

# FCC Radio Test Report

## FCC ID: 2AIMRMDZ16AB

This report concerns (check one):  Original Grant  Class I Change  Class II Change

**Project No.** : 1605C248  
**Equipment** : MI BOX  
**Model Name** : MDZ-16-AB  
**Applicant** : Beijing Xiaomi Electronics Co.,Ltd  
**Address** : Room 707,7F,Building 5,No 58,JinghaiWulu  
Road ,Beijing economic and Technological  
Development Zone

**Date of Receipt** : May 27, 2016  
**Date of Test** : May 27, 2016 ~ Jul. 04, 2016  
**Issued Date** : Jul. 05, 2016  
**Tested by** : BTL Inc.

**Testing Engineer** : Shawn Xiao  
(Shawn Xiao)

**Technical Manager** : David Mao  
(David Mao)

**Authorized Signatory** : Steven Lu  
(Steven Lu)

# **B T L I N C .**

No.3, Jinshagang 1st Road, Shixia, Dalang Town, Dongguan,  
Guangdong, China.

TEL: +86-769-8318-3000 FAX: +86-769-8319-6000

### **Declaration**

**BTL** represents to the client that testing is done in accordance with standard procedures as applicable and that test instruments used has been calibrated with standards traceable to international standard(s) and/or national standard(s).

**BTL's** reports apply only to the specific samples tested under conditions. It is manufacture's responsibility to ensure that additional production units of this model are manufactured with the identical electrical and mechanical components. **BTL** shall have no liability for any declarations, inferences or generalizations drawn by the client or others from **BTL** issued reports.

**BTL's** report must not be used by the client to claim product certification, approval, or endorsement by NVLAP, NIST, or any agency of the Federal Government.

This report is the confidential property of the client. As a mutual protection to the clients, the public and **BTL-self**, extracts from the test report shall not be reproduced except in full with **BTL's** authorized written approval.

**BTL's** laboratory quality assurance procedures are in compliance with the **ISO Guide 17025** requirements, and accredited by the conformity assessment authorities listed in this test report.

### **Limitation**

For the use of the authority's logo is limited unless the Test Standard(s)/Scope(s)/Item(s) mentioned in this test report is (are) included in the conformity assessment authorities acceptance respective.

<b>Table of Contents</b>	<b>Page</b>
<b>1 . CERTIFICATION</b>	<b>6</b>
<b>2 . SUMMARY OF TEST RESULTS</b>	<b>7</b>
2.1 TEST FACILITY	8
2.2 MEASUREMENT UNCERTAINTY	8
<b>3 . GENERAL INFORMATION</b>	<b>9</b>
3.1 GENERAL DESCRIPTION OF EUT	9
3.2 DESCRIPTION OF TEST MODES	11
3.3 TABLE OF PARAMETERS OF TEXT SOFTWARE SETTING	11
3.4 BLOCK DIAGRAM SHOWING THE CONFIGURATION OF SYSTEM TESTED	12
3.5 DESCRIPTION OF SUPPORT UNITS	12
<b>4 . EMC EMISSION TEST</b>	<b>13</b>
4.1 CONDUCTED EMISSION MEASUREMENT	13
4.1.1 POWER LINE CONDUCTED EMISSION LIMITS	13
4.1.2 TEST PROCEDURE	13
4.1.3 DEVIATION FROM TEST STANDARD	13
4.1.4 TEST SETUP	14
4.1.5 EUT OPERATING CONDITIONS	14
4.1.6 EUT TEST CONDITIONS	14
4.1.7 TEST RESULTS	14
4.2 RADIATED EMISSION MEASUREMENT	15
4.2.1 RADIATED EMISSION LIMITS	15
4.2.2 TEST PROCEDURE	16
4.2.3 DEVIATION FROM TEST STANDARD	16
4.2.4 TEST SETUP	17
4.2.5 EUT OPERATING CONDITIONS	18
4.2.6 EUT TEST CONDITIONS	18
4.2.7 TEST RESULTS (9KHZ TO 30MHZ)	18
4.2.8 TEST RESULTS (30MHZ TO 1000 MHZ)	19
4.2.9 TEST RESULTS (ABOVE 1000 MHZ)	19
<b>5 . BANDWIDTH TEST</b>	<b>20</b>
5.1 APPLIED PROCEDURES / LIMIT	20
5.1.1 TEST PROCEDURE	20
5.1.2 DEVIATION FROM STANDARD	20
5.1.3 TEST SETUP	20
5.1.4 EUT OPERATION CONDITIONS	20
5.1.5 EUT TEST CONDITIONS	20
5.1.6 TEST RESULTS	20

<b>Table of Contents</b>	<b>Page</b>
<b>6 . MAXIMUM OUTPUT POWER TEST</b>	<b>21</b>
<b>6.1 APPLIED PROCEDURES / LIMIT</b>	<b>21</b>
6.1.1 TEST PROCEDURE	21
6.1.2 DEVIATION FROM STANDARD	21
6.1.3 TEST SETUP	21
6.1.4 EUT OPERATION CONDITIONS	21
6.1.5 EUT TEST CONDITIONS	21
6.1.6 TEST RESULTS	21
<b>7 . ANTENNA CONDUCTED SPURIOUS EMISSION</b>	<b>22</b>
<b>7.1 APPLIED PROCEDURES / LIMIT</b>	<b>22</b>
7.1.1 TEST PROCEDURE	22
7.1.2 DEVIATION FROM STANDARD	22
7.1.3 TEST SETUP	22
7.1.4 EUT OPERATION CONDITIONS	22
7.1.5 EUT TEST CONDITIONS	22
7.1.6 TEST RESULTS	22
<b>8 . POWER SPECTRAL DENSITY TEST</b>	<b>23</b>
<b>8.1 APPLIED PROCEDURES / LIMIT</b>	<b>23</b>
8.1.1 TEST PROCEDURE	23
8.1.2 DEVIATION FROM STANDARD	23
8.1.3 TEST SETUP	23
8.1.4 EUT OPERATION CONDITIONS	23
8.1.5 EUT TEST CONDITIONS	23
8.1.6 TEST RESULTS	23
<b>9 . MEASUREMENT INSTRUMENTS LIST</b>	<b>24</b>
<b>10 . EUT TEST PHOTO</b>	<b>26</b>
<b>ATTACHMENT A - CONDUCTED EMISSION</b>	<b>30</b>
<b>ATTACHMENT A - RADIATED EMISSION (9KHZ TO 30MHZ)</b>	<b>35</b>
<b>ATTACHMENT B - RADIATED EMISSION (30MHZ TO 1000MHZ)</b>	<b>38</b>
<b>ATTACHMENT C - RADIATED EMISSION (ABOVE 1000MHZ)</b>	<b>51</b>
<b>ATTACHMENT D - BANDWIDTH</b>	<b>64</b>
<b>ATTACHMENT E - MAXIMUM OUTPUT POWER TEST</b>	<b>67</b>
<b>ATTACHMENT F - ANTENNA CONDUCTED SPURIOUS EMISSION</b>	<b>68</b>
<b>ATTACHMENT G - POWER SPECTRAL DENSITY TEST</b>	<b>76</b>

### REPORT ISSUED HISTORY

Issued No.	Description	Issued Date
BTL-FCCP-2-1605C248	Original Issue.	Jul. 05, 2016

## 1. CERTIFICATION

Equipment : MI BOX  
Brand Name : MI  
Model Name : MDZ-16-AB  
Applicant : Beijing Xiaomi Electronics Co.,Ltd  
Manufacturer : Beijing Xiaomi Electronics Co.,Ltd  
Address : Room 707,7F,Building 5,No 58,JinghaiWulu Road ,Beijing economic and  
Technological Development Zone  
Factory : TCL Technoly Electronics (Huizhou) Co.,Ltd.  
Address : 37, Zhongkai Hi-tech Development Zone, Huizhou Guangdong 516006,  
P.R.China  
Date of Test : May 27, 2016 ~ Jul. 04, 2016  
Test Sample : Engineering Sample  
Standard(s) : FCC Part15, Subpart C (15.247) / ANSI C63.10-2013

The above equipment has been tested and found compliance with the requirement of the relative standards by BTL Inc.

The test data, data evaluation, and equipment configuration contained in our test report (Ref No. BTL-FCCP-2-1605C248) were obtained utilizing the test procedures, test instruments, test sites that has been accredited by the Authority of TAF according to the ISO-17025 quality assessment standard and technical standard(s).

## 2. SUMMARY OF TEST RESULTS

Test procedures according to the technical standard(s):

Applied Standard(s): FCC Part15 (15.247) , Subpart C			
Standard(s)	Section	Test Item	Judgment
	15.207	Conducted Emission	PASS
	15.247(d)	Antenna conducted Spurious Emission	PASS
	15.247(a)(2)	6dB Bandwidth	PASS
	15.247(b)(3)	Peak Output Power	PASS
	15.247(e)	Power Spectral Density	PASS
	15.203	Antenna Requirement	PASS
	15.209/15.205	Transmitter Radiated Emissions	PASS

**NOTE:**

(1) "N/A" denotes test is not applicable to this device.

## 2.1 TEST FACILITY

The test facilities used to collect the test data in this report is at the location of No.3, Jinshagang 1st Road, Shixia, Dalang Town, Dongguan, Guangdong, China.  
 BTL's test firm number for FCC: 319330

## 2.2 MEASUREMENT UNCERTAINTY

Where relevant, the following measurement uncertainty levels have been estimated for tests performed on the EUT as specified in CISPR 16-4-2. The BTL measurement uncertainty is less than the CISPR 16-4-2  $U_{cispr}$  requirement.

The reported uncertainty of measurement  $y \pm U$ , where expanded uncertainty  $U$  is based on a standard uncertainty multiplied by a coverage factor of  $k=2$ , providing a level of confidence of approximately **95 %**.

### A. Conducted Measurement :

Test Site	Method	Measurement Frequency Range	U, (dB)
DG-C02	CISPR	150 KHz ~ 30MHz	2.32

### B. Radiated Measurement :

Test Site	Method	Measurement Frequency Range	Ant. H / V	U, (dB)
DG-CB03	CISPR	9KHz~30MHz	V	3.79
		9KHz~30MHz	H	3.57
		30MHz ~ 200MHz	V	3.82
		30MHz ~ 200MHz	H	3.78
		200MHz ~ 1,000MHz	V	4.10
		200MHz ~ 1,000MHz	H	4.06
		1GHz~18GHz	V	3.12
		1GHz~18GHz	H	3.68
		18GHz~40GHz	V	4.15
		18GHz~40GHz	H	4.14

Note: Unless specifically mentioned, the uncertainty of measurement has not been taken into account to declare the compliance or non-compliance to the specification.



### 3. GENERAL INFORMATION

#### 3.1 GENERAL DESCRIPTION OF EUT

Equipment	MI BOX	
Brand Name	MI	
Model Name	MDZ-16-AB	
Model Difference	N/A	
Product Description	Operation Frequency	2402~2480 MHz
	Modulation Technology	GFSK (1Mbps)
	Bit Rate of Transmitter	
	Output Power (Max.)	6.48dBm
Power Source	DC Voltage supplied from AC/DC adapter. #1 Brand /Model: MI / AY11BA-AF0522102 #2 Brand /Model: MI / GSCU2100S05V215S	
Power Rating	#1 I/P: 100-240V~0.5A 50/60Hz O/P:5.2V ---2.1A #2 I/P: 100-240V~0.3A 50/60Hz O/P:5.2V ---2.1A	

**Note:**

1. For a more detailed features description, please refer to the manufacturer's specifications or the user's manual.

2. Channel List:

Channel List			
Channel	Frequency (MHz)	Channel	Frequency (MHz)
00	2402	20	2442
01	2404	21	2444
02	2406	22	2446
03	2408	23	2448
04	2410	24	2450
05	2412	25	2452
06	2414	26	2454
07	2416	27	2456
08	2418	28	2458
09	2420	29	2460
10	2422	30	2462
11	2424	31	2464
12	2426	32	2466
13	2428	33	2468
14	2430	34	2470
15	2432	35	2472
16	2434	36	2474
17	2436	37	2476
18	2438	38	2478
19	2440	39	2480

3. Table for Filed Antenna:

Original Antenna:

Ant.	Brand	Model Name	Antenna Type	Connector	Gain (dBi)
1	MI	ANT_M12	PCB	N/A	3.3

### 3.2 DESCRIPTION OF TEST MODES

To investigate the maximum EMI emission characteristics generates from EUT, the test system was pre-scanning tested base on the consideration of following EUT operation mode or test configuration mode which possible have effect on EMI emission level. Each of these EUT operation mode(s) or test configuration mode(s) mentioned above was evaluated respectively.

Pretest Mode	Description
Mode 1	TX Mode <b>NOTE (1)</b>

The EUT system operated these modes were found to be the worst case during the pre-scanning test as following:

For Radiated Test	
Final Test Mode	Description
Mode 1	TX Mode <b>NOTE (1)</b>

Note:

- (1) The measurements are performed at the high, middle, low available channels.
- (2) The EUT is considered a portable unit, it was pre-tested on the positioned of each 3 axis. The worst case was found positioned on X-plane. Therefore only the test data of this X-plane was used for radiated emission measurement test

### 3.3 TABLE OF PARAMETERS OF TEXT SOFTWARE SETTING

During testing channel & power controlling software provided by the customer was used to control the operating channel as well as the output power level. The RF output power selection is for the setting of RF output power expected by the customer and is going to be fixed on the firmware of the final end product power parameters of WLAN

Test Software Version	N/A		
Frequency (MHz)	2402	2440	2480
BT LE	N/A	N/A	N/A

### 3.4 BLOCK DIAGRAM SHOWING THE CONFIGURATION OF SYSTEM TESTED

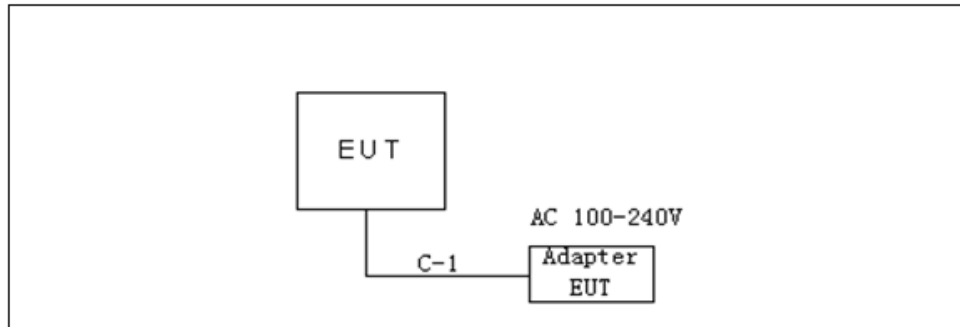

### 3.5 DESCRIPTION OF SUPPORT UNITS

The EUT has been tested as an independent unit together with other necessary accessories or support units. The following support units or accessories were used to form a representative test configuration during the tests.

Item	Equipment	Mfr/Brand	Model/Type No.	FCC ID	Series No.
-	-	-	-	-	-

Item	Shielded Type	Ferrite Core	Length	Note
C-1	NO	NO	1m	DC Cable

Note:

- (1) For detachable type I/O cable should be specified the length in m in 『Length』 column.

## 4. EMC EMISSION TEST

### 4.1 CONDUCTED EMISSION MEASUREMENT

#### 4.1.1 POWER LINE CONDUCTED EMISSION LIMITS (Frequency Range 150KHz-30MHz)

Frequency of Emission (MHz)	Conducted Limit (dBμV)	
	Quasi-peak	Average
0.15 -0.5	66 to 56*	56 to 46*
0.50 -5.0	56	46
5.0 30.0	60	50

Note:

- (1) The limit of " \* " decreases with the logarithm of the frequency
- (2) The test result calculated as following:  
 Measurement Value = Reading Level + Correct Factor  
 Correct Factor = Insertion Loss + Cable Loss + Attenuator Factor(if use)  
 Margin Level = Measurement Value - Limit Value

The following table is the setting of the receiver

Receiver Parameters	Setting
Attenuation	10 dB
Start Frequency	0.15 MHz
Stop Frequency	30 MHz
IF Bandwidth	9 kHz

#### 4.1.2 TEST PROCEDURE

- a. The EUT was placed 0.8 meters from the horizontal ground plane with EUT being connected to the power mains through a line impedance stabilization network (LISN). All other support equipments powered from additional LISN(s). The LISN provide 50 Ohm/ 50uH of coupling impedance for the measuring instrument.
- b. Interconnecting cables that hang closer than 40 cm to the ground plane shall be folded back and forth in the center forming a bundle 30 to 40 cm long.
- c. I/O cables that are not connected to a peripheral shall be bundled in the center. The end of the cable may be terminated, if required, using the correct terminating impedance. The overall length shall not exceed 1 m.
- d. LISN at least 80 cm from nearest part of EUT chassis.
- e. For the actual test configuration, please refer to the related Item –EUT Test Photos.

#### 4.1.3 DEVIATION FROM TEST STANDARD

No deviation

#### 4.1.4 TEST SETUP

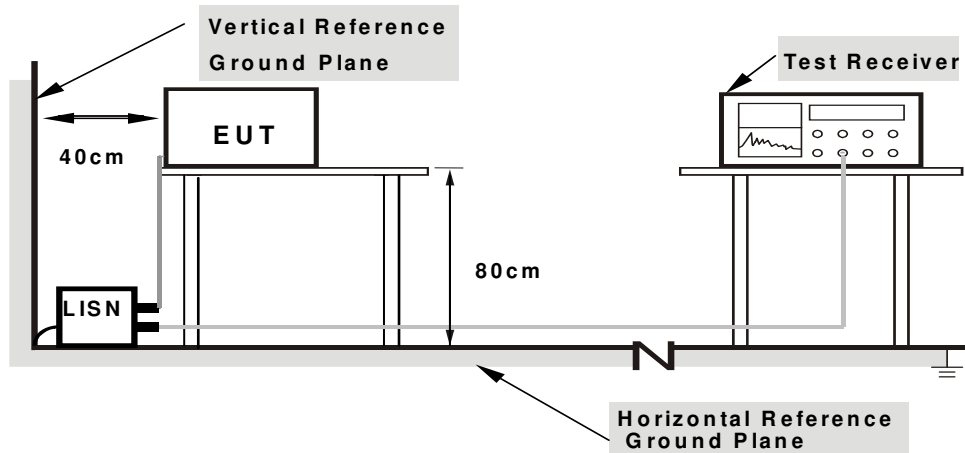

- Note:**
1. Support units were connected to second LISN.
  2. Both of LISNs (AMN) are 80 cm from EUT and at least 80 from other units and other metal planes

#### 4.1.5 EUT OPERATING CONDITIONS

The EUT was configured for testing in a typical fashion (as a customer would normally use it). The EUT has been programmed to continuously transmit during test. This operating condition was tested and used to collect the included data.

#### 4.1.6 EUT TEST CONDITIONS

Temperature: 22°C  
 Relative Humidity: 56%  
 Test Voltage: AC 120V/60Hz

#### 4.1.7 TEST RESULTS

Please refer to the Attachment A.

Remark:

- (1) All readings are QP Mode value unless otherwise stated AVG in column of『Note』. If the QP Mode Measured value compliance with the QP Limits and lower than AVG Limits, the EUT shall be deemed to meet both QP & AVG Limits and then only QP Mode was measured, but AVG Mode didn't perform. In this case, a “ \* ” marked in AVG Mode column of Interference Voltage Measured.
- (2) Measuring frequency range from 150KHz to 30MHz.

## 4.2 RADIATED EMISSION MEASUREMENT

### 4.2.1 RADIATED EMISSION LIMITS

In case the emission fall within the restricted band specified on 15.205(a), then the 15.209(a) limit in the table below has to be followed.

#### LIMITS OF RADIATED EMISSION MEASUREMENT (9KHz-1000MHz)

Frequency (MHz)	Field Strength (microvolts/meter)	Measurement Distance (meters)
0.009~0.490	2400/F(KHz)	300
0.490~1.705	24000/F(KHz)	30
1.705~30.0	30	30
30~88	100	3
88~216	150	3
216~960	200	3
960~1000	500	3

#### LIMITS OF RADIATED EMISSION MEASUREMENT (Above 1000MHz)

Frequency (MHz)	(dBuV/m) (at 3 meters)	
	PEAK	AVERAGE
Above 1000	74	54

#### Notes:

- (1) The limit for radiated test was performed according to FCC PART 15C.
- (2) The tighter limit applies at the band edges.
- (3) Emission level (dBuV/m)=20log Emission level (uV/m).
- (4) The test result calculated as following:  
 Measurement Value = Reading Level + Correct Factor  
 Correct Factor = Antenna Factor + Cable Loss - Amplifier Gain(if use)  
 Margin Level = Measurement Value - Limit Value

Spectrum Parameter	Setting
Attenuation	Auto
Start Frequency	1000 MHz
Stop Frequency	10th carrier harmonic
RBW / VBW (Emission in restricted band)	RBW 1MHz VBW 3MHz peak detector for Pk value RMS detector for AV value

Receiver Parameter	Setting
Attenuation	Auto
Start ~ Stop Frequency	9KHz~90KHz for PK/AVG detector
Start ~ Stop Frequency	90KHz~110KHz for QP detector
Start ~ Stop Frequency	110KHz~490KHz for PK/AVG detector
Start ~ Stop Frequency	490KHz~30MHz for QP detector
Start ~ Stop Frequency	30MHz~1000MHz for QP detector

#### 4.2.2 TEST PROCEDURE

- a. The measuring distance of at 3 m shall be used for measurements. The EUT was placed on the top of a rotating table 0.8 meter above the ground at a 3 meter semi-anechoic chamber. The table was rotated 360 degrees to determine the position of the highest radiation.(below 1GHz)
- b. The measuring distance of at 3 m shall be used for measurements. The EUT was placed on the top of a rotating table 1.5 meter above the ground at a 3 meter semi-anechoic chamber. The table was rotated 360 degrees to determine the position of the highest radiation.(above 1GHz)
- c. The height of the equipment or of the substitution antenna shall be 0.8 m or 1.5 m; the height of the test antenna shall vary between 1 m to 4 m. Both horizontal and vertical polarizations of the antenna are set to make the measurement.
- d. For each suspected emission, the EUT was arranged to its worst case and then the antenna was tuned to heights find the maximum reading (used Bore sight function).
- e. The receiver system was set to peak and average detect function and specified bandwidth with maximum hold mode when the test frequency is above 1GHz.
- f. The initial step in collecting radiated emission data is a receiver peak detector mode pre-scanning the measurement frequency range. Significant peaks are then marked and then Quasi Peak detector mode re-measured.
- g. All readings are Peak unless otherwise stated QP in column of Note. Peak denotes that the Peak reading compliance with the QP Limits and then QP Mode measurement didn't perform. (below 1GHz)
- h. All readings are Peak Mode value unless otherwise stated AVG in column of Note. If the Peak Mode Measured value compliance with the Peak Limits and lower than AVG Limits, the EUT shall be deemed to meet both Peak & AVG Limits and then only Peak Mode was measured, but AVG Mode didn't perform. (above 1GHz)
- i. For the actual test configuration, please refer to the related Item –EUT Test Photos.

#### 4.2.3 DEVIATION FROM TEST STANDARD

No deviation



**4.2.4 TEST SETUP**

(A) Radiated Emission Test Set-Up Frequency Below 1 GHz

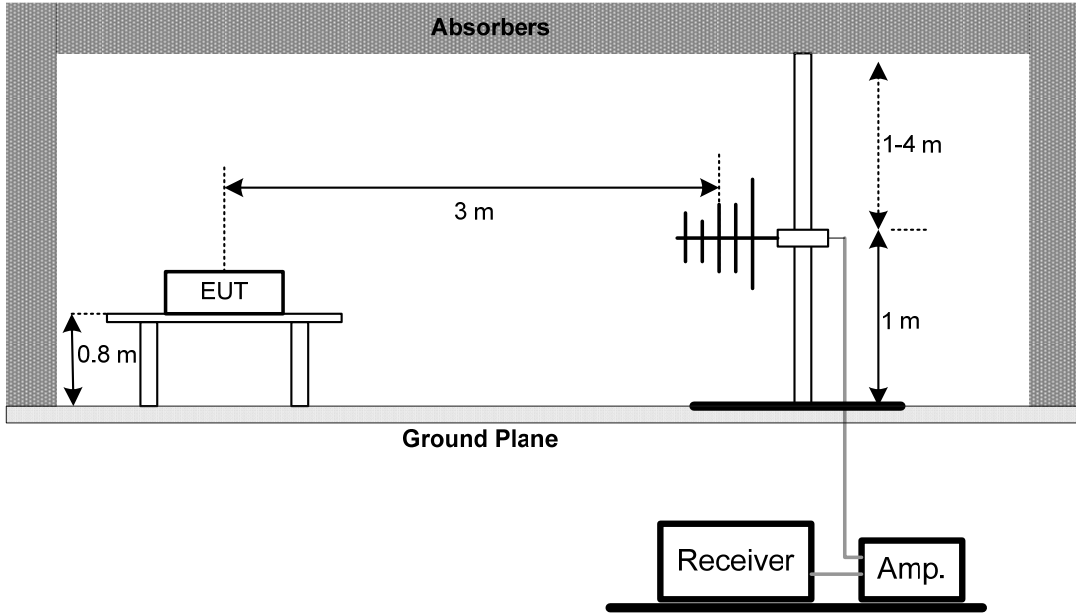

(B) Radiated Emission Test Set-Up Frequency Above 1 GHz

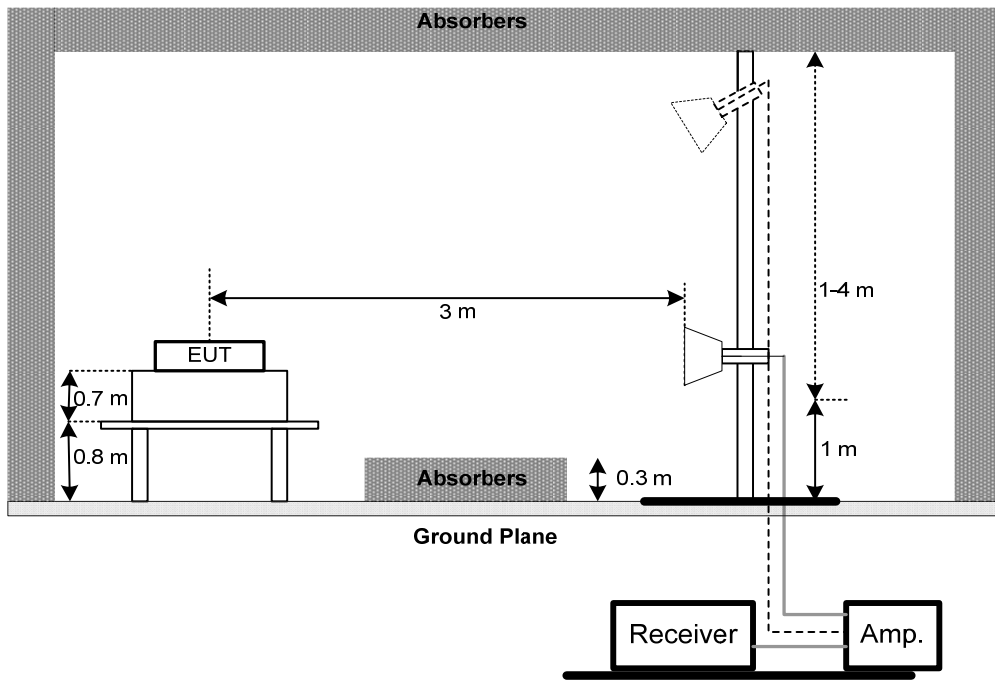

(C) For radiated emissions below 30MHz

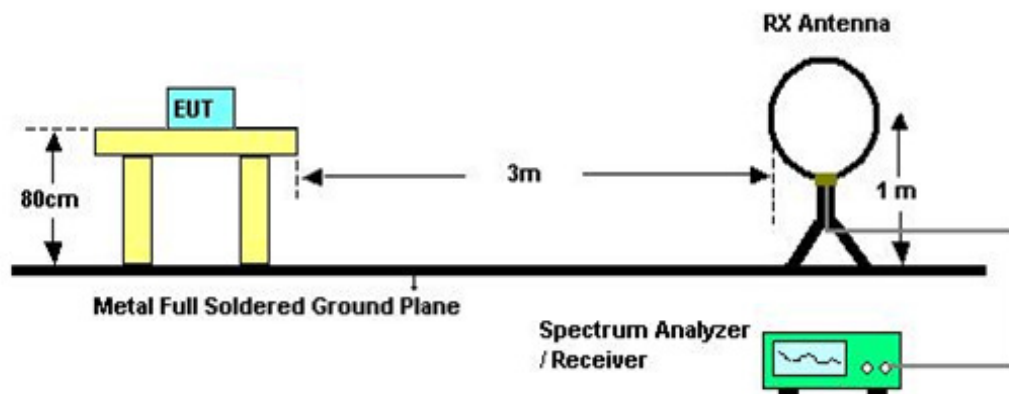

#### 4.2.5 EUT OPERATING CONDITIONS

The EUT tested system was configured as the statements of 4.1.5 unless otherwise a special operating condition is specified in the follows during the testing.

#### 4.2.6 EUT TEST CONDITIONS

Temperature: 22°C

Relative Humidity: 56%

Test Voltage: AC 120V/60Hz

#### 4.2.7 TEST RESULTS (9KHZ TO 30MHZ)

Please refer to the Attachment B

Remark:

- (1) The amplitude of spurious emissions which are attenuated by more than 20 dB below the permissible value has no need to be reported.
- (2) Distance extrapolation factor =  $40 \log (\text{specific distance} / \text{test distance})$  (dB).
- (3) Limit line = specific limits (dBuV) + distance extrapolation factor.

#### **4.2.8 TEST RESULTS (30MHZ TO 1000 MHZ)**

Please refer to the Attachment C.

Remark:

- (1) All readings are Peak unless otherwise stated QP in column of 『Note』 . Peak denotes that the Peak reading compliance with the QP Limits and then QP Mode measurement didn't perform.
- (2) Measuring frequency range from 30MHz to 1000MHz.
- (3) If the peak scan value lower limit more than 20dB, then this signal data does not show in table.

#### **4.2.9 TEST RESULTS (ABOVE 1000 MHZ)**

Please refer to the Attachment D.

Remark:

- (1) All readings are Peak unless otherwise stated QP in column of 『Note』 . Peak denotes that the Peak reading compliance with the QP Limits and then QP Mode measurement didn't perform.
- (2) Radiated emissions measured in frequency range above 1000MHz were made with an instrument using Peak detector mode and AV detector mode of the emission
- (3) A preamp and high pass filter were used for this test in order to provide sufficient measurement sensitivity.
- (4) EUT Orthogonal Axis:  
"X" - denotes Laid on Table ; "Y" - denotes Vertical Stand ; "Z" - denotes Side Stand
- (5) During the measurements above 1 GHz it is taken care of that the EUT is always within the 3 dB cone of radiation BW of the used antenna
- (6) No limit: This is fundamental signal, the judgment is not applicable.  
For fundamental signal judgment was referred to Peak output test.

## 5. BANDWIDTH TEST

### 5.1 Applied procedures / limit

FCC Part15 (15.247) , Subpart C				
Section	Test Item	Limit	Frequency Range (MHz)	Result
15.247(a)(2)	Bandwidth	$\geq 500\text{KHz}$ (6dB bandwidth)	2400-2483.5	PASS

#### 5.1.1 TEST PROCEDURE

- The EUT was directly connected to the spectrum analyzer and antenna output port as show in the block diagram below,
- Spectrum Setting : RBW= 100KHz, VBW=300KHz, Sweep time = 2.5 ms.

#### 5.1.2 DEVIATION FROM STANDARD

No deviation.

#### 5.1.3 TEST SETUP

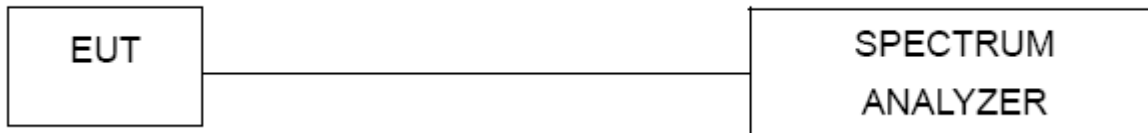

#### 5.1.4 EUT OPERATION CONDITIONS

The EUT tested system was configured as the statements of 4.1.5 unless otherwise a special operating condition is specified in the follows during the testing.

#### 5.1.5 EUT TEST CONDITIONS

Temperature: 25°C  
 Relative Humidity: 55%  
 Test Voltage: AC 120V/60Hz

#### 5.1.6 TEST RESULTS

Please refer to the Attachment E.

## 6. MAXIMUM OUTPUT POWER TEST

### 6.1 Applied procedures / limit

FCC Part15 (15.247) , Subpart C				
Section	Test Item	Limit	Frequency Range (MHz)	Result
15.247(b)(3)	Maximum Output Power	1 watt or 30dBm	2400-2483.5	PASS

#### 6.1.1 TEST PROCEDURE

- a. The EUT was directly connected to the power meter and antenna output port as show in the block diagram below,
- b. The maximum peak conducted output power was performed in accordance with method 9.1.2 of FCC KDB 558074 D01 DTS Meas Guidance v03r05.

#### 6.1.2 DEVIATION FROM STANDARD

No deviation.

#### 6.1.3 TEST SETUP



#### 6.1.4 EUT OPERATION CONDITIONS

The EUT tested system was configured as the statements of 4.1.5 unless otherwise a special operating condition is specified in the follows during the testing.

#### 6.1.5 EUT TEST CONDITIONS

Temperature: 25°C  
 Relative Humidity: 55%  
 Test Voltage: AC 120V/60Hz

#### 6.1.6 TEST RESULTS

Please refer to the Attachment F.

## 7. ANTENNA CONDUCTED SPURIOUS EMISSION

### 7.1 Applied procedures / limit

In any 100 kHz bandwidth outside the frequency band in which the spread spectrum or digitally modulated device is operating, the RF power that is produced shall be at least 20 dB below that in the 100 kHz bandwidth within the band that contains the highest level of the desired power, based on either an RF conducted or a radiated measurement, provided that the transmitter demonstrates compliance with the peak conducted power limits.

#### 7.1.1 TEST PROCEDURE

- a. The EUT was directly connected to the spectrum analyzer and antenna output port as show in the block diagram below,
- b. Spectrum Setting : RBW= 100KHz, VBW=300KHz, Sweep time = 10 ms.
- c. Offset=antanna gain + cable loss

#### 7.1.2 DEVIATION FROM STANDARD

No deviation.

#### 7.1.3 TEST SETUP



#### 7.1.4 EUT OPERATION CONDITIONS

The EUT tested system was configured as the statements of 4.1.5 unless otherwise a special operating condition is specified in the follows during the testing.

#### 7.1.5 EUT TEST CONDITIONS

Temperature: 25°C  
 Relative Humidity: 55%  
 Test Voltage: AC 120V/60Hz

#### 7.1.6 TEST RESULTS

Please refer to the Attachment G.

## 8. POWER SPECTRAL DENSITY TEST

### 8.1 Applied procedures / limit

FCC Part15 (15.247) , Subpart C				
Section	Test Item	Limit	Frequency Range (MHz)	Result
15.247(e)	Power Spectral Density	8 dBm (in any 3KHz)	2400-2483.5	PASS

#### 8.1.1 TEST PROCEDURE

- a. The EUT was directly connected to the spectrum analyzer and antenna output port as show in the block diagram below,
- b. Spectrum Setting: RBW=3KHz, VBW=10 KHz, Sweep time = auto.

#### 8.1.2 DEVIATION FROM STANDARD

No deviation.

#### 8.1.3 TEST SETUP

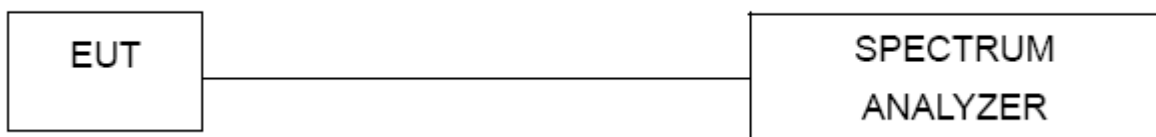

#### 8.1.4 EUT OPERATION CONDITIONS

The EUT tested system was configured as the statements of 4.1.5 unless otherwise a special operating condition is specified in the follows during the testing.

#### 8.1.5 EUT TEST CONDITIONS

Temperature: 25°C  
 Relative Humidity: 55%  
 Test Voltage: AC 120V/60Hz

#### 8.1.6 TEST RESULTS

Please refer to the Attachment H.

## 9. MEASUREMENT INSTRUMENTS LIST

Conducted Emission Measurement					
Item	Kind of Equipment	Manufacturer	Type No.	Serial No.	Calibrated until
1	LISN	EMCO	3816/2	0052765	Mar. 27, 2017
2	LISN	R&S	ENV216	101447	Mar. 27, 2017
3	Test Cable	emci	RG223(9KHz-30 MHz)	C_17	Mar. 10, 2017
4	EMI Test Receiver	R&S	ESCI	100382	Mar. 27, 2017
5	50Ω Terminator	SHX	TF2-3G-A	08122901	Mar. 27, 2017
6	Measurement Software	Farad	EZ-EMC Ver.NB-03A1-01	N/A	N/A

Radiated Emission Measurement					
Item	Kind of Equipment	Manufacturer	Type No.	Serial No.	Calibrated until
1	Antenna	Schwarbeck	VULB9160	9160-3232	Mar. 27, 2017
2	Amplifier	HP	8447D	2944A09673	Nov. 09, 2016
3	Receiver	AGILENT	N9038A	MY52130039	Oct. 11, 2016
4	Test Cable	emci	LMR-400(30MHz-1GHz)	C-01	Jun. 27, 2017
5	Controller	CT	SC100	N/A	N/A
6	Measurement Software	Farad	EZ-EMC Ver.NB-03A1-01	N/A	N/A
7	Antenna	ETS	3115	00075789	Mar. 27, 2017
8	Amplifier	Agilent	8449B	3008A02274	Nov. 01, 2016
9	Receiver	AGILENT	N9038A	MY52130039	Oct. 11, 2016
10	Test Cable	emci	EMC104-SM-S M-10000(1GHz-26.5GHz)	C-68	Jun. 27, 2017
11	Controller	CT	SC100	N/A	N/A
12	Broad-Band Horn Antenna	Schwarzbeck	BBHA 9170	9170319	Mar. 27, 2017
13	Microwave Preamplifier With Adaptor	EMC INSTRUMENT	EMC2654045	980039 & HA01	Mar. 27, 2017
14	Active Loop Antenna	R&S	HFH2-Z2	830749/020	Sep. 07, 2016



6dB Bandwidth Measurement					
Item	Kind of Equipment	Manufacturer	Type No.	Serial No.	Calibrated until
1	EXA Spectrum Analyzer	Agilent	N9010A	MY50520044	Mar. 27, 2017

Peak Output Power Measurement					
Item	Kind of Equipment	Manufacturer	Type No.	Serial No.	Calibrated until
1	Power Meter	ANRITSU	ML2495A	1128009	Mar. 27, 2017
2	Pulse Power Sensor	ANRITSU	MA 2411B	1027500	Mar. 27, 2017

Antenna Conducted Spurious Emission Measurement					
Item	Kind of Equipment	Manufacturer	Type No.	Serial No.	Calibrated until
1	EXA Spectrum Analyzer	Agilent	N9010A	MY50520044	Mar. 27, 2017

Power Spectral Density Measurement					
Item	Kind of Equipment	Manufacturer	Type No.	Serial No.	Calibrated until
1	EXA Spectrum Analyzer	Agilent	N9010A	MY50520044	Mar. 27, 2017

Remark: "N/A" denotes no model name, serial no. or calibration specified.  
 All calibration period of equipment list is one year.

## 10. EUT TEST PHOTO

### Conducted Measurement Photos



## Radiated Measurement Photos

9KHz to 30MHz

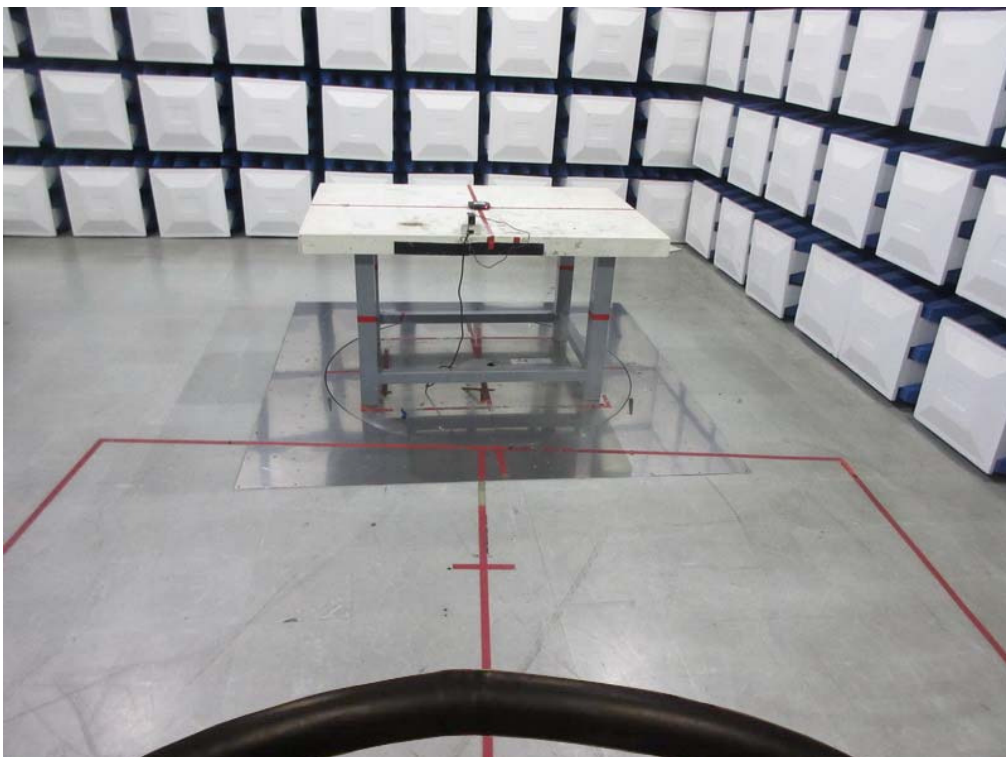

## Radiated Measurement Photos

30MHz to 1000MHz





## Radiated Measurement Photos

Above 1000MHz

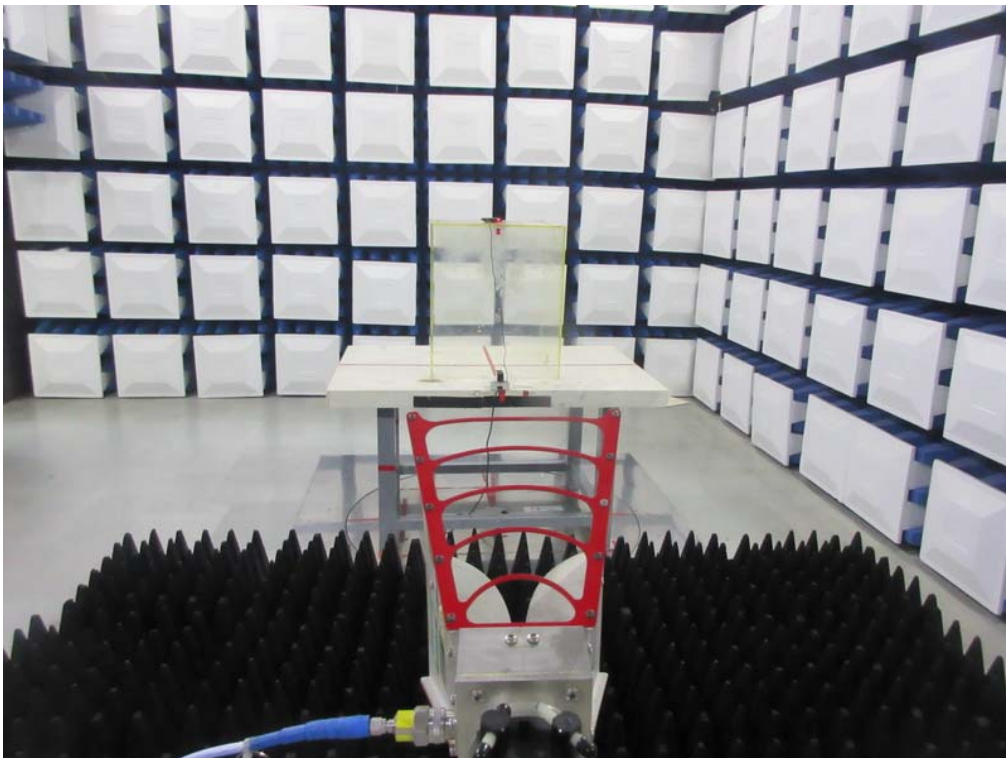
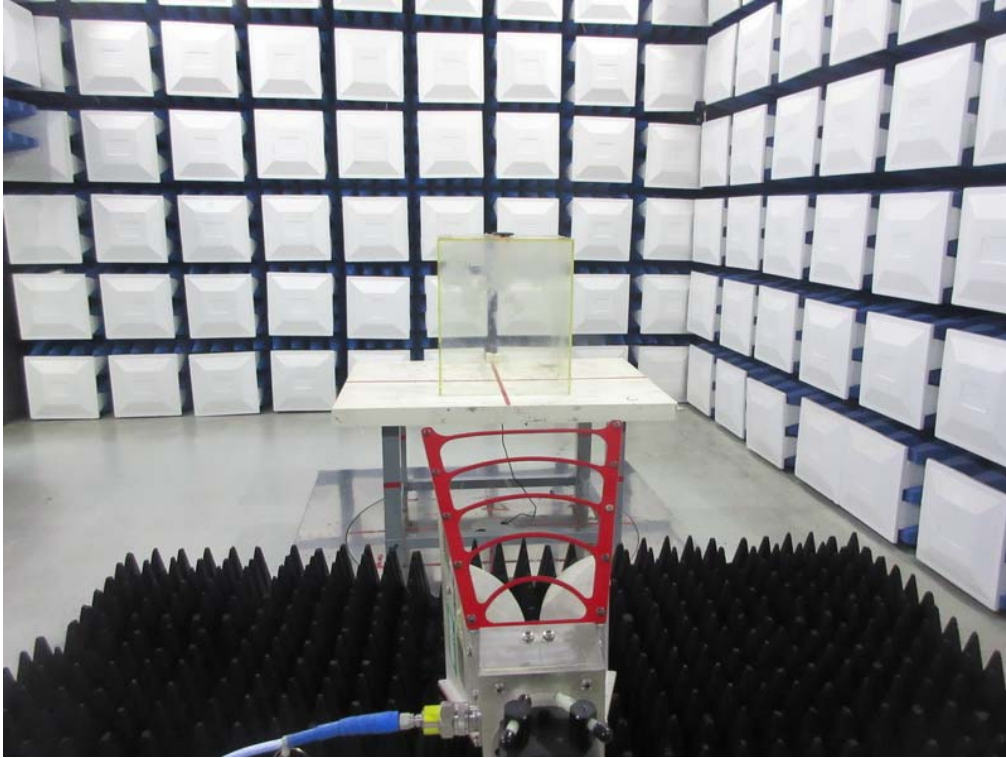

## ATTACHMENT A - CONDUCTED EMISSION

Test Mode: TX Mode- Adapter: MI / GSCU2100S05V215S

**Line**

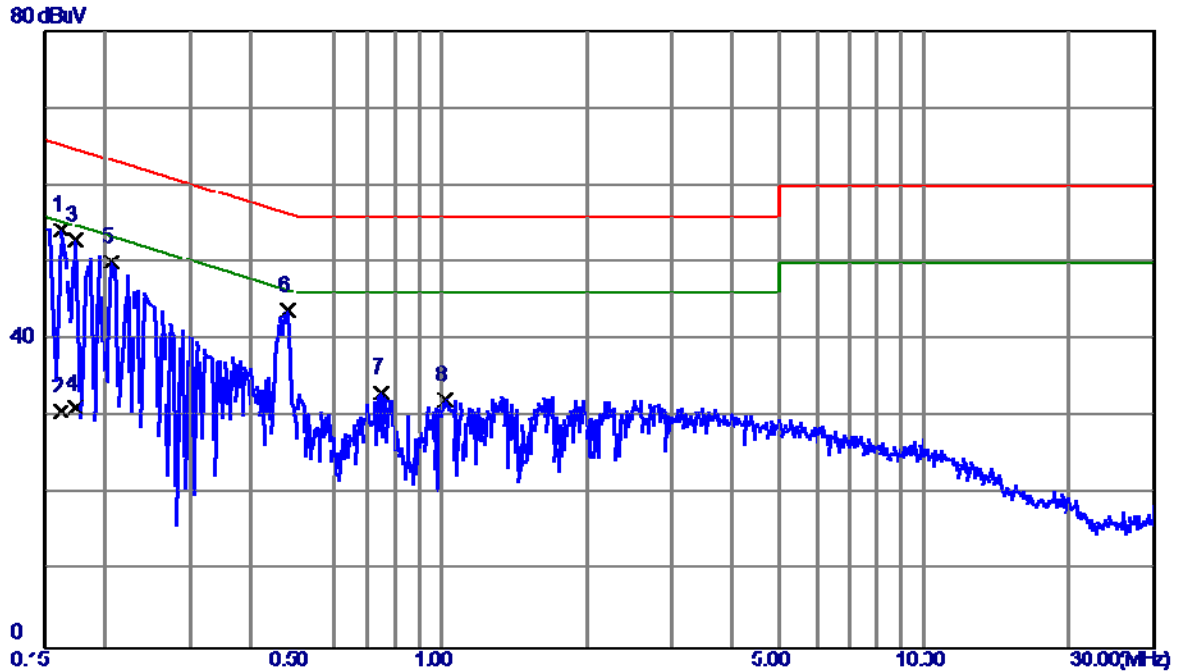

No.	Freq. MHz	Reading Level dBuV	Correct Factor dB	Measure ment dBuV	Limit dBuV	Margin dB	Detector	Comment
1 *	0.1620	44.66	9.52	54.18	65.36	-11.18	Peak	
2	0.1620	21.20	9.52	30.72	55.36	-24.64	AVG	
3	0.1740	43.37	9.52	52.89	64.77	-11.88	Peak	
4	0.1740	21.60	9.52	31.12	54.77	-23.65	AVG	
5	0.2060	40.50	9.53	50.03	63.37	13.34	Peak	
6	0.4780	34.22	9.62	43.84	56.37	-12.53	Peak	
7	0.7500	23.35	9.70	33.05	56.00	-22.95	Peak	
8	1.0140	22.47	9.76	32.23	56.00	-23.77	Peak	

Test Mode: TX Mode- Adapter: MI / GSCU2100S05V215S

**Neutral**

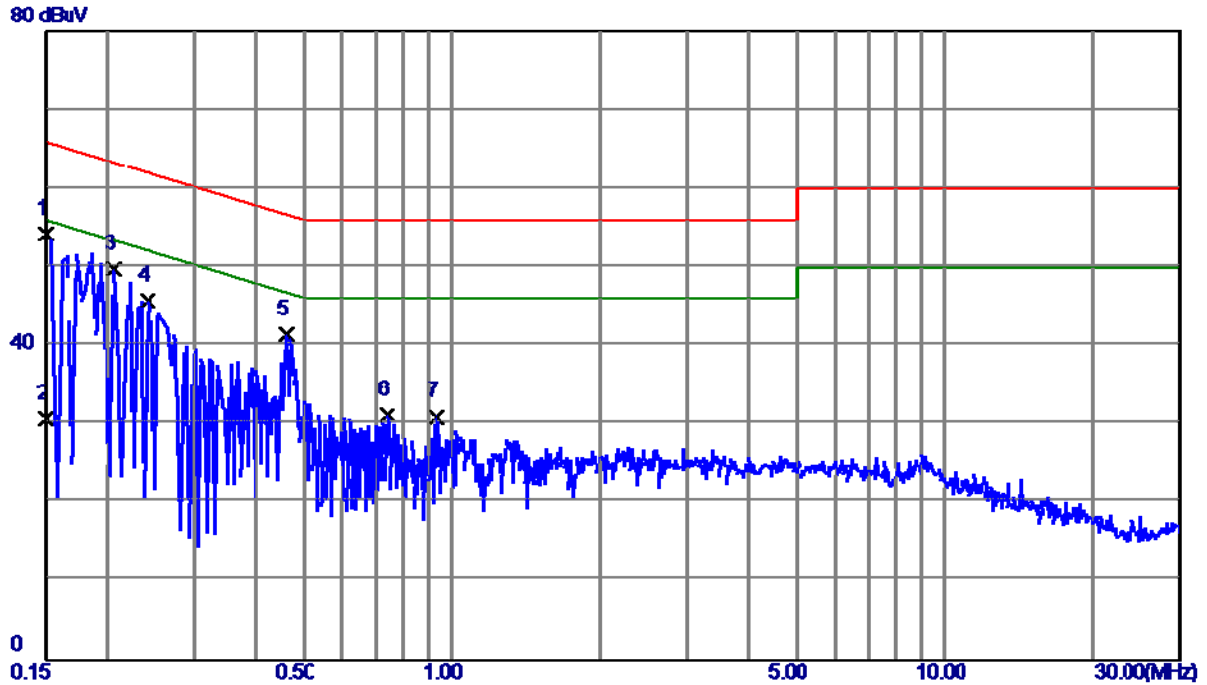

No.	Freq. MHz	Reading Level dBuV	Correct Factor dB	Measure ment dBuV	Limit dBuV	Margin dB	Detector	Comment
1 *	0.1500	44.75	9.52	54.27	66.00	-11.73	Peak	
2	0.1500	21.20	9.52	30.72	56.00	-25.28	AVG	
3	0.2060	40.18	9.53	49.71	63.37	-13.66	Peak	
4	0.2420	36.25	9.53	45.78	62.03	-16.25	Peak	
5	0.4620	32.02	9.44	41.46	56.66	-15.20	Peak	
6	0.7380	21.74	9.49	31.23	56.00	-24.77	Peak	
7	0.9300	21.30	9.66	30.96	56.00	-25.04	Peak	



Test Mode: TX Mode- Adapter: MI / AY11BA-AF0522102

**Line**

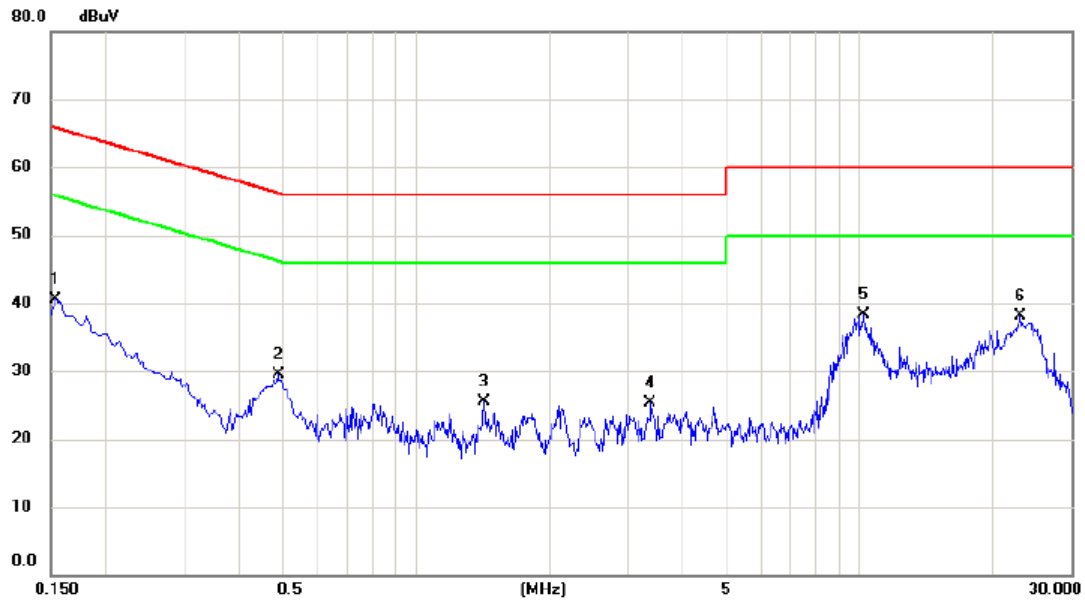

No.	Mk.	Freq. MHz	Reading Level dBuV	Correct Factor dB	Measure- ment dBuV	Limit dBuV	Margin dB	Detector	Comment
1		0.1540	30.84	9.68	40.52	65.78	-25.26	QP	
2		0.4890	19.73	9.69	29.42	56.18	-26.76	QP	
3		1.4254	15.68	9.73	25.41	56.00	-30.59	QP	
4		3.3814	15.40	9.83	25.23	56.00	-30.77	QP	
5	*	10.2332	28.27	9.95	38.22	60.00	-21.78	QP	
6		23.0181	28.06	9.95	38.01	60.00	-21.99	QP	

Test Mode: TX Mode- Adapter: MI / AY11BA-AF0522102

**Neutral**

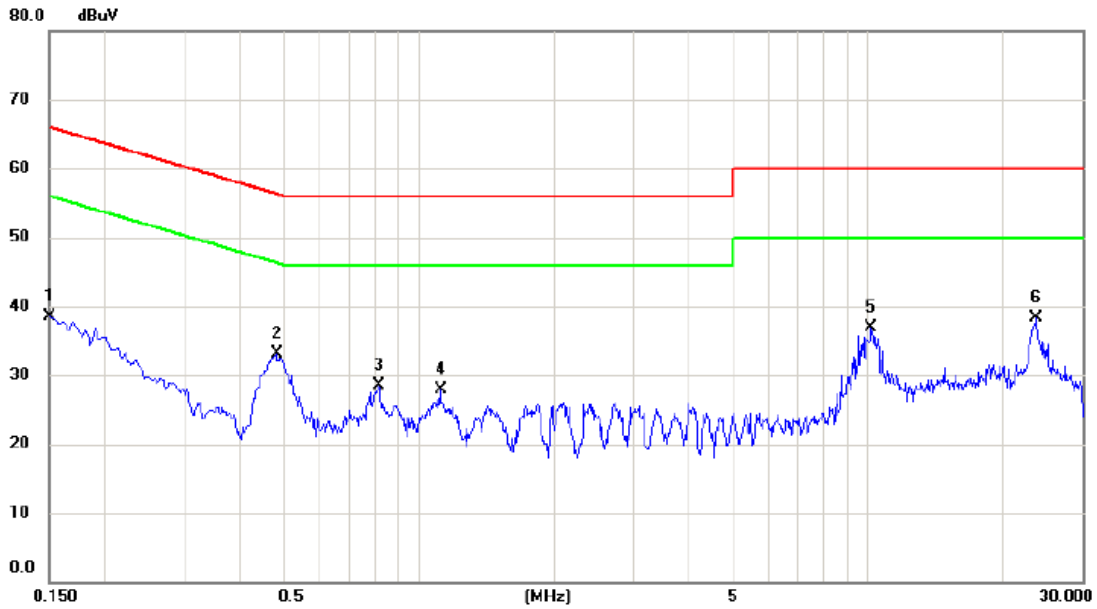

No.	Mk.	Freq. MHz	Reading Level dBuV	Correct Factor dB	Measure- ment dBuV	Limit dBuV	Margin dB	Detector	Comment
1		0.1500	28.74	9.68	38.42	66.00	-27.58	QP	
2		0.4812	23.33	9.69	33.02	56.32	-23.30	QP	
3		0.8131	18.72	9.70	28.42	56.00	-27.58	QP	
4		1.1170	18.12	9.72	27.84	56.00	-28.16	QP	
5		10.1791	26.98	9.96	36.94	60.00	-23.06	QP	
6	*	23.7615	28.30	9.95	38.25	60.00	-21.75	QP	

## ATTACHMENT B - RADIATED EMISSION (9KHZ TO 30MHZ)

Test Mode: TX Mode- Adapter: MI / GSCU2100S05V215S

Frequency (MHz)	Ant 0°/90°	Read level dBuV/m	Factor (dB)	Measured(FS) (dBuV/m)	Limit (dBuV/m)	Margin (dB)	Note
0.0092	0°	13.4	24.9840	38.3840	128.3285	-89.9445	AVG
0.0092	0°	14.28	24.9840	39.2640	148.3285	-109.0645	PEAK
0.028	0°	6.77	23.7933	30.5633	118.6611	-88.0977	AVG
0.028	0°	8.1	23.7933	31.8933	138.6611	-106.7677	PEAK
0.0361	0°	3.29	23.2803	26.5703	116.4541	-89.8837	AVG
0.0361	0°	5.54	23.2803	28.8203	136.4541	-107.6337	PEAK
0.0583	0°	1.29	22.2340	23.5240	112.2909	-88.7669	AVG
0.0583	0°	2.54	22.2340	24.7740	132.2909	-107.5169	PEAK
0.5092	0°	19.33	19.8294	39.1594	73.4665	-34.3070	QP
1.9525	0°	23.77	19.5048	43.2748	69.5400	-26.2652	QP

Frequency (MHz)	Ant 0°/90°	Read level dBuV/m	Factor (dB)	Measured(FS) (dBuV/m)	Limit (dBuV/m)	Margin (dB)	Note
0.0121	90°	13.28	24.3000	37.5800	125.9485	-88.3685	AVG
0.0121	90°	14.8	24.3000	39.1000	145.9485	-106.8485	PEAK
0.0264	90°	7.29	23.8947	31.1847	119.1721	-87.9875	AVG
0.0264	90°	8.95	23.8947	32.8447	139.1721	-106.3275	PEAK
0.0435	90°	5.37	22.8117	28.1817	114.8344	-86.6528	AVG
0.0435	90°	6.36	22.8117	29.1717	134.8344	-105.6628	PEAK
0.0581	90°	1.54	22.2380	23.7780	112.3207	-88.5427	AVG
0.0581	90°	2.85	22.2380	25.0880	132.3207	-107.2327	PEAK
0.6219	90°	22.29	20.1901	42.4801	71.7298	-29.2497	QP
2.0545	90°	24.51	19.4673	43.9773	69.5400	-25.5627	QP

Test Mode:	TX Mode- Adapter: MI / AY11BA-AF0522102
------------	---

Frequency (MHz)	Ant 0°/90°	Read level dBuV/m	Factor (dB)	Measured(FS) (dBuV/m)	Limit (dBuV/m)	Margin (dB)	Note
0.0093	0°	13.25	24.98	38.23	128.23	-90.01	AVG
0.0093	0°	14.63	24.98	39.61	148.23	-108.63	PEAK
0.0281	0°	6.58	23.79	30.37	118.63	-88.26	AVG
0.0281	0°	8.07	23.79	31.86	138.63	-106.77	PEAK
0.0364	0°	3.38	23.26	26.64	116.38	-89.74	AVG
0.0364	0°	5.24	23.26	28.50	136.38	-107.88	PEAK
0.0582	0°	1.39	22.24	23.63	112.31	-88.68	AVG
0.0582	0°	2.56	22.24	24.80	132.31	-107.51	PEAK
0.5090	0°	19.84	19.83	39.67	73.47	-33.80	QP
1.9526	0°	23.41	19.50	42.91	69.54	-26.63	QP

Frequency (MHz)	Ant 0°/90°	Read level dBuV/m	Factor (dB)	Measured(FS) (dBuV/m)	Limit (dBuV/m)	Margin (dB)	Note
0.0122	90°	13.24	24.30	37.54	125.88	-88.34	AVG
0.0122	90°	14.58	24.30	38.88	145.88	-107.00	PEAK
0.0264	90°	7.16	23.89	31.05	119.17	-88.12	AVG
0.0264	90°	8.73	23.89	32.62	139.17	-106.55	PEAK
0.0432	90°	5.49	22.83	28.32	114.89	-86.57	AVG
0.0432	90°	6.52	22.83	29.35	134.89	-105.54	PEAK
0.0581	90°	1.74	22.24	23.98	112.32	-88.34	AVG
0.0581	90°	2.91	22.24	25.15	132.32	-107.17	PEAK
0.6216	90°	22.17	20.19	42.36	71.73	-29.37	QP
2.0543	90°	23.84	19.47	43.31	69.54	-26.23	QP

# ATTACHMENT C - RADIATED EMISSION (30MHZ TO 1000MHZ)

Test Mode: TX 2402MHz -CH00- Adapter: MI / GSCU2100S05V215S

**Vertical**

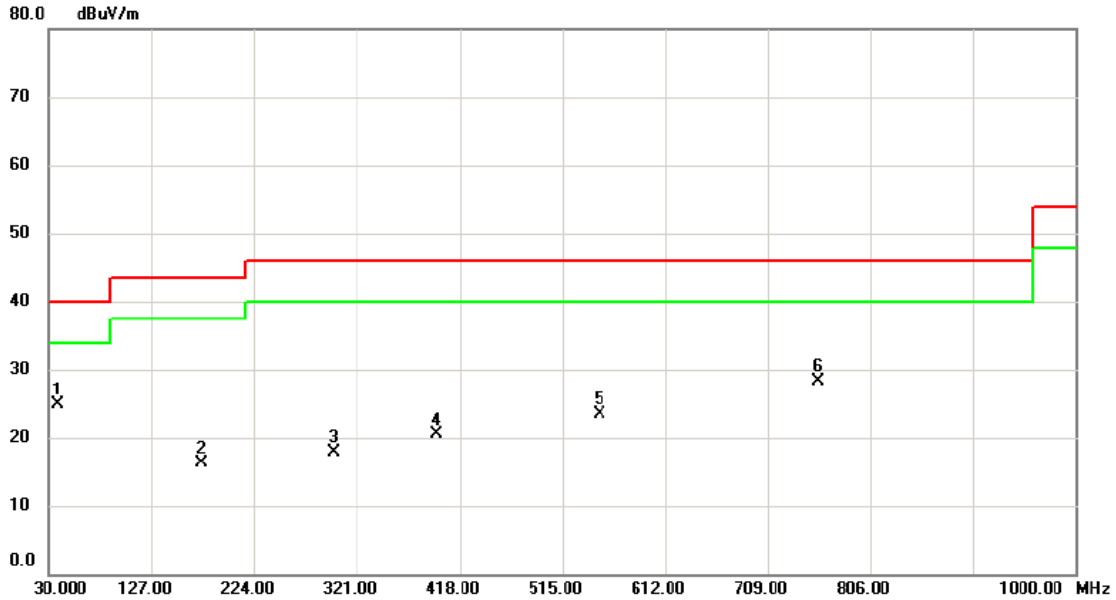

No.	Mk.	Freq. MHz	Reading Level dBuV	Correct Factor dB	Measure- ment dBuV/m	Limit dBuV/m	Margin dB	Detector	Comment
1	*	38.2450	38.90	-14.06	24.84	40.00	-15.16	peak	
2		173.5600	28.87	-12.53	16.34	43.50	-27.16	peak	
3		300.1450	28.30	-10.46	17.84	46.00	-28.16	peak	
4		396.1750	29.09	-8.53	20.56	46.00	-25.44	peak	
5		550.4050	28.82	-5.30	23.52	46.00	-22.48	peak	
6		757.0150	30.86	-2.61	28.25	46.00	-17.75	peak	

Test Mode: TX 2402MHz -CH00- Adapter: MI / GSCU2100S05V215S

### Horizontal

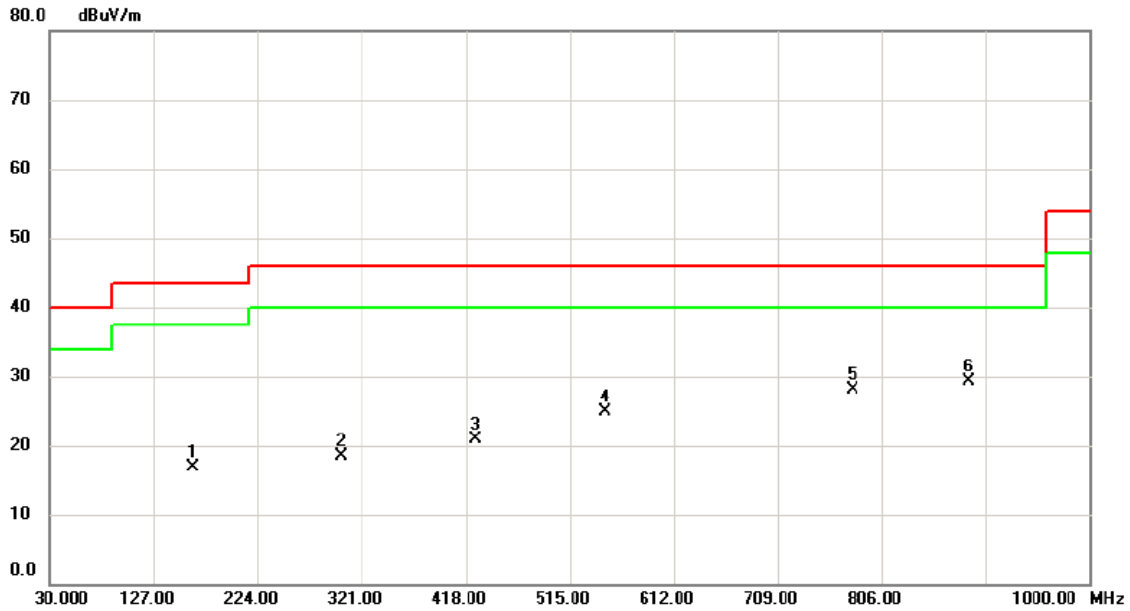

No.	Mk.	Freq. MHz	Reading Level dBuV	Correct Factor dB	Measure- ment dBuV/m	Limit dBuV/m	Margin dB	Detector	Comment
1		164.3450	29.11	-12.24	16.87	43.50	-26.63	peak	
2		301.6000	28.91	-10.49	18.42	46.00	-27.58	peak	
3		427.7000	29.37	-8.43	20.94	46.00	-25.06	peak	
4		547.4950	30.49	-5.53	24.96	46.00	-21.04	peak	
5		779.3250	29.70	-1.65	28.05	46.00	-17.95	peak	
6	*	887.9650	28.62	0.63	29.25	46.00	-16.75	peak	



Test Mode: TX 2440MHz -CH19- Adapter: MI / GSCU2100S05V215S

Vertical

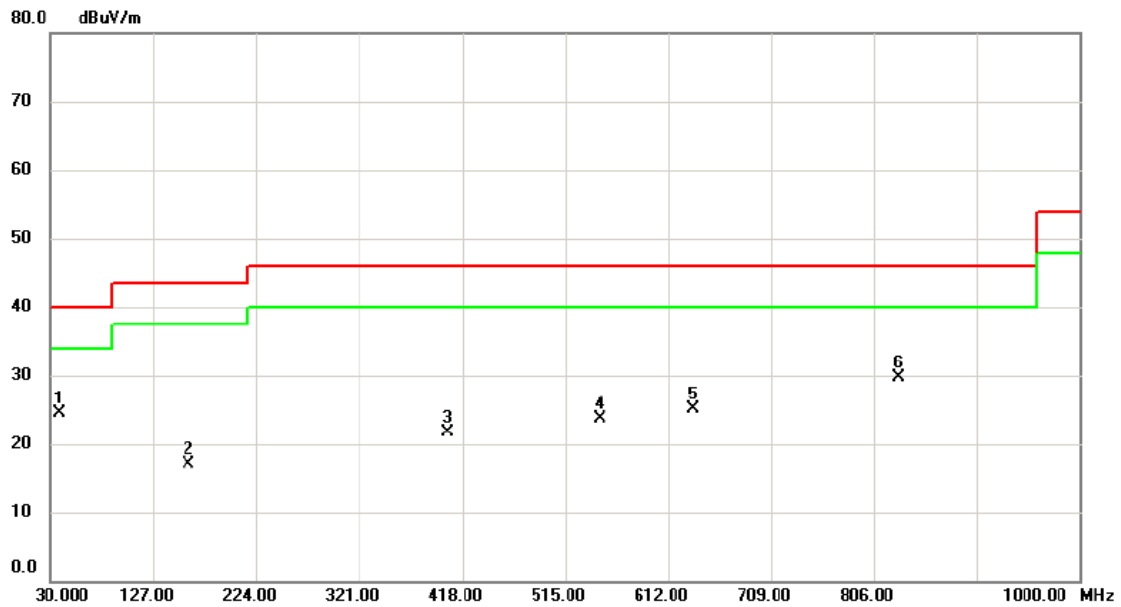

No.	Mk.	Freq. MHz	Reading Level dBuV	Correct Factor dB	Measure- ment dBuV/m	Limit dBuV/m	Margin dB	Detector	Comment
1	*	38.2450	38.50	-14.06	24.44	40.00	-15.56	peak	
2		159.4950	29.28	-12.23	17.05	43.50	-26.45	peak	
3		404.4200	29.96	-8.30	21.66	46.00	-24.34	peak	
4		548.4650	29.20	-5.43	23.77	46.00	-22.23	peak	
5		635.2800	30.96	-5.87	25.09	46.00	-20.91	peak	
6		830.2500	31.37	-1.68	29.69	46.00	-16.31	peak	

Test Mode: TX 2440MHz -CH19- Adapter: MI / GSCU2100S05V215S

### Horizontal

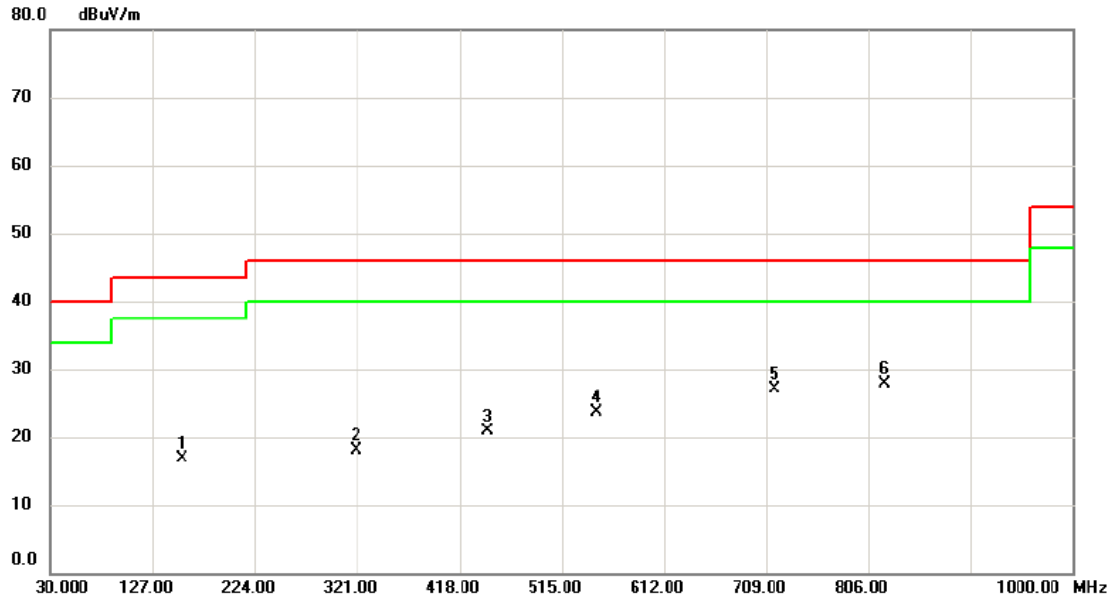

No.	Mk.	Freq. MHz	Reading Level dBuV	Correct Factor dB	Measure- ment dBuV/m	Limit dBuV/m	Margin dB	Detector	Comment
1		154.6450	29.45	-12.61	16.84	43.50	-26.66	peak	
2		320.0300	29.07	-10.92	18.15	46.00	-27.85	peak	
3		444.1900	29.48	-8.54	20.94	46.00	-25.06	peak	
4		548.4650	29.16	-5.43	23.73	46.00	-22.27	peak	
5		716.7600	30.04	-2.99	27.05	46.00	-18.95	peak	
6	*	821.5200	29.27	-1.41	27.86	46.00	-18.14	peak	

Test Mode: TX 2480MHz -CH39- Adapter: MI / GSCU2100S05V215S

Vertical

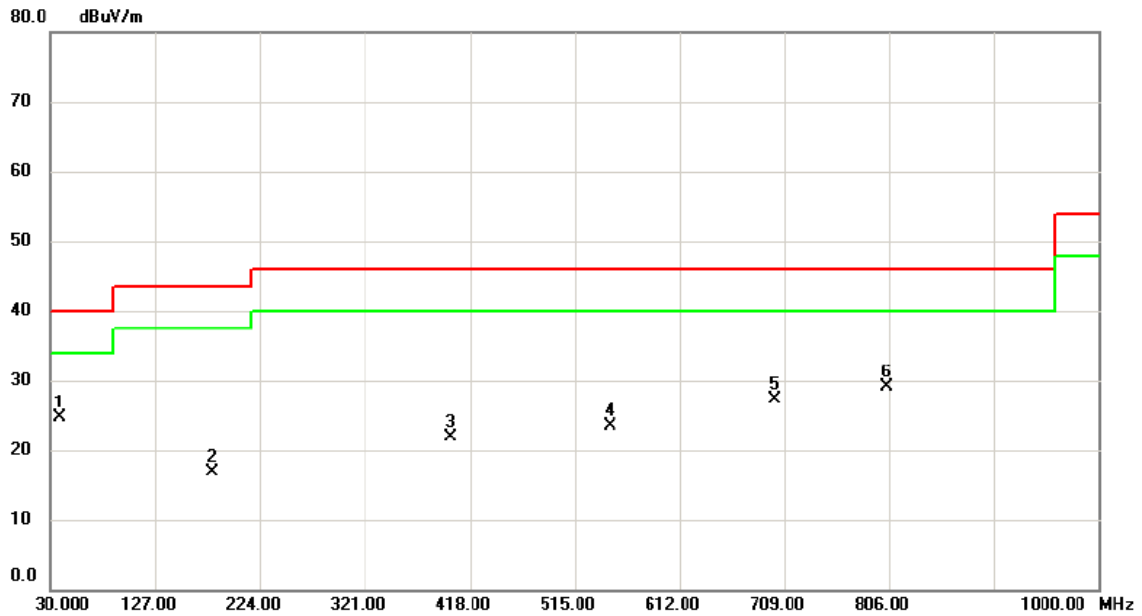

No.	Mk.	Freq. MHz	Reading Level dBuV	Correct Factor dB	Measure- ment dBuV/m	Limit dBuV/m	Margin dB	Detector	Comment
1	*	38.2450	38.84	-14.06	24.78	40.00	-15.22	peak	
2		178.8950	29.84	-12.84	17.00	43.50	-26.50	peak	
3		400.5400	30.19	-8.27	21.92	46.00	-24.08	peak	
4		548.4650	29.02	-5.43	23.59	46.00	-22.41	peak	
5		700.7550	30.37	-3.01	27.36	46.00	-18.64	peak	
6		804.5450	30.02	-0.88	29.14	46.00	-16.86	peak	

Test Mode: TX 2480MHz -CH39- Adapter: MI / GSCU2100S05V215S

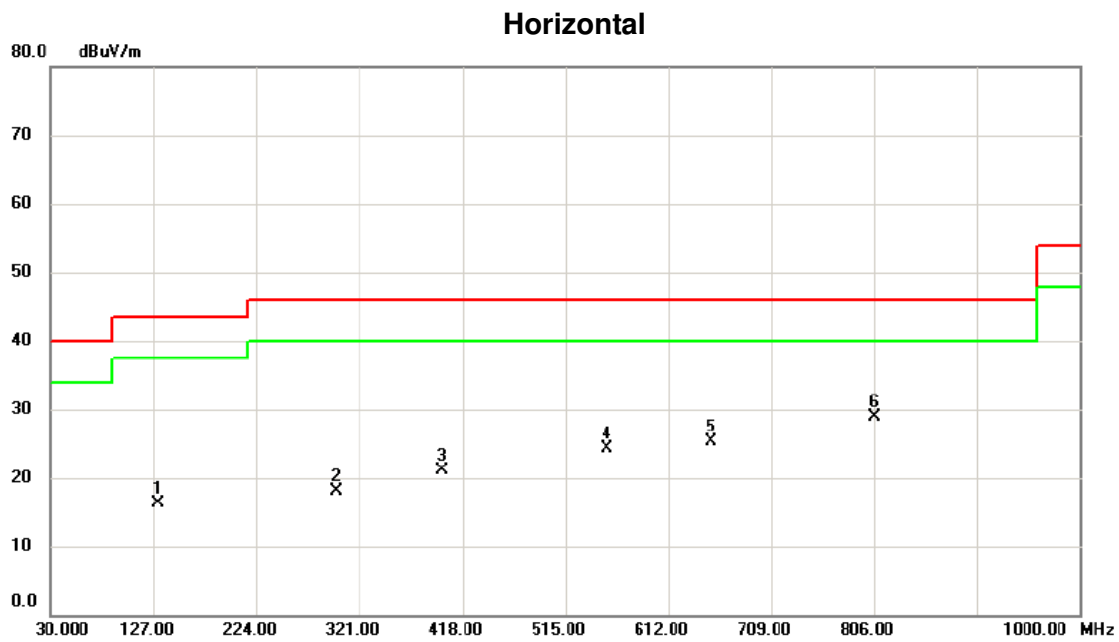

No.	Mk.	Freq. MHz	Reading Level dBuV	Correct Factor dB	Measure- ment dBuV/m	Limit dBuV/m	Margin dB	Detector	Comment
1		130.8800	28.83	-12.49	16.34	43.50	-27.16	peak	
2		300.1450	28.57	-10.46	18.11	46.00	-27.89	peak	
3		399.0850	29.42	-8.32	21.10	46.00	-24.90	peak	
4		554.7700	29.83	-5.53	24.30	46.00	-21.70	peak	
5		652.7400	30.23	-4.93	25.30	46.00	-20.70	peak	
6	*	806.9700	29.95	-0.95	29.00	46.00	-17.00	peak	

Test Mode: TX 2402MHz -CH00- Adapter: MI / AY11BA-AF0522102

**Vertical**

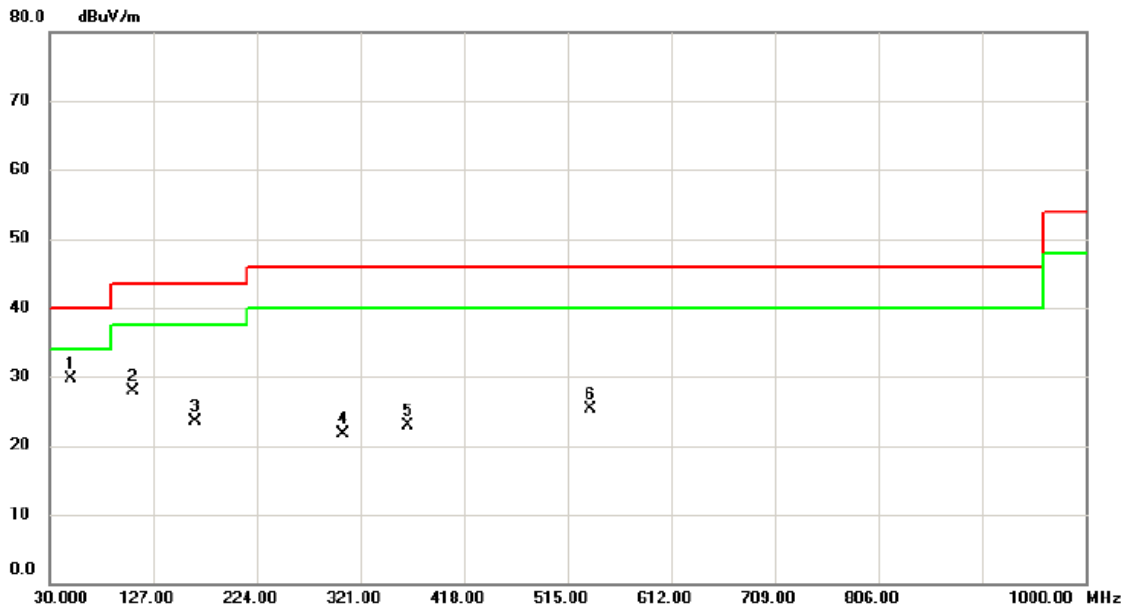

No.	Mk.	Freq. MHz	Reading Level dBuV	Correct Factor dB	Measure- ment dBuV/m	Limit dBuV/m	Margin dB	Detector	Comment
1	*	50.0000	41.72	-11.97	29.75	40.00	-10.25	peak	
2		108.5000	41.76	-13.90	27.86	43.50	-15.64	peak	
3		166.0000	34.94	-11.43	23.51	43.50	-19.99	peak	
4		305.0000	31.65	-10.04	21.61	46.00	-24.39	peak	
5		365.0000	32.64	-9.71	22.93	46.00	-23.07	peak	
6		536.0000	30.76	-5.52	25.24	46.00	-20.76	peak	

Test Mode: TX 2402MHz -CH00- Adapter: MI / AY11BA-AF0522102

### Horizontal

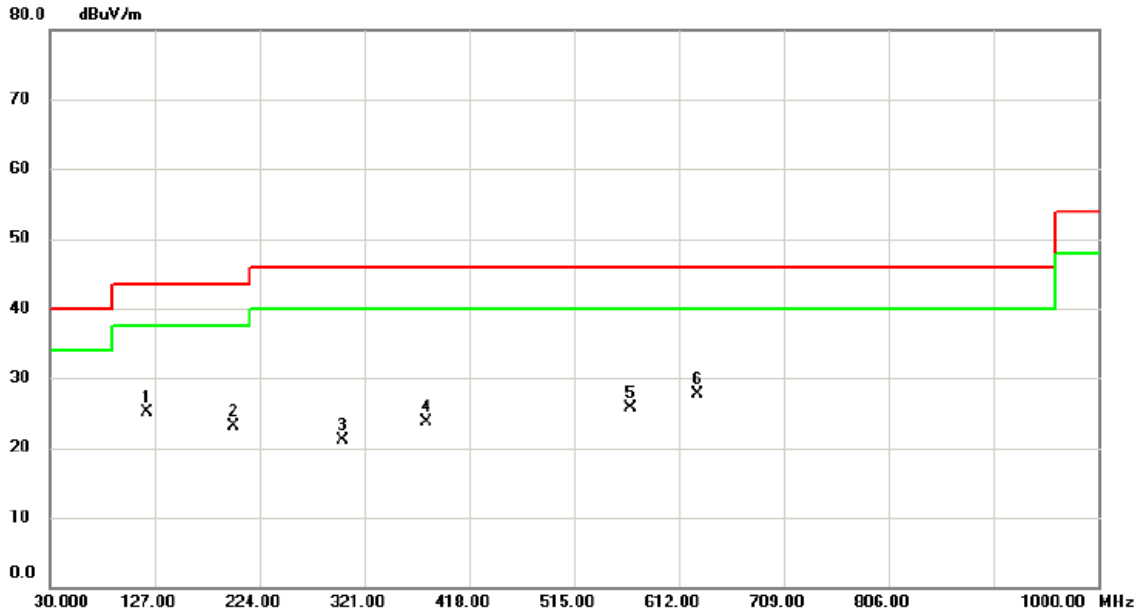

No.	Mk.	Freq. MHz	Reading Level dBuV	Correct Factor dB	Measure- ment dBuV/m	Limit dBuV/m	Margin dB	Detector	Comment
1		120.5000	37.53	-12.48	25.05	43.50	-18.45	peak	
2		200.0000	36.80	-13.62	23.18	43.50	-20.32	peak	
3		300.5000	31.04	-9.97	21.07	46.00	-24.93	peak	
4		378.0000	32.56	-8.79	23.77	46.00	-22.23	peak	
5		567.0000	30.47	-4.80	25.67	46.00	-20.33	peak	
6	*	630.0000	30.95	-3.17	27.78	46.00	-18.22	peak	

Test Mode: TX 2440MHz -CH19- Adapter: MI / AY11BA-AF0522102

**Vertical**

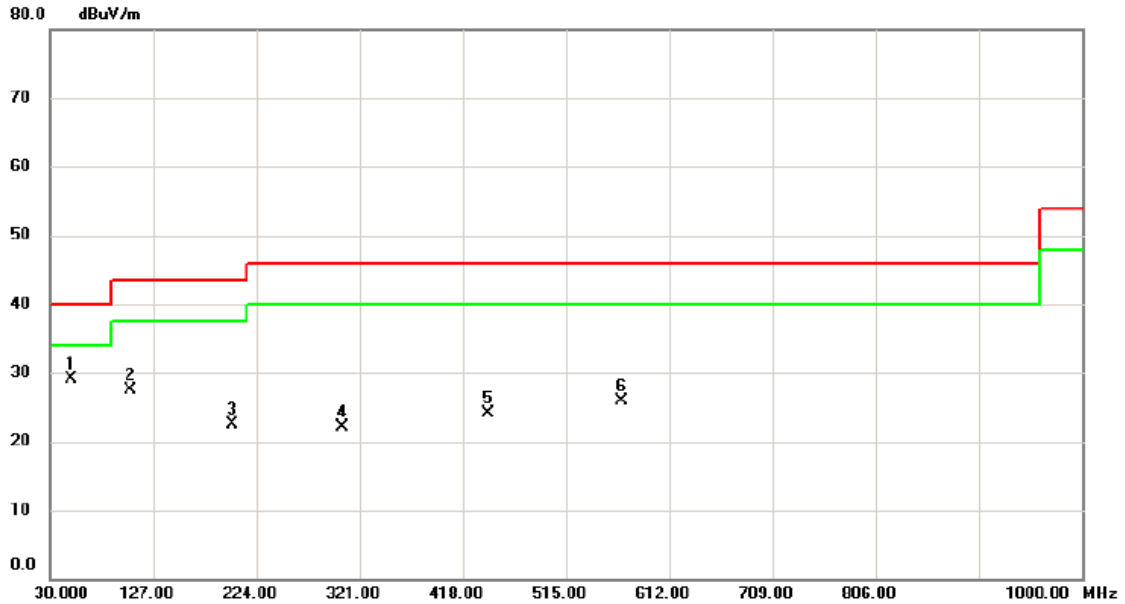

No.	Mk.	Freq.	Reading Level	Correct Factor	Measurement	Limit	Margin	Detector	Comment
		MHz	dBuV	dB	dBuV/m	dBuV/m	dB		
1	*	50.0000	41.12	-11.97	29.15	40.00	-10.85	peak	
2		106.0000	41.57	-14.07	27.50	43.50	-16.00	peak	
3		201.0000	36.20	-13.67	22.53	43.50	-20.97	peak	
4		305.0000	32.11	-10.04	22.07	46.00	-23.93	peak	
5		442.0000	31.13	-7.08	24.05	46.00	-21.95	peak	
6		568.0000	30.63	-4.80	25.83	46.00	-20.17	peak	

Test Mode: TX 2440MHz -CH19- Adapter: MI / AY11BA-AF0522102

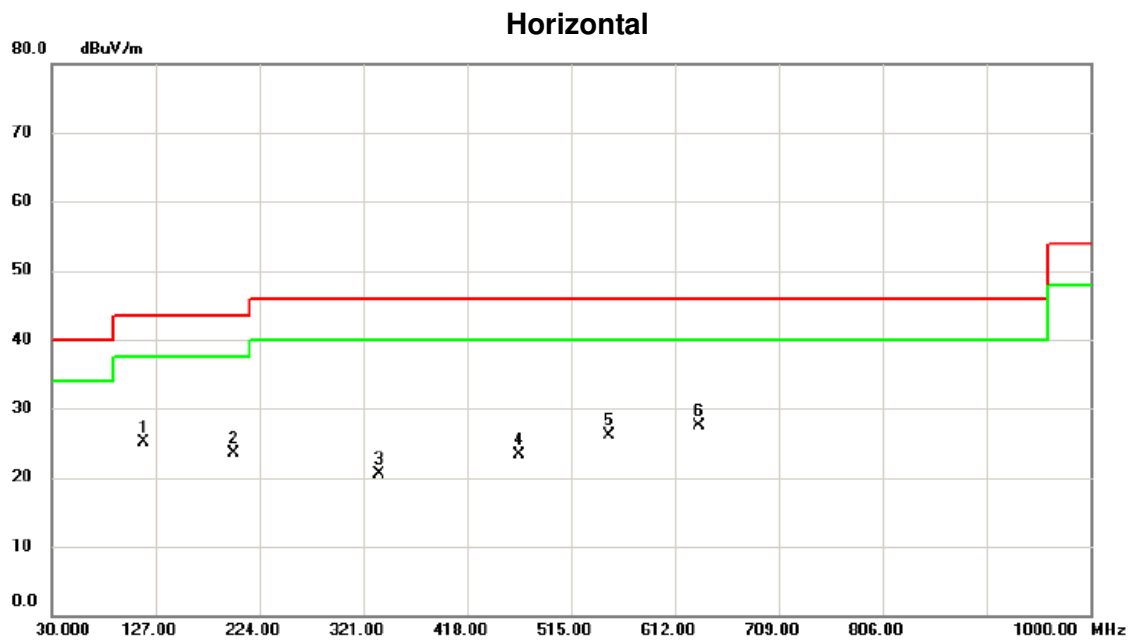

No.	Mk.	Freq. MHz	Reading Level dBuV	Correct Factor dB	Measure- ment dBuV/m	Limit dBuV/m	Margin dB	Detector	Comment
1	*	116.0000	38.13	-13.05	25.08	43.50	-18.42	peak	
2		200.5000	37.19	-13.65	23.54	43.50	-19.96	peak	
3		335.5000	30.99	-10.54	20.45	46.00	-25.55	peak	
4		466.0000	30.56	-7.29	23.27	46.00	-22.73	peak	
5		551.0000	30.85	-4.65	26.20	46.00	-19.80	peak	
6		635.0000	30.32	-2.85	27.47	46.00	-18.53	peak	



Test Mode: TX 2480MHz -CH39- Adapter: MI / AY11BA-AF0522102

### Vertical

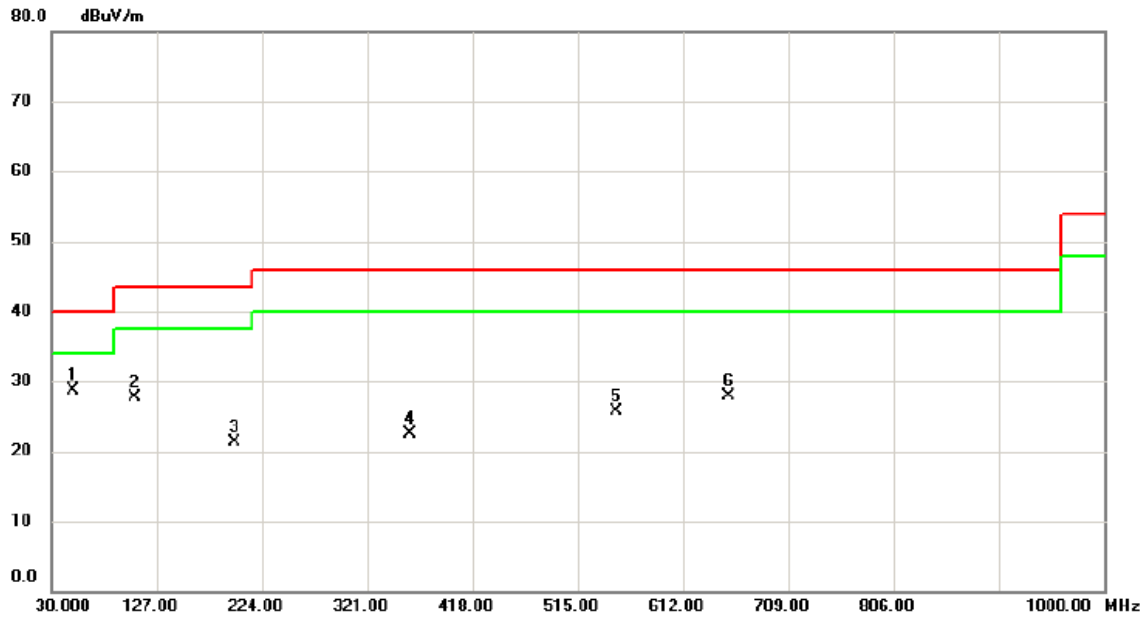

No.	Mk.	Freq. MHz	Reading Level dBuV	Correct Factor dB	Measure- ment dBuV/m	Limit dBuV/m	Margin dB	Detector	Comment
1	*	49.5000	40.83	-12.07	28.76	40.00	-11.24	peak	
2		107.5000	41.64	-13.97	27.67	43.50	-15.83	peak	
3		199.0000	34.83	-13.57	21.26	43.50	-22.24	peak	
4		360.0000	32.52	-10.07	22.45	46.00	-23.55	peak	
5		550.0000	30.27	-4.64	25.63	46.00	-20.37	peak	
6		654.0000	29.72	-1.80	27.92	46.00	-18.08	peak	

Test Mode: TX 2480MHz -CH39- Adapter: MI / AY11BA-AF0522102

### Horizontal

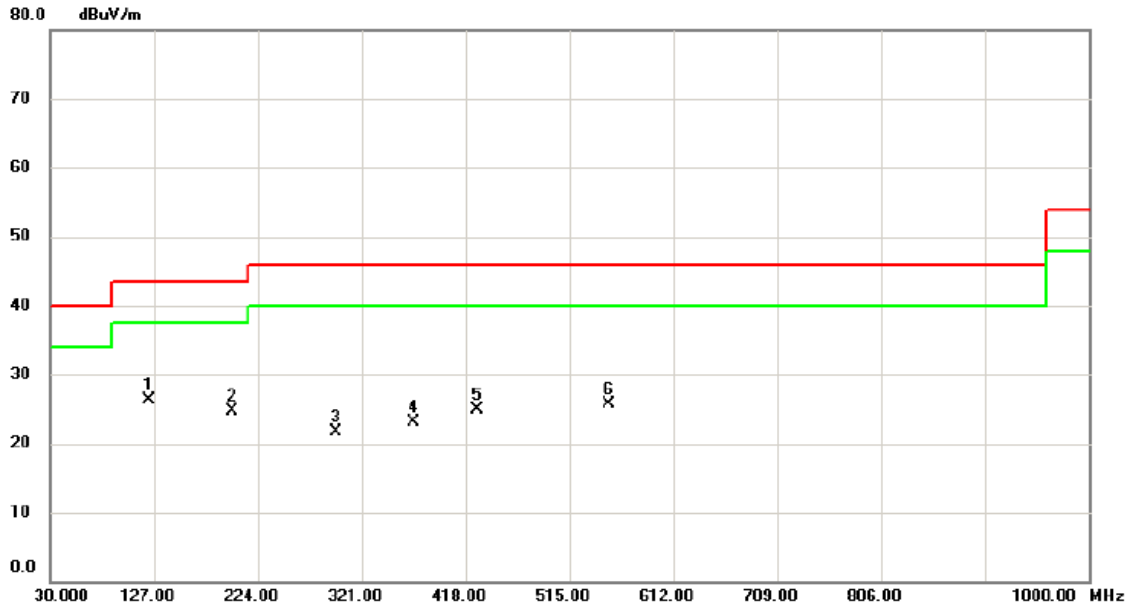

No.	Mk.	Freq. MHz	Reading Level dBuV	Correct Factor dB	Measure- ment dBuV/m	Limit dBuV/m	Margin dB	Detector	Comment
1	*	122.5000	38.58	-12.19	26.39	43.50	-17.11	peak	
2		200.0000	38.32	-13.62	24.70	43.50	-18.80	peak	
3		297.5000	31.68	-9.97	21.71	46.00	-24.29	peak	
4		369.0000	32.45	-9.43	23.02	46.00	-22.98	peak	
5		429.5000	32.05	-7.12	24.93	46.00	-21.07	peak	
6		552.5000	30.34	-4.65	25.69	46.00	-20.31	peak	

## ATTACHMENT D - RADIATED EMISSION (ABOVE 1000MHZ)

Orthogonal Axis :	X
Test Mode :	TX 2402MHz _CH00

### Vertical

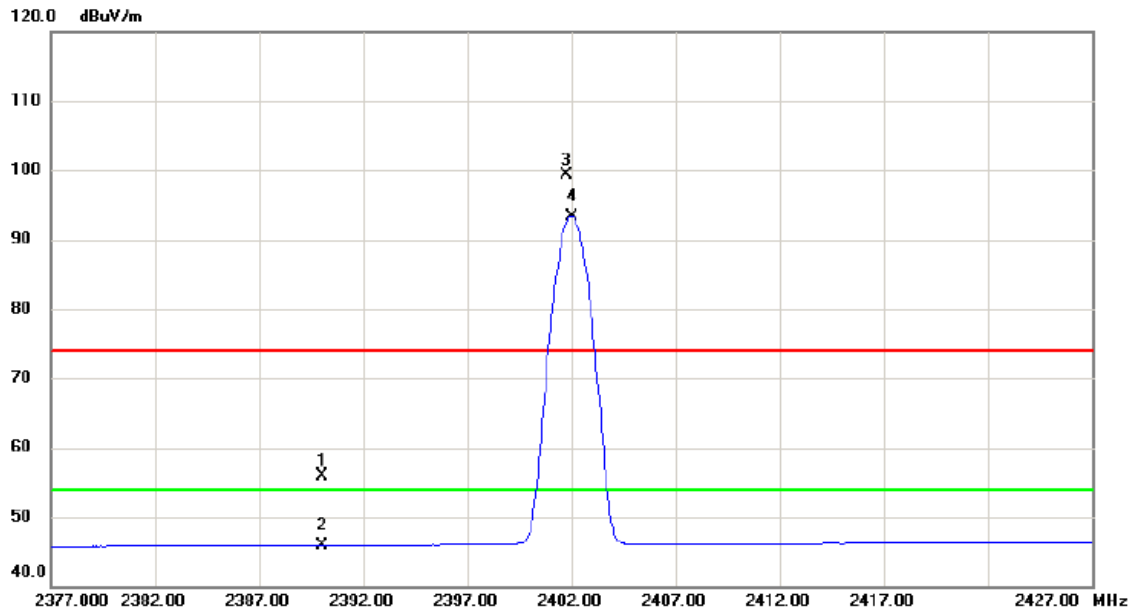

No.	Mk.	Freq. MHz	Reading Level dBuV	Correct Factor dB	Measure- ment dBuV/m	Limit dBuV/m	Margin dB	Detector	Comment
1		2390.000	23.07	32.77	55.84	74.00	-18.16	peak	
2		2390.000	13.16	32.77	45.93	54.00	-8.07	AVG	
3	X	2401.750	66.56	32.82	99.38	74.00	25.38	peak	No Limit
4	*	2402.000	60.54	32.82	93.36	54.00	39.36	AVG	No Limit

Orthogonal Axis :	X
Test Mode :	TX 2402MHz _CH00

### Vertical

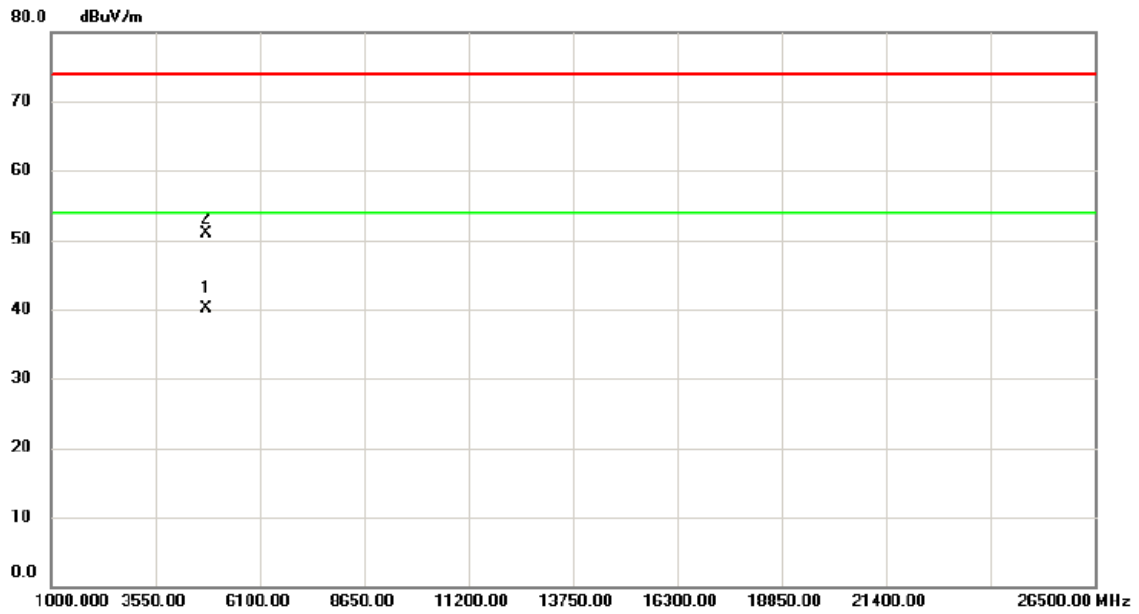

No.	Mk.	Freq. MHz	Reading Level dBuV	Correct Factor dB	Measure- ment dBuV/m	Limit dBuV/m	Margin dB	Detector	Comment
1	*	4803.895	35.56	4.62	40.18	54.00	-13.82	AVG	
2		4804.495	46.33	4.63	50.96	74.00	-23.04	peak	

Orthogonal Axis :	X
Test Mode :	TX 2402MHz _CH00

### Horizontal

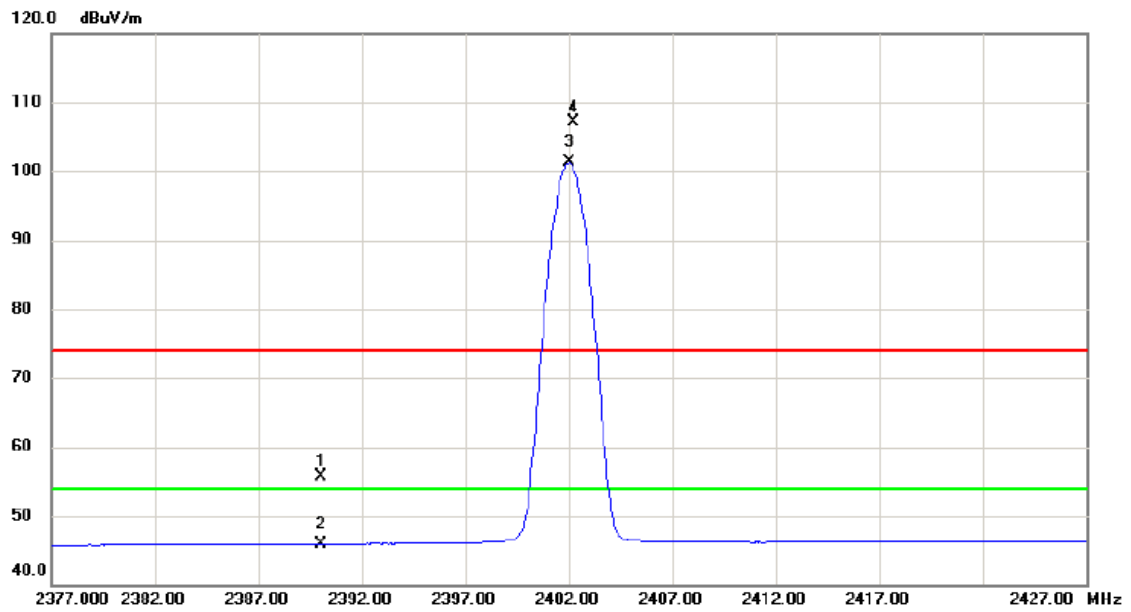

No.	Mk.	Freq. MHz	Reading Level dBuV	Correct Factor dB	Measure- ment dBuV/m	Limit dBuV/m	Margin dB	Detector	Comment
1		2390.000	22.85	32.77	55.62	74.00	-18.38	peak	
2		2390.000	13.17	32.77	45.94	54.00	-8.06	AVG	
3	*	2402.000	68.41	32.82	101.23	54.00	47.23	AVG	No Limit
4	X	2402.250	74.36	32.82	107.18	74.00	33.18	peak	No Limit

Orthogonal Axis :	X
Test Mode :	TX 2402MHz _CH00

### Horizontal

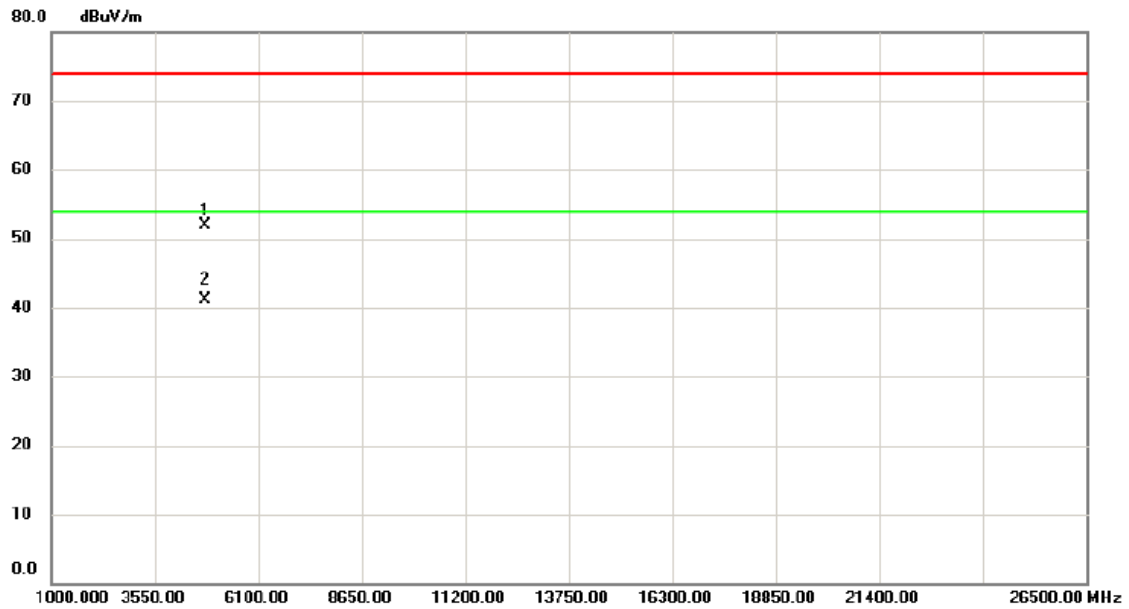

No.	Mk.	Freq. MHz	Reading Level dBuV	Correct Factor dB	Measure- ment dBuV/m	Limit dBuV/m	Margin dB	Detector	Comment
1		4803.675	47.21	4.62	51.83	74.00	-22.17	peak	
2	*	4803.900	36.53	4.62	41.15	54.00	-12.85	AVG	

Orthogonal Axis :	X
Test Mode :	TX 2440MHz _CH19

### Vertical

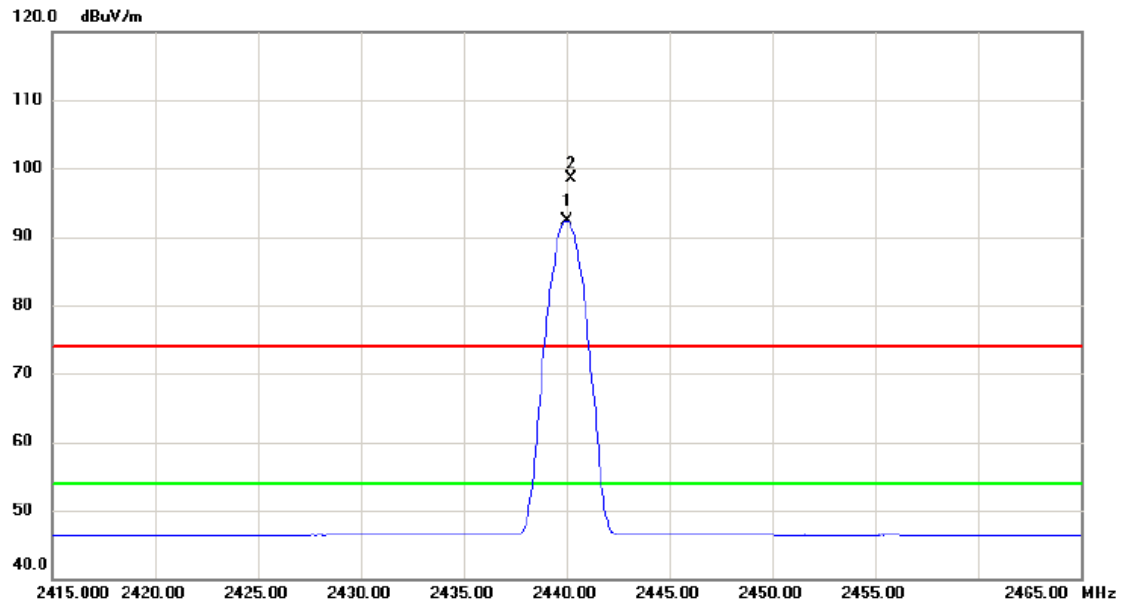

No.	Mk.	Freq. MHz	Reading Level dBuV	Correct Factor dB	Measure- ment dBuV/m	Limit dBuV/m	Margin dB	Detector	Comment
1	*	2440.000	59.42	32.97	92.39	54.00	38.39	AVG	No Limit
2	X	2440.250	65.45	32.98	98.43	74.00	24.43	peak	No Limit



Orthogonal Axis :	X
Test Mode :	TX 2440MHz _CH19

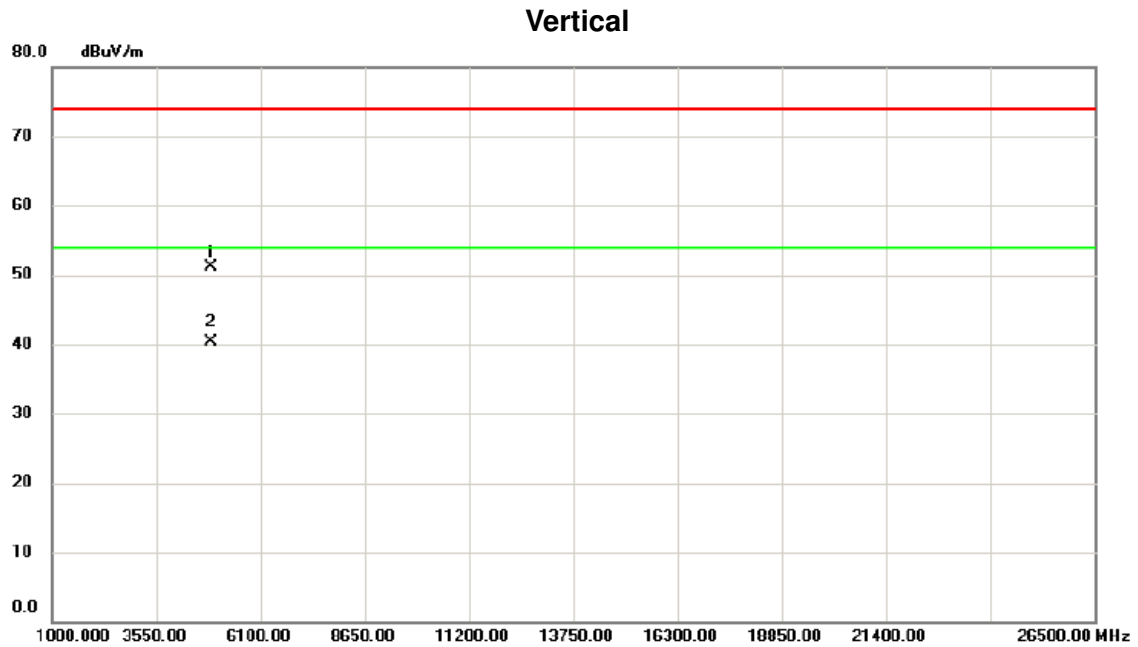

No.	Mk.	Freq. MHz	Reading Level dBuV	Correct Factor dB	Measure- ment dBuV/m	Limit dBuV/m	Margin dB	Detector	Comment
1		4879.625	46.25	4.91	51.16	74.00	-22.84	peak	
2	*	4879.905	35.39	4.91	40.30	54.00	-13.70	AVG	

Orthogonal Axis :	X
Test Mode :	TX 2440MHz _CH19

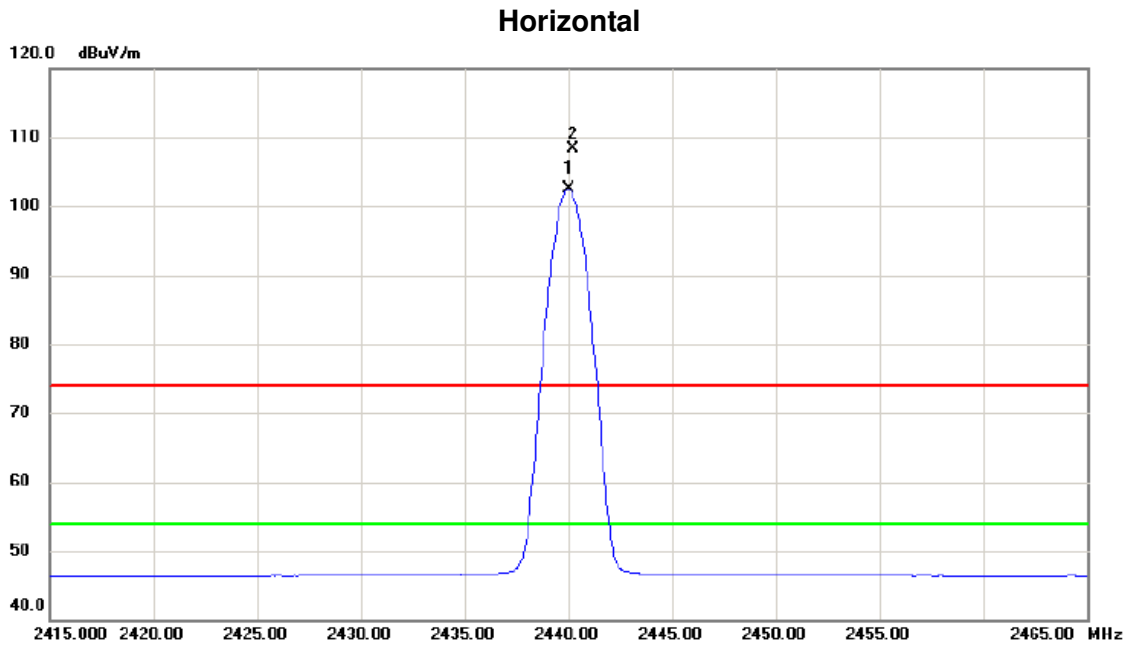

No.	Mk.	Freq. MHz	Reading Level dBuV	Correct Factor dB	Measure- ment dBuV/m	Limit dBuV/m	Margin dB	Detector	Comment
1	*	2440.000	69.46	32.97	102.43	54.00	48.43	AVG	No Limit
2	X	2440.250	75.42	32.98	108.40	74.00	34.40	peak	No Limit

Orthogonal Axis :	X
Test Mode :	TX 2440MHz _CH19

### Horizontal

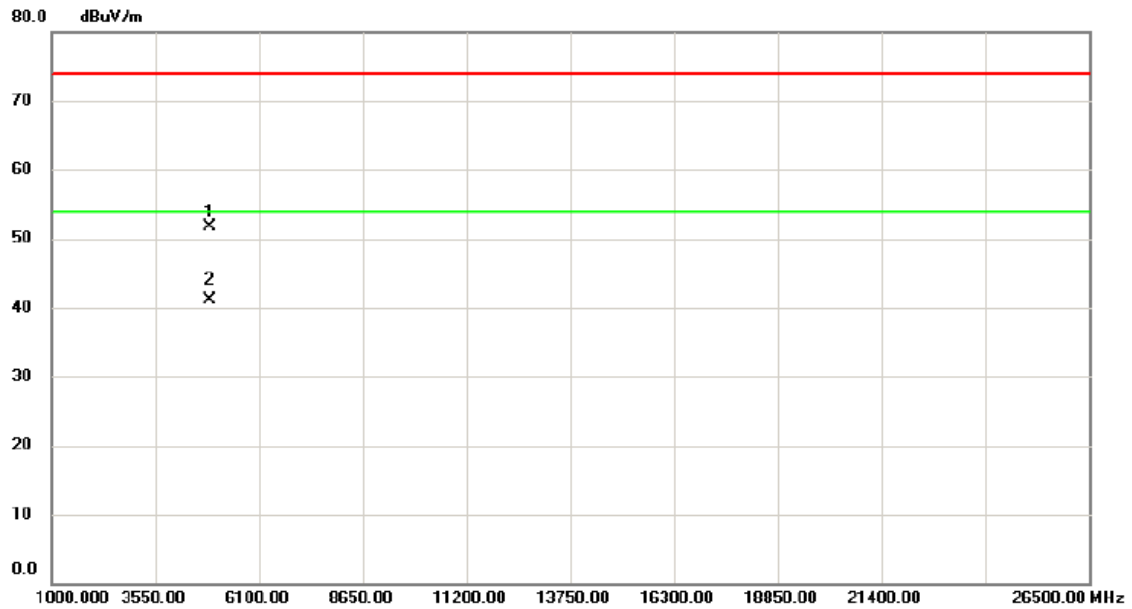

No.	Mk.	Freq. MHz	Reading Level dBuV	Correct Factor dB	Measure- ment dBuV/m	Limit dBuV/m	Margin dB	Detector	Comment
1		4879.395	46.71	4.91	51.62	74.00	-22.38	peak	
2	*	4879.930	36.26	4.91	41.17	54.00	-12.83	AVG	

Orthogonal Axis :	X
Test Mode :	TX 2480MHz _CH39

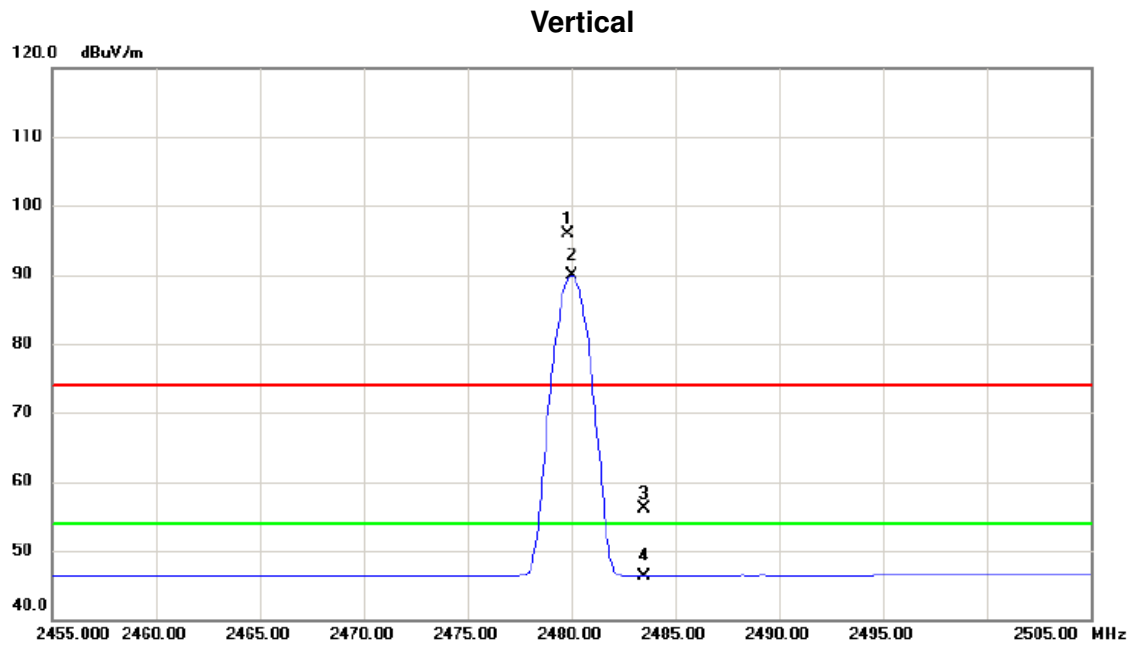

No.	Mk.	Freq. MHz	Reading Level dBuV	Correct Factor dB	Measure- ment dBuV/m	Limit dBuV/m	Margin dB	Detector	Comment
1	X	2479.800	62.78	33.14	95.92	74.00	21.92	peak	No Limit
2	*	2480.000	56.79	33.14	89.93	54.00	35.93	AVG	No Limit
3		2483.500	22.98	33.15	56.13	74.00	-17.87	peak	
4		2483.500	13.21	33.15	46.36	54.00	-7.64	AVG	

Orthogonal Axis :	X
Test Mode :	TX 2480MHz _CH39

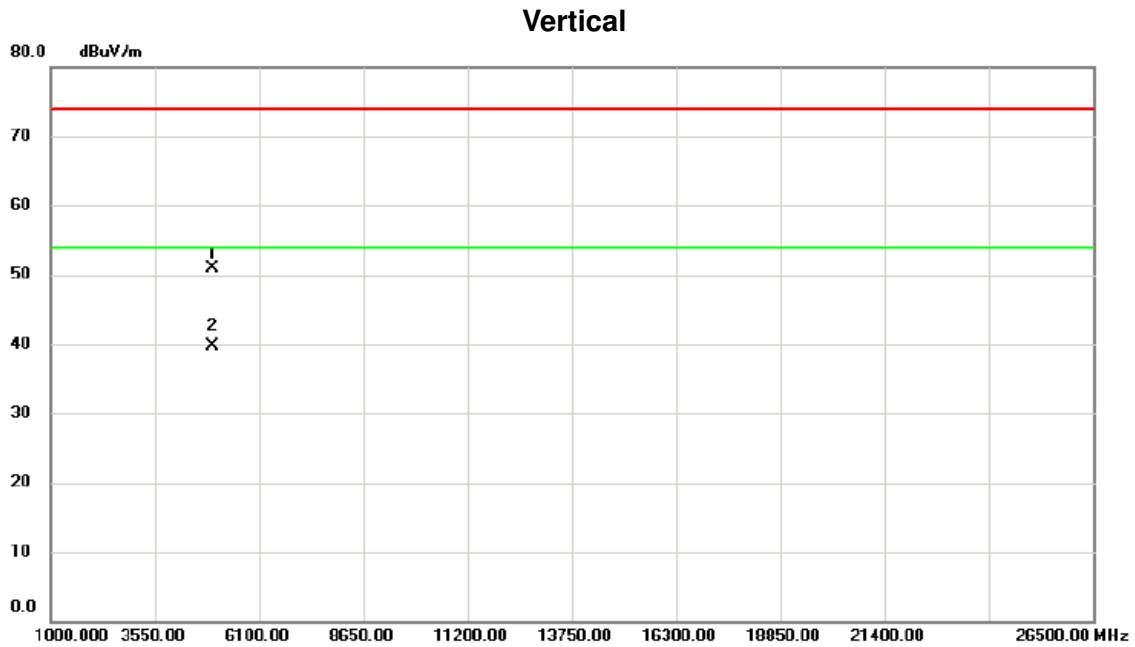

No.	Mk.	Freq. MHz	Reading Level dBuV	Correct Factor dB	Measure- ment dBuV/m	Limit dBuV/m	Margin dB	Detector	Comment
1		4959.545	45.70	5.22	50.92	74.00	-23.08	peak	
2	*	4959.825	34.55	5.22	39.77	54.00	-14.23	AVG	

Orthogonal Axis :	X
Test Mode :	TX 2480MHz _CH39

### Horizontal

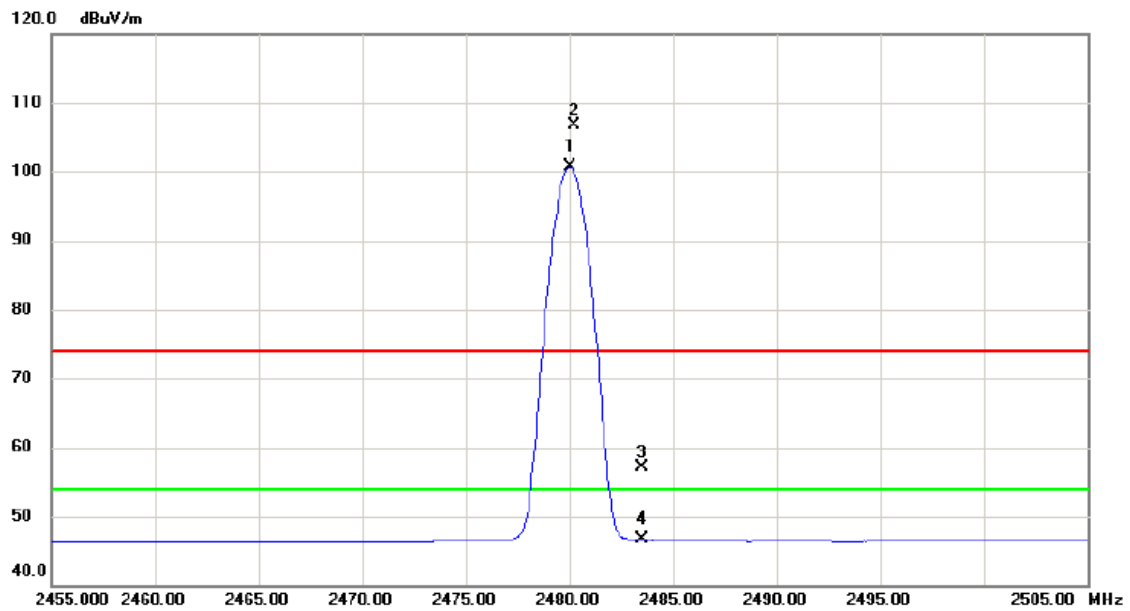

No.	Mk.	Freq. MHz	Reading Level dBuV	Correct Factor dB	Measure- ment dBuV/m	Limit dBuV/m	Margin dB	Detector	Comment
1	*	2480.000	67.57	33.14	100.71	54.00	46.71	AVG	No Limit
2	X	2480.250	73.54	33.14	106.68	74.00	32.68	peak	No Limit
3		2483.500	24.02	33.15	57.17	74.00	-16.83	peak	
4		2483.500	13.55	33.15	46.70	54.00	-7.30	AVG	

Orthogonal Axis :	X
Test Mode :	TX 2480MHz _CH39

### Horizontal

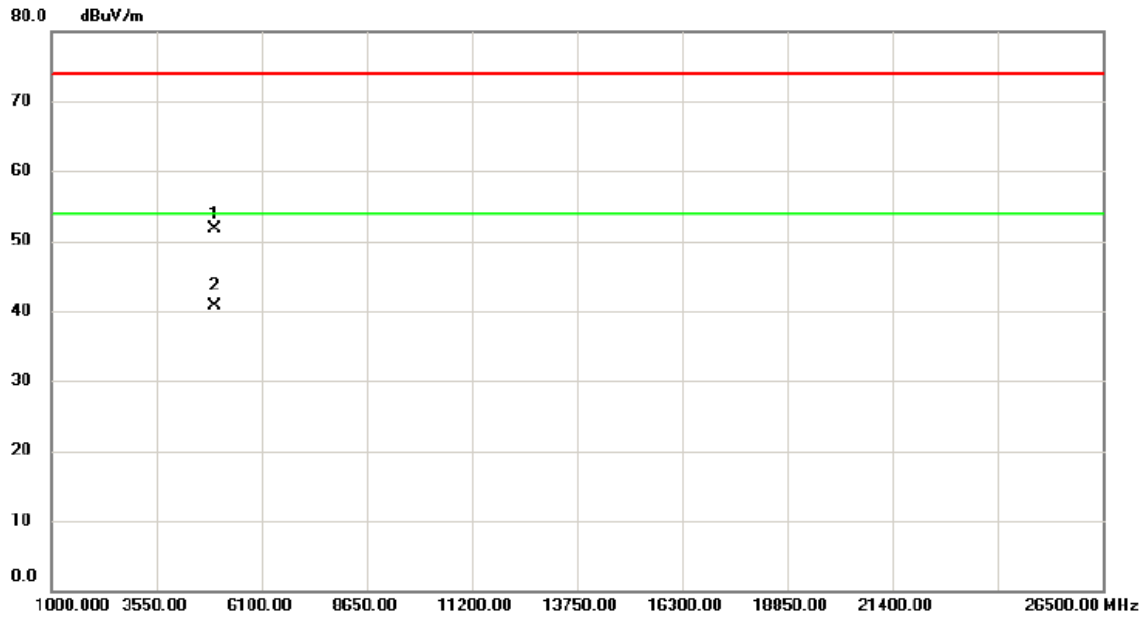

No.	Mk.	Freq.	Reading Level	Correct Factor	Measurement	Limit	Margin	Detector	Comment
		MHz	dBuV	dB	dBuV/m	dBuV/m	dB		
1		4959.385	46.49	5.22	51.71	74.00	-22.29	peak	
2	*	4959.890	35.43	5.22	40.65	54.00	-13.35	AVG	

## ATTACHMENT E - BANDWIDTH



Test Mode : CH00, CH19 , CH39

Frequency (MHz)	6dB Bandwidth (MHz)	99% Occupied BW (MHz)	Min. Limit (kHz)	Test Result
2402	0.714	1.082	500	Complies
2440	0.710	1.082	500	Complies
2480	0.712	1.084	500	Complies

### TX CH00

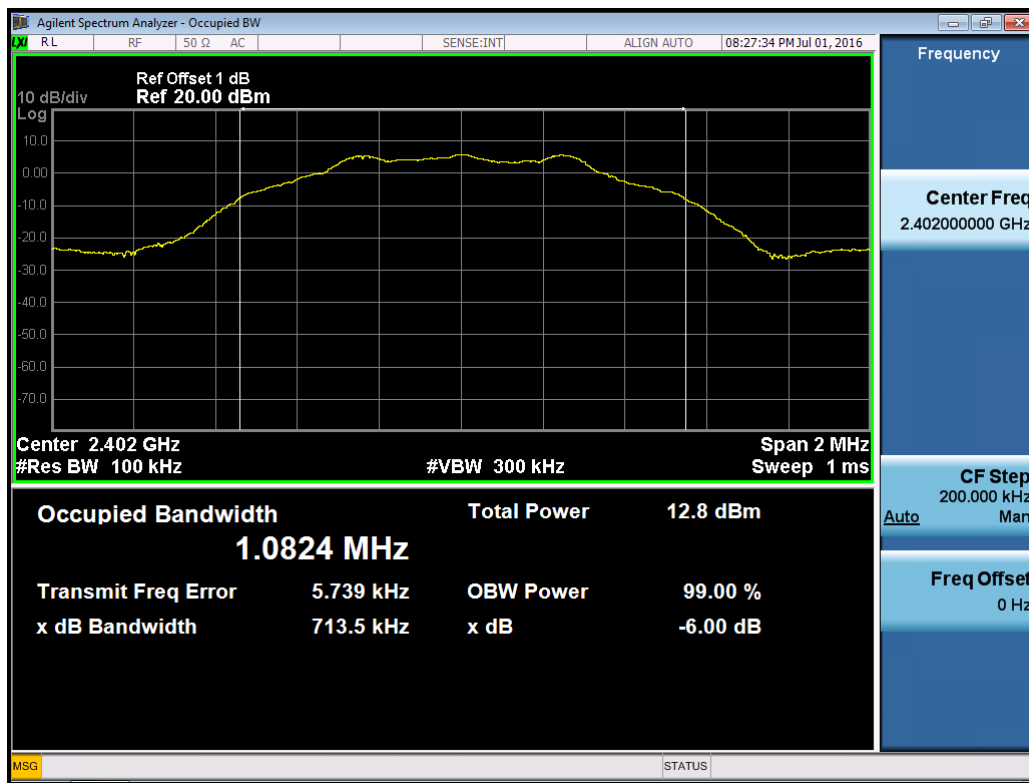

### TX CH19

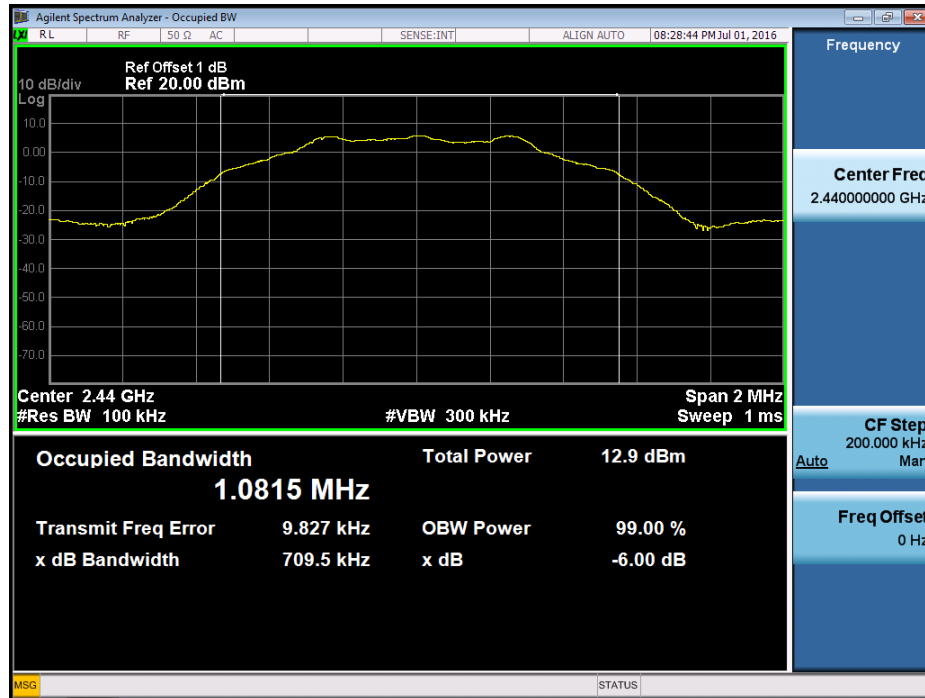

### TX CH39

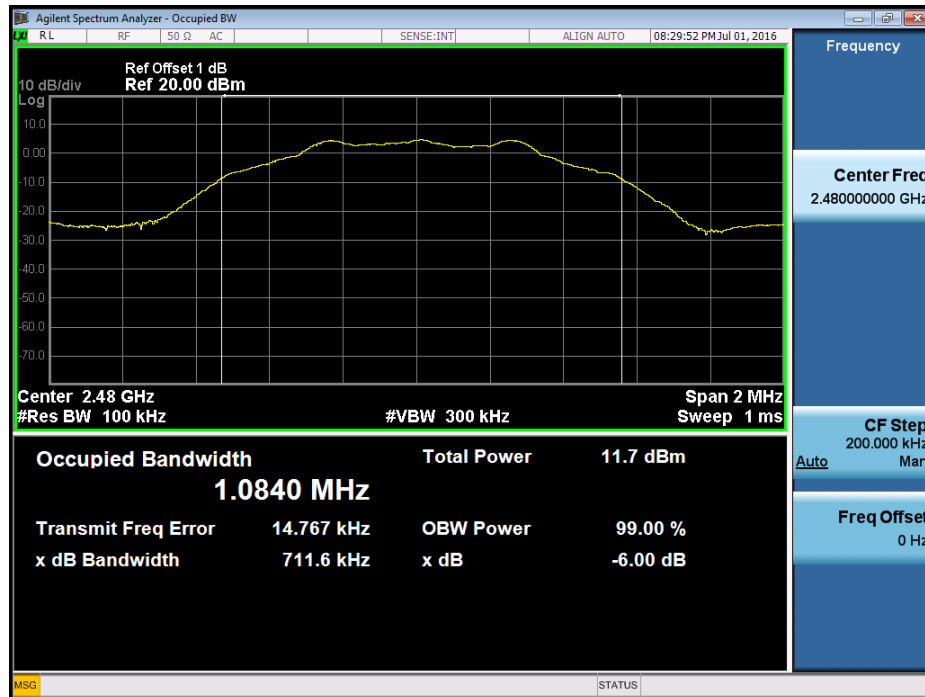

## ATTACHMENT F - MAXIMUM OUTPUT POWER TEST

Test Mode :	CH00, CH19 , CH39
-------------	-------------------

Frequency	Conducted Power (dBm)	Conducted Power (W)	Max. Limit(dBm)	Max. Limit(W)	Result
2402 MHz	6.37	0.0043	30.00	1.0000	Complies
2440 MHz	6.48	0.0044	30.00	1.0000	Complies
2480 MHz	5.28	0.0034	30.00	1.0000	Complies

# ATTACHMENT G - ANTENNA CONDUCTED SPURIOUS EMISSION

Test Mode : CH00, CH19 , CH39

CH00 (Lower)

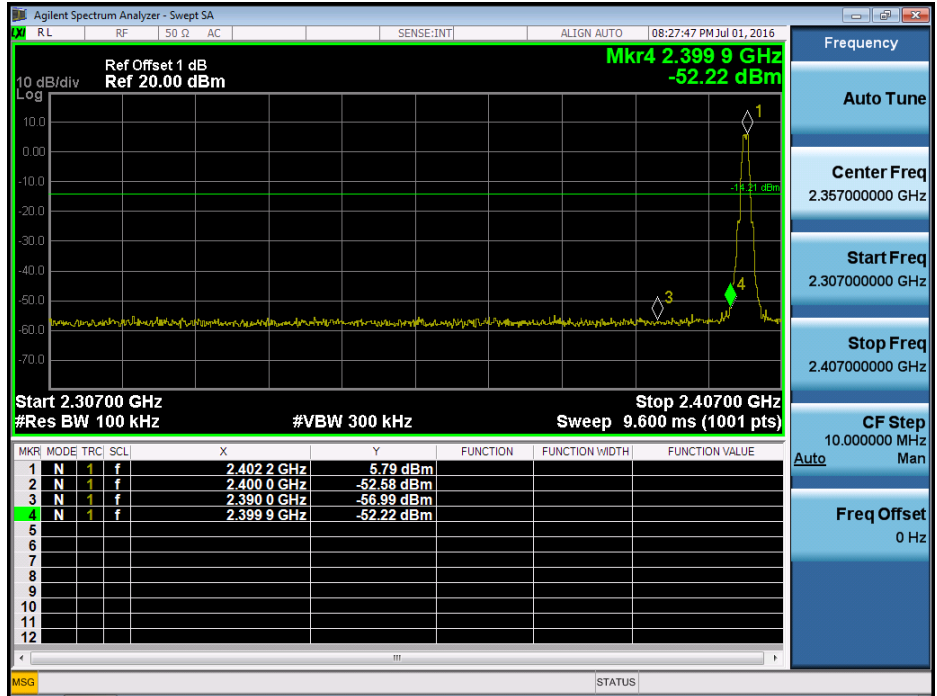

CH39 (upper) - 1Mbps

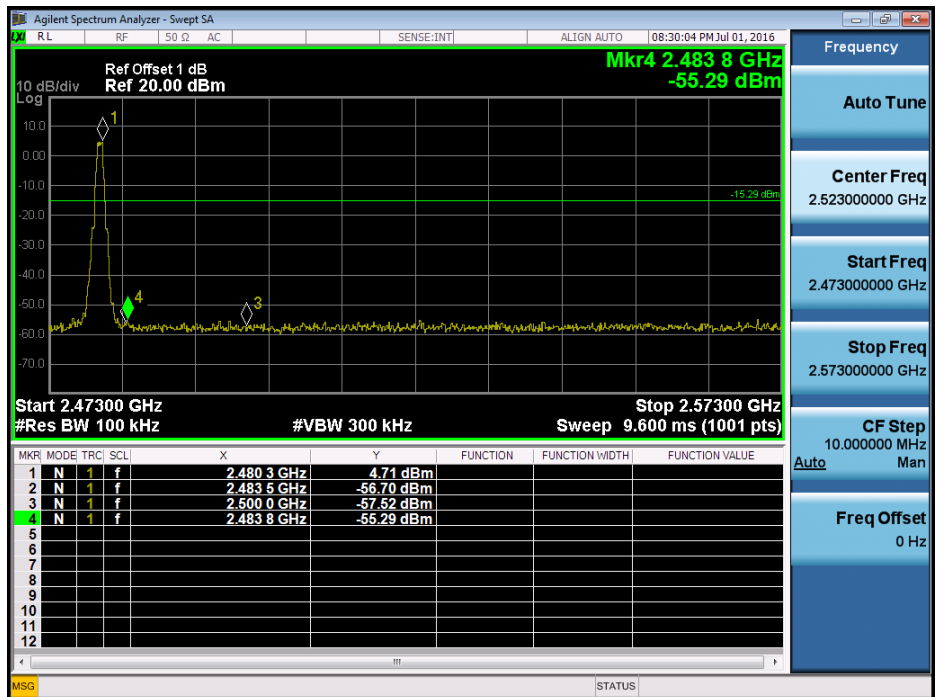

### CH00 (10 Harmonic of the frequency)-1

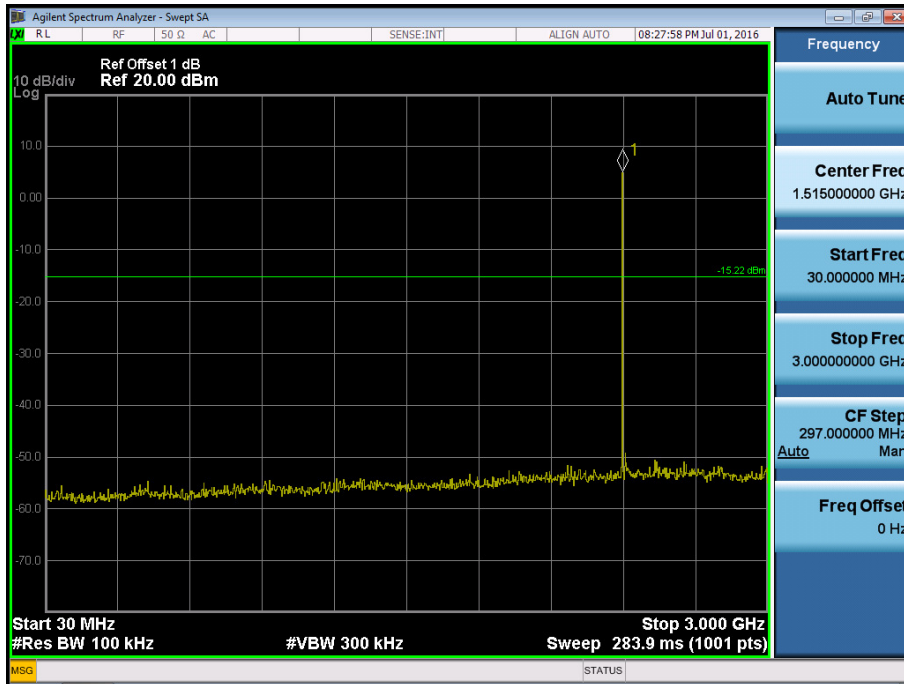

### CH00 (10 Harmonic of the frequency)-2

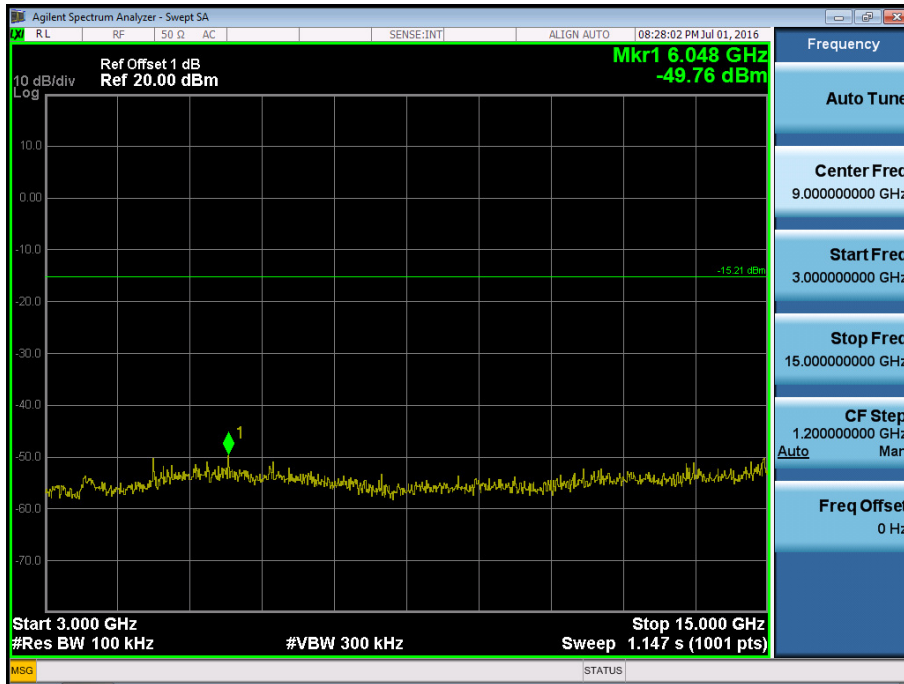

### CH00 (10 Harmonic of the frequency)-3

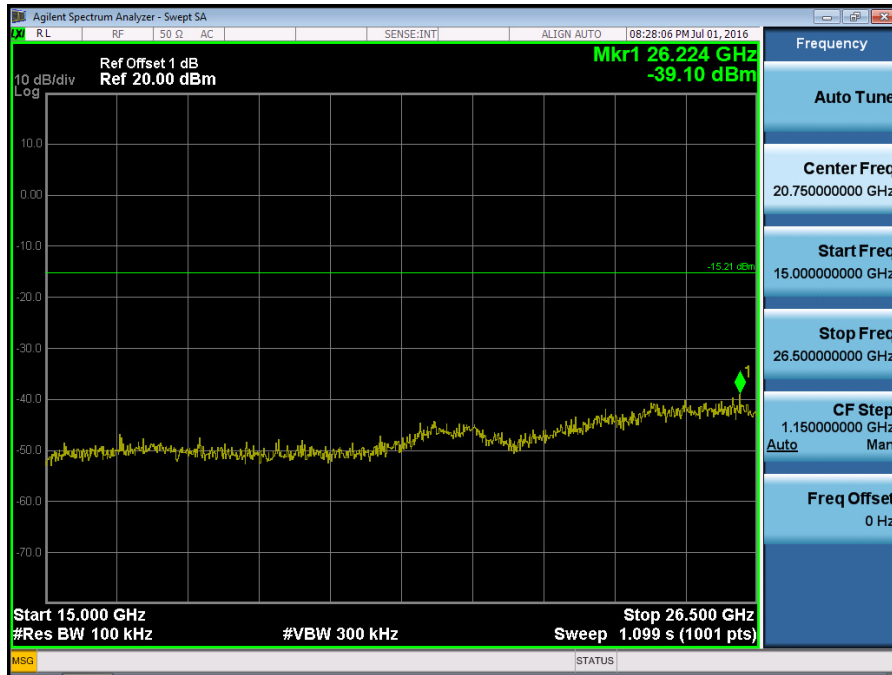

### CH19 (10 Harmonic of the frequency)-1

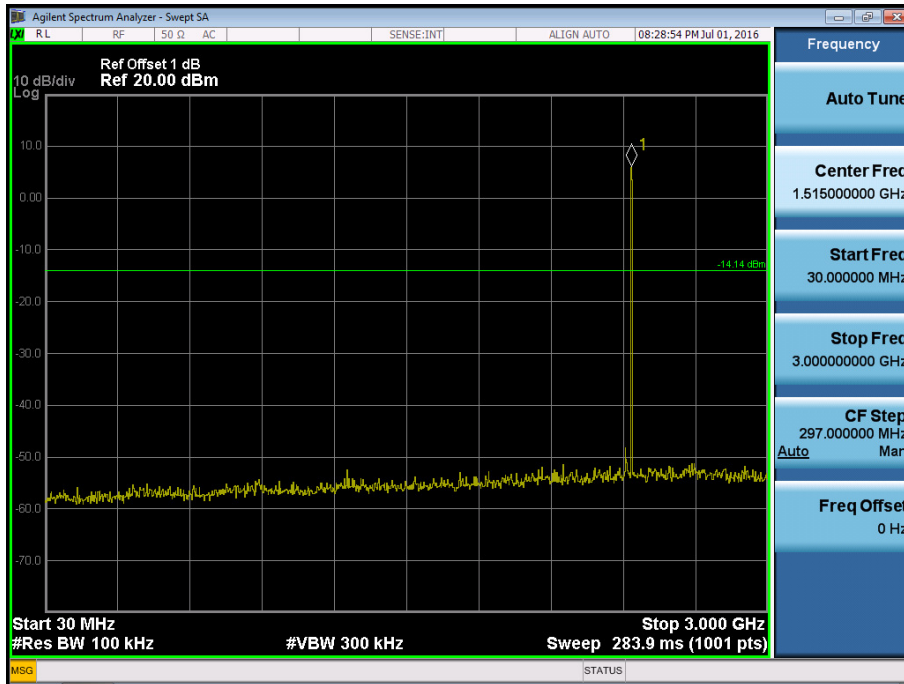

### CH19 (10 Harmonic of the frequency)-2

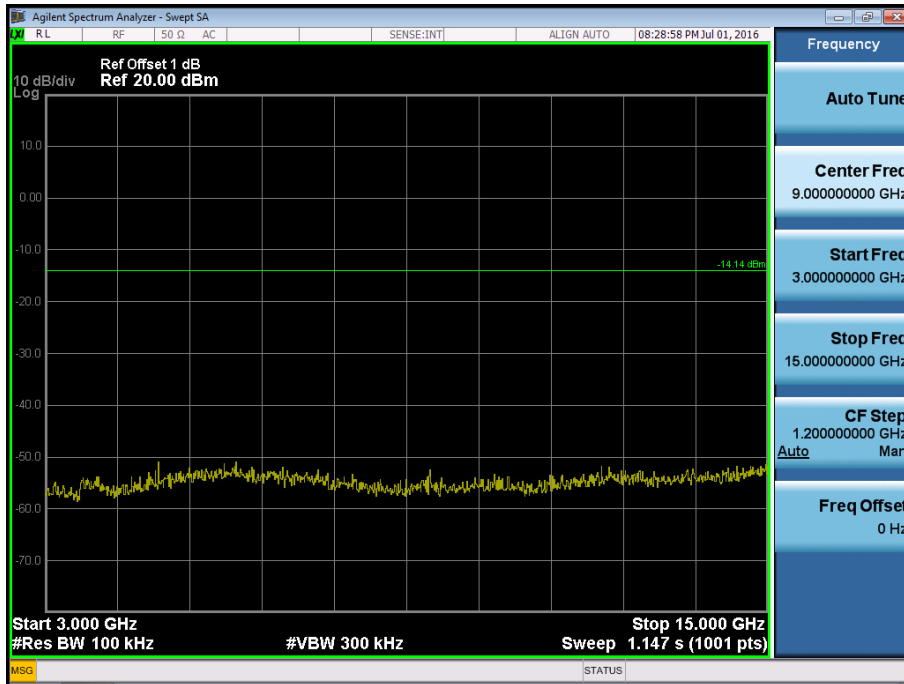



### CH19 (10 Harmonic of the frequency)-3



### CH39 (10 Harmonic of the frequency)-1

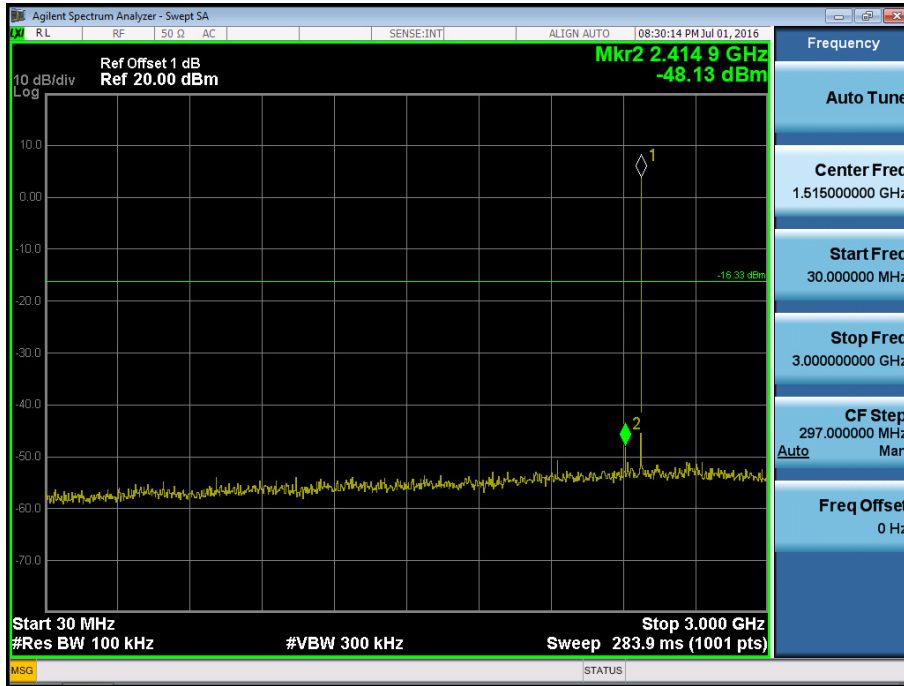

### CH39 (10 Harmonic of the frequency)-2

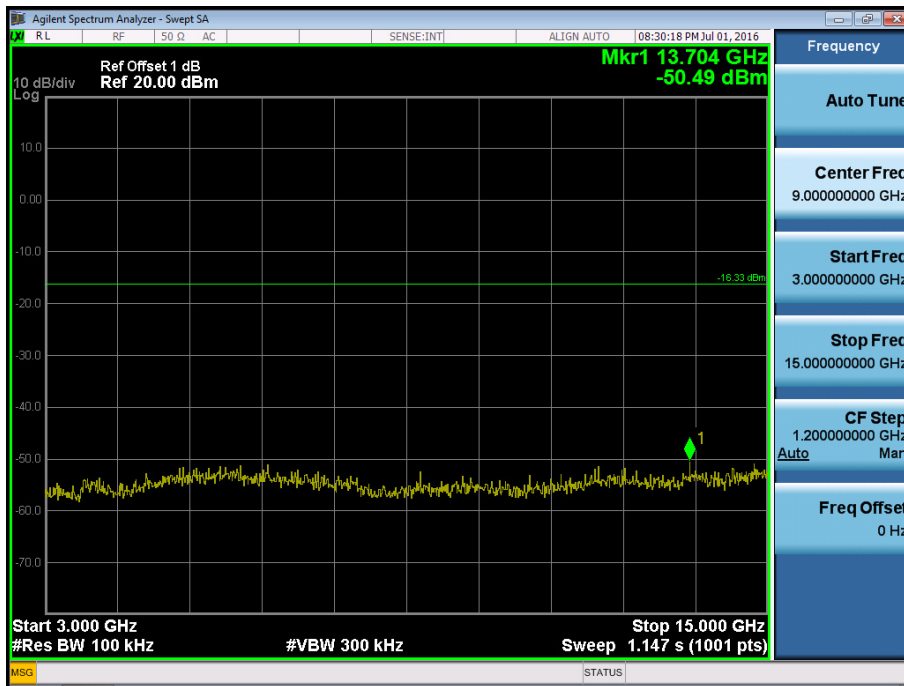

**CH39 (10 Harmonic of the frequency)-3**

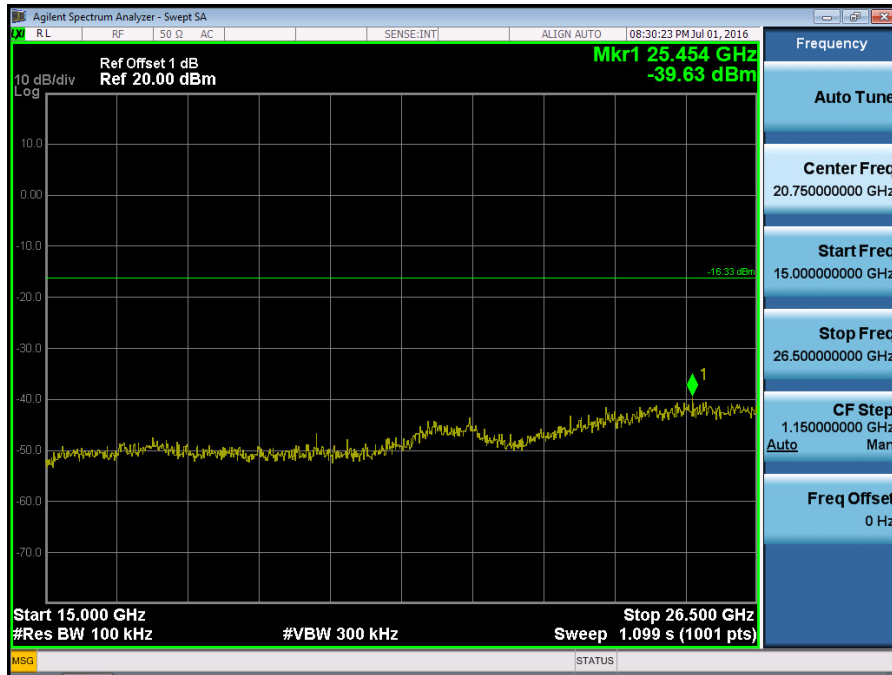

## ATTACHMENT H - POWER SPECTRAL DENSITY TEST

Test Mode : CH00, CH19 , CH39

Frequency (MHz)	Power Density (dBm)	Max. Limit (dBm)	Result
2402	-8.29	8	Complies
2440	-8.00	8	Complies
2480	-9.03	8	Complies

**TX CH00**

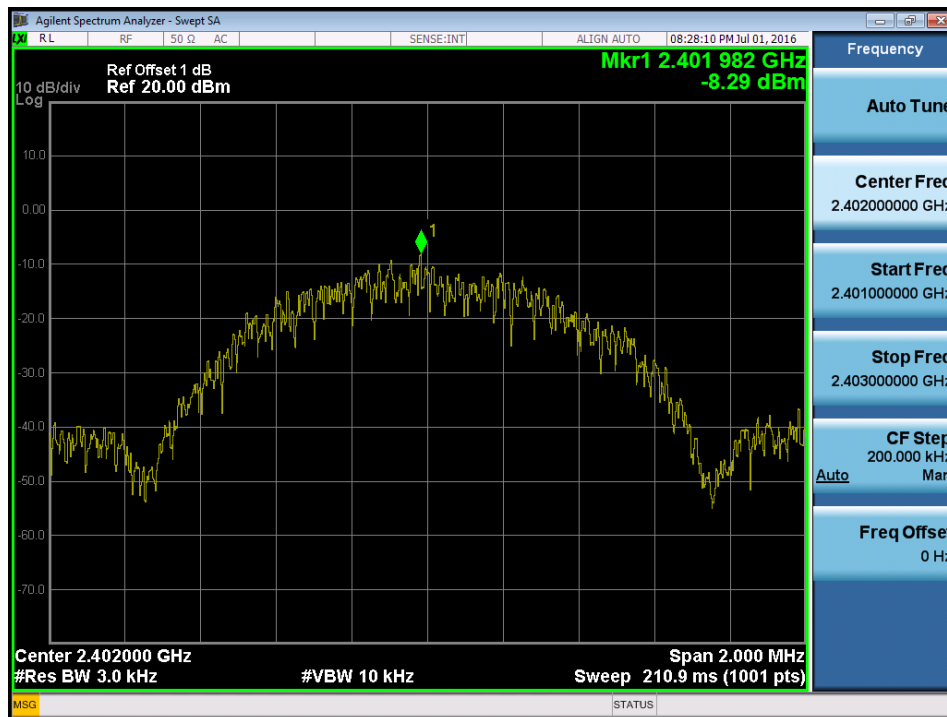

**TX CH19**

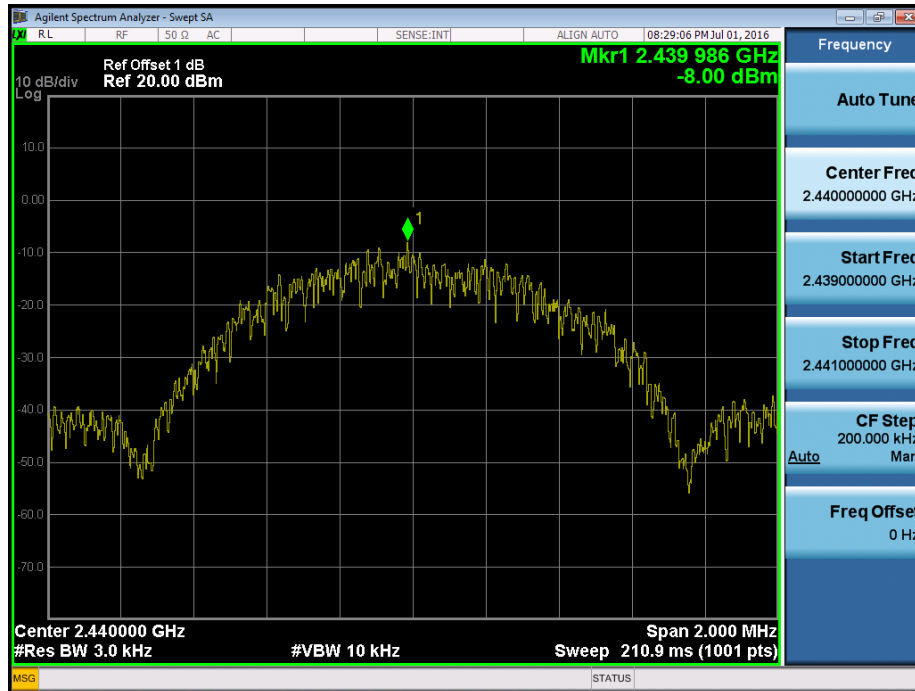

**TX CH39**

