



**Version**

Version No.	Date	Description
V1.0	Jan. 23, 2019	Original



## Contents

	Page
<b>1 GENERAL INFORMATION .....</b>	<b>5</b>
<b>1.1 STATEMENT OF COMPLIANCE.....</b>	<b>5</b>
<b>1.2 EUT DESCRIPTION.....</b>	<b>6</b>
1.2.1 General Description.....	6
1.2.2 Wireless Technologies.....	7
1.2.3 List of Accessory.....	7
<b>1.3 MAXIMUM CONDUCTED POWER .....</b>	<b>8</b>
<b>1.4 OTHER INFORMATION.....</b>	<b>9</b>
<b>1.5 TESTING LOCATION .....</b>	<b>9</b>
<b>1.6 TEST FACILITY .....</b>	<b>9</b>
<b>1.7 GUIDANCE STANDARD .....</b>	<b>10</b>
<b>2 SPECIFIC ABSORPTION RATE (SAR).....</b>	<b>11</b>
<b>2.1 INTRODUCTION.....</b>	<b>11</b>
<b>2.2 SAR DEFINITION.....</b>	<b>11</b>
<b>2.3 SAR LIMITS .....</b>	<b>11</b>
<b>3 SAR MEASUREMENT SYSTEM .....</b>	<b>12</b>
<b>3.1 SPEAG DASY SYSTEM .....</b>	<b>12</b>
3.1.1 Robot .....	12
3.1.2 Probe .....	13
3.1.3 Data Acquisition Electronics (DAE) .....	13
3.1.4 Phantom .....	14
3.1.5 Device Holder .....	15
3.1.6 System Validation Dipoles.....	15
<b>3.2 SAR SCAN PROCEDURE.....</b>	<b>16</b>
3.2.1 SAR Reference Measurement (drift).....	16
3.2.2 Area Scan.....	16
3.2.3 Zoom Scan .....	16
3.2.4 SAR Drift Measurement.....	17
<b>3.3 TEST EQUIPMENT .....</b>	<b>18</b>
<b>3.4 MEASUREMENT UNCERTAINTY.....</b>	<b>19</b>
<b>3.5 TISSUE DIELECTRIC PARAMETER MEASUREMENT &amp; SYSTEM VERIFICATION .....</b>	<b>20</b>
3.5.1 Tissue Simulating Liquids.....	20
3.5.2 System Check Description .....	22
3.5.3 Tissue Verification.....	23
3.5.4 System Verification .....	23
<b>4 SAR MEASUREMENT EVALUATION.....</b>	<b>24</b>
<b>4.1 EUT CONFIGURATION AND SETTING.....</b>	<b>24</b>
4.1.1 GSM Configuration and Testing.....	24
4.1.2 WCDMA Configuration and Testing.....	24
4.1.3 LTE Configuration and Testing .....	26
4.1.4 WLAN Configuration and Testing .....	26
<b>4.2 EUT TESTING POSITION.....</b>	<b>28</b>
4.2.1 Head Exposure Conditions.....	28
4.2.2 Body-worn Accessory Exposure Conditions.....	30
4.2.3 Hotspot Mode Exposure Conditions.....	31
<b>4.3 MEASURED CONDUCTED POWER RESULT .....</b>	<b>32</b>
4.3.1 Conducted Power of GSM Band .....	32
4.3.2 Conducted Power of WCDMA Band.....	33
4.3.3 Conducted Power of LTE Band .....	34
4.3.4 Conducted Power of WLAN .....	41

4.3.5	Conducted Power of BT .....	43
<b>4.4</b>	<b>SAR TEST EXCLUSION EVALUATIONS .....</b>	<b>44</b>
4.4.1	Standalone SAR Test Exclusion Considerations .....	44
4.4.2	Estimated SAR Calculation .....	45
<b>4.5</b>	<b>SAR TESTING RESULTS .....</b>	<b>46</b>
4.5.1	SAR Test Reduction Considerations .....	46
4.5.2	SAR Results for Head Exposure Condition .....	48
4.5.3	SAR Results for Body-worn Exposure Condition (Separation Distance is 1.0 cm) .....	51
4.5.4	SAR Results for Hotspot Exposure Condition (Separation Distance is 1.0 cm) .....	52
<b>4.6</b>	<b>SAR MEASUREMENT VARIABILITY .....</b>	<b>54</b>
4.6.1	Repeated Measurement .....	54
<b>4.7</b>	<b>SIMULTANEOUS MULTI-BAND TRANSMISSION EVALUATION .....</b>	<b>55</b>
4.7.1	Simultaneous Transmission SAR Test Exclusion Considerations .....	55
4.7.2	Simultaneous Transmission Possibilities .....	56
4.7.3	Max. Standalone SAR .....	57
4.7.4	Sum of SAR .....	58
4.7.5	SAR to Peak Location Separation Ratio Analysis .....	59

- Appendix A. SAR Plots of System Verification**
- Appendix B. SAR Plots of SAR Measurement**
- Appendix C. Calibration Certificate for Probe and Dipole**
- Appendix D. Photographs of EUT and Setup**

# 1 General Information

## 1.1 Statement of Compliance

The maximum results of Specific Absorption Rate (SAR) found during testing for the EUT are as follows:

Equipment Class	Mode	Highest Reported Head SAR <sub>1g</sub> (W/kg)	Highest Reported Body-worn SAR <sub>1g</sub> (1.0 cm Gap) (W/kg)	Highest Reported Hotspot SAR <sub>1g</sub> (1.0 cm Gap) (W/kg)
PCE	GSM850	0.68	1.12	1.12
	GSM1900	0.19	0.44	0.44
	WCDMA II	0.18	0.51	0.51
	WCDMA IV	0.18	0.47	0.47
	WCDMA V	0.50	0.66	0.66
	LTE 2	0.17	0.49	0.56
	LTE 4	0.22	0.55	0.72
	LTE 5	0.43	0.58	0.58
	LTE 12	0.15	0.20	0.20
DTS	LTE 17	N/A	N/A	N/A
	2.4G WLAN	0.63	0.19	0.19
NII	5.2G WLAN	0.07	0.08	N/A
	5.3G WLAN	N/A	N/A	N/A
	5.6G WLAN	0.28	0.05	N/A
	5.8G WLAN	1.05	0.18	N/A
DSS	Bluetooth	N/A	N/A	N/A
Highest Simultaneous Transmission SAR		Head (W/kg)	Body-worn (W/kg)	Hotspot (W/kg)
PCE + DTS		1.31	1.31	1.31
PCE + NII		1.52	1.21	N/A
PCE + DSS		0.80	1.18	N/A

## 1.2 EUT Description

### 1.2.1 General Description

<b>Product Name</b>	Mobile Phone
<b>Trade mark</b>	N/A
<b>Model No.(EUT)</b>	FLAME X555
<b>FCC ID</b>	2AIMEX555
<b>Device Dimension</b>	Overall Diagonal: 148mm Display Diagonal: 126mm
<b>IMEI Code</b>	354707100011529
<b>Tx Frequency Bands (Unit: MHz)</b>	<p>GSM850: 824.2 ~ 848.8  GSM1900: 1850.2 ~ 1909.8  WCDMA Band II: 1852.4 ~ 1907.6  WCDMA Band IV: 1712.4 ~ 1752.6  WCDMA Band V: 826.4 ~ 846.6  LTE Band 2: 1850.7 ~ 1909.3 (1.4M), 1851.5 ~ 1908.5 (3M), 1852.5 ~ 1907.5 (5M), 1855 ~ 1905 (10M), 1857.5 ~ 1902.5 (15M), 1860 ~ 1900 (20M)  LTE Band 4: 1710.7 ~ 1754.3 (1.4M), 1711.5 ~ 1753.5 (3M), 1712.5 ~ 1752.5 (5M), 1715 ~ 1750 (10M), 1717.5 ~ 1747.5 (15M), 1720 ~ 1745 (20M)  LTE Band 5: 824.7 ~ 848.3 (1.4M), 825.5 ~ 847.5 (3M), 826.5 ~ 846.5 (5M), 829 ~ 844 (10M)  LTE Band 12: 699.7 ~ 715.3 (1.4M), 700.5 ~ 714.5 (3M), 701.5 ~ 713.5 (5M), 704 ~ 711 (10M)  LTE Band 17: 706.5 ~ 713.5 (5M), 709 ~ 711 (10M)  WLAN: 2412 ~ 2462, 5180 ~ 5240, 5260 ~ 5320, 5500 ~ 5700, 5745 ~ 5825  Bluetooth: 2402 ~ 2480</p>
	<p>Note:  According to 201504 FCC TCB workshop RF exposure slides, for overlapping bands, only larger band was tested.</p> <ol style="list-style-type: none"> <li>1. The maximum output power, including tolerance, for the smaller band is = the larger band to qualify for the SAR test exclusion.</li> <li>2. The channel bandwidth and other operating parameters for the smaller band is fully supported by the larger band.</li> <li>3. Band 12 (699 – 716 MHz) SAR can support band 17 (704 – 716 MHz).</li> </ol>
<b>Device Class</b>	B
<b>Antenna Type</b>	FPC Antenna
<b>EUT Stage</b>	Identical Prototype

### 1.2.2 Wireless Technologies

<b>GSM</b>	Voice GPRS (Multi-Slot Class: 12-4UP) EDGE (Multi-Slot Class: 12-4UP)
<b>WCDMA</b>	RMC HSDPA HSUPA
<b>LTE</b>	QPSK 16QAM
<b>2.4G WLAN</b>	802.11b 802.11g 802.11n (HT20/HT40)
<b>5G WLAN</b>	802.11a 802.11n (HT20/HT40)
<b>Bluetooth</b>	BR+EDR LE
<b>Wireless Router (Hotspot)</b>	2.4G WLAN: Support 5.2G WLAN: Not Support 5.3G WLAN: Not Support 5.6G WLAN: Not Support 5.8G WLAN: Not Support
<b>VOIP</b>	Support Note: Since this device supports VOIP capability through 3rd party apps software, we have evaluated data mode for head and body-worn SAR.

### 1.2.3 List of Accessory

<b>Battery</b>	<b>Brand Name</b>	N/A
	<b>Model Name</b>	BPX555
	<b>Power Rating</b>	3.8Vdc, 2000mAh
	<b>Type</b>	Li-ion

### 1.3 Maximum Conducted Power

The maximum conducted average power (Unit: dBm) including tune-up tolerance is shown as below.

Mode	GSM850	GSM1900
GSM (GMSK, 1Tx-slot)	33.5	30.5
GPRS (GMSK, 1Tx-slot)	33.5	30.5
GPRS (GMSK, 2Tx-slot)	33.0	29.5
GPRS (GMSK, 3Tx-slot)	31.0	27.0
GPRS (GMSK, 4Tx-slot)	29.5	26.0
EDGE (8PSK, 1Tx-slot)	27.5	27.5
EDGE (8PSK, 2Tx-slot)	26.5	26.5
EDGE (8PSK, 3Tx-slot)	25.0	25.0
EDGE (8PSK, 4Tx-slot)	24.0	24.0

Mode	WCDMA Band II	WCDMA Band IV	WCDMA Band V
RMC 12.2K	23.5	24.0	24.5
HSDPA Subtest-1	22.5	22.5	23.5
HSDPA Subtest-2	22.5	22.5	23.5
HSDPA Subtest-3	22.0	22.0	23.0
HSDPA Subtest-4	22.0	22.0	23.0
HSUPA Subtest-1	20.0	20.5	21.5
HSUPA Subtest-2	20.0	20.5	21.5
HSUPA Subtest-3	21.0	21.5	22.5
HSUPA Subtest-4	20.0	20.0	21.0
HSUPA Subtest-5	22.0	22.0	23.0

Band	Mode	Maximum Conducted Power (Unit: dBm)
LTE 2	QPSK / 16QAM	23.0
LTE 4	QPSK / 16QAM	22.5
LTE 5	QPSK / 16QAM	23.0
LTE 12	QPSK / 16QAM	23.0
LTE 17	QPSK / 16QAM	23.0

Mode	2.4G WLAN
802.11b	15.0
802.11g	12.5
802.11n HT20	12.5
802.11n HT40	12.0

Mode	5.2G WLAN	5.3G WLAN	5.6G WLAN	5.8G WLAN
802.11a	13.0	12.0	11.5	12.0
802.11n HT20	13.0	11.5	11.5	11.5
802.11n HT40	12.0	9.5	10.0	10.5

Mode		2.4G Bluetooth
BR + EDR	GFSK	4.5
	$\pi/4$ -DQPSK	1.5
	8-DPSK	1.5
LE	GFSK	3.5

#### Shenzhen UnionTrust Quality and Technology Co., Ltd.



### 1.4 Other Information

Sample Received Date:	Jan. 04, 2019
Sample tested Date:	Jan. 07, 2019 ~ Jan. 21, 2019

### 1.5 Testing Location

Shenzhen UnionTrust Quality and Technology Co., Ltd.	
Address: Address: 16/F, Block A, Building 6, Baoneng Science and Technology Park, Qingxiang Road No.1, Longhua New District, Shenzhen, China	
Telephone: +86-755-28230888	Fax: +86-755-28230886
Mail: <a href="mailto:info@uttlab.com">info@uttlab.com</a>	Website: <a href="http://www.uttlab.com">Http://www.uttlab.com</a>

### 1.6 Test Facility

The test facility is recognized, certified, or accredited by the following organizations:

**CNAS-Lab Code: L9069**

The measuring equipment utilized to perform the tests documented in this report has been calibrated once a year or in accordance with the manufacturer's recommendations, and is traceable under the ISO/IEC/EN 17025 to international or national standards. Equipment has been calibrated by accredited calibration laboratories.

**IC-Registration No.: 21600-1**

The 3m Semi-anechoic chamber of Shenzhen UnionTrust Quality and Technology Co., Ltd. has been registered by Certification and Engineering Bureau of Industry Canada for radio equipment testing with Registration No.: 21600-1.

**A2LA-Lab Certificate No.: 4312.01**

Shenzhen UnionTrust Quality and Technology Co., Ltd. has been accredited by A2LA for technical competence in the field of electrical testing, and proved to be in compliance with ISO/IEC 17025: 2005 General Requirements for the Competence of Testing and Calibration Laboratories and any additional program requirements in the identified field of testing.

**FCC Accredited Lab.**

**Designation Number: CN1194**

**Test Firm Registration Number: 259480**

**Shenzhen UnionTrust Quality and Technology Co., Ltd.**

Address: 16/F, Block A, Building 6, Baoneng Science and Technology Park, Qingxiang Road No.1, Longhua New District, Shenzhen, China  
 Tel: +86-755-28230888      Fax: +86-755-28230886      E-mail: [info@uttlab.com](mailto:info@uttlab.com)      [Http://www.uttlab.com](http://www.uttlab.com)

## 1.7 Guidance Standard

The tests documented in this report were performed in accordance with FCC 47 CFR Part 2 §2.1093, IEEE Std 1528-2013, ANSI/IEEE C95.1-1992, the following FCC Published RF exposure KDB procedures:

KDB 865664 D01 v01r04

KDB 865664 D02 v01r02

KDB 248227 D01 v02r02

KDB 447498 D01 v06

KDB 648474 D04 v01r03

KDB 941225 D01 v03r01

KDB 941225 D05 v02r05

KDB 941225 D06 v02r01

The equipment have been tested by **Shenzhen UnionTrust Quality and Technology Co., Ltd.**, and found compliance with the requirement of the above standards.

## 2 Specific Absorption Rate (SAR)

### 2.1 Introduction

SAR is related to the rate at which energy is absorbed per unit mass in an object exposed to a radio field. The SAR distribution in a biological body is complicated and is usually carried out by experimental techniques or numerical modeling, by appropriate techniques, to produce specific absorption rates (SARs) as averaged over the whole-body, any 1 g or any 10 g of tissue (defined as a tissue volume in the shape of a cube). All SAR values are to be averaged over any six-minute period. When portable device was used within 20 cm of the user’s body, SAR evaluation of the device will be required. The SAR limit in chapter 2.3.

### 2.2 SAR Definition

The SAR definition is the time derivative (rate) of the incremental energy (dW) absorbed by (dissipated in) an incremental mass (dm) contained in a volume element (dv) of a given density (ρ). The equation description is as below:

$$SAR = \frac{d}{dt} \left( \frac{dW}{dm} \right) = \frac{d}{dt} \left( \frac{dW}{\rho dv} \right)$$

SAR is expressed in units of Watts per kilogram (W/kg)

SAR measurement can be related to the electrical field in the tissue by

$$SAR = \frac{\sigma |E|^2}{\rho}$$

Where: σ is the conductivity of the tissue, ρ is the mass density of the tissue and E is the RMS electrical field strength.

### 2.3 SAR Limits

(A) Limits for Occupational/Controlled Exposure (W/kg)

Whole-Body	Partial-Body	Hands, Wrists, Feet and Ankles
0.4	8.0	20.0

(B) Limits for General Population/Uncontrolled Exposure (W/kg)

Whole-Body	Partial-Body	Hands, Wrists, Feet and Ankles
0.08	1.6	4.0

**Note:**

1. Whole-Body SAR is averaged over the entire body, partial-body SAR is averaged over any 1 gram of tissue defined as a tissue volume in the shape of a cube. SAR for hands, wrists, feet and ankles is averaged over any 10 grams of tissue defined as a tissue volume in the shape of a cube.
2. At frequencies above 6.0 GHz, SAR limits are not applicable and MPE limits for power density should be applied at 5 cm or more from the transmitting device.
3. The SAR limit is specified in FCC 47 CFR Part 2 §2.1093, ANSI/IEEE C95.1-1992.

**Shenzhen UnionTrust Quality and Technology Co., Ltd.**

## 3 SAR Measurement System

### 3.1 SPEAG DASY System

DASY system consists of high precision robot, probe alignment sensor, phantom, robot controller, controlled measurement server and near-field probe. The robot includes six axes that can move to the precision position of the DASY5 software defined. The DASY software can define the area that is detected by the probe. The robot is connected to controlled box. Controlled measurement server is connected to the controlled robot box. The DAE includes amplifier, signal multiplexing, AD converter, offset measurement and surface detection. It is connected to the Electro-optical coupler (ECO). The ECO performs the conversion from the optical into digital electric signal of the DAE and transfers data to the PC.

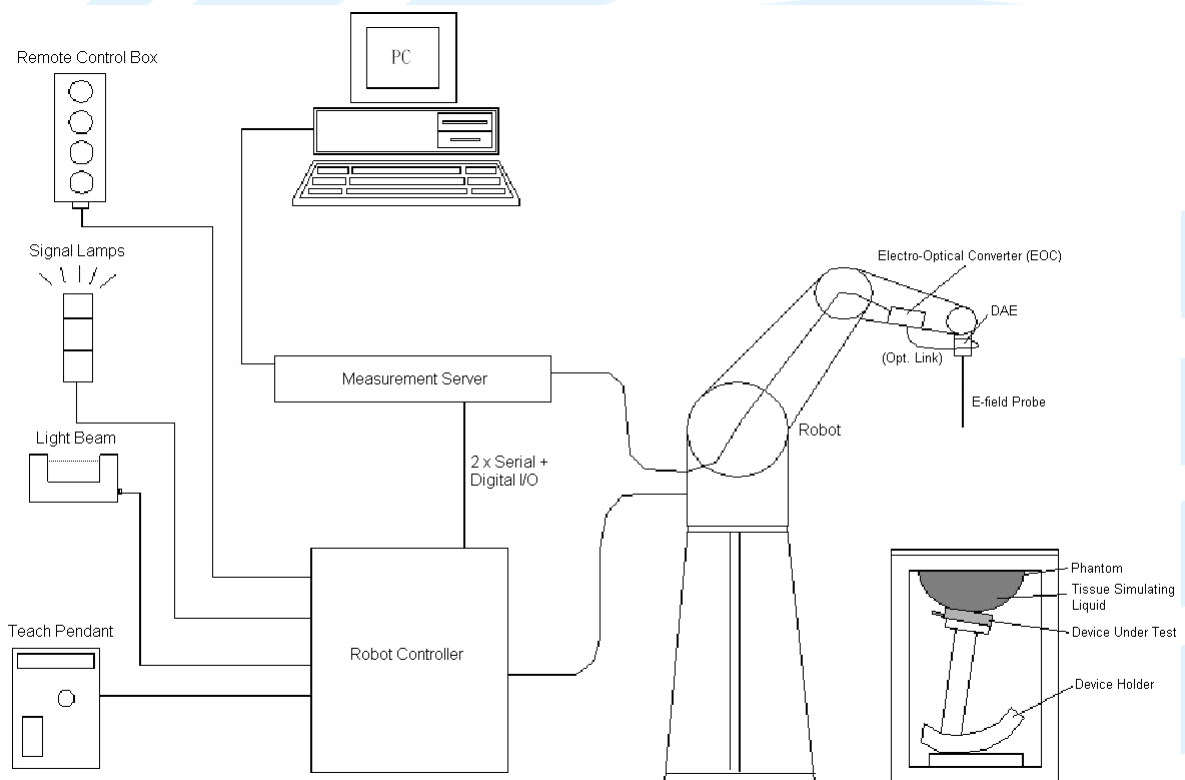

DASY Measurement System

#### 3.1.1 Robot

The DASY system uses the high precision robots from Stäubli SA (France). For the 6-axis controller system, the robot controller version (DASY4: CS7MB) from Stäubli is used. The Stäubli robot series have many features that are important for our application:

- High precision (repeatability  $\pm 0.02$  mm)
- High reliability (industrial design)
- Jerk-free straight movements
- Low ELF interference (the closed metallic construction shields against motor control fields)

### **Shenzhen UnionTrust Quality and Technology Co., Ltd.**

Address: 16/F, Block A, Building 6, Baoneng Science and Technology Park, Qingxiang Road No.1, Longhua New District, Shenzhen, China  
Tel: +86-755-28230888 Fax: +86-755-28230886 E-mail: info@uttlab.com [Http://www.uttlab.com](http://www.uttlab.com)

### 3.1.2 Probe

The SAR measurement is conducted with the dosimetric probe. The probe is specially designed and calibrated for use in liquid with high permittivity. The dosimetric probe has special calibration in liquid at different frequency.

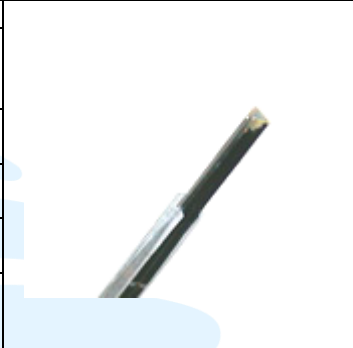
<b>Model</b>	EX3DV4	
<b>Construction</b>	Symmetrical design with triangular core. Built-in shielding against static charges. PEEK enclosure material (resistant to organic solvents, e.g., DGBE).	
<b>Frequency</b>	10 MHz to 6 GHz Linearity: $\pm 0.2$ dB	
<b>Directivity</b>	$\pm 0.3$ dB in HSL (rotation around probe axis) $\pm 0.5$ dB in tissue material (rotation normal to probe axis)	
<b>Dynamic Range</b>	10 $\mu$ W/g to 100 mW/g Linearity: $\pm 0.2$ dB (noise: typically $< 1$ $\mu$ W/g)	
<b>Dimensions</b>	Overall length: 337 mm (Tip: 20 mm) Tip diameter: 2.5 mm (Body: 12 mm) Typical distance from probe tip to dipole centers: 1 mm	

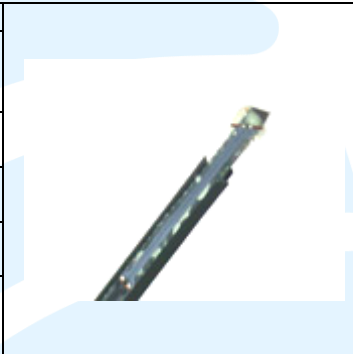
<b>Model</b>	ES3DV3	
<b>Construction</b>	Symmetrical design with triangular core. Interleaved sensors. Built-in shielding against static charges. PEEK enclosure material (resistant to organic solvents, e.g., DGBE).	
<b>Frequency</b>	10 MHz to 4 GHz Linearity: $\pm 0.2$ dB	
<b>Directivity</b>	$\pm 0.2$ dB in HSL (rotation around probe axis) $\pm 0.3$ dB in tissue material (rotation normal to probe axis)	
<b>Dynamic Range</b>	5 $\mu$ W/g to 100 mW/g Linearity: $\pm 0.2$ dB	
<b>Dimensions</b>	Overall length: 337 mm (Tip: 20 mm) Tip diameter: 3.9 mm (Body: 12 mm) Distance from probe tip to dipole centers: 2.0 mm	

### 3.1.3 Data Acquisition Electronics (DAE)

<b>Model</b>	DAE3, DAE4	
<b>Construction</b>	Signal amplifier, multiplexer, A/D converter and control logic. Serial optical link for communication with DASY embedded system (fully remote controlled). Two step probe touch detector for mechanical surface detection and emergency robot stop.	
<b>Measurement Range</b>	-100 to +300 mV (16 bit resolution and two range settings: 4mV, 400mV)	
<b>Input Offset Voltage</b>	$< 5\mu$ V (with auto zero)	
<b>Input Bias Current</b>	$< 50$ fA	
<b>Dimensions</b>	60 x 60 x 68 mm	

### 3.1.4 Phantom

<b>Model</b>	Twin SAM	
<b>Construction</b>	The shell corresponds to the specifications of the Specific Anthropomorphic Mannequin (SAM) phantom defined in IEEE 1528 and IEC 62209-1. It enables the dosimetric evaluation of left and right hand phone usage as well as body mounted usage at the flat phantom region. A cover prevents evaporation of the liquid. Reference markings on the phantom allow the complete setup of all predefined phantom positions and measurement grids by teaching three points with the robot.	
<b>Material</b>	Vinylester, glass fiber reinforced (VE-GF)	
<b>Shell Thickness</b>	$2 \pm 0.2$ mm ( $6 \pm 0.2$ mm at ear point)	
<b>Dimensions</b>	Length: 1000 mm Width: 500 mm Height: adjustable feet	
<b>Filling Volume</b>	approx. 25 liters	

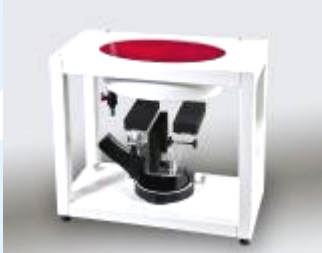
<b>Model</b>	ELI	
<b>Construction</b>	Phantom for compliance testing of handheld and body-mounted wireless devices in the frequency range of 30 MHz to 6 GHz. ELI is fully compatible with the IEC 62209-2 standard and all known tissue simulating liquids. ELI has been optimized regarding its performance and can be integrated into our standard phantom tables. A cover prevents evaporation of the liquid. Reference markings on the phantom allow installation of the complete setup, including all predefined phantom positions and measurement grids, by teaching three points. The phantom is compatible with all SPEAG dosimetric probes and dipoles.	
<b>Material</b>	Vinylester, glass fiber reinforced (VE-GF)	
<b>Shell Thickness</b>	$2.0 \pm 0.2$ mm (bottom plate)	
<b>Dimensions</b>	Major axis: 600 mm Minor axis: 400 mm	
<b>Filling Volume</b>	approx. 30 liters	

### 3.1.5 Device Holder

<b>Model</b>	Mounting Device	
<b>Construction</b>	In combination with the Twin SAM Phantom or ELI4, the Mounting Device enables the rotation of the mounted transmitter device in spherical coordinates. Rotation point is the ear opening point. Transmitter devices can be easily and accurately positioned according to IEC, IEEE, FCC or other specifications. The device holder can be locked for positioning at different phantom sections (left head, right head, flat).	
<b>Material</b>	POM	

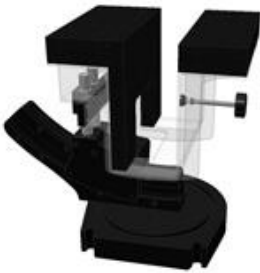
<b>Model</b>	Laptop Extensions Kit	
<b>Construction</b>	Simple but effective and easy-to-use extension for Mounting Device that facilitates the testing of larger devices according to IEC 62209-2 (e.g., laptops, cameras, etc.). It is lightweight and fits easily on the upper part of the Mounting Device in place of the phone positioner.	
<b>Material</b>	POM, Acrylic glass, Foam	

### 3.1.6 System Validation Dipoles

<b>Model</b>	D-Serial	
<b>Construction</b>	Symmetrical dipole with 1/4 balun. Enables measurement of feed point impedance with NWA. Matched for use near flat phantoms filled with tissue simulating solutions.	
<b>Frequency</b>	750 MHz to 5800 MHz	
<b>Return Loss</b>	> 20 dB	
<b>Power Capability</b>	> 100 W (f < 1GHz), > 40 W (f > 1GHz)	

### 3.2 SAR Scan Procedure

#### 3.2.1 SAR Reference Measurement (drift)

Prior to the SAR test, local SAR shall be measured at a stationary reference point where the SAR exceeds the lower detection limit of the measurement system.

#### 3.2.2 Area Scan

Measurement procedures for evaluating the SAR of wireless device start with a coarse measurement grid to determine the approximate location of the local peak SAR values. This is known as the area-scan procedure. All antennas and radiating structures that may contribute to the measured SAR or influence the SAR distribution must be included in the area scan. The area scan measurement resolution must enable the extrapolation algorithms of the SAR system to correctly identify the peak SAR location(s) for subsequent zoom scan measurements to correctly determine the 1-g SAR. Area scans are performed at a constant distance from the phantom surface, determined by the measurement frequencies. When a measured peak is closer than 1/2 the zoom scan volume dimension (x, y) from the edge of the area scan region, unless the entire peak and gram-averaging volume are both captured within the zoom scan volume, the area scan must be repeated by shifting and expanding the area scan region to ensure all peaks are away from the area scan boundary. The area scan resolutions specified in the table below must be applied to the SAR measurements.

	≤ 3 GHz	> 3 GHz
Maximum distance from closest measurement point (geometric center of probe sensors) to phantom surface	5 mm ± 1 mm	1/2 · δ · ln(2) mm ± 0.5 mm
Maximum probe angle from probe axis to phantom surface normal at the measurement location	30° ± 1°	20° ± 1°
Maximum area scan spatial resolution: Δx <sub>Area</sub> , Δy <sub>Area</sub>	≤ 2 GHz: ≤ 15 mm 2 – 3 GHz: ≤ 12 mm	3 – 4 GHz: ≤ 12 mm 4 – 6 GHz: ≤ 10 mm
	When the x or y dimension of the test device, in the measurement plane orientation, is smaller than the above, the measurement resolution must be ≤ the corresponding x or y dimension of the test device with at least one measurement point on the test device.	

#### 3.2.3 Zoom Scan

To evaluate the peak spatial-average SAR values with respect to 1 g or 10 g cubes, fine resolution volume scans, called zoom scans, are performed at the peak SAR locations identified during the area scan. If the cube volume within the zoom scan chosen to calculate the peak spatial-average SAR touches any boundary of the zoom-scan volume, the zoom scan shall be repeated with the center of the zoom-scan volume shifted to the new maximum SAR location. For any secondary peaks found in the area scan that are within 2 dB of the maximum peak and are not within this zoom scan, the zoom scan shall be performed for such peaks, unless the peak spatial-average SAR at the location of the maximum peak is more than 2 dB below the applicable SAR limit (i.e., 1 W/kg for a 1.6 W/kg 1 g limit, or 1.26 W/kg for a 2 W/kg 10 g limit). The zoom scan resolutions specified in the table below must be applied to the SAR measurements.

**Shenzhen UnionTrust Quality and Technology Co., Ltd.**



		≤ 3 GHz	> 3 GHz	
Maximum zoom scan spatial resolution: $\Delta x_{Zoom}, \Delta y_{Zoom}$		≤ 2 GHz: ≤ 8 mm 2 – 3 GHz: ≤ 5 mm*	3 – 4 GHz: ≤ 5 mm* 4 – 6 GHz: ≤ 4 mm*	
Maximum zoom Scan spatial resolution, normal to phantom surface	uniform grid: $\Delta Z_{Zoom}(n)$	≤ 5 mm	3 – 4 GHz: ≤ 4 mm 4 – 5 GHz: ≤ 3 mm 5 – 6 GHz: ≤ 2 mm	
	graded grid	$\Delta Z_{Zoom}(1)$ : between 1 <sup>ST</sup> two points closest to phantom surface	≤ 4 mm	3 – 4 GHz: ≤ 3 mm 4 – 5 GHz: ≤ 2.5 mm 5 – 6 GHz: ≤ 2 mm
		$\Delta Z_{Zoom}(n>1)$ : between subsequent points	≤ 1.5 · $\Delta Z_{Zoom}(n-1)$ mm	
Minimum zoom scan volume	x, y, z	≥ 30 mm	3 – 4 GHz: ≥ 28 mm 4 – 5 GHz: ≥ 25 mm 5 – 6 GHz: ≥ 22 mm	
Note: $\delta$ is the penetration depth of a plane-wave at normal incidence to the tissue medium; see IEEE Std 1528-2013 for details. * When zoom scan is required and the reported SAR from the area scan based 1-g SAR estimation procedures of KDB Publication 447498 is ≤ 1.4 W/kg, ≤ 8 mm, ≤ 7 mm and ≤ 5 mm zoom scan resolution may be applied, respectively, for 2 GHz to 3 GHz, 3 GHz to 4 GHz and 4 GHz to 6 GHz.				

### 3.2.4 SAR Drift Measurement

The local SAR (or conducted power) shall be measured at exactly the same location as in 3.2.1 section. The absolute value of the measurement drift (the difference between the SAR measured in 3.2.1 and 3.2.4 section) shall be recorded. The SAR drift shall be kept within ± 5%.

### 3.3 Test Equipment

Equipment	Manufacturer	Model	SN	Cal. Date	Cal. Interval
System Validation Dipole	SPEAG	D750V3	1048	Jul. 06, 2016	3 Year
System Validation Dipole	SPEAG	D835V2	4d005	May. 18, 2018	3 Year
System Validation Dipole	SPEAG	D1800V2	2d140	May. 18, 2018	3 Year
System Validation Dipole	SPEAG	D1900V2	509	May. 18, 2018	3 Year
System Validation Dipole	SPEAG	D2450V2	883	Jul. 05, 2016	3 Year
System Validation Dipole	SPEAG	D5GHzV2	1280	Jun. 05, 2018	3 Year
Dosimetric E-Field Probe	SPEAG	EX3DV4	7506	Jun. 22, 2018	1 Year
Dosimetric E-Field Probe	SPEAG	ES3DV3	3090	Apr. 03, 2018	1 Year
Data Acquisition Electronics	SPEAG	DAE4	662	May. 11, 2018	1 Year
Data Acquisition Electronics	SPEAG	DAE4	1557	Jun. 05, 2018	1 Year
Wideband Radio Communication Tester	R&S	CMW500	116254	Jun. 08, 2018	1 Year
ENA Series Network Analyzer	Agilent	8753ES	MY40000519	Apr. 14, 2018	1 Year
Dielectric Assessment Kit	SPEAG	DAK-3.5	1056	N/A	N/A
USB/GPIB Interface	Agilent	82357B	N10149	N/A	N/A
EXG-B RF Analog Signal Generator	KEYSIGHT	N5171B	MY53051777	Nov. 24, 2018	1 Year
USB Wideband Power Sensor	KEYSIGHT	U2021XA	MY55430035	Nov. 24, 2018	1 Year
USB Wideband Power Sensor	KEYSIGHT	U2021XA	MY55430023	Nov. 24, 2018	1 Year
Thermometer	Shanghai Gao Zhi Precision Instrument Co., Ltd.	HB6801	120100323	Mar. 29, 2018	1 Year
Coupler	REBES	TC-05180-10 S	161221001	N/A	1 Year
Amplifier	Mini-Circuit	ZHL42	QA1252001	N/A	N/A
DC Source	Agilent	66319B	MY43000795	N/A	N/A

### 3.4 Measurement Uncertainty

Per KDB 865664 D01 SAR Measurement 100 MHz to 6 GHz, when the highest measured 1-g SAR within a frequency band is  $< 1.5$  W/kg, the extensive SAR measurement uncertainty analysis described in IEEE Std 1528-2013 is not required in SAR reports submitted for equipment approval.



### 3.5 Tissue Dielectric Parameter Measurement & System Verification

#### 3.5.1 Tissue Simulating Liquids

The temperature of the tissue-equivalent medium used during measurement must also be within 18 °C to 25 °C and within ± 2 °C of the temperature when the tissue parameters are characterized. The dielectric parameters must be measured before the tissue-equivalent medium is used in a series of SAR measurements. The parameters should be re-measured after each 3 - 4 days of use; or earlier if the dielectric parameters can become out of tolerance.

The depth of tissue-equivalent liquid in a phantom must be ≥ 15.0 cm with ≤ ± 0.5 cm variation for SAR measurements ≤ 3 GHz and ≥ 10.0 cm with ≤ ± 0.5 cm variation for measurements > 3 GHz. The nominal dielectric values of the tissue simulating liquids in the phantom and the tolerance of 5% are listed in Table-3.1.



Photo of Liquid Height

Table-3.1 Tissue Dielectric Parameters for Head and Body

Target Frequency (MHz)	Head		Body	
	$\epsilon_r$	$\sigma$ (S/m)	$\epsilon_r$	$\sigma$ (S/m)
750	41.9	0.89	55.5	0.96
835	41.5	0.90	55.2	0.97
900	41.5	0.97	55.0	1.05
1450	40.5	1.20	54.0	1.30
1640	40.3	1.29	53.8	1.40
1750	40.1	1.37	53.4	1.49
1800	40.0	1.40	53.3	1.52
1900	40.0	1.40	53.3	1.52
2000	40.0	1.40	53.3	1.52
2300	39.5	1.67	52.9	1.81
2450	39.2	1.80	52.7	1.95
2600	39.0	1.96	52.5	2.16
3500	37.9	2.91	51.3	3.31
5200	36.0	4.66	49.0	5.30
5300	35.9	4.76	48.9	5.42
5500	35.6	4.96	48.6	5.65
5600	35.5	5.07	48.5	5.77
5800	35.3	5.27	48.2	6.00

( $\epsilon_r$  = relative permittivity,  $\sigma$  = conductivity and  $\rho = 1000 \text{ kg/m}^3$ )

The following table gives the recipes for tissue simulating liquids.

Table-3.2 Recipes of Tissue Simulating Liquid

Tissue Type	Bactericide	DGBE	HEC	NaCl	Sucrose	Triton X-100	Water	Diethylene Glycol Mono-hexylether
H750	0.2	-	0.2	1.4	57.0	-	41.1	-
H835	0.1	-	1.0	1.4	57.0	-	40.5	-
H900	0.1	-	1.0	1.5	56.5	-	40.9	-
H1450	-	45.5	-	0.7	-	-	53.8	-
H1640	-	45.8	-	0.5	-	-	53.7	-
H1750	-	44.5	-	0.3	-	-	55.2	-
H1800	-	44.9	-	0.2	-	-	54.9	-
H1900	-	44.9	-	0.2	-	-	54.9	-
H2000	-	50	-	-	-	-	50	-
H2300	-	44.9	-	0.1	-	-	55.0	-
H2450	-	45.0	-	0.1	-	-	54.9	-
H2600	-	45.1	-	0.1	-	-	54.8	-
H3500	-	8.0	-	0.2	-	20.0	71.8	-
H5G	-	-	-	-	-	17.2	65.52	17.3
B750	0.2	-	0.2	0.8	48.8	-	50.0	-
B835	0.2	-	0.2	0.9	48.5	-	50.2	-
B900	0.2	-	0.2	0.9	48.2	-	50.5	-
B1450	-	34.0	-	0.3	-	-	65.7	-
B1640	-	32.5	-	0.3	-	-	67.2	-
B1750	-	29.4	-	0.4	-	-	70.2	-
B1800	-	29.5	-	0.4	-	-	70.1	-
B1900	-	29.5	-	0.3	-	-	70.2	-
B2000	-	30.0	-	0.2	-	-	69.8	-
B2300	-	31.0	-	0.1	-	-	68.9	-
B2450	-	31.4	-	0.1	-	-	68.5	-
B2600	-	31.8	-	0.1	-	-	68.1	-
B3500	-	28.8	-	0.1	-	-	71.1	-
B5G	-	-	-	-	-	10.7	78.6	10.7

### 3.5.2 System Check Description

The system check procedure provides a simple, fast, and reliable test method that can be performed daily or before every SAR measurement. The objective here is to ascertain that the measurement system has acceptable accuracy and repeatability. This test requires a flat phantom and a radiating source. The system verification setup is shown as below.

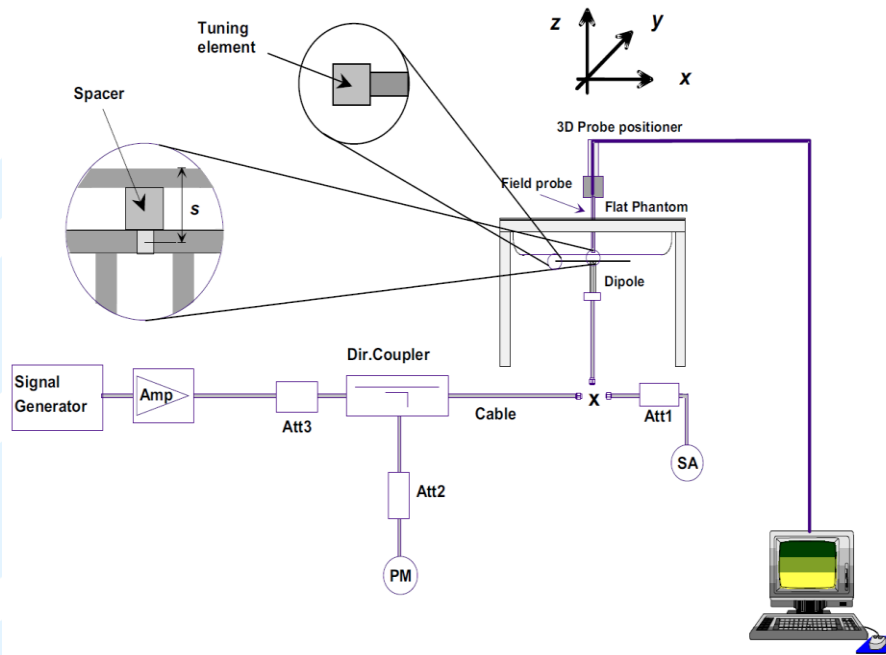

System Verification Setup

### 3.5.3 Tissue Verification

The measuring results for tissue simulating liquid are shown as below.

Test Date	Tissue Type	Frequency (MHz)	Liquid Temp. (°C)	Measured Conductivity ( $\sigma$ )	Measured Permittivity ( $\epsilon_r$ )	Target Conductivity ( $\sigma$ )	Target Permittivity ( $\epsilon_r$ )	Conductivity Deviation (%)	Permittivity Deviation (%)
Jan. 11, 2019	Head	750	21.5	0.908	40.500	0.89	41.90	2.02	-3.34
Jan. 15, 2019	Head	835	21.6	0.890	42.400	0.90	41.50	-1.11	2.17
Jan. 10, 2019	Head	1800	21.4	1.430	39.200	1.37	40.10	4.38	-2.24
Jan. 16, 2019	Head	1900	21.6	1.450	41.400	1.40	40.00	3.57	3.50
Jan. 16, 2019	Head	2450	21.6	1.780	40.200	1.80	39.20	-1.11	2.55
Jan. 21, 2019	Head	5200	21.5	4.688	36.999	4.66	36.00	0.60	2.78
Jan. 21, 2019	Head	5600	21.5	5.189	36.130	5.07	35.50	2.35	1.77
Jan. 21, 2019	Head	5800	21.5	5.421	35.684	5.27	35.30	2.87	1.09
Jan. 08, 2019	Body	750	21.4	0.967	55.300	0.96	55.50	0.73	-0.36
Jan. 09, 2019	Body	835	21.5	0.993	57.100	0.97	55.20	2.37	3.44
Jan. 07, 2019	Body	1800	21.6	1.540	54.900	1.49	53.40	3.36	2.81
Jan. 07, 2019	Body	1900	21.6	1.550	52.600	1.52	53.30	1.97	-1.31
Jan. 16, 2019	Body	2450	21.6	2.020	52.900	1.95	52.70	3.59	0.38
Jan. 20, 2019	Body	5200	21.5	5.480	48.358	5.30	49.00	3.40	-1.31
Jan. 20, 2019	Body	5600	21.5	6.011	47.673	5.77	48.50	4.18	-1.71
Jan. 20, 2019	Body	5800	21.5	6.287	47.348	6.00	48.20	4.78	-1.77

**Note:**

The dielectric properties of the tissue simulating liquid must be measured within 24 hours before the SAR testing and within  $\pm 5\%$  of the target values. The variation of the liquid temperature must be within  $\pm 2\text{ }^\circ\text{C}$  during the test.

### 3.5.4 System Verification

The measuring result for system verification is tabulated as below.

Test Date	Tissue Type	Frequency (MHz)	1W Target SAR-1g (W/kg)	Measured SAR-1g (W/kg)	Normalized to 1W SAR-1g (W/kg)	Deviation (%)	Dipole S/N	Probe S/N	DAE S/N
Jan. 11, 2019	Head	750	8.34	0.851	8.51	2.04	1048	3090	662
Jan. 15, 2019	Head	835	9.45	0.953	9.53	0.85	4d005	3090	662
Jan. 10, 2019	Head	1800	39.20	4.080	40.80	4.08	2d140	3090	662
Jan. 16, 2019	Head	1900	39.60	3.950	39.50	-0.25	509	3090	662
Jan. 16, 2019	Head	2450	52.40	5.570	55.70	6.30	883	3090	662
Jan. 21, 2019	Head	5200	78.70	8.240	82.40	4.70	1280	7506	1557
Jan. 21, 2019	Head	5600	84.40	8.760	87.60	3.79	1280	7506	1557
Jan. 21, 2019	Head	5800	80.00	8.320	83.20	4.00	1280	7506	1557
Jan. 08, 2019	Body	750	8.72	0.867	8.67	-0.57	1048	3090	662
Jan. 09, 2019	Body	835	9.74	0.948	9.48	-2.67	4d005	3090	662
Jan. 07, 2019	Body	1800	39.00	4.000	40.00	2.56	2d140	3090	662
Jan. 07, 2019	Body	1900	39.50	4.330	43.30	9.62	509	3090	662
Jan. 16, 2019	Body	2450	51.80	5.470	54.70	5.60	883	3090	662
Jan. 20, 2019	Body	5200	74.70	7.660	76.60	2.54	1280	7506	1557
Jan. 20, 2019	Body	5600	79.20	7.850	78.50	-0.88	1280	7506	1557
Jan. 20, 2019	Body	5800	75.00	7.610	76.10	1.47	1280	7506	1557

**Note:**

Comparing to the reference SAR value, the validation data should be within its specification of 10%. The result indicates the system check can meet the variation criterion and the plots can be referred to Appendix A of this report.

**Shenzhen UnionTrust Quality and Technology Co., Ltd.**

## 4 SAR Measurement Evaluation

### 4.1 EUT Configuration and Setting

#### Connections between EUT and System Simulator

For WWAN SAR testing, the EUT was linked and controlled by base station emulator. Communication between the EUT and the emulator was established by air link. The distance between the EUT and the communicating antenna of the emulator is larger than 50 cm and the output power radiated from the emulator antenna is at least 30 dB smaller than the output power of EUT. The EUT was set from the emulator to radiate maximum output power during SAR testing.

#### 4.1.1 GSM Configuration and Testing

GSM (GMSK: CS1) voice mode transmits with 1 time slot. GPRS (GMSK: CS1) and EDGE (GMSK: MCS1, 8PSK: MCS9) may transmit up to 4 time slots in the 8 time-slot frame according to the multislot class implemented in a device.

#### 4.1.2 WCDMA Configuration and Testing

##### WCDMA Handsets Head SAR

SAR for next to the ear head exposure is measured using a 12.2 kbps RMC with TPC bits configured to all "1's". The 3G SAR test reduction procedure is applied to AMR configurations with 12.2 kbps RMC as the primary mode.

##### WCDMA Handsets Body-worn SAR

SAR for body-worn configurations is measured using a 12.2 kbps RMC with TPC bits configured to all "1's". The 3G SAR test reduction procedure is applied to other spreading codes and multiple DPDCH<sub>n</sub> configurations supported by the handset with 12.2 kbps RMC as the primary mode.

##### Handsets with Release 5 HSDPA

The 3G SAR test reduction procedure is applied to HSDPA body-worn configurations with 12.2 kbps RMC as the primary mode. Otherwise, SAR is measured for HSDPA using the HSDPA body SAR procedures in the "Release 5 HSDPA Data Devices", for the highest reported SAR body-worn exposure configuration in 12.2 kbps RMC. Handsets with both HSDPA and HSUPA are tested according to Release 6 HSPA test procedures.

##### Handsets with Release 6 HSUPA

The 3G SAR test reduction procedure is applied to HSPA (HSUPA/HSDPA with RMC) body-worn configurations with 12.2 kbps RMC as the primary mode. Otherwise, SAR is measured for HSPA using the HSPA body SAR procedures in the "Release 6 HSPA Data Devices", for the highest reported body-worn exposure SAR configuration in 12.2 kbps RMC. When VOIP is applicable for next to the ear head exposure in HSPA, the 3G SAR test reduction procedure is applied to HSPA with 12.2 kbps RMC as the primary mode; otherwise, the same HSPA configuration used for body-worn measurements is tested for next to the ear head exposure.

##### Release 5 HSDPA Data Devices

The 3G SAR test reduction procedure is applied to body SAR with 12.2 kbps RMC as the primary mode. Otherwise, body SAR for HSDPA is measured using an FRC with H-Set 1 in Sub-test 1 and a 12.2 kbps RMC configured in Test Loop Mode 1, for the highest reported SAR configuration in 12.2 kbps RMC without HSDPA.

### **Shenzhen UnionTrust Quality and Technology Co., Ltd.**



HSDPA is configured according to the applicable UE category of a test device. The number of HS-DSCH / HS-PDSCHs, HARQ processes, minimum inter-TTI interval, transport block sizes and RV coding sequence are defined by the H-set. To maintain a consistent test configuration and stable transmission conditions, QPSK is used in the H-set for SAR testing. HS-DPCCH should be configured with a CQI feedback cycle of 4 ms and a CQI repetition factor of 2 to maintain a constant rate of active CQI slots. DPCCH and DPDCH gain factors ( $\beta_c$ ,  $\beta_d$ ), and HS-DPCCH power offset parameters ( $\Delta_{ACK}$ ,  $\Delta_{NACK}$ ,  $\Delta_{CQI}$ ) are set according to values indicated in below. The CQI value is determined by the UE category, transport block size, number of HS-PDSCHs and modulation used in the H-set.

Sub-test	$\beta_c$	$\beta_d$	$\beta_d$ (SF)	$\beta_c / \beta_d$	$\beta_{hs}^{(1)}$	CM (dB) <sup>(2)</sup>	MPR
1	2 / 15	15 / 15	64	2 / 15	4 / 15	0.0	0
2	12 / 15 <sup>(3)</sup>	15 / 15 <sup>(3)</sup>	64	12 / 15 <sup>(3)</sup>	24 / 15	1.0	0
3	15 / 15	8 / 15	64	15 / 8	30 / 15	1.5	0.5
4	15 / 15	4 / 15	64	15 / 4	30 / 15	1.5	0.5

Note 1:  $\Delta_{ACK}$ ,  $\Delta_{NACK}$  and  $\Delta_{CQI} = 8 \Leftrightarrow A_{hs} = \beta_{hs} / \beta_c = 30 / 15 \Leftrightarrow \beta_{hs} = 30 / 15 * \beta_c$ .  
 Note 2: CM = 1 for  $\beta_c / \beta_d = 12 / 15$ ,  $\beta_{hs} / \beta_c = 24 / 15$ .  
 Note 3: For subtest 2 the  $\beta_c / \beta_d$  ratio of 12 / 15 for the TFC during the measurement period (TF1, TF0) is achieved by setting the signaled gain factors for the reference TFC (TF1, TF1) to  $\beta_c = 11 / 15$  and  $\beta_d = 15 / 15$ .

**Release 6 HSUPA Data Devices**

The 3G SAR test reduction procedure is applied to body SAR with 12.2 kbps RMC as the primary mode. Otherwise, body SAR for HSPA is measured with E-DCH Sub-test 5, using H-Set 1 and QPSK for FRC and a 12.2 kbps RMC configured in Test Loop Mode 1 and power control algorithm 2, according to the highest reported body SAR configuration in 12.2 kbps RMC without HSPA. When VOIP applies to head exposure, the 3G SAR test reduction procedure is applied with 12.2 kbps RMC as the primary mode. Otherwise, the same HSPA configuration used for body SAR measurements are applied to head exposure testing. Due to inner loop power control requirements in HSPA, a communication test set is required for output power and SAR tests. The 12.2 kbps RMC, FRC H-set 1 and E-DCH configurations for HSPA are configured according to the  $\beta$  values indicated in below.

Sub-test	$\beta_c$	$\beta_d$	$\beta_d$ (SF)	$\beta_c / \beta_d$	$\beta_{hs}^{(1)}$	$\beta_{ec}$	$\beta_{ed}$	$\beta_{ed}$ (SF)	$\beta_{ed}$ (codes)	CM <sup>(2)</sup> (dB)	MPR (dB)	AG <sup>(4)</sup> Index	E-TFCI
1	11 / 15 <sup>(3)</sup>	15 / 15 <sup>(3)</sup>	64	11 / 15 <sup>(3)</sup>	22 / 15	209 / 225	1039 / 225	4	1	1.0	0.0	20	75
2	6 / 15	15 / 15	64	6 / 15	12 / 15	12 / 15	94 / 75	4	1	3.0	2.0	12	67
3	15 / 15	9 / 15	64	15 / 9	30 / 15	30 / 15	$\beta_{ed1}: 47/15$ $\beta_{ed2}: 47/15$	4	2	2.0	1.0	15	92
4	2 / 15	15 / 15	64	2 / 15	4 / 15	2 / 15	56 / 75	4	1	3.0	2.0	17	71
5	15 / 15 <sup>(4)</sup>	15 / 15 <sup>(4)</sup>	64	15 / 15 <sup>(4)</sup>	30 / 15	24 / 15	134 / 15	4	1	1.0	0.0	21	81

Note 1:  $\Delta_{ACK}$ ,  $\Delta_{NACK}$  and  $\Delta_{CQI} = 8 \Leftrightarrow A_{hs} = \beta_{hs} / \beta_c = 30 / 15 \Leftrightarrow \beta_{hs} = 30 / 15 * \beta_c$ .  
 Note 2: CM = 1 for  $\beta_c / \beta_d = 12 / 15$ ,  $\beta_{hs} / \beta_c = 24 / 15$ . For all other combinations of DPDCH, DPCCH, HS-DPCCH, E-DPDCH and E-DPCCH the MPR is based on the relative CM difference.  
 Note 3: For subtest 1 the  $\beta_c / \beta_d$  ratio of 11 / 15 for the TFC during the measurement period (TF1, TF0) is achieved by setting the signaled gain factors for the reference TFC (TF1, TF1) to  $\beta_c = 10 / 15$  and  $\beta_d = 15 / 15$ .  
 Note 4: For subtest 5 the  $\beta_c / \beta_d$  ratio of 15 / 15 for the TFC during the measurement period (TF1, TF0) is achieved by setting the signaled gain factors for the reference TFC (TF1, TF1) to  $\beta_c = 14 / 15$  and  $\beta_d = 15 / 15$ .  
 Note 5: Testing UE using E-DPDCH Physical Layer category 1 Sub-test 3 is not required according to TS 25.306 Table 5.1g.  
 Note 6:  $\beta_{ed}$  cannot be set directly; it is set by Absolute Grant Value.

**Shenzhen UnionTrust Quality and Technology Co., Ltd.**

### 4.1.3 LTE Configuration and Testing

UE power class is category 3. The LTE maximum power reduction (MPR) in accordance with 3GPP TS 36.101 is active all times during LTE operation. The allowed MPR for the maximum output power please refer to the tune up procedure.

In addition, the device is compliant with additional maximum power reduction (A-MPR) requirements defined in 3GPP TS 36.101 section 6.2.4 that was disabled for all FCC compliance testing.

A properly configured base station simulator is used for the SAR and power measurements, so spectrum plots for each RB allocation and offset configuration are not included in the SAR report to demonstrate that the tested RB allocations have been correctly established at the maximum output power conditions.

### 4.1.4 WLAN Configuration and Testing

In general, various vendor specific external test software and chipset based internal test modes are typically used for SAR measurement. These chipset based test mode utilities are generally hardware and manufacturer dependent, and often include substantial flexibility to reconfigure or reprogram a device. A Wi-Fi device must be configured to transmit continuously at the required data rate, channel bandwidth and signal modulation, using the highest transmission duty factor supported by the test mode tools for SAR measurement. The test frequencies established using test mode must correspond to the actual channel frequencies. When 802.11 frame gaps are accounted for in the transmission, a maximum transmission duty factor of 92 - 96% is typically achievable in most test mode configurations. A minimum transmission duty factor of 85% is required to avoid certain hardware and device implementation issues related to wide range SAR scaling. In addition, a periodic transmission duty factor is required for current generation SAR systems to measure SAR correctly. The reported SAR must be scaled to 100% transmission duty factor to determine compliance at the maximum tune-up tolerance limit.

According to KDB 248227 D01, this device has installed WLAN engineering testing software which can provide continuous transmitting RF signal. During WLAN SAR testing, this device was operated to transmit continuously at the maximum transmission duty with specified transmission mode, operating frequency, lowest data rate, and maximum output power.

#### Initial Test Configuration

An initial test configuration is determined for OFDM transmission modes in 2.4 GHz and 5 GHz bands according to the channel bandwidth, modulation and data rate combination(s) with the highest maximum output power specified for production units in each standalone and aggregated frequency band. When the same maximum power is specified for multiple transmission modes in a frequency band, the largest channel bandwidth, lowest order modulation, lowest data rate and lowest order 802.11a/g/n/ac mode is used for SAR measurement, on the highest measured output power channel in the initial test configuration, for each frequency band.

#### Subsequent Test Configuration

SAR measurement requirements for the remaining 802.11 transmission mode configurations that have not been tested in the initial test configuration are determined separately for each standalone and aggregated frequency band, in each exposure condition, according to the maximum output power specified for production units. Additional power measurements may be required to determine if SAR measurements are required for

#### **Shenzhen UnionTrust Quality and Technology Co., Ltd.**

subsequent highest output power channels in a subsequent test configuration. When the highest reported SAR for the initial test configuration according to the initial test position or fixed exposure position requirements, is adjusted by the ratio of the subsequent test configuration to initial test configuration specified maximum output power and the adjusted SAR is  $\leq 1.2$  W/kg, SAR is not required for that subsequent test configuration.

#### **SAR Test Configuration and Channel Selection**

When multiple channel bandwidth configurations in a frequency band have the same specified maximum output power, the initial test configuration is using largest channel bandwidth, lowest order modulation, lowest data rate, and lowest order 802.11 mode (i.e., 802.11a is chosen over 802.11n then 802.11ac or 802.11g is chosen over 802.11n). After an initial test configuration is determined, if multiple test channels have the same measured maximum output power, the channel chosen for SAR measurement is determined according to the following.

- 1) The channel closest to mid-band frequency is selected for SAR measurement.
- 2) For channels with equal separation from mid-band frequency; for example, high and low channels or two mid-band channels, the higher frequency (number) channel is selected for SAR measurement.

#### **Test Reduction for U-NII-1 (5.2 GHz) and U-NII-2A (5.3 GHz) Bands**

For devices that operate in both U-NII bands using the same transmitter and antenna(s), SAR test reduction is determined according to the following.

- 1) When the same maximum output power is specified for both bands, begin SAR measurement in U-NII-2A band by applying the OFDM SAR requirements. If the highest reported SAR for a test configuration is  $\leq 1.2$  W/kg, SAR is not required for U-NII-1 band for that configuration (802.11 mode and exposure condition).
- 2) When different maximum output power is specified for the bands, begin SAR measurement in the band with higher specified maximum output power. The highest reported SAR for the tested configuration is adjusted by the ratio of lower to higher specified maximum output power for the two bands. When the adjusted SAR is  $\leq 1.2$  W/kg, SAR is not required for the band with lower maximum output power in that test configuration.

## 4.2 EUT Testing Position

### 4.2.1 Head Exposure Conditions

RF Exposure Conditions	Test Position	Separation Distance	SAR test exclusion
Head	Right Cheek	0 cm	N/A
	Right Tilted		
	Left Cheek		
	Left Tilted		

Note:

1. Head exposure for voice mode of handset is limited to next to the ear exposure conditions.
2. Devices that are designed to transmit next to the ear must be tested using the SAM phantom.
3. Other head exposure conditions, for example, in-front-of the face, should be tested using a flat phantom according to the required published RF exposure KDB procedures.
4. When data mode operates in next to the ear configurations, either data alone or in conjunction with voice transmissions, SAR evaluation is required for such use conditions.
5. When device supports VoIP, SAR evaluation for head Exposure Conditions using the most appropriate wireless data mode configurations is required.

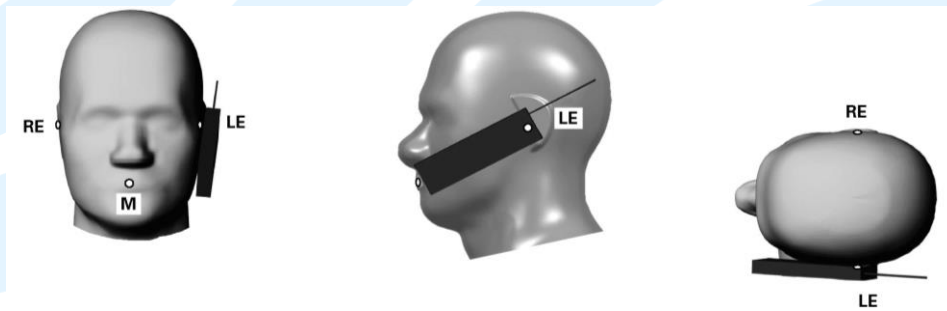

Fig-4.1 Cheek Position

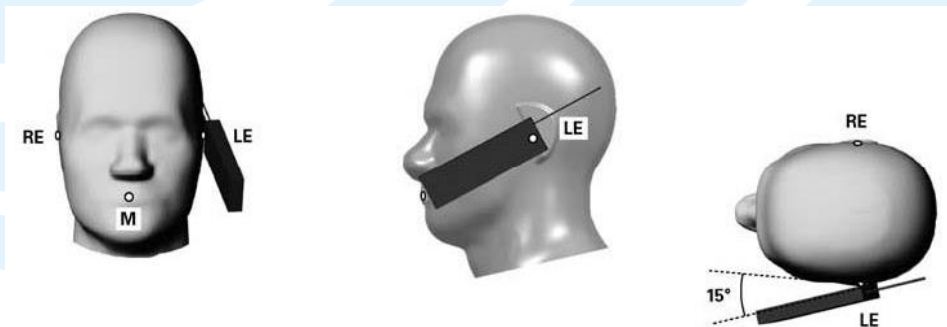

Fig-4.2 Tilted Position

Define two imaginary lines on the handset

- a) The vertical centerline passes through two points on the front side of the handset - the midpoint of the width  $w_t$  of the handset at the level of the acoustic output, and the midpoint of the width  $w_b$  of the bottom of the handset.
- b) The horizontal line is perpendicular to the vertical centerline and passes through the center of the acoustic output. The horizontal line is also tangential to the face of the handset at point A.
- c) The two lines intersect at point A. Note that for many handsets, point A coincides with the center of the acoustic output; however, the acoustic output may be located elsewhere on the horizontal line. Also note that

### **Shenzhen UnionTrust Quality and Technology Co., Ltd.**

the vertical centerline is not necessarily parallel to the front face of the handset, especially for clamshell handsets, handsets with flip covers, and other irregularly shaped handsets.

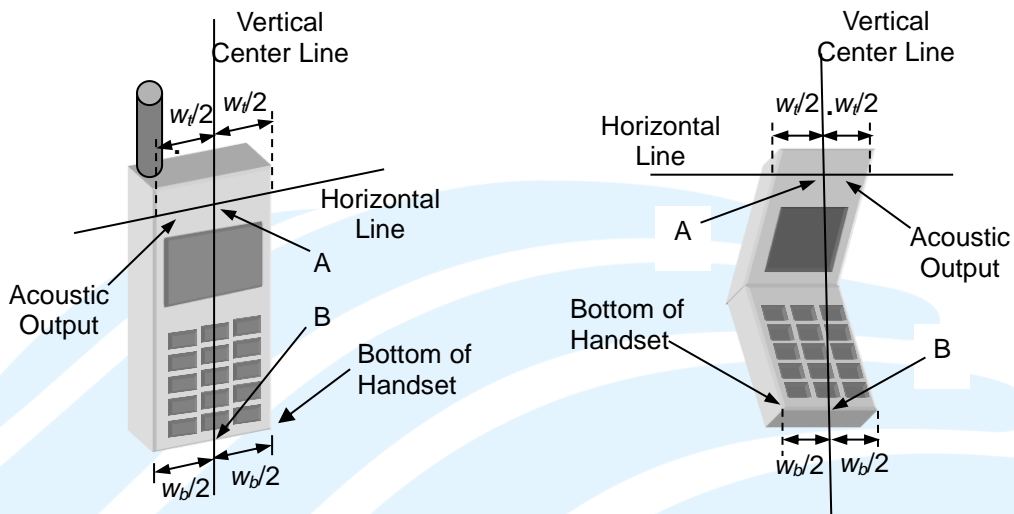

Fig-4.3 Handset Vertical and Horizontal Reference Lines

### 4.2.2 Body-worn Accessory Exposure Conditions

RF Exposure Conditions	Test Position	Separation Distance	SAR test exclusion
Body-worn	Front Face	0 ~ 2.5 cm	N/A
	Rear Face		

Note:

1. Body-worn accessories that do not contain metallic or conductive components may be tested according to worst-case exposure configurations, typically according to the smallest test separation distance required for the group of body-worn accessories with similar operating and exposure characteristics. All body-worn accessories containing metallic components are tested in conjunction with the host device.
2. Body-worn accessory SAR compliance is based on a single minimum test separation distance for all wireless and operating modes applicable to each body-worn accessory used by the host, and according to the relevant voice and/or data mode transmissions and operations. If a body-worn accessory supports voice only operations in its normal and expected use conditions, testing of data mode for body-worn compliance is not required.
3. A conservative minimum test separation distance for supporting off-the-shelf body-worn accessories that may be acquired by users of consumer handsets should be used to test for body-worn accessory SAR compliance. This distance is determined by the handset manufacturer according to the typical body-worn accessories users may acquire at the time of equipment certification, but not more than 2.5 cm, to enable users to purchase aftermarket body-worn accessories with the required minimum separation.
4. Devices that are designed to operate on the body of users using lanyards and straps or without requiring additional body-worn accessories must be tested for SAR compliance using a conservative minimum test separation distance  $\leq 5$  mm to support compliance.
5. When device supports VoIP, SAR evaluation for body-worn accessory Exposure Conditions using the most appropriate wireless data mode configurations is required.
6. Body-worn accessory exposure is typically related to voice mode operations when handsets are carried in body-worn accessories.
7. When the reported SAR for a body-worn accessory, measured without a headset connected to the handset, is  $> 1.2$  W/kg, the highest reported SAR configuration for that wireless mode and frequency band should be repeated for the body-worn accessory with a headset attached to the handset.

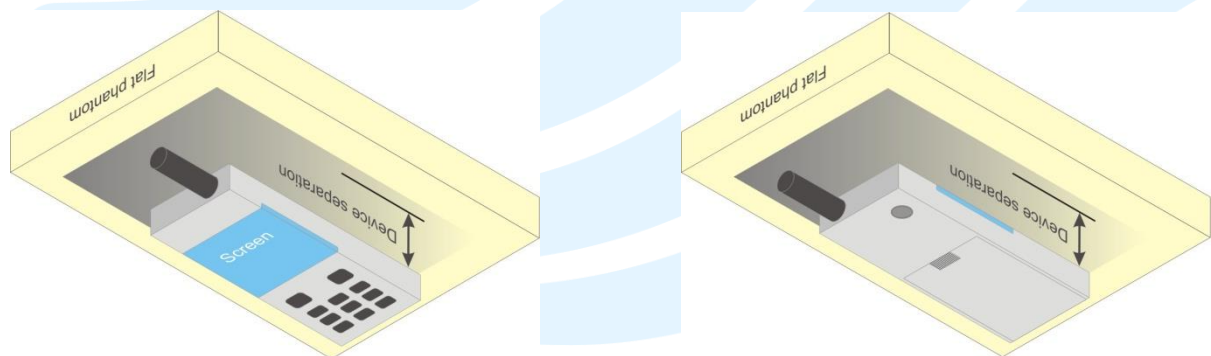

Fig-4.4 Body Worn Position

### 4.2.3 Hotspot Mode Exposure Conditions

RF Exposure Conditions	Test Position	Separation Distance	SAR test exclusion
Hotspot	Front Face	1 cm	Note 2/3
	Rear Face		
	Left Side		
	Right Side		
	Top Side		
	Bottom Side		

Note:

1. The SAR test separation distance for hotspot mode is determined according to device form factor. When the overall length and width of a device is > 9 cm x 5 cm (~3.5" x 2"), a test separation distance of 10 mm is required for hotspot mode SAR measurements. A test separation distance of 5 mm or less is required for smaller devices. The SAR test separation distance for hotspot mode is determined according to device form factor.
2. Hotspot mode SAR is measured for all edges and surfaces of the device with a transmitting antenna located within 25 mm from that surface or edge.
3. Based on the antenna location shown on appendix D of this report, the SAR testing required for hotspot mode is listed on section 4.5.1.

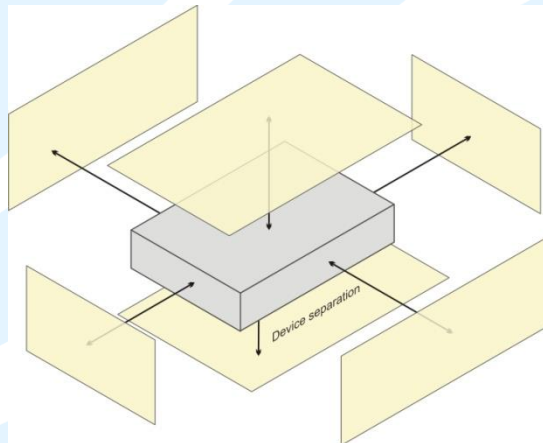

Fig-4.5 Test Positions for Hotspot Mode

### 4.3 Measured Conducted Power Result

#### 4.3.1 Conducted Power of GSM Band

The measuring conducted average power (Unit: dBm) is shown as below.

Band	GSM850			GSM1900		
Channel	128	190	251	512	661	810
Frequency (MHz)	824.2	836.6	848.8	1850.2	1880.0	1909.8
<b>Maximum Burst-Averaged Output Power</b>						
GSM (GMSK, 1Tx-slot)	32.92	33.05	<b>33.07</b>	<b>29.97</b>	29.84	29.81
GPRS (GMSK, 1Tx-slot)	32.89	33.00	32.98	29.96	29.84	29.77
GPRS (GMSK, 2Tx-slot)	32.08	32.29	32.30	28.84	28.82	28.70
GPRS (GMSK, 3Tx-slot)	30.19	30.42	30.48	26.52	26.42	26.42
GPRS (GMSK, 4Tx-slot)	28.90	29.08	29.17	25.40	25.29	25.16
EDGE (8PSK, 1Tx-slot)	27.06	27.04	27.05	26.72	26.93	27.12
EDGE (8PSK, 2Tx-slot)	26.10	26.15	26.14	25.81	26.01	26.19
EDGE (8PSK, 3Tx-slot)	24.43	24.45	24.42	23.85	24.27	24.44
EDGE (8PSK, 4Tx-slot)	23.61	23.57	23.48	22.95	23.32	23.61
<b>Maximum Frame-Averaged Output Power</b>						
GSM (GMSK, 1Tx-slot)	23.92	24.05	24.07	20.97	20.84	20.81
GPRS (GMSK, 1Tx-slot)	23.89	24.00	23.98	20.96	20.84	20.77
GPRS (GMSK, 2Tx-slot)	26.08	26.29	<b>26.30</b>	<b>22.84</b>	22.82	22.70
GPRS (GMSK, 3Tx-slot)	25.93	26.16	26.22	22.26	22.16	22.16
GPRS (GMSK, 4Tx-slot)	25.90	26.08	26.17	22.40	22.29	22.16
EDGE (8PSK, 1Tx-slot)	18.06	18.04	18.05	17.72	17.93	18.12
EDGE (8PSK, 2Tx-slot)	20.10	20.15	20.14	19.81	20.01	20.19
EDGE (8PSK, 3Tx-slot)	20.17	20.19	20.16	19.59	20.01	20.18
EDGE (8PSK, 4Tx-slot)	20.61	20.57	20.48	19.95	20.32	20.61

**Note:**

- SAR testing was performed on the maximum frame-averaged power mode.
- The frame-averaged power is linearly proportion to the slot number configured and it is linearly scaled the maximum burst-averaged power based on time slots. The calculated method is shown as below:  

$$\text{Frame-averaged power} = 10 \times \log (\text{Burst-averaged power mW} \times \text{Slot used} / 8)$$



### 4.3.2 Conducted Power of WCDMA Band

Band	WCDMA Band II			WCDMA Band IV			WCDMA Band V			3GPP MPR (dB)
Channel	9262	9400	9538	1312	1413	1513	4132	4182	4233	
Frequency (MHz)	1852.4	1880.0	1907.6	1712.4	1732.6	1752.6	826.4	836.4	846.6	
RMC 12.2K	23.03	<b>23.08</b>	23.02	23.24	<b>23.27</b>	23.25	24.09	<b>24.13</b>	24.11	-
HSDPA Subtest-1	21.82	21.80	21.87	22.06	22.03	22.07	22.87	22.88	22.84	-
HSDPA Subtest-2	21.75	21.75	21.79	22.01	22.00	22.02	22.85	22.82	22.83	-
HSDPA Subtest-3	21.20	21.19	21.27	21.49	21.50	21.51	22.32	22.30	22.36	-
HSDPA Subtest-4	21.17	21.23	21.28	21.46	21.51	21.47	22.35	22.30	22.33	-
HSUPA Subtest-1	19.64	19.61	19.69	19.91	19.91	19.89	20.79	20.76	20.77	-
HSUPA Subtest-2	19.66	19.62	19.69	19.91	19.92	19.90	20.84	20.86	20.83	-
HSUPA Subtest-3	20.66	20.67	20.69	20.96	20.95	20.95	21.77	21.84	21.79	-
HSUPA Subtest-4	19.18	19.18	19.22	19.45	19.48	19.46	20.42	20.39	20.40	-
HSUPA Subtest-5	21.21	21.20	21.25	21.46	21.48	21.45	22.34	22.32	22.30	-

### 4.3.3 Conducted Power of LTE Band

LTE Band / BW	RB Size	RB Offset	QPSK			3GPP MPR (dB)	16QAM			3GPP MPR (dB)	64QAM			3GPP MPR (dB)
			Low CH	Mid CH	High CH		Low CH	Mid CH	High CH		Low CH	Mid CH	High CH	
			18607	18900	19193		18607	18900	19193		18607	18900	19193	
2 / 1.4M	1	0	21.95	22.15	21.90	0	21.11	21.31	21.07	1	/	/	/	2
	1	2	22.31	22.40	22.38	0	21.52	21.58	21.51	1	/	/	/	2
	1	5	21.83	22.04	21.82	0	21.19	21.09	21.10	1	/	/	/	2
	3	0	22.29	22.34	22.26	0	21.36	21.49	21.19	1	/	/	/	2
	3	1	22.28	22.35	22.19	0	21.38	21.35	21.21	1	/	/	/	2
	3	3	22.23	22.36	22.17	0	21.30	21.31	21.14	1	/	/	/	2
	6	0	21.20	21.32	21.16	1	20.37	20.26	20.31	2	/	/	/	3

LTE Band / BW	RB Size	RB Offset	QPSK			3GPP MPR (dB)	16QAM			3GPP MPR (dB)	64QAM			3GPP MPR (dB)
			Low CH	Mid CH	High CH		Low CH	Mid CH	High CH		Low CH	Mid CH	High CH	
			18615	18900	19185		18615	18900	19185		18615	18900	19185	
2 / 3M	1	0	21.93	22.13	21.97	0	21.16	21.31	21.19	1	/	/	/	2
	1	7	22.39	22.33	22.30	0	21.41	21.48	21.42	1	/	/	/	2
	1	14	21.86	21.93	21.89	0	21.05	21.26	21.09	1	/	/	/	2
	8	0	21.28	21.34	21.22	1	20.23	20.34	20.30	2	/	/	/	3
	8	3	21.33	21.38	21.20	1	20.41	20.28	20.35	2	/	/	/	3
	8	7	21.22	21.36	21.26	1	20.39	20.31	20.12	2	/	/	/	3
	15	0	21.27	21.40	21.17	1	20.30	20.31	20.25	2	/	/	/	3

LTE Band / BW	RB Size	RB Offset	QPSK			3GPP MPR (dB)	16QAM			3GPP MPR (dB)	64QAM			3GPP MPR (dB)
			Low CH	Mid CH	High CH		Low CH	Mid CH	High CH		Low CH	Mid CH	High CH	
			18625	18900	19175		18625	18900	19175		18625	18900	19175	
2 / 5M	1	0	21.99	22.16	21.99	0	21.25	21.24	21.02	1	/	/	/	2
	1	12	22.24	22.39	22.31	0	21.57	21.65	21.44	1	/	/	/	2
	1	24	21.93	22.01	21.94	0	21.09	21.20	21.01	1	/	/	/	2
	12	0	21.23	21.43	21.18	1	20.24	20.46	20.26	2	/	/	/	3
	12	6	21.20	21.36	21.34	1	20.28	20.43	20.37	2	/	/	/	3
	12	13	21.34	21.38	21.25	1	20.26	20.39	20.25	2	/	/	/	3
	25	0	21.28	21.35	21.30	1	20.28	20.43	20.34	2	/	/	/	3

LTE Band / BW	RB Size	RB Offset	QPSK			3GPP MPR (dB)	16QAM			3GPP MPR (dB)	64QAM			3GPP MPR (dB)
			Low CH	Mid CH	High CH		Low CH	Mid CH	High CH		Low CH	Mid CH	High CH	
			18650	18900	19150		18650	18900	19150		18650	18900	19150	
2 / 10M	1	0	22.05	22.04	21.97	0	21.26	21.28	21.19	1	/	/	/	2
	1	24	22.35	22.50	22.39	0	21.48	21.46	21.39	1	/	/	/	2
	1	49	21.85	22.05	21.89	0	21.19	21.20	20.99	1	/	/	/	2
	25	0	21.27	21.44	21.34	1	20.24	20.33	20.29	2	/	/	/	3
	25	12	21.33	21.35	21.26	1	20.27	20.27	20.32	2	/	/	/	3
	25	25	21.20	21.22	21.12	1	20.31	20.33	20.09	2	/	/	/	3
	50	0	21.27	21.33	21.29	1	20.34	20.29	20.22	2	/	/	/	3

LTE Band / BW	RB Size	RB Offset	QPSK			3GPP MPR (dB)	16QAM			3GPP MPR (dB)	64QAM			3GPP MPR (dB)
			Low CH 18675	Mid CH 18900	High CH 19125		Low CH 18675	Mid CH 18900	High CH 19125		Low CH 18675	Mid CH 18900	High CH 19125	
			1857.5 MHz	1880.0 MHz	1902.5 MHz		1857.5 MHz	1880.0 MHz	1902.5 MHz		1857.5 MHz	1880.0 MHz	1902.5 MHz	
2 / 15M	1	0	22.07	22.02	21.99	0	21.21	21.26	21.11	1	/	/	/	2
	1	37	22.21	22.46	22.22	0	21.56	21.65	21.45	1	/	/	/	2
	1	74	21.92	21.96	21.91	0	21.16	21.15	21.12	1	/	/	/	2
	36	0	21.29	21.41	21.23	1	20.19	20.46	20.27	2	/	/	/	3
	36	19	21.32	21.36	21.32	1	20.40	20.38	20.31	2	/	/	/	3
	36	39	21.30	21.34	21.22	1	20.37	20.35	20.24	2	/	/	/	3
	75	0	21.24	21.31	21.18	1	20.23	20.36	20.21	2	/	/	/	3

LTE Band / BW	RB Size	RB Offset	QPSK			3GPP MPR (dB)	16QAM			3GPP MPR (dB)	64QAM			3GPP MPR (dB)
			Low CH 18700	Mid CH 18900	High CH 19100		Low CH 18700	Mid CH 18900	High CH 19100		Low CH 18700	Mid CH 18900	High CH 19100	
			1860.0 MHz	1880.0 MHz	1900.0 MHz		1860.0 MHz	1880.0 MHz	1900.0 MHz		1860.0 MHz	1880.0 MHz	1900.0 MHz	
2 / 20M	1	0	22.10	22.16	22.04	0	21.28	21.35	21.21	1	/	/	/	2
	1	50	22.41	<b>22.51</b>	22.41	0	21.57	21.66	21.57	1	/	/	/	2
	1	99	21.99	22.11	21.98	0	21.24	21.29	21.18	1	/	/	/	2
	50	0	21.33	21.49	21.36	1	20.37	20.51	20.35	2	/	/	/	3
	50	25	21.38	21.52	21.38	1	20.42	20.47	20.38	2	/	/	/	3
	50	50	21.37	21.39	21.27	1	20.41	20.42	20.26	2	/	/	/	3
	100	0	21.34	21.42	21.34	1	20.39	20.44	20.35	2	/	/	/	3

LTE Band / BW	RB Size	RB Offset	QPSK			3GPP MPR (dB)	16QAM			3GPP MPR (dB)	64QAM			3GPP MPR (dB)
			Low CH 19957	Mid CH 20175	High CH 20393		Low CH 19957	Mid CH 20175	High CH 20393		Low CH 19957	Mid CH 20175	High CH 20393	
			1710.7 MHz	1732.5 MHz	1754.3 MHz		1710.7 MHz	1732.5 MHz	1754.3 MHz		1710.7 MHz	1732.5 MHz	1754.3 MHz	
4 / 1.4M	1	0	21.58	21.55	21.45	0	20.73	20.90	20.81	1	/	/	/	2
	1	2	21.89	21.92	21.90	0	21.21	21.21	21.02	1	/	/	/	2
	1	5	21.51	21.45	21.45	0	20.81	20.66	20.66	1	/	/	/	2
	3	0	21.84	21.74	21.88	0	21.04	20.77	20.80	1	/	/	/	2
	3	1	21.92	22.01	21.82	0	21.00	20.91	20.84	1	/	/	/	2
	3	3	21.93	21.82	21.96	0	20.94	20.94	20.84	1	/	/	/	2
	6	0	20.91	20.87	20.86	1	19.90	19.88	19.90	2	/	/	/	3

LTE Band / BW	RB Size	RB Offset	QPSK			3GPP MPR (dB)	16QAM			3GPP MPR (dB)	64QAM			3GPP MPR (dB)
			Low CH 19965	Mid CH 20175	High CH 20385		Low CH 19965	Mid CH 20175	High CH 20385		Low CH 19965	Mid CH 20175	High CH 20385	
			1711.5 MHz	1732.5 MHz	1753.5 MHz		1711.5 MHz	1732.5 MHz	1753.5 MHz		1711.5 MHz	1732.5 MHz	1753.5 MHz	
4 / 3M	1	0	21.54	21.64	21.58	0	20.80	20.99	20.83	1	/	/	/	2
	1	7	22.01	21.86	21.91	0	21.33	21.08	21.09	1	/	/	/	2
	1	14	21.50	21.36	21.34	0	20.77	20.67	20.65	1	/	/	/	2
	8	0	20.92	20.76	20.82	1	19.98	19.77	19.80	2	/	/	/	3
	8	3	20.85	21.03	20.96	1	20.01	19.88	19.95	2	/	/	/	3
	8	7	20.83	20.84	20.91	1	19.92	19.93	19.95	2	/	/	/	3
	15	0	21.00	20.81	20.84	1	20.06	19.91	19.93	2	/	/	/	3

LTE Band / BW	RB Size	RB Offset	QPSK			3GPP MPR (dB)	16QAM			3GPP MPR (dB)	64QAM			3GPP MPR (dB)
			Low CH 19975	Mid CH 20175	High CH 20375		Low CH 19975	Mid CH 20175	High CH 20375		Low CH 19975	Mid CH 20175	High CH 20375	
			1712.5 MHz	1732.5 MHz	1752.5 MHz		1712.5 MHz	1732.5 MHz	1752.5 MHz		1712.5 MHz	1732.5 MHz	1752.5 MHz	
4 / 5M	1	0	21.58	21.52	21.50	0	20.84	20.99	20.80	1	/	/	/	2
	1	12	21.99	21.86	21.88	0	21.17	21.26	21.03	1	/	/	/	2
	1	24	21.55	21.52	21.44	0	20.84	20.69	20.66	1	/	/	/	2
	12	0	21.03	20.71	20.81	1	20.00	19.84	19.95	2	/	/	/	3
	12	6	20.80	20.97	20.93	1	19.90	19.94	19.87	2	/	/	/	3
	12	13	20.84	21.00	20.87	1	19.92	19.98	19.98	2	/	/	/	3
	25	0	20.96	20.81	20.91	1	20.06	19.85	19.96	2	/	/	/	3

LTE Band / BW	RB Size	RB Offset	QPSK			3GPP MPR (dB)	16QAM			3GPP MPR (dB)	64QAM			3GPP MPR (dB)
			Low CH 20000	Mid CH 20175	High CH 20350		Low CH 20000	Mid CH 20175	High CH 20350		Low CH 20000	Mid CH 20175	High CH 20350	
			1715.0 MHz	1732.5 MHz	1750.0 MHz		1715.0 MHz	1732.5 MHz	1750.0 MHz		1715.0 MHz	1732.5 MHz	1750.0 MHz	
4 / 10M	1	0	21.58	21.52	21.47	0	20.82	20.94	20.87	1	/	/	/	2
	1	24	21.90	21.90	21.90	0	21.20	21.11	21.15	1	/	/	/	2
	1	49	21.55	21.35	21.36	0	20.71	20.59	20.60	1	/	/	/	2
	25	0	20.90	20.73	20.95	1	20.04	19.82	19.94	2	/	/	/	3
	25	12	20.80	20.92	20.94	1	19.85	19.90	19.95	2	/	/	/	3
	25	25	20.94	20.86	20.85	1	19.92	19.98	19.93	2	/	/	/	3
	50	0	20.91	20.73	20.87	1	20.03	19.87	19.93	2	/	/	/	3

**Shenzhen UnionTrust Quality and Technology Co., Ltd.**

LTE Band / BW	RB Size	RB Offset	QPSK			3GPP MPR (dB)	16QAM			3GPP MPR (dB)	64QAM			3GPP MPR (dB)
			Low CH 20025	Mid CH 20175	High CH 20325		Low CH 20025	Mid CH 20175	High CH 20325		Low CH 20025	Mid CH 20175	High CH 20325	
			1717.5 MHz	1732.5 MHz	1747.5 MHz		1717.5 MHz	1732.5 MHz	1747.5 MHz		1717.5 MHz	1732.5 MHz	1747.5 MHz	
4 / 15M	1	0	21.62	21.63	21.44	0	20.72	20.96	20.83	1	/	/	/	2
	1	37	21.84	21.97	21.97	0	21.35	21.11	21.08	1	/	/	/	2
	1	74	21.37	21.47	21.49	0	20.80	20.58	20.75	1	/	/	/	2
	36	0	20.85	20.67	20.92	1	20.12	19.77	19.82	2	/	/	/	3
	36	19	20.91	21.03	20.95	1	19.90	19.87	19.95	2	/	/	/	3
	36	39	20.81	20.91	20.94	1	19.81	20.00	19.85	2	/	/	/	3
	75	0	20.93	20.79	20.88	1	19.88	19.96	19.80	2	/	/	/	3

LTE Band / BW	RB Size	RB Offset	QPSK			3GPP MPR (dB)	16QAM			3GPP MPR (dB)	64QAM			3GPP MPR (dB)
			Low CH 20050	Mid CH 20175	High CH 20300		Low CH 20050	Mid CH 20175	High CH 20300		Low CH 20050	Mid CH 20175	High CH 20300	
			1720.0 MHz	1732.5 MHz	1745.0 MHz		1720.0 MHz	1732.5 MHz	1745.0 MHz		1720.0 MHz	1732.5 MHz	1745.0 MHz	
4 / 20M	1	0	21.66	21.68	21.61	0	20.89	21.00	20.93	1	/	/	/	2
	1	50	22.01	<b>22.02</b>	22.01	0	21.35	21.26	21.20	1	/	/	/	2
	1	99	21.57	21.54	21.51	0	20.88	20.72	20.78	1	/	/	/	2
	50	0	21.03	20.85	20.95	1	20.13	19.90	19.98	2	/	/	/	3
	50	25	20.98	21.04	20.96	1	20.05	20.05	20.00	2	/	/	/	3
	50	50	20.95	21.01	20.97	1	20.00	20.06	19.99	2	/	/	/	3
	100	0	21.02	20.92	20.93	1	20.07	19.97	19.96	2	/	/	/	3

LTE Band / BW	RB Size	RB Offset	QPSK			3GPP MPR (dB)	16QAM			3GPP MPR (dB)	64QAM			3GPP MPR (dB)
			Low CH 20407	Mid CH 20525	High CH 20643		Low CH 20407	Mid CH 20525	High CH 20643		Low CH 20407	Mid CH 20525	High CH 20643	
			824.7 MHz	836.5 MHz	848.3 MHz		824.7 MHz	836.5 MHz	848.3 MHz		824.7 MHz	836.5 MHz	848.3 MHz	
5 / 1.4M	1	0	22.33	22.20	22.19	0	21.53	21.37	21.42	1	/	/	/	2
	1	2	22.36	22.32	22.32	0	21.51	21.62	21.65	1	/	/	/	2
	1	5	22.17	22.23	22.27	0	21.36	21.50	21.28	1	/	/	/	2
	3	0	22.41	22.39	22.58	0	21.33	21.42	21.37	1	/	/	/	2
	3	1	22.47	22.38	22.34	0	21.43	21.45	21.40	1	/	/	/	2
	3	3	22.36	22.32	22.40	0	21.47	21.28	21.24	1	/	/	/	2
	6	0	21.35	21.30	21.49	1	20.34	20.36	20.47	2	/	/	/	3

LTE Band / BW	RB Size	RB Offset	QPSK			3GPP MPR (dB)	16QAM			3GPP MPR (dB)	64QAM			3GPP MPR (dB)
			Low CH 20415	Mid CH 20525	High CH 20635		Low CH 20415	Mid CH 20525	High CH 20635		Low CH 20415	Mid CH 20525	High CH 20635	
			825.5 MHz	836.5 MHz	847.5 MHz		825.5 MHz	836.5 MHz	847.5 MHz		825.5 MHz	836.5 MHz	847.5 MHz	
5 / 3M	1	0	22.34	22.23	22.24	0	21.44	21.29	21.39	1	/	/	/	2
	1	7	22.35	22.46	22.37	0	21.62	21.54	21.57	1	/	/	/	2
	1	14	22.34	22.32	22.13	0	21.33	21.48	21.45	1	/	/	/	2
	8	0	21.43	21.55	21.57	1	20.30	20.43	20.42	2	/	/	/	3
	8	3	21.41	21.39	21.37	1	20.44	20.41	20.43	2	/	/	/	3
	8	7	21.43	21.36	21.48	1	20.47	20.27	20.33	2	/	/	/	3
	15	0	21.39	21.37	21.49	1	20.30	20.31	20.46	2	/	/	/	3

LTE Band / BW	RB Size	RB Offset	QPSK			3GPP MPR (dB)	16QAM			3GPP MPR (dB)	64QAM			3GPP MPR (dB)
			Low CH 20425	Mid CH 20525	High CH 20625		Low CH 20425	Mid CH 20525	High CH 20625		Low CH 20425	Mid CH 20525	High CH 20625	
			826.5 MHz	836.5 MHz	846.5 MHz		826.5 MHz	836.5 MHz	846.5 MHz		826.5 MHz	836.5 MHz	846.5 MHz	
5 / 5M	1	0	22.40	22.19	22.27	0	21.44	21.43	21.34	1	/	/	/	2
	1	12	22.34	22.50	22.45	0	21.44	21.48	21.64	1	/	/	/	2
	1	24	22.16	22.36	22.22	0	21.43	21.47	21.41	1	/	/	/	2
	12	0	21.31	21.44	21.57	1	20.29	20.44	20.36	2	/	/	/	3
	12	6	21.37	21.33	21.32	1	20.35	20.34	20.35	2	/	/	/	3
	12	13	21.42	21.32	21.44	1	20.47	20.29	20.35	2	/	/	/	3
	25	0	21.46	21.41	21.45	1	20.26	20.37	20.34	2	/	/	/	3

LTE Band / BW	RB Size	RB Offset	QPSK			3GPP MPR (dB)	16QAM			3GPP MPR (dB)	64QAM			3GPP MPR (dB)
			Low CH 20450	Mid CH 20525	High CH 20600		Low CH 20450	Mid CH 20525	High CH 20600		Low CH 20450	Mid CH 20525	High CH 20600	
			829.0 MHz	836.5 MHz	844.0 MHz		829.0 MHz	836.5 MHz	844.0 MHz		829.0 MHz	836.5 MHz	844.0 MHz	
5 / 10M	1	0	22.44	22.33	22.35	0	21.56	21.46	21.52	1	/	/	/	2
	1	24	<b>22.53</b>	22.51	22.48	0	21.62	21.63	21.69	1	/	/	/	2
	1	49	22.36	22.38	22.29	0	21.49	21.53	21.48	1	/	/	/	2
	25	0	21.45	21.55	21.58	1	20.37	20.51	20.51	2	/	/	/	3
	25	12	21.50	21.53	21.49	1	20.48	20.48	20.48	2	/	/	/	3
	25	25	21.53	21.41	21.48	1	20.49	20.35	20.43	2	/	/	/	3
	50	0	21.49	21.49	21.55	1	20.41	20.44	20.49	2	/	/	/	3

LTE Band / BW	RB Size	RB Offset	QPSK			3GPP MPR (dB)	16QAM			3GPP MPR (dB)	64QAM			3GPP MPR (dB)
			Low CH 23017	Mid CH 23095	High CH 23173		Low CH 23017	Mid CH 23095	High CH 23173		Low CH 23017	Mid CH 23095	High CH 23173	
			699.7 MHz	707.5 MHz	715.3 MHz		699.7 MHz	707.5 MHz	715.3 MHz		699.7 MHz	707.5 MHz	715.3 MHz	
12 / 1.4M	1	0	22.22	22.16	22.22	0	21.24	21.34	21.32	1	/	/	/	2
	1	2	22.38	22.38	22.43	0	21.50	21.54	21.57	1	/	/	/	2
	1	5	22.33	22.28	22.27	0	21.55	21.39	21.35	1	/	/	/	2
	3	0	22.25	22.45	22.17	0	21.23	21.62	21.39	1	/	/	/	2
	3	1	22.40	22.43	22.29	0	21.38	21.41	21.43	1	/	/	/	2
	3	3	22.29	22.56	22.43	0	21.20	21.69	21.44	1	/	/	/	2
	6	0	21.23	21.52	21.36	1	20.38	20.49	20.41	2	/	/	/	3

LTE Band / BW	RB Size	RB Offset	QPSK			3GPP MPR (dB)	16QAM			3GPP MPR (dB)	64QAM			3GPP MPR (dB)
			Low CH 23025	Mid CH 23095	High CH 23165		Low CH 23025	Mid CH 23095	High CH 23165		Low CH 23025	Mid CH 23095	High CH 23165	
			700.5 MHz	707.5 MHz	714.5 MHz		700.5 MHz	707.5 MHz	714.5 MHz		700.5 MHz	707.5 MHz	714.5 MHz	
12 / 3M	1	0	22.20	22.10	22.11	0	21.27	21.38	21.32	1	/	/	/	2
	1	7	22.29	22.42	22.32	0	21.53	21.63	21.59	1	/	/	/	2
	1	14	22.36	22.34	22.37	0	21.47	21.50	21.53	1	/	/	/	2
	8	0	21.26	21.55	21.34	1	20.29	20.53	20.29	2	/	/	/	3
	8	3	21.36	21.44	21.43	1	20.45	20.41	20.44	2	/	/	/	3
	8	7	21.19	21.46	21.41	1	20.22	20.61	20.51	2	/	/	/	3
	15	0	21.28	21.57	21.39	1	20.39	20.48	20.27	2	/	/	/	3

LTE Band / BW	RB Size	RB Offset	QPSK			3GPP MPR (dB)	16QAM			3GPP MPR (dB)	64QAM			3GPP MPR (dB)
			Low CH 23035	Mid CH 23095	High CH 23155		Low CH 23035	Mid CH 23095	High CH 23155		Low CH 23035	Mid CH 23095	High CH 23155	
			701.5 MHz	707.5 MHz	713.5 MHz		701.5 MHz	707.5 MHz	713.5 MHz		701.5 MHz	707.5 MHz	713.5 MHz	
12 / 5M	1	0	22.20	22.10	22.27	0	21.34	21.29	21.32	1	/	/	/	2
	1	12	22.32	22.43	22.41	0	21.53	21.55	21.59	1	/	/	/	2
	1	24	22.24	22.23	22.39	0	21.41	21.37	21.38	1	/	/	/	2
	12	0	21.36	21.51	21.19	1	20.28	20.60	20.27	2	/	/	/	3
	12	6	21.31	21.37	21.27	1	20.42	20.48	20.51	2	/	/	/	3
	12	13	21.13	21.61	21.29	1	20.21	20.51	20.48	2	/	/	/	3
	25	0	21.36	21.60	21.26	1	20.29	20.46	20.34	2	/	/	/	3

LTE Band / BW	RB Size	RB Offset	QPSK			3GPP MPR (dB)	16QAM			3GPP MPR (dB)	64QAM			3GPP MPR (dB)
			Low CH 23060	Mid CH 23095	High CH 23130		Low CH 23060	Mid CH 23095	High CH 23130		Low CH 23060	Mid CH 23095	High CH 23130	
			704.0 MHz	707.5 MHz	711.0 MHz		704.0 MHz	707.5 MHz	711.0 MHz		704.0 MHz	707.5 MHz	711.0 MHz	
12 / 10M	1	0	22.26	22.26	22.31	0	21.41	21.41	21.41	1	/	/	/	2
	1	24	22.44	22.48	22.49	0	21.59	21.65	21.63	1	/	/	/	2
	1	49	22.41	22.43	22.42	0	21.55	21.53	21.54	1	/	/	/	2
	25	0	21.38	21.57	21.35	1	20.43	20.68	20.41	2	/	/	/	3
	25	12	21.45	21.48	21.45	1	20.51	20.55	20.52	2	/	/	/	3
	25	25	21.33	21.65	21.43	1	20.38	20.71	20.51	2	/	/	/	3
	50	0	21.37	21.64	21.39	1	20.41	20.64	20.43	2	/	/	/	3

LTE Band / BW	RB Size	RB Offset	QPSK			3GPP MPR (dB)	16QAM			3GPP MPR (dB)	64QAM			3GPP MPR (dB)
			Low CH 23755	Mid CH 23790	High CH 23825		Low CH 23755	Mid CH 23790	High CH 23825		Low CH 23755	Mid CH 23790	High CH 23825	
			706.5 MHz	710.0 MHz	713.5 MHz		706.5 MHz	710.0 MHz	713.5 MHz		706.5 MHz	710.0 MHz	713.5 MHz	
17 / 5M	1	0	22.12	22.28	22.29	0	21.33	21.47	21.30	1	/	/	/	2
	1	12	22.37	22.32	22.41	0	21.62	21.50	21.57	1	/	/	/	2
	1	24	22.25	22.41	22.45	0	21.48	21.38	21.59	1	/	/	/	2
	12	0	21.42	21.42	21.19	1	20.45	20.51	20.35	2	/	/	/	3
	12	6	21.34	21.40	21.37	1	20.50	20.46	20.35	2	/	/	/	3
	12	13	21.52	21.47	21.40	1	20.59	20.62	20.51	2	/	/	/	3
	25	0	21.47	21.41	21.33	1	20.53	20.47	20.41	2	/	/	/	3

LTE Band / BW	RB Size	RB Offset	QPSK			3GPP MPR (dB)	16QAM			3GPP MPR (dB)	64QAM			3GPP MPR (dB)
			Low CH 23780	Mid CH 23790	High CH 23800		Low CH 23780	Mid CH 23790	High CH 23800		Low CH 23780	Mid CH 23790	High CH 23800	
			709.0 MHz	710.0 MHz	711.0 MHz		709.0 MHz	710.0 MHz	711.0 MHz		709.0 MHz	710.0 MHz	711.0 MHz	
17 / 10M	1	0	22.26	22.31	22.29	0	21.42	21.48	21.44	1	/	/	/	2
	1	24	<b>22.51</b>	22.47	22.48	0	21.67	21.66	21.62	1	/	/	/	2
	1	49	22.45	22.42	22.47	0	21.57	21.56	21.59	1	/	/	/	2
	25	0	21.51	21.42	21.37	1	20.58	20.51	20.41	2	/	/	/	3
	25	12	21.49	21.45	21.47	1	20.54	20.48	20.52	2	/	/	/	3
	25	25	21.61	21.55	21.43	1	20.65	20.63	20.53	2	/	/	/	3
	50	0	21.56	21.49	21.39	1	20.63	20.54	20.45	2	/	/	/	3

**Shenzhen UnionTrust Quality and Technology Co., Ltd.**

Address: 16/F, Block A, Building 6, Baoneng Science and Technology Park, Qingxiang Road No.1, Longhua New District, Shenzhen, China  
 Tel: +86-755-28230888 Fax: +86-755-28230886 E-mail: info@uttlab.com <http://www.uttlab.com>



#### 4.3.4 Conducted Power of WLAN

Mode		Channel	Frequency (MHz)	Average Power (dBm)
2.4G	802.11b	1	2412	14.07
		6	2437	14.17
		11	2462	14.22
	802.11g	1	2412	9.82
		6	2437	11.95
		11	2462	12.05
	802.11n (HT20)	1	2412	9.92
		6	2437	12.02
		11	2462	10.29
	802.11n (HT40)	3	2422	11.30
		6	2437	11.25
		9	2452	11.38

Mode		Channel	Frequency (MHz)	Average Power (dBm)
802.11a	5.2G	36	5180	10.90
		40	5200	11.26
		44	5220	11.49
		48	5240	12.46
	5.3G	52	5260	10.52
		56	5280	11.05
		60	5300	10.75
		64	5320	11.25
	5.6G	100	5500	10.84
		104	5520	10.80
		108	5540	10.71
		112	5560	10.61
		116	5580	10.46
		132	5660	9.96
		136	5680	9.80
		140	5700	9.76
	5.8G	149	5745	10.97
		153	5765	11.36
		157	5785	10.91
		161	5805	11.21
		165	5825	10.89

Mode		Channel	Frequency (MHz)	Average Power (dBm)
802.11n (HT20)	5.2G	36	5180	11.52
		40	5200	12.24
		44	5220	12.89
		48	5240	12.63
	5.3G	52	5260	10.44
		56	5280	10.62
		60	5300	10.73
		64	5320	10.89
	5.6G	100	5500	10.89
		104	5520	10.77
		108	5540	10.67
		112	5560	10.60
		116	5580	10.41
		132	5660	10.00
		136	5680	9.85
	5.8G	140	5700	9.73
		149	5745	10.04
		153	5765	10.90
		157	5785	9.92
161		5805	9.65	
		165	5825	9.91

Mode		Channel	Frequency (MHz)	Average Power (dBm)
802.11n (HT40)	5.2G	38	5190	11.10
		46	5230	11.67
	5.3G	54	5270	8.75
		62	5310	9.03
	5.6G	102	5510	9.63
		110	5550	9.56
	5.8G	134	5670	8.27
		151	5755	9.84
		159	5795	9.31

**Shenzhen UnionTrust Quality and Technology Co., Ltd.**

### 4.3.5 Conducted Power of BT

Mode		Channel	Frequency (MHz)	Average Power (dBm)
BR + EDR	GFSK	0	2402	4.00
		39	2441	3.35
		78	2480	2.23
	π/4-DQPSK	0	2402	1.07
		39	2441	0.82
		78	2480	-0.21
	8-DPSK	0	2402	1.15
		39	2441	0.84
		78	2480	-0.17

Mode		Channel	Frequency (MHz)	Average Power (dBm)
LE	LE	0	2402	3.03
		19	2440	2.43
		39	2480	1.28

## 4.4 SAR Test Exclusion Evaluations

### 4.4.1 Standalone SAR Test Exclusion Considerations

According to KDB 447498 D01, the SAR test exclusion condition is based on source-based time-averaged maximum conducted output power, adjusted for tune-up tolerance, and the minimum test separation distance required for the exposure conditions. The 1-g and 10-g SAR test exclusion thresholds are determined by the following:

- a) For 100 MHz to 6 GHz and test separation distances  $\leq 50$  mm:

$$\frac{\text{Max. Tune up Power}_{(mW)}}{\text{Min. Test Separation Distance}_{(mm)}} \times \sqrt{f_{(GHz)}} \leq 3.0 \text{ for SAR-1g, } \leq 7.5 \text{ for SAR-10g}$$

When the minimum test separation distance is  $< 5$  mm, a distance of 5 mm is applied to determine SAR test exclusion.

- b) For 100 MHz to 1500 MHz and test separation distances  $> 50$  mm:

$$\{[\text{Threshold for 50 mm in step a)}] + [(\text{test separation distance} - 50 \text{ mm}) \cdot (f_{(MHz)}/150)]\} \text{ mW}$$

- c) For  $> 1500$  MHz and  $\leq 6$  GHz and test separation distances  $> 50$  mm:

$$\{[\text{Threshold for 50 mm in step a)}] + [(\text{test separation distance} - 50 \text{ mm}) \cdot 10]\} \text{ mW}$$

When the calculated result in step a) is  $\leq 3.0$  for SAR-1g exposure condition, or  $\leq 7.5$  for SAR-10g exposure condition, the SAR testing exclusion is applied.

When the device output power is less than the calculated result (power threshold, mW) shown in in step b) and c), the SAR testing exclusion is applied.

Mode	Max. Tune-up Power (dBm)	Max. Tune-up Power (mW)	Head			Body-Worn		
			Ant. to Surface (mm)	Calculated Result	Require SAR Testing?	Ant. to Surface (mm)	Calculated Result	Require SAR Testing?
BT	4.5	2.82	5	0.9	No	10	0.4	No

#### 4.4.2 Estimated SAR Calculation

According to KDB 447498 D01, when an antenna qualifies for the standalone SAR test exclusion and also transmits simultaneously with other antennas, the standalone SAR value must be estimated according to the following to determine the simultaneous transmission SAR test exclusion criteria:

a) For test separation distances  $\leq 50$  mm:

$$Estimated\ SAR = \frac{Max.\ Tune\ up\ Power_{(mW)}}{Min.\ Test\ Separation\ Distance_{(mm)}} \times \frac{\sqrt{f(GHz)}}{x}$$

Where  $x = 7.5$  for 1-g SAR and  $x = 18.75$  for 10-g SAR.

b) For test separation distances  $> 50$  mm, 0.4 W/kg for 1-g SAR and 1.0 W/kg for 10-g SAR.

Mode / Band	Frequency (GHz)	Max. Tune-up Power (dBm)	Test Position	Separation Distance (mm)	Estimated SAR (W/kg)
BT (DSS)	2.48	4.5	Head	5	0.12
BT (DSS)	2.48	4.5	Body-worn	10	0.06

## 4.5 SAR Testing Results

### 4.5.1 SAR Test Reduction Considerations

#### KDB 447498 D01 General RF Exposure Guidance

Testing of other required channels within the operating mode of a frequency band is not required when the *reported* SAR for the mid-band or highest output power channel is:

- a)  $\leq 0.8$  W/kg or 2.0 W/kg, for 1-g or 10-g respectively, when the transmission band is  $\leq 100$  MHz
- b)  $\leq 0.6$  W/kg or 1.5 W/kg, for 1-g or 10-g respectively, when the transmission band is between 100 MHz and 200 MHz
- c)  $\leq 0.4$  W/kg or 1.0 W/kg, for 1-g or 10-g respectively, when the transmission band is  $\geq 200$  MHz

#### KDB 941225 D01 3G SAR Procedures

##### a) GSM SAR Test Reduction

SAR test reduction for GPRS and EDGE modes is determined by the source-based time-averaged output power specified for production units, including tune-up tolerance. The data mode with highest specified time-averaged output power should be tested for SAR compliance in the applicable exposure conditions. For modes with the same specified maximum output power and tolerance, the higher number time-slot configuration should be tested. The GMSK EDGE configurations are grouped with GPRS and considered with respect to time-averaged maximum output power to determine compliance. The 3G SAR test reduction procedure is applied to 8-PSK EDGE with GMSK GPRS/EDGE as the primary mode.

##### b) 3G SAR Test Reduction Procedure

The mode tested for SAR is referred to as the primary mode. The equivalent modes considered for SAR test reduction are denoted as secondary modes. Both primary and secondary modes must be in the same frequency band. When the maximum output power and tune-up tolerance specified for production units in a secondary mode is  $\leq 1/4$  dB higher than the primary mode or when the highest reported SAR of the primary mode is scaled by the ratio of specified maximum output power and tune-up tolerance of secondary to primary mode and the adjusted SAR is  $\leq 1.2$  W/kg, SAR measurement is not required for the secondary mode.

#### KDB 941225 D05 SAR for LTE Devices

##### a) QPSK with 1 RB and 50% RB allocation

Start with the largest channel bandwidth and measure SAR, using the RB offset and required test channel combination with the highest maximum output power among RB offsets at the upper edge, middle and lower edge of each required test channel. When the reported SAR is  $\leq 0.8$  W/kg, testing of the remaining RB offset configurations and required test channels is not required; otherwise, SAR is required for the remaining required test channels and only for the RB offset configuration with the highest output power for that channel. When the reported SAR of a required test channel is  $> 1.45$  W/kg, SAR is required for all three RB offset configurations for that required test channel.

##### b) QPSK with 100% RB allocation

SAR is not required when the highest maximum output power for 100% RB allocation is less than the highest maximum output power in 50% and 1 RB allocations and the highest reported SAR for 1 RB and 50% RB allocation are  $\leq 0.8$  W/kg. Otherwise, SAR is measured for the highest output power channel; and if the reported SAR is  $> 1.45$  W/kg, the remaining required test channels must also be tested.

##### c) Higher order modulations

SAR is required only when the highest maximum output power for the configuration in the higher order

### **Shenzhen UnionTrust Quality and Technology Co., Ltd.**

modulation is > 1/2 dB higher than the same configuration in QPSK or when the reported SAR for the QPSK configuration is > 1.45 W/kg.

d) Other channel bandwidth

SAR is required when the highest maximum output power of the smaller channel bandwidth is > 1/2 dB higher than the equivalent channel configurations in the largest channel bandwidth configuration or the reported SAR of a configuration for the largest channel bandwidth is > 1.45 W/kg.

**KDB 941225 D06 Hot Spot SAR**

Hotspot mode SAR is measured for all edges and surfaces of the device with a transmitting antenna located within 25 mm from that surface or edge.

Antenna	Front Face	Rear Face	Left Side	Right Side	Top Side	Bottom Side
WWAN Ant-0	Yes	Yes	N/A	Yes	N/A	Yes
WLAN / BT	Yes	Yes	Yes	N/A	Yes	N/A

**KDB 248227 D01 Wi-Fi SAR**

- a) For handsets operating next to ear, hotspot mode or mini-tablet configurations, the initial test position procedures were applied. The test position with the highest extrapolated peak SAR will be used as the initial test position. When the reported SAR of initial test position is  $\leq 0.4$  W/kg, SAR testing for remaining test positions is not required. Otherwise, SAR is evaluated at the subsequent highest peak SAR positions until the reported SAR result is  $\leq 0.8$  W/kg or all test positions are measured.
- b) For WLAN 2.4 GHz, the highest measured maximum output power channel for DSSS was selected for SAR measurement. When the reported SAR is  $\leq 0.8$  W/kg, no further SAR testing is required. Otherwise, SAR is evaluated at the next highest measured output power channel. When any reported SAR is > 1.2 W/kg, SAR is required for the third channel. For OFDM modes (802.11g/n), SAR is not required when the highest reported SAR for DSSS is adjusted by the ratio of OFDM to DSSS specified maximum output power and it is  $\leq 1.2$  W/kg.
- c) For WLAN 5 GHz, the initial test configuration was selected according to the transmission mode with the highest maximum output power. When the reported SAR of initial test configuration is > 0.8 W/kg, SAR is required for the subsequent highest measured output power channel until the reported SAR result is  $\leq 1.2$  W/kg or all required channels are measured. For other transmission modes, SAR is not required when the highest reported SAR for initial test configuration is adjusted by the ratio of subsequent test configuration to initial test configuration specified maximum output power and it is  $\leq 1.2$  W/kg.

### 4.5.2 SAR Results for Head Exposure Condition

Plot No.	Band	Mode	Test Position	Ch.	Max. Tune-up Power (dBm)	Measured Conducted Power (dBm)	Power Drift (dB)	Measured SAR-1g (W/kg)	Scaling Factor	Scaled SAR-1g (W/kg)
1	GSM850	GPRS10	Right Cheek	251	33.0	32.30	0.01	<b>0.579</b>	1.17	<b>0.68</b>
	GSM850	GPRS10	Right Tilted	251	33.0	32.30	-0.03	0.317	1.17	0.37
	GSM850	GPRS10	Left Cheek	251	33.0	32.30	-0.04	0.538	1.17	0.63
	GSM850	GPRS10	Left Tilted	251	33.0	32.30	0.00	0.308	1.17	0.36
2	GSM1900	GPRS10	Right Cheek	512	29.5	28.84	0.05	<b>0.16</b>	1.16	<b>0.19</b>
	GSM1900	GPRS10	Right Tilted	512	29.5	28.84	0.00	0.067	1.16	0.08
	GSM1900	GPRS10	Left Cheek	512	29.5	28.84	0.15	0.109	1.16	0.13
	GSM1900	GPRS10	Left Tilted	512	29.5	28.84	0.02	0.054	1.16	0.06
3	WCDMA II	RMC12.2K	Right Cheek	9400	23.5	23.08	-0.04	<b>0.165</b>	1.10	<b>0.18</b>
	WCDMA II	RMC12.2K	Right Tilted	9400	23.5	23.08	0.00	0.08	1.10	0.09
	WCDMA II	RMC12.2K	Left Cheek	9400	23.5	23.08	-0.03	0.142	1.10	0.16
	WCDMA II	RMC12.2K	Left Tilted	9400	23.5	23.08	-0.01	0.061	1.10	0.07
4	WCDMA IV	RMC12.2K	Right Cheek	1413	24.0	23.27	0.14	0.142	1.18	0.17
	WCDMA IV	RMC12.2K	Right Tilted	1413	24.0	23.27	0.03	0.062	1.18	0.07
	WCDMA IV	RMC12.2K	Left Cheek	1413	24.0	23.27	0.02	<b>0.156</b>	1.18	<b>0.18</b>
	WCDMA IV	RMC12.2K	Left Tilted	1413	24.0	23.27	-0.07	0.043	1.18	0.05
5	WCDMA V	RMC12.2K	Right Cheek	4182	24.5	24.13	-0.08	<b>0.461</b>	1.09	<b>0.50</b>
	WCDMA V	RMC12.2K	Right Tilted	4182	24.5	24.13	0.03	0.228	1.09	0.25
	WCDMA V	RMC12.2K	Left Cheek	4182	24.5	24.13	0.04	0.421	1.09	0.46
	WCDMA V	RMC12.2K	Left Tilted	4182	24.5	24.13	-0.03	0.22	1.09	0.24



Plot No.	Band	Mode	Test Position	Ch.	RB	offset	Max. Tune-up Power (dBm)	Measured Conducted Power (dBm)	Power Drift (dB)	Measured SAR-1g (W/kg)	Scaling Factor	Scaled SAR-1g (W/kg)
6	LTE 2	QPSK20M	Right Cheek	18900	1	50	23.0	22.51	0.06	0.154	1.12	0.17
	LTE 2	QPSK20M	Right Tilted	18900	1	50	23.0	22.51	0.00	0.072	1.12	0.08
	LTE 2	QPSK20M	Left Cheek	18900	1	50	23.0	22.51	0.06	0.146	1.12	0.16
	LTE 2	QPSK20M	Left Tilted	18900	1	50	23.0	22.51	-0.02	0.066	1.12	0.07
	LTE 2	QPSK20M	Right Cheek	18900	50	25	22.0	21.52	0.17	0.122	1.12	0.14
	LTE 2	QPSK20M	Right Tilted	18900	50	25	22.0	21.52	0.02	0.058	1.12	0.06
	LTE 2	QPSK20M	Left Cheek	18900	50	25	22.0	21.52	0.10	0.114	1.12	0.13
	LTE 2	QPSK20M	Left Tilted	18900	50	25	22.0	21.52	0.02	0.053	1.12	0.06
7	LTE 4	QPSK20M	Right Cheek	20175	1	50	22.5	22.02	0.03	0.156	1.12	0.17
	LTE 4	QPSK20M	Right Tilted	20175	1	50	22.5	22.02	0.03	0.072	1.12	0.08
	LTE 4	QPSK20M	Left Cheek	20175	1	50	22.5	22.02	0.05	0.201	1.12	0.22
	LTE 4	QPSK20M	Left Tilted	20175	1	50	22.5	22.02	-0.04	0.069	1.12	0.08
	LTE 4	QPSK20M	Right Cheek	20175	50	25	21.5	21.04	-0.11	0.137	1.11	0.15
	LTE 4	QPSK20M	Right Tilted	20175	50	25	21.5	21.04	0.01	0.058	1.11	0.06
	LTE 4	QPSK20M	Left Cheek	20175	50	25	21.5	21.04	0.03	0.148	1.11	0.16
	LTE 4	QPSK20M	Left Tilted	20175	50	25	21.5	21.04	0.04	0.05	1.11	0.06
8	LTE 5	QPSK10M	Right Cheek	20450	1	24	23.0	22.53	-0.12	0.388	1.11	0.43
	LTE 5	QPSK10M	Right Tilted	20450	1	24	23.0	22.53	-0.04	0.208	1.11	0.23
	LTE 5	QPSK10M	Left Cheek	20450	1	24	23.0	22.53	0.12	0.347	1.11	0.39
	LTE 5	QPSK10M	Left Tilted	20450	1	24	23.0	22.53	-0.02	0.217	1.11	0.24
	LTE 5	QPSK10M	Right Cheek	20600	25	0	22.0	21.58	0.00	0.34	1.10	0.37
	LTE 5	QPSK10M	Right Tilted	20600	25	0	22.0	21.58	-0.02	0.189	1.10	0.21
	LTE 5	QPSK10M	Left Cheek	20600	25	0	22.0	21.58	0.04	0.314	1.10	0.35
	LTE 5	QPSK10M	Left Tilted	20600	25	0	22.0	21.58	0.07	0.193	1.10	0.21
9	LTE 12	QPSK10M	Right Cheek	23130	1	24	23.0	22.49	0.02	0.137	1.12	0.15
	LTE 12	QPSK10M	Right Tilted	23130	1	24	23.0	22.49	0.02	0.078	1.12	0.09
	LTE 12	QPSK10M	Left Cheek	23130	1	24	23.0	22.49	-0.09	0.1	1.12	0.11
	LTE 12	QPSK10M	Left Tilted	23130	1	24	23.0	22.49	-0.03	0.055	1.12	0.06
	LTE 12	QPSK10M	Right Cheek	23095	25	25	22.0	21.65	0.02	0.101	1.08	0.11
	LTE 12	QPSK10M	Right Tilted	23095	25	25	22.0	21.65	0.02	0.059	1.08	0.06
	LTE 12	QPSK10M	Left Cheek	23095	25	25	22.0	21.65	0.03	0.09	1.08	0.10
	LTE 12	QPSK10M	Left Tilted	23095	25	25	22.0	21.65	-0.01	0.054	1.08	0.06

Plot No.	Band	Mode	Test Position	Ch.	Max. Tune-up Power (dBm)	Measured Conducted Power (dBm)	Power Drift (dB)	Measured SAR-1g (W/kg)	Scaling Factor	Scaled SAR-1g (W/kg)
10	802.11b	-	Right Cheek	11	15.0	14.22	0.02	<b>0.523</b>	1.20	<b>0.63</b>
	802.11b	-	Right Tilted	11	15.0	14.22	-0.08	0.392	1.20	0.47
	802.11b	-	Left Cheek	11	15.0	14.22	-0.06	0.231	1.20	0.28
	802.11b	-	Left Tilted	11	15.0	14.22	0.00	0.196	1.20	0.23
11	802.11a	-	Right Cheek	48	13.0	12.46	0.05	0.054	1.13	0.06
	802.11a	-	Right Tilted	48	13.0	12.46	0.01	<b>0.06</b>	1.13	<b>0.07</b>
	802.11a	-	Left Cheek	48	13.0	12.46	0.01	0.034	1.13	0.04
	802.11a	-	Left Tilted	48	13.0	12.46	0.06	0.034	1.13	0.04
12	802.11a	-	Right Cheek	100	11.5	10.84	0.02	0.232	1.16	0.27
	802.11a	-	Right Tilted	100	11.5	10.84	0.06	<b>0.238</b>	1.16	<b>0.28</b>
	802.11a	-	Left Cheek	100	11.5	10.84	0.05	0.136	1.16	0.16
	802.11a	-	Left Tilted	100	11.5	10.84	0.03	0.142	1.16	0.17
13	802.11a	-	Right Cheek	153	12.0	11.36	0.02	0.879	1.16	1.02
	802.11a	-	Right Tilted	153	12.0	11.36	0.02	<b>0.902</b>	1.16	<b>1.05</b>
	802.11a	-	Left Cheek	153	12.0	11.36	0.05	0.515	1.16	0.60
	802.11a	-	Left Tilted	153	12.0	11.36	-0.03	0.538	1.16	0.62
	802.11a	-	Right Cheek	161	12.0	11.21	0.06	0.848	1.20	1.02
	802.11a	-	Right Tilted	161	12.0	11.21	0.06	0.869	1.20	1.04
	802.11a	-	Right Tilted	153	12.0	11.36	0.01	0.897	1.16	1.04

**Shenzhen UnionTrust Quality and Technology Co., Ltd.**

Address: 16/F, Block A, Building 6, Baoneng Science and Technology Park, Qingxiang Road No.1, Longhua New District, Shenzhen, China  
 Tel: +86-755-28230888 Fax: +86-755-28230886 E-mail: info@uttlab.com [Http://www.uttlab.com](http://www.uttlab.com)

### 4.5.3 SAR Results for Body-worn Exposure Condition (Separation Distance is 1.0 cm)

Plot No.	Band	Mode	Test Position	Ch.	RB	offset	Max. Tune-up Power (dBm)	Measured Conducted Power (dBm)	Power Drift (dB)	Measured SAR-1g (W/kg)	Scaling Factor	Scaled SAR-1g (W/kg)
14	GSM850	GPRS10	Front Face	251	-	-	33.0	32.30	0.02	0.734	1.17	0.86
	GSM850	GPRS10	Rear Face	251	-	-	33.0	32.30	-0.03	<b>0.921</b>	1.17	1.08
	GSM850	GPRS10	Front Face	128	-	-	33.0	32.08	0.02	0.643	1.24	0.79
	GSM850	GPRS10	Front Face	190	-	-	33.0	32.29	-0.06	0.647	1.18	0.76
	GSM850	GPRS10	Rear Face	128	-	-	33.0	32.08	0.03	0.909	1.24	<b>1.12</b>
	GSM850	GPRS10	Rear Face	190	-	-	33.0	32.29	0.03	0.906	1.18	1.07
	GSM850	GPRS10	Rear Face	251	-	-	33.0	32.30	-0.04	0.912	1.17	1.07
24	GSM1900	GPRS10	Front Face	512	-	-	29.5	28.84	-0.03	0.227	1.16	0.26
	GSM1900	GPRS10	Rear Face	512	-	-	29.5	28.84	0.00	<b>0.375</b>	1.16	<b>0.44</b>
16	WCDMA II	RMC12.2K	Front Face	9400	-	-	23.5	23.08	-0.09	0.29	1.10	0.32
	WCDMA II	RMC12.2K	Rear Face	9400	-	-	23.5	23.08	0.00	<b>0.465</b>	1.10	<b>0.51</b>
17	WCDMA IV	RMC12.2K	Front Face	1413	-	-	24.0	23.27	0.00	0.278	1.18	0.33
	WCDMA IV	RMC12.2K	Rear Face	1413	-	-	24.0	23.27	-0.10	<b>0.396</b>	1.18	<b>0.47</b>
18	WCDMA V	RMC12.2K	Front Face	4182	-	-	24.5	24.13	0.03	0.523	1.09	0.57
	WCDMA V	RMC12.2K	Rear Face	4182	-	-	24.5	24.13	-0.17	<b>0.603</b>	1.09	<b>0.66</b>
25	LTE 2	QPSK20M	Front Face	18900	1	50	23.0	22.51	-0.18	0.288	1.12	0.32
	LTE 2	QPSK20M	Rear Face	18900	1	50	23.0	22.51	-0.02	<b>0.434</b>	1.12	<b>0.49</b>
	LTE 2	QPSK20M	Front Face	18900	50	25	22.0	21.52	-0.12	0.243	1.12	0.27
	LTE 2	QPSK20M	Rear Face	18900	50	25	22.0	21.52	0.06	0.355	1.12	0.40
26	LTE 4	QPSK20M	Front Face	20175	1	50	22.5	22.02	0.02	0.354	1.12	0.40
	LTE 4	QPSK20M	Rear Face	20175	1	50	22.5	22.02	-0.05	<b>0.49</b>	1.12	<b>0.55</b>
	LTE 4	QPSK20M	Front Face	20175	50	25	21.5	21.04	-0.05	0.282	1.11	0.31
	LTE 4	QPSK20M	Rear Face	20175	50	25	21.5	21.04	-0.12	0.394	1.11	0.44
21	LTE 5	QPSK10M	Front Face	20450	1	24	23.0	22.53	-0.02	0.433	1.11	0.48
	LTE 5	QPSK10M	Rear Face	20450	1	24	23.0	22.53	-0.12	<b>0.519</b>	1.11	<b>0.58</b>
	LTE 5	QPSK10M	Front Face	20600	25	0	22.0	21.58	0.00	0.344	1.10	0.38
	LTE 5	QPSK10M	Rear Face	20600	25	0	22.0	21.58	0.01	0.405	1.10	0.45
22	LTE 12	QPSK10M	Front Face	23130	1	24	23.0	22.49	-0.10	0.136	1.12	0.15
	LTE 12	QPSK10M	Rear Face	23130	1	24	23.0	22.49	0.06	<b>0.182</b>	1.12	<b>0.20</b>
	LTE 12	QPSK10M	Front Face	23095	25	25	22.0	21.65	0.13	0.136	1.08	0.15
	LTE 12	QPSK10M	Rear Face	23095	25	25	22.0	21.65	0.01	0.181	1.08	0.20
23	802.11b	-	Front Face	11	-	-	15.0	14.22	-0.07	0.128	1.20	0.15
	802.11b	-	Rear Face	11	-	-	15.0	14.22	-0.13	<b>0.162</b>	1.20	<b>0.19</b>
27	802.11a	-	Front Face	48	-	-	13.0	12.46	0.06	0.033	1.13	0.04
	802.11a	-	Rear Face	48	-	-	13.0	12.46	0.01	<b>0.072</b>	1.13	<b>0.08</b>
28	802.11a	-	Front Face	100	-	-	11.5	10.84	0.02	<b>0.04</b>	1.16	<b>0.05</b>
	802.11a	-	Rear Face	100	-	-	11.5	10.84	0.03	0.025	1.16	0.03
29	802.11a	-	Front Face	153	-	-	12.0	11.36	0.08	<b>0.155</b>	1.16	<b>0.18</b>
	802.11a	-	Rear Face	153	-	-	12.0	11.36	0.00	0.078	1.16	0.09

**4.5.4 SAR Results for Hotspot Exposure Condition (Separation Distance is 1.0 cm)**

Plot No.	Band	Mode	Test Position	Ch.	Max. Tune-up Power (dBm)	Measured Conducted Power (dBm)	Power Drift (dB)	Measured SAR-1g (W/kg)	Scaling Factor	Scaled SAR-1g (W/kg)
14	GSM850	GPRS10	Front Face	251	33.0	32.30	0.02	0.734	1.17	0.86
	GSM850	GPRS10	Rear Face	251	33.0	32.30	0.01	<b>0.921</b>	1.17	1.08
	GSM850	GPRS10	Right Side	251	33.0	32.30	0.05	0.86	1.17	1.01
	GSM850	GPRS10	Bottom Side	251	33.0	32.30	0.08	0.264	1.17	0.31
	GSM850	GPRS10	Front Face	128	33.0	32.08	0.02	0.643	1.24	0.79
	GSM850	GPRS10	Front Face	190	33.0	32.29	-0.06	0.647	1.18	0.76
	GSM850	GPRS10	Rear Face	128	33.0	32.08	0.03	0.909	1.24	<b>1.12</b>
	GSM850	GPRS10	Rear Face	190	33.0	32.29	0.03	0.906	1.18	1.07
	GSM850	GPRS10	Right Side	128	33.0	32.08	0.10	0.9	1.24	1.11
	GSM850	GPRS10	Right Side	190	33.0	32.29	0.02	0.853	1.18	1.00
	GSM850	GPRS10	Rear Face	251	33.0	32.30	-0.04	0.912	1.17	1.07
	15	GSM1900	GPRS10	Front Face	512	29.5	28.84	-0.03	0.227	1.16
GSM1900		GPRS10	Rear Face	512	29.5	28.84	0.00	0.375	1.16	0.44
GSM1900		GPRS10	Right Side	512	29.5	28.84	0.01	0.097	1.16	0.11
GSM1900		GPRS10	Bottom Side	512	29.5	28.84	0.06	<b>0.379</b>	1.16	<b>0.44</b>
16	WCDMA II	RMC12.2K	Front Face	9400	23.5	23.08	-0.09	0.29	1.10	0.32
	WCDMA II	RMC12.2K	Rear Face	9400	23.5	23.08	0.05	<b>0.465</b>	1.10	<b>0.51</b>
	WCDMA II	RMC12.2K	Right Side	9400	23.5	23.08	0.05	0.114	1.10	0.13
	WCDMA II	RMC12.2K	Bottom Side	9400	23.5	23.08	0.03	0.461	1.10	0.51
17	WCDMA IV	RMC12.2K	Front Face	1413	24.0	23.27	0.00	0.278	1.18	0.33
	WCDMA IV	RMC12.2K	Rear Face	1413	24.0	23.27	-0.09	<b>0.396</b>	1.18	<b>0.47</b>
	WCDMA IV	RMC12.2K	Right Side	1413	24.0	23.27	0.10	0.105	1.18	0.12
	WCDMA IV	RMC12.2K	Bottom Side	1413	24.0	23.27	-0.06	0.393	1.18	0.46
18	WCDMA V	RMC12.2K	Front Face	4182	24.5	24.13	0.03	0.523	1.09	0.57
	WCDMA V	RMC12.2K	Rear Face	4182	24.5	24.13	-0.17	<b>0.603</b>	1.09	<b>0.66</b>
	WCDMA V	RMC12.2K	Right Side	4182	24.5	24.13	0.00	0.48	1.09	0.52
	WCDMA V	RMC12.2K	Bottom Side	4182	24.5	24.13	0.03	0.198	1.09	0.22

Plot No.	Band	Mode	Test Position	Ch.	RB	offset	Max. Tune-up Power (dBm)	Measured Conducted Power (dBm)	Power Drift (dB)	Measured SAR-1g (W/kg)	Scaling Factor	Scaled SAR-1g (W/kg)
19	LTE 2	QPSK20M	Front Face	18900	1	50	23.0	22.51	-0.18	0.288	1.12	0.32
	LTE 2	QPSK20M	Rear Face	18900	1	50	23.0	22.51	-0.02	0.434	1.12	0.49
	LTE 2	QPSK20M	Right Side	18900	1	50	23.0	22.51	0.00	0.128	1.12	0.14
	LTE 2	QPSK20M	Bottom Side	18900	1	50	23.0	22.51	0.02	0.498	1.12	0.56
	LTE 2	QPSK20M	Front Face	18900	50	25	22.0	21.52	-0.12	0.243	1.12	0.27
	LTE 2	QPSK20M	Rear Face	18900	50	25	22.0	21.52	0.06	0.355	1.12	0.40
	LTE 2	QPSK20M	Right Side	18900	50	25	22.0	21.52	-0.02	0.106	1.12	0.12
	LTE 2	QPSK20M	Bottom Side	18900	50	25	22.0	21.52	0.03	0.382	1.12	0.43
20	LTE 4	QPSK20M	Front Face	20175	1	50	22.5	22.02	0.02	0.354	1.12	0.40
	LTE 4	QPSK20M	Rear Face	20175	1	50	22.5	22.02	-0.05	0.49	1.12	0.55
	LTE 4	QPSK20M	Right Side	20175	1	50	22.5	22.02	-0.17	0.132	1.12	0.15
	LTE 4	QPSK20M	Bottom Side	20175	1	50	22.5	22.02	-0.05	0.649	1.12	0.72
	LTE 4	QPSK20M	Front Face	20175	50	25	21.5	21.04	-0.05	0.282	1.11	0.31
	LTE 4	QPSK20M	Rear Face	20175	50	25	21.5	21.04	-0.12	0.394	1.11	0.44
	LTE 4	QPSK20M	Right Side	20175	50	25	21.5	21.04	0.17	0.11	1.11	0.12
	LTE 4	QPSK20M	Bottom Side	20175	50	25	21.5	21.04	0.05	0.416	1.11	0.46
21	LTE 5	QPSK10M	Front Face	20450	1	24	23.0	22.53	-0.02	0.433	1.11	0.48
	LTE 5	QPSK10M	Rear Face	20450	1	24	23.0	22.53	-0.12	0.519	1.11	0.58
	LTE 5	QPSK10M	Right Side	20450	1	24	23.0	22.53	0.04	0.42	1.11	0.47
	LTE 5	QPSK10M	Bottom Side	20450	1	24	23.0	22.53	0.13	0.156	1.11	0.17
	LTE 5	QPSK10M	Front Face	20600	25	0	22.0	21.58	0.00	0.344	1.10	0.38
	LTE 5	QPSK10M	Rear Face	20600	25	0	22.0	21.58	0.01	0.405	1.10	0.45
	LTE 5	QPSK10M	Right Side	20600	25	0	22.0	21.58	0.03	0.328	1.10	0.36
	LTE 5	QPSK10M	Bottom Side	20600	25	0	22.0	21.58	0.02	0.116	1.10	0.13
22	LTE 12	QPSK10M	Front Face	23130	1	24	23.0	22.49	-0.10	0.136	1.12	0.15
	LTE 12	QPSK10M	Rear Face	23130	1	24	23.0	22.49	0.05	0.182	1.12	0.20
	LTE 12	QPSK10M	Right Side	23130	1	24	23.0	22.49	-0.09	0.165	1.12	0.19
	LTE 12	QPSK10M	Bottom Side	23130	1	24	23.0	22.49	-0.03	0.033	1.12	0.04
	LTE 12	QPSK10M	Front Face	23095	25	25	22.0	21.65	0.13	0.136	1.08	0.15
	LTE 12	QPSK10M	Rear Face	23095	25	25	22.0	21.65	0.01	0.181	1.08	0.20
	LTE 12	QPSK10M	Right Side	23095	25	25	22.0	21.65	0.14	0.151	1.08	0.16
	LTE 12	QPSK10M	Bottom Side	23095	25	25	22.0	21.65	0.03	0.035	1.08	0.04

Plot No.	Band	Mode	Test Position	Ch.	Max. Tune-up Power (dBm)	Measured Conducted Power (dBm)	Power Drift (dB)	Measured SAR-1g (W/kg)	Scaling Factor	Scaled SAR-1g (W/kg)
23	802.11b	-	Front Face	11	15.0	14.22	-0.07	0.128	1.20	0.15
	802.11b	-	Rear Face	11	15.0	14.22	-0.13	0.162	1.20	0.19
	802.11b	-	Left Side	11	15.0	14.22	0.07	0.09	1.20	0.11
	802.11b	-	Top Side	11	15.0	14.22	0.09	0.076	1.20	0.09

**Shenzhen UnionTrust Quality and Technology Co., Ltd.**

## 4.6 SAR Measurement Variability

### 4.6.1 Repeated Measurement

According to KDB 865664 D01, SAR measurement variability was assessed for each frequency band, which is determined by the SAR probe calibration point and tissue-equivalent medium used for the device measurements. When both head and body tissue-equivalent media are required for SAR measurements in a frequency band, the variability measurement procedures should be applied to the tissue medium with the highest measured SAR, using the highest measured SAR configuration for that tissue-equivalent medium. Alternatively, if the highest measured SAR for both head and body tissue-equivalent media are  $\leq 1.45$  W/kg and the ratio of these highest SAR values, i.e., largest divided by smallest value, is  $\leq 1.10$ , the highest SAR configuration for either head or body tissue-equivalent medium may be used to perform the repeated measurement. These additional measurements are repeated after the completion of all measurements requiring the same head or body tissue-equivalent medium in a frequency band. The test device should be returned to ambient conditions (normal room temperature) with the battery fully charged before it is re-mounted on the device holder for the repeated measurement(s) to minimize any unexpected variations in the repeated results.

SAR repeated measurement procedure:

1. When the highest measured SAR is  $< 0.80$  W/kg, repeated measurement is not required.
2. When the highest measured SAR is  $\geq 0.80$  W/kg, repeat that measurement once.
3. If the ratio of largest to smallest SAR for the original and first repeated measurements is  $> 1.20$ , or when the original or repeated measurement is  $\geq 1.45$  W/kg, perform a second repeated measurement.
4. If the ratio of largest to smallest SAR for the original, first and second repeated measurements is  $> 1.20$ , and the original, first or second repeated measurement is  $\geq 1.5$  W/kg, perform a third repeated measurement.

Band	Mode	Test Position	Ch.	Original Measured SAR-1g (W/kg)	1st Repeated SAR-1g (W/kg)	L/S Ratio	2nd Repeated SAR-1g (W/kg)	L/S Ratio	3rd Repeated SAR-1g (W/kg)	L/S Ratio
Head Exposure Condition										
802.11a	-	Right Tilted	153	0.902	0.897	1.01	N/A	N/A	N/A	N/A
Hotspot Exposure Condition										
GSM850	GPRS10	Rear Face	251	0.921	0.912	1.01	N/A	N/A	N/A	N/A

## 4.7 Simultaneous Multi-band Transmission Evaluation

### 4.7.1 Simultaneous Transmission SAR Test Exclusion Considerations

a) Sum of SAR

Simultaneous transmission SAR test exclusion is determined for each operating configuration and exposure condition according to the reported standalone SAR of each applicable simultaneous transmitting antenna. When the sum of SAR<sub>1g</sub> of all simultaneously transmitting antennas in an operating mode and exposure condition combination is within the SAR limit (SAR<sub>1g</sub> 1.6 W/kg), the simultaneous transmission SAR is not required. When the sum of SAR<sub>1g</sub> is greater than the SAR limit (SAR<sub>1g</sub> 1.6 W/kg), SAR test exclusion is determined by the SPLSR.

b) SAR to Peak Location Separation Ratio

The simultaneous transmitting antennas in each operating mode and exposure condition combination are considered one pair at a time to determine the SPLSR.

$$SPLSR = (SAR_1 + SAR_2)^{1.5}/R_i$$

The ratio is rounded to two decimal digits, and must be  $\leq 0.04$  for all antenna pairs in the configuration to qualify for 1-g SAR test exclusion. When 10-g SAR applies, the ratio must be  $\leq 0.10$ .

$SAR_1$  and  $SAR_2$  are the highest reported or estimated SAR values for each antenna in the pair, and  $R_i$  is the separation distance in mm between the peak SAR locations for the antenna pair

$$\text{peak location separation distance} = \sqrt{(x_1 - x_2)^2 + (y_1 - y_2)^2 + (z_1 - z_2)^2}$$

Where  $(x_1, y_1, z_1)$  and  $(x_2, y_2, z_2)$  are the coordinates of the extrapolated peak SAR locations in the area or zoom scans.

When standalone test exclusion applies, SAR is estimated; the peak location is assumed to be at the feed-point or geometric center of the antenna. Due to curvatures on the SAM phantom, when SAR is estimated for one of the antennas in an antenna pair, the measured peak SAR location will be translated onto the test device to determine the peak location separation for the antenna pair.

When SAR is estimated for both antennas, the peak location separation should be determined by the closest physical separation of the antennas, according to the feed-point or geometric center of the antennas.

c) Volume Scan

When the SPLSR is  $\leq 0.04$  for 1-g SAR and  $\leq 0.10$  for 10-g SAR, the simultaneous transmission SAR is not required. Otherwise, the enlarged zoom scan and volume scan post-processing procedures will be performed.

### 4.7.2 Simultaneous Transmission Possibilities

The simultaneous transmission possibilities for this device are listed as below.

Simultaneous Transmission Configurations	Head (Voice / VoIP)	Body-worn (Voice / VoIP)	Hotspot (Data)
GSM (Voice / Data) + WLAN (Data)	Yes	Yes	Yes
WCDMA (Voice / Data) + WLAN (Data)	Yes	Yes	Yes
LTE (Data) + WLAN (Data)	Yes	Yes	Yes
GSM (Voice / Data) + BT (Data)	Yes	Yes	No
WCDMA (Voice / Data) + BT (Data)	Yes	Yes	No
LTE (Data) + BT (Data)	Yes	Yes	No

Note:

1. The 2.4G WLAN and 5G WLAN cannot transmit simultaneously.
2. The WLAN and Bluetooth cannot transmit simultaneously, so there is no co-location test requirement for WLAN and Bluetooth.



### 4.7.3 Max. Standalone SAR

#### WWAN

Position		GSM		WCDMA			LTE			
		850	1900	II	IV	V	2	4	5	12
Head	Right Cheek	0.68	0.19	0.18	0.17	0.50	0.17	0.17	0.43	0.15
	Right Tilted	0.37	0.08	0.09	0.07	0.25	0.08	0.08	0.23	0.09
	Left Cheek	0.63	0.13	0.16	0.18	0.46	0.16	0.22	0.39	0.11
	Left Tilted	0.36	0.06	0.07	0.05	0.24	0.07	0.08	0.24	0.06
Body-worn	Front Face	0.86	0.26	0.32	0.33	0.57	0.32	0.40	0.48	0.15
	Rear Face	1.12	0.44	0.51	0.47	0.66	0.49	0.55	0.58	0.20
Hotspot	Front Face	0.86	0.26	0.32	0.33	0.57	0.32	0.40	0.48	0.15
	Rear Face	1.12	0.44	0.51	0.47	0.66	0.49	0.55	0.58	0.20
	Left Side	0.00	0.00	0.00	0.00	0.00	0.00	0.00	0.00	0.00
	Right Side	1.11	0.11	0.13	0.12	0.52	0.14	0.15	0.47	0.19
	Top Side	0.00	0.00	0.00	0.00	0.00	0.00	0.00	0.00	0.00
	Bottom Side	0.31	0.44	0.51	0.46	0.22	0.56	0.72	0.17	0.04

#### WLAN & BT

Position		WLAN					BT
		2.4G	5.2G	5.3G	5.6G	5.8G	2.4G
Head	Right Cheek	0.63	0.06	N/A	0.27	1.02	0.12
	Right Tilted	0.47	0.07	N/A	0.28	1.05	0.12
	Left Cheek	0.28	0.04	N/A	0.16	0.60	0.12
	Left Tilted	0.23	0.04	N/A	0.17	0.62	0.12
Body-worn	Front Face	0.15	0.04	N/A	0.05	0.18	0.06
	Rear Face	0.19	0.08	N/A	0.03	0.09	0.06
Hotspot	Front Face	0.15	N/A	N/A	N/A	N/A	N/A
	Rear Face	0.19	N/A	N/A	N/A	N/A	N/A
	Left Side	0.11	N/A	N/A	N/A	N/A	N/A
	Right Side	0.00	N/A	N/A	N/A	N/A	N/A
	Top Side	0.09	N/A	N/A	N/A	N/A	N/A
	Bottom Side	0.00	N/A	N/A	N/A	N/A	N/A

### 4.7.4 Sum of SAR

#### WWAN + WLAN (DTS)

Position		Highest Simultaneous Transmission SAR	GSM		WCDMA			LTE			
			850	1900	II	IV	V	2	4	5	12
Head	Right Cheek	1.31	1.31	0.82	0.81	0.80	1.13	0.80	0.80	1.06	0.78
	Right Tilted		0.84	0.55	0.56	0.54	0.72	0.55	0.55	0.70	0.56
	Left Cheek		0.91	0.41	0.44	0.46	0.74	0.44	0.50	0.67	0.39
	Left Tilted		0.59	0.29	0.30	0.28	0.47	0.30	0.31	0.47	0.29
Body-worn	Front Face	1.31	1.01	0.41	0.47	0.48	0.72	0.47	0.55	0.63	0.30
	Rear Face		1.31	0.63	0.70	0.66	0.85	0.68	0.74	0.77	0.39
Hotspot	Front Face	1.31	1.01	0.41	0.47	0.48	0.72	0.47	0.55	0.63	0.30
	Rear Face		1.31	0.63	0.70	0.66	0.85	0.68	0.74	0.77	0.39
	Left Side		0.11	0.11	0.11	0.11	0.11	0.11	0.11	0.11	0.11
	Right Side		1.11	0.11	0.13	0.12	0.52	0.14	0.15	0.47	0.19
	Top Side		0.09	0.09	0.09	0.09	0.09	0.09	0.09	0.09	0.09
	Bottom Side		0.31	0.44	0.51	0.46	0.22	0.56	0.72	0.17	0.04

#### WWAN + WLAN(NII)

Position		Highest Simultaneous Transmission SAR	GSM		WCDMA			LTE			
			850	1900	II	IV	V	2	4	5	12
Head	Right Cheek	1.52	1.70	1.21	1.20	1.19	1.52	1.19	1.19	1.45	1.17
	Right Tilted		1.42	1.13	1.14	1.12	1.30	1.13	1.13	1.28	1.14
	Left Cheek		1.23	0.73	0.76	0.78	1.06	0.76	0.82	0.99	0.71
	Left Tilted		0.98	0.68	0.69	0.67	0.86	0.69	0.70	0.86	0.68
Body-worn	Front Face	1.21	1.04	0.44	0.50	0.51	0.75	0.50	0.58	0.66	0.33
	Rear Face		1.21	0.53	0.60	0.56	0.75	0.58	0.64	0.67	0.29

#### WWAN + BT(DSS)

Position		Highest Simultaneous Transmission SAR	GSM		WCDMA			LTE			
			850	1900	II	IV	V	2	4	5	12
Head	Right Cheek	0.80	0.80	0.31	0.30	0.29	0.62	0.29	0.29	0.55	0.27
	Right Tilted		0.49	0.20	0.21	0.19	0.37	0.20	0.20	0.35	0.21
	Left Cheek		0.75	0.25	0.28	0.30	0.58	0.28	0.34	0.51	0.23
	Left Tilted		0.48	0.18	0.19	0.17	0.36	0.19	0.20	0.36	0.18
Body-worn	Front Face	1.18	0.92	0.32	0.38	0.39	0.63	0.38	0.46	0.54	0.21
	Rear Face		1.18	0.50	0.57	0.53	0.72	0.55	0.61	0.64	0.26

### 4.7.5 SAR to Peak Location Separation Ratio Analysis

Band	Mode	Test Position	Ch.	SAR Value (W/kg)	Coordinates			Peak Location Separation Distance (Ri, mm)	SPLSR	Simultaneous Transmission SAR Test
					x	y	z			
GSM850	GPRS10	Right Cheek	251	0.68	43.0	36.9	-3.1	72.0	0.031	SPLSR < 0.04, Not required
802.11a	-		153	1.02	11.3	-27.7	-1.7			

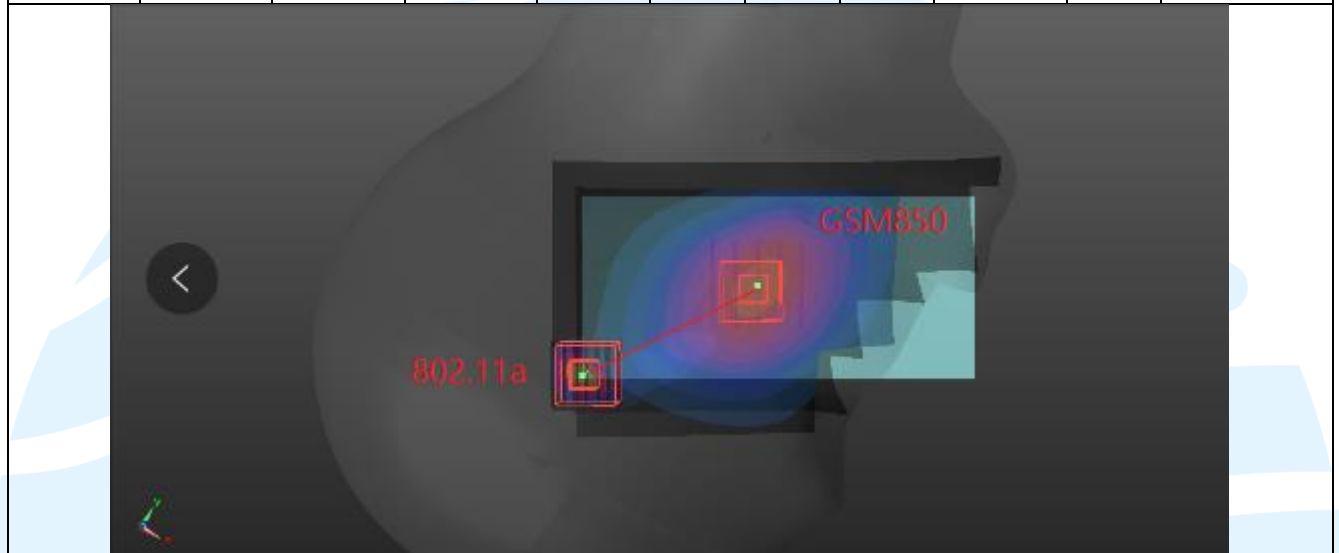

\*\*\* End of Report \*\*\*

The test report is effective only with both signature and specialized stamp. The result(s) shown in this report refer only to the sample(s) tested. Without written approval of UnionTrust, this report can't be reproduced except in full.



## **Appendix A. SAR Plots of System Verification**

The plots for system verification with largest deviation for each SAR system combination are shown as follows.



## Appendix B. SAR Plots of SAR Measurement

The SAR plots for highest measured SAR in each exposure configuration, wireless mode and frequency band combination, and measured SAR > 1.5 W/kg are shown as follows.



## **Appendix C. Calibration Certificate for Probe and Dipole**

The calibration certificates are shown as follows.



**Appendix D. Photographs of EUT and Setup**

