

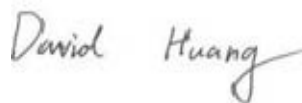

# RF TEST REPORT



Report No.: 16071234-FCC-R4

Supersede Report No.: N/A

Applicant	SMT TELECOMM HK LIMITED	
Product Name	Mobile Phone	
Model No.	X455	
Serial No.	N/A	
Test Standard	FCC Part 15.247: 2015, ANSI C63.10: 2013	
Test Date	October 28 to November 09, 2016	
Issue Date	November 10, 2016	
Test Result	<input checked="" type="checkbox"/> Pass <input type="checkbox"/> Fail	
Equipment complied with the specification	<input checked="" type="checkbox"/>	
Equipment did not comply with the specification	<input type="checkbox"/>	
		
Loren Luo Test Engineer	David Huang Checked By	
This test report may be reproduced in full only Test result presented in this test report is applicable to the tested sample only		

Issued by:

**SIEMIC (SHENZHEN-CHINA) LABORATORIES**

Zone A, Floor 1, Building 2 Wan Ye Long Technology Park

South Side of Zhoushi Road, Bao' an District, Shenzhen, Guangdong China 518108

Phone: +86 0755 2601 4629801 Email: [China@siemic.com.cn](mailto:China@siemic.com.cn)

## Laboratories Introduction

SIEMIC, headquartered in the heart of Silicon Valley, with superior facilities in US and Asia, is one of the leading independent testing and certification facilities providing customers with one-stop shop services for Compliance Testing and Global Certifications.



In addition to testing and certification, SIEMIC provides initial design reviews and compliance management throughout a project. Our extensive experience with China, Asia Pacific, North America, European, and International compliance requirements, assures the fastest, most cost effective way to attain regulatory compliance for the global markets.

### Accreditations for Conformity Assessment

Country/Region	Scope
USA	EMC, RF/Wireless, SAR, Telecom
Canada	EMC, RF/Wireless, SAR, Telecom
Taiwan	EMC, RF, Telecom, SAR, Safety
Hong Kong	RF/Wireless, SAR, Telecom
Australia	EMC, RF, Telecom, SAR, Safety
Korea	EMI, EMS, RF, SAR, Telecom, Safety
Japan	EMI, RF/Wireless, SAR, Telecom
Singapore	EMC, RF, SAR, Telecom
Europe	EMC, RF, SAR, Telecom, Safety

Test Report No.	16071234-FCC-R4
Page	3 of 40

This page has been left blank intentionally.

# CONTENTS

1. REPORT REVISION HISTORY .....	5
2. CUSTOMER INFORMATION .....	5
3. TEST SITE INFORMATION.....	5
4. EQUIPMENT UNDER TEST (EUT) INFORMATION .....	6
5. TEST SUMMARY.....	8
6. MEASUREMENTS, EXAMINATION AND DERIVED RESULTS .....	9
6.1 ANTENNA REQUIREMENT.....	9
6.2 DTS (6 DB) CHANNEL BANDWIDTH .....	10
6.3 MAXIMUM OUTPUT POWER .....	12
6.4 POWER SPECTRAL DENSITY.....	14
6.5 BAND-EDGE & UNWANTED EMISSIONS INTO RESTRICTED FREQUENCY BANDS .....	16
6.6 AC POWER LINE CONDUCTED EMISSIONS.....	19
6.7 RADIATED SPURIOUS EMISSIONS & RESTRICTED BAND .....	25
ANNEX A. TEST INSTRUMENT.....	31
ANNEX B. EUT AND TEST SETUP PHOTOGRAPHS.....	32
ANNEX C. TEST SETUP AND SUPPORTING EQUIPMENT.....	35
ANNEX D. USER MANUAL / BLOCK DIAGRAM / SCHEMATICS / PARTLIST .....	39
ANNEX E. DECLARATION OF SIMILARITY.....	40

## 1. Report Revision History

Report No.	Report Version	Description	Issue Date
16071234-FCC-R4	NONE	Original	November 10, 2016

## 2. Customer information

Applicant Name	SMT TELECOMM HK LIMITED
Applicant Add	Unit C 8/F, CHARMHILL CTR 50 HILLWOOD RD TST KL
Manufacturer	SMT TELECOMM HK LIMITED
Manufacturer Add	Unit C 8/F, CHARMHILL CTR 50 HILLWOOD RD TST KL

## 3. Test site information

Lab performing tests	SIEMIC (Shenzhen-China) LABORATORIES
Lab Address	Zone A, Floor 1, Building 2 Wan Ye Long Technology Park South Side of Zhoushi Road, Bao' an District, Shenzhen, Guangdong China 518108
FCC Test Site No.	718246
IC Test Site No.	4842E-1
Test Software	Radiated Emission Program-To Shenzhen v2.0

## 4. Equipment under Test (EUT) Information

Description of EUT:	Mobile Phone
Main Model:	X455
Serial Model:	N/A
Date EUT received:	October 27, 2016
Test Date(s):	October 28 to November 09, 2016
Equipment Category :	DTS
Antenna Gain:	GSM850: -1.3dBi PCS1900: -1.4dBi UMTS-FDD Band V: -1.1dBi UMTS-FDD Band II: -0.7dBi Bluetooth/WIFI/BLE: -1.5dBi
Antenna Type:	PIFA antenna
Type of Modulation:	GSM / GPRS: GMSK EGPRS: GMSK,8PSK UMTS-FDD: QPSK 802.11b/g/n: DSSS, OFDM Bluetooth: GFSK, $\pi$ /4DQPSK, 8DPSK BLE: GFSK
RF Operating Frequency (ies):	GSM850 TX: 824.2 ~ 848.8 MHz; RX: 869.2 ~ 893.8 MHz PCS1900 TX: 1850.2 ~ 1909.8 MHz; RX: 1930.2 ~ 1989.8 MHz UMTS-FDD Band V TX: 826.4 ~ 846.6 MHz; RX: 871.4 ~ 891.6 MHz UMTS-FDD Band II TX:1852.4 ~ 1907.6 MHz; RX: 1932.4 ~ 1987.6 MHz WIFI: 802.11b/g/n(20M): 2412-2462 MHz WIFI: 802.11n(40M): 2422-2452 MHz Bluetooth& BLE: 2402-2480 MHz
Max. Output Power:	-4.588dBm

Test Report No.	16071234-FCC-R4
Page	7 of 40

Number of Channels: GSM 850: 124CH  
PCS1900: 299CH  
UMTS-FDD Band V: 102CH  
UMTS-FDD Band II: 277CH  
WIFI :802.11b/g/n(20M): 11CH  
WIFI :802.11n(40M): 7CH  
Bluetooth: 79CH  
BLE: 40CH

Port: USB Port, Earphone Port

Trade Name : N/A

Input Power: Adapter:  
Model: PCX455  
Input: AC100-240V~50/60Hz,0.15A  
Output: DC 5.0V-500mA  
Battery:  
Model: BPX455  
Voltage: 3.7V  
Battery Capacity: 1300mAh(4.81Wh)  
Charging limit voltage: 4.2V

GPRS/EGPRS Multi-slot class: 8/10/12

FCC ID: 2AIMEX455

## 5. Test Summary

The product was tested in accordance with the following specifications.

All testing has been performed according to below product classification:

FCC Rules	Description of Test	Result
§15.203	Antenna Requirement	Compliance
§15.247 (a)(2)	DTS (6 dB) CHANNEL BANDWIDTH	Compliance
§15.247(b)(3)	Conducted Maximum Output Power	Compliance
§15.247(e)	Power Spectral Density	Compliance
§15.247(d)	Band-Edge & Unwanted Emissions into Restricted Frequency Bands	Compliance
§15.207 (a),	AC Power Line Conducted Emissions	Compliance
§15.205, §15.209, §15.247(d)	Radiated Spurious Emissions & Unwanted Emissions into Restricted Frequency Bands	Compliance

### Measurement Uncertainty

Emissions		
Test Item	Description	Uncertainty
Band Edge and Radiated Spurious Emissions	Confidence level of approximately 95% (in the case where distributions are normal), with a coverage factor of 2 (for EUTs < 0.5m X 0.5m X 0.5m)	+5.6dB/-4.5dB
-	-	-



## 6. Measurements, Examination And Derived Results

### 6.1 Antenna Requirement

#### Applicable Standard

According to § 15.203, an intentional radiator shall be designed to ensure that no antenna other than that furnished by the responsible party shall be used with the device. The use of a permanently attached antenna or of an antenna that uses a unique coupling to the intentional radiator shall be considered sufficient to comply with the provisions of this section. The manufacturer may design the unit so that a broken antenna can be replaced by the user, but the user of a standard antenna jack or electrical connector is prohibited. The structure and application of the EUT were analyzed to determine compliance with section §15.203 of the rules. §15.203 state that the subject device must meet the following criteria:

- a. Antenna must be permanently attached to the unit.
- b. Antenna must use a unique type of connector to attach to the EUT.

Unit must be professionally installed, and installer shall be responsible for verifying that the correct antenna is employed with the unit.

And according to FCC 47 CFR section 15.247 (b), if the transmitting antennas of directional gain greater than 6dBi are used, the power shall be reduced by the amount in dB that the directional gain of the antenna exceeds 6 dBi.

#### Antenna Connector Construction

The EUT has 2 antennas:

A permanently attached PIFA antenna for Bluetooth/WIFI/BLE, the gain is -1.5dBi for Bluetooth/WIFI/BLE.

A permanently attached PIFA antenna for GSM/PCS/UMTS, the gain is -1.3dBi for GSM850, -1.4dBi for PCS1900, -1.1dBi for UMTS-FDD Band V, -0.7dBi for UMTS-FDD Band II.

**The antenna meets up with the ANTENNA REQUIREMENT.**

**Result:** Compliance.

## 6.2 DTS (6 dB) Channel Bandwidth

Temperature	23°C
Relative Humidity	52%
Atmospheric Pressure	1010mbar
Test date :	November 10, 2016
Tested By :	Loren Luo

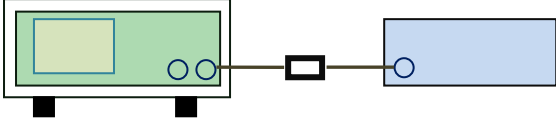
Spec	Item	Requirement	Applicable
§ 15.247(a)(2)	a)	6dB BW ≥ 500kHz;	<input checked="" type="checkbox"/>
RSS Gen(4.6.1)	b)	99% BW: For FCC reference only; required by IC.	<input checked="" type="checkbox"/>
Test Setup	 <p style="text-align: center;">Spectrum Analyzer                      EUT</p>		
Test Procedure	<p>558074 D01 DTS MEAS Guidance v03r03, 8.1 DTS bandwidth <u>6dB Emission bandwidth measurement procedure</u></p> <ul style="list-style-type: none"> <li>- Set RBW = 100 kHz.</li> <li>- Set the video bandwidth (VBW) ≥ 3 RBW.</li> <li>- Detector = Peak.</li> <li>- Trace mode = max hold.</li> <li>- Sweep = auto couple.</li> <li>- Allow the trace to stabilize.</li> </ul> <p>Measure the maximum width of the emission that is constrained by the frequencies associated with the two outermost amplitude points (upper and lower frequencies) that are attenuated by 6 dB relative to the maximum level measured in the fundamental emission.</p>		
Remark			
Result	<input checked="" type="checkbox"/> Pass <input type="checkbox"/> Fail		

Test Data     Yes                       N/A

Test Plot     Yes (See below)                       N/A

## 6dB Bandwidth measurement result

### Test Data

CH	Frequency (MHz)	6dB Bandwidth (kHz)	99% Occupied Bandwidth (MHz)
Low	2402	740.429	1.0592
Mid	2440	741.787	1.0548
High	2480	737.484	1.0547

### Test Plots

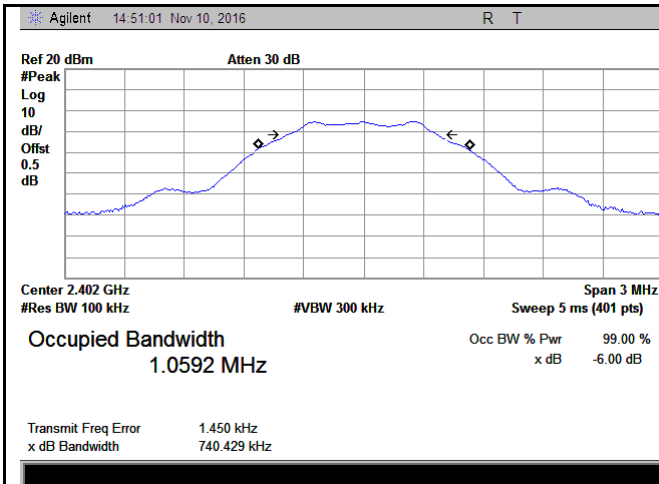

6dB Bandwidth - Low CH 2402

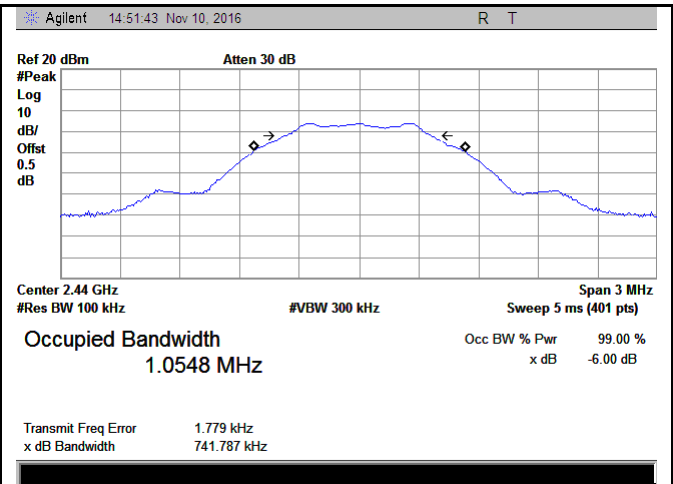

6dB Bandwidth - Mid CH 2440

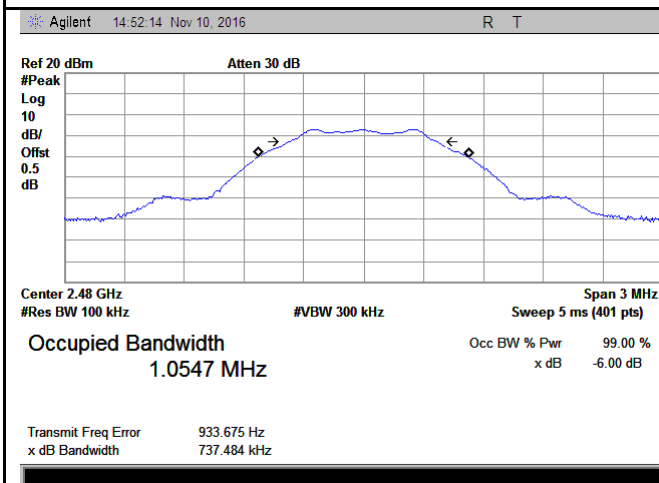

6dB Bandwidth - High CH 2480

### 6.3 Maximum Output Power

Temperature	23°C
Relative Humidity	52%
Atmospheric Pressure	1010mbar
Test date :	November 10, 2016
Tested By :	Loren Luo

#### Requirement(s):

Spec	Item	Requirement	Applicable
§15.247(b) (3),RSS210 (A8.4)	a)	FHSS in 2400-2483.5MHz with $\geq 75$ channels: $\leq 1$ Watt	<input type="checkbox"/>
	b)	FHSS in 5725-5850MHz: $\leq 1$ Watt	<input type="checkbox"/>
	c)	For all other FHSS in the 2400-2483.5MHz band: $\leq 0.125$ Watt.	<input type="checkbox"/>
	d)	FHSS in 902-928MHz with $\geq 50$ channels: $\leq 1$ Watt	<input type="checkbox"/>
	e)	FHSS in 902-928MHz with $\geq 25$ & $<50$ channels: $\leq 0.25$ Watt	<input type="checkbox"/>
	f)	DTS in 902-928MHz, 2400-2483.5MHz: $\leq 1$ Watt	<input checked="" type="checkbox"/>

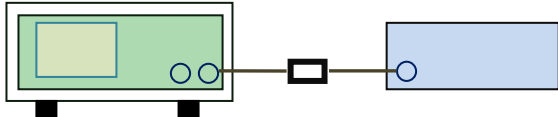
Test Setup	 <p style="text-align: center;">Spectrum Analyzer                      EUT</p>
------------	--

Test Procedure	<p>558074 D01 DTS MEAS Guidance v03r03, 9.1.2 Integrated band power method Maximum output power measurement procedure</p> <ol style="list-style-type: none"> <li>Set the RBW <math>\geq</math> DTS bandwidth.</li> <li>Set VBW <math>\geq 3 \times</math> RBW.</li> <li>Set span <math>\geq 3 \times</math> RBW</li> <li>Sweep time = auto couple.</li> <li>Detector = peak.</li> <li>Trace mode = max hold.</li> <li>Allow trace to fully stabilize.</li> <li>Use peak marker function to determine the peak amplitude level.</li> </ol>
----------------	---

Remark	
Result	<input checked="" type="checkbox"/> Pass <input type="checkbox"/> Fail

Test Data  Yes  N/A  
 Test Plot  Yes (See below)  N/A

**Output Power measurement result**

**Test Data**

Type	CH	Frequency (MHz)	Conducted Power (dBm)	Limit (dBm)	Result
Output power	Low	2402	-4.588	30	Pass
	Mid	2440	-5.321	30	Pass
	High	2480	-6.205	30	Pass

**Test Plots**

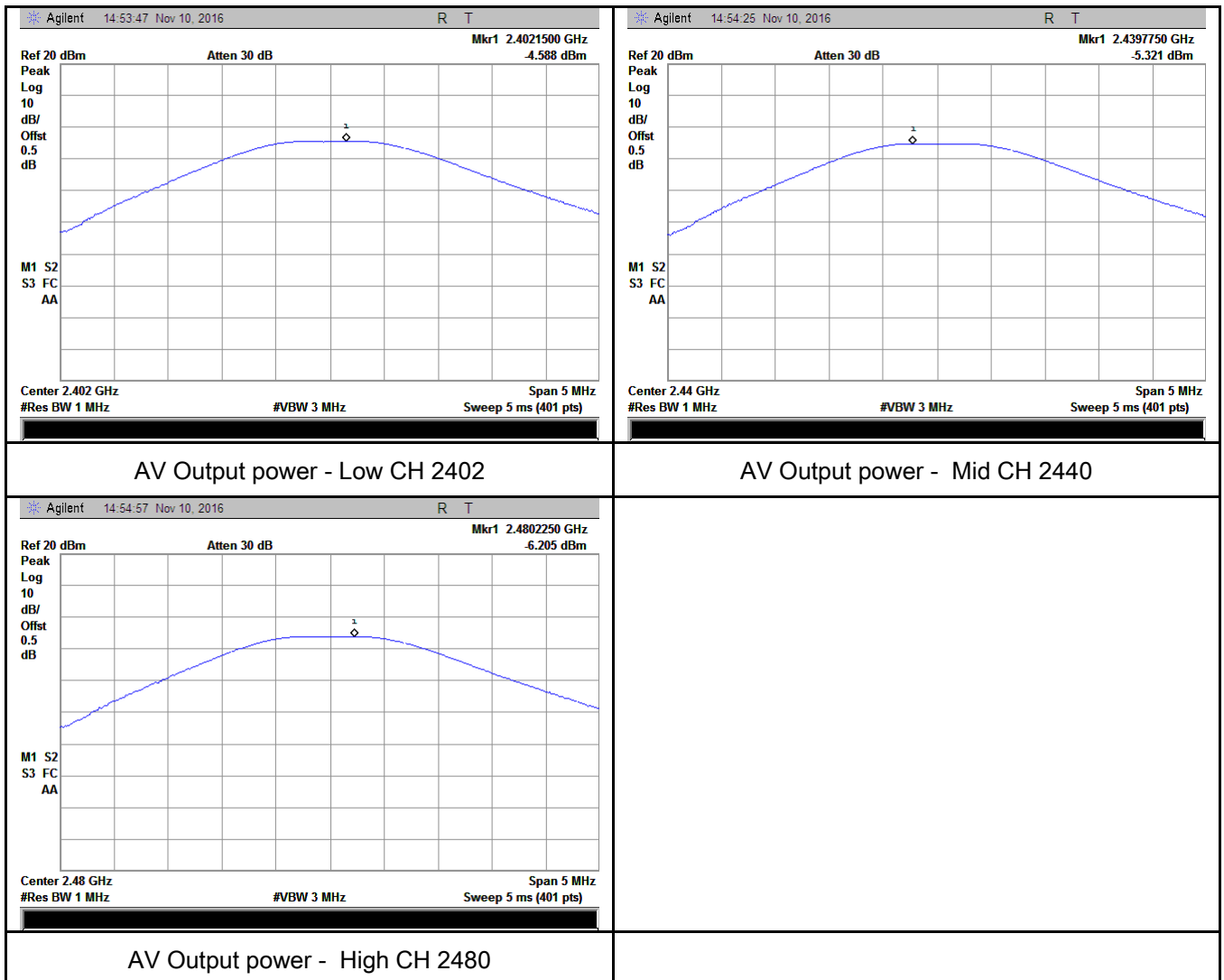

## 6.4 Power Spectral Density

Temperature	23°C
Relative Humidity	52%
Atmospheric Pressure	1010mbar
Test date :	November 10, 2016
Tested By :	Loren Luo

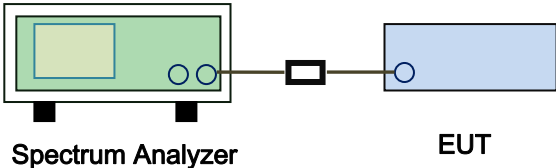
Spec	Item	Requirement	Applicable
§15.247(e)	a)	The power spectral density conducted from the intentional radiator to the antenna shall not be greater than 8 dBm in any 3 kHz band during any time interval of continuous transmission.	<input checked="" type="checkbox"/>
Test Setup	 <p style="text-align: center;">Spectrum Analyzer                      EUT</p>		
Test Procedure	<p>558074 D01 DTS MEAS Guidance v03r03, 10.2 power spectral density method power spectral density measurement procedure</p> <ul style="list-style-type: none"> <li>- a) Set analyzer center frequency to DTS channel center frequency.</li> <li>- b) Set the span to 1.5 times the DTS bandwidth.</li> <li>- c) Set the RBW to: <math>3 \text{ kHz} \leq \text{RBW} \leq 100 \text{ kHz}</math>.</li> <li>- d) Set the VBW <math>\geq 3 \times \text{RBW}</math>.</li> <li>- e) Detector = peak.</li> <li>- f) Sweep time = auto couple.</li> <li>- g) Trace mode = max hold.</li> <li>- h) Allow trace to fully stabilize.</li> <li>- i) Use the peak marker function to determine the maximum amplitude level within the RBW.</li> <li>- j) If measured value exceeds limit, reduce RBW (no less than 3 kHz) and repeat.</li> </ul>		
Remark			
Result	<input checked="" type="checkbox"/> Pass <input type="checkbox"/> Fail		

Test Data     Yes                       N/A  
 Test Plot     Yes (See below)                       N/A

**Power Spectral Density measurement result**

**Test Data**

Type	CH	Freq (MHz)	Reading (dBm)	Factor (dB)	Result (dBm)	Limit (dBm)	Result
PSD	Low	2402	-13.81	-5.23	-19.04	8	Pass
	Mid	2440	-14.47	-5.23	-19.70	8	Pass
	High	2480	-15.35	-5.23	-20.58	8	Pass

Note: factor=10log(3/10)=-5.23

**Test Plots**

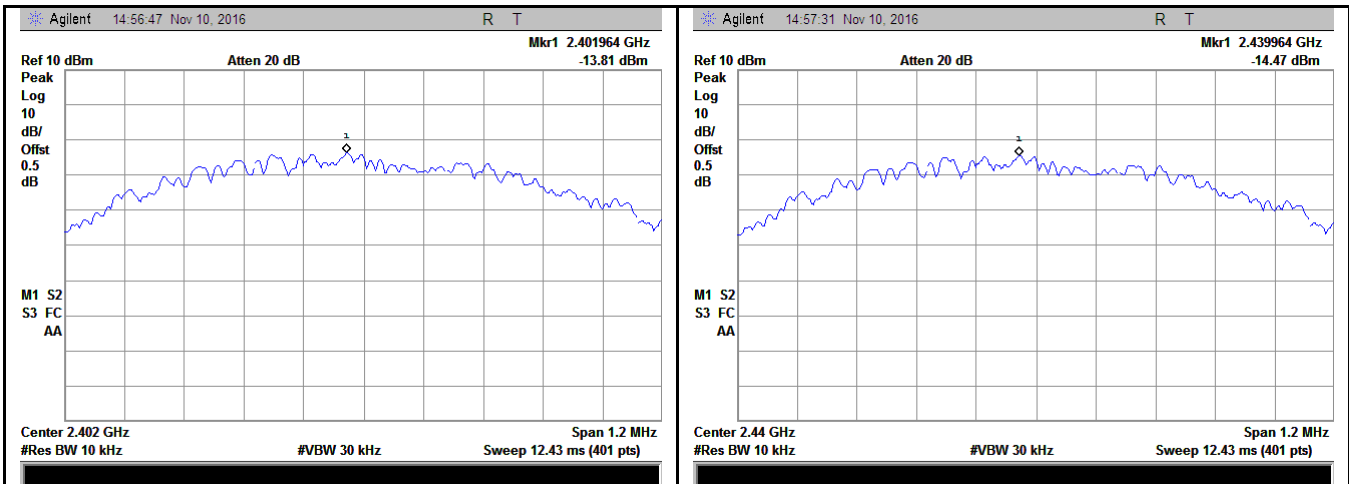

PSD - Low CH 2402

PSD - Mid CH 2440

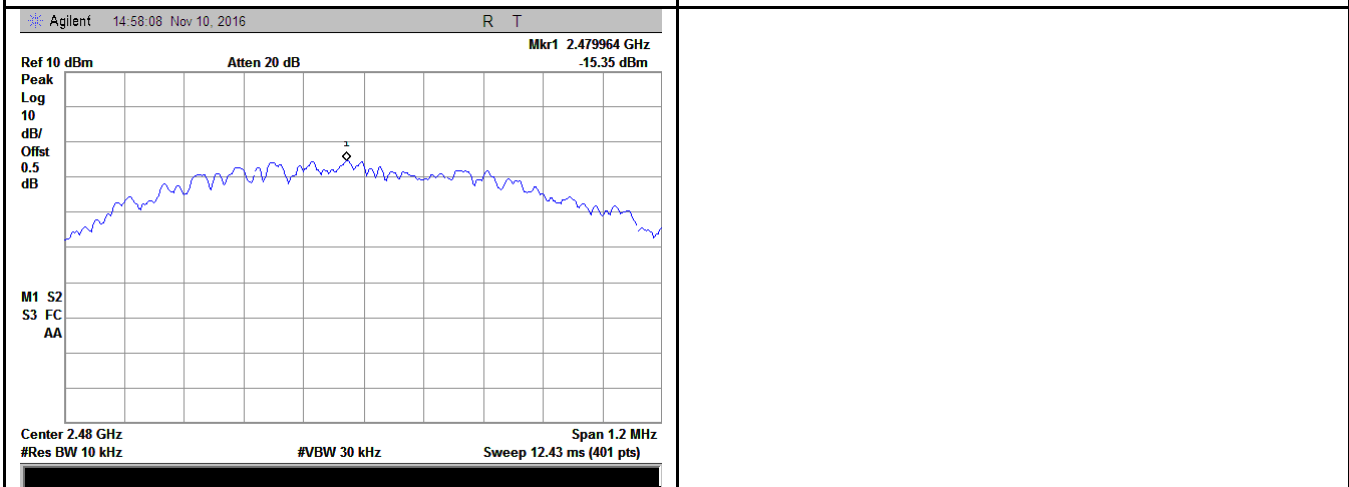

PSD - High CH 2480

## 6.5 Band-Edge & Unwanted Emissions into Restricted Frequency Bands

Temperature	24°C
Relative Humidity	59%
Atmospheric Pressure	1007mbar
Test date :	November 07, 2016
Tested By :	Loren Luo

### Requirement(s):

Spec	Item	Requirement	Applicable
§15.247(d)	a)	In any 100 kHz bandwidth outside the frequency band in which the spread spectrum or digitally modulated intentional radiator is operating, the radio frequency power that is produced by the intentional radiator shall be at least 20 dB below that in the 100 kHz bandwidth within the band that contains the highest level of the desired power, based on either an RF conducted or a radiated measurement, provided the transmitter demonstrates compliance with the peak conducted power limits.	<input checked="" type="checkbox"/>

Test Setup	
------------	--

Test Procedure	<p>Radiated Method Only</p> <ul style="list-style-type: none"> <li>- 1. Check the calibration of the measuring instrument using either an internal calibrator or a known signal from an external generator.</li> <li>- 2. Position the EUT without connection to measurement instrument. Put it on the Rotated table and turn on the EUT and make it operate in transmitting mode. Then set it to Low Channel and High Channel within its operating range, and make sure the instrument is operated in its linear range.</li> </ul>
----------------	---



Test Report No.	16071234-FCC-R4
Page	17 of 40

	<ul style="list-style-type: none"> <li>- 3. First, set both RBW and VBW of spectrum analyzer to 100 kHz with a convenient frequency span including 100kHz bandwidth from band edge, check the emission of EUT, if pass then set Spectrum Analyzer as below:           <ul style="list-style-type: none"> <li>a. The resolution bandwidth and video bandwidth of test receiver/spectrum analyzer is 120 kHz for Quasiy Peak detection at frequency below 1GHz.</li> <li>b. The resolution bandwidth of test receiver/spectrum analyzer is 1MHz and video bandwidth is 3MHz with Peak detection for Peak measurement at frequency above 1GHz.</li> <li>c. The resolution bandwidth of test receiver/spectrum analyzer is 1MHz and the video bandwidth is 10Hz with Peak detection for Average Measurement as below at frequency above 1GHz.</li> </ul> </li> <li>- 4. Measure the highest amplitude appearing on spectral display and set it as a reference level. Plot the graph with marking the highest point and edge frequency.</li> <li>- 5. Repeat above procedures until all measured frequencies were complete.</li> </ul>
Remark	
Result	<input checked="" type="checkbox"/> Pass <input type="checkbox"/> Fail

Test Data     Yes                       N/A  
 Test Plot      Yes (See below)             N/A

**Test Plots**

**Band Edge measurement result**

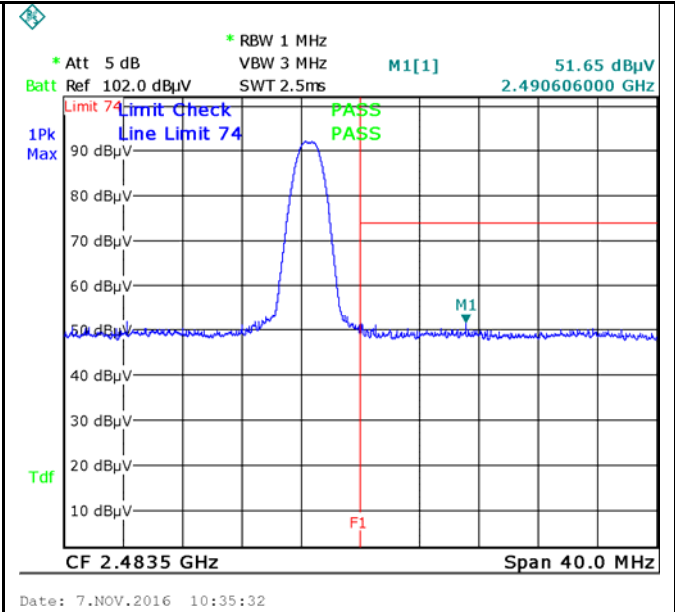
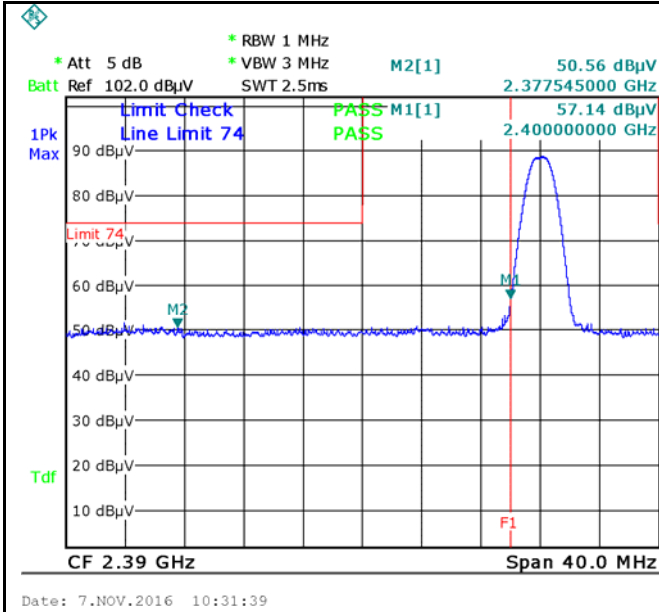

Band Edge, Left Side (Peak)

Note: F1 is frequency 2390MHz; F2 is frequency 2400MHz

Band Edge, Right Side (Peak)

Note: F1 is frequency 2483.5MHz

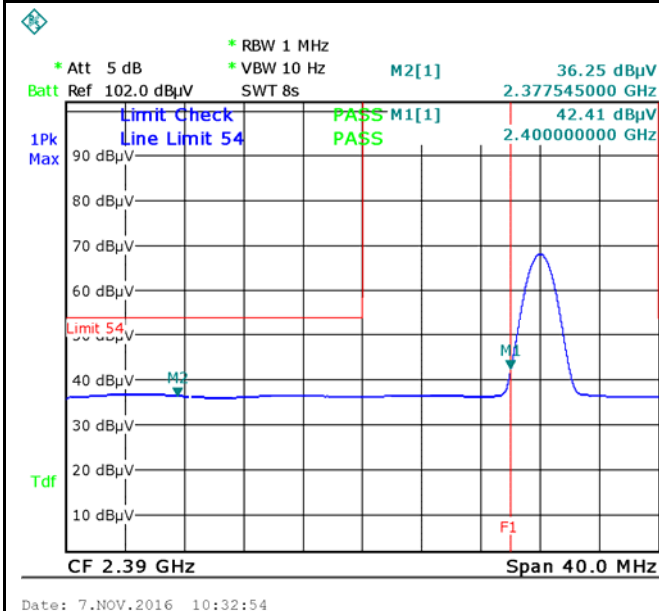

Note: (no need if PK value less than the AV limit)

Band Edge, Left Side-AV

Band Edge, Right Side-AV

## 6.6 AC Power Line Conducted Emissions

Temperature	24°C
Relative Humidity	59%
Atmospheric Pressure	1007mbar
Test date :	November 07, 2016
Tested By :	Loren Luo

### Requirement(s):

Spec	Item	Requirement	Applicable														
47CFR§15.207, RSS210 (A8.1)	a)	For Low-power radio-frequency devices that is designed to be connected to the public utility (AC) power line, the radio frequency voltage that is conducted back onto the AC power line on any frequency or frequencies, within the band 150 kHz to 30 MHz, shall not exceed the limits in the following table, as measured using a 50 [μ] H/50 ohms line impedance stabilization network (LISN). The lower limit applies at the boundary between the frequencies ranges.	<input checked="" type="checkbox"/>														
		<table border="1"> <thead> <tr> <th rowspan="2">Frequency ranges (MHz)</th> <th colspan="2">Limit (dBμV)</th> </tr> <tr> <th>QP</th> <th>Average</th> </tr> </thead> <tbody> <tr> <td>0.15 ~ 0.5</td> <td>66 – 56</td> <td>56 – 46</td> </tr> <tr> <td>0.5 ~ 5</td> <td>56</td> <td>46</td> </tr> <tr> <td>5 ~ 30</td> <td>60</td> <td>50</td> </tr> </tbody> </table>		Frequency ranges (MHz)	Limit (dBμV)		QP	Average	0.15 ~ 0.5	66 – 56	56 – 46	0.5 ~ 5	56	46	5 ~ 30	60	50
		Frequency ranges (MHz)			Limit (dBμV)												
				QP	Average												
0.15 ~ 0.5	66 – 56	56 – 46															
0.5 ~ 5	56	46															
5 ~ 30	60	50															

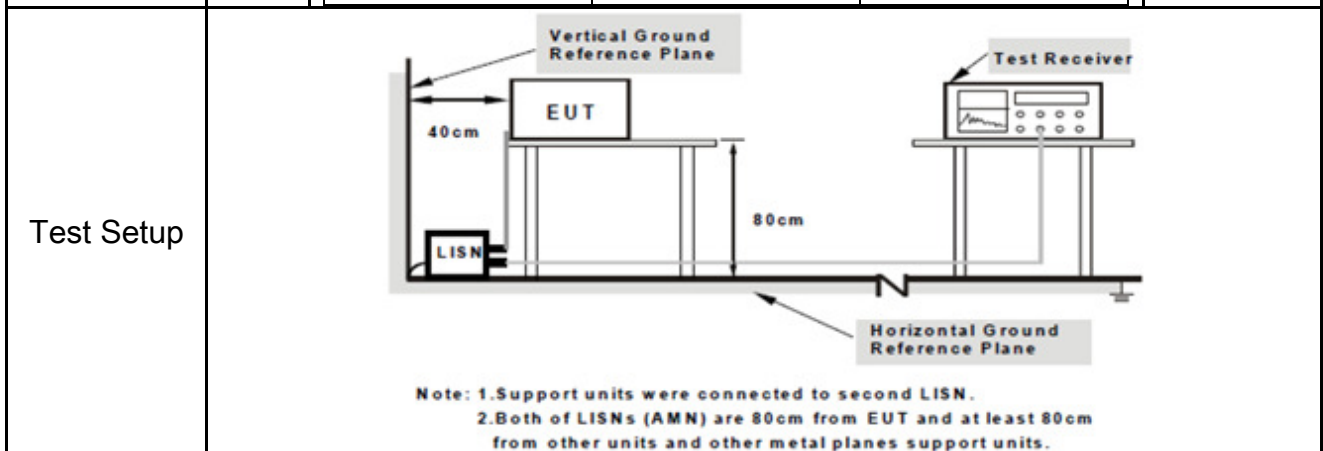

Procedure	<ol style="list-style-type: none"> <li>The EUT and supporting equipment were set up in accordance with the requirements of the standard on top of a 1.5m x 1m x 0.8m high, non-metallic table.</li> <li>The power supply for the EUT was fed through a 50W/50mH EUT LISN, connected to filtered mains.</li> <li>The RF OUT of the EUT LISN was connected to the EMI test receiver via a low-loss</li> </ol>
-----------	---

Test Report No.	16071234-FCC-R4
Page	20 of 40

	<p>coaxial cable.</p> <ol style="list-style-type: none"> <li>4. All other supporting equipment were powered separately from another main supply.</li> <li>5. The EUT was switched on and allowed to warm up to its normal operating condition.</li> <li>6. A scan was made on the NEUTRAL line (for AC mains) or Earth line (for DC power) over the required frequency range using an EMI test receiver.</li> <li>7. High peaks, relative to the limit line, The EMI test receiver was then tuned to the selected frequencies and the necessary measurements made with a receiver bandwidth setting of 10 kHz.</li> <li>8. Step 7 was then repeated for the LIVE line (for AC mains) or DC line (for DC power).</li> </ol>
Remark	
Result	<input checked="" type="checkbox"/> Pass <input type="checkbox"/> Fail

Test Data     Yes                       N/A

Test Plot     Yes (See below)             N/A

**Test Mode:** Transmitting Mode

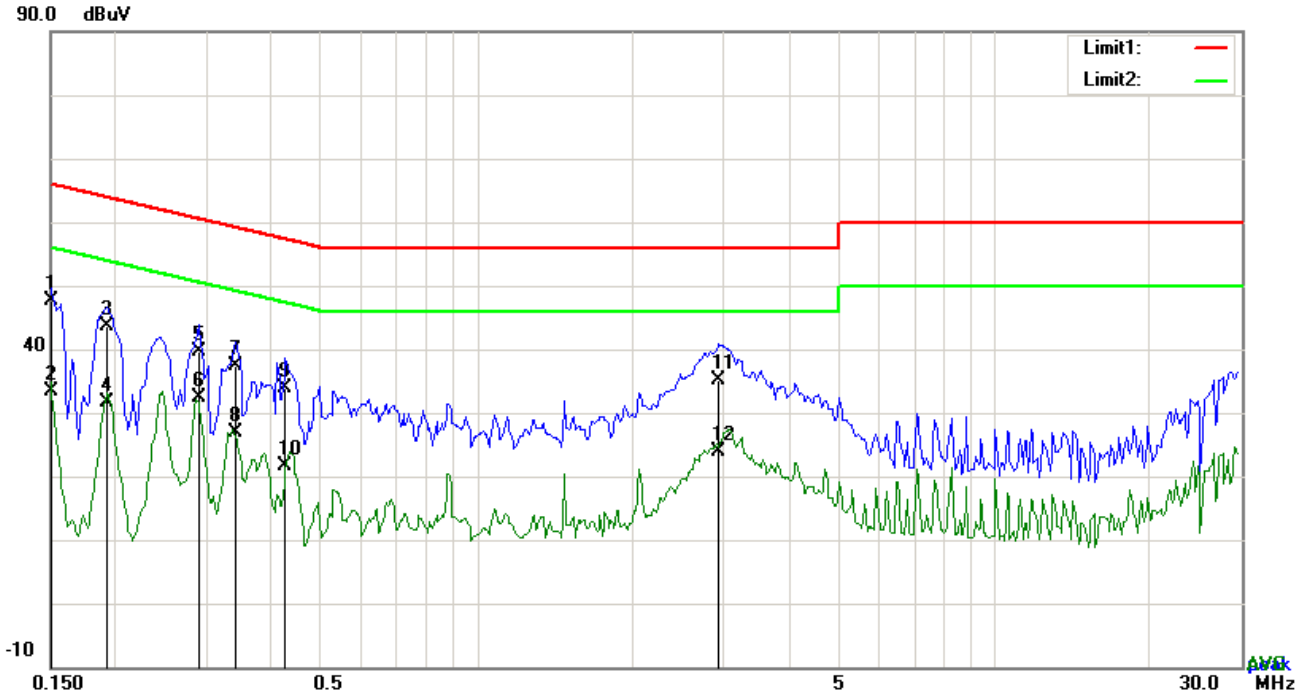

**Test Data**

**Phase Line Plot at 120Vac, 60Hz**

No.	P/L	Frequency (MHz)	Reading (dBµV)	Detector	Corrected (dB)	Result (dBµV)	Limit (dBµV)	Margin (dB)
1	L1	0.1500	37.53	QP	10.03	47.56	66.00	-18.44
2	L1	0.1500	23.36	AVG	10.03	33.39	56.00	-22.61
3	L1	0.1929	33.68	QP	10.03	43.71	63.91	-20.20
4	L1	0.1929	21.62	AVG	10.03	31.65	53.91	-22.26
5	L1	0.2904	29.67	QP	10.03	39.70	60.51	-20.81
6	L1	0.2904	22.36	AVG	10.03	32.39	50.51	-18.12
7	L1	0.3411	27.23	QP	10.03	37.26	59.18	-21.92
8	L1	0.3411	16.78	AVG	10.03	26.81	49.18	-22.37
9	L1	0.4269	23.74	QP	10.03	33.77	57.31	-23.54
10	L1	0.4269	11.55	AVG	10.03	21.58	47.31	-25.73
11	L1	2.9307	25.17	QP	10.05	35.22	56.00	-20.78
12	L1	2.9307	13.87	AVG	10.05	23.92	46.00	-22.08

<b>Test Mode:</b>	<b>Transmitting Mode</b>
-------------------	--------------------------

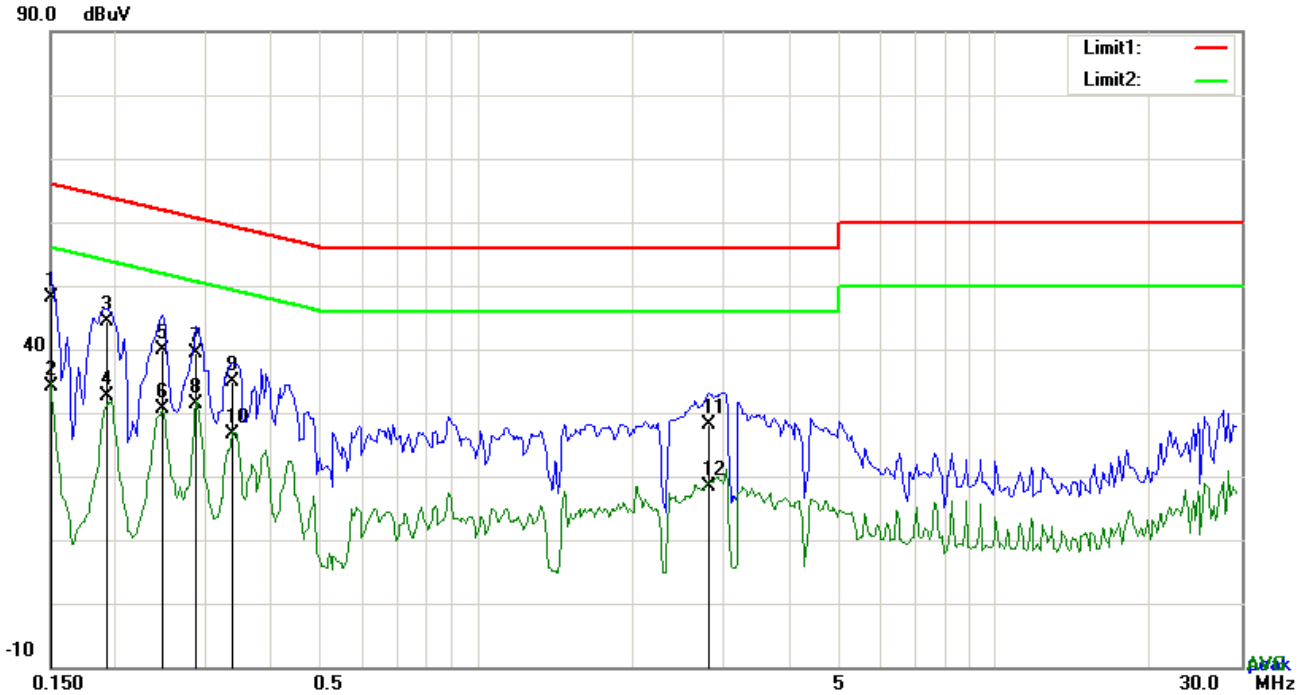

**Test Data**

**Phase Neutral Plot at 120Vac, 60Hz**

No.	P/L	Frequency (MHz)	Reading (dBμV)	Detector	Corrected (dB)	Result (dBμV)	Limit (dBμV)	Margin (dB)
1	N	0.1500	38.12	QP	10.02	48.14	66.00	-17.86
2	N	0.1500	24.12	AVG	10.02	34.14	56.00	-21.86
3	N	0.1929	34.48	QP	10.02	44.50	63.91	-19.41
4	N	0.1929	22.62	AVG	10.02	32.64	53.91	-21.27
5	N	0.2475	29.97	QP	10.02	39.99	61.84	-21.85
6	N	0.2475	20.50	AVG	10.02	30.52	51.84	-21.32
7	N	0.2865	29.33	QP	10.02	39.35	60.63	-21.28
8	N	0.2865	21.39	AVG	10.02	31.41	50.63	-19.22
9	N	0.3372	24.80	QP	10.02	34.82	59.27	-24.45
10	N	0.3372	16.73	AVG	10.02	26.75	49.27	-22.52
11	N	2.8059	18.10	QP	10.05	28.15	56.00	-27.85
12	N	2.8059	8.31	AVG	10.05	18.36	46.00	-27.64

**Test Mode:** Transmitting Mode

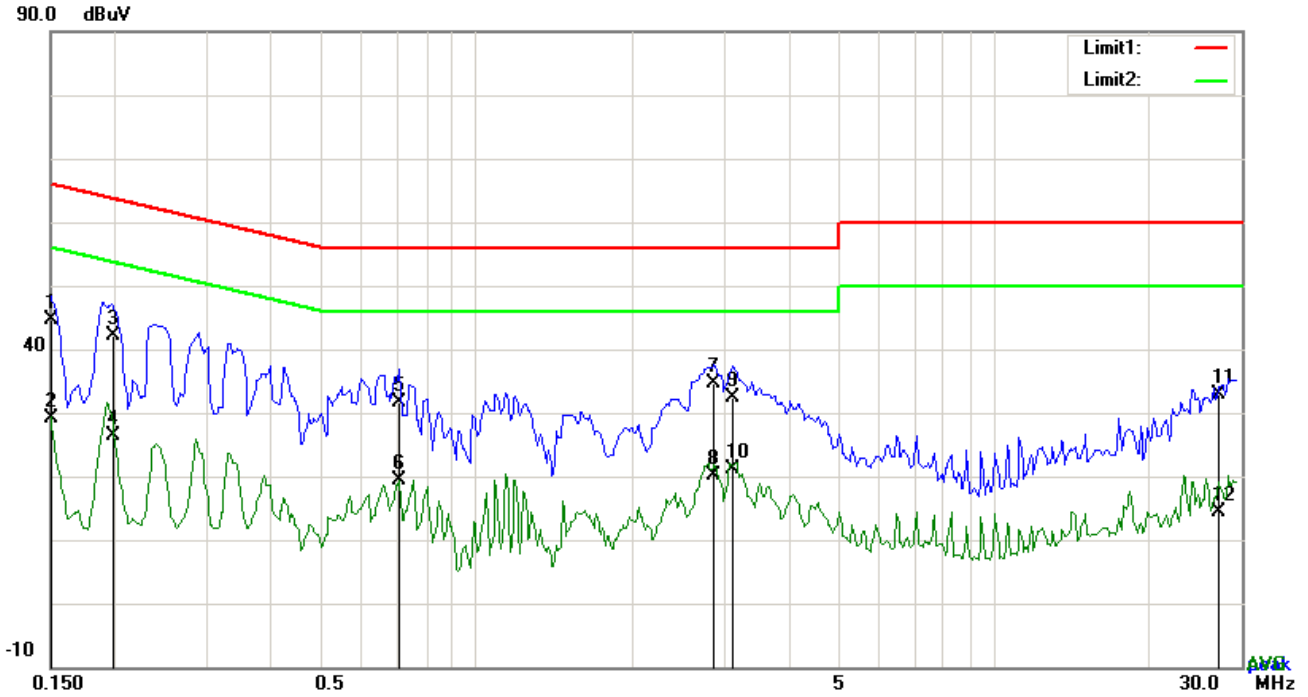

**Test Data**

**Phase Line Plot at 240Vac, 60Hz**

No.	P/L	Frequency (MHz)	Reading (dBµV)	Detector	Corrected (dB)	Result (dBµV)	Limit (dBµV)	Margin (dB)
1	L1	0.1500	34.59	QP	10.03	44.62	66.00	-21.38
2	L1	0.1500	19.10	AVG	10.03	29.13	56.00	-26.87
3	L1	0.1986	32.15	QP	10.03	42.18	63.67	-21.49
4	L1	0.1986	16.37	AVG	10.03	26.40	53.67	-27.27
5	L1	0.7077	21.54	QP	10.03	31.57	56.00	-24.43
6	L1	0.7077	9.36	AVG	10.03	19.39	46.00	-26.61
7	L1	2.8800	24.56	QP	10.05	34.61	56.00	-21.39
8	L1	2.8800	10.12	AVG	10.05	20.17	46.00	-25.83
9	L1	3.1209	22.20	QP	10.06	32.26	56.00	-23.74
10	L1	3.1209	10.97	AVG	10.06	21.03	46.00	-24.97
11	L1	27.1270	22.48	QP	10.44	32.92	60.00	-27.08
12	L1	27.1270	3.96	AVG	10.44	14.40	50.00	-35.60

<b>Test Mode:</b>	<b>Transmitting Mode</b>
-------------------	--------------------------

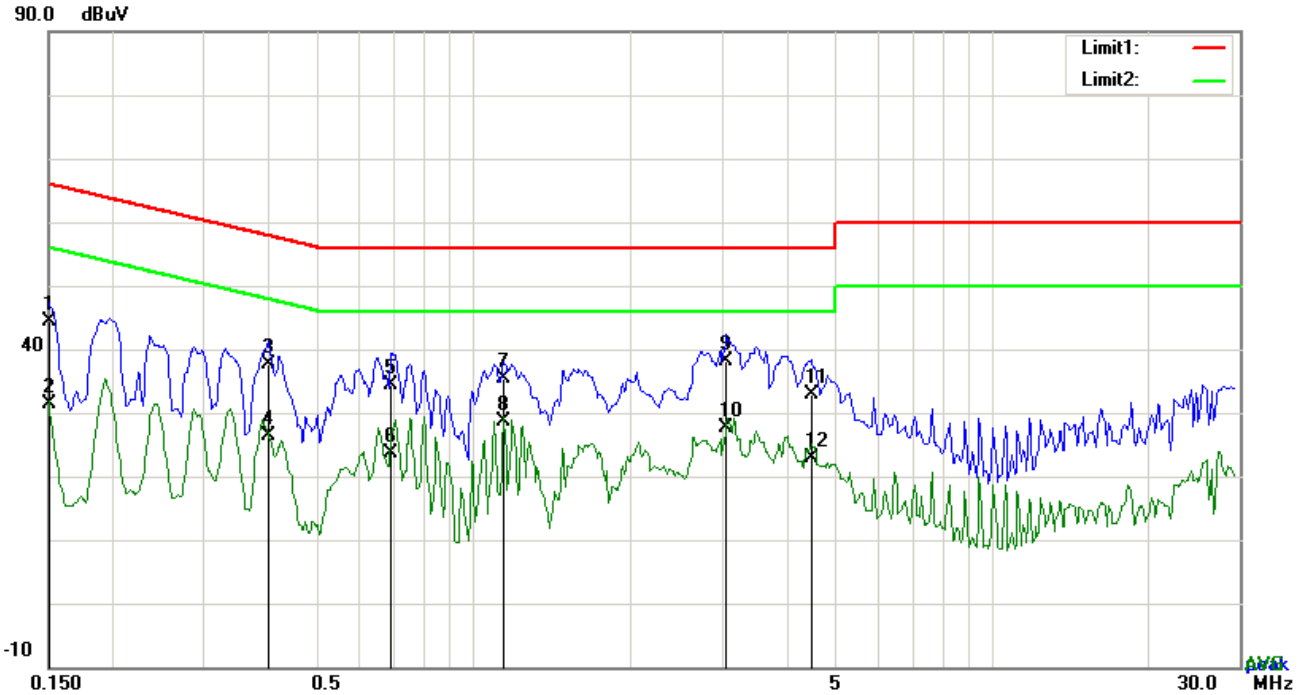

**Test Data**

**Phase Neutral Plot at 240Vac, 60Hz**

No.	P/L	Frequency (MHz)	Reading (dBμV)	Detector	Corrected (dB)	Result (dBμV)	Limit (dBμV)	Margin (dB)
1	N	0.1500	34.29	QP	10.02	44.31	66.00	-21.69
2	N	0.1500	21.26	AVG	10.02	31.28	56.00	-24.72
3	N	0.3996	27.53	QP	10.02	37.55	57.86	-20.31
4	N	0.3996	16.48	AVG	10.02	26.50	47.86	-21.36
5	N	0.6882	24.33	QP	10.02	34.35	56.00	-21.65
6	N	0.6882	13.69	AVG	10.02	23.71	46.00	-22.29
7	N	1.1367	25.35	QP	10.03	35.38	56.00	-20.62
8	N	1.1367	18.59	AVG	10.03	28.62	46.00	-17.38
9	N	3.0624	28.00	QP	10.05	38.05	56.00	-17.95
10	N	3.0624	17.52	AVG	10.05	27.57	46.00	-18.43
11	N	4.4547	22.91	QP	10.06	32.97	56.00	-23.03
12	N	4.4547	12.79	AVG	10.06	22.85	46.00	-23.15



## 6.7 Radiated Spurious Emissions & Restricted Band

Temperature	24°C
Relative Humidity	59%
Atmospheric Pressure	1007mbar
Test date :	November 07, 2016
Tested By :	Loren Luo

### Requirement(s):

Spec	Item	Requirement	Applicable										
47CFR§15.247(d), RSS210 (A8.5)	a)	<p>Except higher limit as specified elsewhere in other section, the emissions from the low-power radio-frequency devices shall not exceed the field strength levels specified in the following table and the level of any unwanted emissions shall not exceed the level of the fundamental emission. The tighter limit applies at the band edges</p> <table border="1"> <thead> <tr> <th>Frequency range (MHz)</th> <th>Field Strength (µV/m)</th> </tr> </thead> <tbody> <tr> <td>30 – 88</td> <td>100</td> </tr> <tr> <td>88 – 216</td> <td>150</td> </tr> <tr> <td>216 - 960</td> <td>200</td> </tr> <tr> <td>Above 960</td> <td>500</td> </tr> </tbody> </table>	Frequency range (MHz)	Field Strength (µV/m)	30 – 88	100	88 – 216	150	216 - 960	200	Above 960	500	<input checked="" type="checkbox"/>
	Frequency range (MHz)	Field Strength (µV/m)											
	30 – 88	100											
88 – 216	150												
216 - 960	200												
Above 960	500												
b)	<p>For non-restricted band, In any 100 kHz bandwidth outside the frequency band in which the spread spectrum or digitally modulated intentional radiator is operating, the radio frequency power that is produced by the intentional radiator shall be at least 20 dB or 30dB below that in the 100 kHz bandwidth within the band that contains the highest level of the desired power, determined by the measurement method on output power to be used. Attenuation below the general limits specified in § 15.209(a) is not required</p> <p><input checked="" type="checkbox"/> 20 dB down      <input type="checkbox"/> 30 dB down</p>	<input checked="" type="checkbox"/>											
c)	<p>or restricted band, emission must also comply with the radiated emission limits specified in 15.209</p>	<input checked="" type="checkbox"/>											

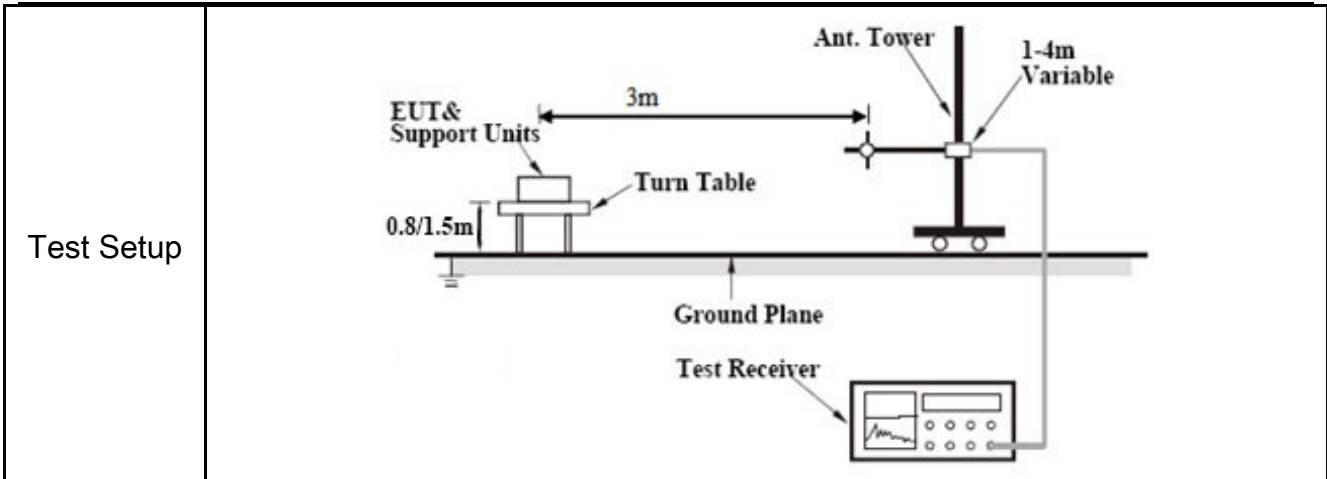

- Procedure**
1. The EUT was switched on and allowed to warm up to its normal operating condition.
  2. The test was carried out at the selected frequency points obtained from the EUT characterization. Maximization of the emissions, was carried out by rotating the EUT, changing the antenna polarization, and adjusting the antenna height in the following manner:
    - a. Vertical or horizontal polarization (whichever gave the higher emission level over a full rotation of the EUT) was chosen.
    - b. The EUT was then rotated to the direction that gave the maximum emission.
    - c. Finally, the antenna height was adjusted to the height that gave the maximum emission.
  3. The resolution bandwidth and video bandwidth of test receiver/spectrum analyzer is 120 kHz for Quasiy Peak detection at frequency below 1GHz.
  4. The resolution bandwidth of test receiver/spectrum analyzer is 1MHz and video bandwidth is 3MHz with Peak detection for Peak measurement at frequency above 1GHz.  
 The resolution bandwidth of test receiver/spectrum analyzer is 1MHz and the video bandwidth is 10Hz with Peak detection for Average Measurement as below at frequency above 1GHz.
  5. Steps 2 and 3 were repeated for the next frequency point, until all selected frequency points were measured.

**Remark** Different RF configuration has been evaluated but not much difference was found. The data presented here is the worst case data with EUT under 802.11n – HT20-2437MHz mode.

**Result**  Pass  Fail

**Test Data**  Yes  N/A

**Test Plot**  Yes (See below)  N/A

**Test Mode: Transmitting Mode**

**Below 1GHz**

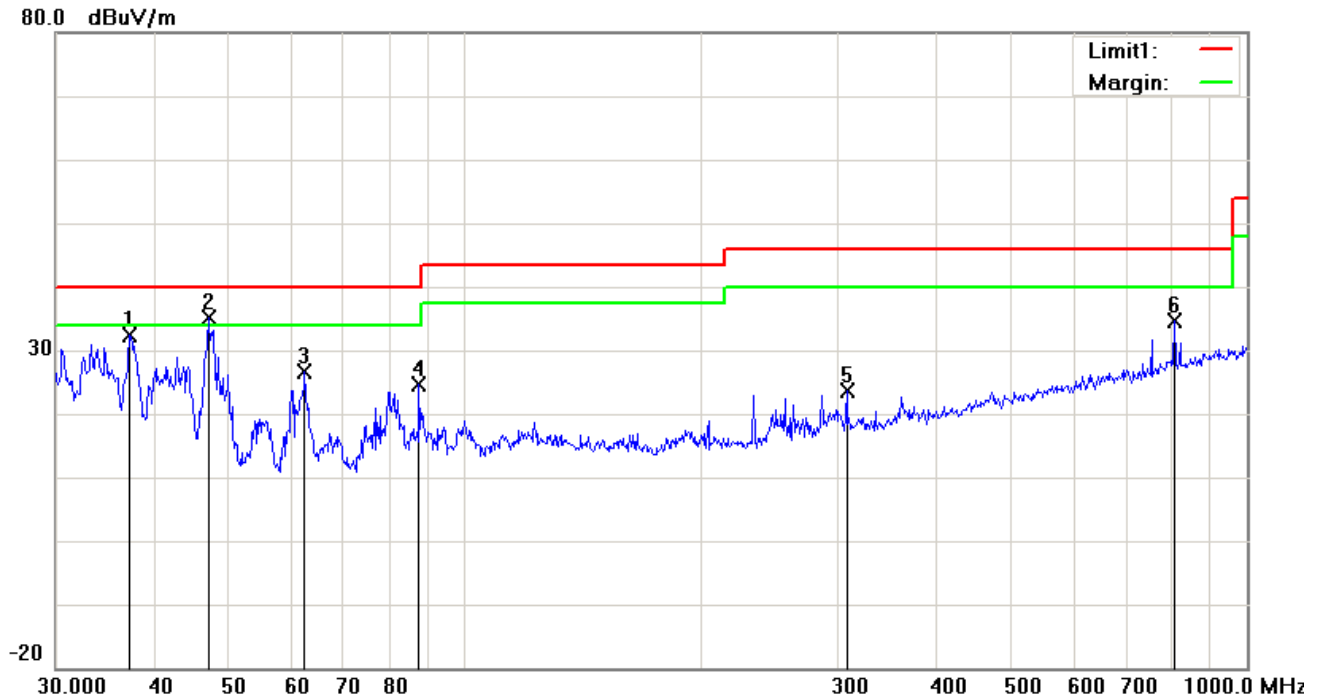

**Test Data**

**Vertical Polarity Plot @3m**

No	P/L	Frequency (MHz)	Reading (dBµV)	Detector	Corrected (dB)	Result (dBµV)	Limit (dBµV)	Margin (dB)	Height	Degree
1	H	37.2855	38.09	peak	-5.61	32.48	40.00	-7.52	100	216
2	H	46.9948	46.93	QP	-11.84	35.09	40.00	-4.91	100	55
3	H	62.4314	40.82	peak	-14.17	26.65	40.00	-13.35	100	338
4	H	87.4177	37.95	peak	-13.44	24.51	40.00	-15.49	100	140
5	H	307.8313	30.20	peak	-6.68	23.52	46.00	-22.48	100	61
6	H	807.4291	31.22	peak	3.30	34.52	46.00	-11.48	200	134

**Below 1GHz**

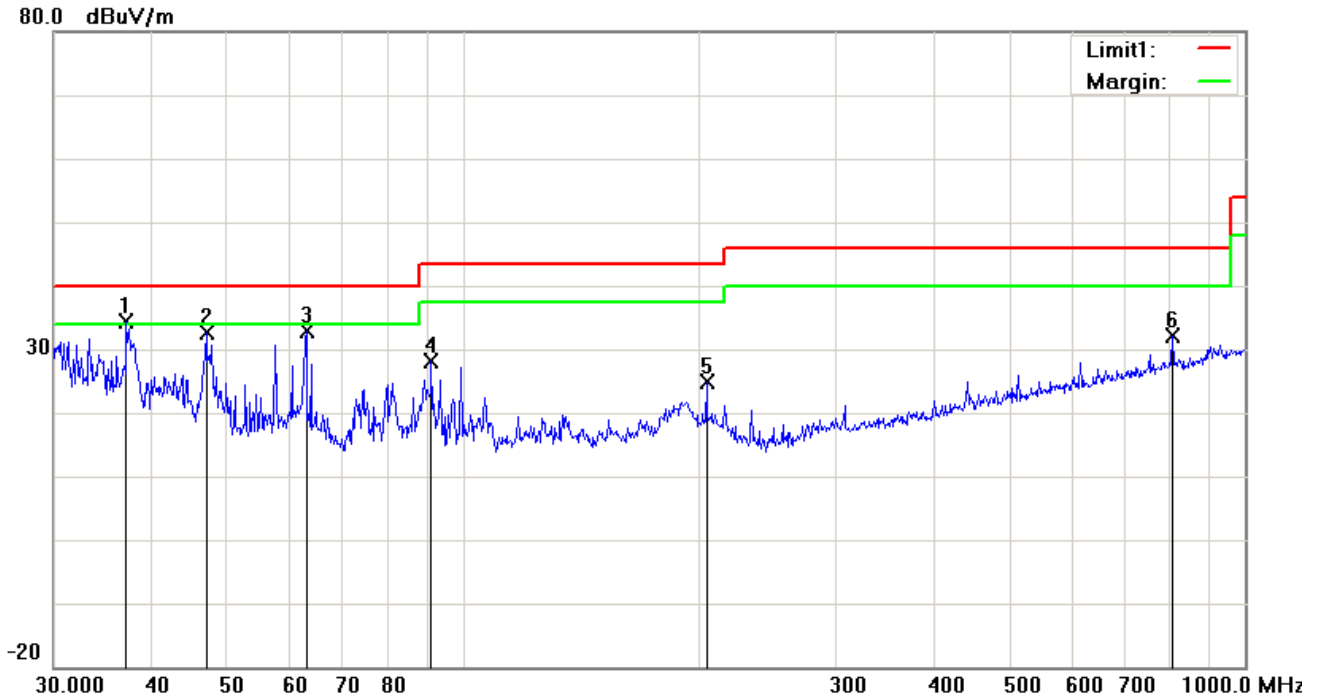

**Test Data**

**Horizontal Polarity Plot @3m**

No	P/L	Frequency (MHz)	Reading (dBμV)	Detector	Corrected (dB)	Result (dBμV)	Limit (dBμV)	Margin (dB)	Height	Degree
1	V	37.1550	39.82	QP	-5.51	34.31	40.00	-5.69	100	132
2	V	46.9948	44.57	peak	-11.84	32.73	40.00	-7.27	100	155
3	V	63.0916	46.95	peak	-14.12	32.83	40.00	-7.17	100	84
4	V	91.1746	41.26	peak	-13.08	28.18	43.50	-15.32	100	67
5	V	204.9551	33.60	peak	-8.78	24.82	43.50	-18.68	100	204
6	V	807.4291	28.77	peak	3.30	32.07	46.00	-13.93	100	219

### Above 1GHz

<b>Test Mode:</b>	<b>Transmitting Mode</b>
-------------------	--------------------------

#### Low Channel (2402 MHz)

Frequency (MHz)	S.A. Reading (dB $\mu$ V)	Detector (PK/AV)	Polarity (H/V)	Ant. Factor (dB/m)	Cable Loss (dB)	Pre-Amp. Gain (dB)	Cord. Amp. (dB $\mu$ V/m)	Limit (dB $\mu$ V/m)	Margin (dB)
4804	38.65	AV	V	33.83	6.86	31.72	47.62	54	-6.38
4804	38.29	AV	H	33.83	6.86	31.72	47.26	54	-6.74
4804	48.22	PK	V	33.83	6.86	31.72	57.19	74	-16.81
4804	47.81	PK	H	33.83	6.86	31.72	56.78	74	-17.22
17769	24.62	AV	V	45.03	11.21	32.38	48.48	54	-5.52
17769	24.37	AV	H	45.03	11.21	32.38	48.23	54	-5.77
17769	40.98	PK	V	45.03	11.21	32.38	64.84	74	-9.16
17769	40.55	PK	H	45.03	11.21	32.38	64.41	74	-9.59

#### Middle Channel (2440 MHz)

Frequency (MHz)	S.A. Reading (dB $\mu$ V)	Detector (PK/AV)	Polarity (H/V)	Ant. Factor (dB/m)	Cable Loss (dB)	Pre-Amp. Gain (dB)	Cord. Amp. (dB $\mu$ V/m)	Limit (dB $\mu$ V/m)	Margin (dB)
4880	38.73	AV	V	33.86	6.82	31.82	47.59	54	-6.41
4880	38.46	AV	H	33.86	6.82	31.82	47.32	54	-6.68
4880	48.57	PK	V	33.86	6.82	31.82	57.43	74	-16.57
4880	47.85	PK	H	33.86	6.82	31.82	56.71	74	-17.29
17814	24.08	AV	V	45.15	11.18	32.41	48	54	-6.00
17814	23.98	AV	H	45.15	11.18	32.41	47.9	54	-6.10
17814	41.32	PK	V	45.15	11.18	32.41	65.24	74	-8.76
17814	40.84	PK	H	45.15	11.18	32.41	64.76	74	-9.24

**High Channel (2480 MHz)**

Frequency (MHz)	S.A. Reading (dB $\mu$ V)	Detector (PK/AV)	Polarity (H/V)	Ant. Factor (dB/m)	Cable Loss (dB)	Pre-Amp. Gain (dB)	Cord. Amp. (dB $\mu$ V/m)	Limit (dB $\mu$ V/m)	Margin (dB)
4960	38.77	AV	V	33.9	6.76	31.92	47.51	54	-6.49
4960	38.5	AV	H	33.9	6.76	31.92	47.24	54	-6.76
4960	48.25	PK	V	33.9	6.76	31.92	56.99	74	-17.01
4960	47.96	PK	H	33.9	6.76	31.92	56.7	74	-17.3
17783	24.73	AV	V	45.22	11.35	32.38	48.92	54	-5.08
17783	24.35	AV	H	45.22	11.35	32.38	48.54	54	-5.46
17783	41.26	PK	V	45.22	11.35	32.38	65.45	74	-8.55
17783	41.02	PK	H	45.22	11.35	32.38	65.21	74	-8.79

**Note:**

- 1, The testing has been conformed to  $10 \times 2480 \text{ MHz} = 24,800 \text{ MHz}$
- 2, All other emissions more than 30 dB below the limit
- 3, X-Axis, Y-Axis and Z-Axis were investigated. The results above show only the worst case.

## Annex A. TEST INSTRUMENT

Instrument	Model	Serial #	Cal Date	Cal Due	In use
<b>AC Line Conducted</b>					
EMI test receiver	ESCS30	8471241027	09/16/2016	09/15/2017	<input checked="" type="checkbox"/>
Line Impedance	LI-125A	191106	09/24/2016	09/23/2017	<input checked="" type="checkbox"/>
Line Impedance	LI-125A	191107	09/24/2016	09/23/2017	<input checked="" type="checkbox"/>
LISN	ISN T800	34373	09/24/2016	09/23/2017	<input checked="" type="checkbox"/>
Double Ridge Horn Antenna (1 ~18GHz)	AH-118	71283	09/23/2016	09/22/2017	<input checked="" type="checkbox"/>
Transient Limiter	LIT-153	531118	08/31/2016	08/30/2017	<input checked="" type="checkbox"/>
<b>RF conducted test</b>					
Agilent ESA-E SERIES	E4407B	MY45108319	09/16/2016	09/15/2017	<input checked="" type="checkbox"/>
Power Splitter	1#	1#	08/31/2016	08/30/2017	<input checked="" type="checkbox"/>
DC Power Supply	E3640A	MY40004013	09/16/2016	09/15/2017	<input checked="" type="checkbox"/>
<b>Radiated Emissions</b>					
EMI test receiver	ESL6	100262	09/16/2016	09/15/2017	<input checked="" type="checkbox"/>
Positioning Controller	UC3000	MF780208282	11/19/2015	11/18/2016	<input checked="" type="checkbox"/>
OPT 010 AMPLIFIER (0.1-1300MHz)	8447E	2727A02430	08/31/2016	08/30/2017	<input checked="" type="checkbox"/>
Microwave Preamplifier (1 ~ 26.5GHz)	8449B	3008A02402	03/24/2016	03/23/2017	<input checked="" type="checkbox"/>
Bilog Antenna (30MHz~6GHz)	JB6	A110712	09/20/2016	09/19/2017	<input checked="" type="checkbox"/>
Double Ridge Horn Antenna (1 ~18GHz)	AH-118	71283	09/23/2016	09/22/2017	<input checked="" type="checkbox"/>
Universal Radio Communication Tester	CMU200	121393	09/24/2016	09/23/2017	<input checked="" type="checkbox"/>

Test Report No.	16071234-FCC-R4
Page	32 of 40

## Annex B. EUT And Test Setup Photographs

### Annex B.i. Photograph: EUT External Photo



Test Report No.	16071234-FCC-R4
Page	33 of 40

**Annex B.ii. Photograph: EUT Internal Photo**

Test Report No.	16071234-FCC-R4
Page	34 of 40

**Annex B.iii. Photograph: Test Setup Photo**

## Annex C. TEST SETUP AND SUPPORTING EQUIPMENT

### Annex C.ii. TEST SET UP BLOCK

#### Block Configuration Diagram for AC Line Conducted Emissions

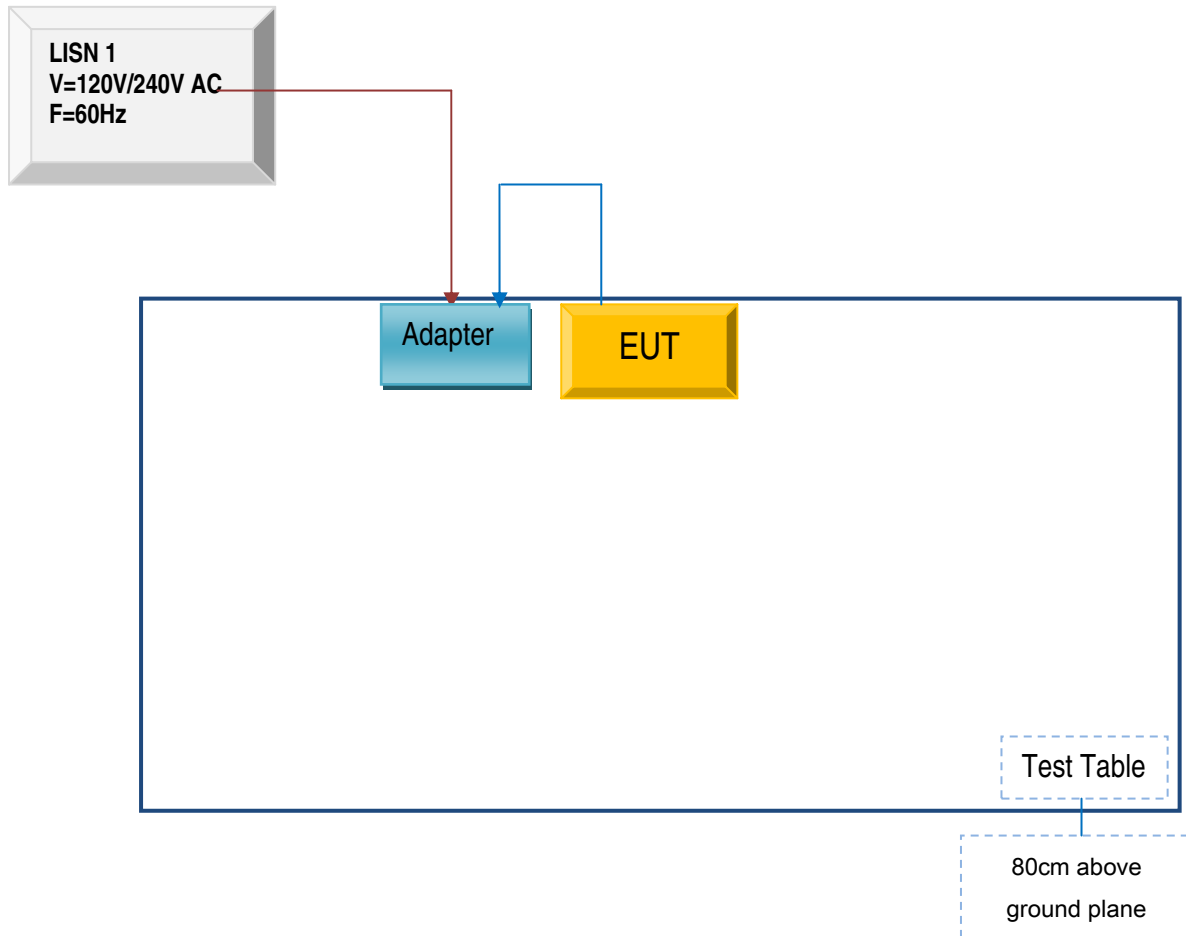

**Block Configuration Diagram for Radiated Emissions ( Below 1GHz ) .**

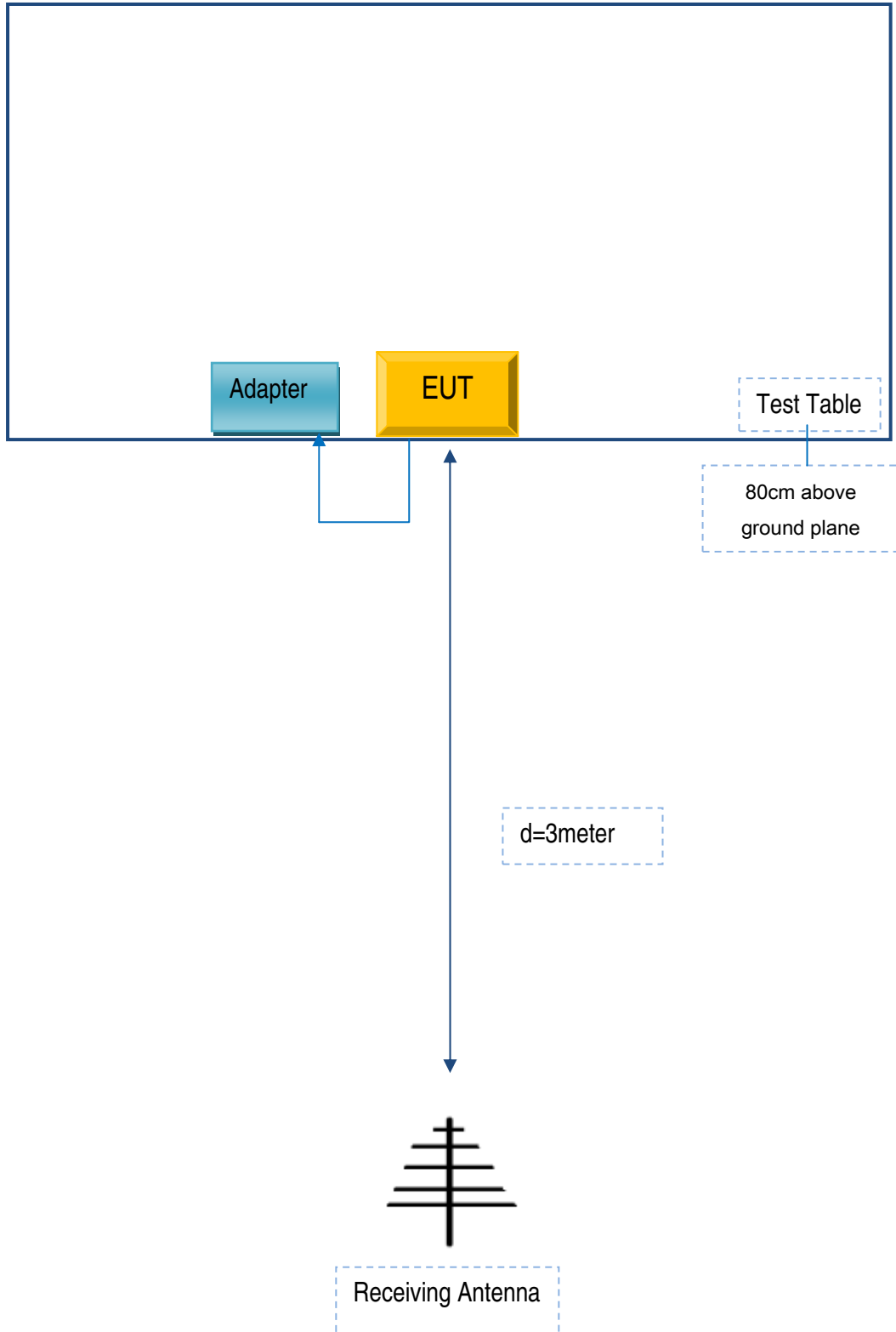

**Block Configuration Diagram for Radiated Emissions ( Above 1GHz ) .**

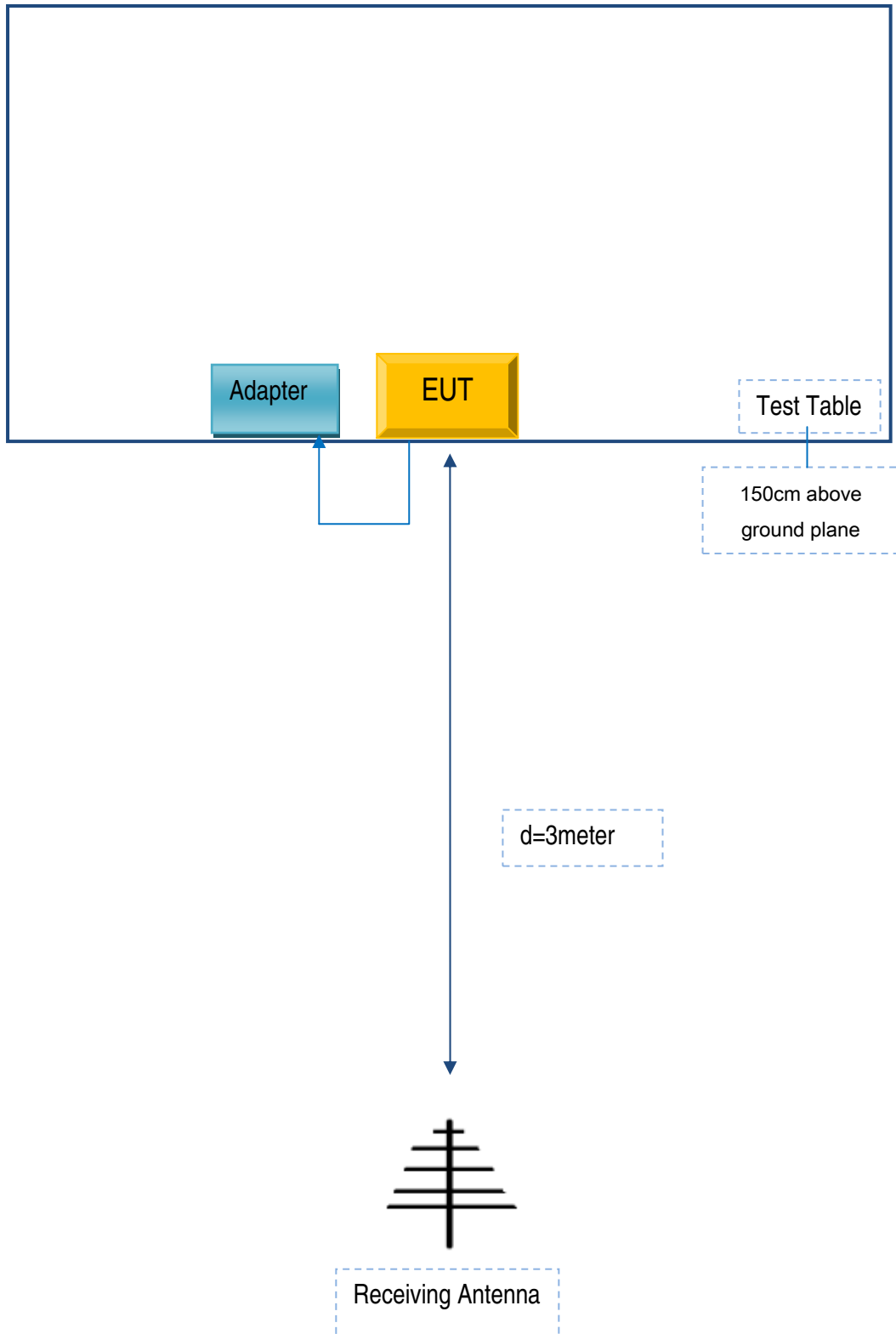

## Annex C. ii. SUPPORTING EQUIPMENT DESCRIPTION

The following is a description of supporting equipment and details of cables used with the EUT.

### Supporting Equipment:

Manufacturer	Equipment Description	Model	Serial No
NEG TECHNOLOGY CO., LIMITED	Adapter	PCX455	S05312

### Supporting Cable:

Cable type	Shield Type	Ferrite Core	Length	Serial No
USB Cable	Un-shielding	No	0.8m	S05312

Test Report No.	16071234-FCC-R4
Page	39 of 40

**Annex D. User Manual / Block Diagram / Schematics / Partlist**

Please see the attachment

Test Report No.	16071234-FCC-R4
Page	40 of 40

## Annex E. DECLARATION OF SIMILARITY

N/A