

# TEST REPORT

**Application No.:** SZEM2012012271CR  
**Applicant:** SMT TELECOMM HK LIMITED  
**Address of Applicant:** UNIT C 8/F CHARMHILL CTR 50 HILLWOOD RD TST KL  
**Manufacturer:** SMT TELECOMM HK LIMITED  
**Address of Manufacturer:** UNIT C 8/F CHARMHILL CTR 50 HILLWOOD RD TST KL  
**Equipment Under Test (EUT):**  
**EUT Name:** tablet  
**Model No.:** Inspire 4.0  
**Trade Mark:** GTL  
**FCC ID:** 2AIMEI40  
**Standard(s) :** FCC Part 96.47  
 FCC KDB 940660 D01 Part 96 CBRS Eqpt v02  
 WINNF-TS-0122-V1.0.1 CBRS CBSD Test Specification  
 WINNF-18-IN-00178 CBRS End User Device as UUT Test Guidelines  
**Date of Receipt:** 2020-12-09  
**Date of Test:** 2020-12-09 to 2020-12-16  
**Date of Issue:** 2020-12-16

<b>Test Result:</b>	<b>Pass*</b>
---------------------	--------------



\* In the configuration tested, the EUT complied with the standards specified above.

Keny Xu  
EMC Laboratory Manager



Unless otherwise agreed in writing, this document is issued by the Company subject to its General Conditions of Service printed overleaf, available on request or accessible at <http://www.sgs.com/en/Terms-and-Conditions.aspx> and, for electronic format documents, subject to Terms and Conditions for Electronic Documents at <http://www.sgs.com/en/Terms-and-Conditions/Terms-e-Documents.aspx>. Attention is drawn to the limitation of liability, indemnification and jurisdiction issues defined therein. Any holder of this document is advised that information contained hereon reflects the Company's findings at the time of its intervention only and within the limits of Client's instructions, if any. The Company's sole responsibility is to its Client and this document does not exonerate parties to a transaction from exercising all their rights and obligations under the transaction documents. This document cannot be reproduced except in full, without prior written approval of the Company. Any unauthorized alteration, forgery or falsification of the content or appearance of this document is unlawful and offenders may be prosecuted to the fullest extent of the law. Unless otherwise stated the results shown in this test report refer only to the sample(s) tested and such sample(s) are retained for 30 days only.  
**Attention: To check the authenticity of testing /inspection report & certificate, please contact us at telephone: (86-755) 8307 1443, or email: CN.Doccheck@sgs.com**  
 No.1 Workshop, M-10, Middle Section, Science & Technology Park, Shenzhen, China 518057 t (86-755) 26012053 f (86-755) 26710594 www.sgsgroup.com.cn  
 中国·深圳·科技园中区M-10栋一号厂房 邮编: 518057 t (86-755) 26012053 f (86-755) 26710594 sgs.china@sgs.com

<i>Revision Record</i>				
<i>Version</i>	<i>Chapter</i>	<i>Date</i>	<i>Modifier</i>	<i>Remark</i>
01		2020-12-16		Original

<b>Authorized for issue by:</b>			
			
		<hr/> <b>Jacky Li /Project Engineer</b>	
			
		<hr/> <b>Eric Fu /Reviewer</b>	



Unless otherwise agreed in writing, this document is issued by the Company subject to its General Conditions of Service printed overleaf, available on request or accessible at <http://www.sgs.com/en/Terms-and-Conditions.aspx> and, for electronic format documents, subject to Terms and Conditions for Electronic Documents at <http://www.sgs.com/en/Terms-and-Conditions/Terms-e-Documents.aspx>. Attention is drawn to the limitation of liability, indemnification and jurisdiction issues defined therein. Any holder of this document is advised that information contained hereon reflects the Company's findings at the time of its intervention only and within the limits of Client's instructions, if any. The Company's sole responsibility is to its Client and this document does not exonerate parties to a transaction from exercising all their rights and obligations under the transaction documents. This document cannot be reproduced except in full, without prior written approval of the Company. Any unauthorized alteration, forgery or falsification of the content or appearance of this document is unlawful and offenders may be prosecuted to the fullest extent of the law. Unless otherwise stated the results shown in this test report refer only to the sample(s) tested and such sample(s) are retained for 30 days only.

Attention: To check the authenticity of testing /inspection report & certificate, please contact us at telephone: (86-755) 8307 1443, or email: [CN.Doccheck@sgs.com](mailto:CN.Doccheck@sgs.com)  
 No.1 Workshop, M-10, Middle Section, Science & Technology Park, Shenzhen, China 518057 t (86-755) 26012053 f (86-755) 26710594 www.sgs.com.cn  
 中国·深圳·科技园中区M-10栋一号厂房 邮编: 518057 t (86-755) 26012053 f (86-755) 26710594 sgs.china@sgs.com

## 2 Test Summary

Item	Standard	Test Case ID	Result
End User Device additional requirement	96.47	/	Pass

The UUT is a End User Device. According to the specifications of the manufacturer, it must comply with the requirements of the following standards:

**Test standards:**

FCC Part 96.47

FCC KDB 940660 D01 Part 96 CBRS Eqpt v02

WINNF-TS-0122-V1.0.1 CBRS CBSD Test Specification

WINNF-18-IN-00178 CBRS End User Device as UUT Test Guidelines



### 3 Contents

	Page
1 COVER PAGE .....	1
2 TEST SUMMARY .....	3
3 CONTENTS .....	4
4 GENERAL INFORMATION .....	5
4.1 DETAILS OF E.U.T. ....	5
4.2 MEASUREMENT UNCERTAINTY .....	5
4.3 DESCRIPTION OF SUPPORT UNITS .....	5
4.4 TEST LOCATION .....	6
5 EQUIPMENT LIST .....	7
6 TEST METHOD AND ENVIRONMENT .....	8
6.1 END USER DEVICE CONFORMANCE AND PERFORMANCE .....	8
6.2 TEST ENVIRONMENT .....	8
6.3 TEST REQUIREMENT .....	8
6.4 TEST PROCEDURE .....	8
6.5 TEST SETUP .....	9
6.6 TEST RESULT .....	10
7 PHOTOGRAPHS .....	12
7.1 EUT CONSTRUCTIONAL DETAILS (EUT PHOTOS) .....	12



## 4 General Information

### 4.1 Details of E.U.T.

Power supply:	DC 5V Adapter information: Model: ASSA107A-050200 Input: 100-240V~50Hz Output: DC 5V2.0A
Sample Type:	End User Device, Portable Device
Transmitter Frequency Band:	LTE Band 48
Transmitter Frequency Range:	3550~3700MHz
Hardware Version:	P3
Software Version:	Inspire_4_09162020
Antenna Type:	PIFA Antenna
Antenna Gain:	1dBi

### 4.2 Measurement Uncertainty

No.	Item	Measurement Uncertainty
1	Radio Frequency	$\pm 7.25 \times 10^{-8}$
2	RF conducted power	$\pm 0.75\text{dB}$
3	Temperature test	$\pm 1^{\circ}\text{C}$
4	Humidity test	$\pm 3\%$
5	Supply voltages	$\pm 1.5\%$
6	Time	$\pm 3\%$

### 4.3 Description of Support Units

Description	Manufacturer	Model No.	Serial No.
EPC	Lanner Electronics Inc.	LICA-1513A	LR202002004052
Router	TP-LINK	TL-R860+	1175379002425
Base station	Baicells	mBS105 (FCC ID: 2AG32MBS110596)	120200007219BSP0001





#### 4.4 Test Location

All tests were performed at:

SGS-CSTC Standards Technical Services Co., Ltd., Shenzhen Branch

No. 1 Workshop, M-10, Middle Section, Science & Technology Park, Shenzhen, Guangdong, China.  
518057.

Tel: +86 755 2601 2053 Fax: +86 755 2671 0594

No tests were sub-contracted.



## 5 Equipment List

Test Equipment	Manufacturer	Model No.	Inventory No.	Cal Date	Cal Due Date
Laptop (With SAS Test harness)	Lenovo	Pro-13API 2019	REF. No.SEA1800	/	/
Spectrum Analyzer	Keysight	N9020A	SEM004-17	2020-05-21	2021-05-20
Shield Room	SAEMC	MSR433	SEM001-11	2018-03-13	2021-03-12
Coaxial Cable	SGS	N/A	SEM031-01	2020-07-11	2021-07-10
Attenuator	Weinschel Associates	WA41	SEM021-09	N/A	N/A
Humidity/ Temperature Indicator	Shanghai Meteorological Industry Factory	ZJ1-2B	SEM002-03	2020-09-27	2021-09-26



## 6 Test Method and Environment

### 6.1 End User Device Conformance and Performance

Test Requirement: FCC Part 96.47  
 Test Method: WINNF-18-IN-00178 CBRS End User Device as UUT Test Guidelines

### 6.2 Test Environment

Environmental Conditions: 25deg. C, 65%RH

### 6.3 Test Requirement

FCC Part 96.47

- a). End User Devices may operate only if they can positively receive and decode an authorization signal transmitted by a CBSD, including the frequencies and power limits for their operation.
- b). An End User Device must discontinue operations, change frequencies, or change its operational power level within 10 seconds of receiving instructions from its associated CBSD.

### 6.4 Test Procedure

Following procedure can be done by applying WINNF-TS-0122-V1.0.1 CBRS CBSD Test Specification, use the certified Baicell CBSD (FCC ID: 2AG32MBS110596) as companion device to show compliance with Part 96.47 requirement for End User Device (EUD):

1. Setup with frequency 3550-3570MHz and power level 13dBm/MHz;
2. Enable CBSD service ;
3. Check EUD Tx Frequency and power;
4. Disable AP service ;
5. Check EUD stops transmission within 10seconds;
6. Setup with 3590-3610MHz & power level 7dBm/MHz;
7. Enable CBSD service;
8. Check EUD Tx Frequency and power;
9. Disable CBSD service;
10. Check EUD stops transmission within 10seconds.



Unless otherwise agreed in writing, this document is issued by the Company subject to its General Conditions of Service printed overleaf, available on request or accessible at <http://www.sgs.com/en/Terms-and-Conditions.aspx> and, for electronic format documents, subject to Terms and Conditions for Electronic Documents at <http://www.sgs.com/en/Terms-and-Conditions/Terms-e-Documents.aspx>. Attention is drawn to the limitation of liability, indemnification and jurisdiction issues defined therein. Any holder of this document is advised that information contained hereon reflects the Company's findings at the time of its intervention only and within the limits of Client's instructions, if any. The Company's sole responsibility is to its Client and this document does not exonerate parties to a transaction from exercising all their rights and obligations under the transaction documents. This document cannot be reproduced except in full, without prior written approval of the Company. Any unauthorized alteration, forgery or falsification of the content or appearance of this document is unlawful and offenders may be prosecuted to the fullest extent of the law. Unless otherwise stated the results shown in this test report refer only to the sample(s) tested and such sample(s) are retained for 30 days only.  
 Attention: To check the authenticity of testing / inspection report & certificate, please contact us at telephone: (86-755) 8307 1443, or email: [CN.Doccheck@sgs.com](mailto:CN.Doccheck@sgs.com)



**6.5 Test Setup**

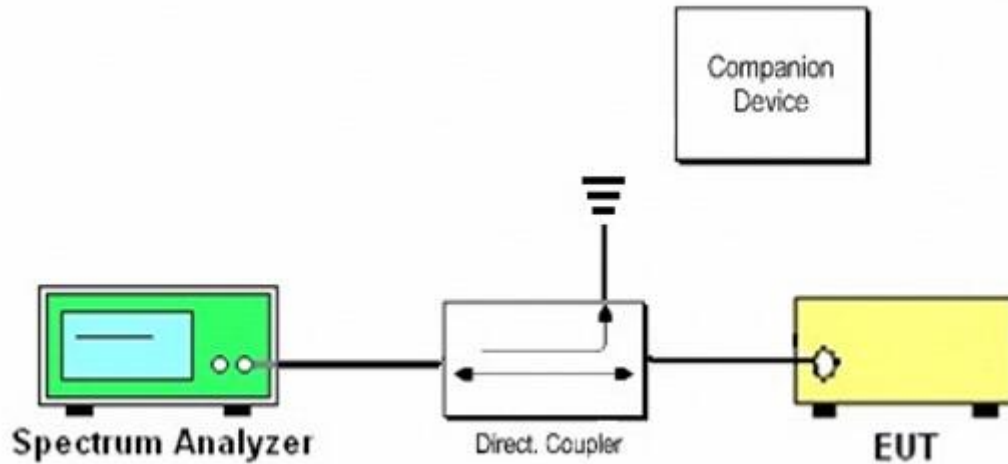

End User Device as UUT, the companion device is certified CBRS (FCC ID: 2AG32MBS110596)



Unless otherwise agreed in writing, this document is issued by the Company subject to its General Conditions of Service printed overleaf, available on request or accessible at <http://www.sgs.com/en/Terms-and-Conditions.aspx> and, for electronic format documents, subject to Terms and Conditions for Electronic Documents at <http://www.sgs.com/en/Terms-and-Conditions/Terms-e-Documents.aspx>. Attention is drawn to the limitation of liability, indemnification and jurisdiction issues defined therein. Any holder of this document is advised that information contained hereon reflects the Company's findings at the time of its intervention only and within the limits of Client's instructions, if any. The Company's sole responsibility is to its Client and this document does not exonerate parties to a transaction from exercising all their rights and obligations under the transaction documents. This document cannot be reproduced except in full, without prior written approval of the Company. Any unauthorized alteration, forgery or falsification of the content or appearance of this document is unlawful and offenders may be prosecuted to the fullest extent of the law. Unless otherwise stated the results shown in this test report refer only to the sample(s) tested and such sample(s) are retained for 30 days only.

6.6 Test Result

[Step 1] Setup with frequency 3550-3570MHz and power level 13dBm/MHz

[Step 3] Check EUD Tx Frequency and power

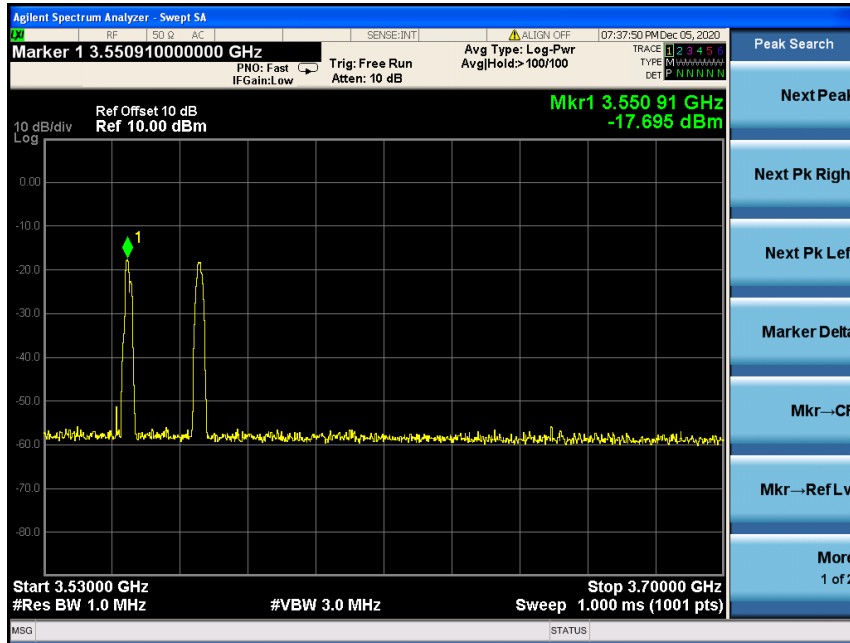

[Step 5] EUD stops transmission within 10 seconds of receiving instructions from its associated CBSD.

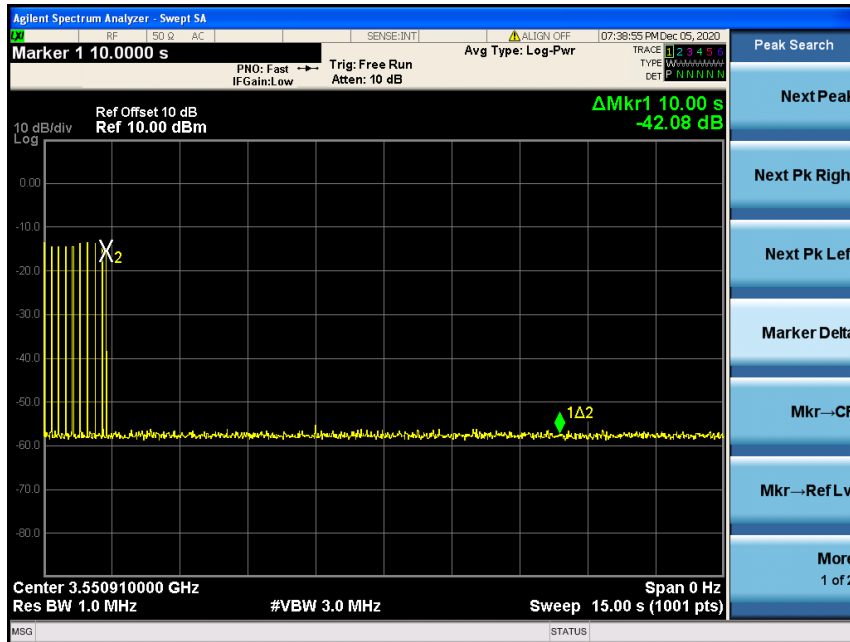

Unless otherwise agreed in writing, this document is issued by the Company subject to its General Conditions of Service printed overleaf, available on request or accessible at <http://www.sgs.com/en/Terms-and-Conditions.aspx> and, for electronic format documents, subject to Terms and Conditions for Electronic Documents at <http://www.sgs.com/en/Terms-and-Conditions/Terms-e-Documents.aspx>. Attention is drawn to the limitation of liability, indemnification and jurisdiction issues defined therein. Any holder of this document is advised that information contained hereon reflects the Company's findings at the time of its intervention only and within the limits of Client's instructions, if any. The Company's sole responsibility is to its Client and this document does not exonerate parties to a transaction from exercising all their rights and obligations under the transaction documents. This document cannot be reproduced except in full, without prior written approval of the Company. Any unauthorized alteration, forgery or falsification of the content or appearance of this document is unlawful and offenders may be prosecuted to the fullest extent of the law. Unless otherwise stated the results shown in this test report refer only to the sample(s) tested and such sample(s) are retained for 30 days only.

[Step 6] Setup with frequency 3590-3610MHz and power level 7dBm/MHz

[Step 8] Check EUD Tx Frequency and power

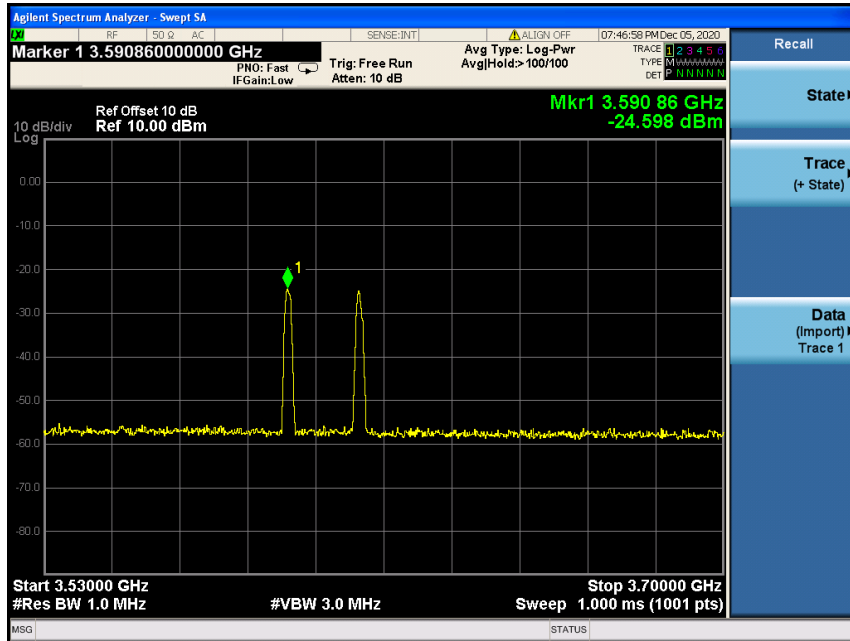

[Step 10] EUD stops transmission within 10 seconds of receiving instructions from its associated CBSD.

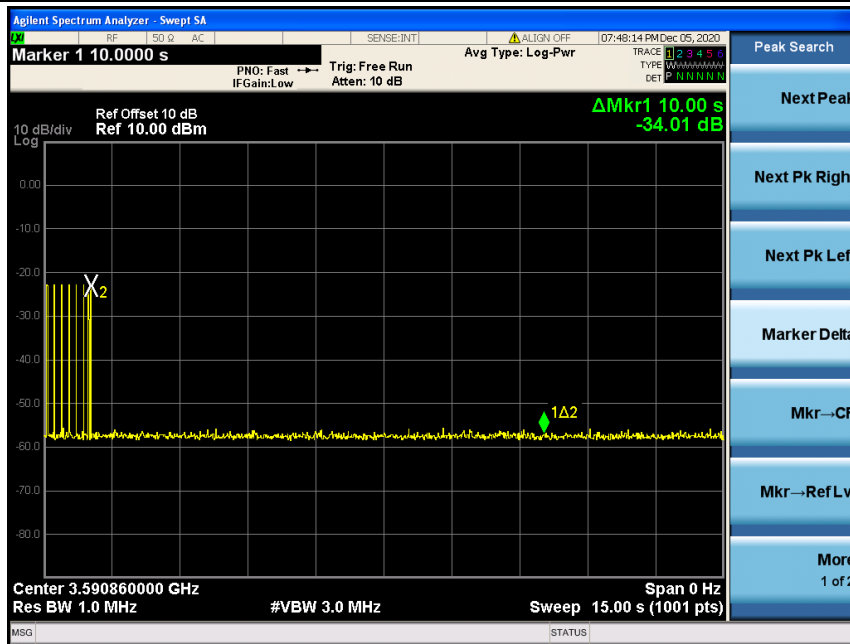

Unless otherwise agreed in writing, this document is issued by the Company subject to its General Conditions of Service printed overleaf, available on request or accessible at <http://www.sgs.com/en/Terms-and-Conditions.aspx> and, for electronic format documents, subject to Terms and Conditions for Electronic Documents at <http://www.sgs.com/en/Terms-and-Conditions/Terms-e-Documents.aspx>. Attention is drawn to the limitation of liability, indemnification and jurisdiction issues defined therein. Any holder of this document is advised that information contained hereon reflects the Company's findings at the time of its intervention only and within the limits of Client's instructions, if any. The Company's sole responsibility is to its Client and this document does not exonerate parties to a transaction from exercising all their rights and obligations under the transaction documents. This document cannot be reproduced except in full, without prior written approval of the Company. Any unauthorized alteration, forgery or falsification of the content or appearance of this document is unlawful and offenders may be prosecuted to the fullest extent of the law. Unless otherwise stated the results shown in this test report refer only to the sample(s) tested and such sample(s) are retained for 30 days only.

## 7 Photographs

### 7.1 EUT Constructional Details (EUT Photos)

Please Refer to Integral and internal photos for details.

- End of the Report -

