



# FCC TEST REPORT

**Test report  
On Behalf of  
VTIN TECHNOLOGY Co., Limited  
For  
Wireless Mouse  
Model No.: PC230B-1, Please refer to page 6 for series models**

**FCC ID: 2AIL4-PC230B-1**

**Prepared for :** VTIN TECHNOLOGY Co., Limited  
UNIT D 16/F ONE CAPITAL PLACE 21, LUARD ROAD WAN CHAI, Hong Kong

**Prepared By :** Shenzhen HUAKE Testing Technology Co., Ltd.  
1F, B2 Building, Junfeng Zhongcheng Zhizao Innovation Park, Fuhai Street,  
Bao'an District, Shenzhen City, China

**Date of Test:** Sept. 07, 2020 ~ Sept. 14, 2020

**Date of Report:** Sept. 14, 2020

**Report Number:** HK2009092536-E





<b>Table of Contents</b>	<b>Page</b>
1 . TEST SUMMARY	5
2 . GENERAL INFORMATION	6
2.1 GENERAL DESCRIPTION OF EUT	6
2.2 Carrier Frequency of Channels	7
2.3 Operation of EUT during testing	7
2.4 DESCRIPTION OF TEST SETUP	8
2.5 MEASUREMENT INSTRUMENTS LIST	9
3 . CONDUCTED EMISSIONS TEST	10
3.1 Conducted Power Line Emission Limit	10
3.2 Test Setup	10
3.3 Test Procedure	10
3.4 Test Result	11
4 RADIATED EMISSION TEST	13
4.1 Radiation Limit	13
4.2 Test Setup	13
4.3 Test Procedure	14
4.4 Test Result	14
5 BAND EDGE	20
5.1 Limits	20
5.2 Test Procedure	20
5.3 Test Result	21
6 OCCUPIED BANDWIDTH MEASUREMENT	23
6.1 Test Setup	23
6.2 Test Procedure	23
6.3 Measurement Equipment Used	23
6.4 Test Result	23
7 ANTENNA REQUIREMENT	25
8 PHOTOGRAPH OF TEST	26
8.1 Radiated Emission	26
8.2 Conducted Emission	27
9 PHOTOS OF THE EUT	28



**\*\* Modified History \*\***

<b>Revision</b>	<b>Description</b>	<b>Issued Data</b>	<b>Remark</b>
Revision 1.0	Initial Test Report Release	Sept. 14, 2020	Jason Zhou



## 1. TEST SUMMARY

### 1.1 TEST PROCEDURES AND RESULTS

DESCRIPTION OF TEST		RESULT
CONDUCTED EMISSIONS TEST	§ 15.207	COMPLIANT
RADIATED EMISSION TEST	§ 15.249 (a) (d)/ §15.209	COMPLIANT
BAND EDGE	§ 15.249 (a) (d)/ §15.209	COMPLIANT
OCCUPIED BANDWIDTH MEASUREMENT	§ 15.215 (c)	COMPLIANT
ANTENNA REQUIREMENT	§ 15.203	COMPLIANT

### 1.2 TEST FACILITY

Test Firm : Shenzhen HUAKE Testing Technology Co., Ltd.

Address : 1F, B2 Building, Junfeng Zhongcheng Zhizao Innovation Park, Fuhai Street, Bao'an District, Shenzhen City, China

### 1.3 MEASUREMENT UNCERTAINTY

Measurement Uncertainty

Conducted Emission Expanded Uncertainty = 2.23dB, k=2

Radiated emission expanded uncertainty(9kHz-30MHz) = 3.08dB, k=2

Radiated emission expanded uncertainty(30MHz-1000MHz) = 4.42dB, k=2

Radiated emission expanded uncertainty(Above 1GHz) = 4.06dB, k=2



## 2. GENERAL INFORMATION

### 2.1 GENERAL DESCRIPTION OF EUT

Equipment	Wireless Mouse
Model Name	PC230B-1
Serial Model	PC230B, CM610, CM611, CM612, CM613, CM614, CM615, CM616, CM617, CM618, CM619, CM620, CM621, CM622, CM623, CM624, CM625, CM626, CM627, CM628, CM629, CM640, CM650, CM655, CM660, CM665, CM670, CM675, CM680, CM685, CM690, CM695, CM800, CM810, CM815, CM820, CM830, CM840, CM850, CM860, CM870, CM880, CM881, CM880 PLUS, CM880 PRO, CM890, CM891, CM892, CM892W, CM893, CM894, CM895, CM896, CM897, CM898, CM899, CM898L
Model Difference	All model's the function, software and electric circuit are the same, only with a product color and model named different. Test sample model: PC230B-1
FCC ID	2AIL4-PC230B-1
Antenna Type	PCB Antenna
Antenna Gain	0dBi
Equipment	Wireless Mouse
BT Operation frequency	2408MHz~2474MHz
Number of Channels	34CH
Modulation Type	GFSK
Power Source	DC 1.5V from Battery
Power Rating	DC 1.5V from Battery



## 2.2 Carrier Frequency of Channels

Description of Channel:					
Channel	Frequency (MHz)	Channel	Frequency (MHz)	Channel	Frequency (MHz)
0	2408	14	2436	28	2464
1	2410	15	2438	29	2466
2	2412	16	2440	30	2468
3	2414	17	2442	31	2470
4	2416	18	2444	32	2472
5	2418	19	2446	33	2474
6	2420	20	2448		
7	2422	21	2450		
8	2424	22	2452		
9	2426	23	2454		
10	2428	24	2456		
11	2430	25	2458		
12	2432	26	2460		
13	2434	27	2462		

## 2.3 Operation of EUT during testing

## Operating Mode

The mode is used: **Transmitting mode**

Low Channel: 2408MHz

Middle Channel: 2440MHz

High Channel: 2474MHz



## 2.4 DESCRIPTION OF TEST SETUP

Operation of EUT during conducted testing and below 1GHz Radiation testing:

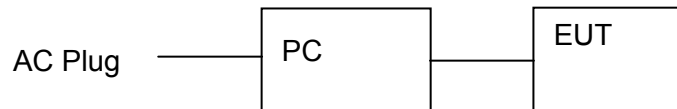

Operation of EUT during Above1GHz Radiation testing:

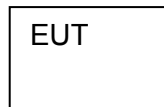

- PC information  
Model: TP00067A  
Input: DC20V, 2.25-3.25A  
Output: 5VDC, 0.5A

The sample was placed (0.8m below 1GHz, 1.5m above 1GHz) above the ground plane of 3m chamber. Measurements in both horizontal and vertical polarities were performed. During the test, each emission was maximized by: having the EUT continuously working, investigated all operating modes, rotated about all 3 axis (X, Y & Z) and considered typical configuration to obtain worst position, manipulating interconnecting cables, rotating the turntable, varying antenna height from 1m to 4m in both horizontal and vertical polarizations. The emissions worst-case are shown in Test Results of the following pages. The worst case is X position





## 2.5 MEASUREMENT INSTRUMENTS LIST

Item	Equipment	Manufacturer	Model No.	Serial No.	Last Cal.	Cal. Interval
1.	L.I.S.N. Artificial Mains Network	R&S	ENV216	HKE-002	Jun. 18, 2020	1 Year
2.	Receiver	R&S	ESCI 7	HKE-010	Jun. 18, 2020	1 Year
3.	RF automatic control unit	Tonscend	JS0806-2	HKE-060	Jun. 18, 2020	1 Year
4.	Spectrum analyzer	R&S	FSP40	HKE-025	Jun. 18, 2020	1 Year
5.	Spectrum analyzer	Agilent	N9020A	HKE-048	Jun. 18, 2020	1 Year
6.	Preamplifier	Schwarzbeck	BBV 9743	HKE-006	Jun. 18, 2020	1 Year
7.	EMI Test Receiver	Rohde & Schwarz	ESCI 7	HKE-010	Jun. 18, 2020	1 Year
8.	Bilog Broadband Antenna	Schwarzbeck	VULB9163	HKE-012	Jun. 18, 2020	1 Year
9.	Loop Antenna	Schwarzbeck	FMZB 1519 B	HKE-014	Jun. 18, 2020	1 Year
10.	Horn Antenna	Schwarzbeck	9120D	HKE-013	Jun. 18, 2020	1 Year
11.	Pre-amplifier	EMCI	EMC051845 SE	HKE-015	Jun. 18, 2020	1 Year
12.	Pre-amplifier	Agilent	83051A	HKE-016	Jun. 18, 2020	1 Year
13.	EMI Test Software EZ-EMC	Tonscend	JY3120-B Version	HKE-083	Jun. 18, 2020	N/A
14.	Power Sensor	Agilent	E9300A	HKE-086	Jun. 18, 2020	1 Year
15.	Spectrum analyzer	Agilent	N9020A	HKE-048	Jun. 18, 2020	1 Year
16.	Signal generator	Agilent	N5182A	HKE-029	Jun. 18, 2020	1 Year
17.	Signal Generator	Agilent	83630A	HKE-028	Jun. 18, 2020	1 Year
18.	Shielded room	Shiel Hong	4*3*3	HKE-039	Jun. 18, 2020	1 Year
19.	Horn Antenna	Schwarzbeck	BBHA 9170	HKE-017	Jun. 18, 2020	1 Year



### 3. CONDUCTED EMISSIONS TEST

#### 3.1 Conducted Power Line Emission Limit

For unintentional device, according to § 15.107(a) Line Conducted Emission Limits is as following

Frequency (MHz)	Maximum RF Line Voltage (dB $\mu$ V)			
	CLASS A		CLASS B	
	Q.P.	Ave.	Q.P.	Ave.
0.15 - 0.50	79	66	66-56*	56-46*
0.50 - 5.00	73	60	56	46
5.00 - 30.0	73	60	60	50

\* Decreasing linearly with the logarithm of the frequency

For intentional device, according to §15.207(a) Line Conducted Emission Limit is same as above table.

#### 3.2 Test Setup

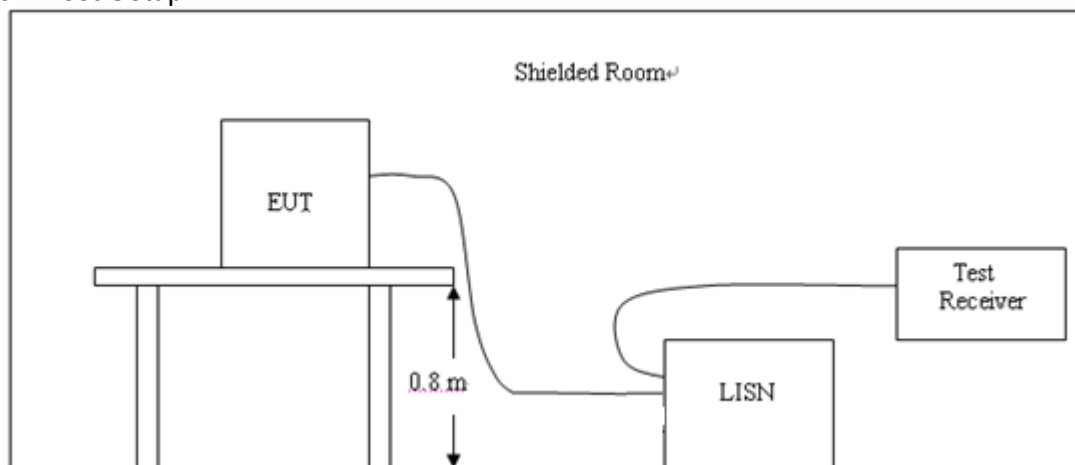

#### 3.3 Test Procedure

- 1, The equipment was set up as per the test configuration to simulate typical actual usage per the user's manual. The EUT is a tabletop system, a wooden table with a height of 0.8 meters is used and is placed on the ground plane as per ANSI C63.10.
- 2, Support equipment, if needed, was placed as per ANSI C63.10.
- 3, All I/O cables were positioned to simulate typical actual usage as per ANSI C63.10.
- 4, If a EUT received DC power from the USB Port of Notebook PC, the PC's adapter received AC120V/60Hz power through a Line Impedance Stabilization Network (LISN) which supplied power source and was grounded to the ground plane.
- 5, All support equipments received AC power from a second LISN, if any.
- 6, The EUT test program was started. Emissions were measured on each current carrying line of the EUT using a spectrum Analyzer / Receiver connected to the LISN powering the EUT. The LISN has two monitoring points: Line 1 (Hot Side) and Line 2 (Neutral Side). Two scans were taken: one with Line 1 connected to Analyzer / Receiver and Line 2 connected to a 50 ohm load; the second scan had Line 1 connected to a 50 ohm load and Line 2 connected to the Analyzer / Receiver.
- 7, Analyzer / Receiver scanned from 150 KHz to 30MHz for emissions in each of the test modes.



### 3.4 Test Result

Test Specification: Line

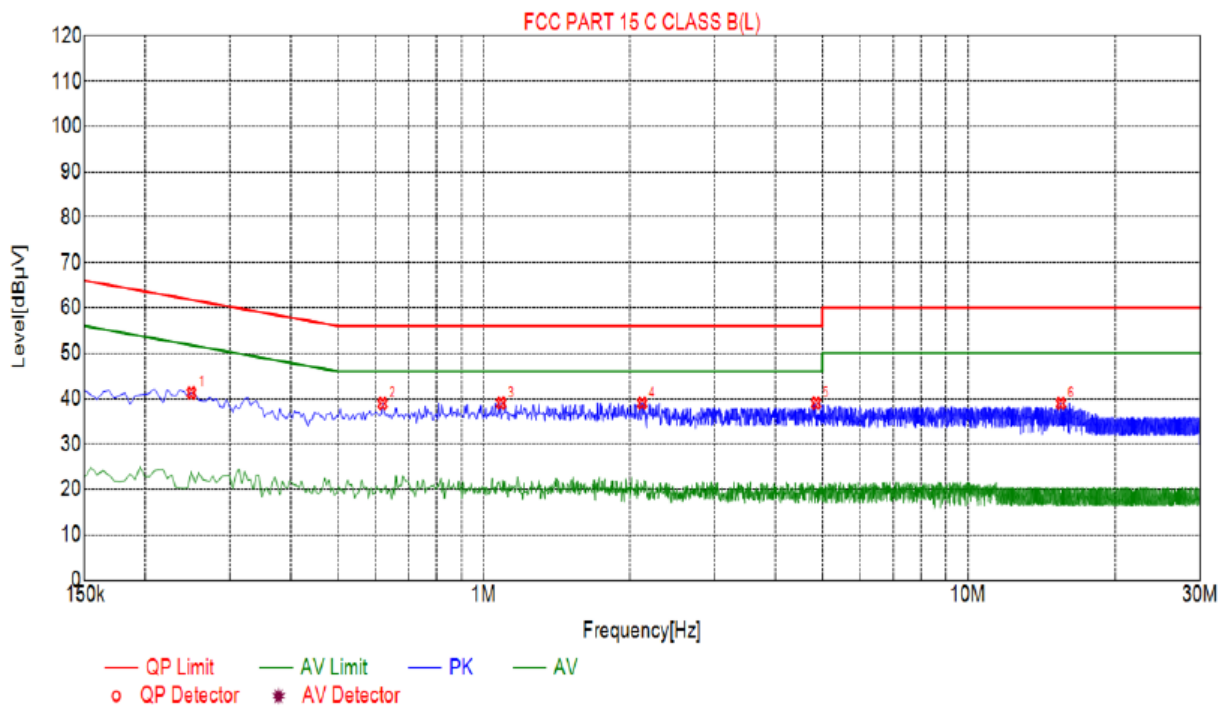

Suspected List								
NO.	Freq. [MHz]	Level [dBµV]	Factor [dB]	Limit [dBµV]	Margin [dB]	Reading [dBµV]	Detector	Type
1	0.2490	41.25	20.04	61.79	20.54	21.21	PK	L
2	0.6180	38.90	20.05	56.00	17.10	18.85	PK	L
3	1.0860	38.99	20.07	56.00	17.01	18.92	PK	L
4	2.1255	38.98	20.16	56.00	17.02	18.82	PK	L
5	4.8570	38.97	20.26	56.00	17.03	18.71	PK	L
6	15.4590	38.92	19.97	60.00	21.08	18.95	PK	L

Remark: Margin = Limit – Level  
 Correction factor = Cable lose + LISN insertion loss  
 Level=Test receiver reading + correction factor



Test Specification: Neutral

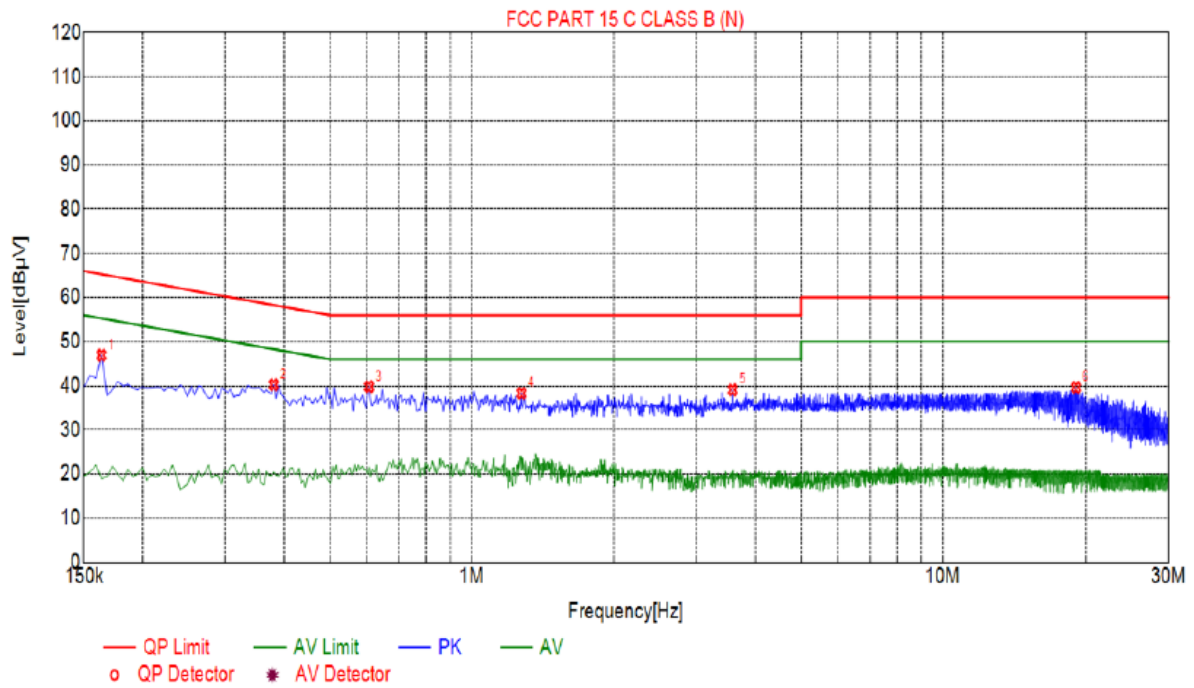

Suspected List								
NO.	Freq. [MHz]	Level [dBµV]	Factor [dB]	Limit [dBµV]	Margin [dB]	Reading [dBµV]	Detector	Type
1	0.1635	46.93	19.98	65.28	18.35	26.95	PK	N
2	0.3795	40.23	20.05	58.29	18.06	20.18	PK	N
3	0.6045	39.79	20.05	56.00	16.21	19.74	PK	N
4	1.2750	38.29	20.09	56.00	17.71	18.20	PK	N
5	3.5790	39.07	20.25	56.00	16.93	18.82	PK	N
6	19.0725	39.61	20.07	60.00	20.39	19.54	PK	N

Remark: Margin = Limit – Level

Correction factor = Cable lose + LISN insertion loss

Level=Test receiver reading + correction factor

## 4 RADIATED EMISSION TEST

### 4.1 Radiation Limit

For unintentional device, according to § 15.109(a), except for Class A digital devices, the field strength of radiated emissions from unintentional radiators at a distance of 3 meters shall not exceed the following values:

Frequency (MHz)	Distance (Meters)	Radiated (dB $\mu$ V/m)	Radiated ( $\mu$ V/m)
30-88	3	40	100
88-216	3	43.5	150
216-960	3	46	200
Above 960	3	54	500

For intentional device, according to § 15.209(a), the general requirement of field strength of radiated emissions from intentional radiators at a distance of 3 meters shall not exceed the above table.

### 4.2 Test Setup

#### (1) Radiated Emission Test-Up Frequency Below 30MHz

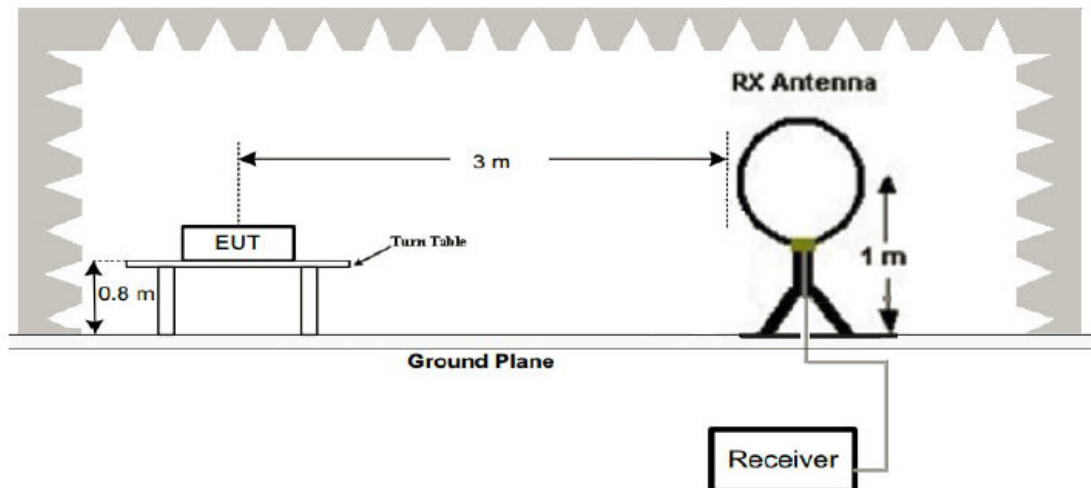

#### (2) Radiated Emission Test-Up Frequency 30MHz~1GHz

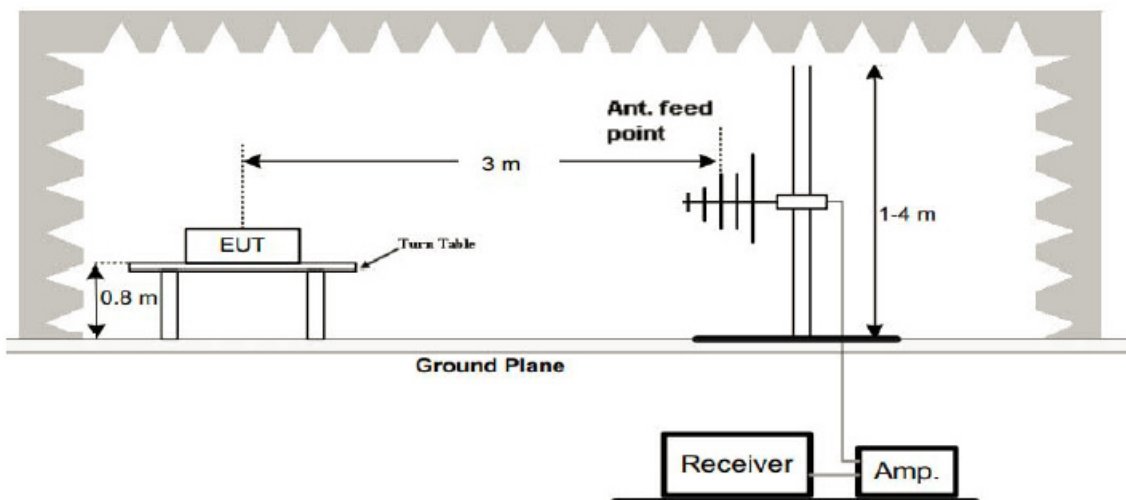

### (3) Radiated Emission Test-Up Frequency Above 1GHz

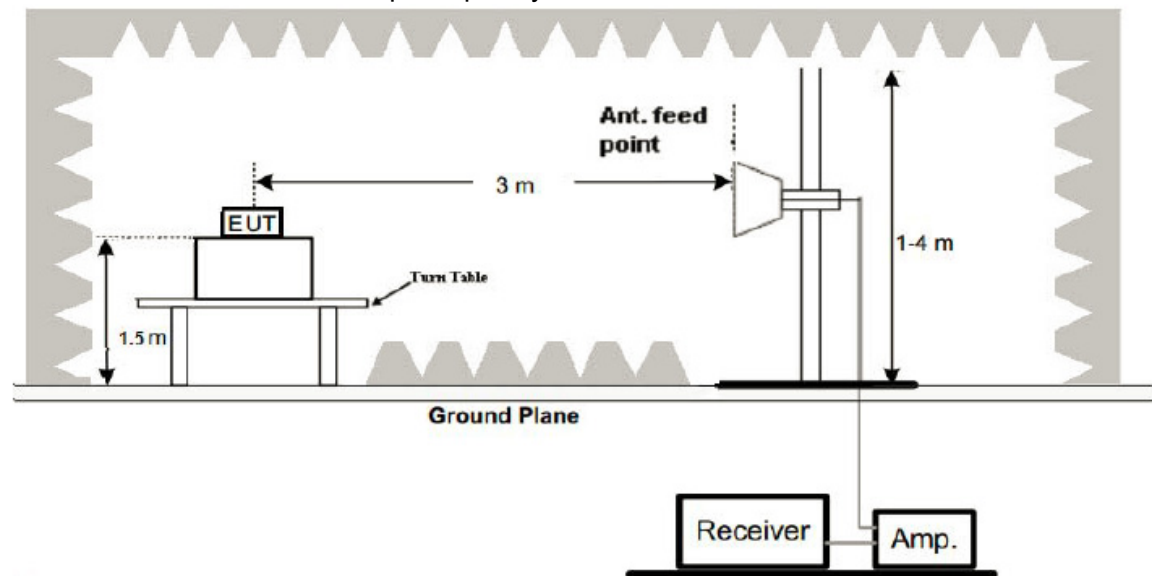

#### 4.3 Test Procedure

1. Below 1GHz measurement the EUT is placed on turntable which is 0.8m above ground plane. And above 1GHz measurement EUT was placed on low permittivity and low tangent turn table which is 1.5m above ground plane.
2. The turntable shall be rotated for 360 degrees to determine the position of maximum emission level.
3. EUT is set 3m away from the receiving antenna, which is varied from 1m to 4m to find out the highest emissions.
4. Maximum procedure was performed on the six highest emissions to ensure EUT compliance.
5. And also, each emission was to be maximized by changing the polarization of receiving antenna both horizontal and vertical.
6. Repeat above procedures until the measurements for all frequencies are complete.
7. The test frequency range from 9KHz to 25GHz per FCC PART 15.33(a).

#### Note:

For battery operated equipment, the equipment tests shall be performed using a new battery.

#### 4.4 Test Result

PASS



Below 1GHz Test Results:

Antenna polarity: H

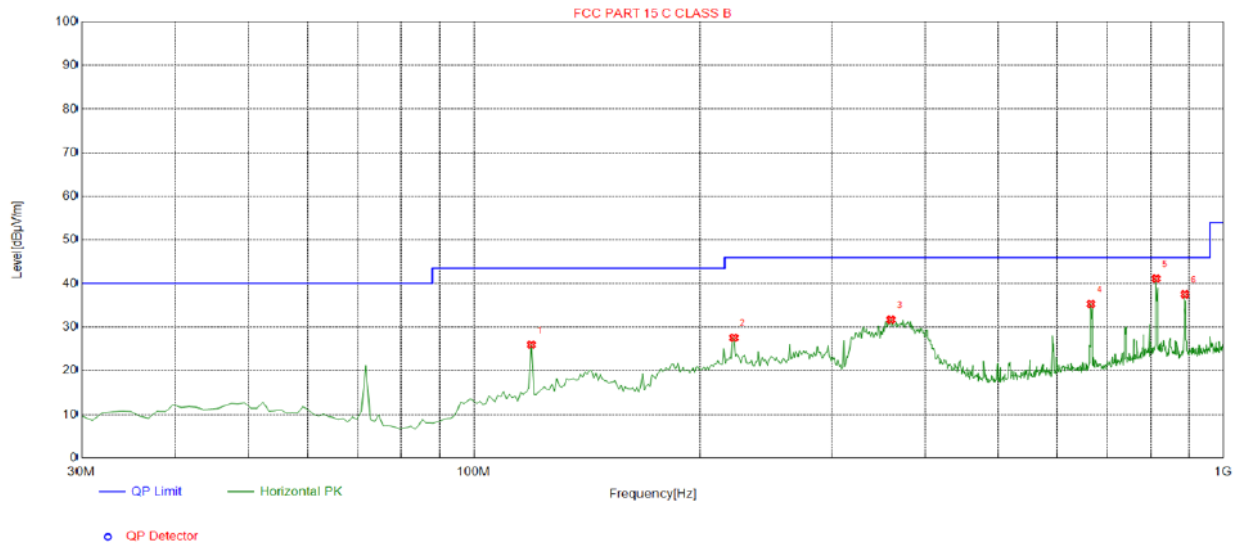

Suspected List									
NO.	Freq. [MHz]	Factor [dB]	Reading [dBµV/m]	Level [dBµV/m]	Limit [dBµV/m]	Margin [dB]	Height [cm]	Angle [°]	Polarity
1	119.3293	-16.99	42.93	25.94	43.50	17.56	100	348	Horizontal
2	222.2523	-14.51	42.04	27.53	46.00	18.47	100	91	Horizontal
3	360.1301	-11.34	43.02	31.68	46.00	14.32	100	27	Horizontal
4	665.9860	-4.81	40.11	35.30	46.00	10.70	100	332	Horizontal
5	813.5736	-2.87	44.02	41.15	46.00	4.85	100	78	Horizontal
6	888.3383	-1.91	39.42	37.51	46.00	8.49	100	261	Horizontal

Remark: Factor = Cable loss + Antenna factor – Pre-amplifier; Level = Reading + Factor; Margin = Limit – Level



Antenna polarity: V

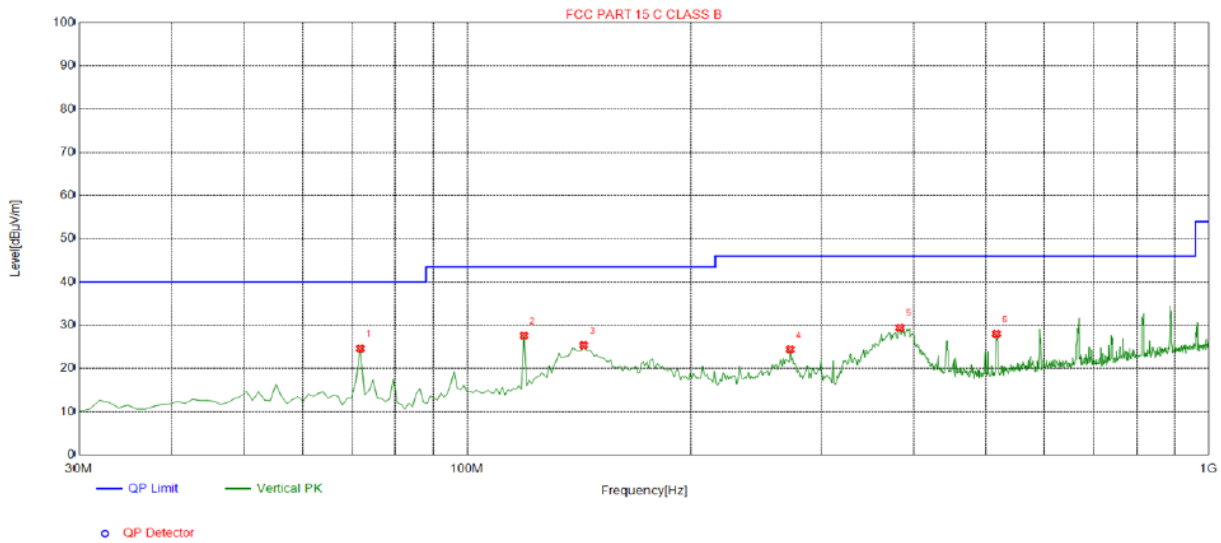

Suspected List									
NO.	Freq. [MHz]	Factor [dB]	Reading [dBµV/m]	Level [dBµV/m]	Limit [dBµV/m]	Margin [dB]	Height [cm]	Angle [°]	Polarity
1	71.7518	-17.99	42.60	24.61	40.00	15.39	100	291	Vertical
2	119.3293	-16.99	44.60	27.61	43.50	15.89	100	63	Vertical
3	143.6036	-19.09	44.45	25.36	43.50	18.14	100	304	Vertical
4	272.7427	-13.55	37.96	24.41	46.00	21.59	100	163	Vertical
5	383.4334	-10.76	40.17	29.41	46.00	16.59	100	342	Vertical
6	517.4274	-7.80	35.81	28.01	46.00	17.99	100	131	Vertical

Remark: Factor = Cable loss + Antenna factor – Preamplifier; Level = Reading + Factor; Margin = Limit – Level

Remark:

- (1) Measuring frequencies from 9 KHz to the 1 GHz, Radiated emission test from 9KHz to 30MHz was verified, and no any emission was found except system noise floor.
- (2) \* denotes emission frequency which appearing within the Restricted Bands specified in provision of 15.205, then the general radiated emission limits in 15.209 apply.
- (3) The IF bandwidth of EMI Test Receiver between 30MHz to 1GHz was 120KHz, 1 MHz for measuring above 1 GHz, below 30MHz was 10KHz.





Above 1 GHz Test Results:  
CH Low (2408MHz)

Horizontal:

Frequency	Meter Reading	Factor	Emission Level	Limits	Margin	Detector Type
(MHz)	(dB $\mu$ V)	(dB)	(dB $\mu$ V/m)	(dB $\mu$ V/m)	(dB)	
2408	103.65	-5.84	97.81	114	-16.19	peak
2408	86.55	-5.84	80.71	94	-13.29	AVG
4816	59.74	-3.64	56.1	74	-17.9	peak
4816	43.26	-3.64	39.62	54	-14.38	AVG
7224	55.32	-0.95	54.37	74	-19.63	peak
7224	42.13	-0.95	41.18	54	-12.82	AVG

Remark: Factor = Antenna Factor + Cable Loss – Pre-amplifier.

Vertical:

Frequency	Meter Reading	Factor	Emission Level	Limits	Margin	Detector Type
(MHz)	(dB $\mu$ V)	(dB)	(dB $\mu$ V/m)	(dB $\mu$ V/m)	(dB)	
2408	103.47	-5.84	97.63	114	-16.37	peak
2408	83.26	-5.84	77.42	94	-16.58	AVG
4816	58.34	-3.64	54.7	74	-19.3	peak
4816	45.62	-3.64	41.98	54	-12.02	AVG
7224	55.19	-0.95	54.24	74	-19.76	peak
7224	38.67	-0.95	37.72	54	-16.28	AVG

Remark: Factor = Antenna Factor + Cable Loss – Pre-amplifier.



## CH Middle (2440MHz)

## Horizontal:

Frequency (MHz)	Meter Reading (dB $\mu$ V)	Factor (dB)	Emission Level (dB $\mu$ V/m)	Limits (dB $\mu$ V/m)	Margin (dB)	Detector Type
2440	108.67	-5.71	102.96	114	-11.04	peak
2440	80.32	-5.71	74.61	94	-19.39	AVG
4880	58.83	-3.51	55.32	74	-18.68	peak
4880	42.16	-3.51	38.65	54	-15.35	AVG
7320	55.32	-0.82	54.5	74	-19.5	peak
7320	38.58	-0.82	37.76	54	-16.24	AVG

Remark: Factor = Antenna Factor + Cable Loss – Pre-amplifier.

## Vertical:

Frequency (MHz)	Meter Reading (dB $\mu$ V)	Factor (dB)	Emission Level (dB $\mu$ V/m)	Limits (dB $\mu$ V/m)	Margin (dB)	Detector Type
2440	104.35	-5.71	98.64	114	-15.36	peak
2440	84.26	-5.71	78.55	94	-15.45	AVG
4880	57.93	-3.51	54.42	74	-19.58	peak
4880	73.16	-3.51	69.65	54	15.65	AVG
7320	55.32	-0.82	54.5	74	-19.5	peak
7320	40.97	-0.82	40.15	54	-13.85	AVG

Remark: Factor = Antenna Factor + Cable Loss – Pre-amplifier.



## CH High (2474MHz)

Horizontal:

Frequency	Meter Reading	Factor	Emission Level	Limits	Margin	Detector Type
(MHz)	(dB $\mu$ V)	(dB)	(dB $\mu$ V/m)	(dB $\mu$ V/m)	(dB)	
2474	102.35	-5.65	96.7	114	-17.3	peak
2474	82.49	-5.65	76.84	94	-17.16	AVG
4948	58.64	-3.43	55.21	74	-18.79	peak
4948	41.26	-3.43	37.83	54	-16.17	AVG
7422	56.32	-0.75	55.57	74	-18.43	peak
7422	36.97	-0.75	36.22	54	-17.78	AVG

Remark: Factor = Antenna Factor + Cable Loss – Pre-amplifier.

Vertical:

Frequency	Meter Reading	Factor	Emission Level	Limits	Margin	Detector Type
(MHz)	(dB $\mu$ V)	(dB)	(dB $\mu$ V/m)	(dB $\mu$ V/m)	(dB)	
2474	100.32	-5.65	94.67	114	-19.33	peak
2474	82.33	-5.65	76.68	94	-17.32	AVG
4948	59.48	-3.43	56.05	74	-17.95	peak
4948	44.16	-3.43	40.73	54	-13.27	AVG
7422	55.82	-0.75	55.07	74	-18.93	peak
7422	37.94	-0.75	37.19	54	-16.81	AVG

Remark: Factor = Antenna Factor + Cable Loss – Pre-amplifier.

Remark :

- (1) Measuring frequencies from 1 GHz to the 25 GHz .
- (2) "F" denotes fundamental frequency; "H" denotes spurious frequency. "E" denotes band edge frequency.
- (3) \* denotes emission frequency which appearing within the Restricted Bands specified in provision of 15.205, then the general radiated emission limits in 15.209 apply.
- (4) The emissions are attenuated more than 20dB below the permissible limits are not record in the report.
- (5) The IF bandwidth of EMI Test Receiver between 30MHz to 1GHz was 120KHz, 1 MHz for measuring above 1 GHz, below 30MHz was 10KHz. The resolution bandwidth of test receiver/spectrum analyzer is 1MHz and video bandwidth is 3MHz for peak measurement with peak detector at frequency above 1GHz. The resolution bandwidth of test receiver/spectrum analyzer is 1MHz and video bandwidth is 10Hz for Average measurement with peak detection at frequency above 1GHz.
- (6) When the test results of Peak Detected below the limits of Average Detected, the Average Detected is not need completed. For example: Top Channel at Fundamental 73.16dB $\mu$ V/m(PK Value) <93.98(AV Limit), at harmonic 53.20 dB $\mu$ V/m(PK Value) <54 dB $\mu$ V/m(AV Limit), the Average Detected not need to completed.
- (7) All modes of operation were investigated and the worst-case emissions are reported.



## 5 BAND EDGE

### 5.1 Limits

FCC PART 15.249(d) Emissions radiated outside of the specified frequency bands, except for harmonics, shall be attenuated by at least 50 dB below the level of the fundamental or to the general radiated emission limits in §15.209, whichever is the lesser attenuation.

### 5.2 Test Procedure

The band edge compliance of RF radiated emission should be measured by following the guidance in ANSI C63.10 with respect to maximizing the emission by rotating the EUT, measuring the emission while the EUT is situated in three orthogonal planes (if appropriate), adjusting the measurement antenna height and polarization etc. Set RBW to 1MHz and VBM to 3MHz to measure the peak field strength and set RBW to 1MHz and VBW to 10Hz to measure the average radiated field strength. The conducted RF band edge was measured by using a spectrum analyzer. Set span wide enough to capture the highest in-band emission and the emission at the band edge. Set RBW to 1MHz and VBW to 3MHz, to measure the conducted peak band edge.



## 5.3 Test Result

**PASS**

Radiated Band Edge Test:

Operation Mode: TX CH Low (2408MHz)

Horizontal (Worst case)

Frequency (MHz)	Meter Reading (dB $\mu$ V)	Factor (dB)	Emission Level (dB $\mu$ V/m)	Limits (dB $\mu$ V/m)	Margin (dB)	Detector Type
2310	57.62	-5.81	51.81	74	-22.19	peak
2310	/	-5.81	/	54	/	AVG
2390	54.33	-5.84	48.49	74	-25.51	peak
2390	/	-5.84	/	54	/	AVG
2400	52.38	-5.84	46.54	74	-27.46	peak
2400	/	-5.84	/	54	/	AVG

Remark: Factor = Antenna Factor + Cable Loss – Pre-amplifier.

Vertical:

Frequency (MHz)	Meter Reading (dB $\mu$ V)	Factor (dB)	Emission Level (dB $\mu$ V/m)	Limits (dB $\mu$ V/m)	Margin (dB)	Detector Type
2310	57.64	-5.81	51.83	74	-22.17	peak
2310	/	-5.81	/	54	/	AVG
2390	54.13	-5.84	48.29	74	-25.71	peak
2390	/	-5.84	/	54	/	AVG
2400	55.03	-5.84	49.19	74	-24.81	peak
2400	/	-5.84	/	54	/	AVG

Remark: Factor = Antenna Factor + Cable Loss – Pre-amplifier.



Operation Mode: TX CH High (2474MHz)

Horizontal (Worst case)

Frequency	Reading Result	Factor	Emission Level	Limits	Margin	Detector Type
(MHz)	(dB $\mu$ V)	(dB)	(dB $\mu$ V/m)	(dB $\mu$ V/m)	(dB)	
2483.50	56.34	-5.65	50.69	74	-23.31	peak
2483.50	/	-5.65	/	54	/	AVG
2500.00	54.03	-5.65	48.38	74	-25.62	peak
2500.00	/	-5.65	/	54	/	AVG
Remark: Factor = Antenna Factor + Cable Loss – Pre-amplifier.						

Vertical:

Frequency	Reading Result	Factor	Emission Level	Limits	Margin	Detector Type
(MHz)	(dB $\mu$ V)	(dB)	(dB $\mu$ V/m)	(dB $\mu$ V/m)	(dB)	
2483.50	56.38	-5.65	50.73	74	-23.27	peak
2483.50	/	-5.65	/	54	/	AVG
2500.00	54.96	-5.65	49.31	74	-24.69	peak
2500.00	/	-5.65	/	54	/	AVG
Remark: Factor = Antenna Factor + Cable Loss – Pre-amplifier.						
Remark: All the other emissions not reported were too low to read and deemed to comply with FCC limit.						



### 6 OCCUPIED BANDWIDTH MEASUREMENT

#### 6.1 Test Setup

Same as Radiated Emission Measurement

#### 6.2 Test Procedure

1. The EUT was placed on a turn table which is 0.8m above ground plane.
2. Set EUT as normal operation.
3. Based on ANSI C63.10 section 6.9.2: RBW= 30KHz. VBW= 100 KHz, Span=4MHz.
4. The useful radiated emission from the EUT was detected by the spectrum analyser with peak detector.

#### 6.3 Measurement Equipment Used

Same as Radiated Emission Measurement

#### 6.4 Test Result

**PASS**

Frequency	20dB Bandwidth (MHz)	Result
2408 MHz	2.066	<b>PASS</b>
2440 MHz	2.081	<b>PASS</b>
2474 MHz	2.096	<b>PASS</b>

CH: 2408MHz

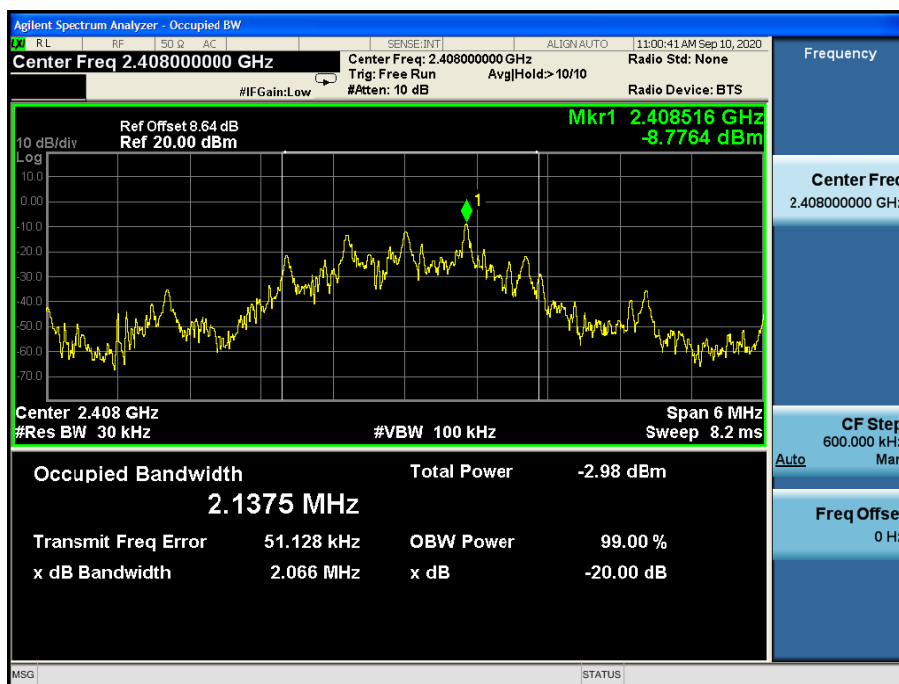



CH: 2440MHz

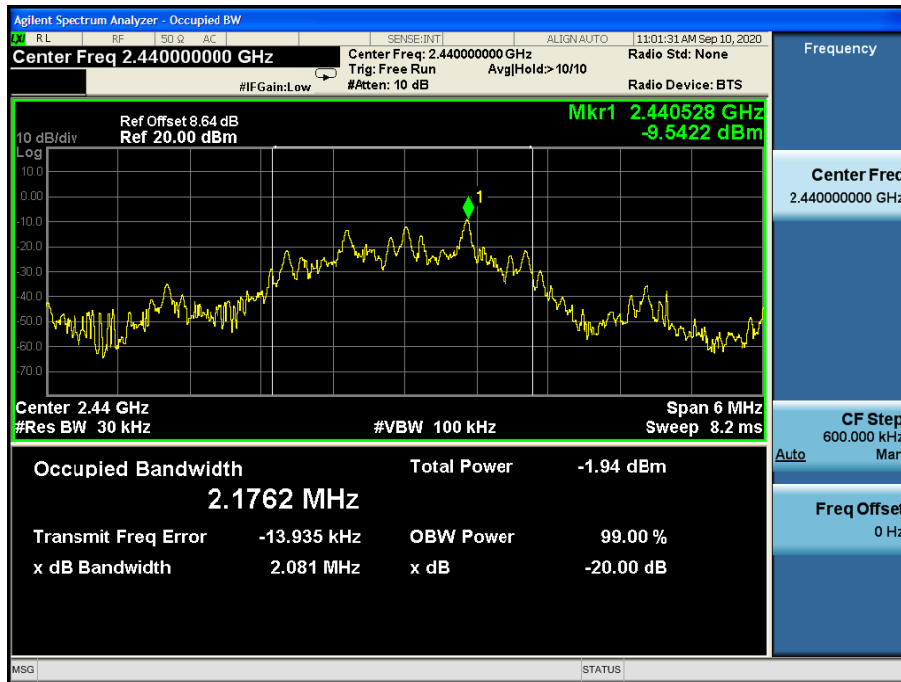

CH: 2474MHz





## 7 ANTENNA REQUIREMENT

### Standard Applicable

For intentional device, according to FCC 47 CFR Section 15.203, an intentional radiator shall be designed to ensure that no antenna other than that furnished by the responsible party shall be used with the device.

### Antenna Connected Construction

The antenna used in this product is a PCB Antenna which permanently attached. It conforms to the standard requirements, The directional gains of antenna used for transmitting is 1.5dBi.

ANTENNA

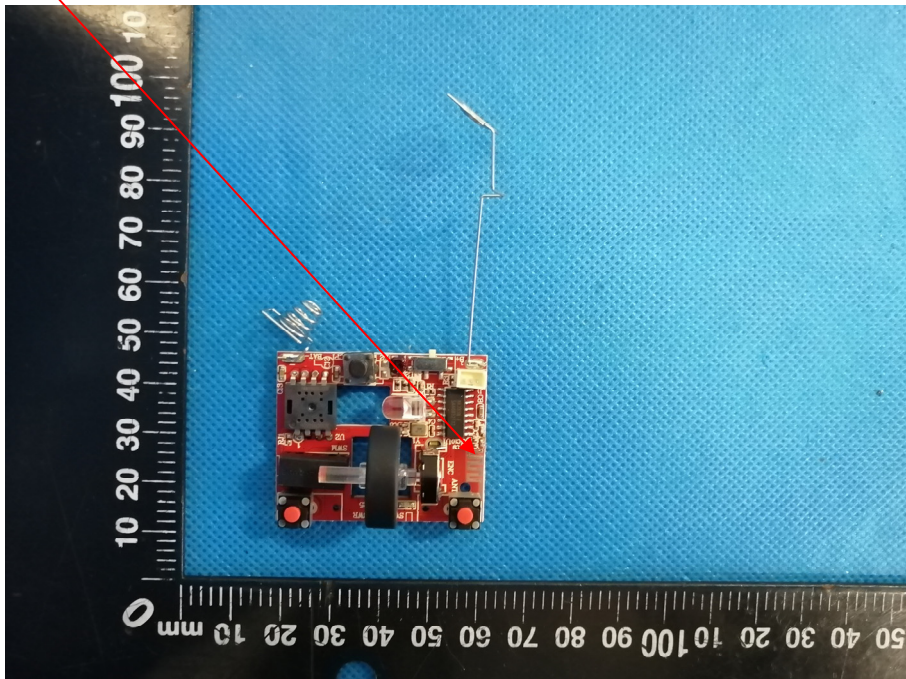



## 8 PHOTOGRAPH OF TEST

### 8.1 Radiated Emission

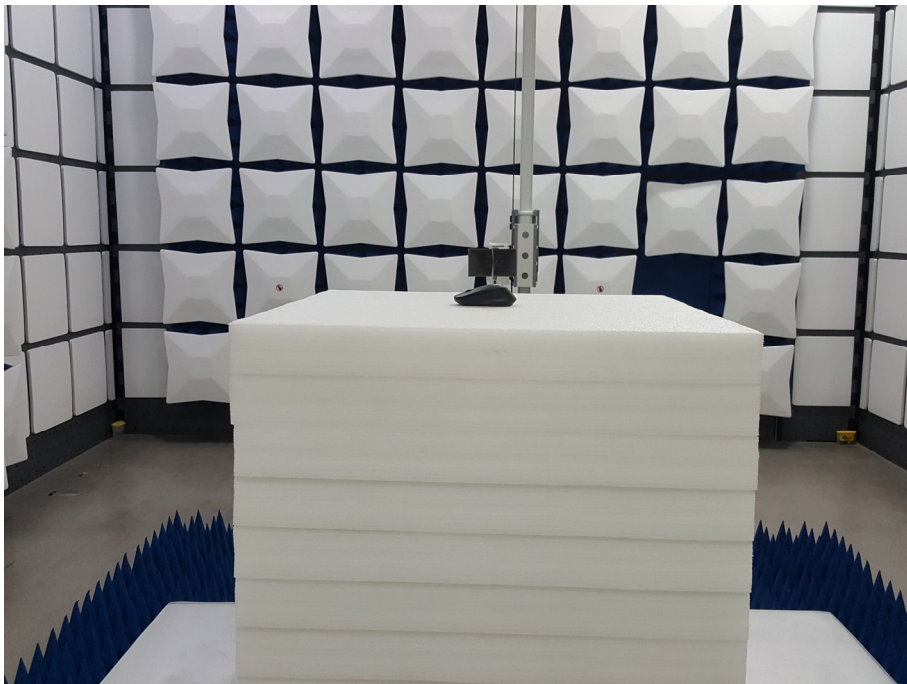
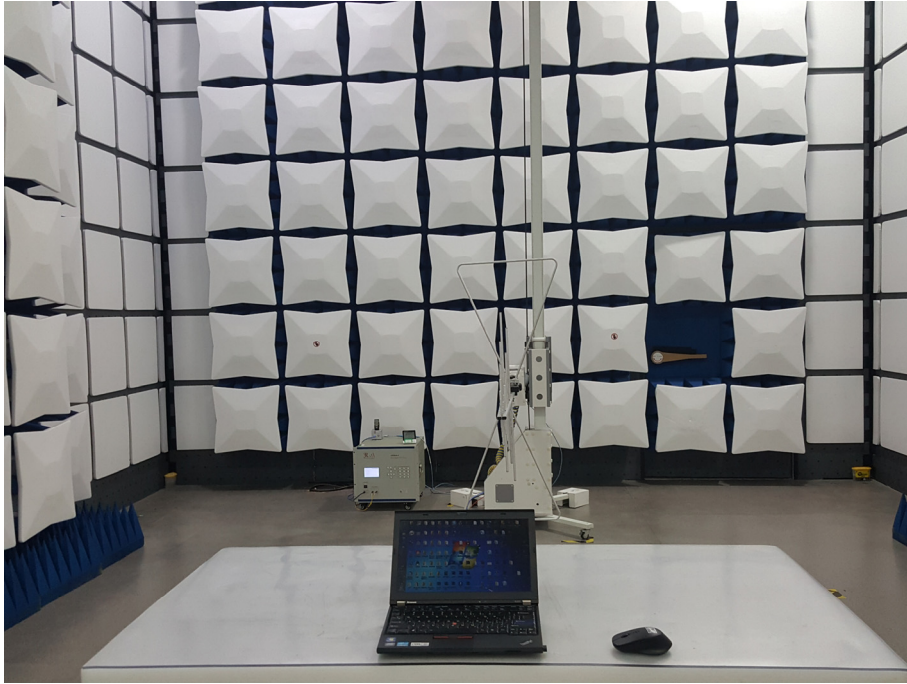

## 8.2 Conducted Emission

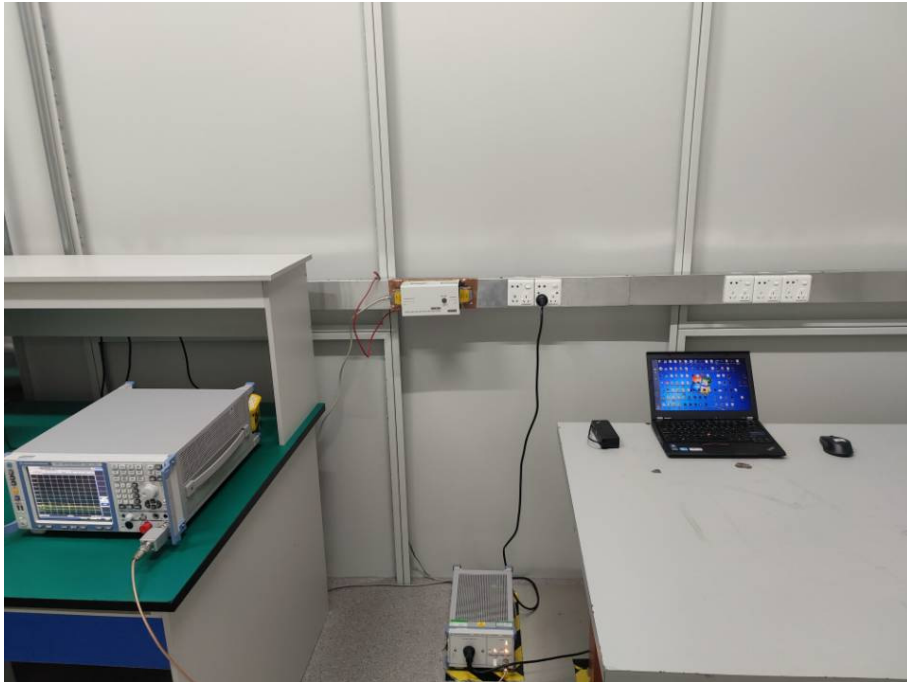



## 9 PHOTOS OF THE EUT

Reference to the reporter : ANNEX A of external photos and ANNEX B of internal photos

-----End of test report-----