

FCC TEST REPORT
for
E-Power Limited

LED Bulb BT Speaker
Model No.: Zeus-01, Zeus-02, Zeus-03, Zeus-04, Zeus-05,
Zeus-06, Zeus-07, Zeus-08, Zeus-09, Zeus-10

Prepared for : E-Power Limited
Address : 7th Floor, NO.A Building, Gangzai Henghongtai Industrial Park,
Shajing, Bao'an District, Shenzhen, Guangdong, China

Prepared By : Shenzhen Anbotek Compliance Laboratory Limited
Address : 1/F., Building 1, SEC Industrial Park, No.0409 Qianhai Road,
Nanshan District, Shenzhen, Guangdong, China
Tel: (86) 755-26066544
Fax: (86) 755-26014772

Report Number : R011605446I
Date of Test : May 16~Jun. 06, 2016
Date of Report : Jun. 07, 2016

TABLE OF CONTENTS

Description

Page

Test Report

1. GENERAL INFORMATION.....	5
1.1 Description of Device (EUT).....	5
1.2 Auxiliary Equipment Used during Test.....	6
1.3 Description of Test Facility.....	6
1.4 Measurement Uncertainty.....	6
2. TEST PROCEDURE.....	7
3. CONDUCTED EMISSION.....	8
3.1 Block Diagram of Test Setup.....	8
3.2 Power Line Conducted Emission Measurement Limits (15.207).....	8
3.3 Configuration of EUT on Measurement.....	8
3.4 Operating Condition of EUT.....	8
3.5 Test Procedure.....	9
3.6 Power Line Conducted Emission Measurement Results.....	9
4. RADIATION INTERFERENCE.....	14
4.1 Requirements (15.247, 15.209):.....	14
4.2 Test Procedure.....	14
4.3 Test Configuration.....	15
4.4 Test Results.....	16
5. CHANNEL SEPARATION TEST.....	25
5.1 Measurement Procedure.....	25
5.2 Test SET-UP.....	25
5.3 Test Equipment.....	25
5.4 Test Results.....	26
6. 20DB BANDWIDTH TEST.....	28
6.1 Measurement Procedure.....	28
6.2 Test SET-UP.....	28
6.3 Test Equipment.....	28
6.4 Test Results.....	28
7. QUANTITY OF HOPPING CHANNEL TEST.....	30
7.1 Measurement Procedure.....	30
7.2 Test SET-UP.....	30
7.3 Test Equipment.....	30
7.4 Test Results.....	30
8. DWELL TIME TEST.....	32

8.1 Measurement Procedure.....32
8.2 Test SET-UP.....32
8.3 Test Equipment.....32
8.4 Test Results.....32
9. MAXIMUM PEAK OUTPUT POWER TEST.....34
9.1 Measurement Procedure.....34
9.2 Test SET-UP.....34
9.3 Test Equipment.....34
9.4 Test Results.....35
10. BAND EDGE TEST.....37
10.1 Measurement Procedure.....37
10.2 Test SET-UP.....37
10.3 Test Equipment.....38
10.4 Test Results.....38
11. ANTENNA APPLICATION.....42
11.1 Antenna requirement.....42
11.2 Result.....42
12. PHOTOGRAPH.....43
12.1 Photo of Power Line Conducted Emission Measurement.....43
12.2 Photo of Radiation Emission Test.....43
APPENDIX I (EXTERNAL PHOTOS).....45
APPENDIX II (INTERNAL PHOTOS).....48

TEST REPORT

Applicant : E-Power Limited
Manufacturer : E-Power Limited
EUT : LED Bulb BT Speaker
Model No. : Zeus-01, Zeus-02, Zeus-03, Zeus-04, Zeus-05, Zeus-06, Zeus-07,
Zeus-08, Zeus-09, Zeus-10
Serial No. : N.A.
Trade Mark : N.A.
Rating : AC 85-260V, 50-60Hz, 0.4A, 10W

Measurement Procedure Used:

FCC Part15 Subpart C 2015, Paragraph 15.207, 15.247 & 15.209

The device described above is tested by Shenzhen Anbotek Compliance Laboratory Limited to determine the maximum emission levels emanating from the device and the severe levels of the device can endure and its performance criterion. The measurement results are contained in this test report and Shenzhen Anbotek Compliance Laboratory Limited is assumed full of responsibility for the accuracy and completeness of these measurements. Also, this report shows that the EUT (Equipment Under Test) is technically compliant with the FCC Part 15 Subpart C requirements.

This report applies to above tested sample only and shall not be reproduced in part without written approval of Shenzhen Anbotek Compliance Laboratory Limited.

Date of Test : May 16~Jun. 06, 2016

Prepared by : Kebo Zhang
(Tested Engineer / Kebo Zhang)

Reviewer : Amy Ding
(Project Manager / Amy Ding)

Approved & Authorized Signer : Tom Chen
(Manager / Tom Chen)

1. GENERAL INFORMATION

1.1 Description of Device (EUT)

EUT	: LED Bulb BT Speaker
Model Number	: Zeus-01, Zeus-02, Zeus-03, Zeus-04, Zeus-05, Zeus-06, Zeus-07, Zeus-08, Zeus-09, Zeus-10 (Note: All samples are the same except the model number and colour, so we prepare "Zeus-01" for test only.)
Test Power Supply	: AC 120V, 60Hz/ AC 240V, 60Hz/
Frequency	: 2402~2480MHz
Antenna Specification	: PCB Antenna: 1.2dBi
Modulation	: GFSK, $\pi/4$ DQPSK, 8DPSK
Applicant Address	: E-Power Limited 7th Floor, NO.A Building, Gangzai Henghongtai Industrial Park, Shajing, Bao'an District, Shenzhen, Guangdong, China
Manufacturer Address	: E-Power Limited 7th Floor, NO.A Building, Gangzai Henghongtai Industrial Park, Shajing, Bao'an District, Shenzhen, Guangdong, China
Factory Address	: E-Power Limited 7th Floor, NO.A Building, Gangzai Henghongtai Industrial Park, Shajing, Bao'an District, Shenzhen, Guangdong, China
Date of receipt	: May 16, 2016
Date of Test	: May 16~Jun. 06, 2016

1.2 Auxiliary Equipment Used during Test

N.A.

1.3 Description of Test Facility

The test facility is recognized, certified, or accredited by the following organizations:

FCC-Registration No.: 752021

Shenzhen Anbotek Compliance Laboratory Limited, EMC Laboratory has been registered and fully described in a report filed with the (FCC) Federal Communications Commission. The acceptance letter from the FCC is maintained in our files. Registration 752021, July 10, 2013.

IC-Registration No.: 8058A-1

Shenzhen Anbotek Compliance Laboratory Limited., EMC Laboratory has been registered and fully described in a report filed with the (IC) Industry Canada. The acceptance letter from the IC is maintained in our files. Registration 8058A, February 22, 2013.

Test Location

All Emissions tests were performed at Shenzhen Anbotek Compliance Laboratory Limited. at 1/F., Building 1, SEC Industrial Park, No.0409 Qianhai Road, Nanshan District, Shenzhen, Guangdong, China

1.4 Measurement Uncertainty

Radiation Uncertainty	:	Ur = 4.1 dB (Horizontal) Ur = 4.3 dB (Vertical)
Conduction Uncertainty	:	Uc = 3.4dB

2. Test Procedure

GENERAL: This report shall NOT be reproduced except in full without the written approval of Shenzhen Anbotek Compliance Laboratory Limited. The EUT was transmitting a test signal during the testing.

RADIATION INTERFERENCE: The test procedure used was ANSI STANDARD C63.10-2013 using a spectrum analyzer with a pre-selector. The analyzer was calibrated in dB above a microvolt at the output of the antenna. The resolution bandwidth was 100KHz and the video bandwidth was 300KHz up to 1.0GHz and 1.0MHz with a video BW of 3.0MHz above 1.0GHz. The ambient temperature of the EUT was 74.3oF with a humidity of 69%.

FORMULA OF CONVERSION FACTORS: The Field Strength at 3m was established by adding the meter reading of the spectrum analyzer (which is set to read in units of dBuV) to the antenna correction factor supplied by the antenna manufacturer. The antenna correction factors are stated in terms of dB. The gain of the Preselector was accounted for in the Spectrum Analyzer Meter Reading.

Example:

Freq (MHz) METER READING + ACF = FS
20 dBuV + 10.36 dB = 30.36 dBuV/m @ 3m

ANSI STANDARD C63.10-2013 10.1.7 MEASUREMENT PROCEDURES: The EUT was placed on a table 80 cm high and with dimensions of 1m by 1.5m. The EUT was placed in the center of the table (1.5m side). The table used for radiated measurements is capable of continuous rotation.

When an emission was found, the table was rotated to produce the maximum signal strength. At this point, the antenna was raised and lowered from 1m to 4m. The antenna was placed in both the horizontal and vertical planes.

3. Conducted Emission

3.1 Block Diagram of Test Setup

3.1.1. Block diagram of connection between the EUT and simulators

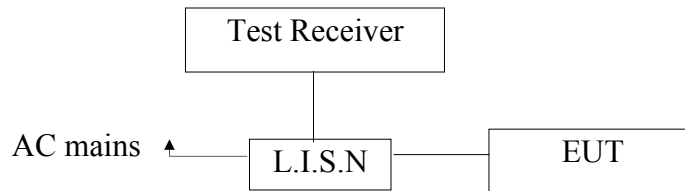

3.2 Power Line Conducted Emission Measurement Limits (15.207)

Frequency MHz	Limits dB(μV)	
	Quasi-peak Level	Average Level
0.15 ~ 0.50	66 ~ 56*	56 ~ 46*
0.50 ~ 5.00	56	46
5.00 ~ 30.00	60	50

- Notes: 1. *Decreasing linearly with logarithm of frequency.
2. The lower limit shall apply at the transition frequencies.

3.3 Configuration of EUT on Measurement

The following equipments are installed on Power Line Conducted Emission Measurement to meet the commission requirement and operating regulations in a manner which tends to maximize its emission characteristics in a normal application.

3.4 Operating Condition of EUT

- 3.4.1. Setup the EUT and simulator as shown as Section 3.1.
- 3.4.2. Turn on the power of all equipment.
- 3.4.3. Let the EUT work in test mode (On) and measure it.

3.5 Test Procedure

The EUT system is connected to the power mains through a line impedance stabilization network (L.I.S.N.). This provides a 50ohm coupling impedance for the EUT system. Please refer the block diagram of the test setup and photographs. Both sides of AC line are checked to find out the maximum conducted emission. In order to find the maximum emission levels, the relative positions of equipment and all of the interface cables shall be changed according to FCC ANSI C63.10-2013 on Conducted Emission Measurement.

The bandwidth of test receiver (ESCI) set at 9KHz.

The frequency range from 150KHz to 30MHz is checked.

The test results are reported on Section 3.6.

Test Equipment

Item	Equipment	Manufacturer	Model No.	Serial No.	Last Cal.	Cal. Interval
1.	Two-Line V-network	Rohde & Schwarz	ENV216	100055	Apr. 17, 2016	1 Year
2.	EMI Test Receiver	Rohde & Schwarz	ESCI	100627	Apr. 17, 2016	1 Year
3.	RF Switching Unit	Compliance Direction	RSU-M2	38303	Apr. 17, 2016	1 Year

3.6 Power Line Conducted Emission Measurement Results

PASS.

The frequency range from 150KHz to 30 MHz is investigated.

Please refer the following pages.

CONDUCTED EMISSION TEST DATA

Test Site: 1# Shielded Room
 Operating Condition: On
 Test Specification: AC 120V, 60Hz
 Comment: Live Line
 Tem.:24°C Hum.:48%

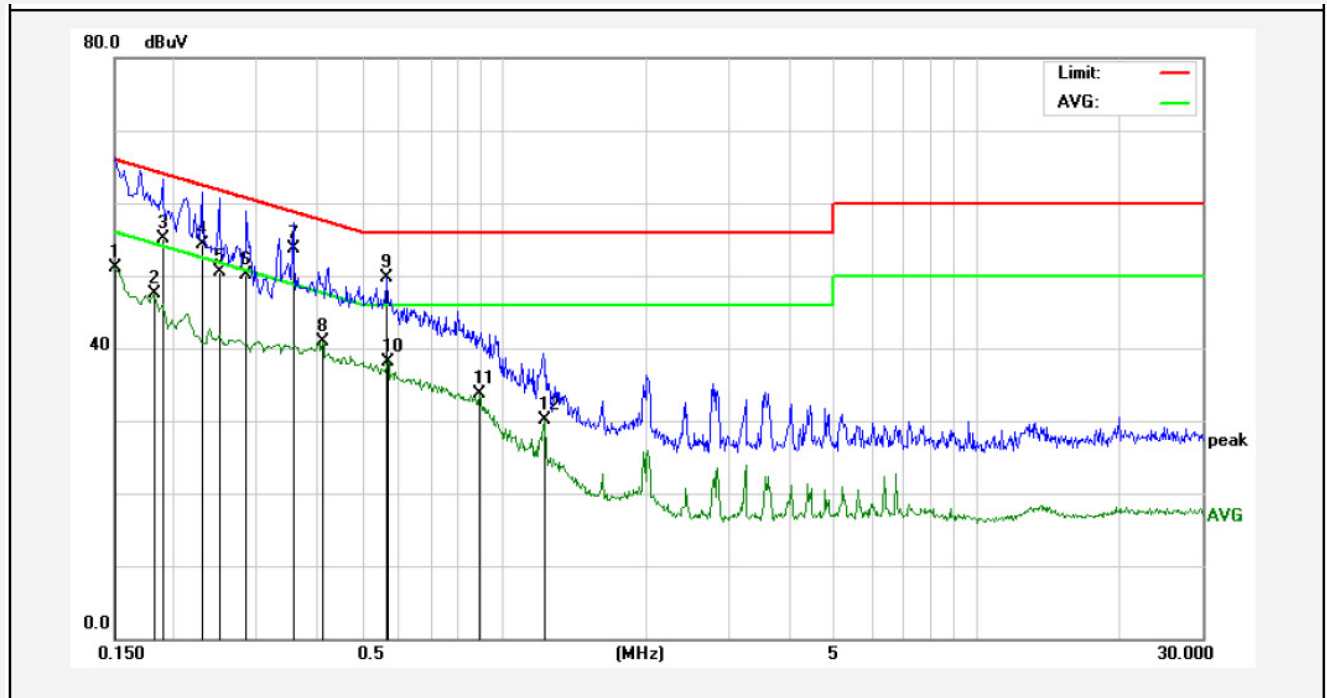

No.	Freq. (MHz)	Reading (dBuV)	Factor (dB)	Result (dBuV)	Limit dBuV	Over Limit (dB)	Detector	Remark
1	0.1499	31.05	20.00	51.05	56.00	-4.95	AVG	
2	0.1819	27.43	20.00	47.43	54.39	-6.96	AVG	
3	0.1900	35.13	20.00	55.13	64.03	-8.90	QP	
4	0.2300	34.24	20.00	54.24	62.45	-8.21	QP	
5	0.2500	30.44	20.00	50.44	61.75	-11.31	QP	
6	0.2860	30.15	20.00	50.15	60.64	-10.49	QP	
7	0.3580	33.69	20.00	53.69	58.77	-5.08	QP	
8	0.4140	20.83	20.00	40.83	47.57	-6.74	AVG	
9	0.5660	29.66	20.00	49.66	56.00	-6.34	QP	
10	0.5700	18.09	20.00	38.09	46.00	-7.91	AVG	
11	0.8860	13.69	20.00	33.69	46.00	-12.31	AVG	
12	1.2180	10.04	20.00	30.04	46.00	-15.96	AVG	

CONDUCTED EMISSION TEST DATA

Test Site: 1# Shielded Room
 Operating Condition: On
 Test Specification: AC 120V, 60Hz
 Comment: Neutral Line
 Tem.:24°C Hum.:48%

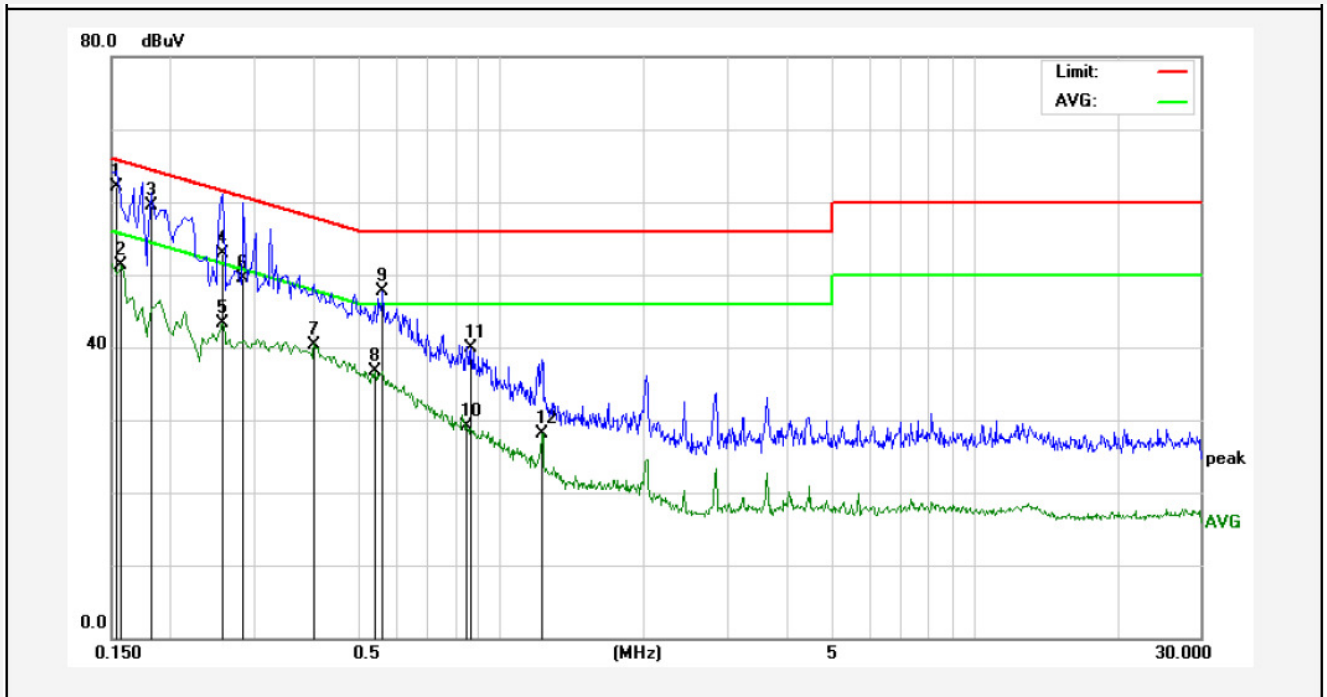

No.	Freq. (MHz)	Reading (dBuV)	Factor (dB)	Result (dBuV)	Limit dBuV	Over Limit (dB)	Detector	Remark
1	0.1539	42.15	20.00	62.15	65.78	-3.63	QP	
2	0.1580	31.32	20.00	51.32	55.56	-4.24	AVG	
3	0.1819	39.48	20.00	59.48	64.39	-4.91	QP	
4	0.2580	32.95	20.00	52.95	61.49	-8.54	QP	
5	0.2580	23.37	20.00	43.37	51.49	-8.12	AVG	
6	0.2860	29.57	20.00	49.57	60.64	-11.07	QP	
7	0.4020	20.40	20.00	40.40	47.81	-7.41	AVG	
8	0.5420	16.80	20.00	36.80	46.00	-9.20	AVG	
9	0.5620	27.74	20.00	47.74	56.00	-8.26	QP	
10	0.8460	9.14	20.00	29.14	46.00	-16.86	AVG	
11	0.8620	19.98	20.00	39.98	56.00	-16.02	QP	
12	1.2220	8.16	20.00	28.16	46.00	-17.84	AVG	

CONDUCTED EMISSION TEST DATA

Test Site: 1# Shielded Room
 Operating Condition: On
 Test Specification: AC 240V, 60Hz
 Comment: Live Line
 Tem.:24°C Hum.:48%

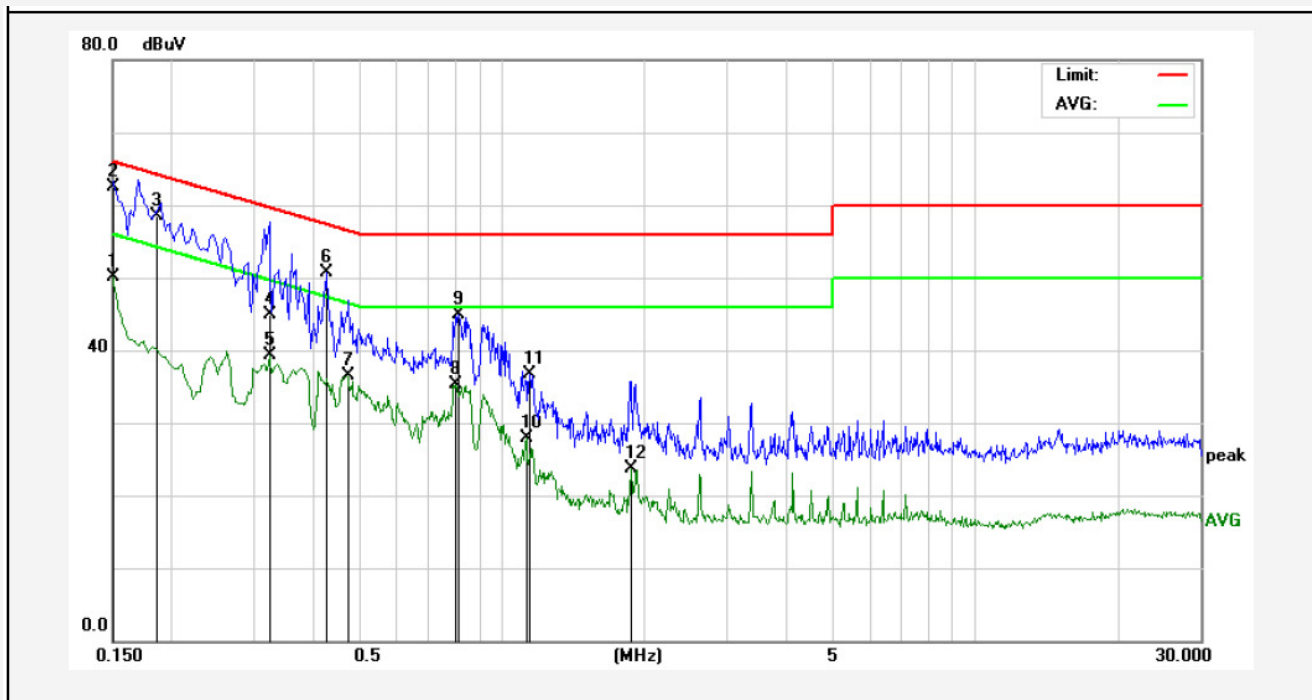

No.	Freq. (MHz)	Reading (dBuV)	Factor (dB)	Result (dBuV)	Limit dBuV	Over Limit (dB)	Detector	Remark
1	0.1499	30.12	20.00	50.12	56.00	-5.88	AVG	
2	0.1500	42.48	20.00	62.48	65.99	-3.51	QP	
3	0.1860	38.44	20.00	58.44	64.21	-5.77	QP	
4	0.3220	24.87	20.00	44.87	59.65	-14.78	QP	
5	0.3220	19.26	20.00	39.26	49.65	-10.39	AVG	
6	0.4260	30.77	20.00	50.77	57.33	-6.56	QP	
7	0.4700	16.51	20.00	36.51	46.51	-10.00	AVG	
8	0.7980	15.24	20.00	35.24	46.00	-10.76	AVG	
9	0.8100	24.97	20.00	44.97	56.00	-11.03	QP	
10	1.1260	7.91	20.00	27.91	46.00	-18.09	AVG	
11	1.1420	16.69	20.00	36.69	56.00	-19.31	QP	
12	1.8740	3.66	20.00	23.66	46.00	-22.34	AVG	

CONDUCTED EMISSION TEST DATA

Test Site: 1# Shielded Room
 Operating Condition: On
 Test Specification: AC 240V, 60Hz
 Comment: Neutral Line
 Tem.:24°C Hum.:48%

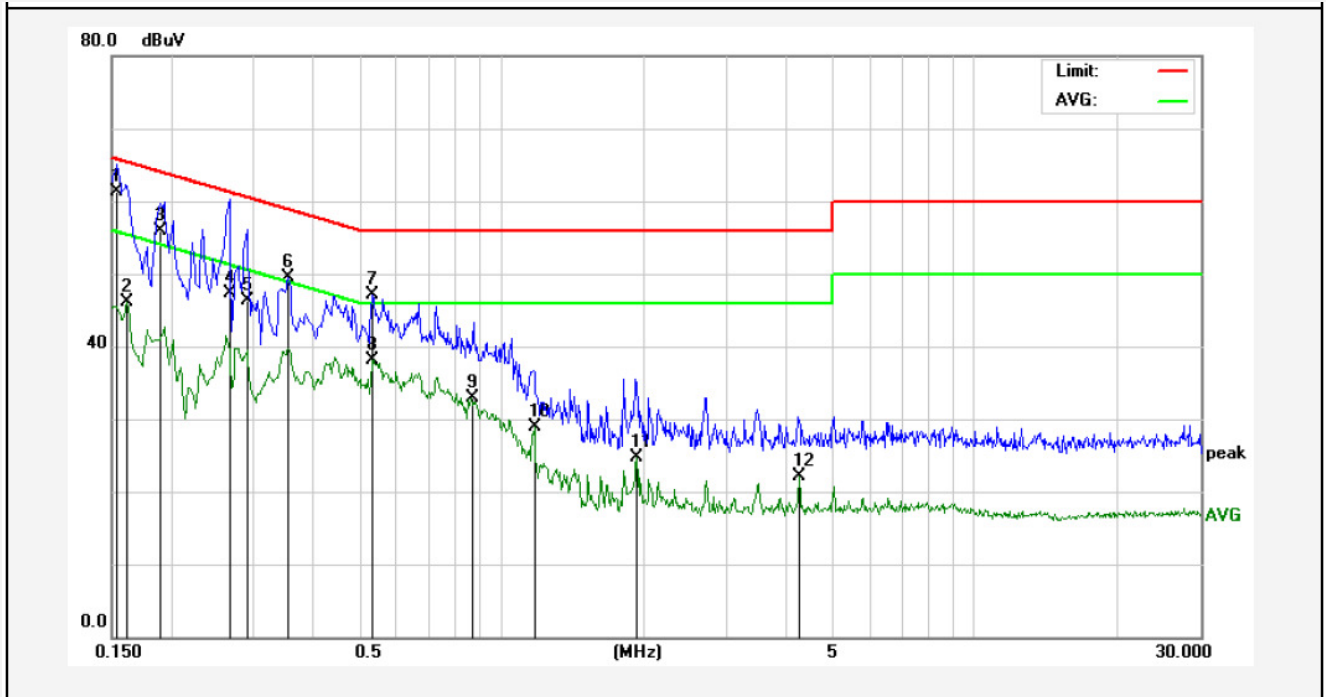

No.	Freq. (MHz)	Reading (dBuV)	Factor (dB)	Result (dBuV)	Limit dBuV	Over Limit (dB)	Detector	Remark
1	0.1539	41.33	20.00	61.33	65.78	-4.45	QP	
2	0.1620	26.03	20.00	46.03	55.36	-9.33	AVG	
3	0.1900	35.95	20.00	55.95	64.03	-8.08	QP	
4	0.2660	27.33	20.00	47.33	61.24	-13.91	QP	
5	0.2900	26.28	20.00	46.28	60.52	-14.24	QP	
6	0.3540	29.44	20.00	49.44	58.87	-9.43	QP	
7	0.5340	27.07	20.00	47.07	56.00	-8.93	QP	
8	0.5340	18.15	20.00	38.15	46.00	-7.85	AVG	
9	0.8620	12.81	20.00	32.81	46.00	-13.19	AVG	
10	1.1780	8.82	20.00	28.82	46.00	-17.18	AVG	
11	1.9380	4.68	20.00	24.68	46.00	-21.32	AVG	
12	4.2660	2.06	20.00	22.06	46.00	-23.94	AVG	

4. Radiation Interference

4.1 Requirements (15.247, 15.209):

4.1.1. Test Limits (< 30 MHz)

Frequency (MHz)	Field Strength (microvolts/meter)	Measurement Distance (meter)
0.009-0.490	2400/F(kHz)	300
0.490-1.705	24000/F(kHz)	30
1.705-30.0	30	30

4.1.2. Test Limits (≥ 30 MHz)

FIELD STRENGTH of Fundamental: @3M	FIELD STRENGTH of Harmonics	S15.209	
902-928 MHz		30 - 88 MHz	40 dBuV/m
2.4-2.4835 GHz		88 - 216 MHz	43.5
94 dBuV/m @3m	54 dBuV/m @3m	216 - 960 MHz	46
		ABOVE 960 MHz	54dBuV/m

For range 9KHz~30MHz, The measured value is really too low to be recorded.

Emissions radiated outside of the specified frequency bands, except for harmonics, shall be attenuated by at least 50 dB below the level of the fundamental or to the general radiated emission limits in 15.209, whichever is the lesser attenuation.

4.2 Test Procedure

For below 1GHz: The EUT is placed on a turntable, which is 0.8m above the ground plane.
 For above 1GHz: The EUT is placed on a turntable, which is 1.5m above the ground plane.
 The turn table can rotate 360 degrees to determine the position of the maximum emission level.
 The EUT is set 3 meters away from the receiving antenna which is mounted on a antenna tower.
 The antenna can be moved up and down from 1 to 4 meters to find out the maximum emission level. Rotated the EUT through three orthogonal axes to determine the maximum emissions, both horizontal and vertical polarization of the antenna are set on test. The EUT is tested in 9*6*6 Chamber. The device is evaluated in xyz orientation.

For 30MHz to 1000MHz:

Set the spectrum analyzer as:
 RBW = 100kHz, VBW =300kHz,
 Detector= Quasi-Peak
 Trace mode= Max hold.
 Sweep- auto couple.

For Above 1GHz:

Set the spectrum analyzer as:
 RBW = 1MHz, VBW =3MHz,
 Detector= Peak
 Trace mode= Max hold.
 Sweep- auto couple.

Set the spectrum analyzer as:
RBW =1MHz, VBW =10Hz
Detector= Average
Trace mode= Max hold.
Sweep- auto couple.

Test Equipment

Item	Equipment	Manufacturer	Model No.	Serial No.	Last Cal.	Cal. Interval
1.	Spectrum Analysis	Agilent	E4407B	US39390582	Apr. 17, 2016	1 Year
2.	Preamplifier	Instruments corporation	EMC011830	980100	Apr. 17, 2016	1 Year
3.	EMI Test Receiver	Rohde & Schwarz	ESPI	101604	Apr. 17, 2016	1 Year
4.	Double Ridged Horn Antenna	Instruments corporation	GTH-0118	351600	Apr. 20, 2016	1 Year
5.	Bilog Broadband Antenna	Schwarzbeck	VULB9163	VULB 9163-289	Apr. 20, 2016	1 Year
6.	Pre-amplifier	SONOMA	310N	186860	Apr. 17, 2016	1 Year
7.	EMI Test Software EZ-EMC	SHURPLE	N/A	N/A	N/A	N/A
8	Power Sensor	DAER	RPR3006W	15I00041SN046	Jun 30, 2015	1 Year
9	MXA Spectrum Analysis	Agilent	N9020A	MY51170037	Jun 30, 2015	1 Year
10	MXG RF Vector Signal Generator	Agilent	N5182A	MY48180656	Jun 30, 2015	1 Year
11	Signal Generator	Agilent	E4421B	MY41000743	Jun 30, 2015	1 Year
12	DC Power supply	IV	IV-8080	YQSB0096	Jun 30, 2015	1 Year
13	TEMP&HUMI PROGRAMMABLE CHAMBER	Bell Group	BE-THK-150M8	SE-0137	Mar 16, 2016	1 Year

4.3 Test Configuration

4.3.1. 9k to 30MHz emissions:

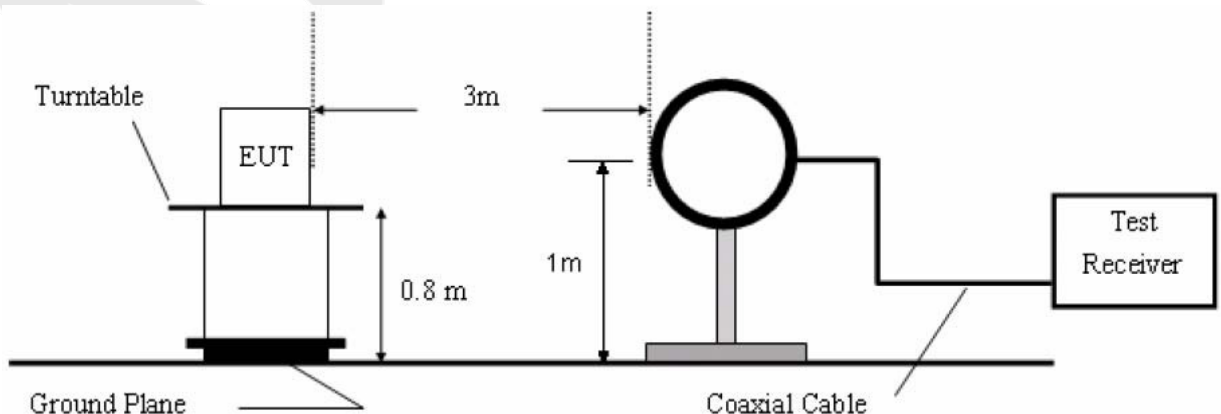

4.3.2. 30M to 1G emissions:

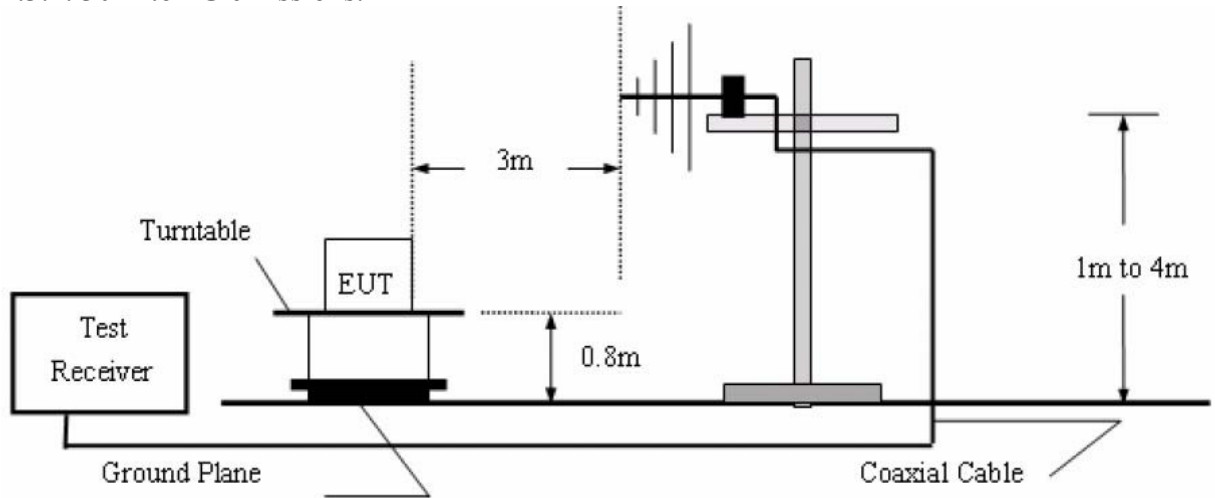

4.3.3. 1G to 40G emissions:

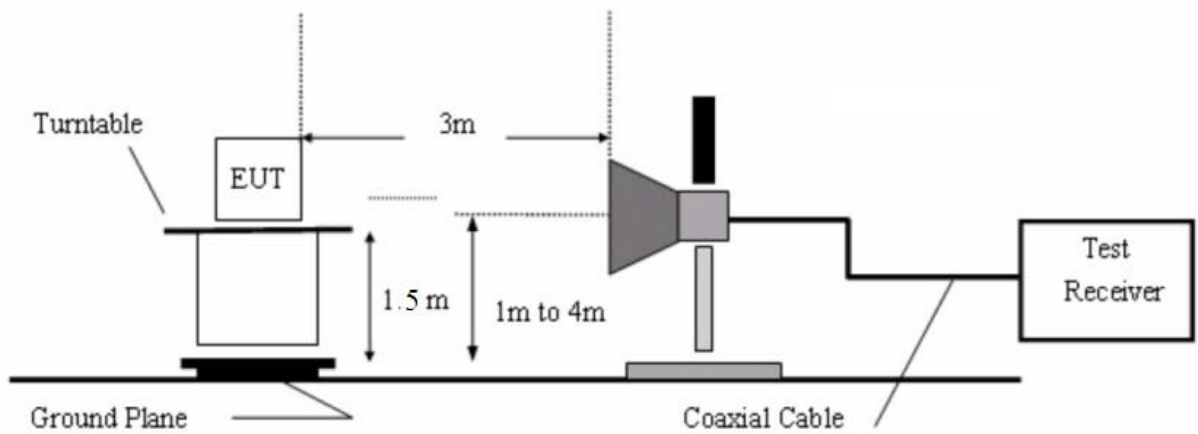

4.4 Test Results

PASS.

Please refer the following pages. Only the worst case (x orientation).

The EDR was tested on ($\pi/4$ DQPSK, 8DPSK) modes, only the worst data of ($\pi/4$ DQPSK) is attached in the following pages.

The test results of above 18000MHz are attenuated more than 20dB below the permissible limits, so the results don't record in the report.

Job No.:	0116054461	Plarization:	Horizontal
Standard:	(RE)FCC PART 15C _3m	Power Source:	AC 120V, 60Hz
Test item:	Radiation Test (30~1000MHz)	Temp.(C)/Hum.(%RH):	24.4(C)/52%RH
Test Mode:	On	Distance:	3m

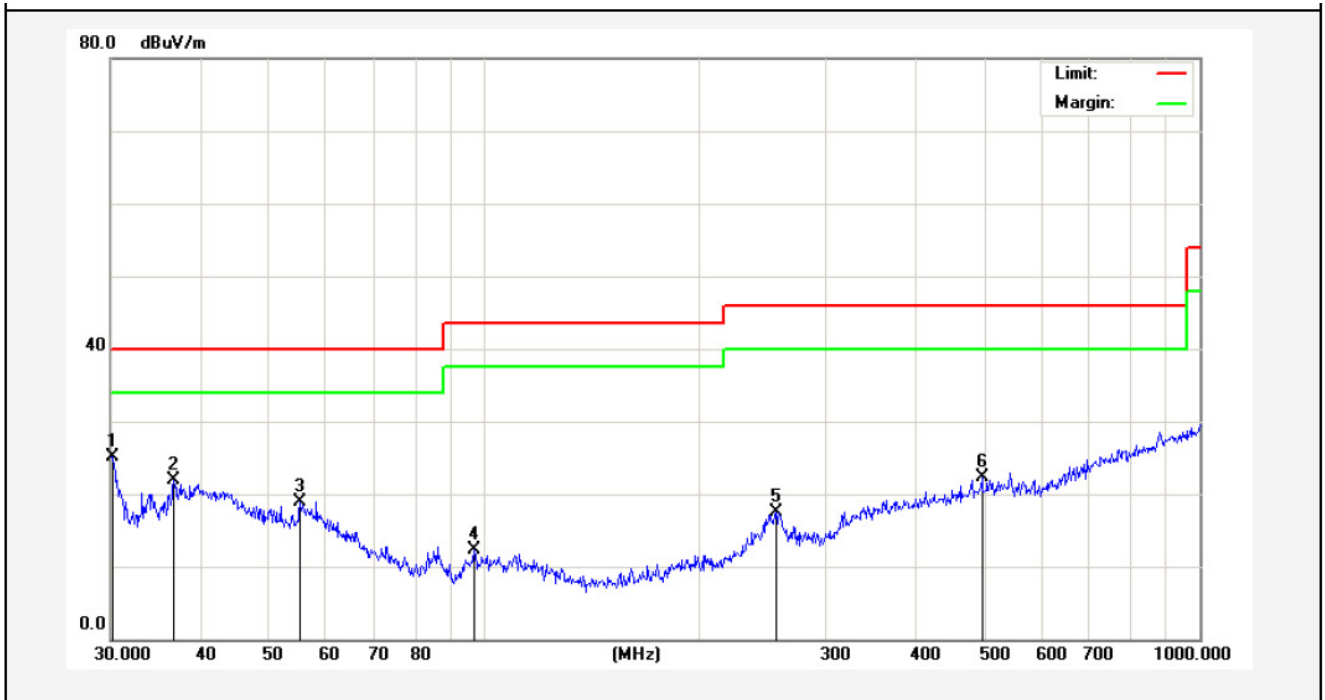

No.	Freq. (MHz)	Reading (dBuV/m)	Factor (dB/m)	Result (dBuV/m)	Limit (dBuV/)	Over Limit (dB)	Detector	Height (cm)	degree (deg)	Remark
1	30.2111	41.93	-16.84	25.09	40.00	-14.91	peak			
2	36.7662	34.89	-12.91	21.98	40.00	-18.02	peak			
3	55.2207	33.88	-14.94	18.94	40.00	-21.06	peak			
4	96.7749	33.20	-20.93	12.27	43.50	-31.23	peak			
5	255.6231	36.37	-18.80	17.57	46.00	-28.43	peak			
6	495.9344	33.38	-11.06	22.32	46.00	-23.68	peak			

Job No.:	0116054461	Plarization:	Vertical
Standard:	(RE)FCC PART 15C _3m	Power Source:	AC 120V, 60Hz
Test item:	Radiation Test (30~1000MHz)	Temp.(C)/Hum.(%RH):	24.4(C)/52 %RH
Test Mode:	On	Distance:	3m

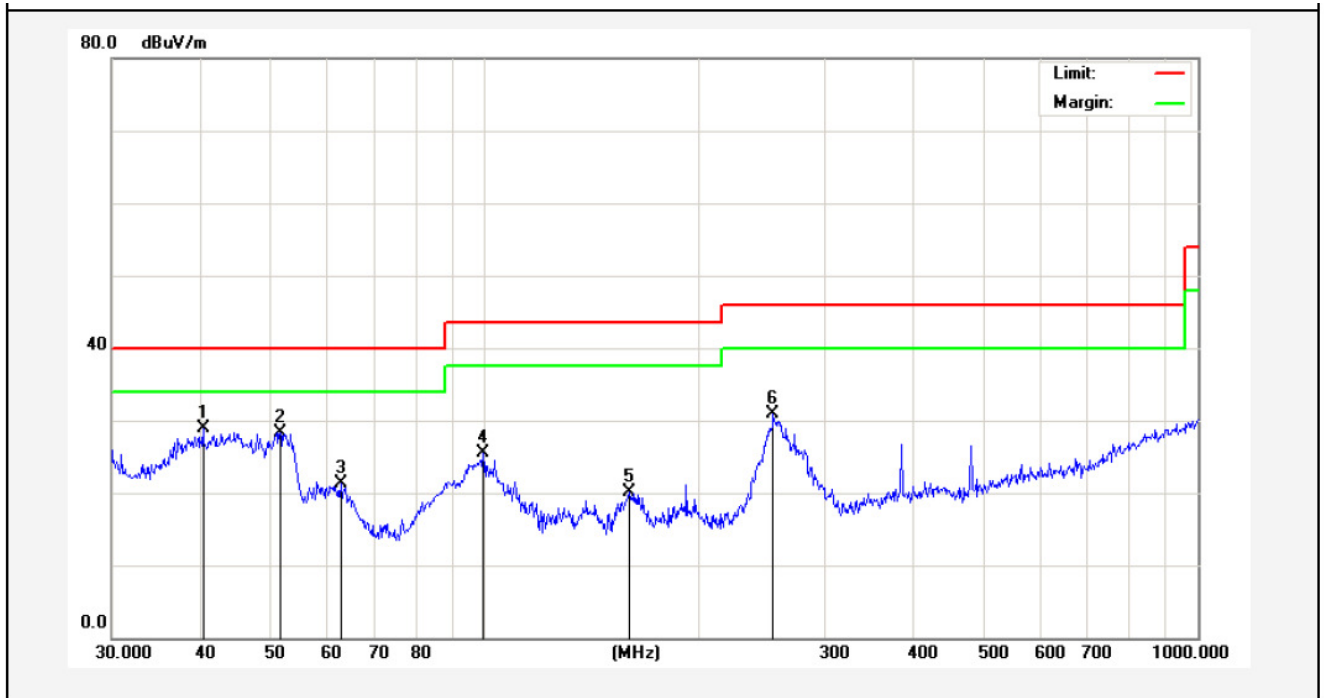

No.	Freq. (MHz)	Reading (dBuV/m)	Factor (dB/m)	Result (dBuV/m)	Limit (dBuV/)	Over Limit (dB)	Detector	Height (cm)	degree (deg)	Remark
1	40.2757	39.36	-10.48	28.88	40.00	-11.12	peak			
2	51.6616	43.07	-14.69	28.38	40.00	-11.62	peak			
3	62.8708	37.84	-16.59	21.25	40.00	-18.75	peak			
4	99.5281	41.20	-15.79	25.41	43.50	-18.09	peak			
5	159.2251	37.97	-17.91	20.06	43.50	-23.44	peak			
6	253.8367	45.01	-14.03	30.98	46.00	-15.02	peak			

Job No.:	011605446I	Plarization:	Horizontal
Standard:	(RE)FCC PART 15C_Class B_3m	Power Source:	AC 120V, 60Hz
Test item:	Radiation Test (Above 1GHz)	Temp.(C)/Hum.(%RH):	24.4(C)/52%RH
Test Mode:	TX(2402 MHz)	Distance:	3m

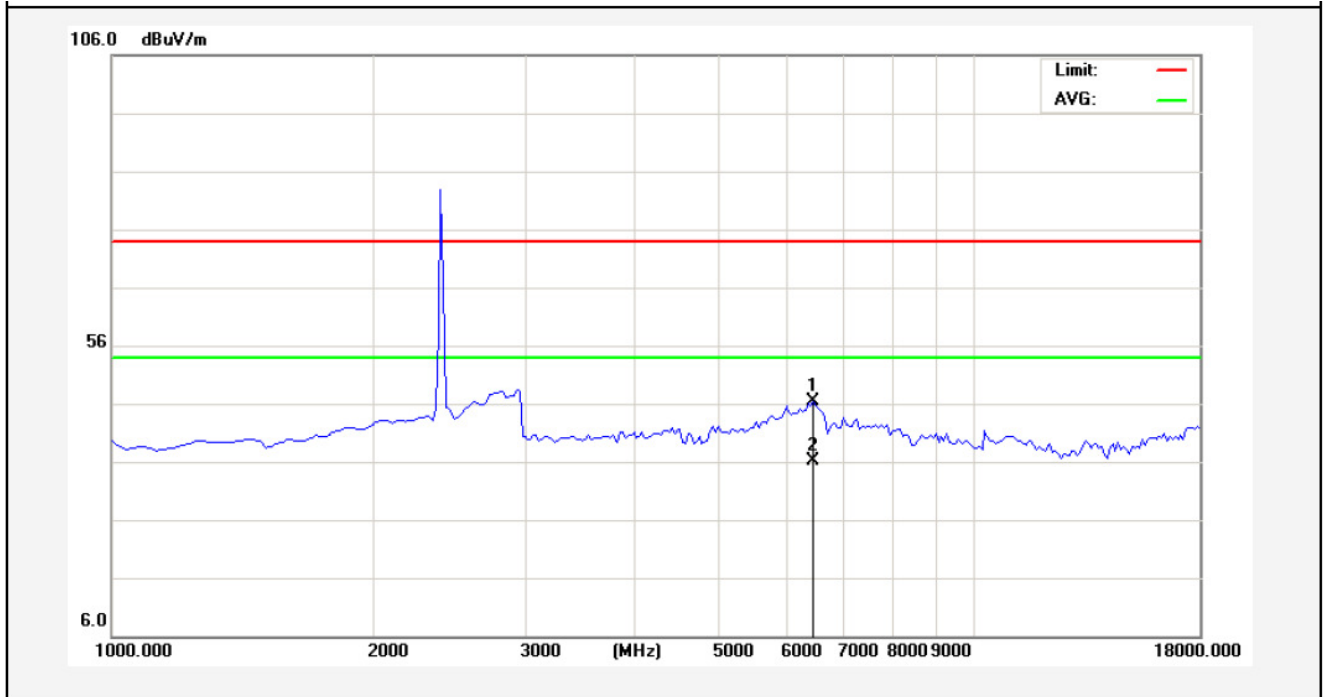

No.	Freq. (MHz)	Reading (dBuV/m)	Factor (dB/m)	Result (dBuV/m)	Limit (dBuV/)	Over Limit (dB)	Detector	Height (cm)	degree (deg)	Remark
1	6482.500	38.72	7.58	46.30	74.00	-27.70	peak			
2	6482.500	28.55	7.58	36.13	54.00	-17.87	AVG			

Job No.:	011605446I	Plarization:	Vertical
Standard:	(RE)FCC PART 15C_Class B_3m	Power Source:	AC 120V, 60Hz
Test item:	Radiation Test (Above 1GHz)	Temp.(C)/Hum.(%RH):	24.4(C)/52%RH
Test Mode:	TX(2402 MHz)	Distance:	3m

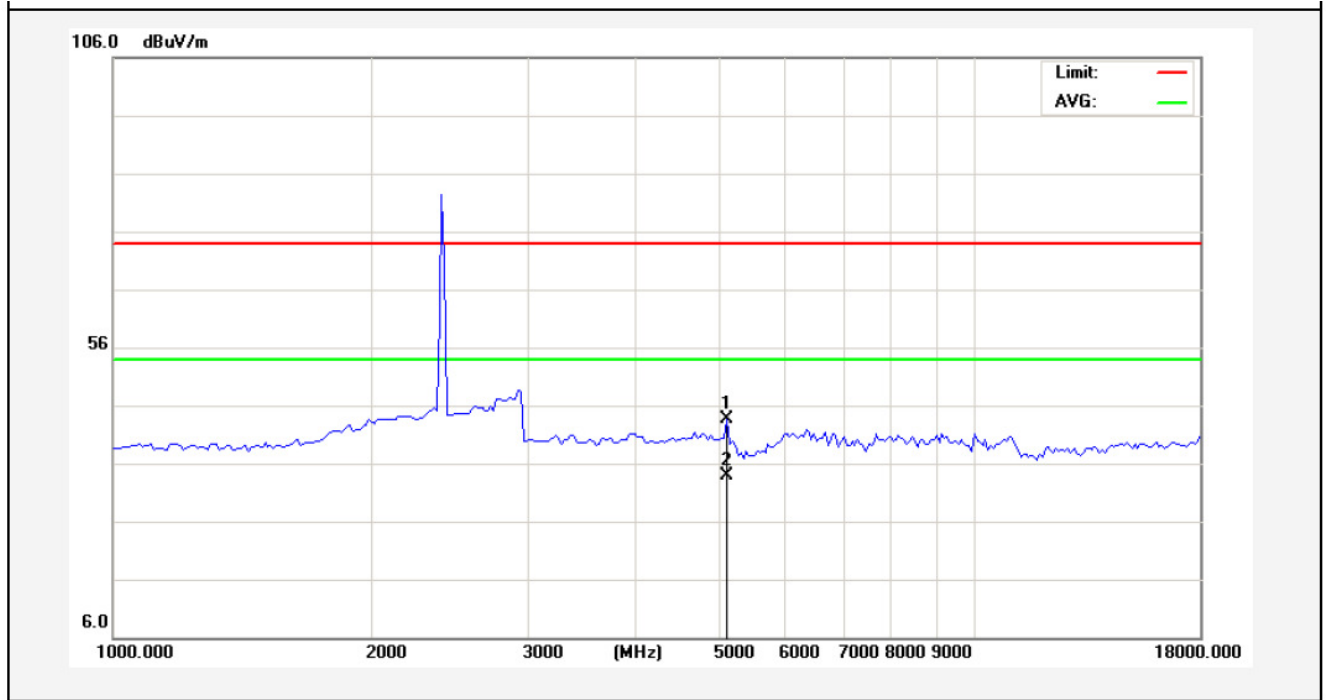

No.	Freq. (MHz)	Reading (dBuV/m)	Factor (dB/m)	Result (dBuV/m)	Limit (dBuV/)	Over Limit (dB)	Detector	Height (cm)	degree (deg)	Remark
1	5122.500	39.91	3.73	43.64	74.00	-30.36	peak			
2	5122.500	30.11	3.73	33.84	54.00	-20.16	AVG			

Job No.:	0116054461	Plarization:	Horizontal
Standard:	(RE)FCC PART 15C_Class B_3m	Power Source:	AC 120V, 60Hz
Test item:	Radiation Test (Above 1GHz)	Temp.(C)/Hum.(%RH):	24.4(C)/52%RH
Test Mode:	TX(2441 MHz)	Distance:	3m

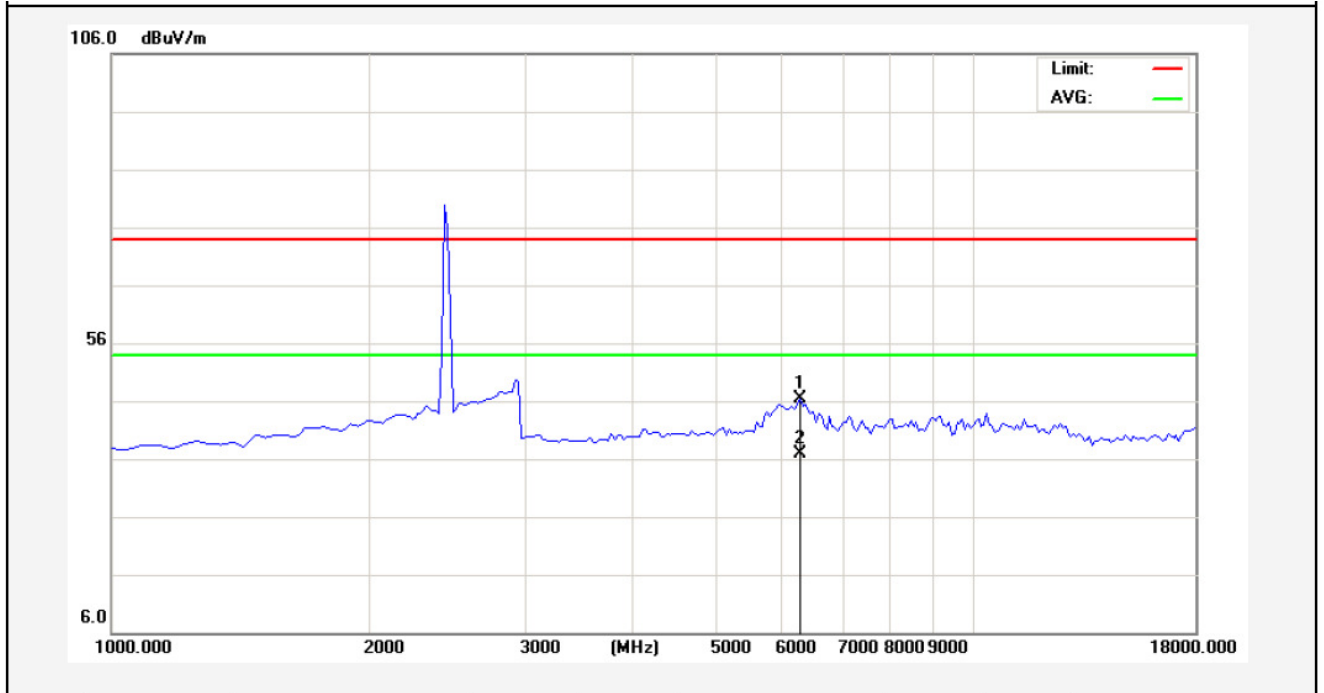

No.	Freq. (MHz)	Reading (dBuV/m)	Factor (dB/m)	Result (dBuV/m)	Limit (dBuV/)	Over Limit (dB)	Detector	Height (cm)	degree (deg)	Remark
1	6312.500	39.01	7.42	46.43	74.00	-27.57	peak			
2	6312.500	29.51	7.42	36.93	54.00	-17.07	AVG			

Job No.:	011605446I	Plarization:	Vertical
Standard:	(RE)FCC PART 15C_Class B_3m	Power Source:	AC 120V, 60Hz
Test item:	Radiation Test (Above 1GHz)	Temp.(C)/Hum.(%RH):	24.4(C)/52%RH
Test Mode:	TX(2441 MHz)	Distance:	3m

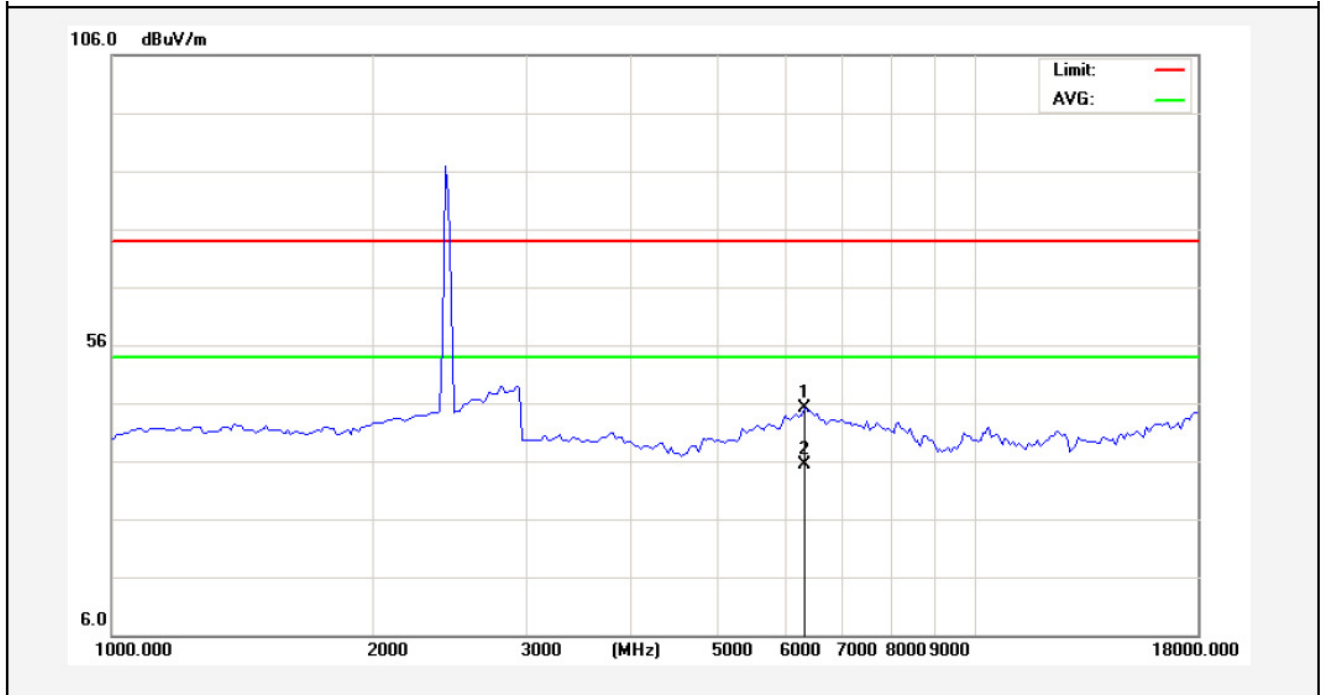

No.	Freq. (MHz)	Reading (dBuV/m)	Factor (dB/m)	Result (dBuV/m)	Limit (dBuV/)	Over Limit (dB)	Detector	Height (cm)	degree (deg)	Remark
1	6355.000	37.64	7.46	45.10	74.00	-28.90	peak			
2	6355.000	28.00	7.46	35.46	54.00	-18.54	AVG			

Job No.:	0116054461	Plarization:	Horizontal
Standard:	(RE)FCC PART 15C_Class B_3m	Power Source:	AC 120V, 60Hz
Test item:	Radiation Test (Above 1GHz)	Temp.(C)/Hum.(%RH):	24.4(C)/52%RH
Test Mode:	TX(2480 MHz)	Distance:	3m

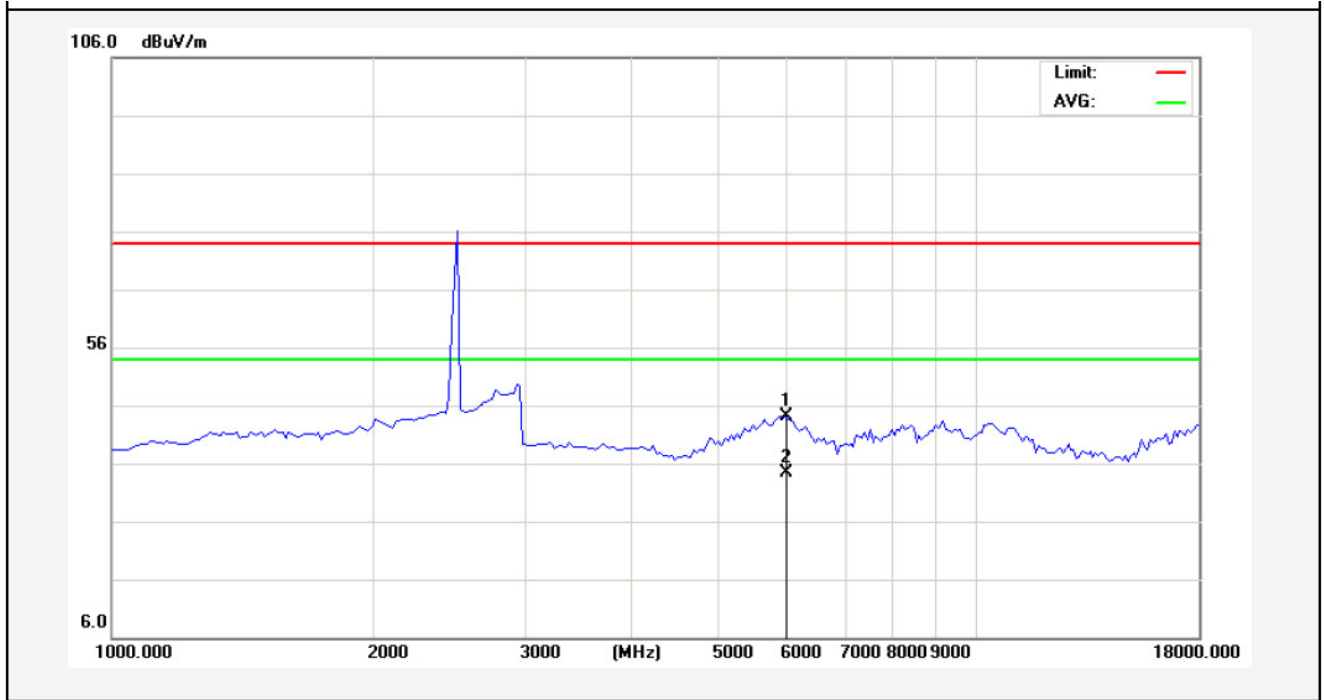

No.	Freq. (MHz)	Reading (dBuV/m)	Factor (dB/m)	Result (dBuV/m)	Limit (dBuV/)	Over Limit (dB)	Detector	Height (cm)	degree (deg)	Remark
1	6015.000	37.00	7.14	44.14	74.00	-29.86	peak			
2	6015.000	27.19	7.14	34.33	54.00	-19.67	AVG			

Job No.:	011605446I	Plarization:	Vertical
Standard:	(RE)FCC PART 15C_Class B_3m	Power Source:	AC 120V, 60Hz
Test item:	Radiation Test (Above 1GHz)	Temp.(C)/Hum.(%RH):	24.4(C)/52%RH
Test Mode:	TX(2480 MHz)	Distance:	3m

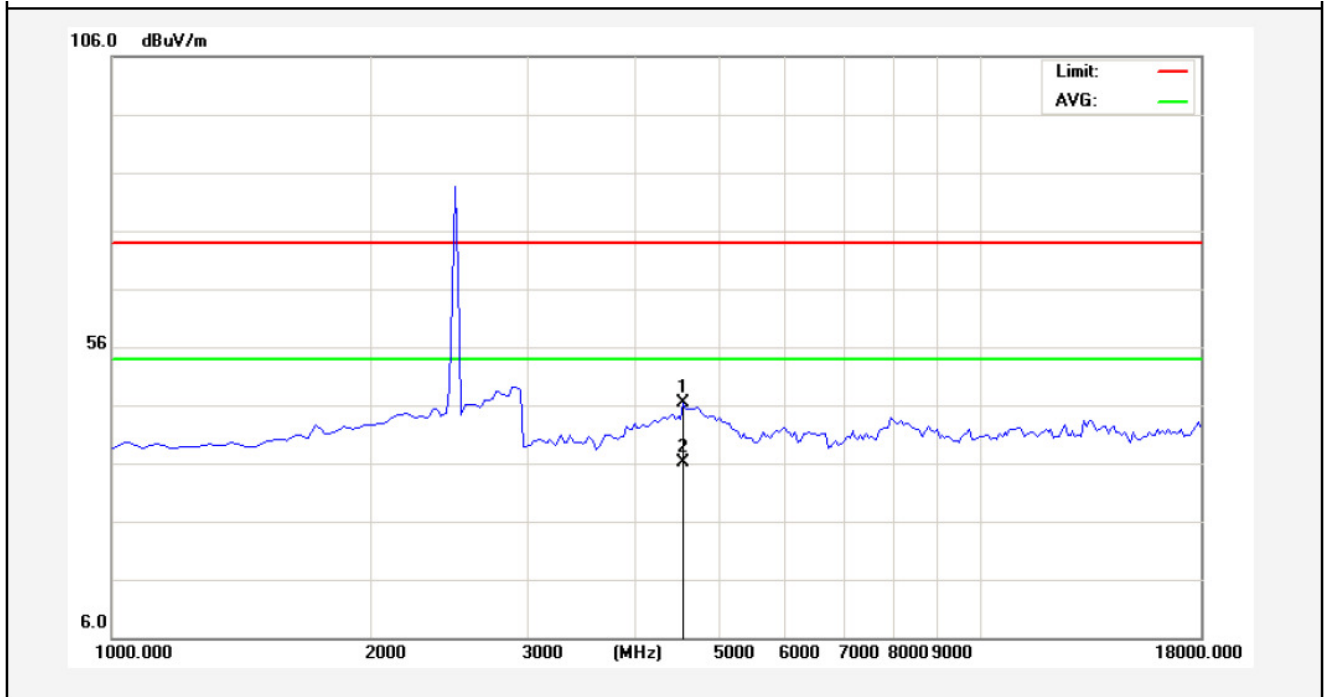

No.	Freq. (MHz)	Reading (dBuV/m)	Factor (dB/m)	Result (dBuV/m)	Limit (dBuV/)	Over Limit (dB)	Detector	Height (cm)	degree (deg)	Remark
1	4570.000	43.46	2.88	46.34	74.00	-27.66	peak			
2	4570.000	33.22	2.88	36.10	54.00	-17.90	AVG			

5. CHANNEL SEPARATION TEST

5.1 Measurement Procedure

The EUT must have its hopping function enabled. Using the following spectrum analyzer settings:

1. Span= Wide enough to capture the peaks of two adjacent channels
2. Set the RBW = 100 kHz.
3. Set the VBW = 1.0 MHz.
4. Sweep time = auto couple.
5. Detector function = peak.
6. Trace mode = max hold.
7. Allow trace to fully stabilize.

5.2 Test SET-UP

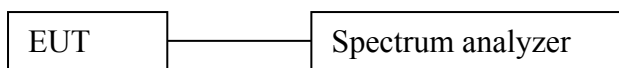

5.3 Test Equipment

Item	Equipment	Manufacturer	Model No.	Serial No.	Last Cal.	Cal. Interval
1.	Spectrum Analysis	Agilent	E4407B	US39390582	Apr. 17, 2016	1 Year
2.	Preamplifier	Instruments corporation	EMC011830	980100	Apr. 17, 2016	1 Year
3.	EMI Test Receiver	Rohde & Schwarz	ESPI	101604	Apr. 17, 2016	1 Year
4.	Double Ridged Horn Antenna	Instruments corporation	GTH-0118	351600	Apr. 20, 2016	1 Year
5.	Bilog Broadband Antenna	Schwarzbeck	VULB9163	VULB 9163-289	Apr. 20, 2016	1 Year
6.	Pre-amplifier	SONOMA	310N	186860	Apr. 17, 2016	1 Year
7.	EMI Test Software EZ-EMC	SHURPLE	N/A	N/A	N/A	N/A
8	Power Sensor	DAER	RPR3006W	15I00041SN046	Jun 30, 2015	1 Year
9	MXA Spectrum Analysis	Agilent	N9020A	MY51170037	Jun 30, 2015	1 Year
10	MXG RF Vector Signal Generator	Agilent	N5182A	MY48180656	Jun 30, 2015	1 Year
11	Signal Generator	Agilent	E4421B	MY41000743	Jun 30, 2015	1 Year
12	DC Power supply	IV	IV-8080	YQSB0096	Jun 30, 2015	1 Year
13	TEMP&HUMI PROGRAMMABLE CHAMBER	Bell Group	BE-THK-150M8	SE-0137	Mar 16, 2016	1 Year

5.4 Test Results

Test Item	: Frequency Separation	Test Mode	: CH Low ~ CH High
Test Voltage	: AC 120V, 60Hz	Temperature	: 24°C
Test Result	: PASS	Humidity	: 55%RH

Channel	Frequency (MHz)	Separation Read Value (kHz)	Limit (kHz)	Modulation Mode
Low	2402	1005	927.9	BDR
Mid	2441	1005	929.3	BDR
High	2480	1005	930.8	BDR
Low	2402	1005	842.7	EDR
Mid	2441	1005	840.7	EDR
High	2480	1005	840.0	EDR

Remark:

1. The limit of mode (EDR) is 2/3 of 20dB BW;
2. The EDR was tested on ($\pi/4$ DQPSK, 8DPSK) modes, only the worst data of ($\pi/4$ DQPSK) is attached in the following pages.

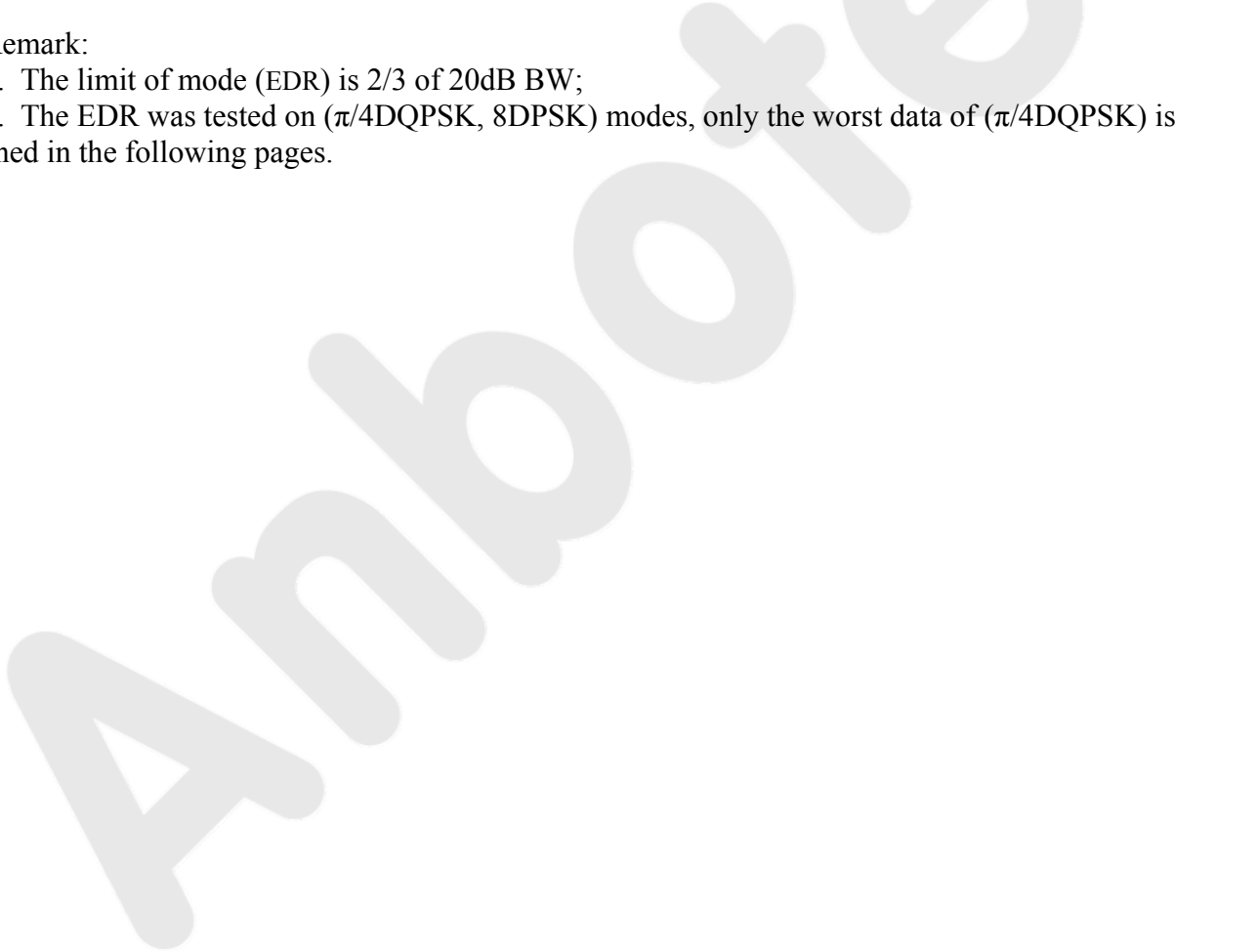

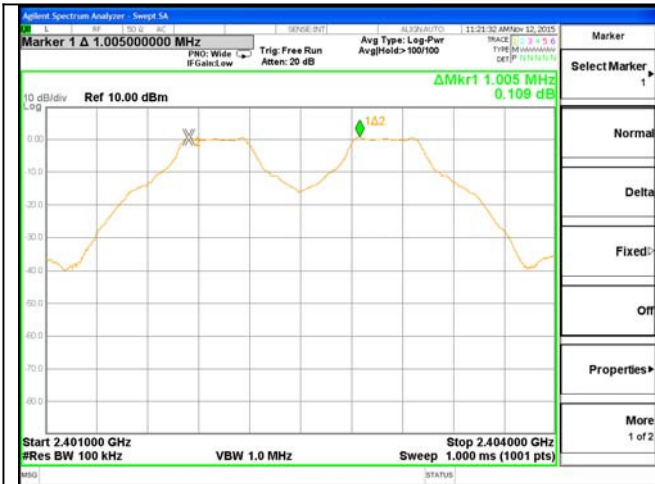

Test Mode: BDR---Low



Test Mode: BDR---Mid



Test Mode: BDR---High

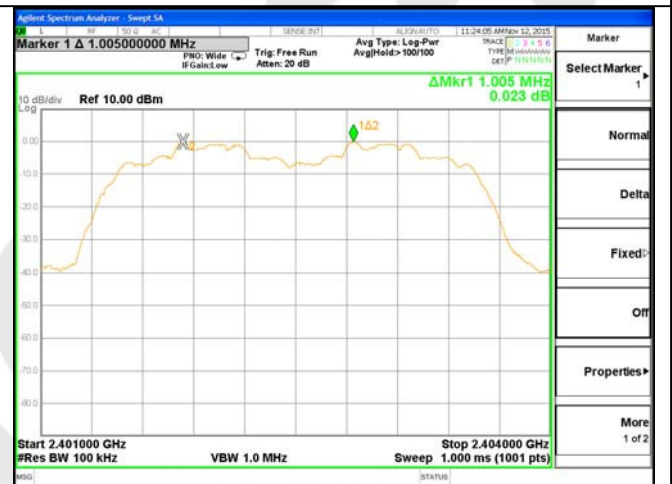

Test Mode: EDR---Low



Test Mode: EDR---Mid

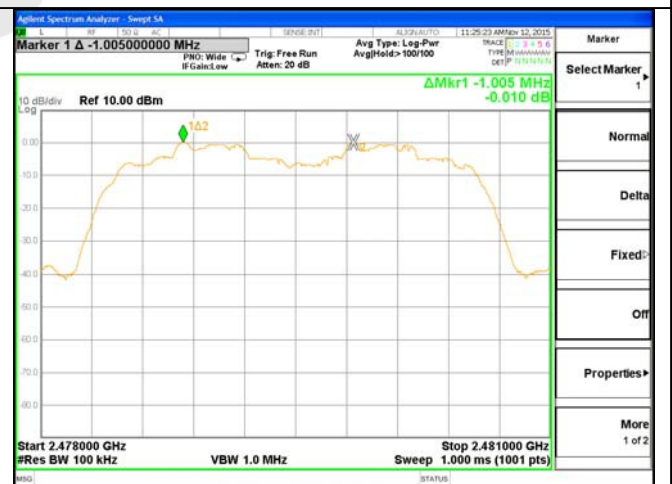

Test Mode: EDR---High

6. 20DB BANDWIDTH TEST

6.1 Measurement Procedure

Using the following spectrum analyzer settings:

1. Span= approximately 2 to 3 times the 20dB bandwidth, centered on a hopping channel.
2. Set the RBW = 30 kHz.
3. Set the VBW = 100 kHz.
4. Sweep time = auto couple.
5. Detector function = peak.
6. Trace mode = max hold.
7. Allow trace to fully stabilize.

6.2 Test SET-UP

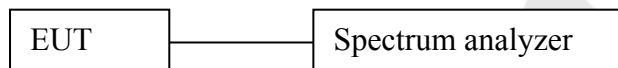

6.3 Test Equipment

Same as the equipment listed in 5.3.

6.4 Test Results

Test Item	: 20dB BW	Test Mode	: CH Low ~ CH High
Test Voltage	: AC 120V, 60Hz	Temperature	: 24°C
Test Result	: PASS	Humidity	: 55%RH

Channel	Frequency (MHz)	20dB Down BW(kHz)	Modulation Mode
Low	2402	927.9	BDR
Mid	2441	929.3	BDR
High	2480	930.8	BDR
Low	2402	1264.0	EDR
Mid	2441	1261.0	EDR
High	2480	1260.0	EDR

Remark: The EDR was tested on ($\pi/4$ DQPSK, 8DPSK) modes, only the worst data of ($\pi/4$ DQPSK) is attached in the following pages.

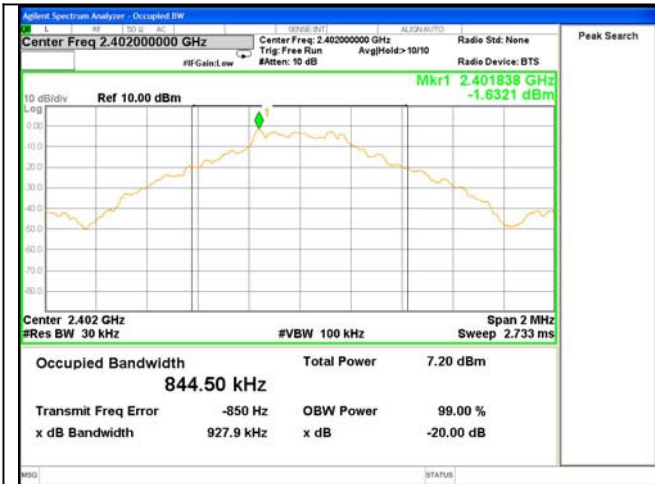

Test Mode: BDR---Low

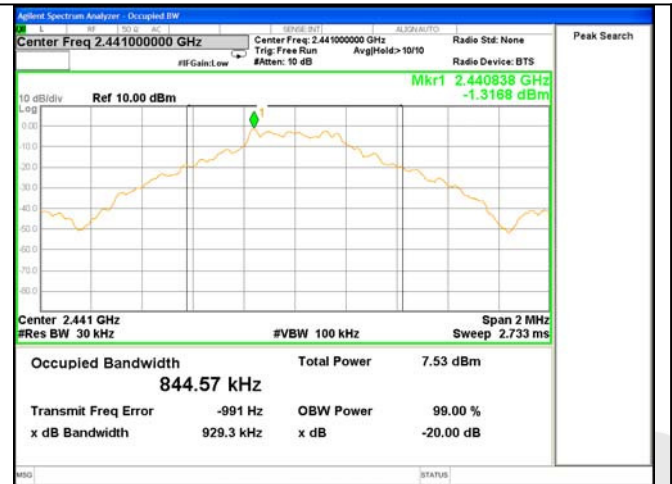

Test Mode: BDR---Mid

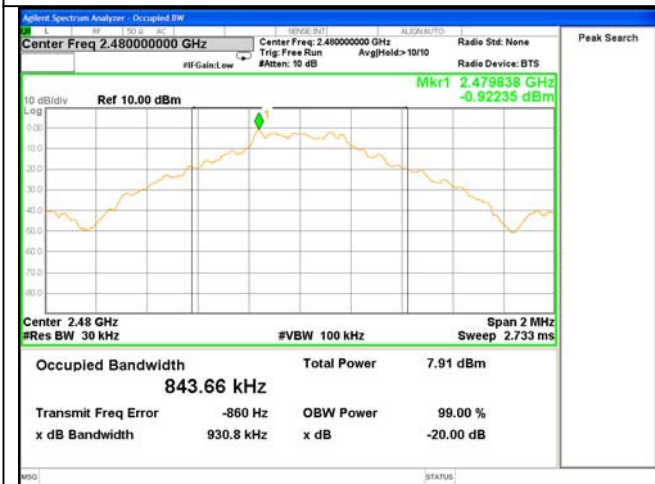

Test Mode: BDR---High

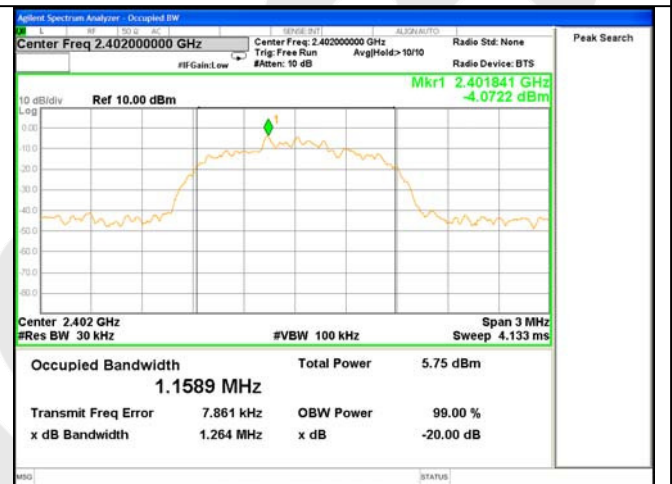

Test Mode: EDR---Low

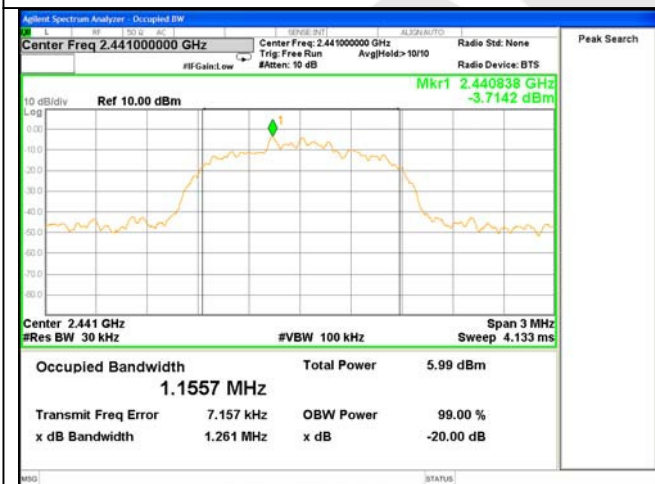

Test Mode: EDR---Mid

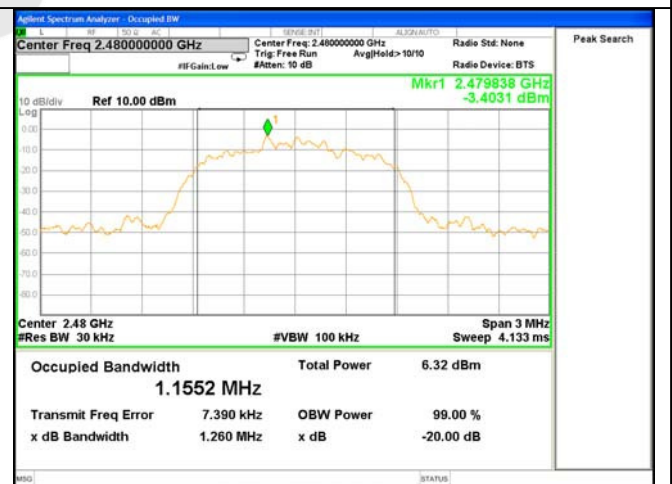

Test Mode: EDR---High

7. QUANTITY OF HOPPING CHANNEL TEST

7.1 Measurement Procedure

The EUT must have its hopping function enabled. Using the following spectrum analyzer setting:

1. Span= the frequency band of operation
2. Set the RBW = 1 MHz.
3. Set the VBW = 1 MHz.
4. Sweep time = auto couple.
5. Detector function = peak.
6. Trace mode = max hold.
7. Allow trace to fully stabilize.

7.2 Test SET-UP

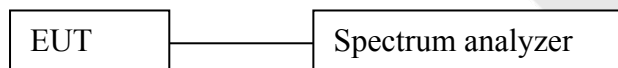

7.3 Test Equipment

Same as the equipment listed in 5.3.

7.4 Test Results

Test Item	: Number of Hopping Frequency	Test Mode	: CH Low ~ CH High
Test Voltage	: AC 120V, 60Hz	Temperature	: 24°C
Test Result	: PASS	Humidity	: 55%RH

Hopping Channel Frequency Range	Quantity of Hopping Channel	Quantity of Hopping Channel
2402-2480	79	>15

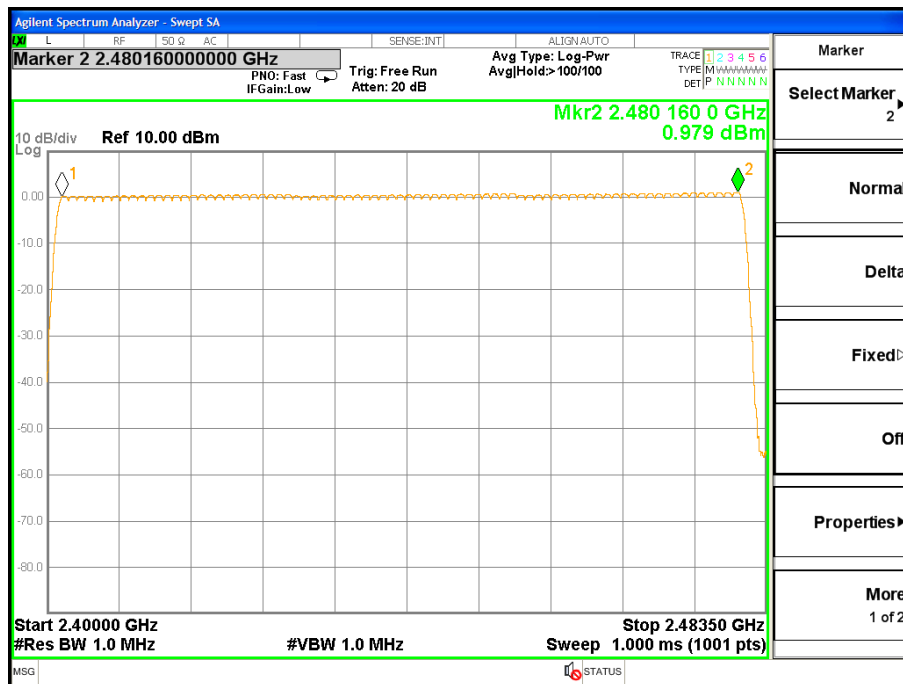

8. DWELL TIME TEST

8.1 Measurement Procedure

The EUT must have its hopping function enabled. Use the following spectrum analyzer settings:

1. Span= zero span, centered on a hopping channel
2. Set the RBW = 1 MHz.
3. Set the VBW = 1 MHz.
4. Sweep time = as necessary to capture the entire dwell time per hopping channel.
5. Detector function = peak.
6. Trace mode = max hold.
7. Allow trace to fully stabilize.

8.2 Test SET-UP

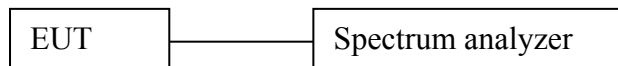

8.3 Test Equipment

Same as the equipment listed in 5.3.

8.4 Test Results

Test Item	:	Time of Occupancy	Test Mode	:	CH Low ~ CH High
Test Voltage	:	AC 120V, 60Hz	Temperature	:	24°C
Test Result	:	PASS	Humidity	:	55%RH

Package Type	Pulse width (ms)	Time slot length(ms)	Dwell time (ms)	Limit (s)	Modulation
DH1	0.369	time slot length *1600/2 /79 * 31.6	118.08	0.4	BDR
DH3	1.620	time slot length *1600/4 /79 * 31.6	259.20	0.4	BDR
DH5	2.870	time slot length *1600/6 /79 * 31.6	306.13	0.4	BDR
DH1	0.376	time slot length *1600/2 /79 * 31.6	120.32	0.4	EDR
DH3	1.620	time slot length *1600/4 /79 * 31.6	259.20	0.4	EDR
DH5	2.863	time slot length *1600/6 /79 * 31.6	305.39	0.4	EDR

Remark: The EDR was tested on ($\pi/4$ DQPSK, 8DPSK) modes, only the worst data of ($\pi/4$ DQPSK) is attached in the following pages.



Test Mode: BDR---DH1



Test Mode: BDR---DH3



Test Mode: BDR---DH5



Test Mode: EDR---DH1



Test Mode: EDR---DH1



Test Mode: EDR---DH3

9. MAXIMUM PEAK OUTPUT POWER TEST

9.1 Measurement Procedure

- a. Check the calibration of the measuring instrument(SA) using either an internal calibrator or a known signal from an external generator.
- b. Turn on the EUT and connect it to measurement instrument. Then set it to any one convenient frequency within its operating range. Set a reference level on the measuring instrument equal to the highest peak value.
- c. The center frequency of the spectrum analyzer is set to the fundamental frequency and using proper RBW and VBW setting.
- d. Measure the captured power within the band and recording the plot.
- e. Repeat above procedures until all frequencies required were complete.

Using the following spectrum analyzer settings:

1. Span= approximately 5 times the 20dB bandwidth, centered on a hopping channel
2. Set the RBW = 3 MHz.
3. Set the VBW = 3 MHz.
4. Sweep time = auto couple.
5. Detector function = peak.
6. Trace mode = max hold.
7. Allow trace to fully stabilize.

9.2 Test SET-UP

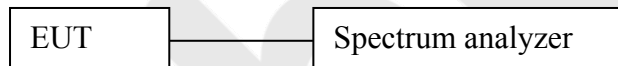

9.3 Test Equipment

Same as the equipment listed in 5.3.

9.4 Test Results

Test Item	: Max. peak output power	Test Mode	: CH Low ~ CH High
Test Voltage	: AC 120V, 60Hz	Temperature	: 24°C
Test Result	: PASS	Humidity	: 55%RH

Channel Frequency (MHz)	Peak Power output(mW)	Peak Power output(dBm)	Peak Power Limit(mW)	Results	Modulation
2402	1.248	0.962	1000	PASS	BDR
2441	1.298	1.133	1000	PASS	BDR
2480	1.404	1.474	1000	PASS	BDR
2402	1.231	0.903	125	PASS	EDR
2441	1.287	1.097	125	PASS	EDR
2480	1.389	1.427	125	PASS	EDR

Remark: The EDR was tested on ($\pi/4$ DQPSK, 8DPSK) modes, only the worst data of ($\pi/4$ DQPSK) is attached in the following pages.

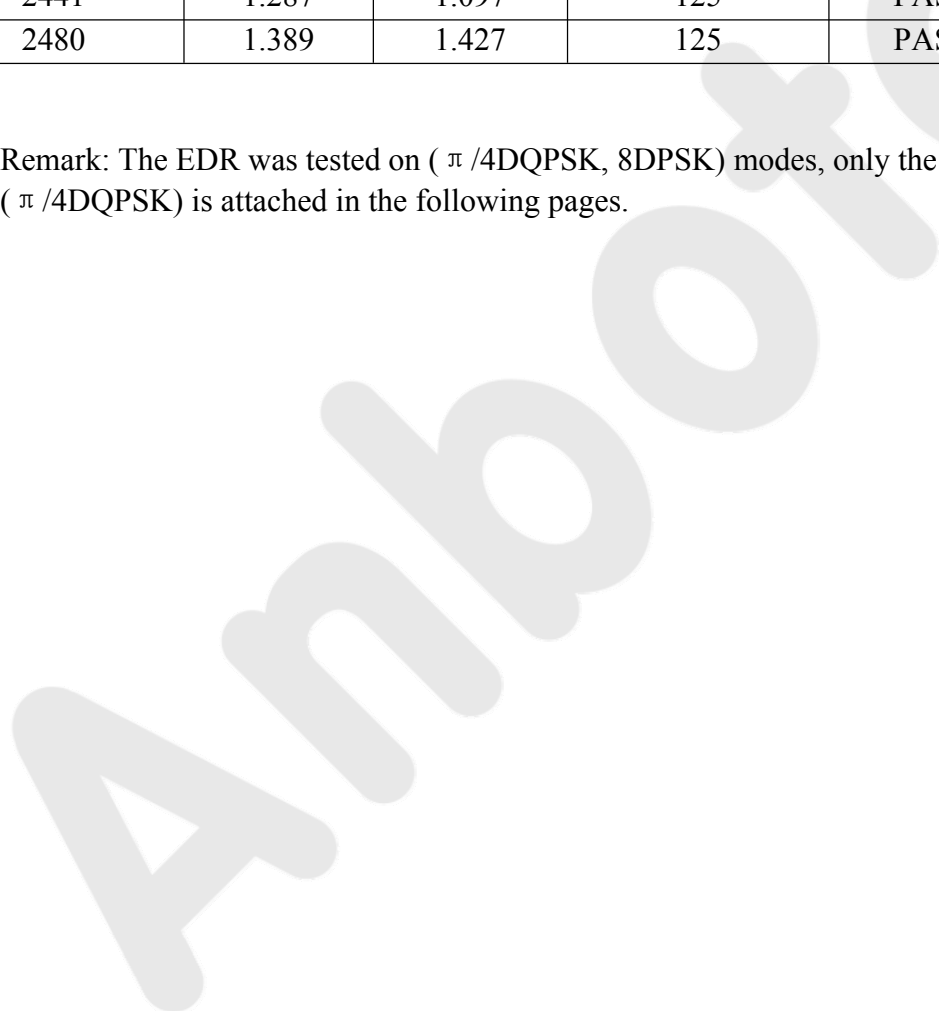

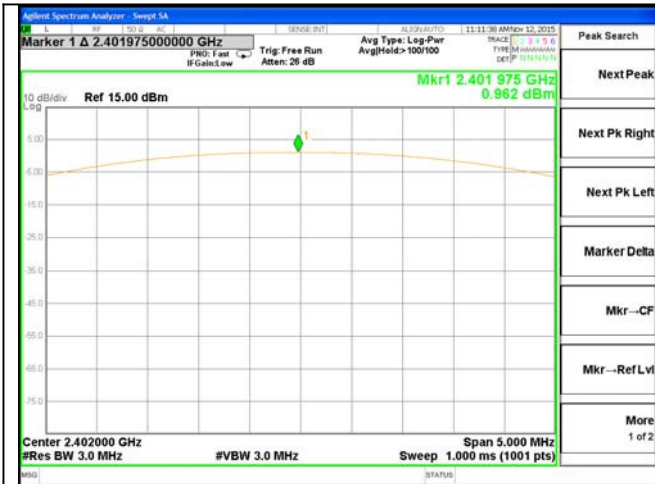

Test Mode: BDR---Low

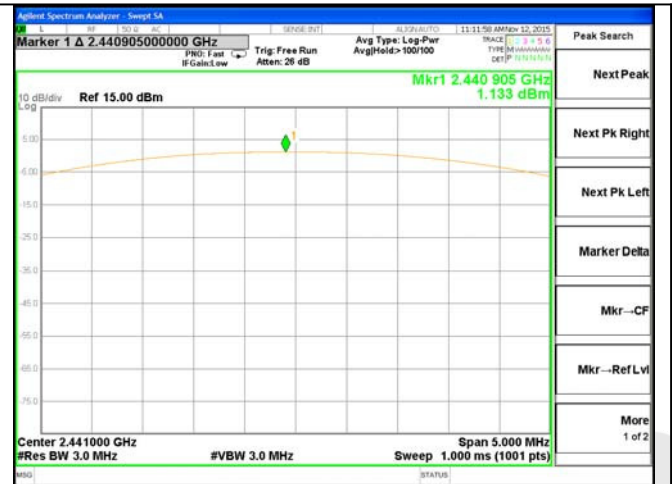

Test Mode: BDR---Mid

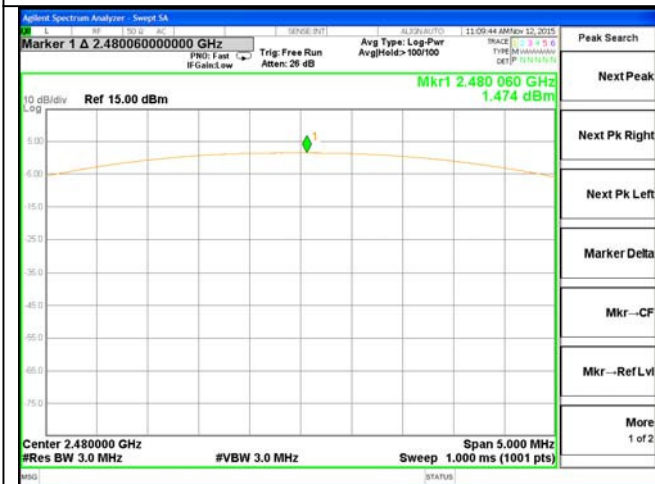

Test Mode: BDR---High

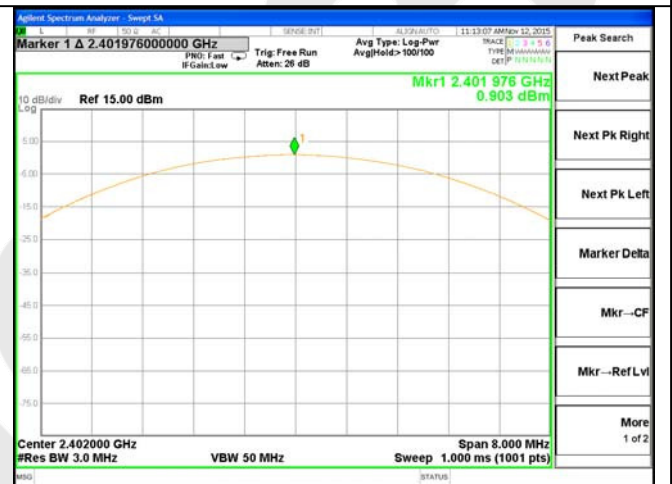

Test Mode: EDR---Low

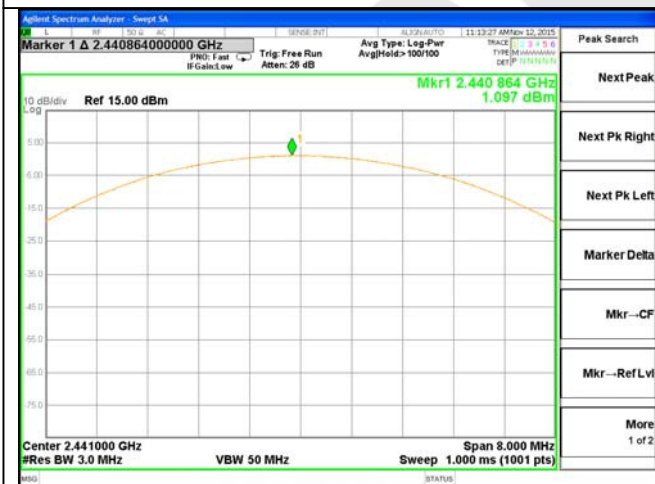

Test Mode: EDR---Mid

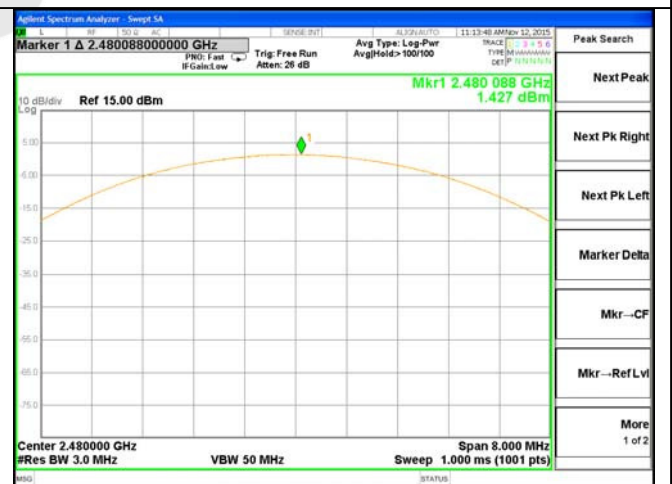

Test Mode: EDR---High

10. BAND EDGE TEST

10.1 Measurement Procedure

A) Conducted Emission method:

1. Check the calibration of the measuring instrument using either an internal calibrator or a known signal from an external generator.
2. Position the EUT without connection to measurement instrument. Put it on the Rotated table and turn on the EUT and make it operate in transmitting mode. Then set it to low Channel and High Channel within its operating range, and make sure the instrument is operated in its linear range.
3. Set both RBW and VBW of spectrum analyzer to 100kHz with a convenient frequency span including 100kHz bandwidth from band edge,
4. Measurement the highest amplitude appearing on spectral display and set it as a reference level. Plot the graph with marking the highest point and edge frequency.
5. Report above procedures until all measured frequencies were complete.

B) Radiated Emission method:

The EUT is placed on a turn table which is 1.5 meter high above the ground. The turn table can rotate 360 degrees to determine the position of the maximum emission level. The EUT is set 3 meters away from the receiving antenna which is mounted on a antenna tower. The antenna can be moved up and down from 1 to 4 meters to find out the maximum emission level. Rotated the EUT through three orthogonal axes to determine the maximum emissions, both horizontal and vertical polarization of the antenna are set on test. The EUT is tested in 9*6*6 Chamber. for Radiated emissions restricted band RBW= 1 MHz, VBW= 3 MHz.

10.2 Test SET-UP

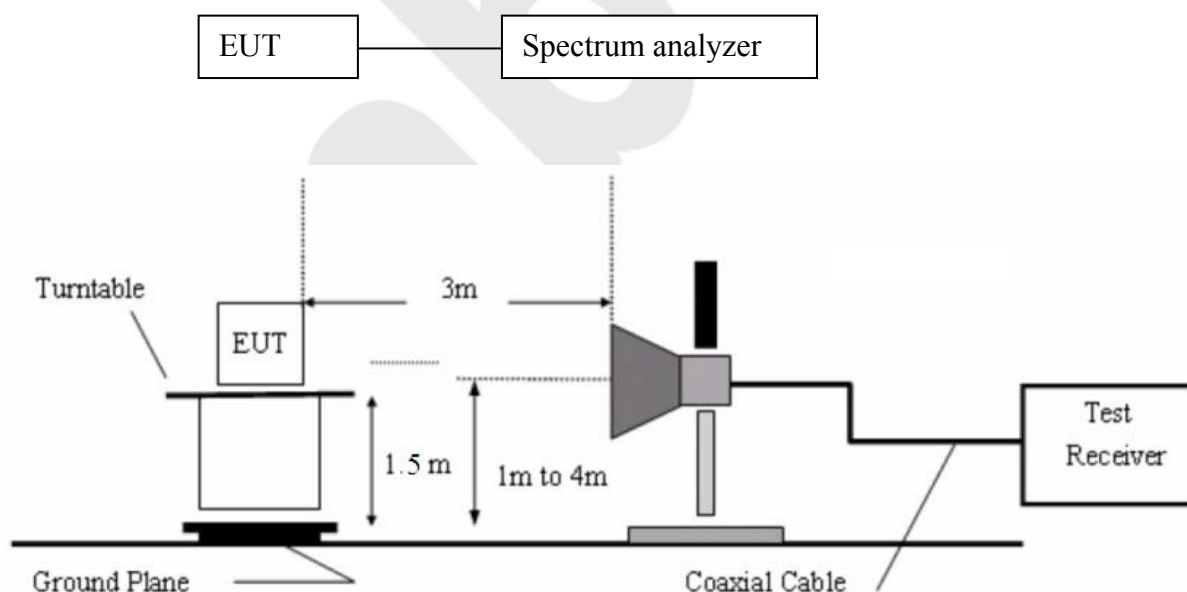

10.3 Test Equipment

Same as the equipment listed in 5.3.

10.4 Test Results

Pass.

Please refer the following data.

Test Item	: Band edge	Test Mode	: CH Low ~ CH High
Test Voltage	: AC 120V, 60Hz	Temperature	: 24°C
Test Result	: PASS	Humidity	: 55%RH

For Hopping Mode:

Remark: The EDR was tested on ($\pi/4$ DQPSK, 8DPSK) modes, only the worst data of ($\pi/4$ DQPSK) is attached in the following pages.



Test Mode: BDR

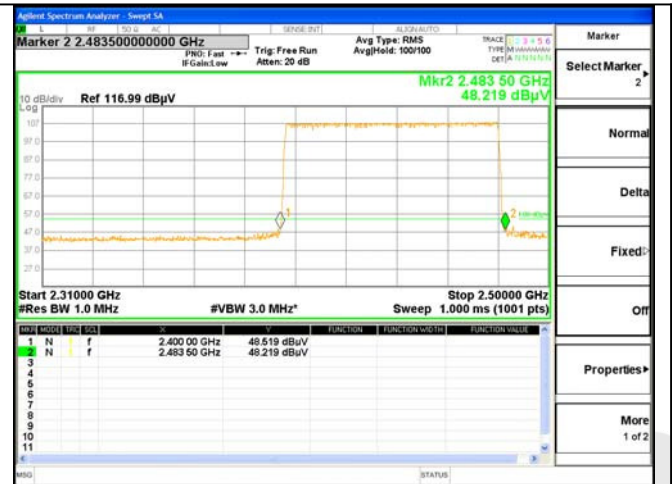

Test Mode: BDR



Test Mode: EDR

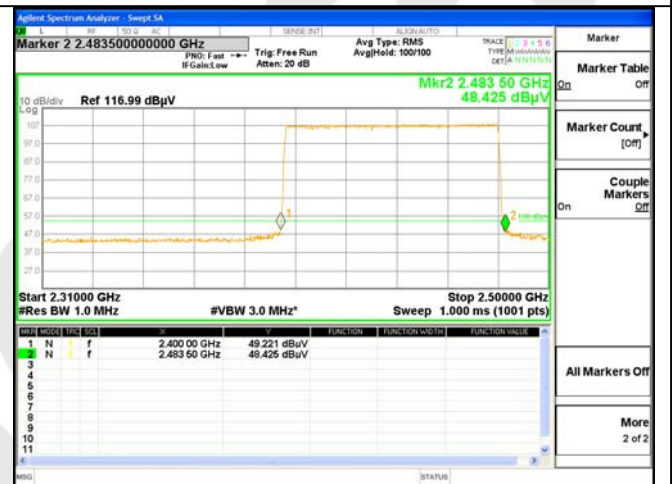

Test Mode: EDR

Test Item	: Band edge	Test Mode	: CH Low ~ CH High
Test Voltage	: AC 120V, 60Hz	Temperature	: 24°C
Test Result	: PASS	Humidity	: 55%RH

For Non-Hopping Mode:

1. Conducted Test

Frequency (MHz)	Peak Power Output(dBm)	Emission read Value(dBm)	Result of Band edge(dBc)	Band edge Limit(dBc)	Modulation
<2400	0.892	-38.035	38.927	>20dBc	BDR
	0.294	-29.188	29.482	>20dBc	EDR
>2483.5	1.299	-52.660	53.959	>20dBc	BDR
	0.805	-50.664	51.469	>20dBc	EDR

2. Radiated emission Test

Frequency (MHz)	Antenna polarization (H/V)	Emission (dBuV/m)		Band edge Limit (dBuV/m)		Modulation
		PK	AV	PK	AV	
<2400	V	49.58	37.47	74.00	54.00	BDR
	V	53.14	39.68	74.00	54.00	EDR
>2483.5	V	54.75	38.14	74.00	54.00	BDR
	V	51.05	35.69	74.00	54.00	EDR

Remark: The EDR was tested on ($\pi/4$ DQPSK, 8DPSK) modes, only the worst data of ($\pi/4$ DQPSK) is attached in the following pages.

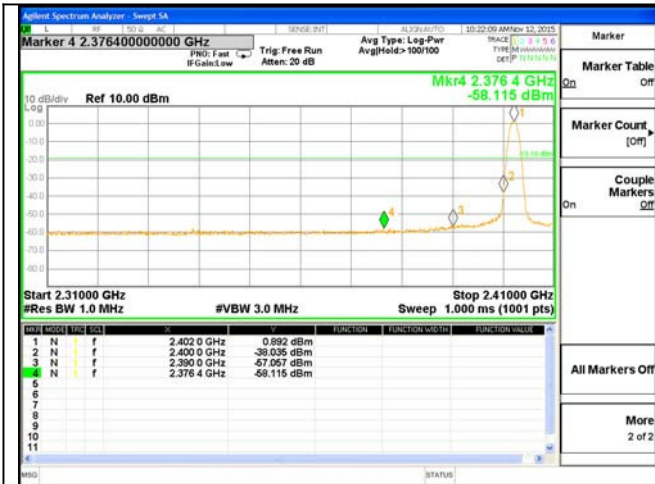

Test Mode: BDR

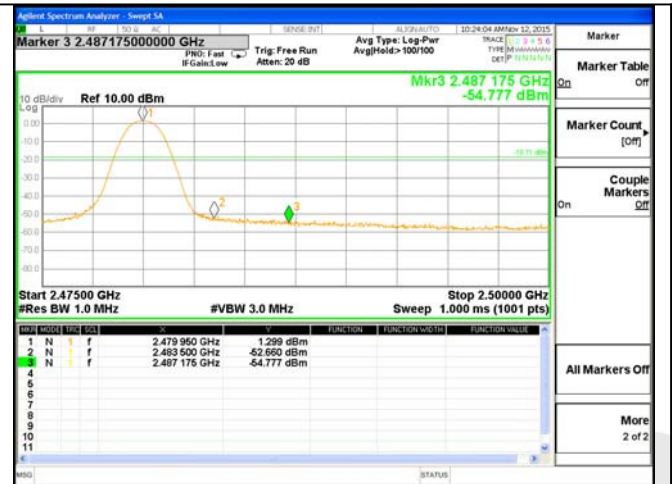

Test Mode: BDR

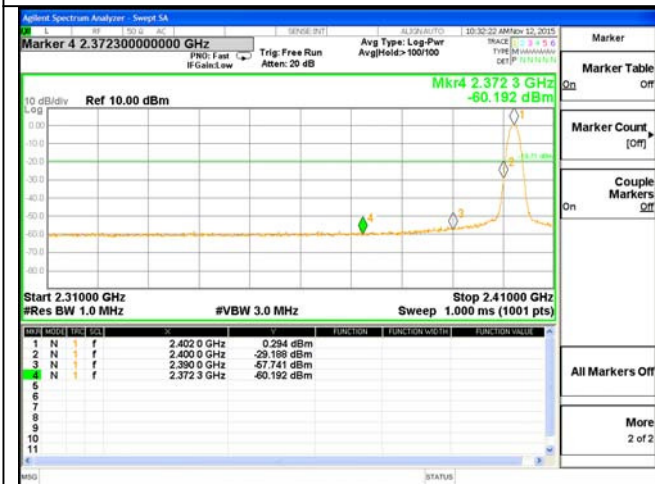

Test Mode: EDR



Test Mode: EDR

11. ANTENNA APPLICATION

11.1 Antenna requirement

The EUT'S antenna is met the requirement of FCC part 15C section 15.203 and 15.247.

FCC part 15C section 15.247 requirements:

Systems operating in the 2402-2480MHz band that are used exclusively for fixed, point-to-point operations may employ transmitting antennas with directional gain greater than 6dBi provided the maximum peak output power of the intentional radiator is reduced by 1dB for every 3dB that the directional gain of the antenna exceeds 6dBi.

11.2 Result

The EUT's antenna used a PCB Antenna, The antenna's gain is 1.2dBi and meets the requirement.

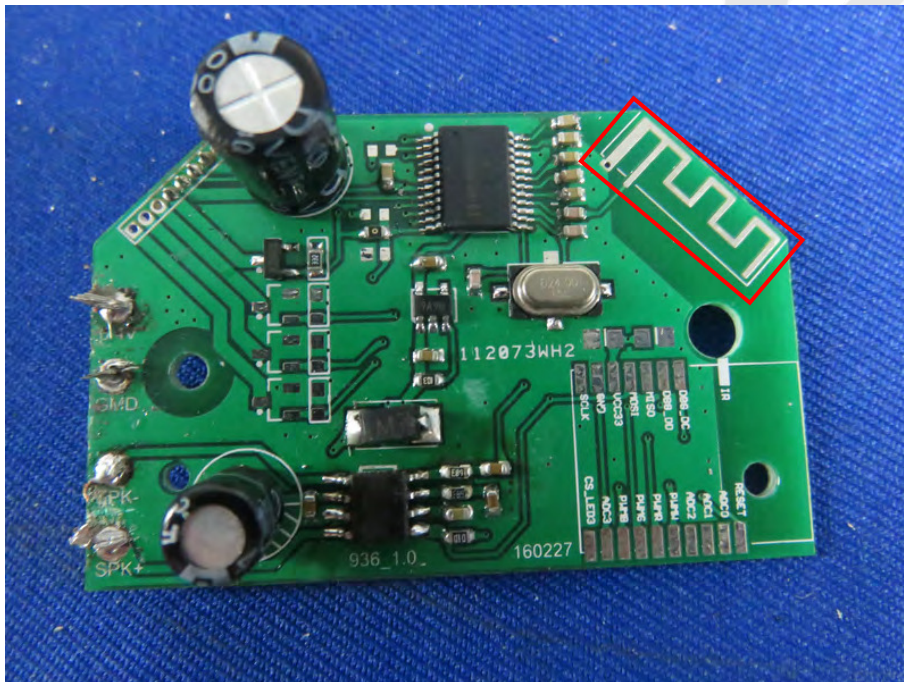

12. PHOTOGRAPH

12.1 Photo of Power Line Conducted Emission Measurement



12.2 Photo of Radiation Emission Test

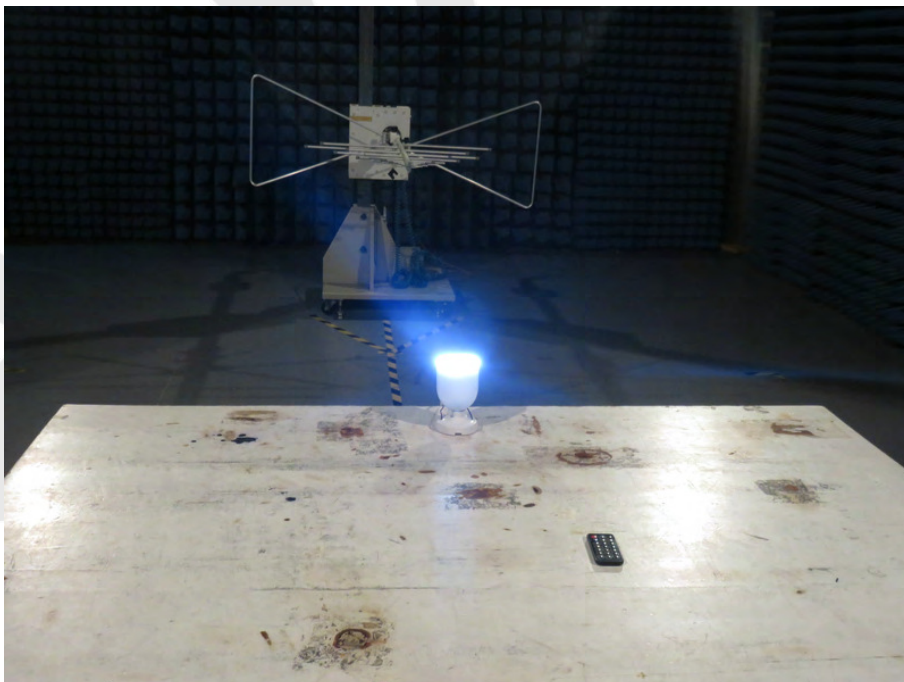

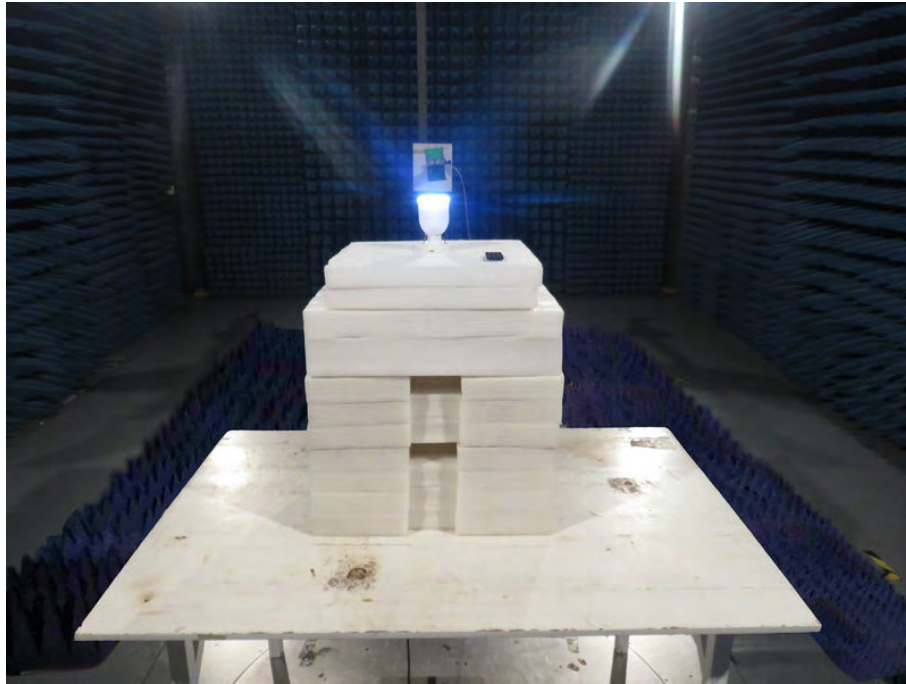

Anbotek

APPENDIX I (EXTERNAL PHOTOS)

1. Figure
The EUT-Top View



2. Figure
The EUT-Bottom View



3. Figure
The EUT-Front View

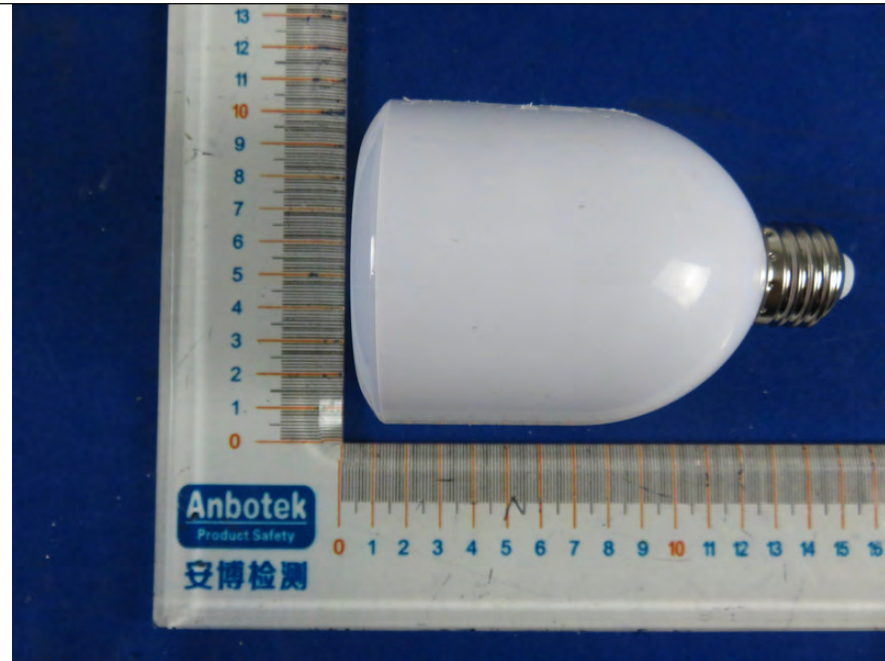

4. Figure
The EUT-Back View

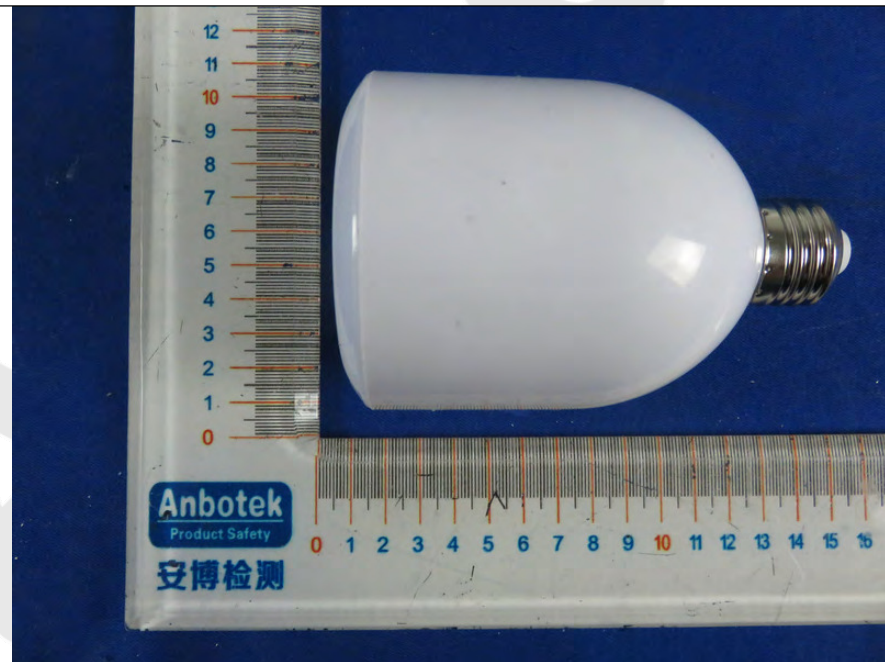

5. Figure
The EUT-Right View

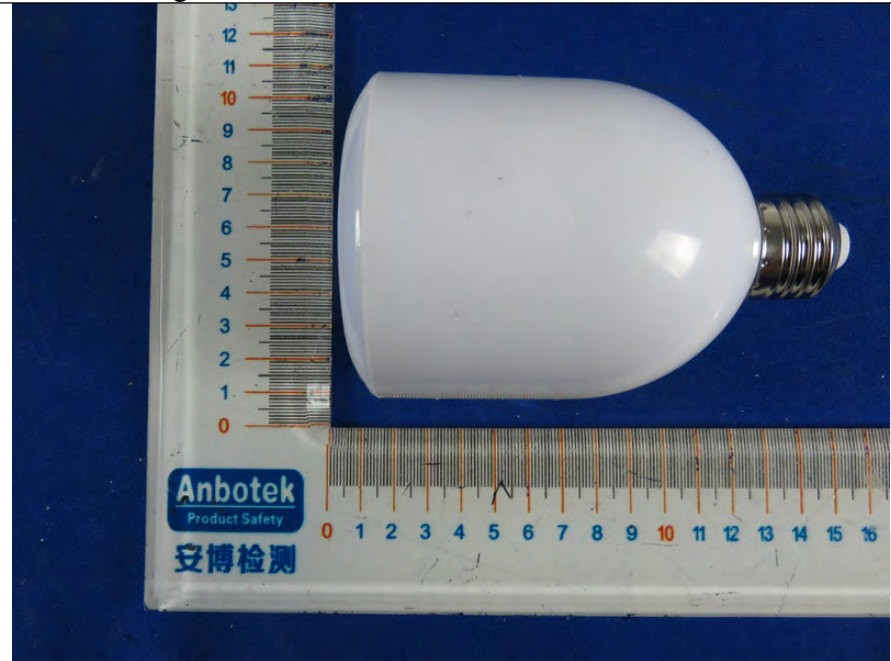

6. Figure
The EUT-Left View

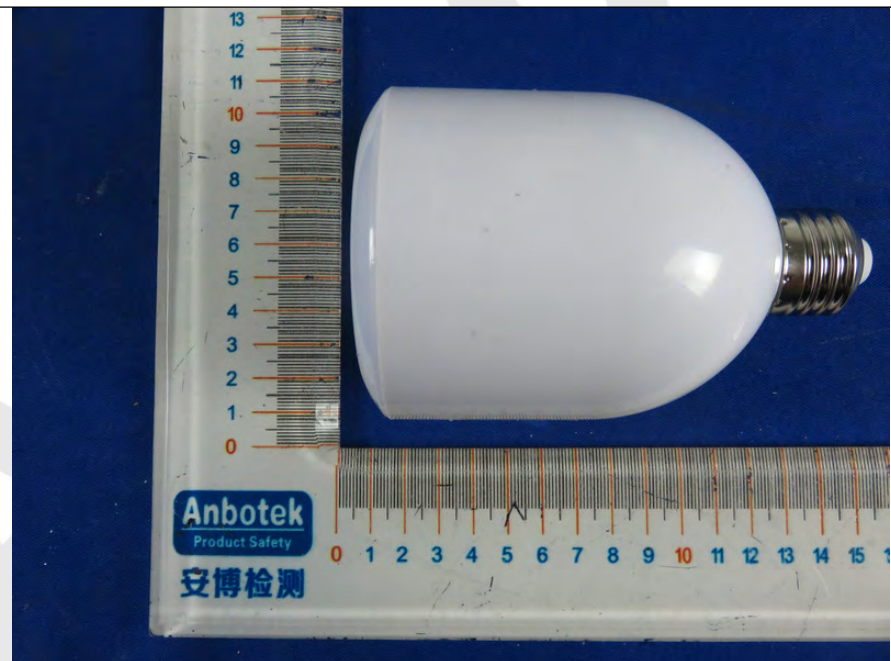

APPENDIX II (INTERNAL PHOTOS)

1. Figure
The EUT-Inside View

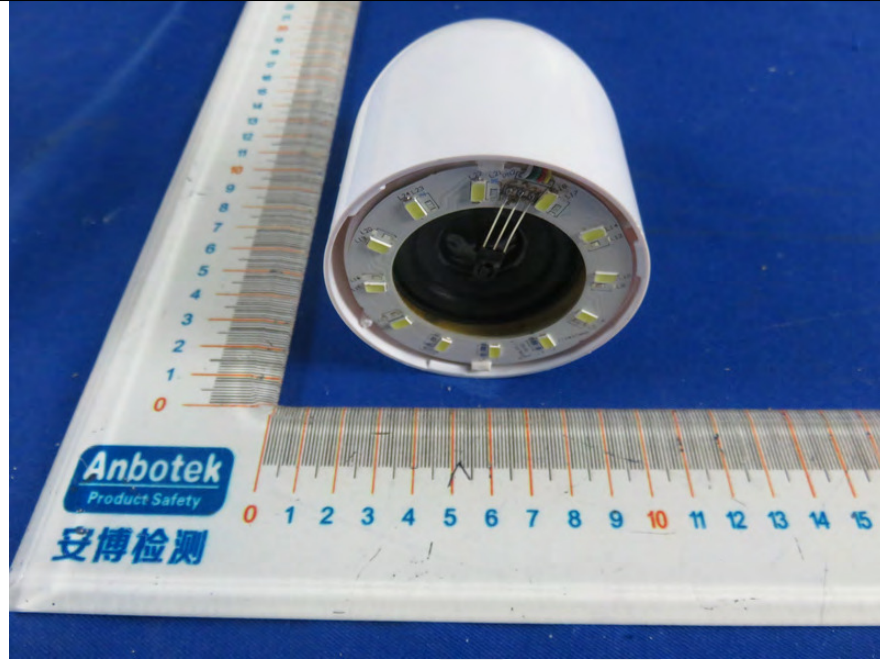

2. Figure
The EUT-Inside View

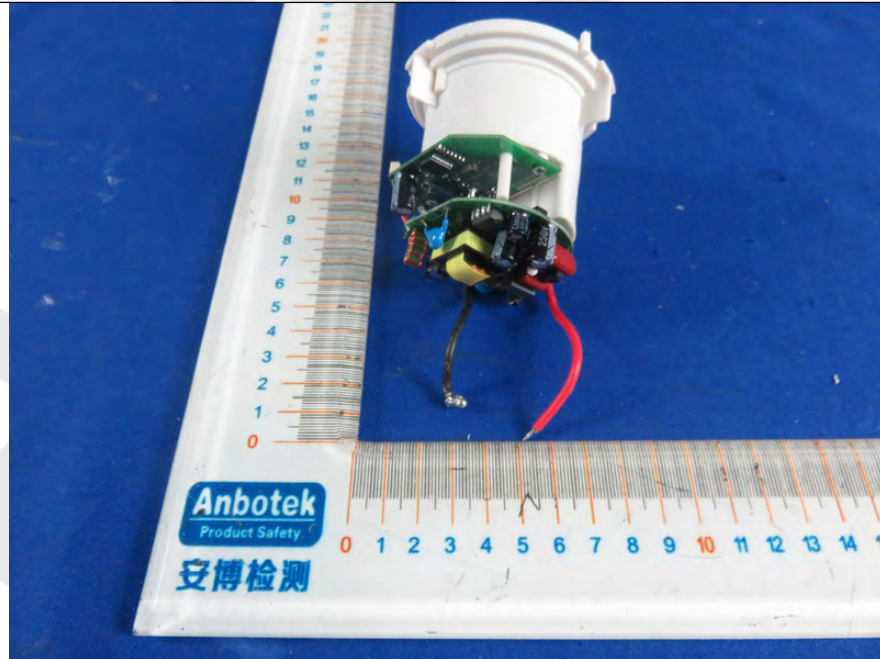

3. Figure
PCB of the EUT-Front View

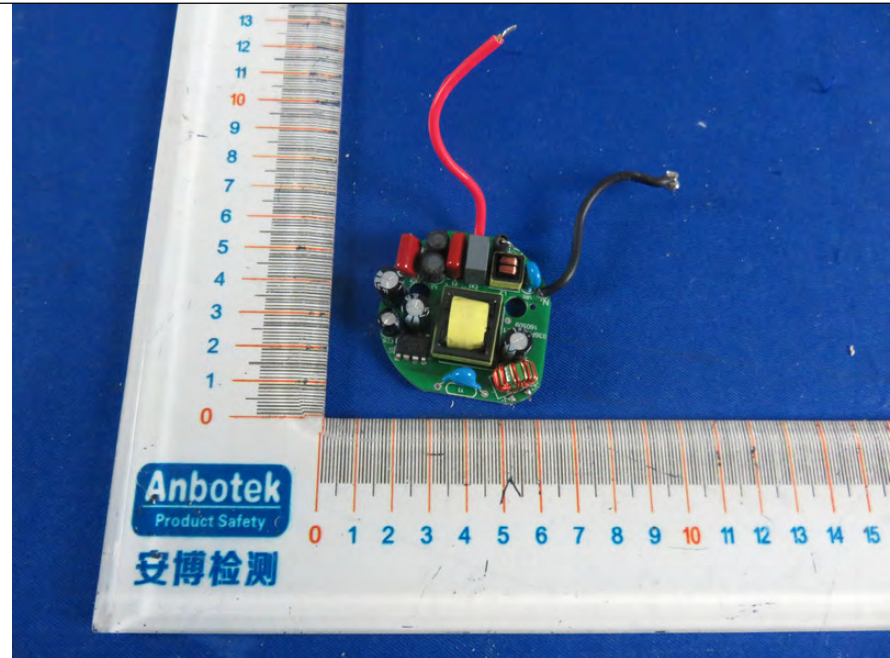

4. Figure
PCB of the EUT-Back View

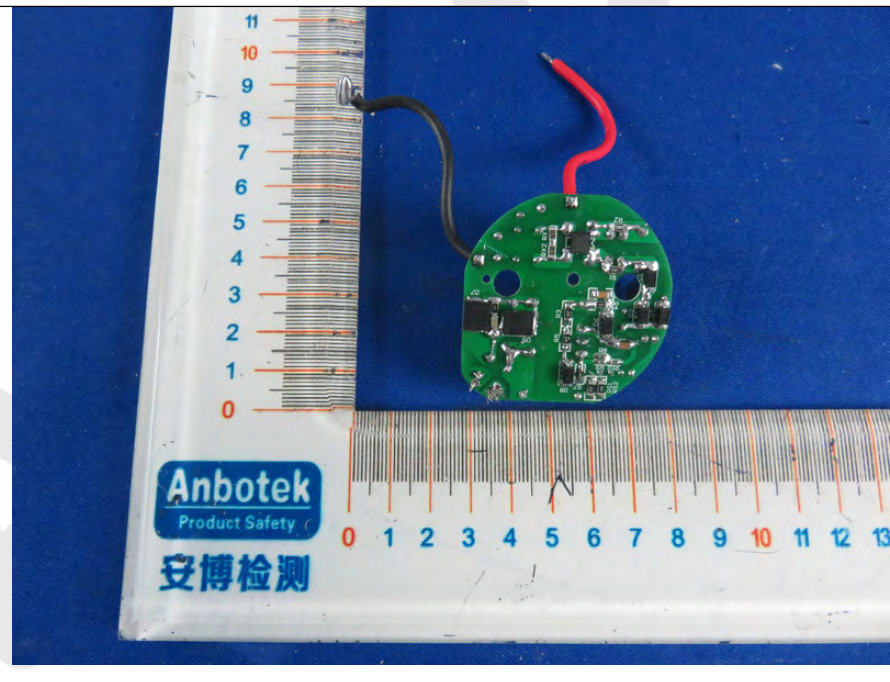

5. Figure
PCB of the EUT-Front View

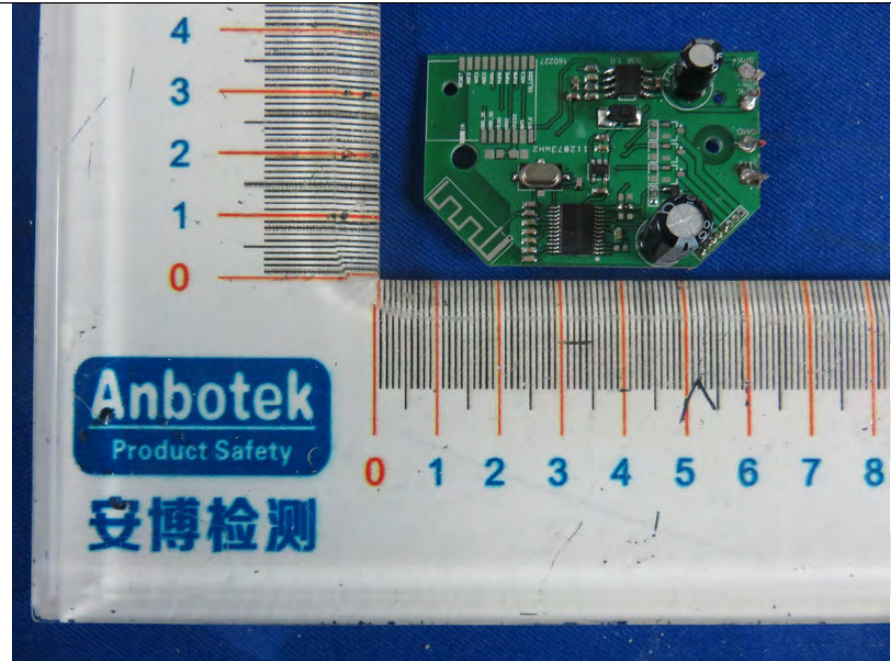

6. Figure
PCB of the EUT-Back View

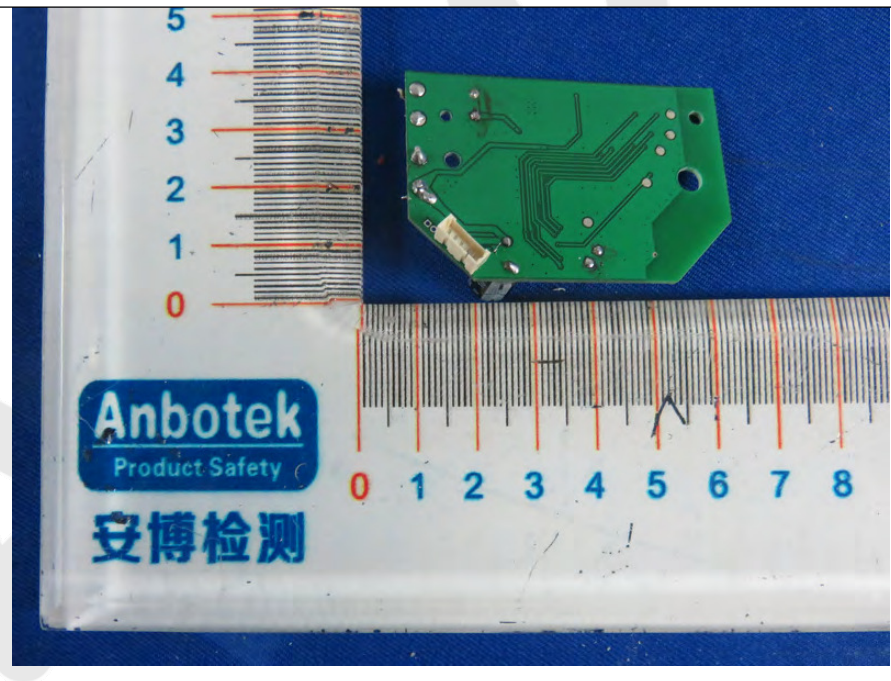

7. Figure
PCB of the EUT-Front View

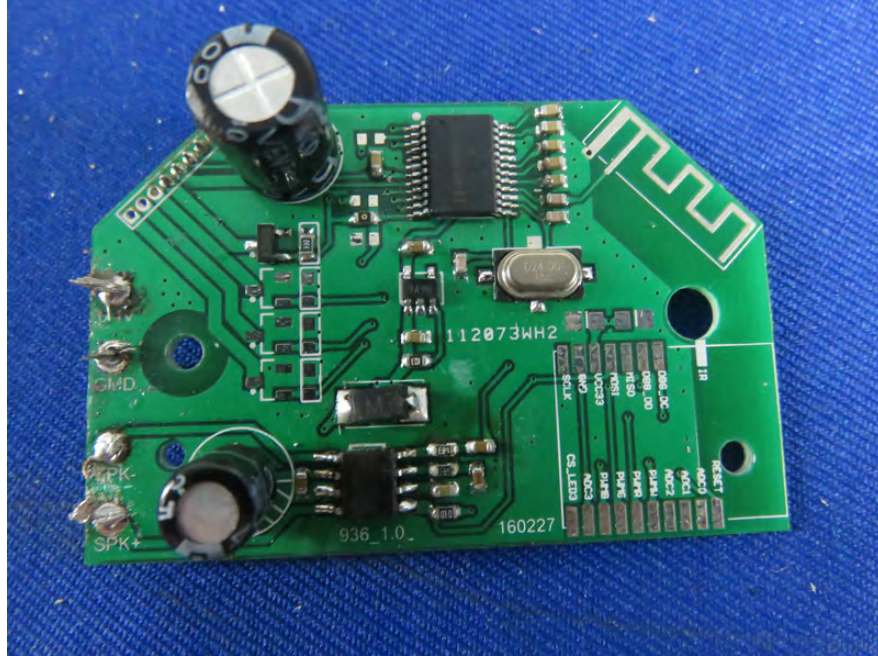

8. Figure
PCB of the EUT-Back View

