

REVISION RECORD			
LTR	ECO NO:	APPROVED:	DATE:

FCC ID: 2A1IF-09291PG

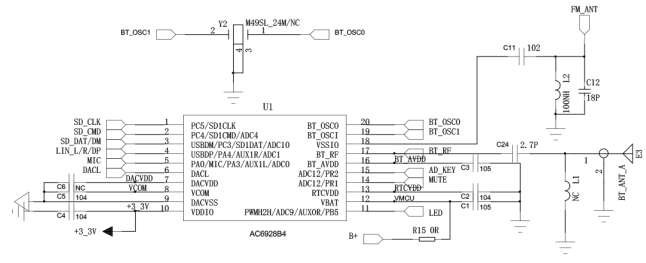

MCU

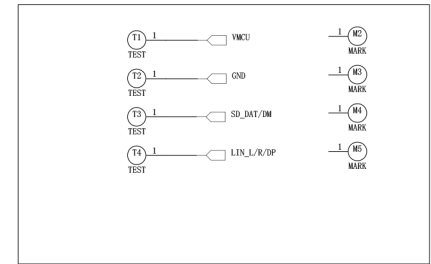
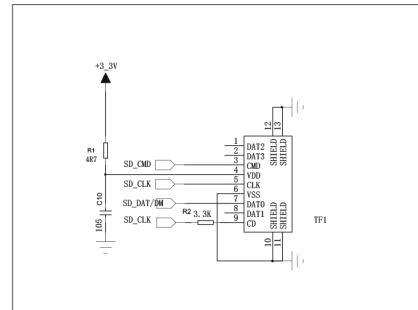
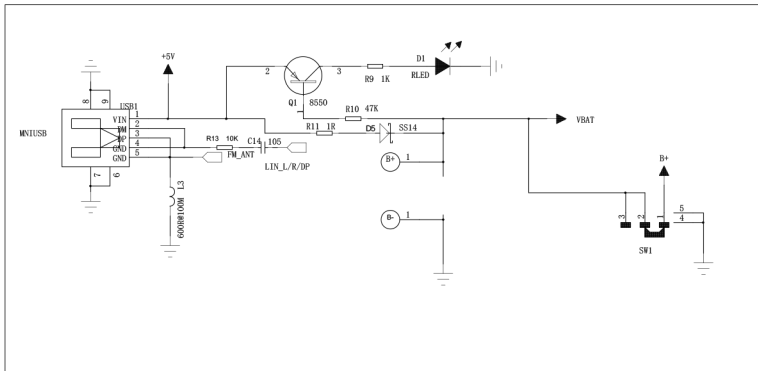
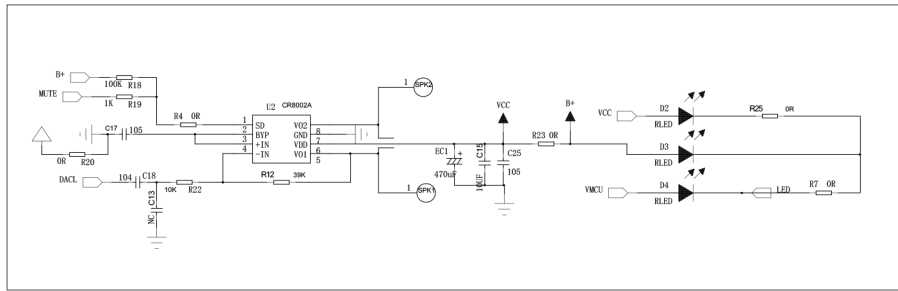
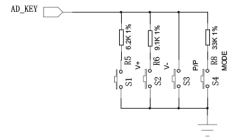
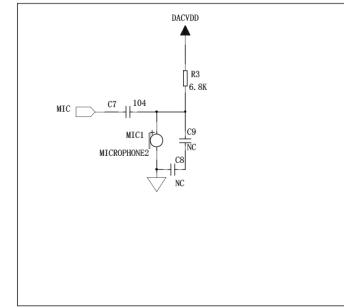

COMPANY: _____

TITLE: _____

DRAWN:	DATED:
CHECKED:	DATED:
QUALITY CONTROL:	DATED:
RELEASED:	DATED:

CODE:	SIZE:	DRAWING NO:	REV:
SCALE:			SHEET: 1 OF 1

A2