



RF Test Report

Applicant : Superior Communications DBA PureGear
Product Type : PURECAM
Trade Name : PureGear
Model Number : 07614PG
Applicable Standard : FCC 47 CFR PART 15 SUBPART C
ANSI C63.10:2013
Receive Date : Jun. 27, 2018
Test Period : Jun. 29 ~ Jul. 30, 2018
Issue Date : Aug. 02, 2018

Issue by

A Test Lab Techno Corp.
No. 140-1, Changan Street, Bade District,
Taoyuan City 33465, Taiwan (R.O.C)
Tel : +886-3-2710188 / Fax : +886-3-2710190



Taiwan Accreditation Foundation accreditation number: 1330

Test Firm MRA designation number: TW0010

Note: This report shall not be reproduced except in full, without the written approval of A Test Lab Techno Corp. This document may be altered or revised by A Test Lab Techno Corp. personnel only, and shall be noted in the revision section of the document. The client should not use it to claim product endorsement by TAF, or any government agencies. The test results in the report only apply to the tested sample.



Revision History

Rev.	Issue Date	Revisions	Revised By
00	Aug. 02, 2018	Initial Issue	Janet Chao

Verification of Compliance

Issued Date: Aug. 02, 2018

Applicant : Superior Communications DBA PureGear
Product Type : PURECAM
Trade Name : PureGear
Model Number : 07614PG
FCC ID : 2A1IF-07614PG
EUT Rated Voltage : DC 5V
Test Voltage : 120Vac / 60 Hz
Applicable Standard : FCC 47 CFR PART 15 SUBPART C
ANSI C63.10:2013
Test Result : Complied

Performing Lab. : A Test Lab Techno Corp.
No. 140-1, Changan Street, Bade District,
Taoyuan City 33465, Taiwan (R.O.C)
Tel : +886-3-2710188 / Fax : +886-3-2710190



Taiwan Accreditation Foundation accreditation number: 1330
<http://www.atl-lab.com.tw/e-index.htm>

A Test Lab Techno Corp. tested the above equipment in accordance with the requirements set forth in the above standards. All indications of Pass/Fail in this report are opinions expressed by A Test Lab Techno Corp. based on interpretations and/or observations of test results. Measurement Uncertainties were not taken into account and are published for informational purposes only. The test results show that the equipment tested is capable of demonstrating compliance with the requirements as documented in this report.

Approved By : Jet Lu Reviewed By : Eric Ou Yang
(Manager) (Jet Lu) (Testing Engineer) (Eric Ou Yang)



TABLE OF CONTENTS

1	General Information	5
2	EUT Description	7
3	Test Methodology	9
	3.1. Mode of Operation.....	9
	3.2. EUT Exercise Software.....	10
	3.3. Configuration of Test System Details	10
	3.4. Test Instruments	12
	3.5. Test Site Environment.....	13
4	Measurement Procedure	14
	4.1. AC Power Line Conducted Emission Measurement.....	14
	4.2. Radiated Emission Measurement	16
	4.3. Maximum Conducted Output Power Measurement.....	20
	4.4. Antenna Measurement	21
5	Test Results.....	22
	Annex A. AC Power Line Conducted Emission Test Results.....	22
	Annex B. Conducted Test Results	24
	Annex C. Radiated Emission Test Results.....	25



1 General Information

1.1 Summary of Test Result

Standard	Item	Result	Remark
15.247			
15.207	AC Power Conducted Emission	PASS	-----
Standard	Item	Result	Remark
15.247			
15.247(d)	Transmitter Radiated Emissions	PASS	-----
15.247(b)(3)	Max. Output Power	PASS	-----
15.247(a)(2)	6dB RF Bandwidth	N/A	Note
15.247(e)	Maximum Power Spectral Density	N/A	Note
15.247(d)	Out of Band Conducted Spurious Emission	N/A	Note
15.203	Antenna Requirement	PASS	-----

The test results of this report relate only to the tested sample(s) identified in this report. Manufacturer or whom it may concern should recognize the pass or fail of the test result.

Note: The product adds a heat sink and a car charger. The layout of module and the appearance of the product are partly changed. Besides, the location of the antenna, antenna gain for BT/LE/WLAN, the module of camera and the software version are changed to do Class II Permissive Change, so it is only needed to be tested for AC Power Line Conducted Emission Measurement, Maximum Conducted Output Power Measurement and Radiated Emission Measurement.

Standard	Description
CFR47, Part 15, Subpart C §15.247	Intentional Radiators
ANSI C63. 10: 2013	American National Standard of Procedures for Compliance Testing of Unlicensed Wireless Devices
KDB 558074 D01 v04	GUIDANCE FOR PERFORMING COMPLIANCE MEASUREMENTS ON DIGITAL TRANSMISSION SYSTEMS (DTS) OPERATING UNDER SECTION 15.247



1.2 Measurement Uncertainty

Test Item	Frequency Range	Uncertainty (dB)
Conducted Emission	9kHz ~ 150kHz	2.7
	150kHz ~ 30MHz	2.7
Radiated Emission	9kHz ~ 30MHz	1.7
	30MHz ~ 1000MHz	5.7
	1000MHz ~ 18000MHz	5.5
	18000MHz ~ 26500MHz	4.8
	26500MHz ~ 40000MHz	4.8
Conducted Output Power	+0.27 dB / -0.28 dB	
RF Bandwidth	4.96%	
Power Spectral Density	+0.71 dB / -0.77 dB	



2 EUT Description

Applicant	Superior Communications DBA PureGear 5082 4th Street Irwindale California USA, Irwindale, California, 91706, United States			
Manufacturer	Shenzhen Auto Range Tech Co., Limited 5/F, Bldg. A1, Atomic Power Industrial Park, Fuming, Guanlan, Shenzhen, Guangdong. P. R. China.			
Product Type	PURECAM			
Trade Name	PureGear			
Model Number	07614PG			
FCC ID	2AIIIF-07614PG			
Class II Permissive Change	<ol style="list-style-type: none"> 1. change the BT/LE/WLAN/GPS antenna's location 2. change the BT//LE/WLAN/GPS antenna's gain to 2.3dBi (the original is 2dBi, and the antenna type remains the same) 3. add a heat sink, and the appearance changes accordingly 4. change the camera module and the module's layout partly changed 5. add an accessory: car charger 6. software version changes to V8.0_000_20180808. 			
IMEI No.	35316305670667			
Operate Freq. Band	Frequency Range (MHz)	Modulation	Channel Bandwidth	Data Rate 400 / 800 GI (ns)
IEEE 802.11b	2412 ~ 2462	DSSS	20MHz	Up to 11Mbps
IEEE 802.11g	2412 ~ 2462	OFDM	20MHz	Up to 54Mbps
IEEE 802.11n 2.4GHz 20MHz	2412 ~ 2462	OFDM	20MHz	Up to 72.2Mbps
IEEE 802.11n 2.4GHz 40MHz	2422 ~ 2452	OFDM	40MHz	Up to 150Mbps
Antenna information	Type		Max. Gain (dBi)	
	Internal Antenna		2.3	
Antenna Delivery	See section 3.1			
Operate Temp. Range	-10 ~ +70 °C			



Frequency Band	Max. RF Output Power (W)
IEEE 802.11b	0.100
IEEE 802.11g	0.024
IEEE 802.11n 2.4GHz 20MHz	0.016
IEEE 802.11n 2.4GHz 40MHz	0.010

EUT Modify Description :

Modify Description:

Class II Permissive change for FCC ID:2AIIIF-07614PG, compare to the original EUT, the changes are as below:

1. change the BT/LE/WLAN/GPS antenna's location
2. change the BT//LE/WLAN/GPS antenna's gain to 2.3dBi (the original is 2dBi, and the antenna type remains the same)
3. add a heat sink, and the appearance changes accordingly
4. change the camera module and the module's layout partly changed
5. add an accessory: car charger
6. software version changes to V8.0_000_20180808.

Above changes do not affect the EUT's RF function.

Verify power is smaller than the original case power.

Therefore, the product is only needed to be tested for AC Power Line Conducted Emission Measurement, Maximum Conducted Output Power Measurement and Radiated Emissions Measurement

Original Report : 1801FR13

Modify: 1807FR11



3 Test Methodology

3.1. Mode of Operation

Decision of Test ATL has verified the construction and function in typical operation. All the test modes were carried out with the EUT in normal operation, which was shown in this test report and defined as:

Test Mode
Mode 1: Transmit mode
Mode 2: IEEE 802.11b Continuous TX mode
Mode 3: IEEE 802.11g Continuous TX mode
Mode 4: IEEE 802.11n 2.4GHz 20MHz Continuous TX mode
Mode 5: IEEE 802.11n 2.4GHz 40MHz Continuous TX mode

Software used to control the EUT for staying in continuous transmitting mode was programmed.

After verification, all tests were carried out with the worst case test modes as shown below except radiated spurious emission below 1GHz and power line conducted emissions below 30MHz, which worst case was in TX mode only.

By preliminary testing and verifying three axis (X, Y and Z) position of EUT transmitted status, it was found that "X axis" position was the worst, then the final test was executed the worst condition and test data were recorded in this report.

Test Mode	ANT-0
Mode 2	V
Mode 3	V
Mode 4	V
Mode 5	V

Test Mode	Antenna Delivery	Data Rate	Test Channel
Mode 2	1TX	1M	1, 6, 11
Mode 3	1TX	6M	1, 6, 11
Mode 4	1TX	6.5M	1, 6, 11
Mode 5	1TX	13.5M	3, 6, 9

3.2. EUT Exercise Software

1.	Setup the EUT shown on "Configuration of Test System Details".
2.	Turn on the power of all equipment.
3.	Turn on TX function
4.	EUT run test program.

Measurement Software	
1	EZ-EMC Ver. ATL-03A1-1
2	EZ-EMC Ver ATL-ITC-3A1-1

3.3. Configuration of Test System Details

Conducted Emissions

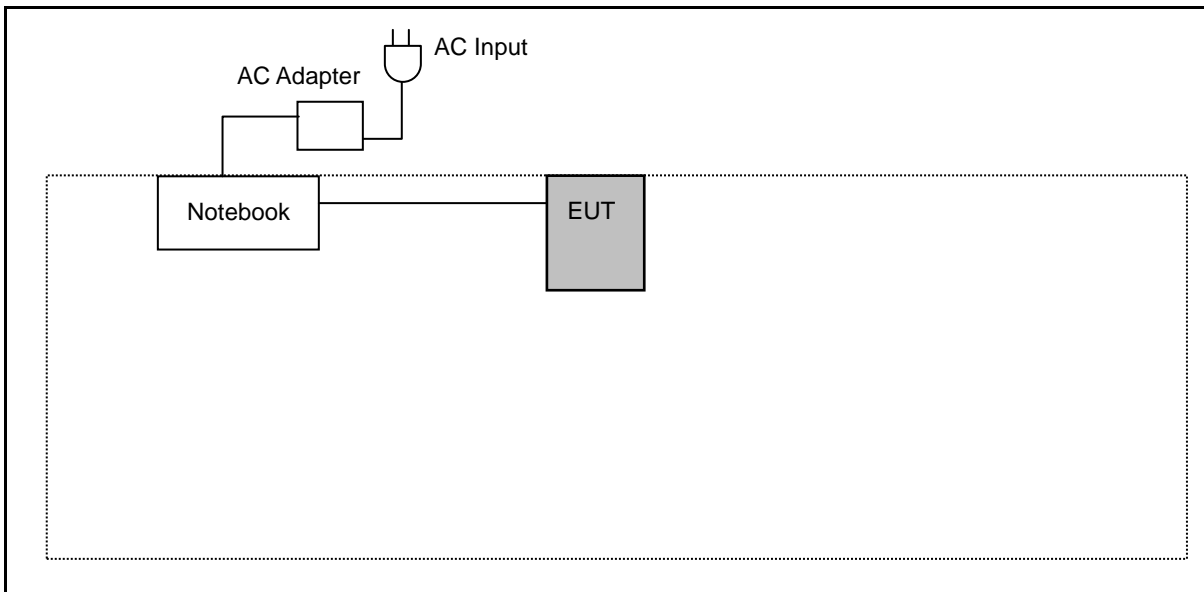

Radiated Emission_ EUT connects to the NB with USB cable

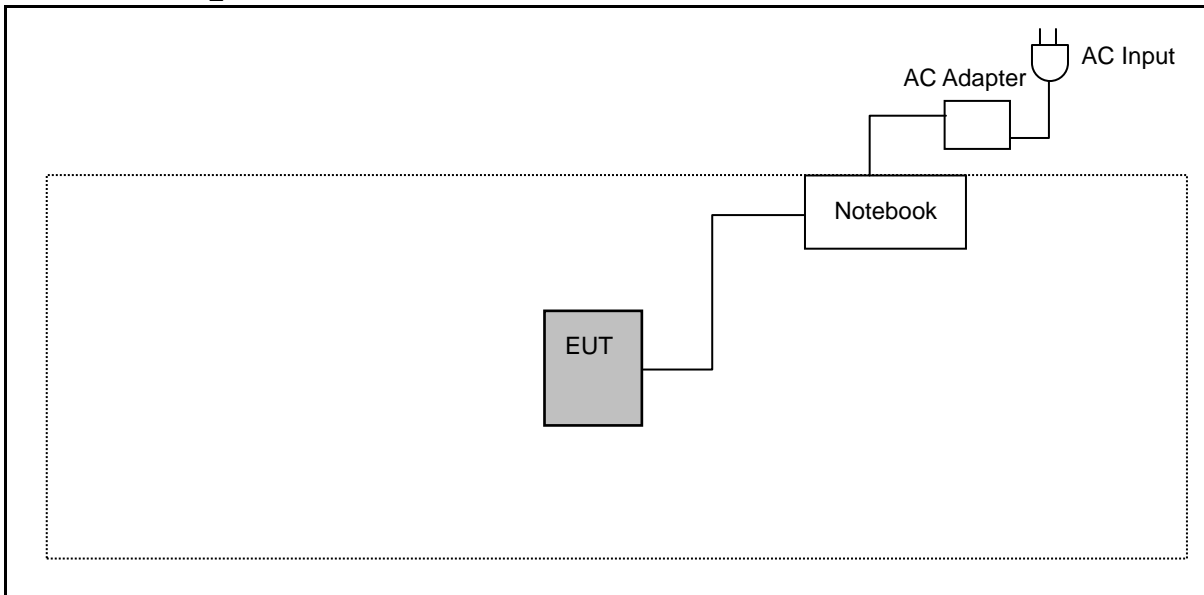

Radiated Emission_ EUT connects to the DC Power Source with the car charger

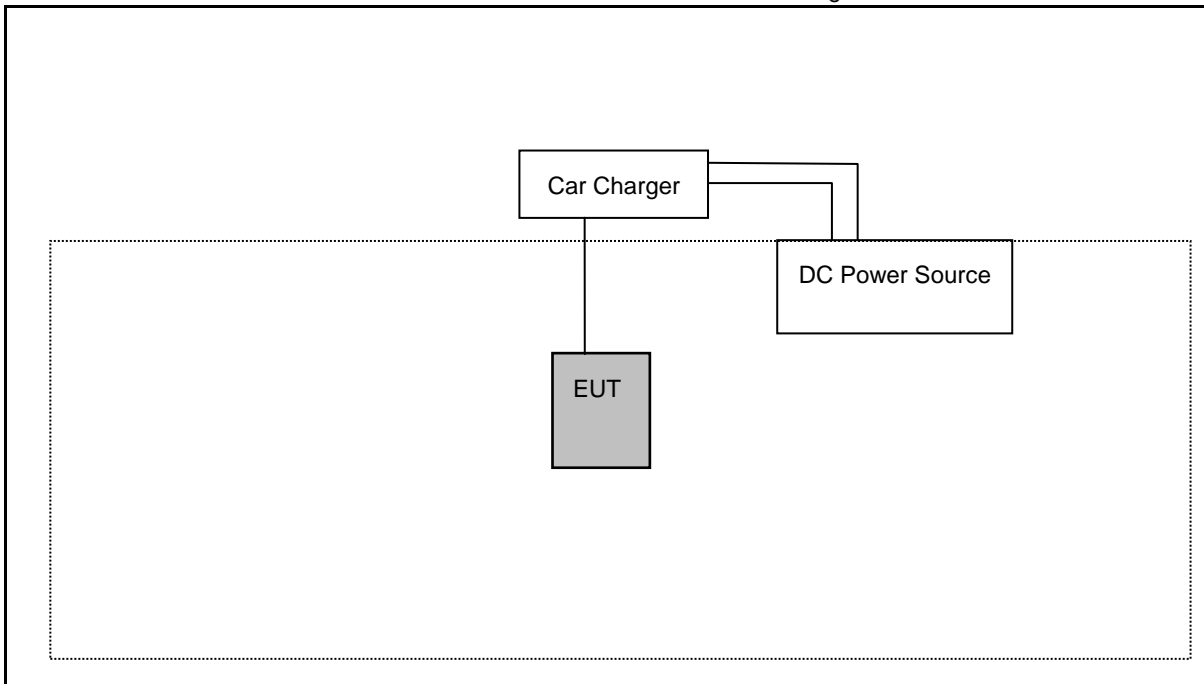



3.4. Test Instruments

For Conducted Emission

Test Period: Jun. 29, 2018

Equipment	Manufacturer	Model Number	Serial Number	Cal. Date	Cal. Period
EMI Test Receiver	R&S	ESCI	101000	12/18/2017	1 year
LISN	R&S	ENV216	101040	04/11/2018	1 year
LISN	R&S	ENV216	101041	03/23/2018	1 year

For Radiated Emissions

Test Period: Jun. 29 ~ Jul. 30, 2018

Equipment	Manufacturer	Model Number	Serial Number	Cal. Date	Cal. Period
Spectrum Analyzer (10Hz~44GHz)	Keysight	N9010A	MY52221312	01/15/2018	1 year
Pre Amplifier (1~26.5GHz)	Agilent	8449B	3008A02237	10/16/2017	1 year
Pre Amplifier (100KHz~1.3GHz)	Agilent	8447D	2944A11119	01/10/2018	1 year
Broadband Antenna	Schwarzbeck	VULB9168	416	10/26/2017	1 year
Horn Antenna (1~18GHz)	SCHWARZBECK MESS-ELEKTRONIK	BBHA9120D	9120D-550	06/22/2018	1 year
Horn Antenna (18~40GHz)	ETS	3116	86467	09/19/2017	1 year
Loop Antenna	COM-POWER CORPORATION	AL-130	121014	03/13/2018	1 year
RF Cable	EMCI	EMC104-N-N-6000	TE01-1	02/20/2018	1 year
Microwave Cable	EMCI	EMC104-SM-SM-1 3000	170814	10/31/2017	1 year
Microwave Cable	EMCI	EMC102-KM-KM-1 4000	151001	02/20/2018	1 year

For Conducted

Test Period: Jul. 04, 2018

Equipment	Manufacturer	Model Number	Serial Number	Cal. Date	Cal. Period
Power Sensor	Anritsu	MA2411B	1126022	08/28/2017	1 year
Power Meter	Anritsu	ML2495A	1135009	08/28/2017	1 year
Microwave Cable	EMCI	EMC102-SM-SM1500	001	11/22/2017	1 year



3.5. Test Site Environment

Items	Required (IEC 60068-1)	Actual
Temperature (°C)	15-35	26
Humidity (%RH)	25-75	60
Barometric pressure (mbar)	860-1060	950

4 Measurement Procedure

4.1. AC Power Line Conducted Emission Measurement

■ Limit

Frequency (MHz)	Quasi-peak	Average
0.15 - 0.5	66 to 56	56 to 46
0.50 - 5.0	56	46
5.0 - 30.0	60	50

■ Test Setup

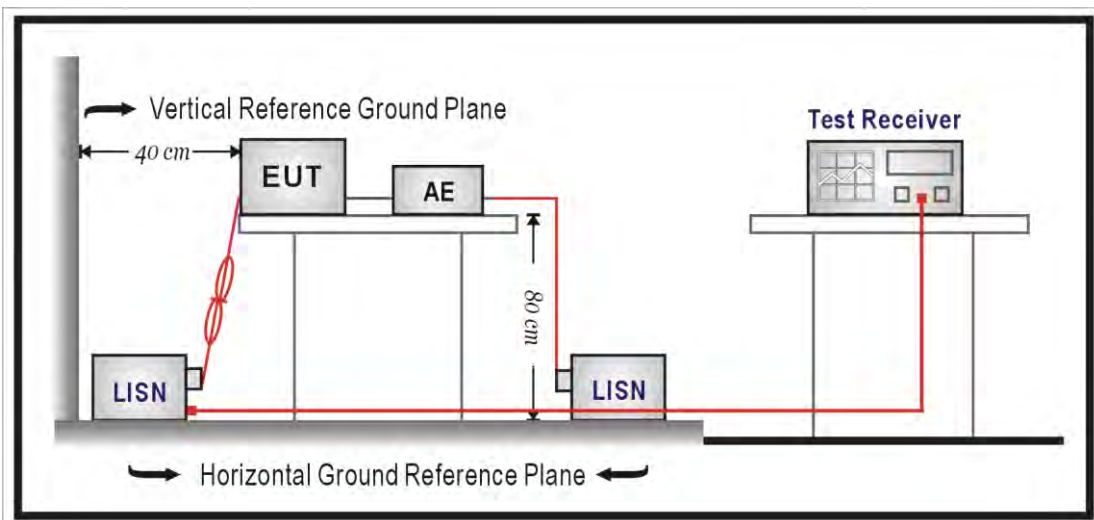

■ Test Procedure

The EUT and simulators are connected to the main power through a line impedance stabilization network (L.I.S.N.). This provides a $50\Omega // 50\mu\text{H}$ coupling impedance for the measuring equipment. The peripheral devices are also connected to the main power through a LISN that provides a $50\Omega // 50\mu\text{H}$ coupling impedance with 50ohm termination.

Tabletop device shall be placed on a non-conducting platform, of nominal size 1 m by 1.5 m, raised 80 cm above the reference ground plane. The wall of screened room shall be located 40cm to the rear of the EUT. Other surfaces of tabletop or floor standing EUT shall be at least 80cm from any other ground conducting surface including one or more LISNs. For floor-standing device shall be placed under the EUT with a 12mm insulating material.

Conducted emissions were investigated over the frequency range from 0.15 MHz to 30 MHz using a resolution bandwidth of 9 kHz. The equipment under test (EUT) shall be meet the limits in section 4.1, as applicable, including the average limit and the quasi-peak limit when using respectively, an average detector and quasi-peak detector measured in accordance with the methods described of related standard. When all of peak value were complied with quasi-peak and average limit from 150kHz to 30MHz then quasi-peak and average measurement was unnecessary.

The AMN shall be placed 0,8 m from the boundary of the unit under test and bonded to a ground reference plane for AMNs mounted on top of the ground reference plane. This distance is between the closest points of the AMN and the EUT. All other units of the EUT and associated equipment shall be at least 0,8 m from the AMN. If the mains power cable is longer than 1m then the cable shall be folded back and forth at the centre of the lead to form a bundle no longer than 0.4m. All of interconnecting cables that hang closer than 40cm to the ground plane shall be folded back and forth in the center forming a bundle 30 cm to 40 cm long. All of EUT and AE shall be separate place more than 0.1m. All 50Ω ports of the LISN shall be resistively terminated into 50Ω loads when not connected to the measuring instrument.

If the reading of the measuring receiver shows fluctuations close to the limit, the reading shall be observed for at least 15 s at each measurement frequency; the higher reading shall be recorded with the exception of any brief isolated high reading which shall be ignored.

4.2. Radiated Emission Measurement

■ Limit

According to §15.209(a), except as provided elsewhere in this subpart, the emissions from an intentional radiator shall not exceed the field strength levels specified in the following table:

Frequency (MHz)	Field Strength ($\mu\text{V}/\text{m}$ at meter)	Measurement Distance (meters)
0.009 – 0.490	$2400 / F$ (kHz)	300
0.490 – 1.705	$24000 / F$ (kHz)	30
1.705 – 30.0	30	30
30 - 88	100**	3
88-216	150**	3
216-960	200**	3
Above 960	500	3

** Except as provided in paragraph (g), fundamental emissions from intentional radiators operating under this Section shall not be located in the frequency bands 54-72 MHz, 76-88 MHz, 174-216 MHz or 470-806 MHz. However, operation within these frequency bands is permitted under other sections of this Part, e.g., Sections 15.231 and 15.241.

■ Setup

9kHz ~ 30MHz

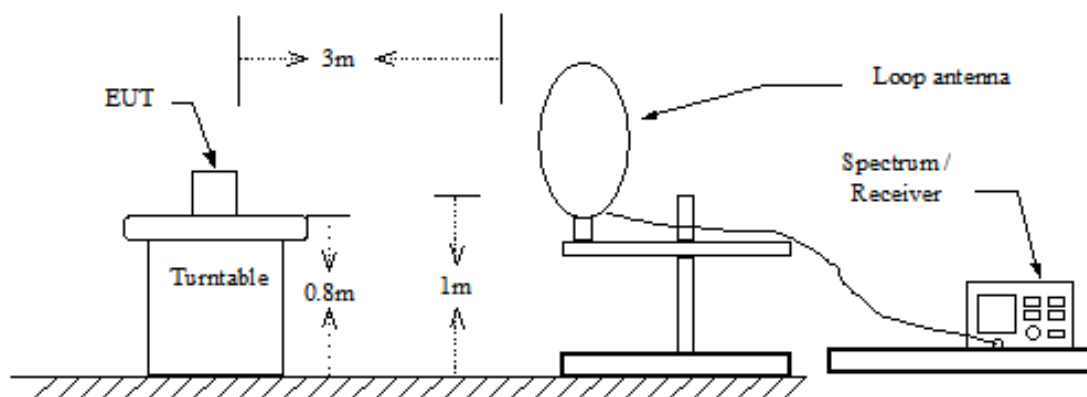

Below 1GHz

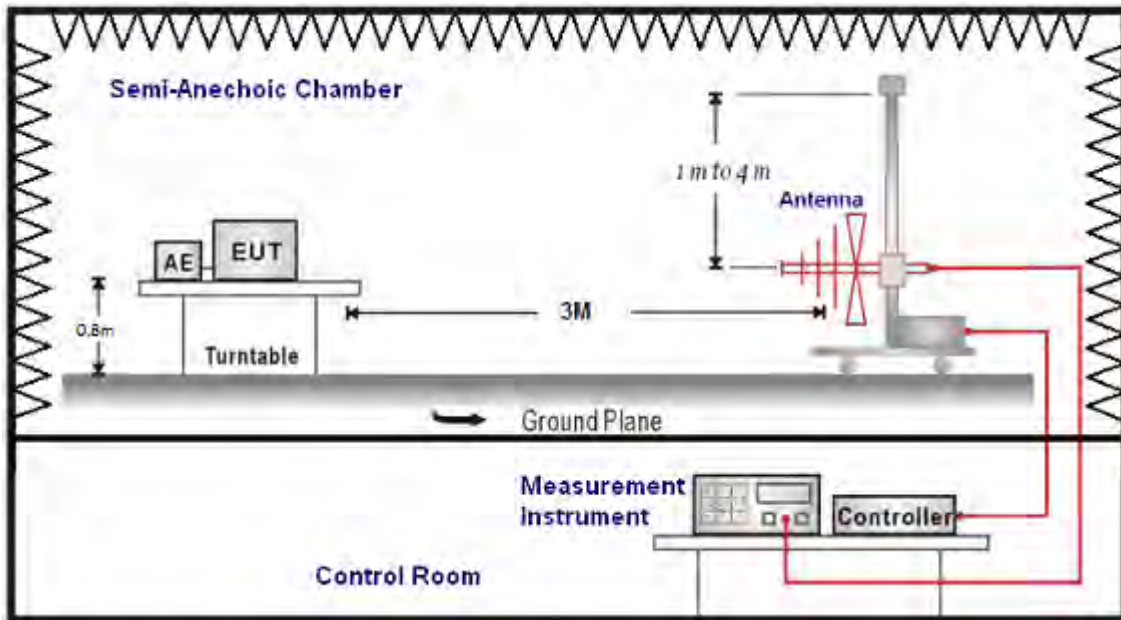

Above 1GHz

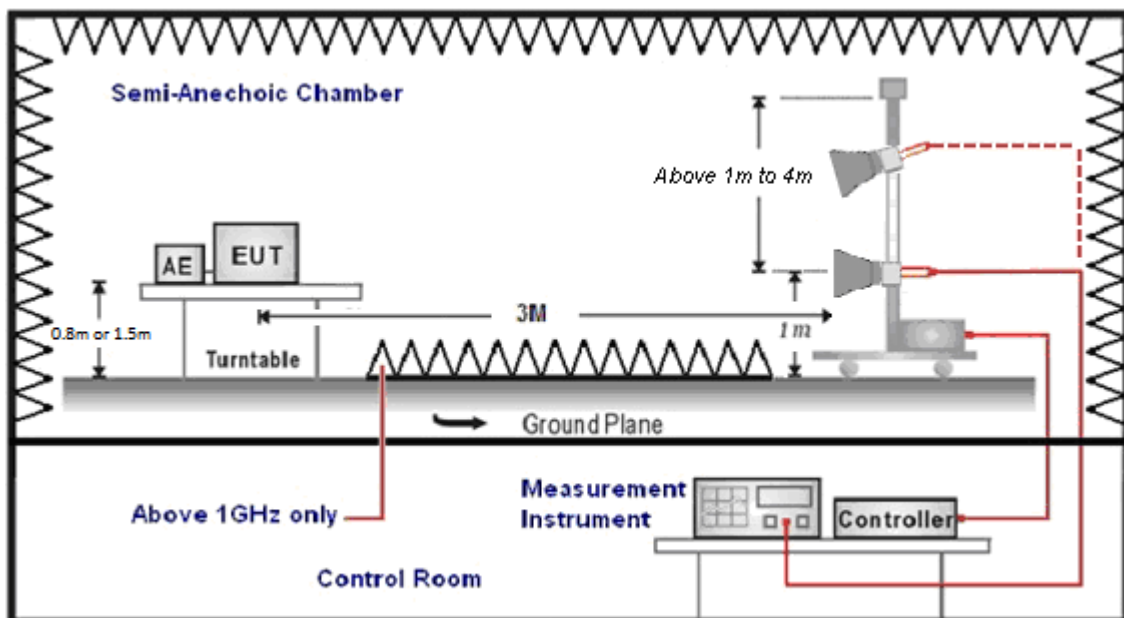



■ Test Procedure

Final radiation measurements were made on a three-meter, Semi Anechoic Chamber. The EUT system was placed on a nonconductive turntable which is 0.8 or 1.5 meters height, top surface 1.0 x 1.5 meter. The spectrum was examined from 250 MHz to 2.5 GHz in order to cover the whole spectrum below 10th harmonic which could generate from the EUT. During the test, EUT was set to transmit continuously & Measurements spectrum range from 9 kHz to 26.5 GHz is investigated.

For measurements below 1 GHz the resolution bandwidth is set to 100 kHz for peak detection measurements or 120 kHz for quasi-peak detection measurements. Peak detection is used unless otherwise noted as quasi-peak.

For measurements above 1 GHz the resolution bandwidth is set to 1 MHz, and then the video bandwidth is set to 1 MHz for peak measurements and 10 Hz for average measurements when Duty cycle >0.98 / $1/T$ for average measurements when Duty cycle <0.98 . A nonconductive material surrounded the EUT to supporting the EUT for standing on three orthogonal planes. At each condition, the EUT was rotated 360 degrees, and the antenna was raised and lowered from one to four meters to find the maximum emission levels. Measurements were taken using both horizontal and vertical antenna polarization.

SCHWARZBECK MESS-ELEKTRONIK Biconilog Antenna at 3 Meter and the SCHWARZBECK Double Ridged Guide Antenna was used in frequencies 1 –26.5 GHz at a distance of 3 meter. The antenna at an angle toward the source of the emission. All test results were extrapolated to equivalent signal at 3 meters utilizing an inverse linear distance extrapolation Factor (20dB/decade).

For testing above 1GHz, the emission level of the EUT in peak mode was 20dB lower than average limit (that means the emission level in peak mode also complies with the limit in average mode), then testing will be stopped and peak values of EUT will be reported, otherwise, the emissions will be measured in average mode again and reported.

Appropriate preamplifiers were used for improving sensitivity and precautions were taken to avoid overloading or desensitizing the spectrum analyzer. No post – detector video filters were used in the test.

The spectrum analyzer's 6 dB bandwidth was set to 1 MHz, and the analyzer was operated in the peak detection mode, for frequencies both below and up 1 GHz. The average levels were obtained by subtracting the duty cycle correction factor from the peak readings.

The following procedures were used to convert the emission levels measured in decibels referenced to 1 microvolt (dBuV) into field intensity in micro volts pre meter (uV/m).

The actual field intensity in decibels referenced to 1 microvolt in to field intensity in micro volts per meter (dBuV/m).



The actual field intensity in referenced to 1 microvolt per meter (dBuV/m) is determined by algebraically adding the measured reading in dBuV, the antenna factor (dB), and cable loss (dB) and Subtracting the gain of preamplifier (dB) is auto calculate in spectrum analyzer.

(1) Amplitude (dBuV/m) = FI (dBuV) +AF (dBuV) +CL (dBuV)-Gain (dB)

FI= Reading of the field intensity.

AF= Antenna factor.

CL= Cable loss.

P.S Amplitude is auto calculate in spectrum analyzer.

(2) Actual Amplitude (dBuV/m) = Amplitude (dBuV)-Dis(dB)

The FCC specified emission limits were calculated according the EUT operating frequency and by following linear interpolation equations:

(a) For fundamental frequency : Transmitter Output < +30dBm

(b) For spurious frequency : Spurious emission limits = fundamental emission limit /10

Data of measurement within this frequency range without mark in the table above means the reading of emissions are attenuated more than 20dB below the permissible limits or the field strength is too small to be measured.

4.3. Maximum Conducted Output Power Measurement

■ Limit

For systems using digital modulation in the 2400-2483.5MHz, the limit for maximum output power is 30dBm.

And According to 15.247 (b), if transmitting antennas of directional gain greater than 6 dBi are used, the power shall be reduced by the amount in dB that the directional gain of the antenna exceeds 6dBi.

■ Test Setup

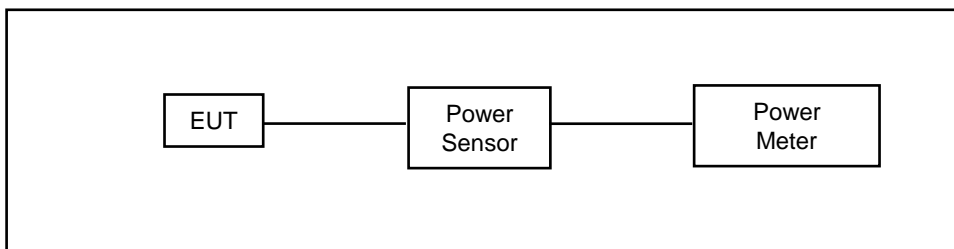

■ Test Procedure

The testing follows the Measurement Procedure of ANSI C63.10-2013 section 11.9.2.3 Method AVGPM.

The tests below are run with the EUT's transmitter set at high power in TX mode. The EUT is needed to force selection of output power level and channel number. While testing, EUT was set to transmit continuously. Remove the Subjective device's antenna and connect the RF output port to power sensor.



4.4. Antenna Measurement

- **Limit**

For intentional device, according to 15.203, an intentional radiator shall be designed to ensure that no antenna other than that furnished by the responsible party shall be used with the device.

And According to 15.247 (b), if transmitting antennas of directional gain greater than 6 dBi are used, the power shall be reduced by the amount in dB that the directional gain of the antenna exceeds 6dBi.

- **Antenna Description**

See section 2 – antenna information.



5 Test Results

Annex A. AC Power Line Conducted Emission Test Results

Standard:	FCC Part 15.247	Line:	L1
Test Mode:	Mode 1	Power:	AC 120V/60Hz
		Temp.(°C)/Hum.(%RH):	26(°C)/60%RH
Description:			

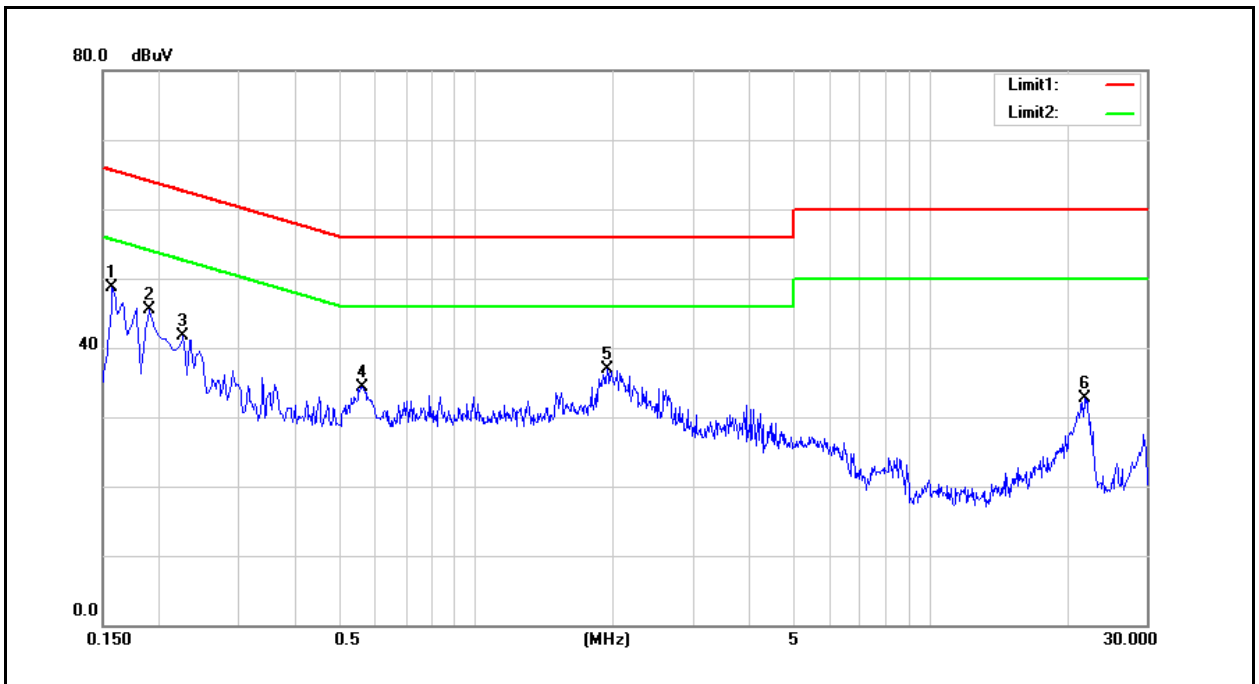

No.	Frequency (MHz)	QP reading (dBuV)	AVG reading (dBuV)	Correction factor (dB)	QP result (dBuV)	AVG result (dBuV)	QP limit (dBuV)	AVG limit (dBuV)	QP margin (dB)	AVG margin (dB)	Remark
1	0.1580	35.91	17.57	9.68	45.59	27.25	65.57	55.57	-19.98	-28.32	Pass
2	0.1900	30.39	15.06	9.68	40.07	24.74	64.04	54.04	-23.97	-29.30	Pass
3	0.2260	26.07	12.02	9.68	35.75	21.70	62.60	52.60	-26.85	-30.90	Pass
4	0.5620	22.78	14.24	9.68	32.46	23.92	56.00	46.00	-23.54	-22.08	Pass
5	1.9420	22.37	15.43	9.74	32.11	25.17	56.00	46.00	-23.89	-20.83	Pass
6	21.9380	14.67	4.77	10.53	25.20	15.30	60.00	50.00	-34.80	-34.70	Pass

Note: 1. Result (dBuV/m) = Correct Factor (dB/m) + Reading(dBuV).

2. Correction factor (dB) = Cable loss (dB) + L.I.S.N. factor (dB).



Standard:	FCC Part 15.247	Line:	N
Test Mode:	Mode 1	Power:	AC 120V/60Hz
		Temp.(°C)/Hum.(%RH):	26(°C)/60%RH
Description:			

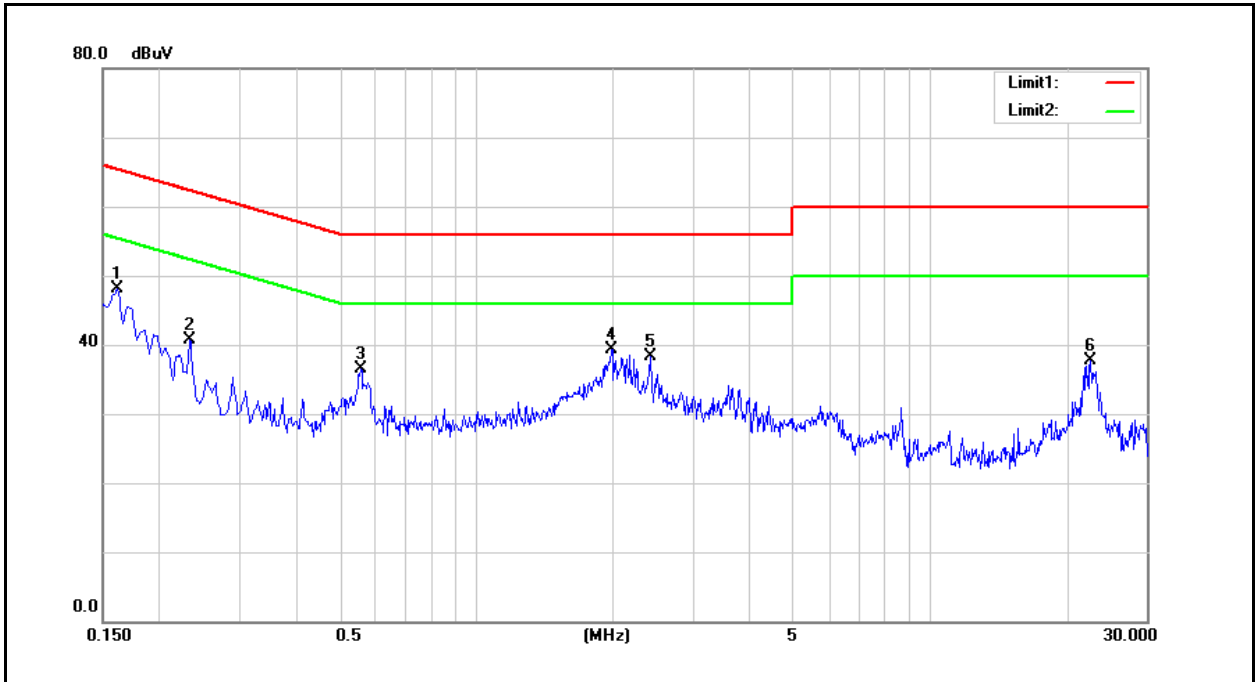

No.	Frequency (MHz)	QP reading (dBuV)	AVG reading (dBuV)	Correction factor (dB)	QP result (dBuV)	AVG result (dBuV)	QP limit (dBuV)	AVG limit (dBuV)	QP margin (dB)	AVG margin (dB)	Remark
1	0.1620	32.86	16.30	9.69	42.55	25.99	65.36	55.36	-22.81	-29.37	Pass
2	0.2340	24.38	11.36	9.69	34.07	21.05	62.31	52.31	-28.24	-31.26	Pass
3	0.5580	23.37	14.92	9.70	33.07	24.62	56.00	46.00	-22.93	-21.38	Pass
4	1.9900	22.72	16.47	9.77	32.49	26.24	56.00	46.00	-23.51	-19.76	Pass
5	2.4340	20.76	14.41	9.78	30.54	24.19	56.00	46.00	-25.46	-21.81	Pass
6	22.5780	18.39	7.45	10.62	29.01	18.07	60.00	50.00	-30.99	-31.93	Pass

Note: 1. Result (dBuV/m) = Correct Factor (dB/m) + Reading(dBuV).
 2. Correction factor (dB) = Cable loss (dB) + L.I.S.N. factor (dB).



Annex B. Conducted Test Results

Maximum Conducted Output Power Measurement

Test Mode	Data Rate (Mbps)	Frequency (MHz)	Peak Output Power				
			Original		Verify		Limit
			dBm	W	dBm	W	dBm
Mode 2	1	2412	19.77	0.095	19.20	0.083	< 30
		2437	20.01	0.100	19.32	0.086	< 30
		2462	18.88	0.077	17.97	0.063	< 30
Mode 3	6	2412	13.75	0.024	13.07	0.020	< 30
		2437	12.99	0.020	12.17	0.016	< 30
		2462	12.88	0.019	11.99	0.016	< 30
Mode 4	6.5	2412	11.95	0.016	11.46	0.014	< 30
		2437	11.87	0.015	11.28	0.013	< 30
		2462	11.85	0.015	11.10	0.013	< 30
Mode 5	13.5	2422	10.18	0.010	9.44	0.009	< 30
		2437	9.05	0.008	8.67	0.007	< 30
		2452	9.01	0.008	8.61	0.007	< 30

Note: The relevant measured result has the offset with cable loss already.

Annex C. Radiated Emission Test Results

Harmonic

Below 1GHz

Standard:	FCC Part 15.247	Test Distance:	3m				
Test item:	Harmonic	Power:	AC 120V/60Hz				
Test Mode:	Mode 1	Temp.(°C)/Hum.(%RH):	26(°C)/60%RH				
Description:	EUT connects to NB with the USB cable						
Frequency (MHz)	Reading (dBuV)	Correct Factor (dB/m)	Result (dBuV/m)	Limit (dBuV/m)	Margin (dB)	Remark	Ant.Polar. H / V
173.5600	48.04	-10.66	37.38	43.50	-6.12	QP	H
180.3500	48.12	-11.32	36.80	43.50	-6.70	QP	H
272.5000	45.54	-10.98	34.56	46.00	-11.44	QP	H
359.8000	43.18	-8.71	34.47	46.00	-11.53	QP	H
480.0800	44.56	-5.16	39.40	46.00	-6.60	QP	H
853.5300	32.21	0.70	32.91	46.00	-13.09	QP	H
176.4700	46.78	-10.92	35.86	43.50	-7.64	QP	V
202.6600	44.48	-13.42	31.06	43.50	-12.44	QP	V
480.0800	43.17	-5.16	38.01	46.00	-7.99	QP	V
686.6900	39.84	-2.06	37.78	46.00	-8.22	QP	V
696.3900	41.16	-1.99	39.17	46.00	-6.83	QP	V
783.6900	34.71	0.17	34.88	46.00	-11.12	QP	V

- Note: 1. Result (dBuV/m) = Correct Factor (dB/m) + Reading(dBuV).
 2. Correction factor (dB/m) = Antenna Factor (dB/m) + Cable loss (dB) – Pre-Amplifier gain (dB).
 3. When the peak results are less than average limit, so not need to evaluate the average.



Standard:		FCC Part 15.247		Test Distance:		3m	
Test item:		Harmonic		Power:		AC 120V/60Hz	
Test Mode:		Mode 1		Temp.(°C)/Hum.(%RH):		26(°C)/60%RH	
Description:		EUT connects to DC Power Source with the car charger					
Frequency (MHz)	Reading (dBuV)	Correct Factor (dB/m)	Result (dBuV/m)	Limit (dBuV/m)	Margin (dB)	Remark	Ant.Polar. H / V
330.7000	42.50	-9.82	32.68	46.00	-13.32	peak	H
647.8900	37.82	-2.38	35.44	46.00	-10.56	peak	H
696.3900	40.40	-1.99	38.41	46.00	-7.59	peak	H
743.9200	40.04	-0.98	39.06	46.00	-6.94	peak	H
792.4200	37.55	0.19	37.74	46.00	-8.26	peak	H
839.9500	36.81	0.67	37.48	46.00	-8.52	peak	H
30.9700	46.55	-11.62	34.93	40.00	-5.07	peak	V
696.3900	36.23	-1.99	34.24	46.00	-11.76	peak	V
743.9200	38.35	-0.98	37.37	46.00	-8.63	peak	V
792.4200	37.80	0.19	37.99	46.00	-8.01	peak	V
839.9500	37.09	0.67	37.76	46.00	-8.24	peak	V
935.9800	34.74	2.58	37.32	46.00	-8.68	peak	V

- Note: 1. Result (dBuV/m) = Correct Factor (dB/m) + Reading(dBuV).
 2. Correction factor (dB/m) = Antenna Factor (dB/m) + Cable loss (dB) – Pre-Amplifier gain (dB).
 3. When the peak results are less than average limit, so not need to evaluate the average.

Above 1GHz

Standard:	FCC Part 15.247	Test Distance:	3m
Test item:	Harmonic	Power:	AC 120V/60Hz
Frequency:	2412MHz	Temp.(°C)/Hum.(%RH):	26(°C)/60%RH
Mode:	Mode 2		
Ant.Polar.:	Horizontal		

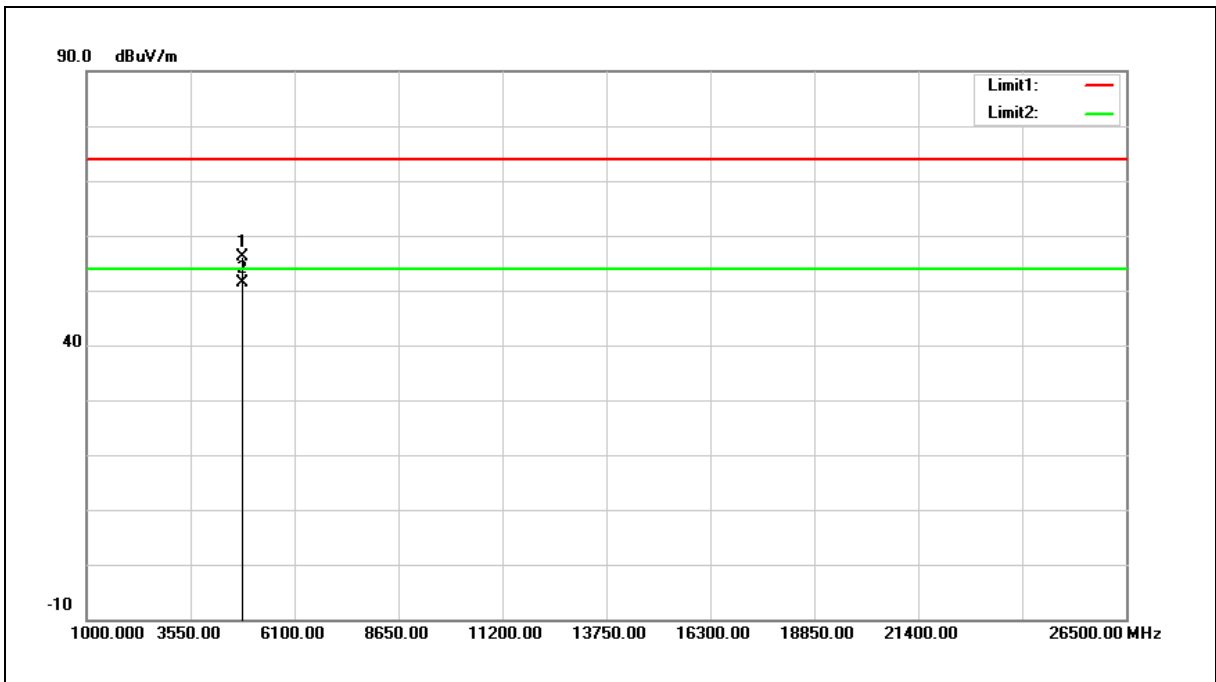

No.	Frequency (MHz)	Reading (dBuV)	Correct Factor (dB/m)	Result (dBuV/m)	Limit (dBuV/m)	Margin (dB)	Remark
1	4824.000	60.37	-4.36	56.01	74.00	-17.99	peak
2	4824.000	55.86	-4.36	51.50	54.00	-2.50	AVG

Note:1.Result (dBuV/m) = Correct Factor (dB/m) + Reading(dBuV).

2.Correction factor (dB/m) = Antenna Factor (dB/m) + Cable loss (dB) – Pre-Amplifier gain (dB).

3.When the peak results are less than average limit, so not need to evaluate the average.



Standard:	FCC Part 15.247	Test Distance:	3m
Test item:	Harmonic	Power:	AC 120V/60Hz
Frequency:	2412MHz	Temp.(°C)/Hum.(%RH):	26(°C)/60%RH
Mode:	Mode 2		
Ant.Polar.:	Vertical		

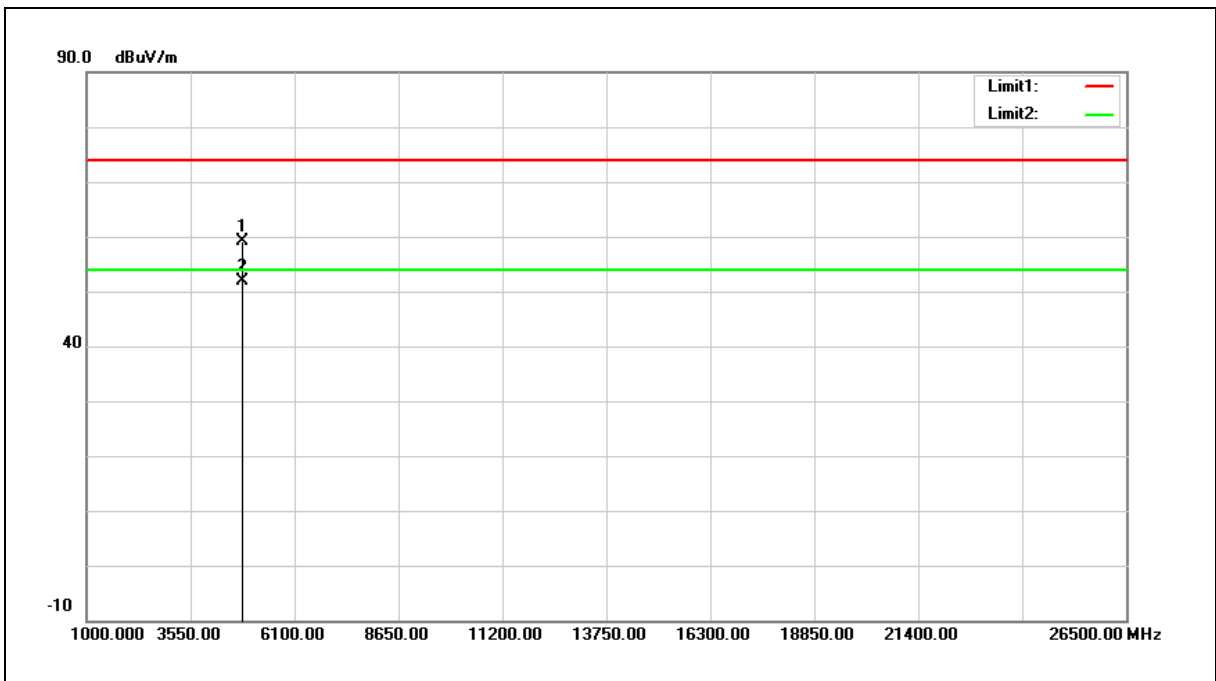

No.	Frequency (MHz)	Reading (dBuV)	Correct Factor (dB/m)	Result (dBuV/m)	Limit (dBuV/m)	Margin (dB)	Remark
1	4824.000	63.45	-4.36	59.09	74.00	-14.91	peak
2	4824.000	56.31	-4.36	51.95	54.00	-2.05	AVG

- Note: 1. Result (dBuV/m) = Correct Factor (dB/m) + Reading(dBuV).
 2. Correction factor (dB/m) = Antenna Factor (dB/m) + Cable loss (dB) – Pre-Amplifier gain (dB).
 3. When the peak results are less than average limit, so not need to evaluate the average.



Standard:	FCC Part 15.247	Test Distance:	3m
Test item:	Harmonic	Power:	AC 120V/60Hz
Frequency:	2437MHz	Temp.(°C)/Hum.(%RH):	26(°C)/60%RH
Mode:	Mode 2		
Ant.Polar.:	Horizontal		

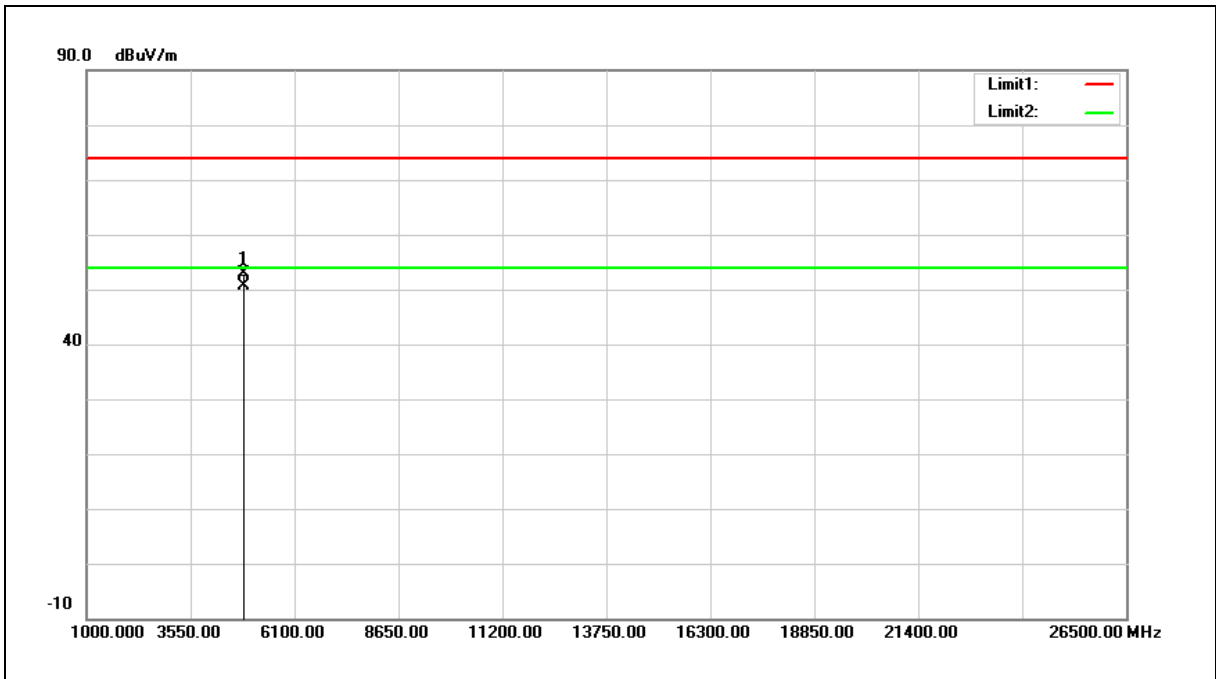

No.	Frequency (MHz)	Reading (dBuV)	Correct Factor (dB/m)	Result (dBuV/m)	Limit (dBuV/m)	Margin (dB)	Remark
1	4874.000	57.23	-4.37	52.86	74.00	-21.14	peak
2	4874.000	55.00	-4.37	50.63	54.00	-3.37	AVG

- Note: 1.Result (dBuV/m) = Correct Factor (dB/m) + Reading(dBuV).
 2.Correction factor (dB/m) = Antenna Factor (dB/m) + Cable loss (dB) – Pre-Amplifier gain (dB).
 3.When the peak results are less than average limit, so not need to evaluate the average.



Standard:	FCC Part 15.247	Test Distance:	3m
Test item:	Harmonic	Power:	AC 120V/60Hz
Frequency:	2437MHz	Temp.(°C)/Hum.(%RH):	26(°C)/60%RH
Mode:	Mode 2		
Ant.Polar.:	Vertical		

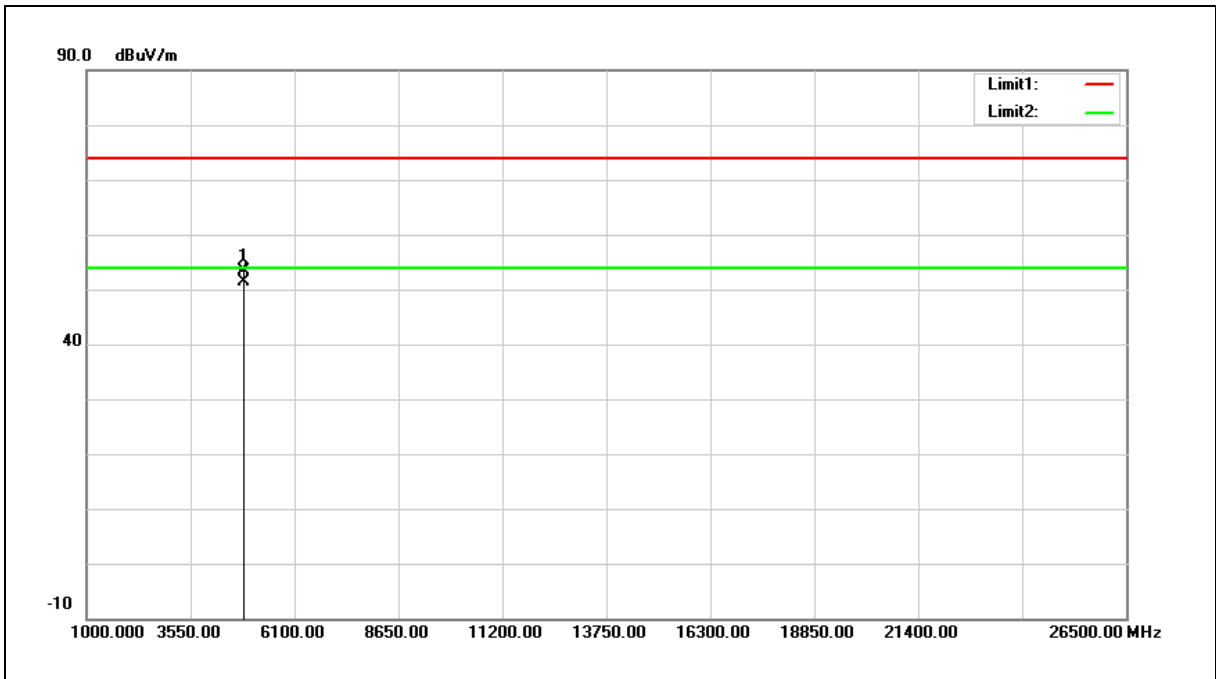

No.	Frequency (MHz)	Reading (dBuV)	Correct Factor (dB/m)	Result (dBuV/m)	Limit (dBuV/m)	Margin (dB)	Remark
1	4874.000	57.80	-4.37	53.43	74.00	-20.57	peak
2	4874.000	55.84	-4.37	51.47	54.00	-2.53	AVG

- Note: 1.Result (dBuV/m) = Correct Factor (dB/m) + Reading(dBuV).
 2.Correction factor (dB/m) = Antenna Factor (dB/m) + Cable loss (dB) – Pre-Amplifier gain (dB).
 3.When the peak results are less than average limit, so not need to evaluate the average.



Standard:	FCC Part 15.247	Test Distance:	3m
Test item:	Harmonic	Power:	AC 120V/60Hz
Frequency:	2462MHz	Temp.(°C)/Hum.(%RH):	26(°C)/60%RH
Mode:	Mode 2		
Ant.Polar.:	Horizontal		

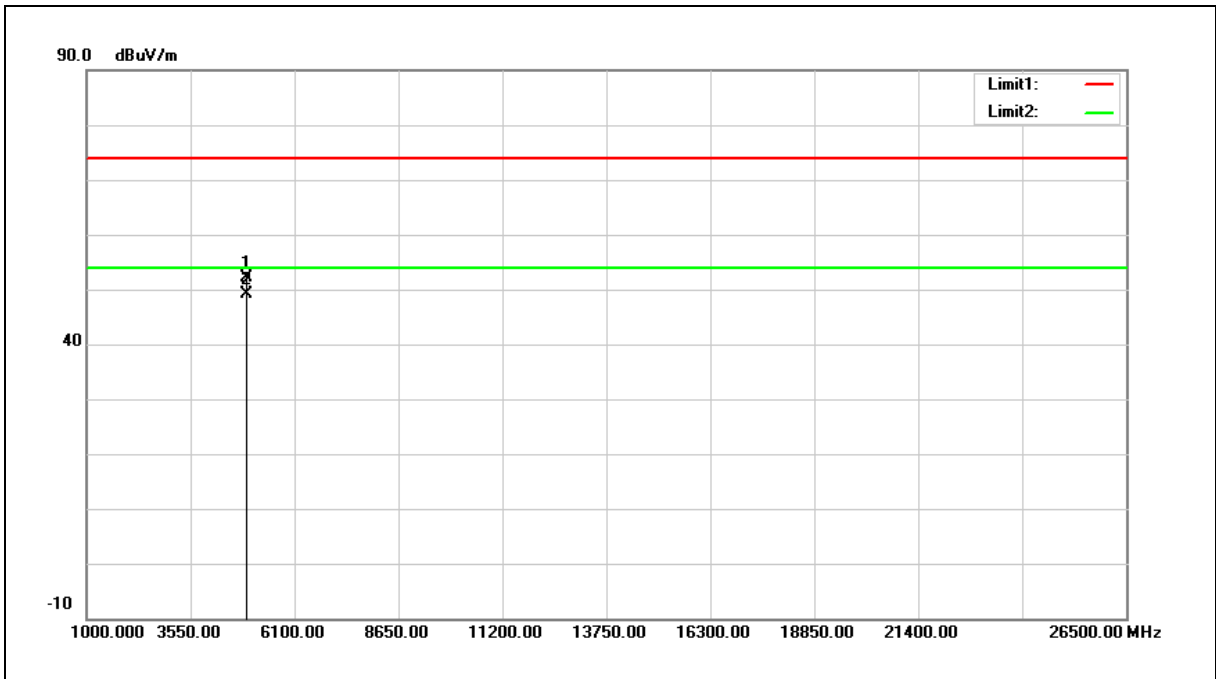

No.	Frequency (MHz)	Reading (dBuV)	Correct Factor (dB/m)	Result (dBuV/m)	Limit (dBuV/m)	Margin (dB)	Remark
1	4924.000	56.61	-4.39	52.22	74.00	-21.78	peak
2	4924.000	53.58	-4.39	49.19	54.00	-4.81	AVG

- Note: 1.Result (dBuV/m) = Correct Factor (dB/m) + Reading(dBuV).
 2.Correction factor (dB/m) = Antenna Factor (dB/m) + Cable loss (dB) – Pre-Amplifier gain (dB).
 3.When the peak results are less than average limit, so not need to evaluate the average.



Standard:	FCC Part 15.247	Test Distance:	3m
Test item:	Harmonic	Power:	AC 120V/60Hz
Frequency:	2462MHz	Temp.(°C)/Hum.(%RH):	26(°C)/60%RH
Mode:	Mode 2		
Ant.Polar.:	Vertical		

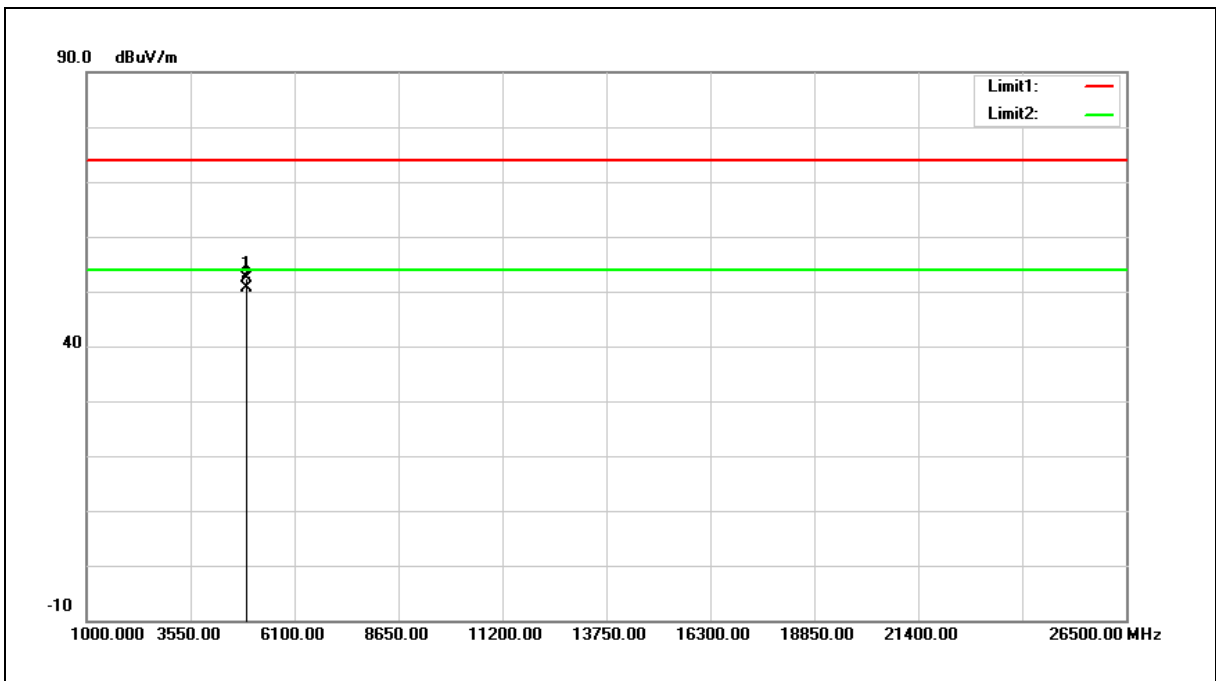

No.	Frequency (MHz)	Reading (dBuV)	Correct Factor (dB/m)	Result (dBuV/m)	Limit (dBuV/m)	Margin (dB)	Remark
1	4924.000	56.68	-4.38	52.30	74.00	-21.70	peak
2	4924.000	55.02	-4.38	50.64	54.00	-3.36	AVG

- Note: 1.Result (dBuV/m) = Correct Factor (dB/m) + Reading(dBuV).
 2.Correction factor (dB/m) = Antenna Factor (dB/m) + Cable loss (dB) – Pre-Amplifier gain (dB).
 3.When the peak results are less than average limit, so not need to evaluate the average.



Standard:	FCC Part 15.247	Test Distance:	3m
Test item:	Harmonic	Power:	AC 120V/60Hz
Frequency:	2412MHz	Temp.(°C)/Hum.(%RH):	26(°C)/60%RH
Mode:	Mode 3		
Ant.Polar.:	Horizontal		

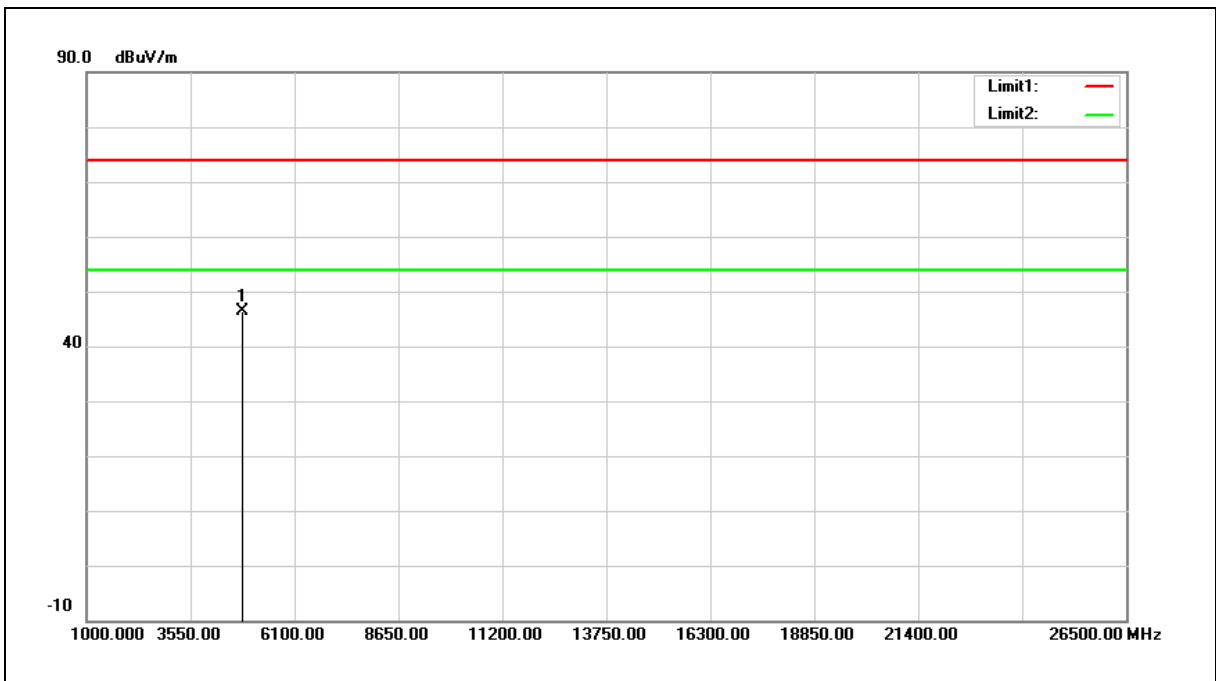

No.	Frequency (MHz)	Reading (dBuV)	Correct Factor (dB/m)	Result (dBuV/m)	Limit (dBuV/m)	Margin (dB)	Remark
1	4824.000	50.82	-4.36	46.46	74.00	-27.54	peak

Note:1.Result (dBuV/m) = Correct Factor (dB/m) + Reading(dBuV).

2.Correction factor (dB/m) = Antenna Factor (dB/m) + Cable loss (dB) – Pre-Amplifier gain (dB).

3.When the peak results are less than average limit, so not need to evaluate the average.



Standard:	FCC Part 15.247	Test Distance:	3m
Test item:	Harmonic	Power:	AC 120V/60Hz
Frequency:	2412MHz	Temp.(°C)/Hum.(%RH):	26(°C)/60%RH
Mode:	Mode 3		
Ant.Polar.:	Vertical		

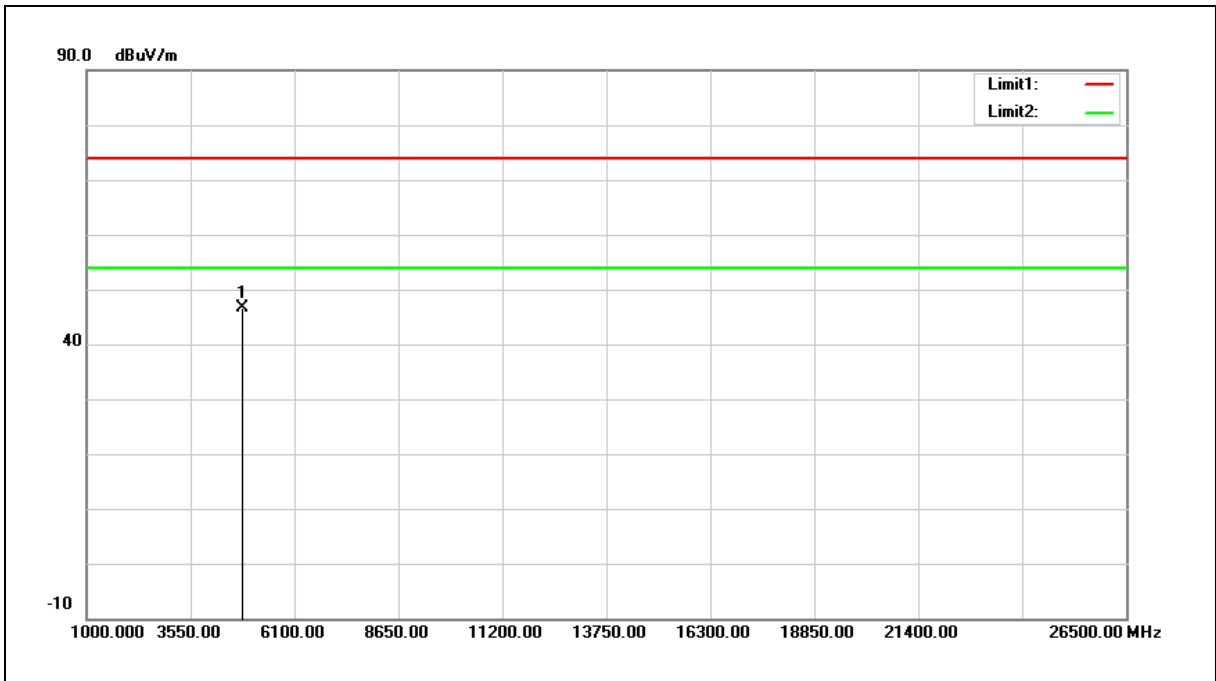

No.	Frequency (MHz)	Reading (dBuV)	Correct Factor (dB/m)	Result (dBuV/m)	Limit (dBuV/m)	Margin (dB)	Remark
1	4824.000	50.90	-4.36	46.54	74.00	-27.46	peak

Note:1.Result (dBuV/m) = Correct Factor (dB/m) + Reading(dBuV).

2.Correction factor (dB/m) = Antenna Factor (dB/m) + Cable loss (dB) – Pre-Amplifier gain (dB).

3.When the peak results are less than average limit, so not need to evaluate the average.



Standard:	FCC Part 15.247	Test Distance:	3m
Test item:	Harmonic	Power:	AC 120V/60Hz
Frequency:	2437MHz	Temp.(°C)/Hum.(%RH):	26(°C)/60%RH
Mode:	Mode 3		
Ant.Polar.:	Horizontal		

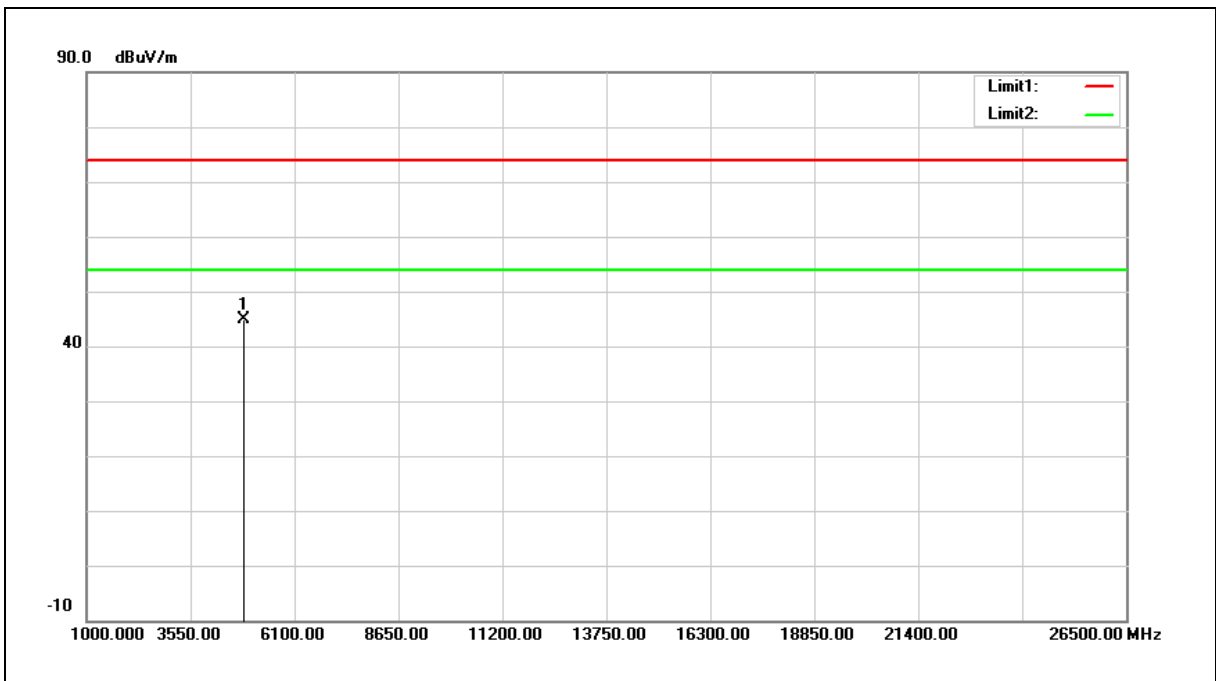

No.	Frequency (MHz)	Reading (dBuV)	Correct Factor (dB/m)	Result (dBuV/m)	Limit (dBuV/m)	Margin (dB)	Remark
1	4874.000	49.20	-4.37	44.83	74.00	-29.17	peak

Note:1.Result (dBuV/m) = Correct Factor (dB/m) + Reading(dBuV).

2.Correction factor (dB/m) = Antenna Factor (dB/m) + Cable loss (dB) – Pre-Amplifier gain (dB).

3.When the peak results are less than average limit, so not need to evaluate the average.



Standard:	FCC Part 15.247	Test Distance:	3m
Test item:	Harmonic	Power:	AC 120V/60Hz
Frequency:	2437MHz	Temp.(°C)/Hum.(%RH):	26(°C)/60%RH
Mode:	Mode 3		
Ant.Polar.:	Vertical		

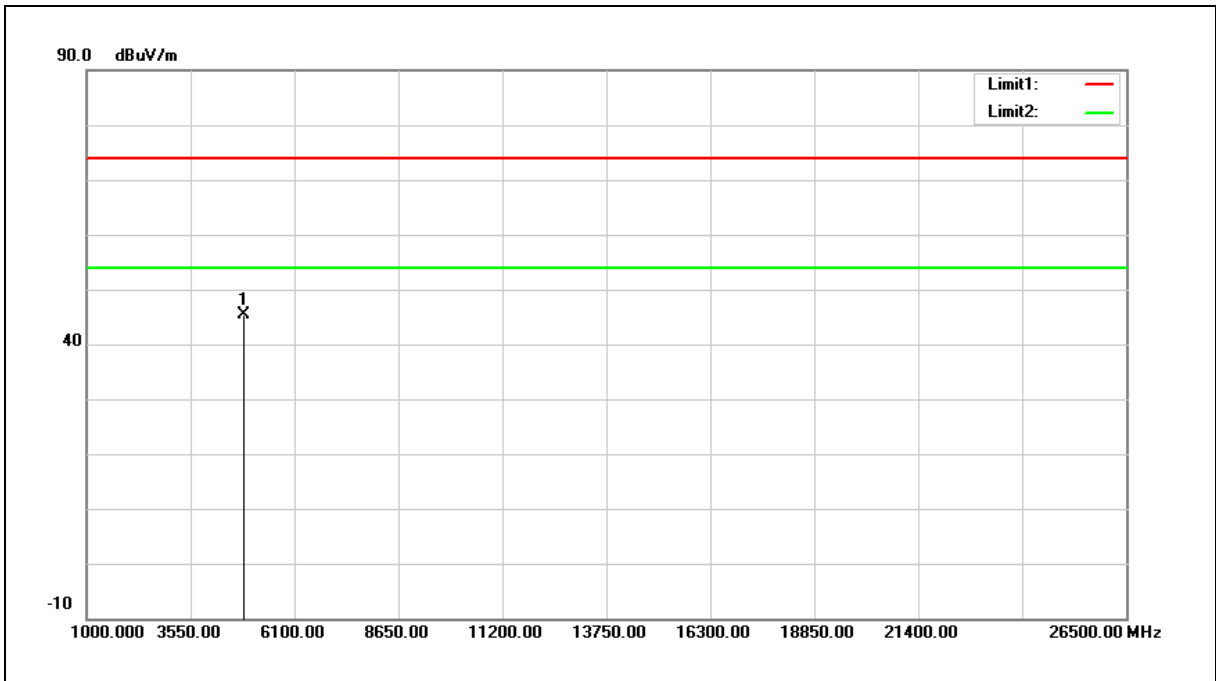

No.	Frequency (MHz)	Reading (dBuV)	Correct Factor (dB/m)	Result (dBuV/m)	Limit (dBuV/m)	Margin (dB)	Remark
1	4874.000	49.69	-4.37	45.32	74.00	-28.68	peak

Note:1.Result (dBuV/m) = Correct Factor (dB/m) + Reading(dBuV).

2.Correction factor (dB/m) = Antenna Factor (dB/m) + Cable loss (dB) – Pre-Amplifier gain (dB).

3.When the peak results are less than average limit, so not need to evaluate the average.



Standard:	FCC Part 15.247	Test Distance:	3m
Test item:	Harmonic	Power:	AC 120V/60Hz
Frequency:	2462MHz	Temp.(°C)/Hum.(%RH):	26(°C)/60%RH
Mode:	Mode 3		
Ant.Polar.:	Horizontal		

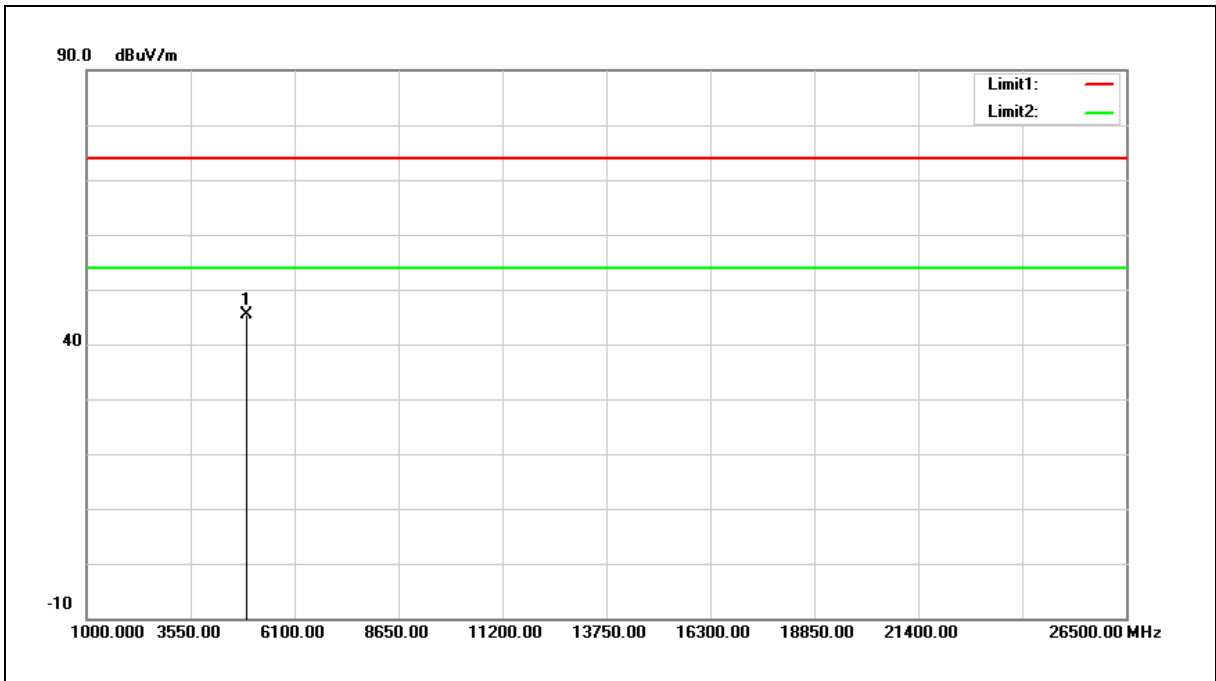

No.	Frequency (MHz)	Reading (dBuV)	Correct Factor (dB/m)	Result (dBuV/m)	Limit (dBuV/m)	Margin (dB)	Remark
1	4924.000	49.84	-4.39	45.45	74.00	-28.55	peak

Note:1.Result (dBuV/m) = Correct Factor (dB/m) + Reading(dBuV).

2.Correction factor (dB/m) = Antenna Factor (dB/m) + Cable loss (dB) – Pre-Amplifier gain (dB).

3.When the peak results are less than average limit, so not need to evaluate the average.



Standard:	FCC Part 15.247	Test Distance:	3m
Test item:	Harmonic	Power:	AC 120V/60Hz
Frequency:	2462MHz	Temp.(°C)/Hum.(%RH):	26(°C)/60%RH
Mode:	Mode 3		
Ant.Polar.:	Vertical		

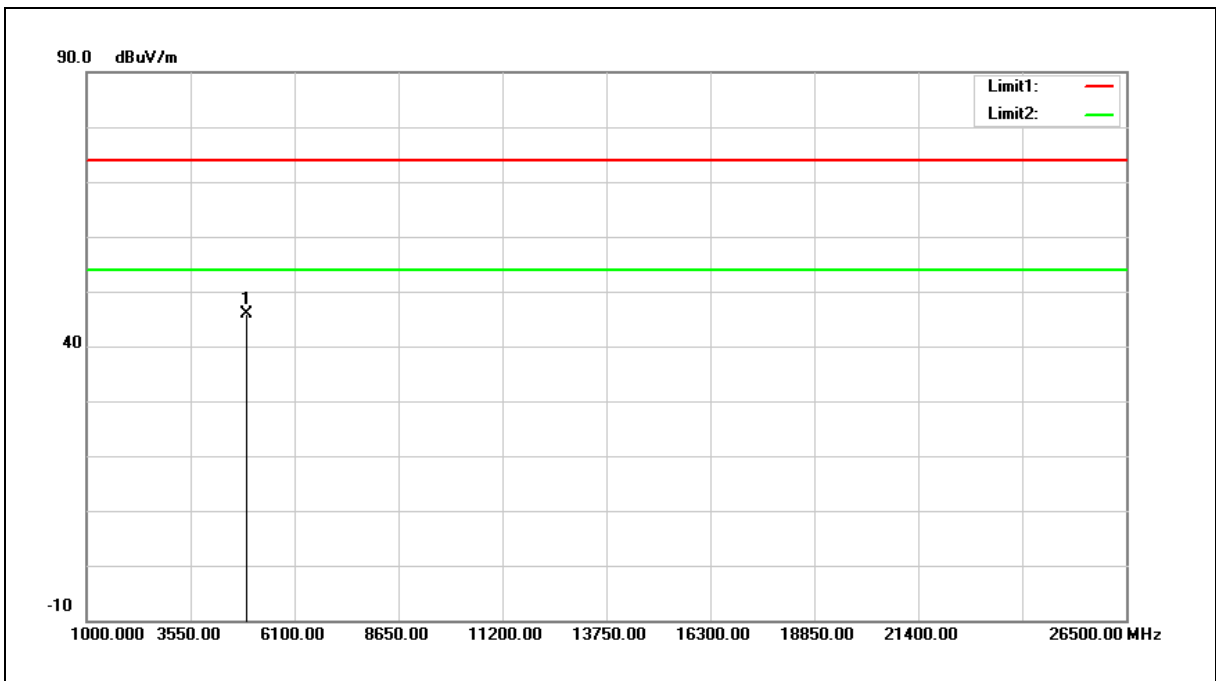

No.	Frequency (MHz)	Reading (dBuV)	Correct Factor (dB/m)	Result (dBuV/m)	Limit (dBuV/m)	Margin (dB)	Remark
1	4924.000	50.24	-4.39	45.85	74.00	-28.15	peak

Note:1.Result (dBuV/m) = Correct Factor (dB/m) + Reading(dBuV).

2.Correction factor (dB/m) = Antenna Factor (dB/m) + Cable loss (dB) – Pre-Amplifier gain (dB).

3.When the peak results are less than average limit, so not need to evaluate the average.



Standard:	FCC Part 15.247	Test Distance:	3m
Test item:	Harmonic	Power:	AC 120V/60Hz
Frequency:	2412MHz	Temp.(°C)/Hum.(%RH):	26(°C)/60%RH
Mode:	Mode 4		
Ant.Polar.:	Horizontal		

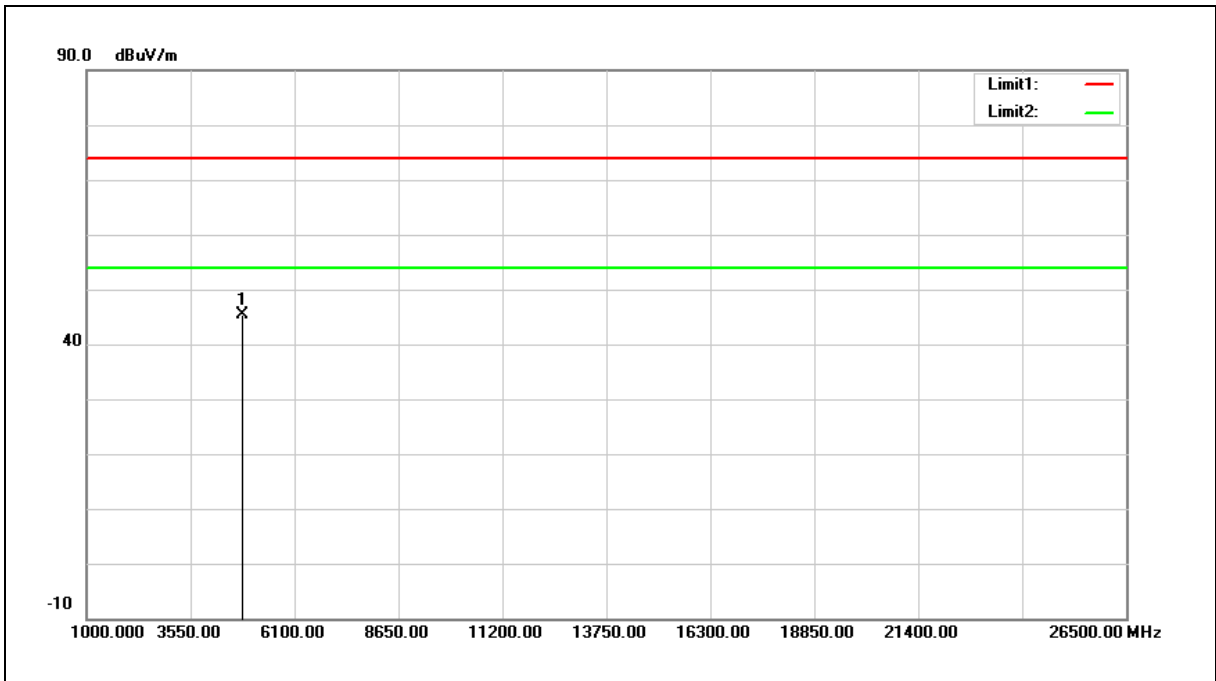

No.	Frequency (MHz)	Reading (dBuV)	Correct Factor (dB/m)	Result (dBuV/m)	Limit (dBuV/m)	Margin (dB)	Remark
1	4824.000	49.81	-4.36	45.45	74.00	-28.55	peak

Note:1.Result (dBuV/m) = Correct Factor (dB/m) + Reading(dBuV).

2.Correction factor (dB/m) = Antenna Factor (dB/m) + Cable loss (dB) – Pre-Amplifier gain (dB).

3.When the peak results are less than average limit, so not need to evaluate the average.



Standard:	FCC Part 15.247	Test Distance:	3m
Test item:	Harmonic	Power:	AC 120V/60Hz
Frequency:	2412MHz	Temp.(°C)/Hum.(%RH):	26(°C)/60%RH
Mode:	Mode 4		
Ant.Polar.:	Vertical		

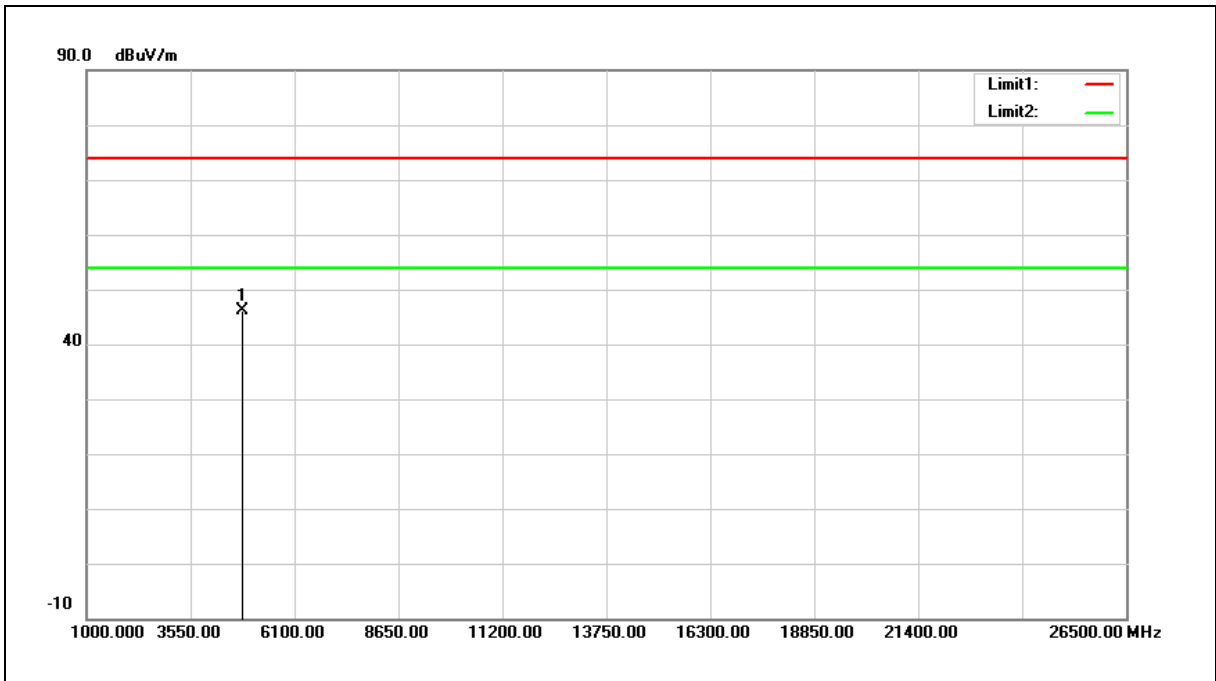

No.	Frequency (MHz)	Reading (dBuV)	Correct Factor (dB/m)	Result (dBuV/m)	Limit (dBuV/m)	Margin (dB)	Remark
1	4824.000	50.37	-4.36	46.01	74.00	-27.99	peak

Note:1.Result (dBuV/m) = Correct Factor (dB/m) + Reading(dBuV).

2.Correction factor (dB/m) = Antenna Factor (dB/m) + Cable loss (dB) – Pre-Amplifier gain (dB).

3.When the peak results are less than average limit, so not need to evaluate the average.



Standard:	FCC Part 15.247	Test Distance:	3m
Test item:	Harmonic	Power:	AC 120V/60Hz
Frequency:	2437MHz	Temp.(°C)/Hum.(%RH):	26(°C)/60%RH
Mode:	Mode 4		
Ant.Polar.:	Horizontal		

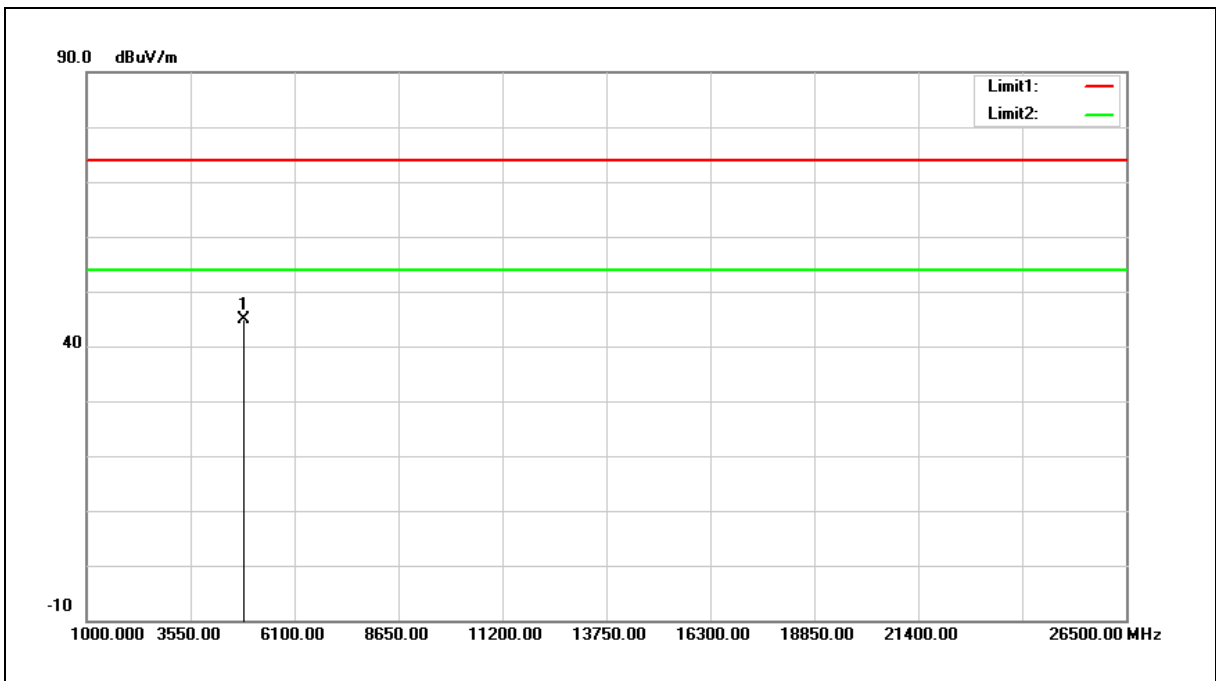

No.	Frequency (MHz)	Reading (dBuV)	Correct Factor (dB/m)	Result (dBuV/m)	Limit (dBuV/m)	Margin (dB)	Remark
1	4874.000	49.18	-4.37	44.81	74.00	-29.19	peak

Note:1.Result (dBuV/m) = Correct Factor (dB/m) + Reading(dBuV).

2.Correction factor (dB/m) = Antenna Factor (dB/m) + Cable loss (dB) – Pre-Amplifier gain (dB).

3.When the peak results are less than average limit, so not need to evaluate the average.



Standard:	FCC Part 15.247	Test Distance:	3m
Test item:	Harmonic	Power:	AC 120V/60Hz
Frequency:	2437MHz	Temp.(°C)/Hum.(%RH):	26(°C)/60%RH
Mode:	Mode 4		
Ant.Polar.:	Vertical		

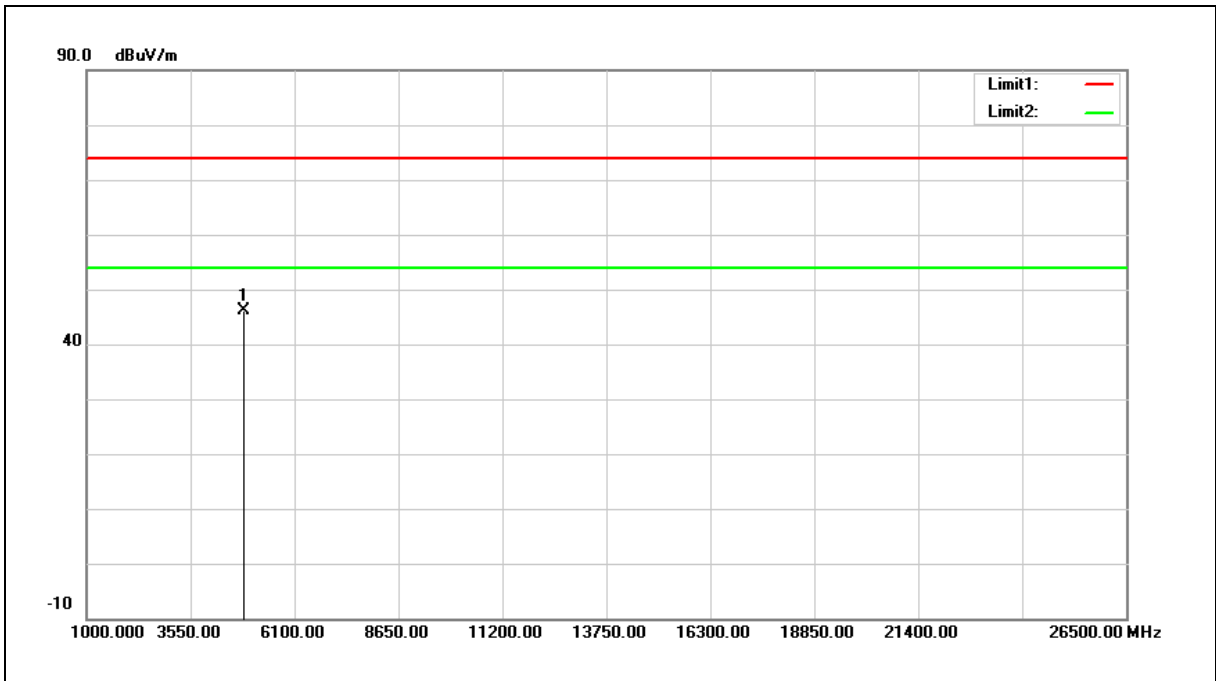

No.	Frequency (MHz)	Reading (dBuV)	Correct Factor (dB/m)	Result (dBuV/m)	Limit (dBuV/m)	Margin (dB)	Remark
1	4874.000	50.46	-4.37	46.09	74.00	-27.91	peak

Note:1.Result (dBuV/m) = Correct Factor (dB/m) + Reading(dBuV).

2.Correction factor (dB/m) = Antenna Factor (dB/m) + Cable loss (dB) – Pre-Amplifier gain (dB).

3.When the peak results are less than average limit, so not need to evaluate the average.



Standard:	FCC Part 15.247	Test Distance:	3m
Test item:	Harmonic	Power:	AC 120V/60Hz
Frequency:	2462MHz	Temp.(°C)/Hum.(%RH):	26(°C)/60%RH
Mode:	Mode 4		
Ant.Polar.:	Horizontal		

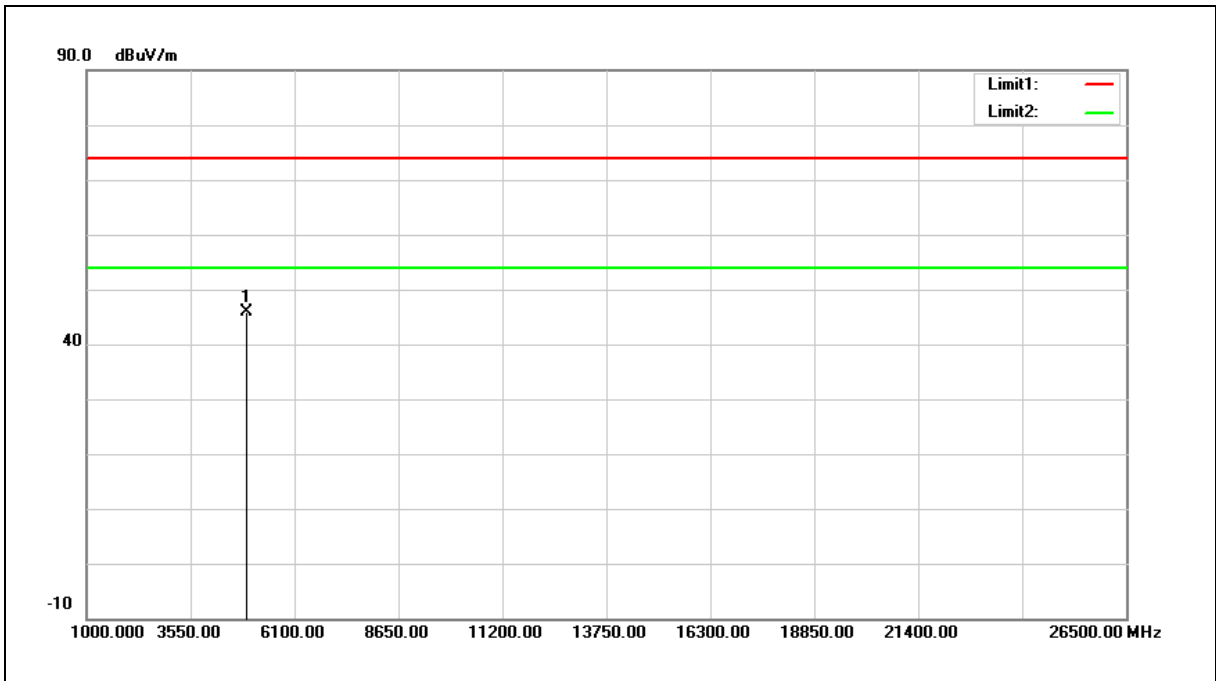

No.	Frequency (MHz)	Reading (dBuV)	Correct Factor (dB/m)	Result (dBuV/m)	Limit (dBuV/m)	Margin (dB)	Remark
1	4924.000	50.27	-4.39	45.88	74.00	-28.12	peak

Note:1.Result (dBuV/m) = Correct Factor (dB/m) + Reading(dBuV).

2.Correction factor (dB/m) = Antenna Factor (dB/m) + Cable loss (dB) – Pre-Amplifier gain (dB).

3.When the peak results are less than average limit, so not need to evaluate the average.



Standard:	FCC Part 15.247	Test Distance:	3m
Test item:	Harmonic	Power:	AC 120V/60Hz
Frequency:	2462MHz	Temp.(°C)/Hum.(%RH):	26(°C)/60%RH
Mode:	Mode 4		
Ant.Polar.:	Vertical		

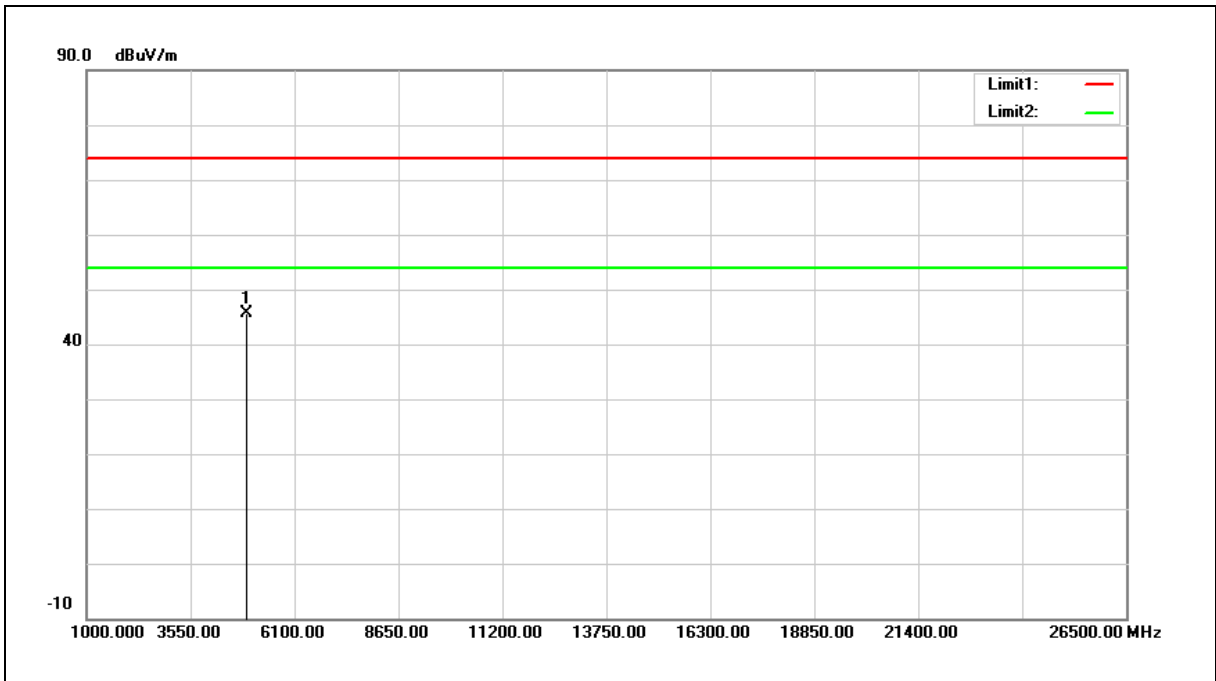

No.	Frequency (MHz)	Reading (dBuV)	Correct Factor (dB/m)	Result (dBuV/m)	Limit (dBuV/m)	Margin (dB)	Remark
1	4924.000	50.03	-4.39	45.64	74.00	-28.36	peak

Note:1.Result (dBuV/m) = Correct Factor (dB/m) + Reading(dBuV).

2.Correction factor (dB/m) = Antenna Factor (dB/m) + Cable loss (dB) – Pre-Amplifier gain (dB).

3.When the peak results are less than average limit, so not need to evaluate the average.



Standard:	FCC Part 15.247	Test Distance:	3m
Test item:	Harmonic	Power:	AC 120V/60Hz
Frequency:	2422MHz	Temp.(°C)/Hum.(%RH):	26(°C)/60%RH
Mode:	Mode 5		
Ant.Polar.:	Horizontal		

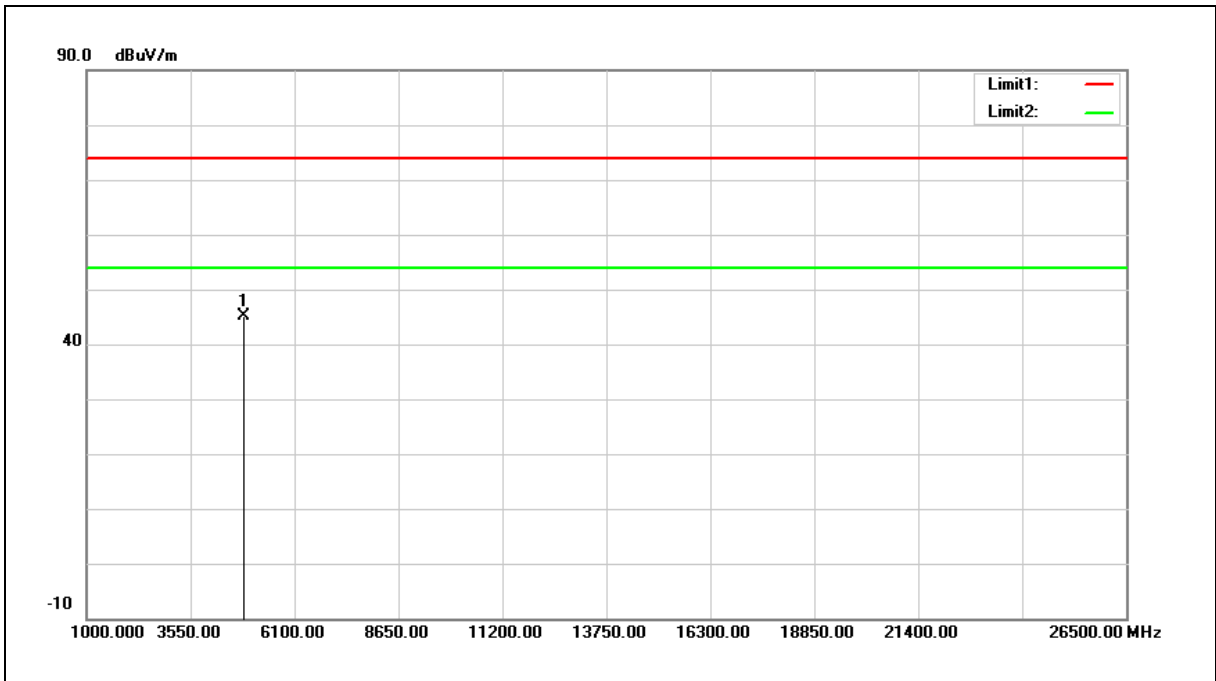

No.	Frequency (MHz)	Reading (dBuV)	Correct Factor (dB/m)	Result (dBuV/m)	Limit (dBuV/m)	Margin (dB)	Remark
1	4844.000	49.46	-4.36	45.10	74.00	-28.90	peak

Note:1.Result (dBuV/m) = Correct Factor (dB/m) + Reading(dBuV).

2.Correction factor (dB/m) = Antenna Factor (dB/m) + Cable loss (dB) – Pre-Amplifier gain (dB).

3.When the peak results are less than average limit, so not need to evaluate the average.



Standard:	FCC Part 15.247	Test Distance:	3m
Test item:	Harmonic	Power:	AC 120V/60Hz
Frequency:	2422MHz	Temp.(°C)/Hum.(%RH):	26(°C)/60%RH
Mode:	Mode 5		
Ant.Polar.:	Vertical		

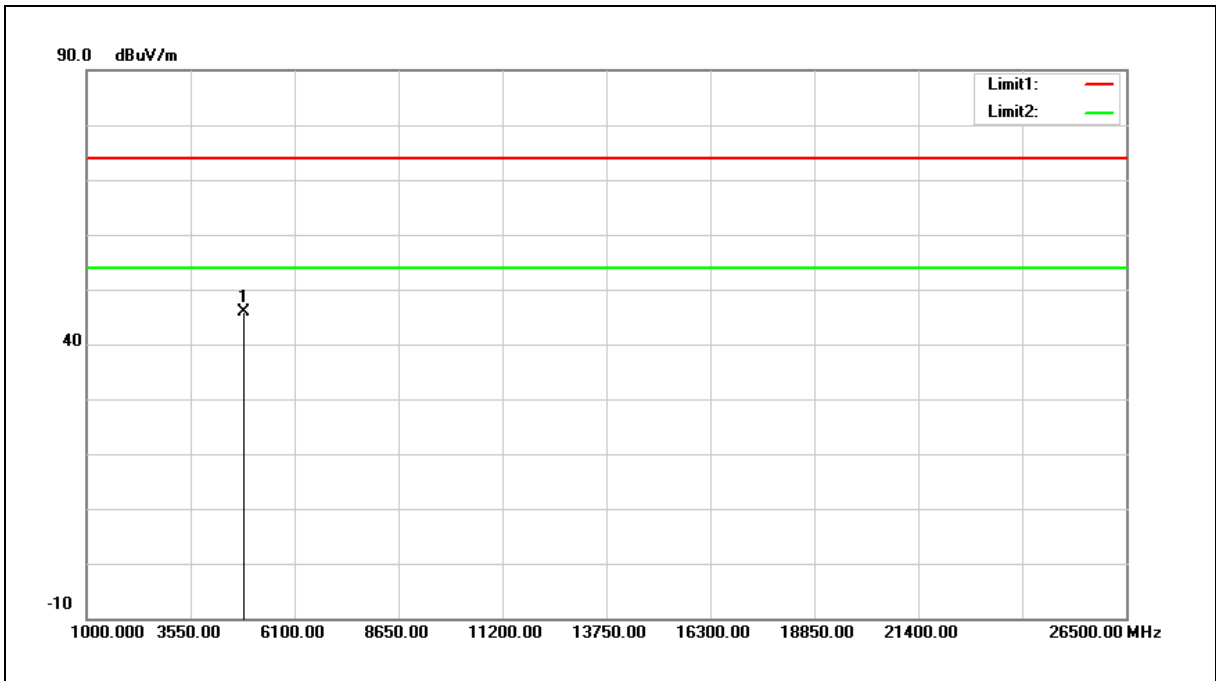

No.	Frequency (MHz)	Reading (dBuV)	Correct Factor (dB/m)	Result (dBuV/m)	Limit (dBuV/m)	Margin (dB)	Remark
1	4844.000	50.29	-4.36	45.93	74.00	-28.07	peak

Note:1.Result (dBuV/m) = Correct Factor (dB/m) + Reading(dBuV).

2.Correction factor (dB/m) = Antenna Factor (dB/m) + Cable loss (dB) – Pre-Amplifier gain (dB).

3.When the peak results are less than average limit, so not need to evaluate the average.



Standard:	FCC Part 15.247	Test Distance:	3m
Test item:	Harmonic	Power:	AC 120V/60Hz
Frequency:	2437MHz	Temp.(°C)/Hum.(%RH):	26(°C)/60%RH
Mode:	Mode 5		
Ant.Polar.:	Horizontal		

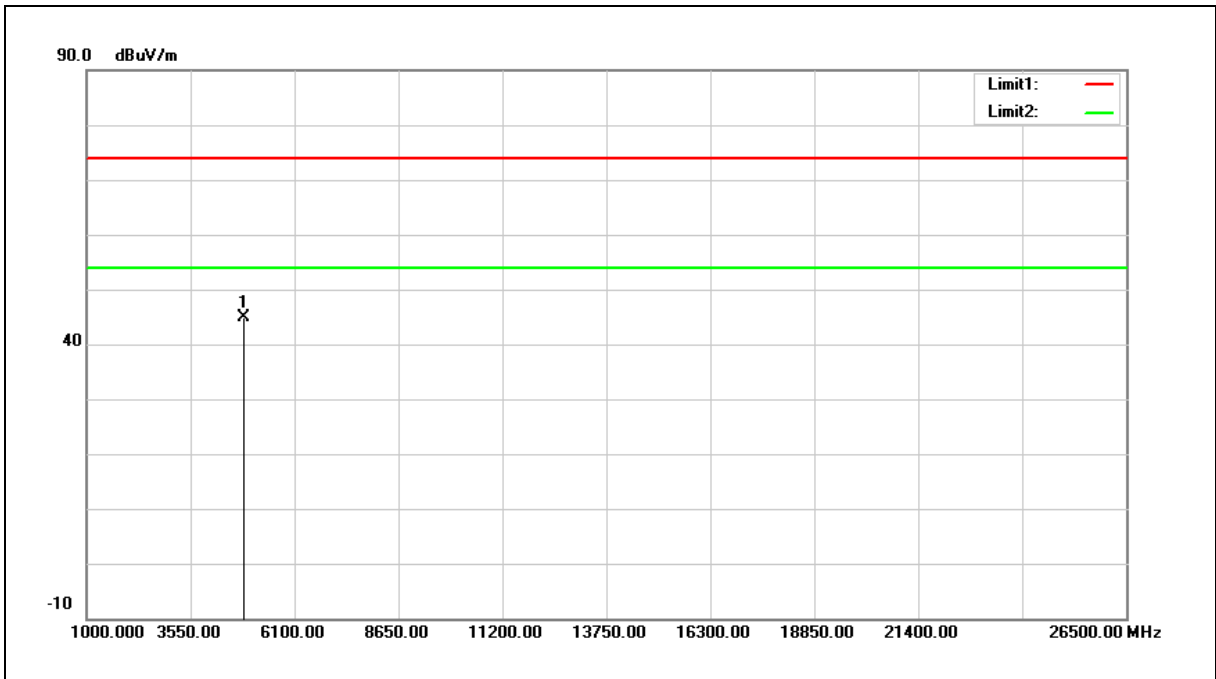

No.	Frequency (MHz)	Reading (dBuV)	Correct Factor (dB/m)	Result (dBuV/m)	Limit (dBuV/m)	Margin (dB)	Remark
1	4874.000	49.22	-4.37	44.85	74.00	-29.15	peak

Note:1.Result (dBuV/m) = Correct Factor (dB/m) + Reading(dBuV).

2.Correction factor (dB/m) = Antenna Factor (dB/m) + Cable loss (dB) – Pre-Amplifier gain (dB).

3.When the peak results are less than average limit, so not need to evaluate the average.



Standard:	FCC Part 15.247	Test Distance:	3m
Test item:	Harmonic	Power:	AC 120V/60Hz
Frequency:	2437MHz	Temp.(°C)/Hum.(%RH):	26(°C)/60%RH
Mode:	Mode 5		
Ant.Polar.:	Vertical		

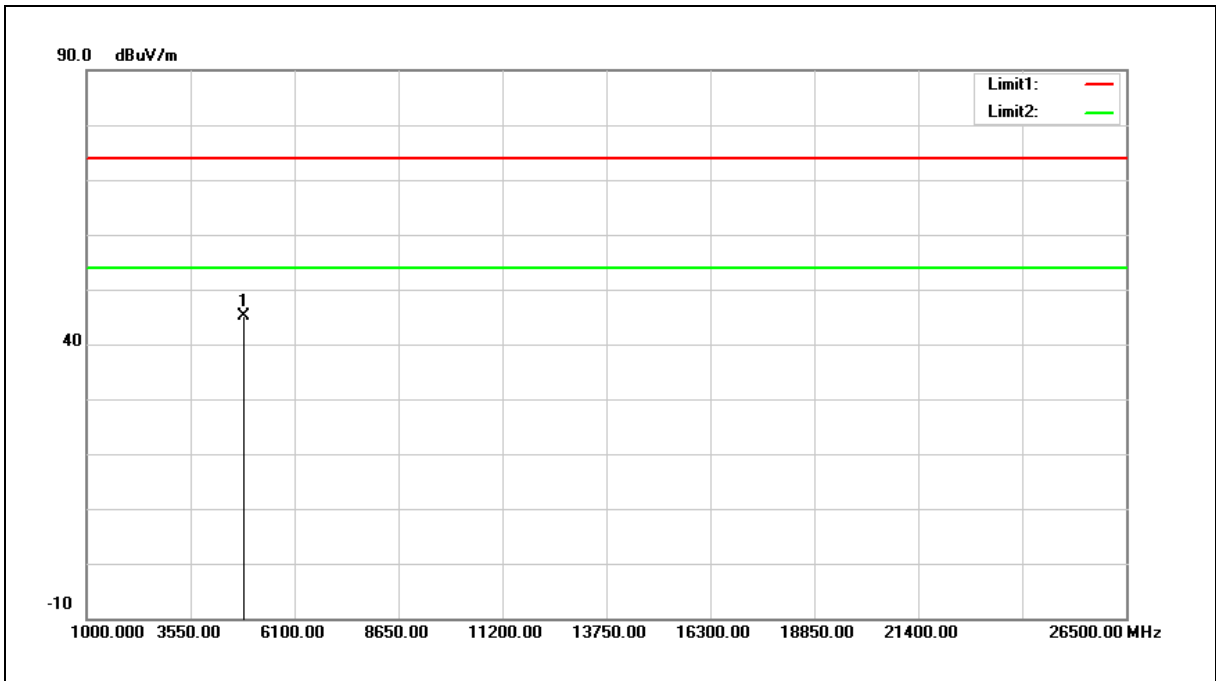

No.	Frequency (MHz)	Reading (dBuV)	Correct Factor (dB/m)	Result (dBuV/m)	Limit (dBuV/m)	Margin (dB)	Remark
1	4874.000	49.58	-4.37	45.21	74.00	-28.79	peak

Note:1.Result (dBuV/m) = Correct Factor (dB/m) + Reading(dBuV).

2.Correction factor (dB/m) = Antenna Factor (dB/m) + Cable loss (dB) – Pre-Amplifier gain (dB).

3.When the peak results are less than average limit, so not need to evaluate the average.



Standard:	FCC Part 15.247	Test Distance:	3m
Test item:	Harmonic	Power:	AC 120V/60Hz
Frequency:	2452MHz	Temp.(°C)/Hum.(%RH):	26(°C)/60%RH
Mode:	Mode 5		
Ant.Polar.:	Horizontal		

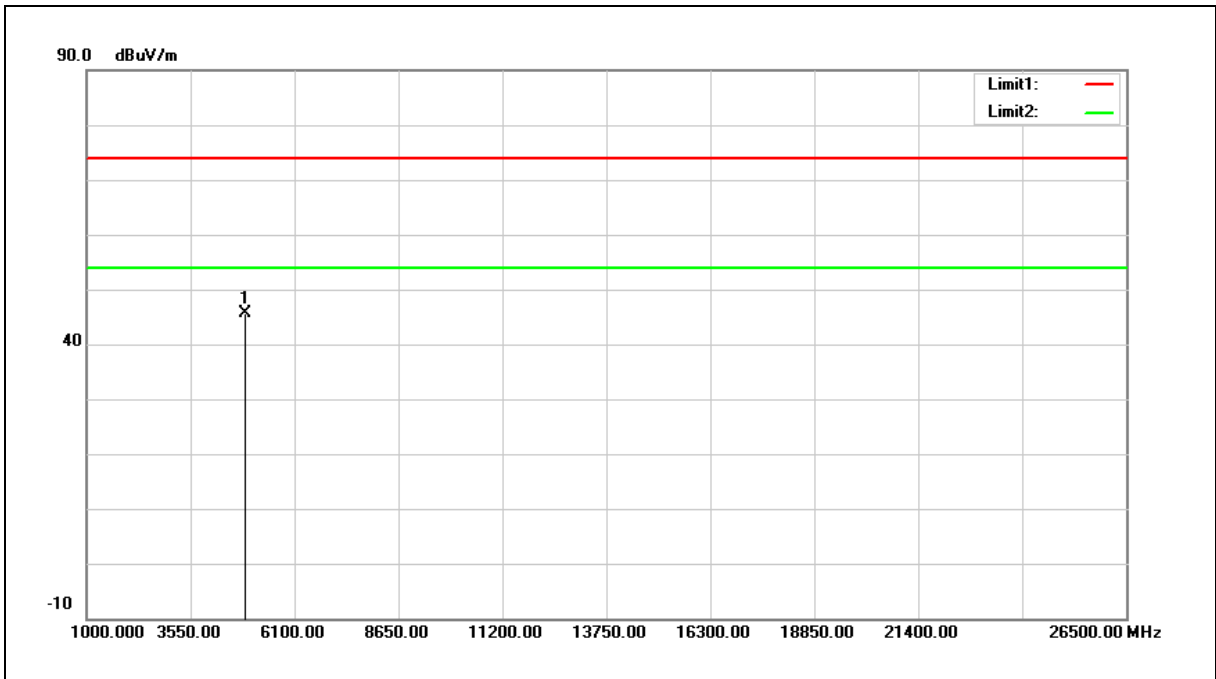

No.	Frequency (MHz)	Reading (dBuV)	Correct Factor (dB/m)	Result (dBuV/m)	Limit (dBuV/m)	Margin (dB)	Remark
1	4904.000	50.08	-4.38	45.70	74.00	-28.30	peak

Note:1.Result (dBuV/m) = Correct Factor (dB/m) + Reading(dBuV).

2.Correction factor (dB/m) = Antenna Factor (dB/m) + Cable loss (dB) – Pre-Amplifier gain (dB).

3.When the peak results are less than average limit, so not need to evaluate the average.



Standard:	FCC Part 15.247	Test Distance:	3m
Test item:	Harmonic	Power:	AC 120V/60Hz
Frequency:	2452MHz	Temp.(°C)/Hum.(%RH):	26(°C)/60%RH
Mode:	Mode 5		
Ant.Polar.:	Vertical		

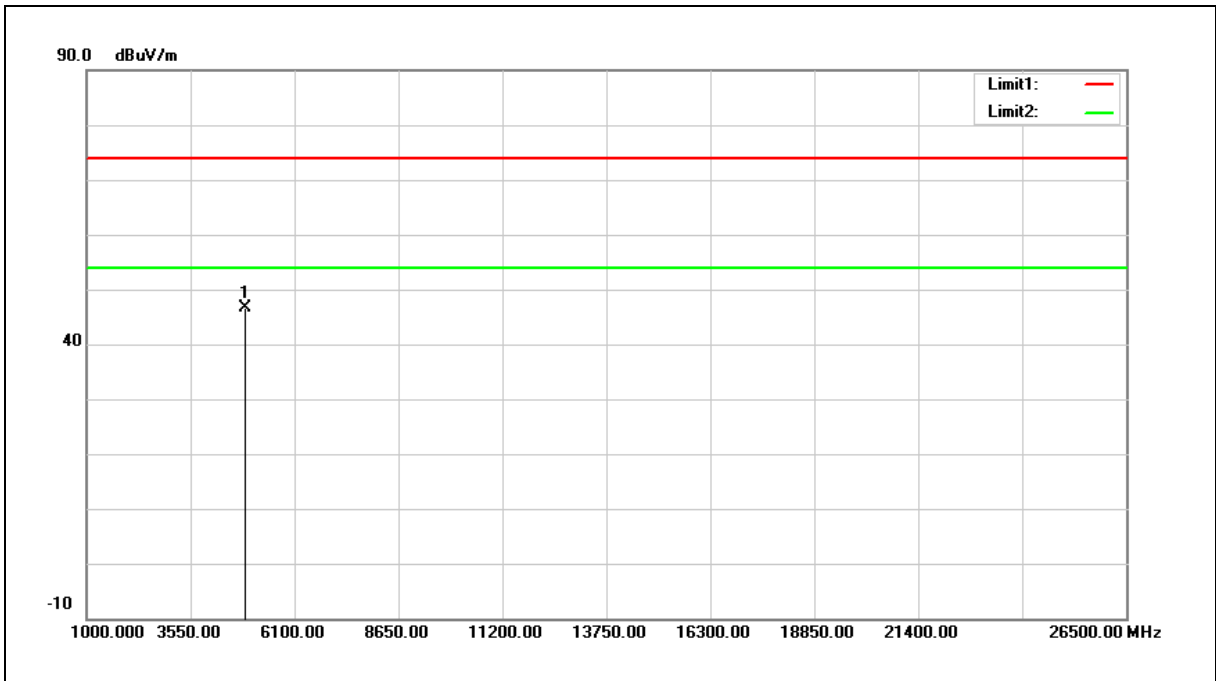

No.	Frequency (MHz)	Reading (dBuV)	Correct Factor (dB/m)	Result (dBuV/m)	Limit (dBuV/m)	Margin (dB)	Remark
1	4904.000	50.90	-4.38	46.52	74.00	-27.48	peak

Note:1.Result (dBuV/m) = Correct Factor (dB/m) + Reading(dBuV).

2.Correction factor (dB/m) = Antenna Factor (dB/m) + Cable loss (dB) – Pre-Amplifier gain (dB).

3.When the peak results are less than average limit, so not need to evaluate the average.

Band Edge

Standard:	FCC Part 15.247	Test Distance:	3m
Test item:	Band edge	Power:	AC 120V/60Hz
Frequency:	2412MHz	Temp.(°C)/Hum.(%RH):	26(°C)/60%RH
Mode:	Mode 2		
Ant.Polar.:	Horizontal		

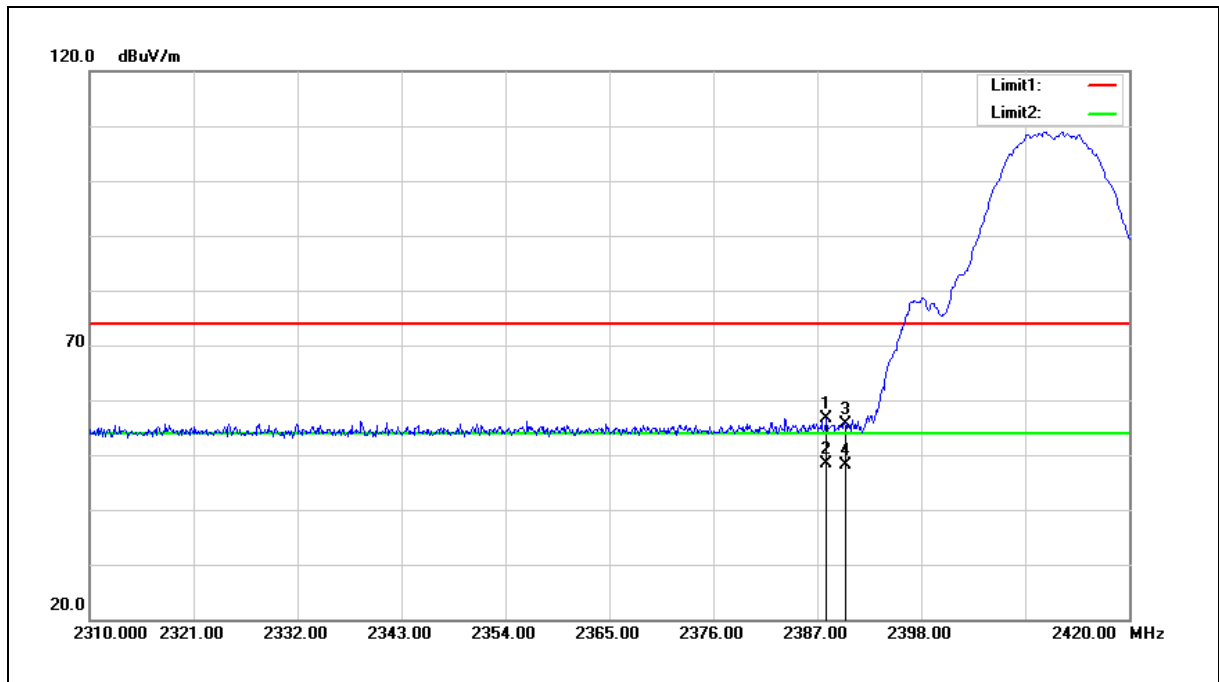

No.	Frequency (MHz)	Reading (dBuV)	Correct Factor (dB/m)	Result (dBuV/m)	Limit (dBuV/m)	Margin (dB)	Remark
1	2387.990	66.16	-9.64	56.52	74.00	-17.48	peak
2	2387.990	58.08	-9.64	48.44	54.00	-5.56	AVG
3	2390.000	65.24	-9.62	55.62	74.00	-18.38	peak
4	2390.000	57.79	-9.62	48.17	54.00	-5.83	AVG

Note:1.Result (dBuV/m) = Correct Factor (dB/m) + Reading(dBuV).

2.Correction factor (dB/m) = Antenna Factor (dB/m) + Cable loss (dB) – Pre-Amplifier gain (dB).

3.When the peak results are less than average limit, so not need to evaluate the average.



Standard:	FCC Part 15.247	Test Distance:	3m
Test item:	Band edge	Power:	AC 120V/60Hz
Frequency:	2412MHz	Temp.(°C)/Hum.(%RH):	26(°C)/60%RH
Mode:	Mode 2		
Ant.Polar.:	Vertical		

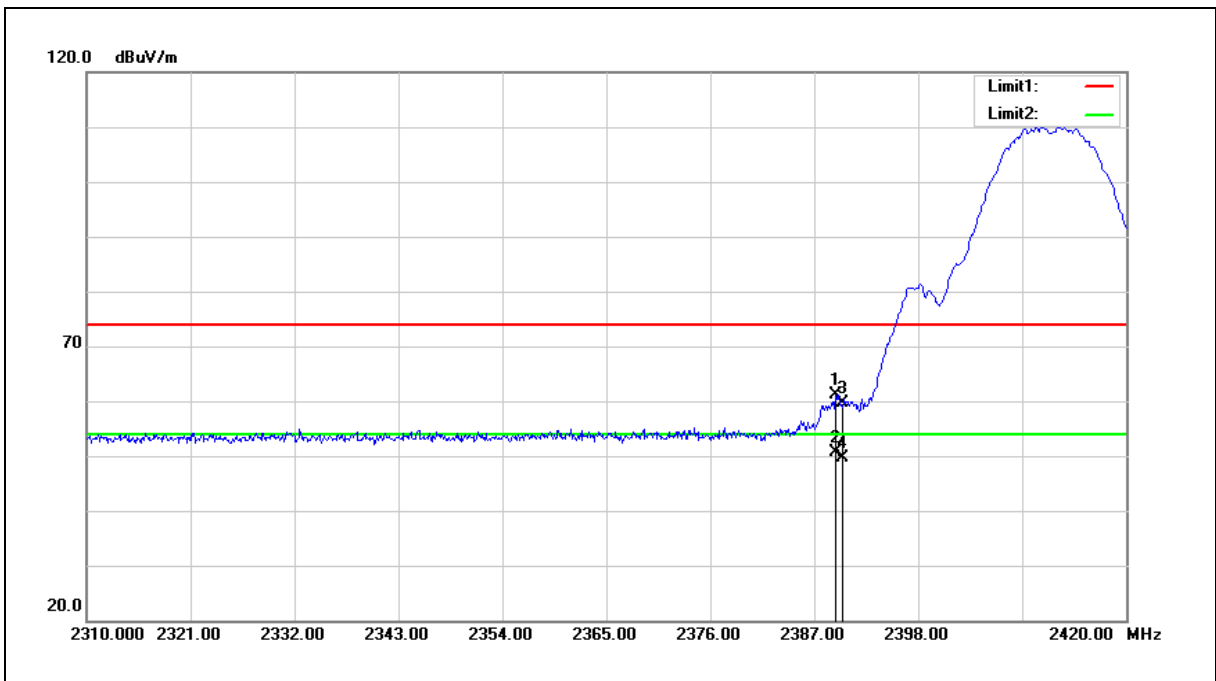

No.	Frequency (MHz)	Reading (dBuV)	Correct Factor (dB/m)	Result (dBuV/m)	Limit (dBuV/m)	Margin (dB)	Remark
1	2389.200	70.65	-9.63	61.02	74.00	-12.98	peak
2	2389.200	60.35	-9.63	50.72	54.00	-3.28	AVG
3	2390.000	69.20	-9.62	59.58	74.00	-14.42	peak
4	2390.000	59.22	-9.62	49.60	54.00	-4.40	AVG

Note:1.Result (dBuV/m) = Correct Factor (dB/m) + Reading(dBuV).

2.Correction factor (dB/m) = Antenna Factor (dB/m) + Cable loss (dB) – Pre-Amplifier gain (dB).

3.When the peak results are less than average limit, so not need to evaluate the average.



Standard:	FCC Part 15.247	Test Distance:	3m
Test item:	Band edge	Power:	AC 120V/60Hz
Frequency:	2462MHz	Temp.(°C)/Hum.(%RH):	26(°C)/60%RH
Mode:	Mode 2		
Ant.Polar.:	Horizontal		

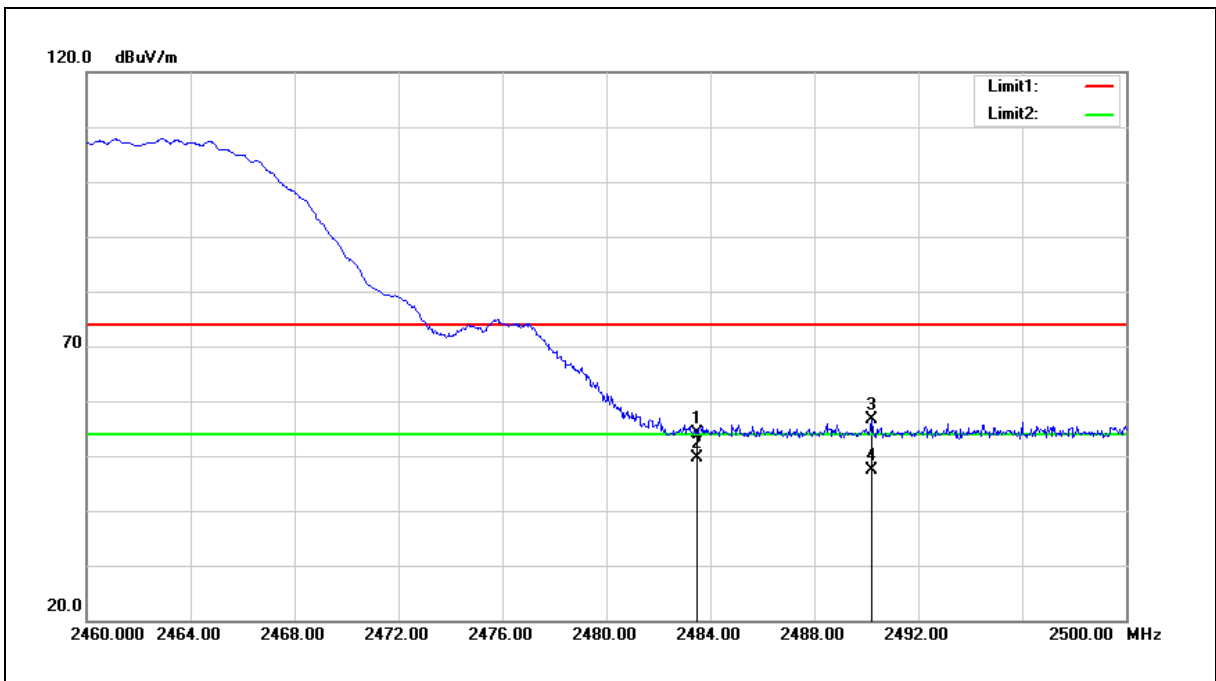

No.	Frequency (MHz)	Reading (dBuV)	Correct Factor (dB/m)	Result (dBuV/m)	Limit (dBuV/m)	Margin (dB)	Remark
1	2483.500	63.27	-9.20	54.07	74.00	-19.93	peak
2	2483.500	58.83	-9.20	49.63	54.00	-4.37	AVG
3	2490.200	65.92	-9.17	56.75	74.00	-17.25	peak
4	2490.200	56.60	-9.17	47.43	54.00	-6.57	AVG

Note:1.Result (dBuV/m) = Correct Factor (dB/m) + Reading(dBuV).

2.Correction factor (dB/m) = Antenna Factor (dB/m) + Cable loss (dB) – Pre-Amplifier gain (dB).

3.When the peak results are less than average limit, so not need to evaluate the average.



Standard:	FCC Part 15.247	Test Distance:	3m
Test item:	Band edge	Power:	AC 120V/60Hz
Frequency:	2462MHz	Temp.(°C)/Hum.(%RH):	26(°C)/60%RH
Mode:	Mode 2		
Ant.Polar.:	Vertical		

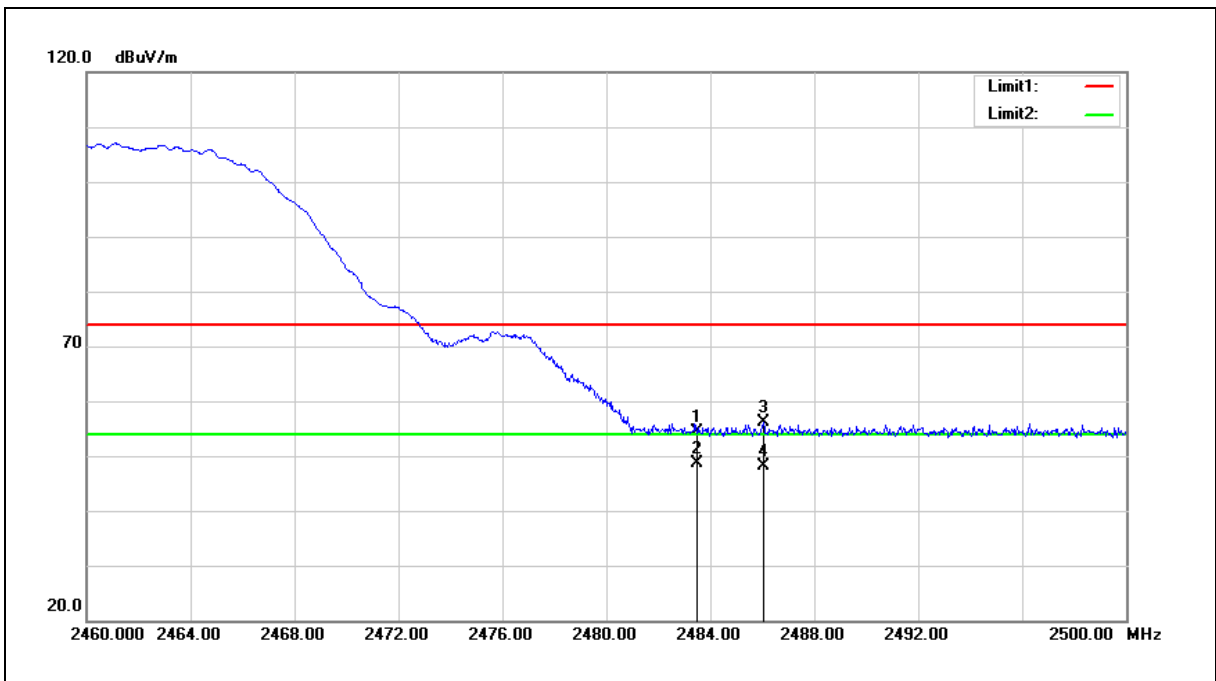

No.	Frequency (MHz)	Reading (dBuV)	Correct Factor (dB/m)	Result (dBuV/m)	Limit (dBuV/m)	Margin (dB)	Remark
1	2483.500	63.55	-9.20	54.35	74.00	-19.65	peak
2	2483.500	57.72	-9.20	48.52	54.00	-5.48	AVG
3	2486.040	65.31	-9.19	56.12	74.00	-17.88	peak
4	2486.040	57.29	-9.19	48.10	54.00	-5.90	AVG

- Note:1.Result (dBuV/m) = Correct Factor (dB/m) + Reading(dBuV).
 2.Correction factor (dB/m) = Antenna Factor (dB/m) + Cable loss (dB) – Pre-Amplifier gain (dB).
 3.When the peak results are less than average limit, so not need to evaluate the average.



Standard:	FCC Part 15.247	Test Distance:	3m
Test item:	Band edge	Power:	AC 120V/60Hz
Frequency:	2412MHz	Temp.(°C)/Hum.(%RH):	26(°C)/60%RH
Mode:	Mode 3		
Ant.Polar.:	Horizontal		

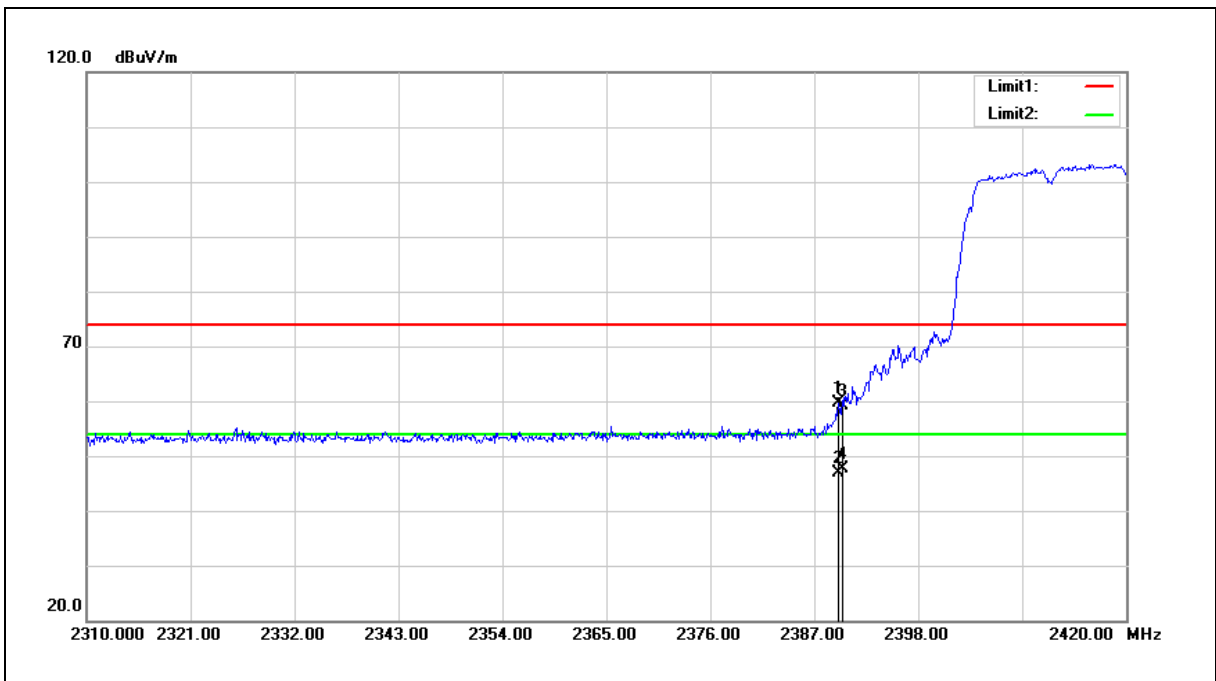

No.	Frequency (MHz)	Reading (dBuV)	Correct Factor (dB/m)	Result (dBuV/m)	Limit (dBuV/m)	Margin (dB)	Remark
1	2389.530	69.23	-9.63	59.60	74.00	-14.40	peak
2	2389.530	56.40	-9.63	46.77	54.00	-7.23	AVG
3	2390.000	68.81	-9.62	59.19	74.00	-14.81	peak
4	2390.000	57.19	-9.62	47.57	54.00	-6.43	AVG

Note:1.Result (dBuV/m) = Correct Factor (dB/m) + Reading(dBuV).

2.Correction factor (dB/m) = Antenna Factor (dB/m) + Cable loss (dB) – Pre-Amplifier gain (dB).

3.When the peak results are less than average limit, so not need to evaluate the average.



Standard:	FCC Part 15.247	Test Distance:	3m
Test item:	Band edge	Power:	AC 120V/60Hz
Frequency:	2412MHz	Temp.(°C)/Hum.(%RH):	26(°C)/60%RH
Mode:	Mode 3		
Ant.Polar.:	Vertical		

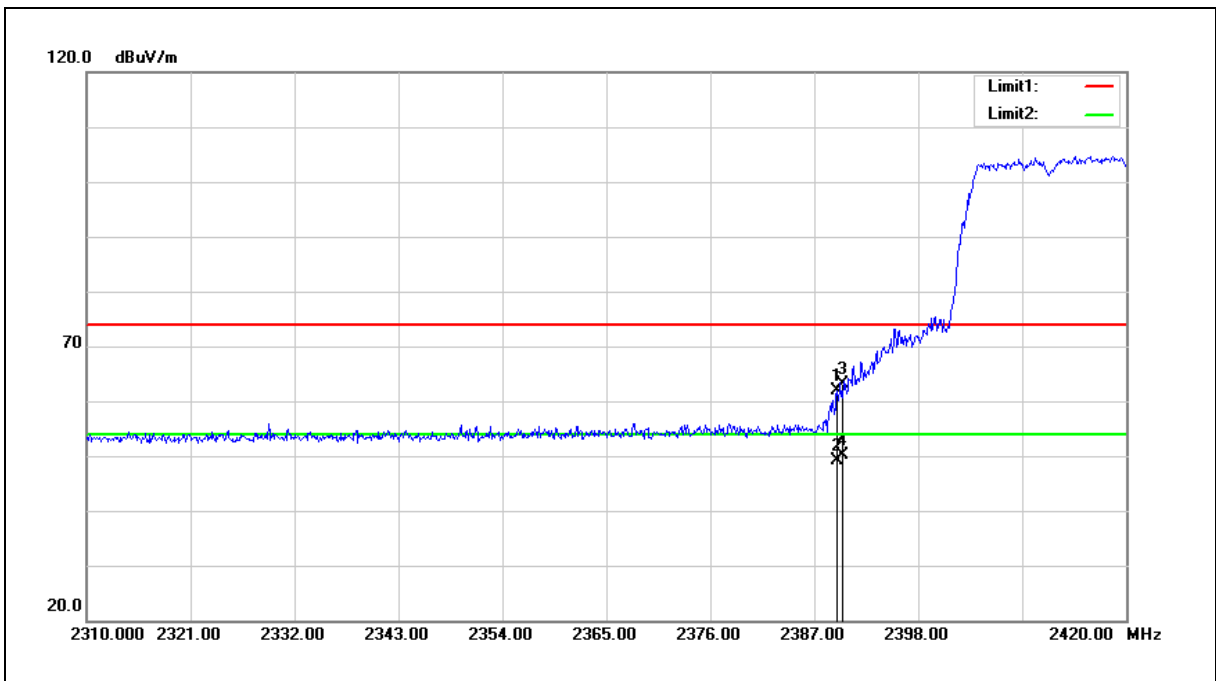

No.	Frequency (MHz)	Reading (dBuV)	Correct Factor (dB/m)	Result (dBuV/m)	Limit (dBuV/m)	Margin (dB)	Remark
1	2389.420	71.39	-9.63	61.76	74.00	-12.24	peak
2	2389.420	58.76	-9.63	49.13	54.00	-4.87	AVG
3	2390.000	72.72	-9.62	63.10	74.00	-10.90	peak
4	2390.000	59.77	-9.62	50.15	54.00	-3.85	AVG

Note:1.Result (dBuV/m) = Correct Factor (dB/m) + Reading(dBuV).

2.Correction factor (dB/m) = Antenna Factor (dB/m) + Cable loss (dB) – Pre-Amplifier gain (dB).

3.When the peak results are less than average limit, so not need to evaluate the average.



Standard:	FCC Part 15.247	Test Distance:	3m
Test item:	Band edge	Power:	AC 120V/60Hz
Frequency:	2462MHz	Temp.(°C)/Hum.(%RH):	26(°C)/60%RH
Mode:	Mode 3		
Ant.Polar.:	Horizontal		

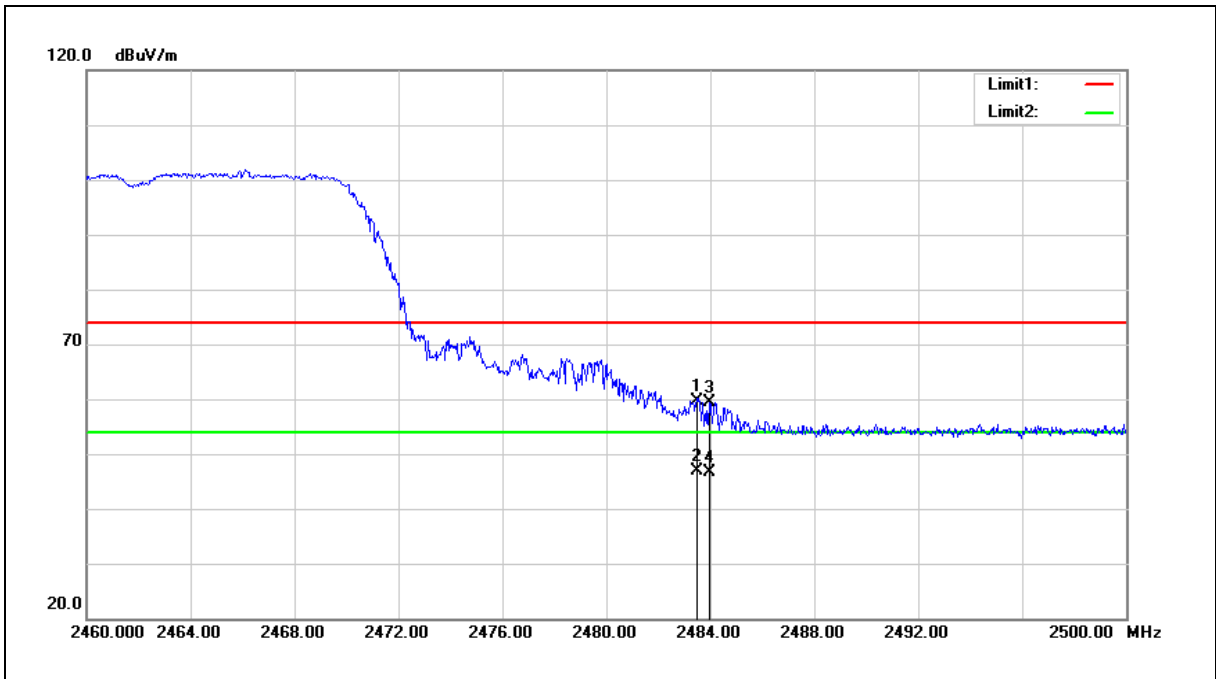

No.	Frequency (MHz)	Reading (dBuV)	Correct Factor (dB/m)	Result (dBuV/m)	Limit (dBuV/m)	Margin (dB)	Remark
1	2483.500	68.71	-9.20	59.51	74.00	-14.49	peak
2	2483.500	56.14	-9.20	46.94	54.00	-7.06	AVG
3	2483.960	68.62	-9.20	59.42	74.00	-14.58	peak
4	2483.960	55.75	-9.20	46.55	54.00	-7.45	AVG

Note:1.Result (dBuV/m) = Correct Factor (dB/m) + Reading(dBuV).

2.Correction factor (dB/m) = Antenna Factor (dB/m) + Cable loss (dB) – Pre-Amplifier gain (dB).

3.When the peak results are less than average limit, so not need to evaluate the average.



Standard:	FCC Part 15.247	Test Distance:	3m
Test item:	Band edge	Power:	AC 120V/60Hz
Frequency:	2462MHz	Temp.(°C)/Hum.(%RH):	26(°C)/60%RH
Mode:	Mode 3		
Ant.Polar.:	Vertical		

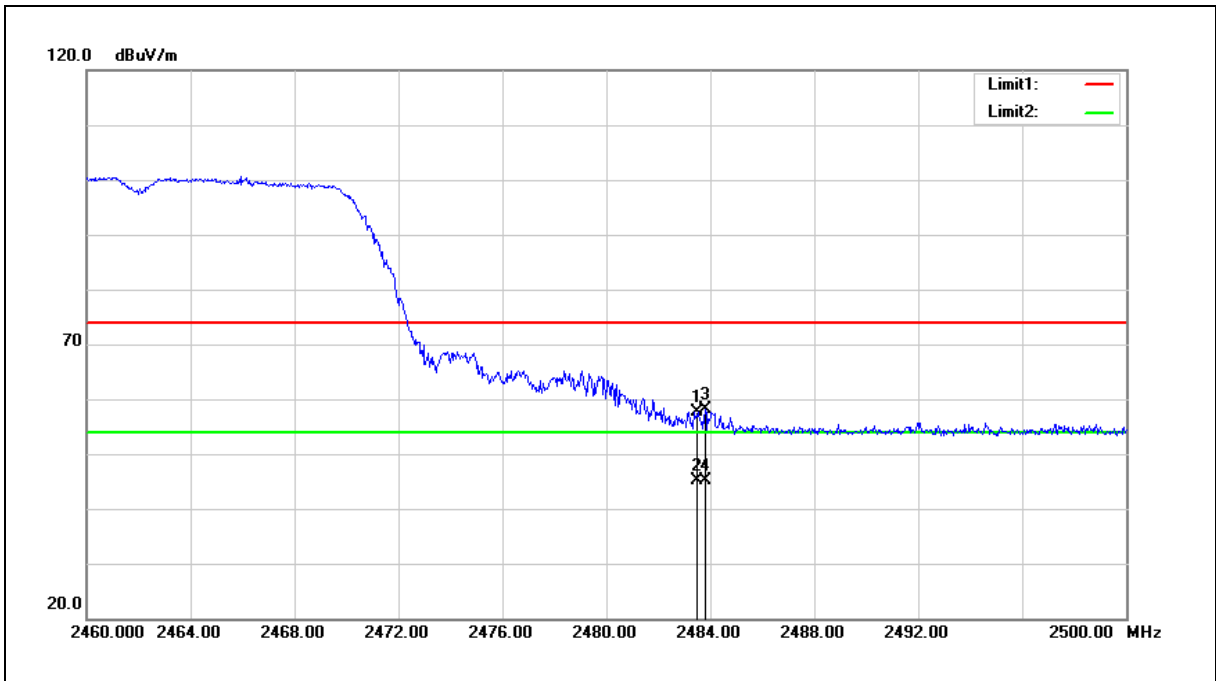

No.	Frequency (MHz)	Reading (dBuV)	Correct Factor (dB/m)	Result (dBuV/m)	Limit (dBuV/m)	Margin (dB)	Remark
1	2483.500	66.92	-9.20	57.72	74.00	-16.28	peak
2	2483.500	54.41	-9.20	45.21	54.00	-8.79	AVG
3	2483.800	67.43	-9.20	58.23	74.00	-15.77	peak
4	2483.800	54.24	-9.20	45.04	54.00	-8.96	AVG

Note:1.Result (dBuV/m) = Correct Factor (dB/m) + Reading(dBuV).

2.Correction factor (dB/m) = Antenna Factor (dB/m) + Cable loss (dB) – Pre-Amplifier gain (dB).

3.When the peak results are less than average limit, so not need to evaluate the average.



Standard:	FCC Part 15.247	Test Distance:	3m
Test item:	Band edge	Power:	AC 120V/60Hz
Frequency:	2412MHz	Temp.(°C)/Hum.(%RH):	26(°C)/60%RH
Mode:	Mode 4		
Ant.Polar.:	Horizontal		

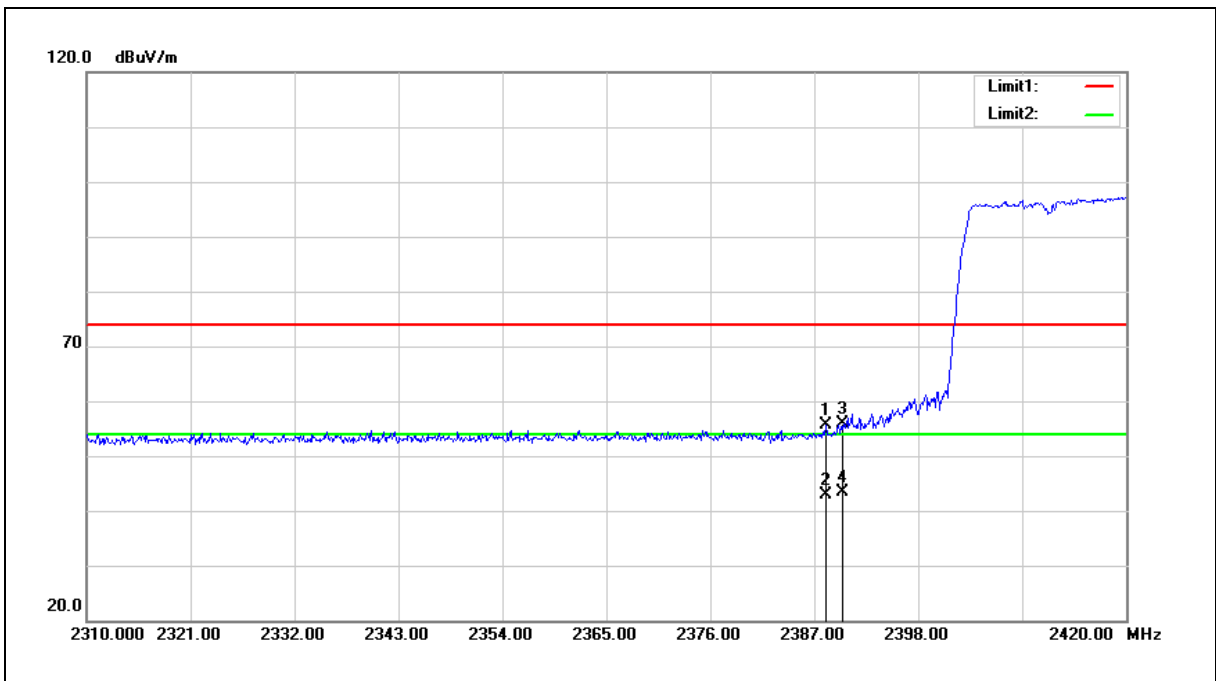

No.	Frequency (MHz)	Reading (dBuV)	Correct Factor (dB/m)	Result (dBuV/m)	Limit (dBuV/m)	Margin (dB)	Remark
1	2388.210	65.28	-9.64	55.64	74.00	-18.36	peak
2	2388.210	52.43	-9.64	42.79	54.00	-11.21	AVG
3	2390.000	65.38	-9.62	55.76	74.00	-18.24	peak
4	2390.000	53.07	-9.62	43.45	54.00	-10.55	AVG

Note:1.Result (dBuV/m) = Correct Factor (dB/m) + Reading(dBuV).

2.Correction factor (dB/m) = Antenna Factor (dB/m) + Cable loss (dB) – Pre-Amplifier gain (dB).

3.When the peak results are less than average limit, so not need to evaluate the average.



Standard:	FCC Part 15.247	Test Distance:	3m
Test item:	Band edge	Power:	AC 120V/60Hz
Frequency:	2412MHz	Temp.(°C)/Hum.(%RH):	26(°C)/60%RH
Mode:	Mode 4		
Ant.Polar.:	Vertical		

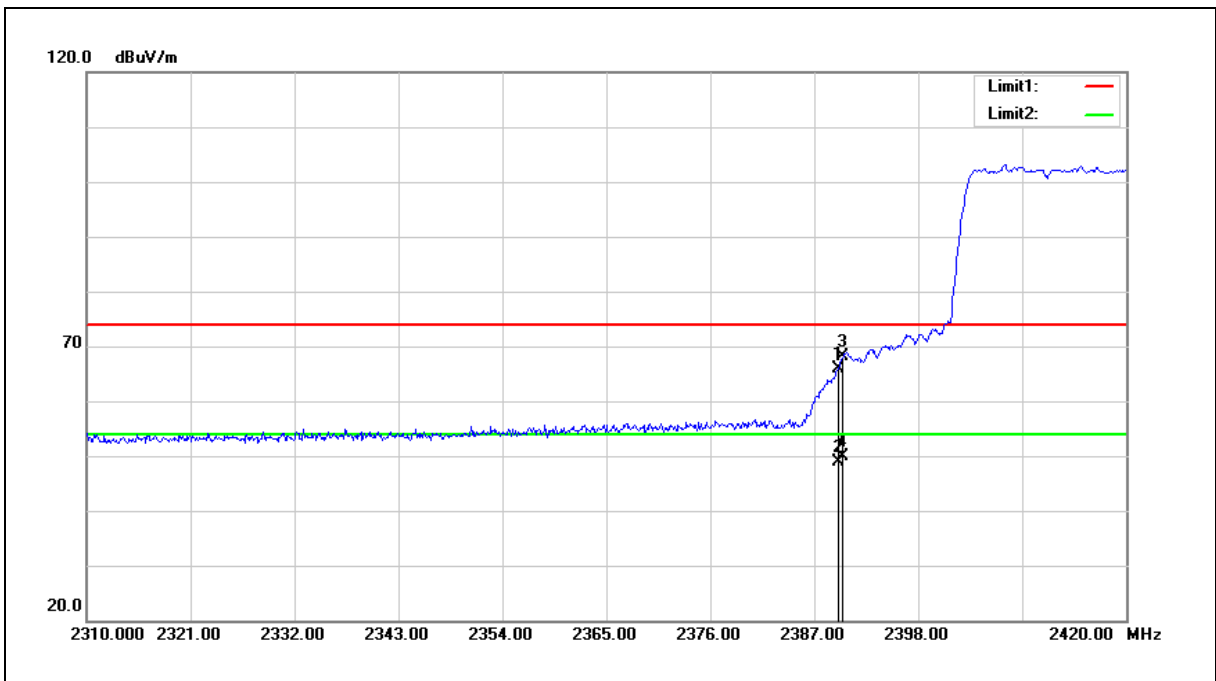

No.	Frequency (MHz)	Reading (dBuV)	Correct Factor (dB/m)	Result (dBuV/m)	Limit (dBuV/m)	Margin (dB)	Remark
1	2389.530	75.46	-9.63	65.83	74.00	-8.17	peak
2	2389.530	58.59	-9.63	48.96	54.00	-5.04	AVG
3	2390.000	77.67	-9.62	68.05	74.00	-5.95	peak
4	2390.000	59.54	-9.62	49.92	54.00	-4.08	AVG

Note:1.Result (dBuV/m) = Correct Factor (dB/m) + Reading(dBuV).

2.Correction factor (dB/m) = Antenna Factor (dB/m) + Cable loss (dB) – Pre-Amplifier gain (dB).

3.When the peak results are less than average limit, so not need to evaluate the average.



Standard:	FCC Part 15.247	Test Distance:	3m
Test item:	Band edge	Power:	AC 120V/60Hz
Frequency:	2462MHz	Temp.(°C)/Hum.(%RH):	26(°C)/60%RH
Mode:	Mode 4		
Ant.Polar.:	Horizontal		

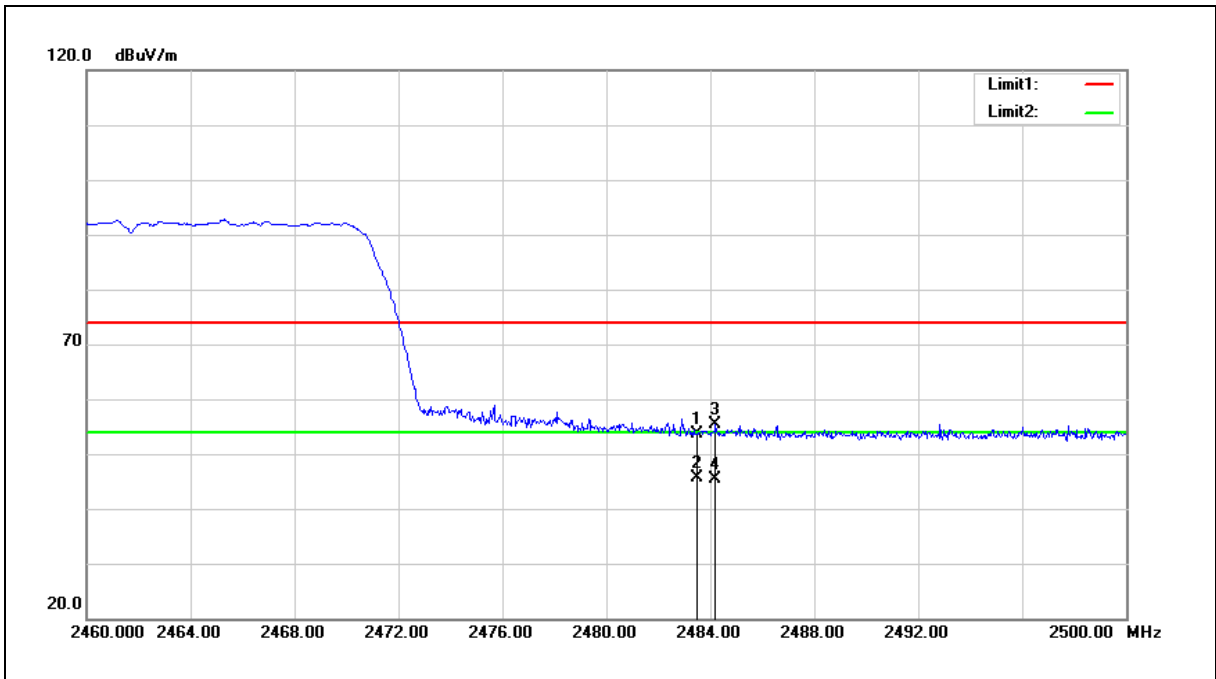

No.	Frequency (MHz)	Reading (dBuV)	Correct Factor (dB/m)	Result (dBuV/m)	Limit (dBuV/m)	Margin (dB)	Remark
1	2483.500	62.81	-9.20	53.61	74.00	-20.39	peak
2	2483.500	54.87	-9.20	45.67	54.00	-8.33	AVG
3	2484.200	64.65	-9.20	55.45	74.00	-18.55	peak
4	2484.200	54.52	-9.20	45.32	54.00	-8.68	AVG

- Note:1.Result (dBuV/m) = Correct Factor (dB/m) + Reading(dBuV).
- 2.Correction factor (dB/m) = Antenna Factor (dB/m) + Cable loss (dB) – Pre-Amplifier gain (dB).
- 3.When the peak results are less than average limit, so not need to evaluate the average.



Standard:	FCC Part 15.247	Test Distance:	3m
Test item:	Band edge	Power:	AC 120V/60Hz
Frequency:	2462MHz	Temp.(°C)/Hum.(%RH):	26(°C)/60%RH
Mode:	Mode 4		
Ant.Polar.:	Vertical		

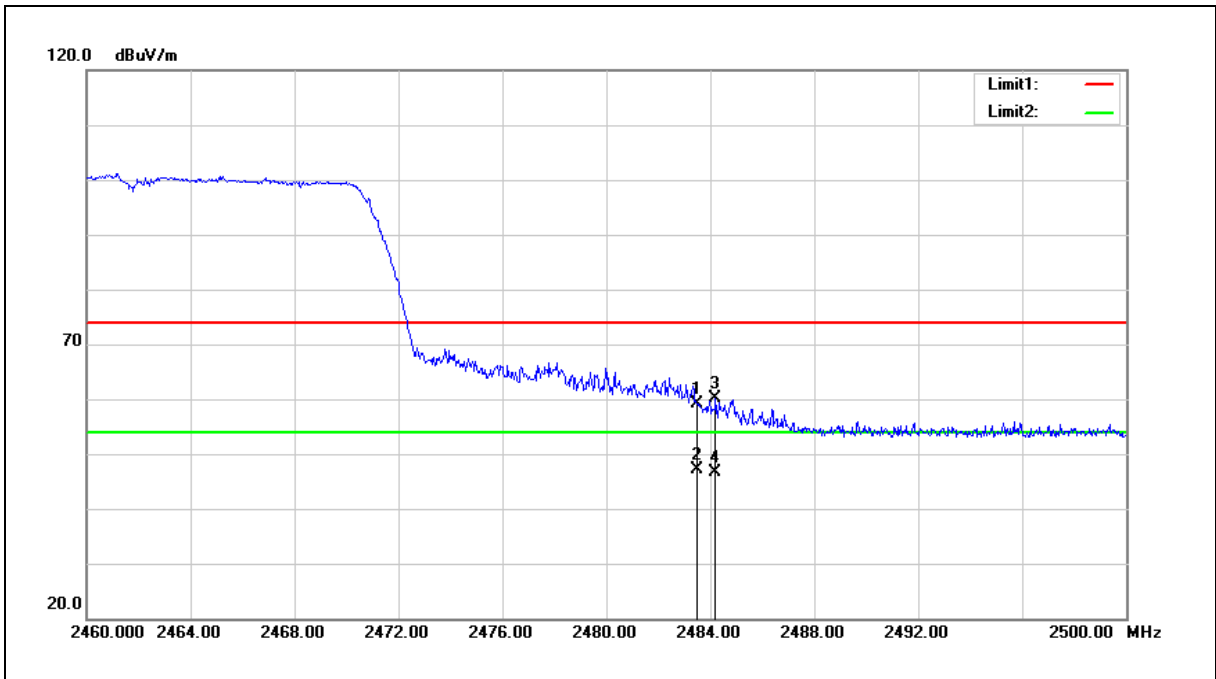

No.	Frequency (MHz)	Reading (dBuV)	Correct Factor (dB/m)	Result (dBuV/m)	Limit (dBuV/m)	Margin (dB)	Remark
1	2483.500	68.44	-9.20	59.24	74.00	-14.76	peak
2	2483.500	56.25	-9.20	47.05	54.00	-6.95	AVG
3	2484.200	69.28	-9.20	60.08	74.00	-13.92	peak
4	2484.200	55.82	-9.20	46.62	54.00	-7.38	AVG

- Note:1.Result (dBuV/m) = Correct Factor (dB/m) + Reading(dBuV).
- 2.Correction factor (dB/m) = Antenna Factor (dB/m) + Cable loss (dB) – Pre-Amplifier gain (dB).
- 3.When the peak results are less than average limit, so not need to evaluate the average.



Standard:	FCC Part 15.247	Test Distance:	3m
Test item:	Band edge	Power:	AC 120V/60Hz
Frequency:	2422MHz	Temp.(°C)/Hum.(%RH):	26(°C)/60%RH
Mode:	Mode 5		
Ant.Polar.:	Horizontal		

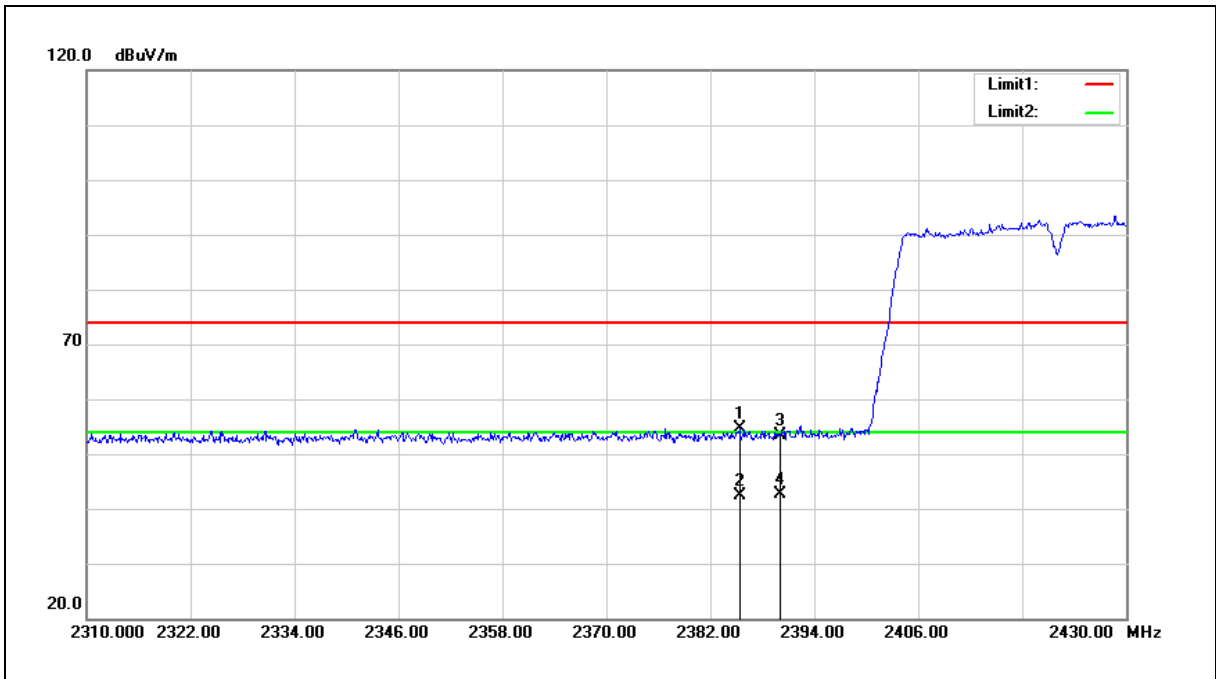

No.	Frequency (MHz)	Reading (dBuV)	Correct Factor (dB/m)	Result (dBuV/m)	Limit (dBuV/m)	Margin (dB)	Remark
1	2385.360	64.28	-9.65	54.63	74.00	-19.37	peak
2	2385.360	52.04	-9.65	42.39	54.00	-11.61	AVG
3	2390.000	63.04	-9.62	53.42	74.00	-20.58	peak
4	2390.000	52.25	-9.62	42.63	54.00	-11.37	AVG

Note:1.Result (dBuV/m) = Correct Factor (dB/m) + Reading(dBuV).

2.Correction factor (dB/m) = Antenna Factor (dB/m) + Cable loss (dB) – Pre-Amplifier gain (dB).

3.When the peak results are less than average limit, so not need to evaluate the average.



Standard:	FCC Part 15.247	Test Distance:	3m
Test item:	Band edge	Power:	AC 120V/60Hz
Frequency:	2422MHz	Temp.(°C)/Hum.(%RH):	26(°C)/60%RH
Mode:	Mode 5		
Ant.Polar.:	Vertical		

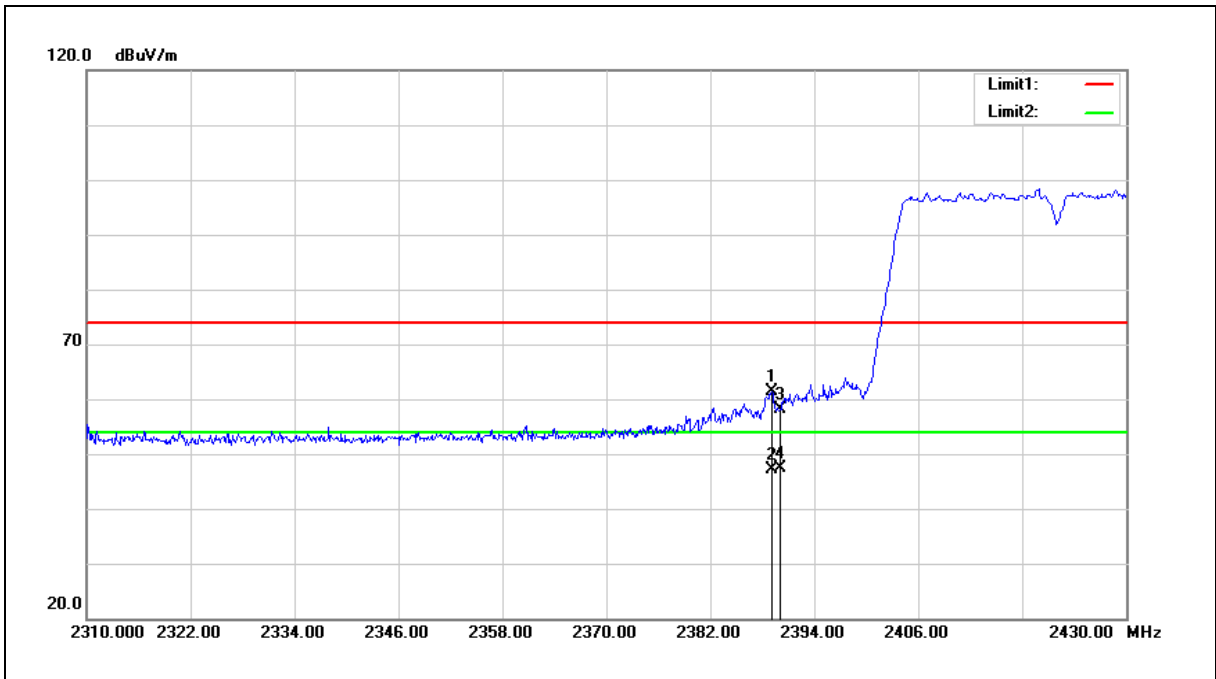

No.	Frequency (MHz)	Reading (dBuV)	Correct Factor (dB/m)	Result (dBuV/m)	Limit (dBuV/m)	Margin (dB)	Remark
1	2389.080	70.97	-9.63	61.34	74.00	-12.66	peak
2	2389.080	56.75	-9.63	47.12	54.00	-6.88	AVG
3	2390.000	67.86	-9.62	58.24	74.00	-15.76	peak
4	2390.000	57.11	-9.62	47.49	54.00	-6.51	AVG

Note:1.Result (dBuV/m) = Correct Factor (dB/m) + Reading(dBuV).

2.Correction factor (dB/m) = Antenna Factor (dB/m) + Cable loss (dB) – Pre-Amplifier gain (dB).

3.When the peak results are less than average limit, so not need to evaluate the average.



Standard:	FCC Part 15.247	Test Distance:	3m
Test item:	Band edge	Power:	AC 120V/60Hz
Frequency:	2452MHz	Temp.(°C)/Hum.(%RH):	26(°C)/60%RH
Mode:	Mode 5		
Ant.Polar.:	Horizontal		

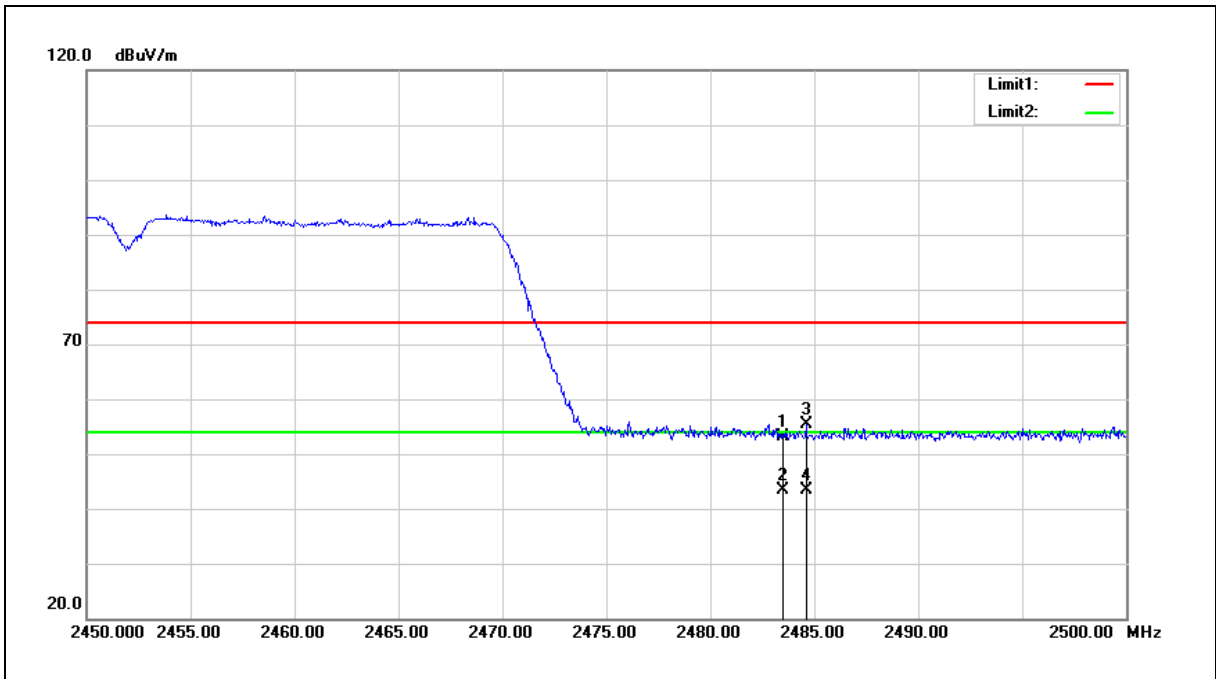

No.	Frequency (MHz)	Reading (dBuV)	Correct Factor (dB/m)	Result (dBuV/m)	Limit (dBuV/m)	Margin (dB)	Remark
1	2483.500	62.38	-9.20	53.18	74.00	-20.82	peak
2	2483.500	52.61	-9.20	43.41	54.00	-10.59	AVG
3	2484.600	64.62	-9.20	55.42	74.00	-18.58	peak
4	2484.600	52.68	-9.20	43.48	54.00	-10.52	AVG

Note:1.Result (dBuV/m) = Correct Factor (dB/m) + Reading(dBuV).

2.Correction factor (dB/m) = Antenna Factor (dB/m) + Cable loss (dB) – Pre-Amplifier gain (dB).

3.When the peak results are less than average limit, so not need to evaluate the average.



Standard:	FCC Part 15.247	Test Distance:	3m
Test item:	Band edge	Power:	AC 120V/60Hz
Frequency:	2452MHz	Temp.(°C)/Hum.(%RH):	26(°C)/60%RH
Mode:	Mode 5		
Ant.Polar.:	Vertical		

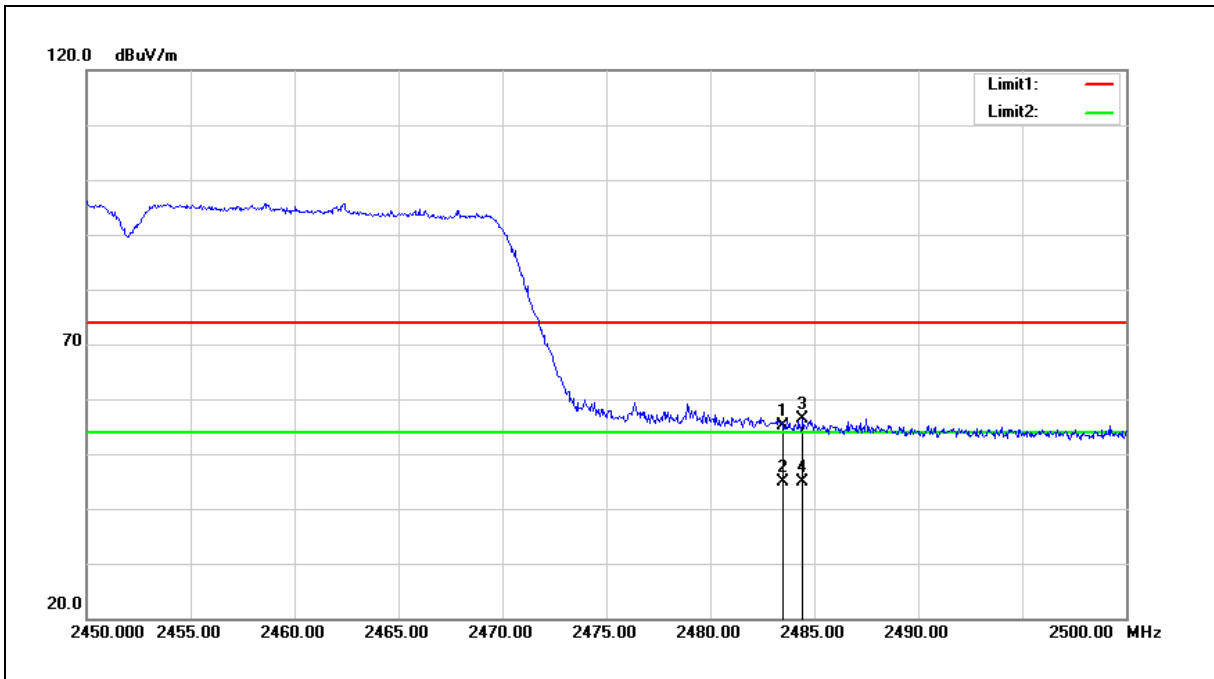

No.	Frequency (MHz)	Reading (dBuV)	Correct Factor (dB/m)	Result (dBuV/m)	Limit (dBuV/m)	Margin (dB)	Remark
1	2483.500	64.33	-9.20	55.13	74.00	-18.87	peak
2	2483.500	54.14	-9.20	44.94	54.00	-9.06	AVG
3	2484.450	65.67	-9.20	56.47	74.00	-17.53	peak
4	2484.450	54.15	-9.20	44.95	54.00	-9.05	AVG

Note:1.Result (dBuV/m) = Correct Factor (dB/m) + Reading(dBuV).

2.Correction factor (dB/m) = Antenna Factor (dB/m) + Cable loss (dB) – Pre-Amplifier gain (dB).

3.When the peak results are less than average limit, so not need to evaluate the average.