

RF Test Report

Applicant : Superior Communications DBA PureGear
Product Type : PURECAM
Trade Name : PureGear
Model Number : 07614PG
Test Specification : FCC 47 CFR PART 15 SUBPART C
ANSI C63.10:2013
Receive Date : Jun. 27, 2018
Test Period : Jun. 29 ~ Jul. 30, 2018
Issue Date : Aug. 02, 2018

Issue by

A Test Lab Techno Corp.
No. 140-1, Changan Street, Bade District,
Taoyuan City 33465, Taiwan (R.O.C)
Tel : +886-3-2710188 / Fax : +886-3-2710190



Taiwan Accreditation Foundation accreditation number: 1330

Test Firm MRA designation number: TW0010

Note: This report shall not be reproduced except in full, without the written approval of A Test Lab Techno Corp. This document may be altered or revised by A Test Lab Techno Corp. personnel only, and shall be noted in the revision section of the document. The client should not use it to claim product endorsement by TAF, or any government agencies. The test results in the report only apply to the tested sample.



Revision History

Rev.	Issue Date	Revisions	Revised By
00	Aug. 02, 2018	Initial Issue	Janet Chao



Verification of Compliance

Issued Date: Aug. 02, 2018

Applicant : Superior Communications DBA PureGear
Product Type : PURECAM
Trade Name : PureGear
Model Number : 07614PG
FCC ID : 2AIIIF-07614PG
EUT Rated Voltage : DC 5V
Test Voltage : 120 Vac / 60 Hz
Applicable Standard : FCC 47 CFR PART 15 SUBPART C
ANSI C63.10:2013
Test Result : Complied

Performing Lab. : A Test Lab Techno Corp.
No. 140-1, Changan Street, Bade District,
Taoyuan City 33465, Taiwan (R.O.C)
Tel : +886-3-2710188 / Fax : +886-3-2710190
Taiwan Accreditation Foundation accreditation number: 1330
<http://www.atl-lab.com.tw/e-index.htm>



A Test Lab Techno Corp. tested the above equipment in accordance with the requirements set forth in the above standards. All indications of Pass/Fail in this report are opinions expressed by A Test Lab Techno Corp. based on interpretations and/or observations of test results. Measurement Uncertainties were not taken into account and are published for informational purposes only. The test results show that the equipment tested is capable of demonstrating compliance with the requirements as documented in this report.

Approved By : Jet Lu Reviewed By : Eric Ou Yang
(Manager) (Jet Lu) (Testing Engineer) (Eric Ou Yang)



TABLE OF CONTENTS

1	General Information	5
	1.1. Summary of Test Result.....	5
	1.2. Measurement Uncertainty.....	6
2	EUT Description	7
3	Test Methodology.....	8
	3.1. Mode of Operation.....	8
	3.2. EUT Exercise Software.....	8
	3.3. Configuration of Test System Details	9
	3.4. Test Instruments	11
	3.5. Test Site Environment.....	12
4	Measurement Procedure.....	13
	4.1. Maximum Conducted Output Power Measurement.....	13
	4.2. AC Power Line Conducted Emission Measurement.....	14
	4.3. Transmitter Radiated Emissions Measurement.....	16
	4.4. Antenna Measurement	19
5	Test Results.....	20
	Annex A. AC Power Line Conducted Emission Test Results	20
	Annex B. Conducted Test Results	22
	Annex C. Transmitter Radiated Emissions Test Results	23



1 General Information

1.1. Summary of Test Result

FCC Standard	Item	Result	Remark
15.207	AC Power Conducted Emission	PASS	-----
15.203	Antenna Requirement	PASS	-----
15.247(b)(1)	Max. Output Power	PASS	-----
15.247(d)	Transmitter Radiated Emissions	PASS	-----
15.247(a)(1)	20dB RF Bandwidth	N/A	Note
15.247(a)(1)	Carrier Frequency Separation	N/A	Note
15.247(a)(1)(iii)	Number of Hopping	N/A	Note
15.247(a)(1)(iii)	Time of Occupancy (Dwell Time)	N/A	Note
15.247(d)	Out of Band Conducted Spurious Emission	N/A	Note

The test results of this report relate only to the tested sample(s) identified in this report. Manufacturer or whom it may concern should recognize the pass or fail of the test result.

Note: The product adds a heat sink and a car charger. The layout of module and the appearance of the product are partly changed. Besides, the location of the antenna, antenna gain for BT/LE/WLAN, the module of camera and the software version are changed to do Class II Permissive Change, so it is only needed to be tested for Maximum Conducted Output Power Measurement and Transmitter Radiated Emissions.

Standard	Description
CFR47, Part 15, Subpart C §15.247	Intentional Radiators
ANSI C63. 10: 2013	American National Standard of Procedures for Compliance Testing of Unlicensed Wireless Devices
KDB 558074 D01 v04	GUIDANCE FOR PERFORMING COMPLIANCE MEASUREMENTS ON DIGITAL TRANSMISSION SYSTEMS (DTS) OPERATING UNDER SECTION 15.247



1.2. Measurement Uncertainty

Test Item	Frequency Range	Uncertainty (dB)
Conducted Emission	9kHz ~ 150kHz	2.7
	150kHz ~ 30MHz	2.7
Radiated Emission	9kHz ~ 30MHz	1.7
	30MHz ~ 1000MHz	5.7
	1000MHz ~ 18000MHz	5.5
	18000MHz ~ 26500MHz	4.8
	26500MHz ~ 40000MHz	4.8
Conducted Output Power	+0.27 dB / -0.28 dB	
RF Bandwidth	4.96%	
Power Spectral Density	+0.71 dB / -0.77 dB	



2 EUT Description

Applicant	Superior Communications DBA PureGear 5082 4th Street Irwindale California USA, Irwindale, California, 91706, United States		
Manufacturer	Shenzhen Auto Range Tech Co., Limited 5/F, Bldg. A1, Atomic Power Industrial Park, Fuming, Guanlan, Shenzhen, Guangdong. P. R. China.		
Product	PURECAM		
Trade Name	PureGear		
Model Number	07614PG		
FCC ID	2AIIIF-07614PG		
Class II Permissive Change	<ol style="list-style-type: none"> 1. change the BT/LE/WLAN/GPS antenna's location 2. change the BT/LE/WLAN/GPS antenna's gain to 2.3dBi (the original is 2dBi, and the antenna type remains the same) 3. add a heat sink, and the appearance changes accordingly 4. change the camera module and the module's layout partly changed 5. add an accessory: car charger 6. software version changes to V8.0_000_20180808. 		
IMEI No.	35316305670667		
Frequency Range	2402 ~ 2480 MHz		
Modulation Type	GFSK for 1Mbps		
	$\pi/4$ -DQPSK for 2Mbps		
	8DPSK for 3Mbps		
Operate Temp. Range	-10 ~ +70 °C		
Antenna information	Type	Max. Gain (dBi)	
	Internal Antenna	2.3	
RF Output Power (Conducted)	GFSK for 1Mbps	0.00514	W
	$\pi/4$ -DQPSK for 2Mbps	0.00453	W
	8DPSK for 3Mbps	0.00493	W

EUT Modify Description :

<p>Modify Description:</p> <p>Class II Permissive change for FCC ID:2AIIIF-07614PG, compare to the original EUT, the changes are as below:</p> <ol style="list-style-type: none"> 1. change the BT/LE/WLAN/GPS antenna's location 2. change the BT/LE/WLAN/GPS antenna's gain to 2.3dBi (the original is 2dBi, and the antenna type remains the same) 3. add a heat sink, and the appearance changes accordingly 4. change the camera module and the module's layout partly changed 5. add an accessory: car charger 6. software version changes to V8.0_000_20180808. <p>Above changes do not affect the EUT's RF function.</p> <p>Verify power is smaller than the original case power. Therefore, the product is only needed to be tested for Maximum Conducted Output Power Measurement and Transmitter Radiated Emissions Measurement</p> <p>Original Report : 1801FR14 Modify: 1807FR12</p>

3 Test Methodology

3.1. Mode of Operation

Decision of Test ATL has verified the construction and function in typical operation. All the test modes were carried out with the EUT in normal operation, which was shown in this test report and defined as:

Pre-Test Mode
Mode 1: Transmit mode
Mode 2: GFSK Continuous TX mode
Mode 3: $\pi/4$ -DQPSK Continuous TX mode
Mode 4: 8DPSK Continuous TX mode

After verification, all tests were carried out with the worst case test modes as shown below except radiated spurious emission below 1GHz and power line conducted emissions below 30MHz, which worst case was in TX mode only. By preliminary testing and verifying three axis (X, Y and Z) position of EUT transmitted status, it was found that "X axis" position was the worst, then the final test was executed the worst condition and test data were recorded in this report.

Final-Test Mode
Mode 1: Transmit mode
Mode 2: GFSK Continuous TX mode
Mode 4: 8DPSK Continuous TX mode

Description of Test Modes

Preliminary tests were performed in different modulation to find the worst case. The modulation has shown the worst-case in section 4.5. Investigation has been done on all the possible configurations for searching the worst cases.

3.2. EUT Exercise Software

1	Setup the EUT shown on "Configuration of Test System Details."
2	Turn on the power of all equipment.
3	Turn on TX function
4	EUT run test program.

Measurement Software	
1	EZ-EMC Ver. ATL-03A1-1
2	EZ-EMC Ver ATL-ITC-3A1-1

3.3. Configuration of Test System Details

Conducted Emissions

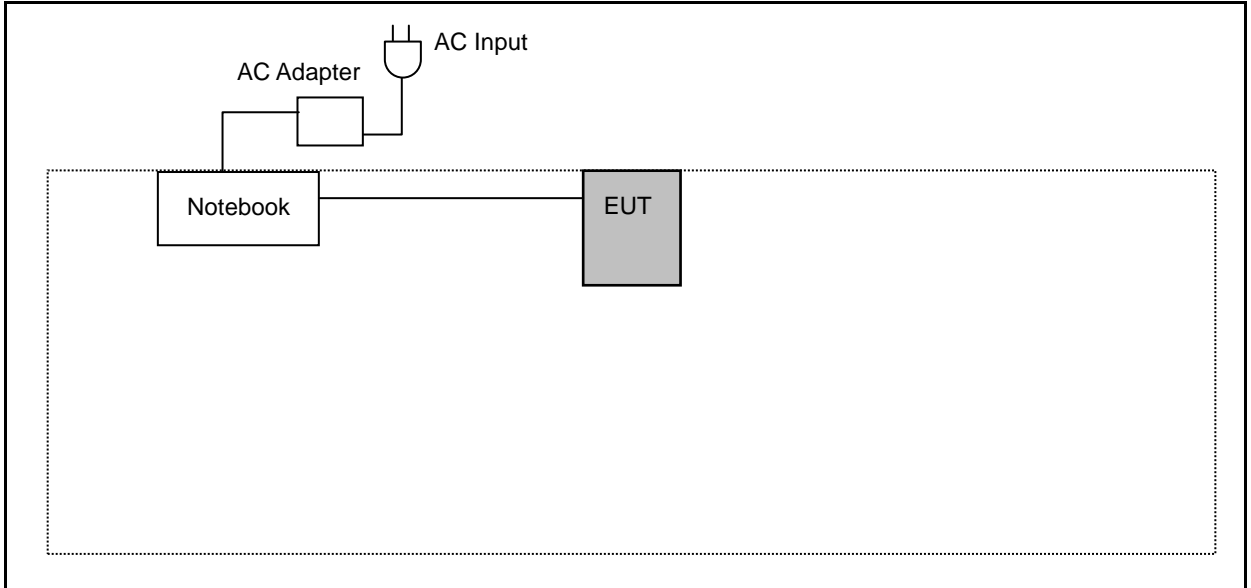

Radiated Emissions_ EUT connects to the NB with USB cable

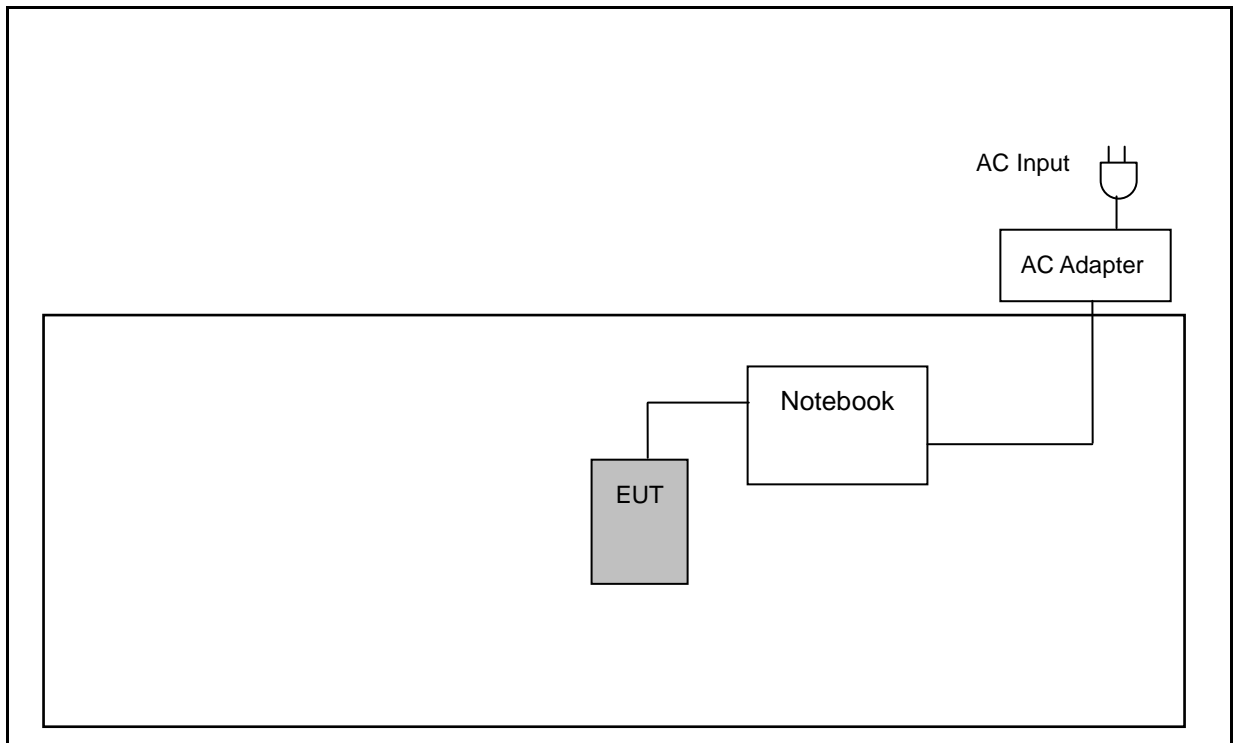

Radiated Emission_ EUT connects to the DC Power Source with the car charger

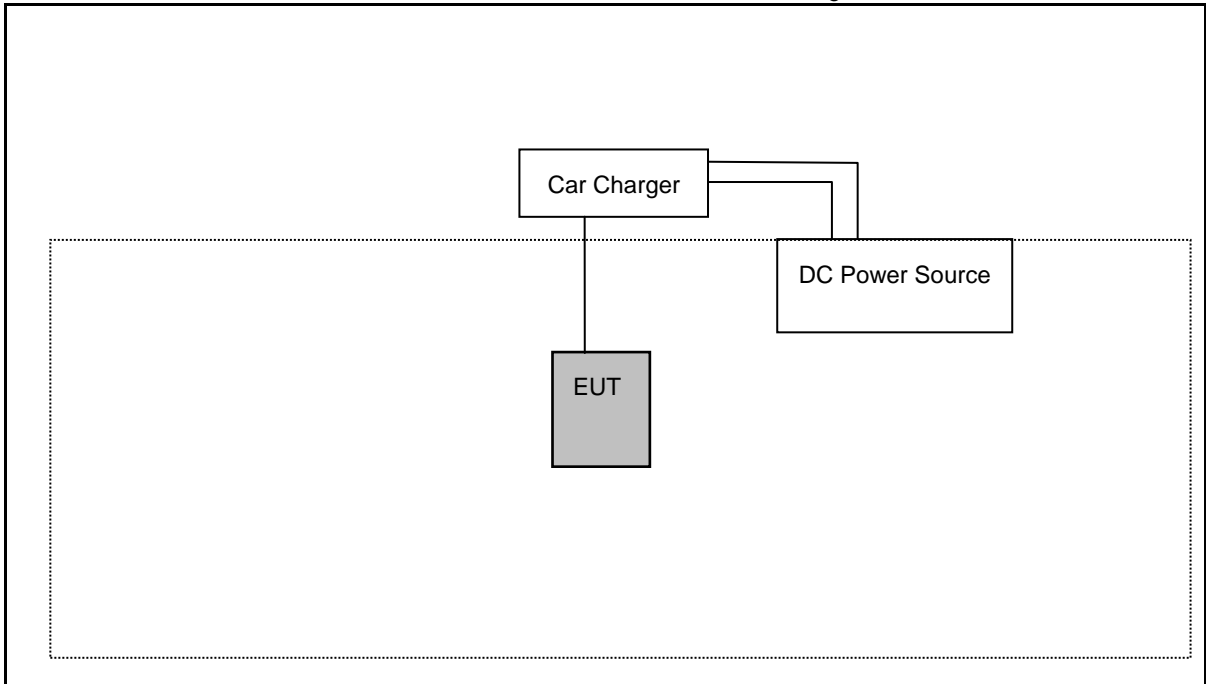



3.4. Test Instruments

For Conducted Emission

Test Period: Jun. 29, 2018

Equipment	Manufacturer	Model Number	Serial Number	Cal. Date	Cal. Period
EMI Test Receiver	R&S	ESCI	101000	12/18/2017	1 year
LISN	R&S	ENV216	101040	04/11/2018	1 year
LISN	R&S	ENV216	101041	03/23/2018	1 year

For Radiated Emissions

Test Period: Jul. 01 ~ Jul. 30, 2018

Equipment	Manufacturer	Model Number	Serial Number	Cal. Date	Cal. Period
Spectrum Analyzer (10Hz~44GHz)	Keysight	N9010A	MY52221312	01/15/2018	1 year
Pre Amplifier (1~26.5GHz)	Agilent	8449B	3008A02237	10/16/2017	1 year
Pre Amplifier (100KHz~1.3GHz)	Agilent	8447D	2944A11119	01/10/2018	1 year
Broadband Antenna	Schwarzbeck	VULB9168	416	10/26/2017	1 year
Horn Antenna (1~18GHz)	SCHWARZBECK MESS-ELEKTRONIK	BBHA9120D	9120D-550	06/22/2018	1 year
Horn Antenna (18~40GHz)	ETS	3116	86467	09/19/2017	1 year
Loop Antenna	COM-POWER CORPORATION	AL-130	121014	03/13/2018	1 year
RF Cable	EMCI	EMC104-N-N-6000	TE01-1	02/20/2018	1 year
Microwave Cable	EMCI	EMC104-SM-SM-13000	170814	10/31/2017	1 year
Microwave Cable	EMCI	EMC102-KM-KM-14000	151001	02/20/2018	1 year

For Conducted

Test Period: Jul. 04, 2018

Equipment	Manufacturer	Model Number	Serial Number	Cal. Date	Cal. Period
Power Sensor	Agilent	N1921A	MY45241957	12/07/2017	1 year
Power Meter	Agilent	N1911A	MY45101619	12/07/2017	1 year
Microwave Cable	EMCI	EMC102-SM-SM1500	001	11/22/2017	1 year

Note: N.C.R. = No Calibration Request.



3.5. Test Site Environment

Items	Required (IEC 60068-1)	Actual
Temperature (°C)	15-35	26
Humidity (%RH)	25-75	60
Barometric pressure (mbar)	860-1060	950

4 Measurement Procedure

4.1. Maximum Conducted Output Power Measurement

■ Limit

For frequency hopping systems operating in the 2400–2483.5 MHz band employing at least 75 non-overlapping hopping channels < 0.125 watt.

■ Test Setup

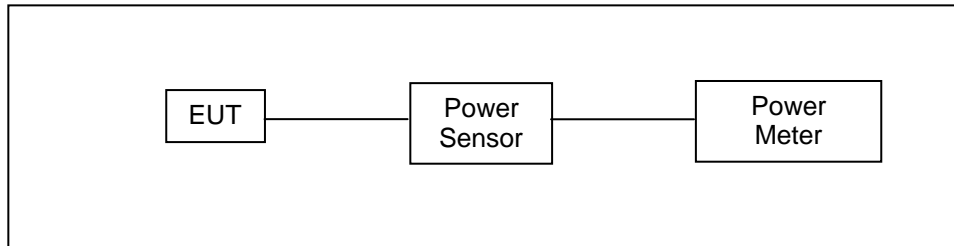

■ Test Procedure

Testing must be done according to this procedure, FCC Public Notice DA 00-705 - Filing and Measurement Guidelines for Frequency Hopping Spread Spectrum Systems. This is the only method recognized by the FCC. The tests below are run with the EUT's transmitter set at high power in TX mode. The EUT is needed to force selection of output power level and channel number. While testing, EUT was set to transmit continuously. Remove the Subjective device's antenna and connect the RF output port to power sensor. The maximum peak output power shall not exceed 1 watt.

Use a direct connection between the antenna port of transmitter and the power sensor, for prevent the power sensor input attenuation 40-50 dB. Set the RBW Bandwidth of the emission or use a channel power meter mode. For antennas with gains of 6 dBi or less, maximum allowed transmitter output is 1 watt (+30 dBm). For antennas with gains greater than 6 dBi, transmitter output level must be decreased by an amount equal to $(\text{GAIN} - 6)/3$ dBm. The antenna port of the EUT was connected to the input of a power sensor. Power was read directly and cable loss correction was added to the reading to obtain power at the EUT antenna terminals.

4.2. AC Power Line Conducted Emission Measurement

■ Limit

Frequency (MHz)	Quasi-peak	Average
0.15 - 0.5	66 to 56	56 to 46
0.50 - 5.0	56	46
5.0 - 30.0	60	50

■ Test Setup

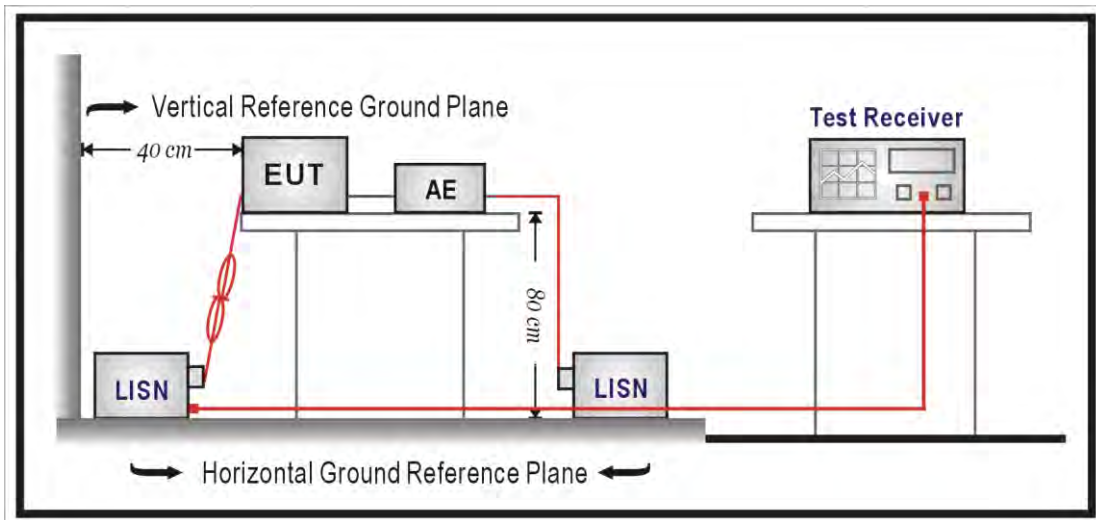

■ Test Procedure

The EUT and simulators are connected to the main power through a line impedance stabilization network (L.I.S.N.). This provides a $50\Omega // 50\mu\text{H}$ coupling impedance for the measuring equipment. The peripheral devices are also connected to the main power through a LISN that provides a $50\Omega // 50\mu\text{H}$ coupling impedance with 50ohm termination.

Tabletop device shall be placed on a non-conducting platform, of nominal size 1 m by 1.5 m, raised 80 cm above the reference ground plane. The wall of screened room shall be located 40cm to the rear of the EUT. Other surfaces of tabletop or floor standing EUT shall be at least 80cm from any other ground conducting surface including one or more LISNs. For floor-standing device shall be placed under the EUT with a 12mm insulating material.

Conducted emissions were investigated over the frequency range from 0.15 MHz to 30 MHz using a resolution bandwidth of 9 kHz. The equipment under test (EUT) shall be meet the limits in section 4.1, as applicable, including the average limit and the quasi-peak limit when using respectively, an average detector and quasi-peak detector measured in accordance with the methods described of related standard. When all of peak value were complied with quasi-peak and average limit from 150kHz to 30MHz then quasi-peak and average measurement was unnecessary.

The AMN shall be placed 0,8 m from the boundary of the unit under test and bonded to a ground reference plane for AMNs mounted on top of the ground reference plane. This distance is between the closest points of the AMN and the EUT. All other units of the EUT and associated equipment shall be at least 0,8 m from the AMN. If the mains power cable is longer than 1m then the cable shall be folded back and forth at the centre of the lead to form a bundle no longer than 0.4m. All of interconnecting cables that hang closer than 40cm to the ground plane shall be folded back and forth in the center forming a bundle 30 cm to 40 cm long. All of EUT and AE shall be separate place more than 0.1m. All 50Ω ports of the LISN shall be resistively terminated into 50Ω loads when not connected to the measuring instrument.

If the reading of the measuring receiver shows fluctuations close to the limit, the reading shall be observed for at least 15 s at each measurement frequency; the higher reading shall be recorded with the exception of any brief isolated high reading which shall be ignored.

4.3. Transmitter Radiated Emissions Measurement

■ Limit

According to §15.209(a), except as provided elsewhere in this subpart, the emissions from an intentional radiator shall not exceed the field strength levels specified in the following table:

Frequency (MHz)	Field Strength ($\mu\text{V}/\text{m}$ at meter)	Measurement Distance (meters)
0.009 – 0.490	$2400 / F$ (kHz)	300
0.490 – 1.705	$24000 / F$ (kHz)	30
1.705 – 30.0	30	30
30 - 88	100**	3
88-216	150**	3
216-960	200**	3
Above 960	500	3

** Except as provided in paragraph (g), fundamental emissions from intentional radiators operating under this Section shall not be located in the frequency bands 54-72 MHz, 76-88 MHz, 174-216 MHz or 470-806 MHz. However, operation within these frequency bands is permitted under other sections of this Part, e.g., Sections 15.231 and 15.241.

■ Setup

9kHz ~ 30MHz

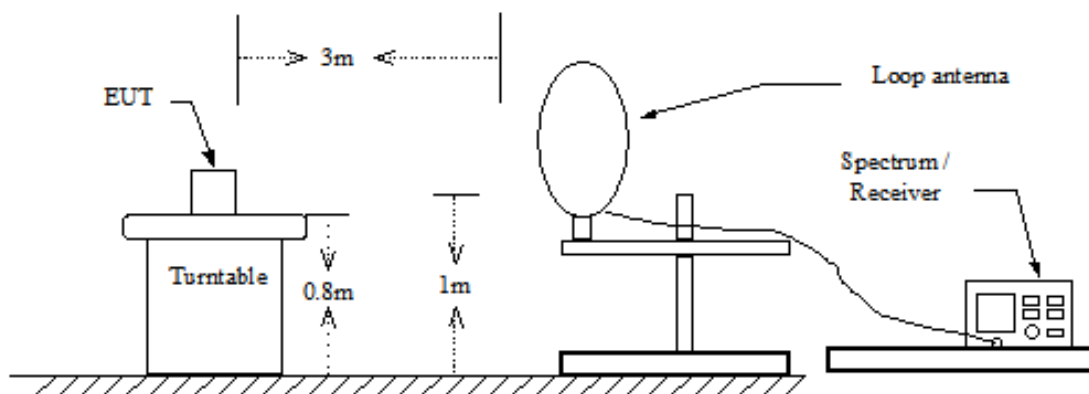

Below 1GHz

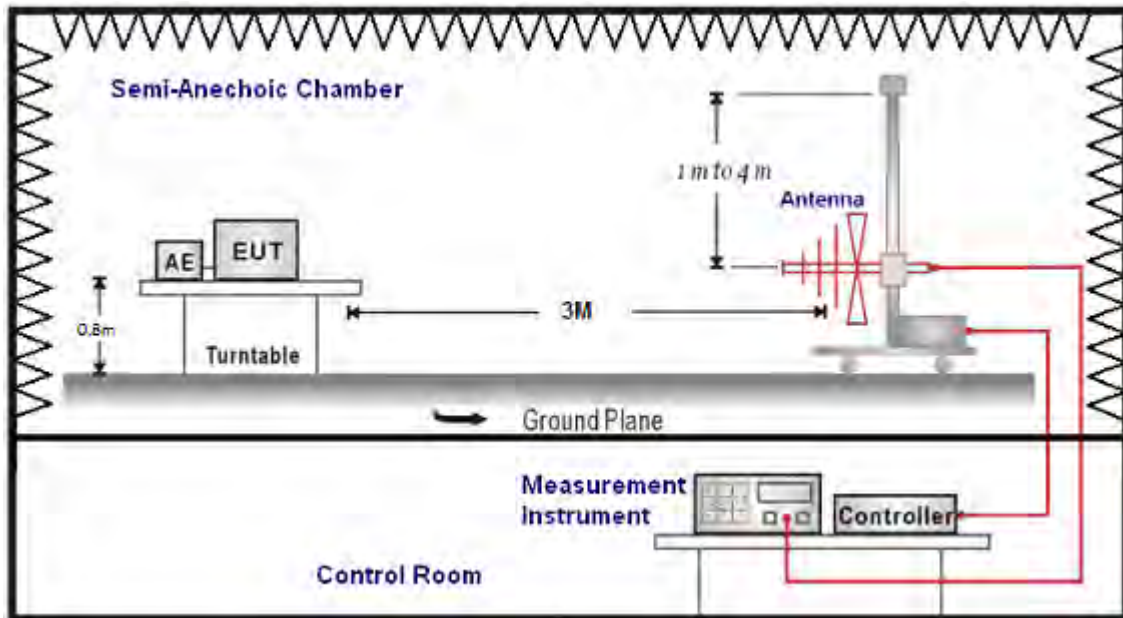

Above 1GHz

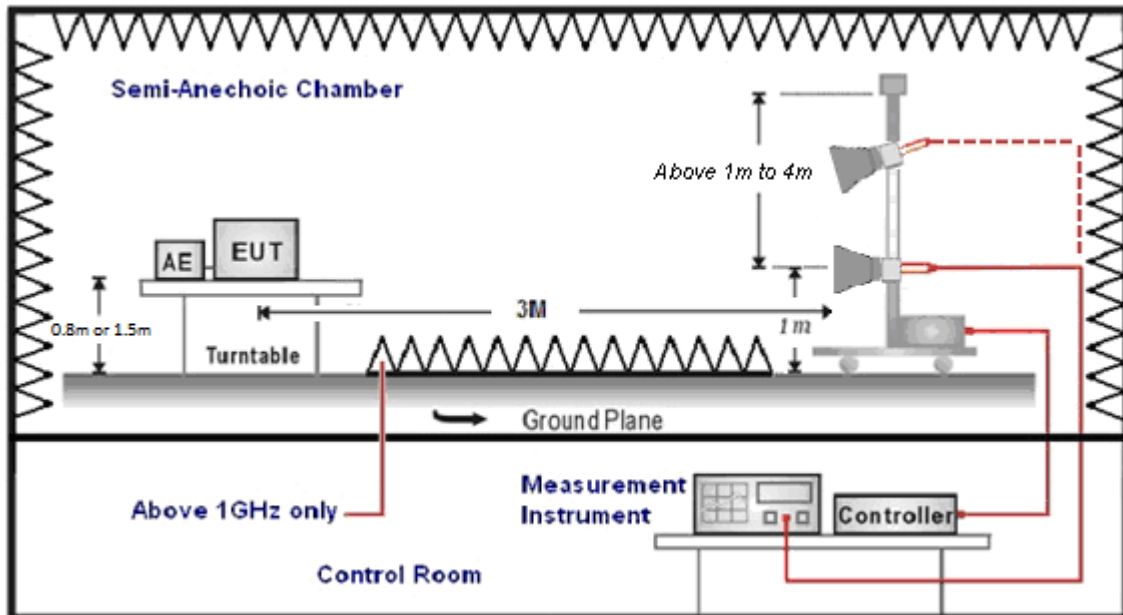

■ Test Procedure

Final radiation measurements were made on a three-meter, Semi Anechoic Chamber. The EUT system was placed on a nonconductive turntable which is 0.8 or 1.5 meters height, top surface 1.0 x 1.5 meter. The spectrum was examined from 250 MHz to 2.5 GHz in order to cover the whole spectrum below 10th harmonic which could generate from the EUT. During the test, EUT was set to transmit continuously & Measurements spectrum range from 9 kHz to 26.5 GHz is investigated.

For measurements below 1 GHz the resolution bandwidth is set to 100 kHz for peak detection measurements or 120 kHz for quasi-peak detection measurements. Peak detection is used unless otherwise noted as quasi-peak.

For measurements above 1 GHz the resolution bandwidth is set to 1 MHz, and then the video bandwidth is set to 1 MHz for peak measurements and 10 Hz for average measurements.

A nonconductive material surrounded the EUT to supporting the EUT for standing on three orthogonal planes. At each condition, the EUT was rotated 360 degrees, and the antenna was raised and lowered from one to four meters to find the maximum emission levels. Measurements were taken using both horizontal and vertical antenna polarization.

SCHWARZBECK MESS-ELEKTRONIK Biconilog Antenna at 3 Meter and the SCHWARZBECK Double Ridged Guide Antenna was used in frequencies 1 – 26.5 GHz at a distance of 1 meter. All test results were extrapolated to equivalent signal at 3 meters utilizing an inverse linear distance extrapolation Factor (20dB/decade).

For testing above 1GHz, the emission level of the EUT in peak mode was 20dB lower than average limit (that means the emission level in peak mode also complies with the limit in average mode), then testing will be stopped and peak values of EUT will be reported, otherwise, the emissions will be measured in average mode again and reported.

Appropriate preamplifiers were used for improving sensitivity and precautions were taken to avoid overloading or desensitizing the spectrum analyzer. No post – detector video filters were used in the test.

The spectrum analyzer's 6 dB bandwidth was set to 1 MHz, and the analyzer was operated in the peak detection mode, for frequencies both below and up 1 GHz. The average levels were obtained by subtracting the duty cycle correction factor from the peak readings.

The following procedures were used to convert the emission levels measured in decibels referenced to 1 microvolt (dBuV) into field intensity in micro volts per meter (uV/m).

The actual field intensity in decibels referenced to 1 microvolt in to field intensity in micro volts per meter (dBuV/m).

The actual field intensity in referenced to 1 microvolt per meter (dBuV/m) is determined by algebraically adding the measured reading in dBuV, the antenna factor (dB), and cable loss (dB) and Subtracting the gain of preamplifier (dB) is auto calculate in spectrum analyzer.

$$(1) \text{ Amplitude (dBuV/m) = FI (dBuV) +AF (dBuV) +CL (dBuV)-Gain (dB)}$$

FI= Reading of the field intensity.

AF= Antenna factor.

CL= Cable loss.

P.S Amplitude is auto calculate in spectrum analyzer.

$$(2) \text{ Actual Amplitude (dBuV/m) = Amplitude (dBuV)-Dis(dB)}$$

The FCC specified emission limits were calculated according the EUT operating frequency and by following linear interpolation equations:

(a) For fundamental frequency : Transmitter Output < +30dBm

(b) For spurious frequency : Spurious emission limits = fundamental emission limit /10

Data of measurement within this frequency range without mark in the table above means the reading of emissions are attenuated more than 20dB below the permissible limits or the field strength is too small to be measured.



4.4. Antenna Measurement

- **Limit**

For intentional device, according to 15.203, an intentional radiator shall be designed to ensure that no antenna other than that furnished by the responsible party shall be used with the device.

And According to 15.247 (b)(4), if transmitting antennas of directional gain greater than 6 dBi are used, the power shall be reduced by the amount in dB that the directional gain of the antenna exceeds 6dBi.

- **Antenna Connector Construction**

See section 2 – antenna information.



5 Test Results

Annex A. AC Power Line Conducted Emission Test Results

Standard:	FCC Part 15.247	Line:	L1
Test item:	Conducted Emission	Power:	AC 120V/60Hz
Test Mode:	Mode 1	Temp.(°C)/Hum.(%RH):	26(°C)/60%RH
Description:			

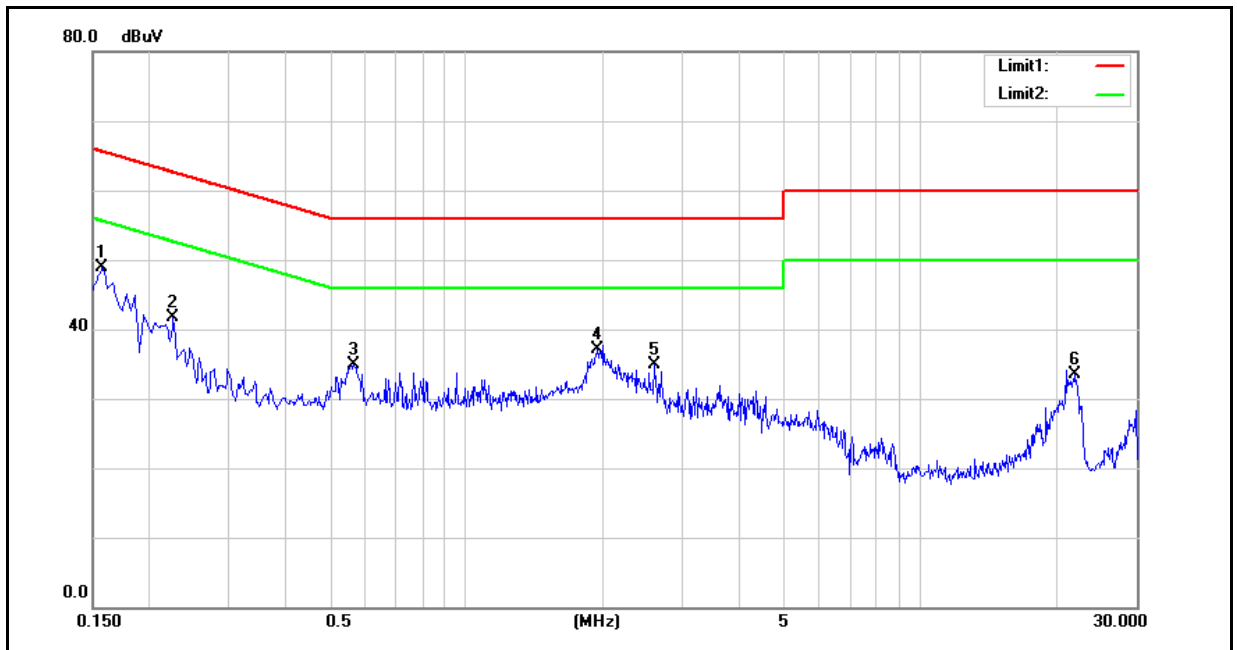

No.	Frequency (MHz)	QP reading (dBuV)	AVG reading (dBuV)	Correction factor (dB)	QP result (dBuV)	AVG result (dBuV)	QP limit (dBuV)	AVG limit (dBuV)	QP margin (dB)	AVG margin (dB)	Remark
1	0.1580	36.11	17.50	9.68	45.79	27.18	65.57	55.57	-19.78	-28.39	Pass
2	0.2260	25.49	11.90	9.68	35.17	21.58	62.60	52.60	-27.43	-31.02	Pass
3	0.5660	22.23	14.22	9.68	31.91	23.90	56.00	46.00	-24.09	-22.10	Pass
4	1.9260	22.08	15.31	9.74	31.82	25.05	56.00	46.00	-24.18	-20.95	Pass
5	2.5980	17.60	11.14	9.77	27.37	20.91	56.00	46.00	-28.63	-25.09	Pass
6	21.9580	14.73	4.89	10.53	25.26	15.42	60.00	50.00	-34.74	-34.58	Pass

Note: 1. Result (dBuV/m) = Correct Factor (dB/m) + Reading(dBuV).

2. Correction factor (dB) = Cable loss (dB) + L.I.S.N. factor (dB).



Standard:	FCC Part 15.247	Line:	N
Test item:	Conducted Emission	Power:	AC 120V/60Hz
Test Mode:	Mode 1	Temp.(°C)/Hum.(%RH):	26(°C)/60%RH
Description:			

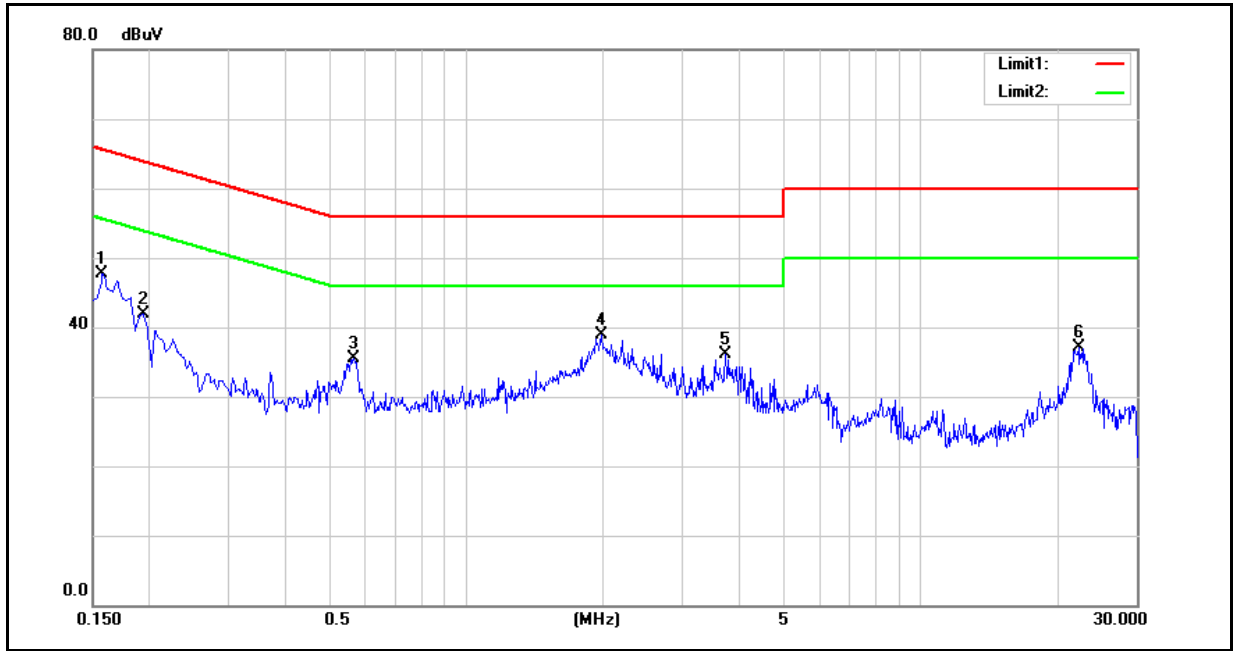

No.	Frequency (MHz)	QP reading (dBuV)	AVG reading (dBuV)	Correction factor (dB)	QP result (dBuV)	AVG result (dBuV)	QP limit (dBuV)	AVG limit (dBuV)	QP margin (dB)	AVG margin (dB)	Remark
1	0.1580	34.18	18.69	9.68	43.86	28.37	65.57	55.57	-21.71	-27.20	Pass
2	0.1940	28.79	12.35	9.69	38.48	22.04	63.86	53.86	-25.38	-31.82	Pass
3	0.5660	23.08	15.95	9.70	32.78	25.65	56.00	46.00	-23.22	-20.35	Pass
4	1.9820	23.34	16.34	9.77	33.11	26.11	56.00	46.00	-22.89	-19.89	Pass
5	3.7340	17.27	7.40	9.84	27.11	17.24	56.00	46.00	-28.89	-28.76	Pass
6	22.3060	18.86	8.43	10.61	29.47	19.04	60.00	50.00	-30.53	-30.96	Pass

Note: 1. Result (dBuV/m) = Correct Factor (dB/m) + Reading(dBuV).

2. Correction factor (dB) = Cable loss (dB) + L.I.S.N. factor (dB).



Annex B. Conducted Test Results

Maximum Conducted Output Power Measurement

Test Mode	Frequency (MHz)	Packet Type	Peak Power				Limit (W)
			Original		Verify		
			(dBm)	(W)	(dBm)	(W)	
Mode 2	2402	DH1	7.06	0.00508	5.67	0.00369	< 0.125
		DH3	7.08	0.00511	5.70	0.00372	< 0.125
		DH5	7.11	0.00514	5.72	0.00373	< 0.125
	2441	DH1	6.81	0.00480	6.33	0.00430	< 0.125
		DH3	6.87	0.00486	6.35	0.00432	< 0.125
		DH5	6.90	0.00490	6.38	0.00435	< 0.125
	2480	DH1	6.23	0.00420	6.45	0.00442	< 0.125
		DH3	6.45	0.00442	6.48	0.00445	< 0.125
		DH5	6.49	0.00446	6.50	0.00447	< 0.125
Mode 3	2402	2DH1	6.29	0.00426	4.71	0.00296	< 0.125
		2DH3	6.33	0.00430	4.75	0.00299	< 0.125
		2DH5	6.56	0.00453	4.77	0.00300	< 0.125
	2441	2DH1	6.10	0.00407	5.10	0.00324	< 0.125
		2DH3	6.35	0.00432	5.12	0.00325	< 0.125
		2DH5	6.35	0.00432	5.15	0.00327	< 0.125
	2480	2DH1	5.48	0.00353	5.28	0.00337	< 0.125
		2DH3	5.52	0.00356	5.31	0.00340	< 0.125
		2DH5	5.76	0.00377	5.35	0.00343	< 0.125
Mode 4	2402	3DH1	6.75	0.00473	4.78	0.00301	< 0.125
		3DH3	6.76	0.00474	4.80	0.00302	< 0.125
		3DH5	6.93	0.00493	4.83	0.00304	< 0.125
	2441	3DH1	6.36	0.00433	5.15	0.00327	< 0.125
		3DH3	6.49	0.00446	5.18	0.00330	< 0.125
		3DH5	6.65	0.00462	5.21	0.00332	< 0.125
	2480	3DH1	5.51	0.00356	5.40	0.00347	< 0.125
		3DH3	5.65	0.00367	5.42	0.00348	< 0.125
		3DH5	6.22	0.00419	5.44	0.00350	< 0.125

Note: The relevant measured result has the offset with cable loss already.

Annex C. Transmitter Radiated Emissions Test Results

Harmonic

Below 1GHz

Standard:	FCC Part 15.247	Test Distance:	3m				
Test item:	Harmonic	Power:	AC 120V/60Hz				
Test Mode:	Mode 1	Temp.(°C)/Hum.(%RH):	26(°C)/60%RH				
Description:	EUT connects to NB with the USB cable						
Frequency (MHz)	Reading (dBuV)	Correct Factor (dB/m)	Result (dBuV/m)	Limit (dBuV/m)	Margin (dB)	Remark	Ant.Polar. H / V
172.5900	43.13	-10.59	32.54	43.50	-10.96	peak	H
180.3500	48.12	-11.32	36.80	43.50	-6.70	peak	H
203.6300	46.55	-13.58	32.97	43.50	-10.53	peak	H
482.0200	39.62	-5.18	34.44	46.00	-11.56	peak	H
786.6000	32.13	0.18	32.31	46.00	-13.69	peak	H
902.0300	29.49	1.91	31.40	46.00	-14.60	peak	H
174.5300	41.87	-10.74	31.13	43.50	-12.37	peak	V
198.7800	42.30	-12.84	29.46	43.50	-14.04	peak	V
480.0800	43.17	-5.16	38.01	46.00	-7.99	peak	V
686.6900	39.84	-2.06	37.78	46.00	-8.22	peak	V
783.6900	34.71	0.17	34.88	46.00	-11.12	peak	V
924.3400	28.97	2.12	31.09	46.00	-14.91	peak	V

Note:1.Result (dBuV/m) = Correct Factor (dB/m) + Reading(dBuV).

2.Correction factor (dB/m) = Antenna Factor (dB/m) + Cable loss (dB) – Pre-Amplifier gain (dB).

3.No emission found between lowest internal used/generated frequencies to 30MHz (9 kHz~30MHz).



Standard:	FCC Part 15.247	Test Distance:	3m				
Test item:	Harmonic	Power:	AC 120V/60Hz				
Test Mode:	Mode 1	Temp.(°C)/Hum.(%RH):	26(°C)/60%RH				
Description:	EUT connects to DC Power Source with the car charger						
Frequency (MHz)	Reading (dBuV)	Correct Factor (dB/m)	Result (dBuV/m)	Limit (dBuV/m)	Margin (dB)	Remark	Ant.Polar. H / V
696.3900	37.81	-1.99	35.82	46.00	-10.18	QP	H
743.9200	38.69	-0.98	37.71	46.00	-8.29	QP	H
792.4200	34.82	0.19	35.01	46.00	-10.99	QP	H
839.9500	35.76	0.67	36.43	46.00	-9.57	QP	H
888.4500	32.27	1.27	33.54	46.00	-12.46	QP	H
984.4800	34.20	2.84	37.04	54.00	-16.96	QP	H
30.9700	48.46	-11.62	36.84	40.00	-3.16	QP	V
551.8600	39.67	-5.03	34.64	46.00	-11.36	QP	V
792.4200	35.79	0.19	35.98	46.00	-10.02	QP	V
839.9500	32.69	0.67	33.36	46.00	-12.64	QP	V
888.4500	35.60	1.27	36.87	46.00	-9.13	QP	V
935.9800	34.73	2.58	37.31	46.00	-8.69	QP	V

Note:1.Result (dBuV/m) = Correct Factor (dB/m) + Reading(dBuV).

2.Correction factor (dB/m) = Antenna Factor (dB/m) + Cable loss (dB) – Pre-Amplifier gain (dB).

3.No emission found between lowest internal used/generated frequencies to 30MHz (9 kHz~30MHz).



Above 1GHz

Standard:	FCC Part 15.247	Test Distance:	3m
Test item:	Harmonic	Power:	AC 120V/60Hz
Frequency:	2402MHz	Temp.(°C)/Hum.(%RH):	26(°C)/60%RH
Mode:	Mode 2		
Ant.Polar.:	Horizontal		

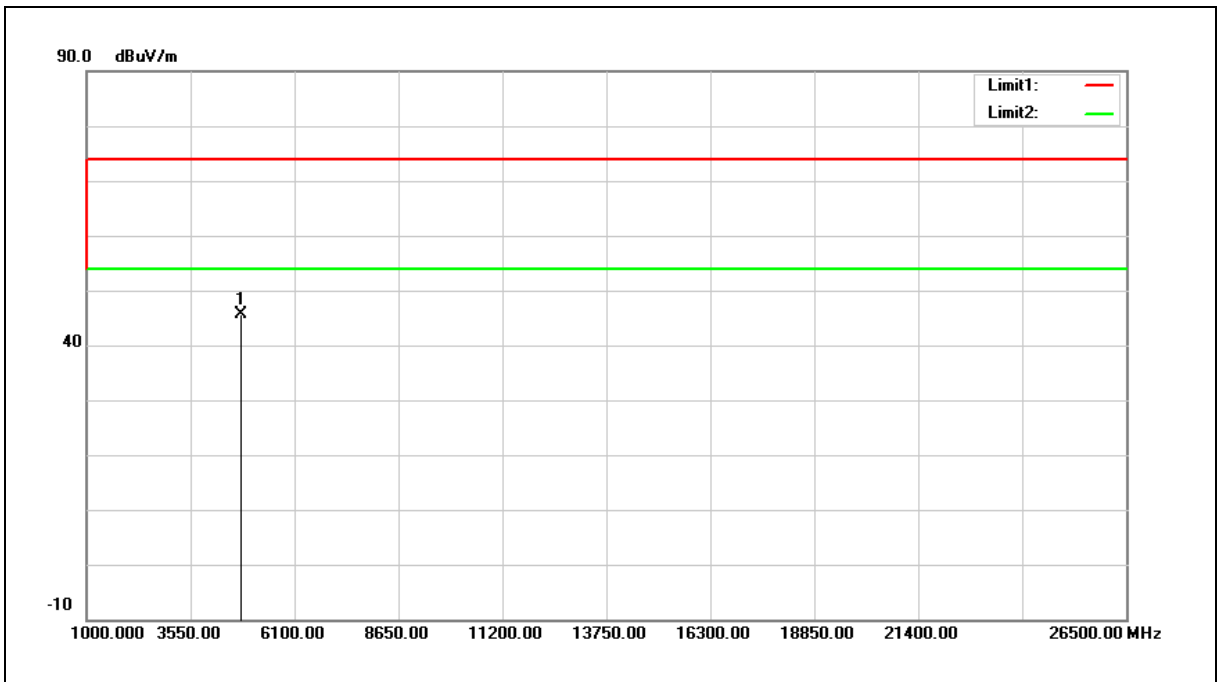

No.	Frequency (MHz)	Reading (dBuV)	Correct Factor (dB/m)	Result (dBuV/m)	Limit (dBuV/m)	Margin (dB)	Remark
1	4804.000	49.87	-4.35	45.52	74.00	-28.48	peak

- Note:1.Result (dBuV/m) = Correct Factor (dB/m) + Reading(dBuV).
 2.Correction factor (dB/m) = Antenna Factor (dB/m) + Cable loss (dB) – Pre-Amplifier gain (dB).
 3.When the peak results are less than average limit, so not need to evaluate the average.



Standard:	FCC Part 15.247	Test Distance:	3m
Test item:	Harmonic	Power:	AC 120V/60Hz
Frequency:	2402MHz	Temp.(°C)/Hum.(%RH):	26(°C)/60%RH
Mode:	Mode 2		
Ant.Polar.:	Vertical		

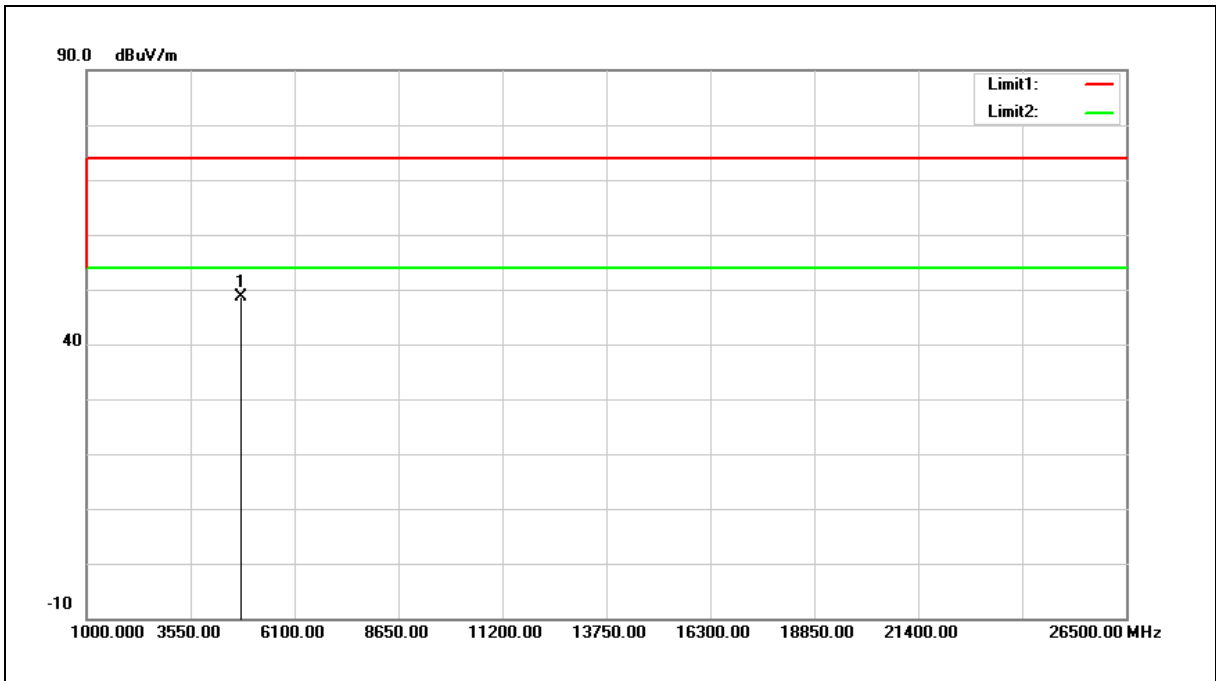

No.	Frequency (MHz)	Reading (dBuV)	Correct Factor (dB/m)	Result (dBuV/m)	Limit (dBuV/m)	Margin (dB)	Remark
1	4804.000	52.97	-4.35	48.62	74.00	-25.38	peak

Note:1.Result (dBuV/m) = Correct Factor (dB/m) + Reading(dBuV).

2.Correction factor (dB/m) = Antenna Factor (dB/m) + Cable loss (dB) – Pre-Amplifier gain (dB).

3.When the peak results are less than average limit, so not need to evaluate the average.



Standard:	FCC Part 15.247	Test Distance:	3m
Test item:	Harmonic	Power:	AC 120V/60Hz
Frequency:	2441MHz	Temp.(°C)/Hum.(%RH):	26(°C)/60%RH
Mode:	Mode 2		
Ant.Polar.:	Horizontal		

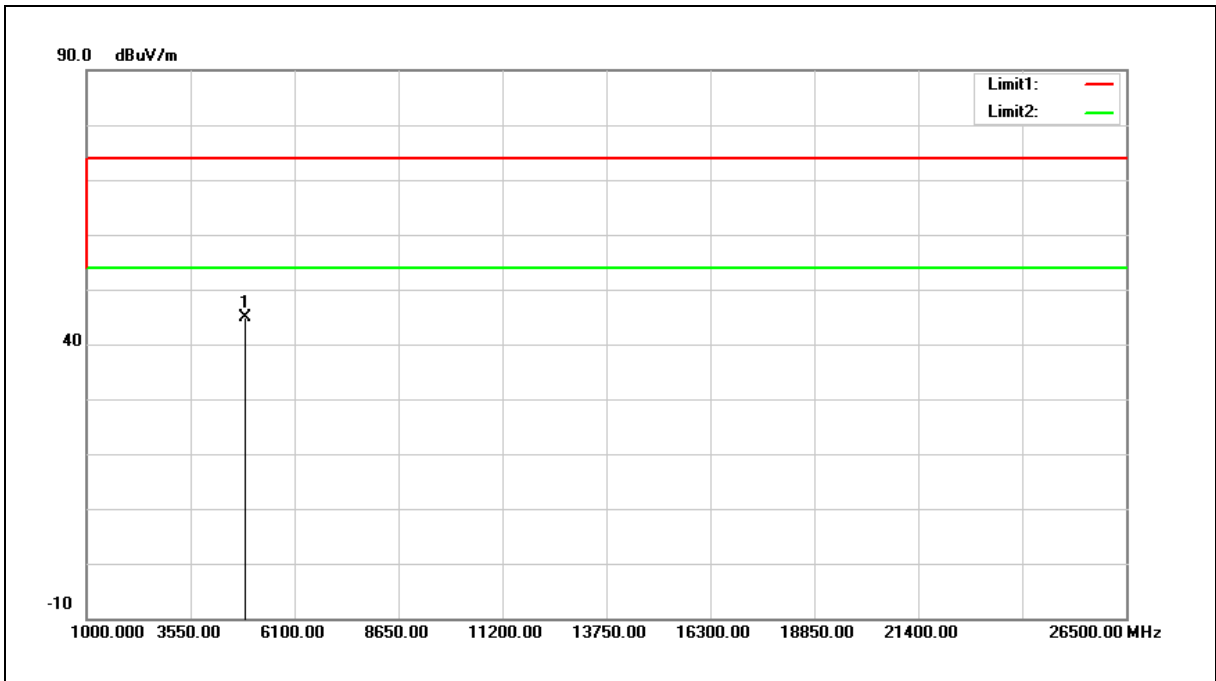

No.	Frequency (MHz)	Reading (dBuV)	Correct Factor (dB/m)	Result (dBuV/m)	Limit (dBuV/m)	Margin (dB)	Remark
1	4882.000	49.24	-4.37	44.87	74.00	-29.13	peak

Note:1.Result (dBuV/m) = Correct Factor (dB/m) + Reading(dBuV).

2.Correction factor (dB/m) = Antenna Factor (dB/m) + Cable loss (dB) – Pre-Amplifier gain (dB).

3.When the peak results are less than average limit, so not need to evaluate the average.



Standard:	FCC Part 15.247	Test Distance:	3m
Test item:	Harmonic	Power:	AC 120V/60Hz
Frequency:	2441MHz	Temp.(°C)/Hum.(%RH):	26(°C)/60%RH
Mode:	Mode 2		
Ant.Polar.:	Vertical		

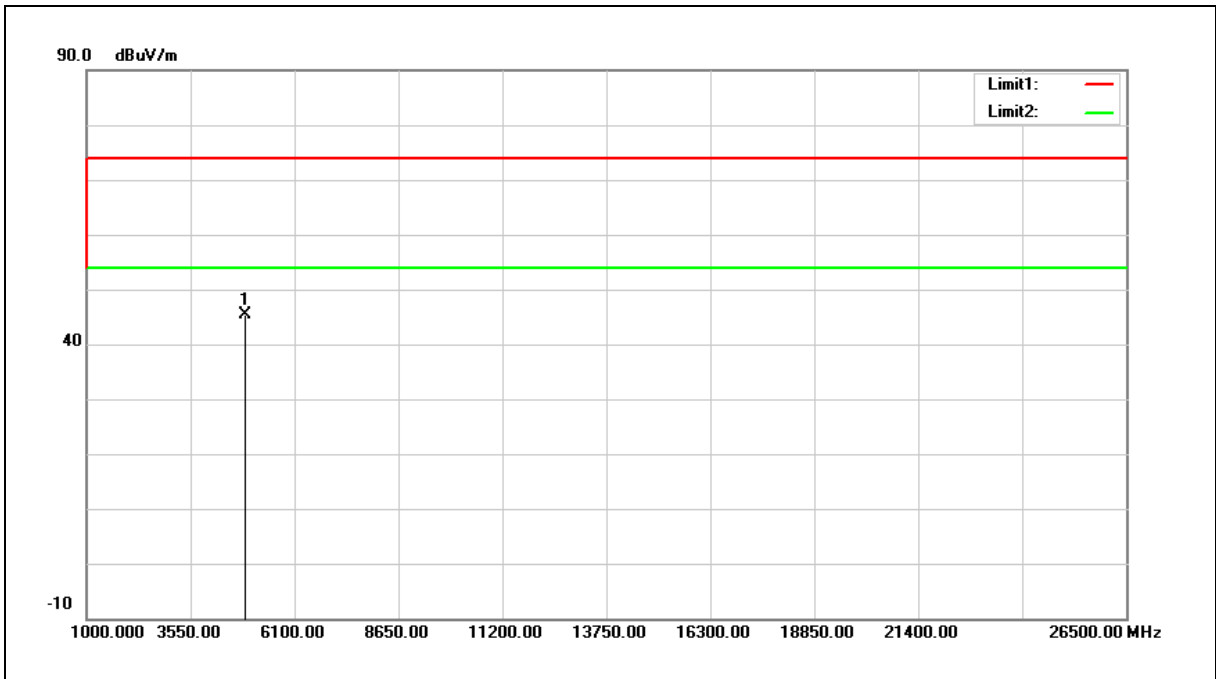

No.	Frequency (MHz)	Reading (dBuV)	Correct Factor (dB/m)	Result (dBuV/m)	Limit (dBuV/m)	Margin (dB)	Remark
1	4882.000	49.65	-4.37	45.28	74.00	-28.72	peak

Note:1.Result (dBuV/m) = Correct Factor (dB/m) + Reading(dBuV).

2.Correction factor (dB/m) = Antenna Factor (dB/m) + Cable loss (dB) – Pre-Amplifier gain (dB).

3.When the peak results are less than average limit, so not need to evaluate the average.



Standard:	FCC Part 15.247	Test Distance:	3m
Test item:	Harmonic	Power:	AC 120V/60Hz
Frequency:	2480MHz	Temp.(°C)/Hum.(%RH):	26(°C)/60%RH
Mode:	Mode 2		
Ant.Polar.:	Horizontal		

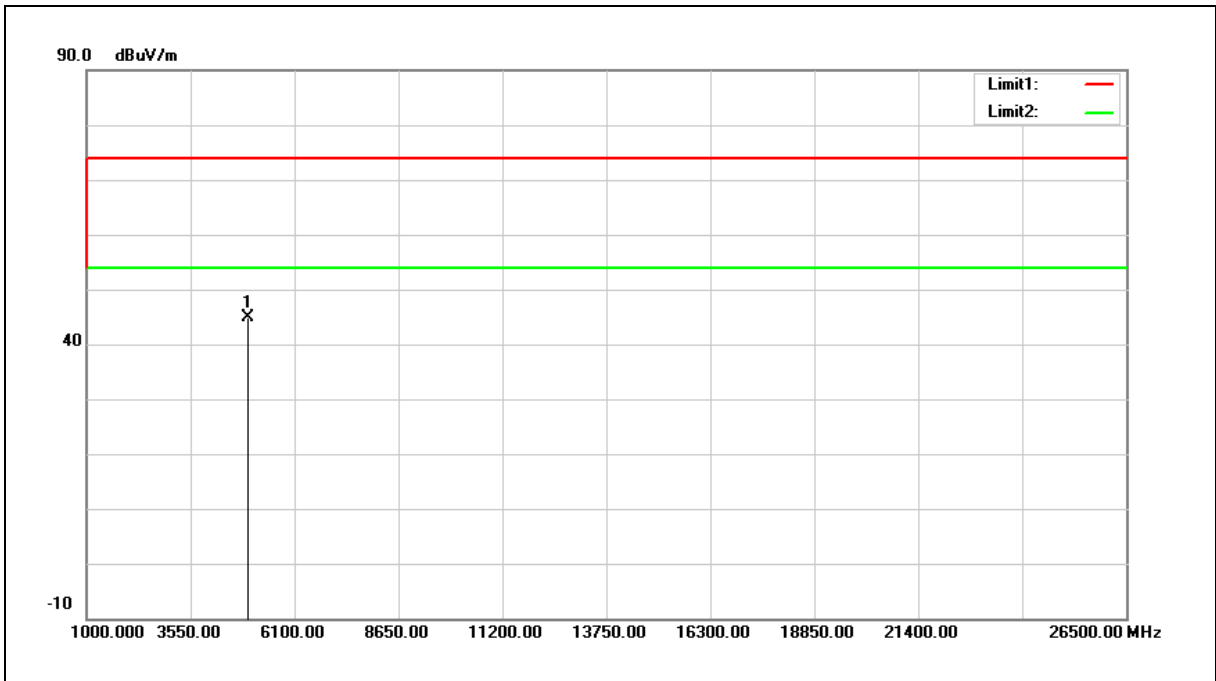

No.	Frequency (MHz)	Reading (dBuV)	Correct Factor (dB/m)	Result (dBuV/m)	Limit (dBuV/m)	Margin (dB)	Remark
1	4960.000	49.29	-4.39	44.90	74.00	-29.10	peak

Note:1.Result (dBuV/m) = Correct Factor (dB/m) + Reading(dBuV).

2.Correction factor (dB/m) = Antenna Factor (dB/m) + Cable loss (dB) – Pre-Amplifier gain (dB).

3.When the peak results are less than average limit, so not need to evaluate the average.



Standard:	FCC Part 15.247	Test Distance:	3m
Test item:	Harmonic	Power:	AC 120V/60Hz
Frequency:	2480MHz	Temp.(°C)/Hum.(%RH):	26(°C)/60%RH
Mode:	Mode 2		
Ant.Polar.:	Vertical		

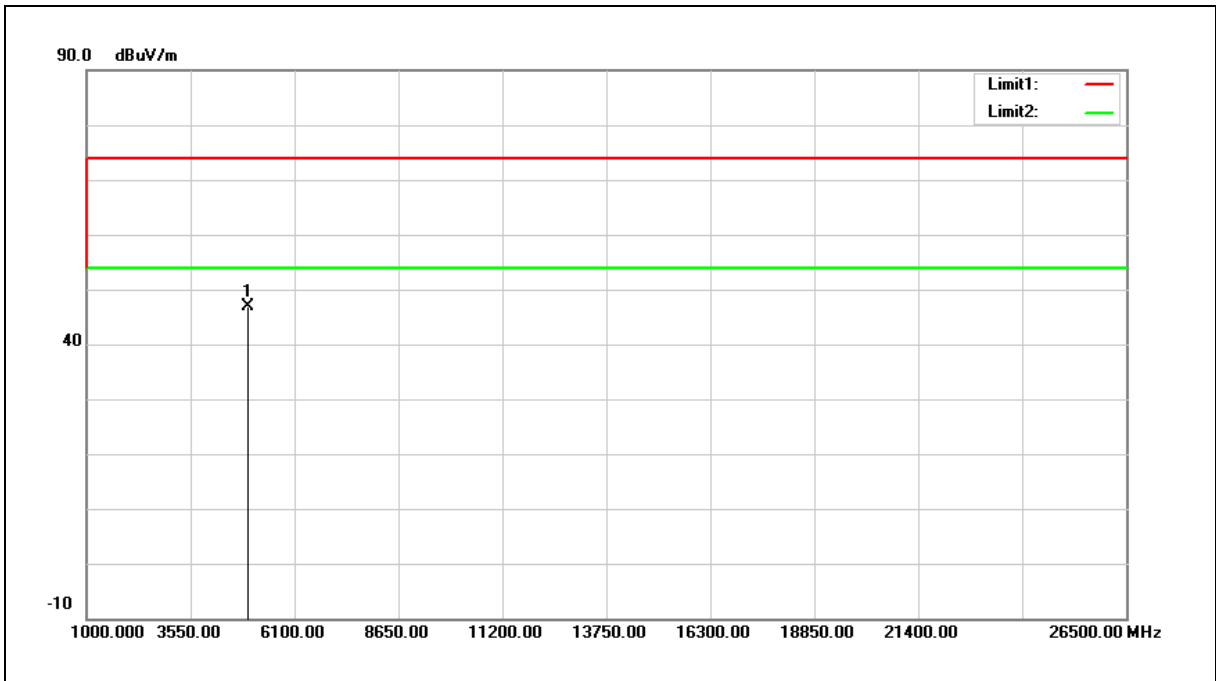

No.	Frequency (MHz)	Reading (dBuV)	Correct Factor (dB/m)	Result (dBuV/m)	Limit (dBuV/m)	Margin (dB)	Remark
1	4960.000	51.26	-4.39	46.87	74.00	-27.13	peak

Note:1.Result (dBuV/m) = Correct Factor (dB/m) + Reading(dBuV).

2.Correction factor (dB/m) = Antenna Factor (dB/m) + Cable loss (dB) – Pre-Amplifier gain (dB).

3.When the peak results are less than average limit, so not need to evaluate the average.



Standard:	FCC Part 15.247	Test Distance:	3m
Test item:	Harmonic	Power:	AC 120V/60Hz
Frequency:	2402MHz	Temp.(°C)/Hum.(%RH):	26(°C)/60%RH
Mode:	Mode 4		
Ant.Polar.:	Horizontal		

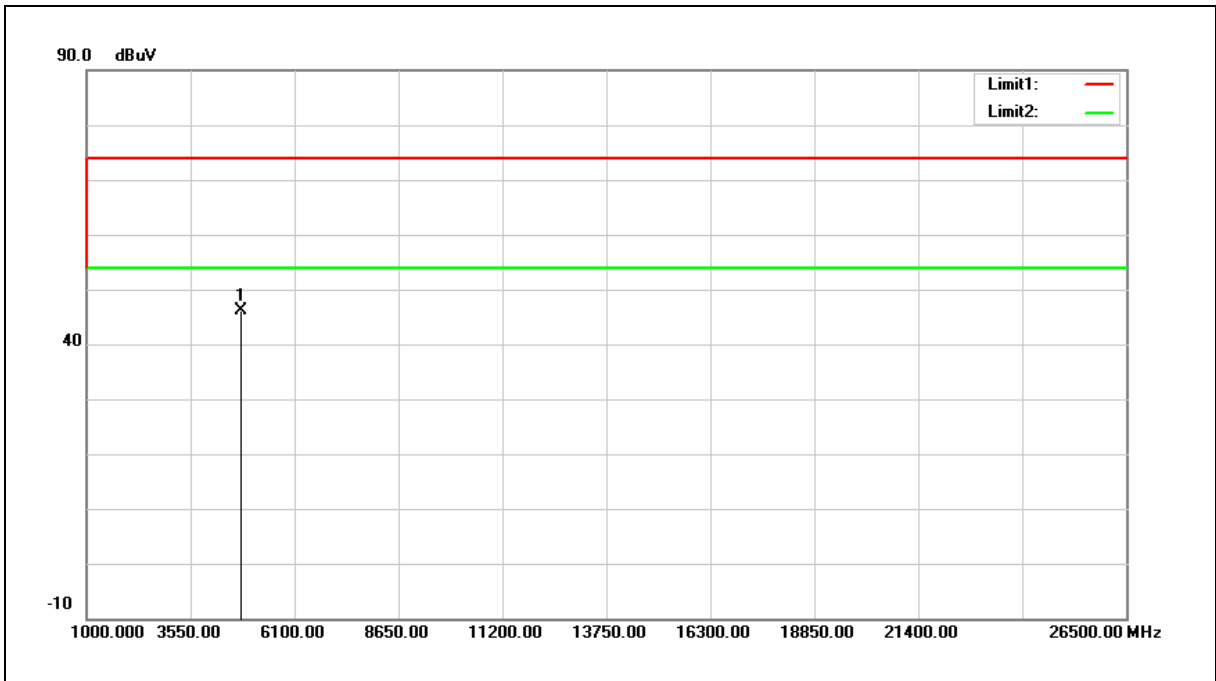

No.	Frequency (MHz)	Reading (dBuV)	Correct Factor (dB)	Result (dBuV)	Limit (dBuV)	Margin (dB)	Remark
1	4804.000	50.54	-4.35	46.19	74.00	-27.81	peak

Note:1.Result (dBuV/m) = Correct Factor (dB/m) + Reading(dBuV).

2.Correction factor (dB/m) = Antenna Factor (dB/m) + Cable loss (dB) – Pre-Amplifier gain (dB).

3.When the peak results are less than average limit, so not need to evaluate the average.



Standard:	FCC Part 15.247	Test Distance:	3m
Test item:	Harmonic	Power:	AC 120V/60Hz
Frequency:	2402MHz	Temp.(°C)/Hum.(%RH):	26(°C)/60%RH
Mode:	Mode 4		
Ant.Polar.:	Vertical		

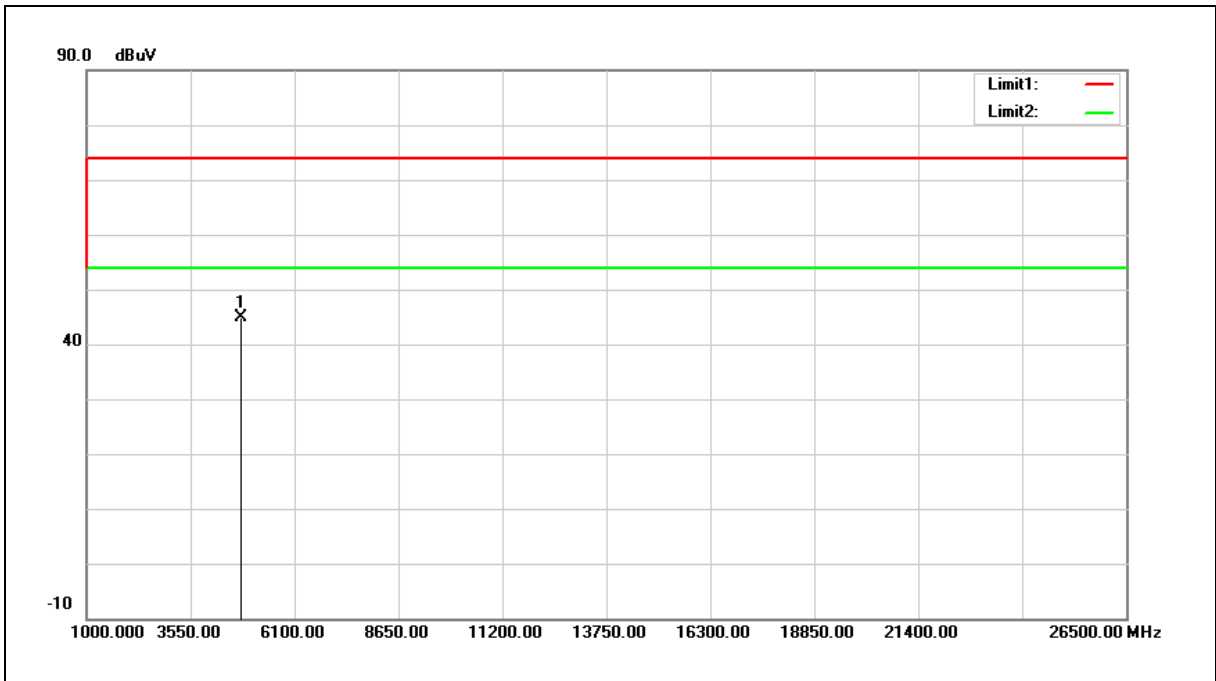

No.	Frequency (MHz)	Reading (dBuV)	Correct Factor (dB)	Result (dBuV)	Limit (dBuV)	Margin (dB)	Remark
1	4804.000	49.12	-4.35	44.77	74.00	-29.23	peak

Note:1.Result (dBuV/m) = Correct Factor (dB/m) + Reading(dBuV).

2.Correction factor (dB/m) = Antenna Factor (dB/m) + Cable loss (dB) – Pre-Amplifier gain (dB).

3.When the peak results are less than average limit, so not need to evaluate the average.



Standard:	FCC Part 15.247	Test Distance:	3m
Test item:	Harmonic	Power:	AC 120V/60Hz
Frequency:	2441MHz	Temp.(°C)/Hum.(%RH):	26(°C)/60%RH
Mode:	Mode 4		
Ant.Polar.:	Horizontal		

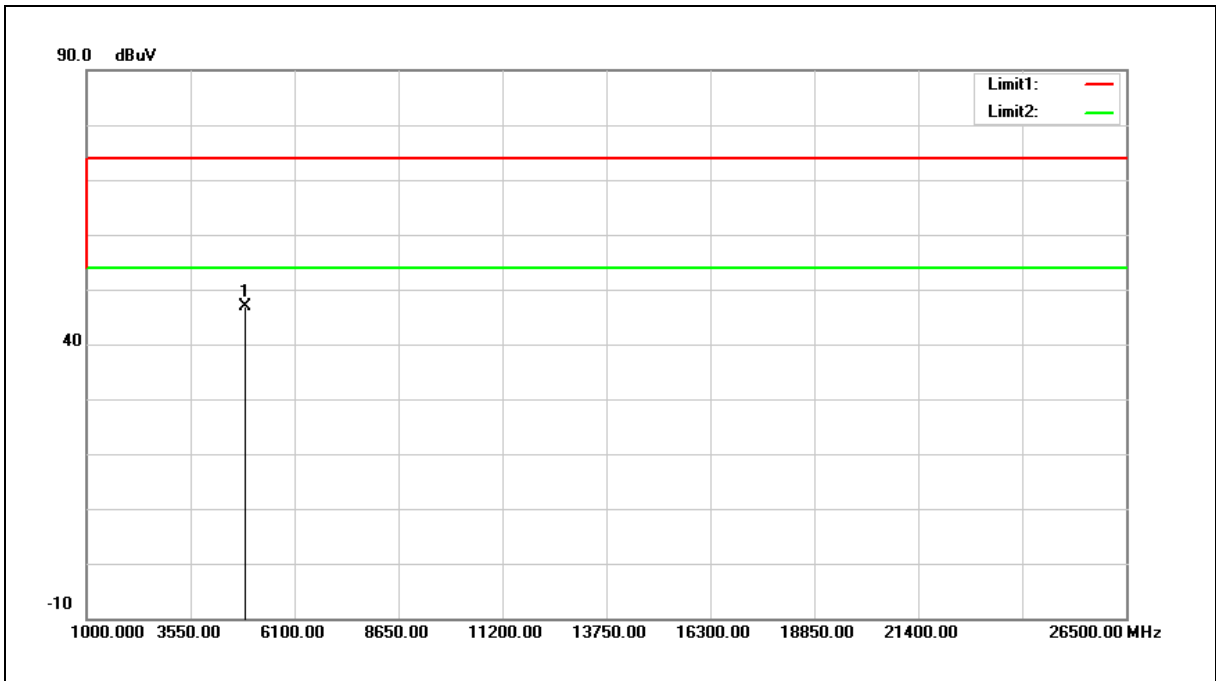

No.	Frequency (MHz)	Reading (dBuV)	Correct Factor (dB)	Result (dBuV)	Limit (dBuV)	Margin (dB)	Remark
1	4882.000	51.22	-4.37	46.85	74.00	-27.15	peak

Note:1.Result (dBuV/m) = Correct Factor (dB/m) + Reading(dBuV).

2.Correction factor (dB/m) = Antenna Factor (dB/m) + Cable loss (dB) – Pre-Amplifier gain (dB).

3.When the peak results are less than average limit, so not need to evaluate the average.



Standard:	FCC Part 15.247	Test Distance:	3m
Test item:	Harmonic	Power:	AC 120V/60Hz
Frequency:	2441MHz	Temp.(°C)/Hum.(%RH):	26(°C)/60%RH
Mode:	Mode 4		
Ant.Polar.:	Vertical		

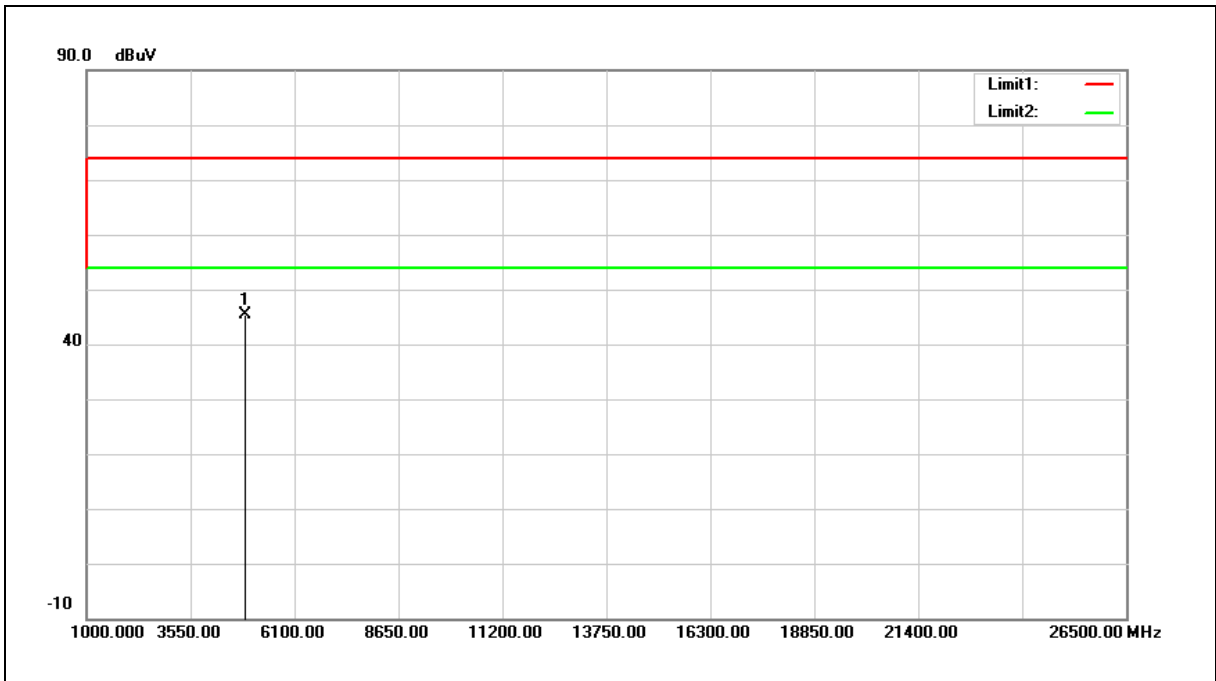

No.	Frequency (MHz)	Reading (dBuV)	Correct Factor (dB)	Result (dBuV)	Limit (dBuV)	Margin (dB)	Remark
1	4882.000	49.68	-4.37	45.31	74.00	-28.69	peak

Note:1.Result (dBuV/m) = Correct Factor (dB/m) + Reading(dBuV).

2.Correction factor (dB/m) = Antenna Factor (dB/m) + Cable loss (dB) – Pre-Amplifier gain (dB).

3.When the peak results are less than average limit, so not need to evaluate the average.



Standard:	FCC Part 15.247	Test Distance:	3m
Test item:	Harmonic	Power:	AC 120V/60Hz
Frequency:	2480MHz	Temp.(°C)/Hum.(%RH):	26(°C)/60%RH
Mode:	Mode 4		
Ant.Polar.:	Horizontal		

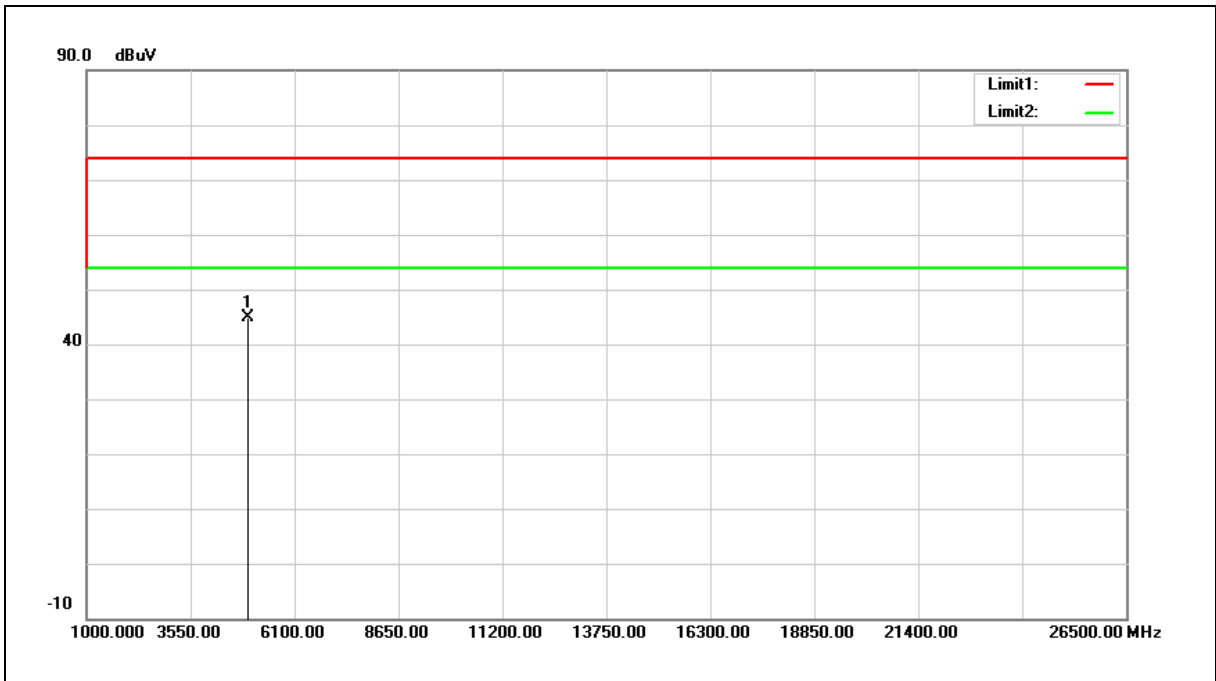

No.	Frequency (MHz)	Reading (dBuV)	Correct Factor (dB)	Result (dBuV)	Limit (dBuV)	Margin (dB)	Remark
1	4960.000	49.17	-4.39	44.78	74.00	-29.22	peak

Note:1.Result (dBuV/m) = Correct Factor (dB/m) + Reading(dBuV).

2.Correction factor (dB/m) = Antenna Factor (dB/m) + Cable loss (dB) – Pre-Amplifier gain (dB).

3.When the peak results are less than average limit, so not need to evaluate the average.



Standard:	FCC Part 15.247	Test Distance:	3m
Test item:	Harmonic	Power:	AC 120V/60Hz
Frequency:	2480MHz	Temp.(°C)/Hum.(%RH):	26(°C)/60%RH
Mode:	Mode 4		
Ant.Polar.:	Vertical		

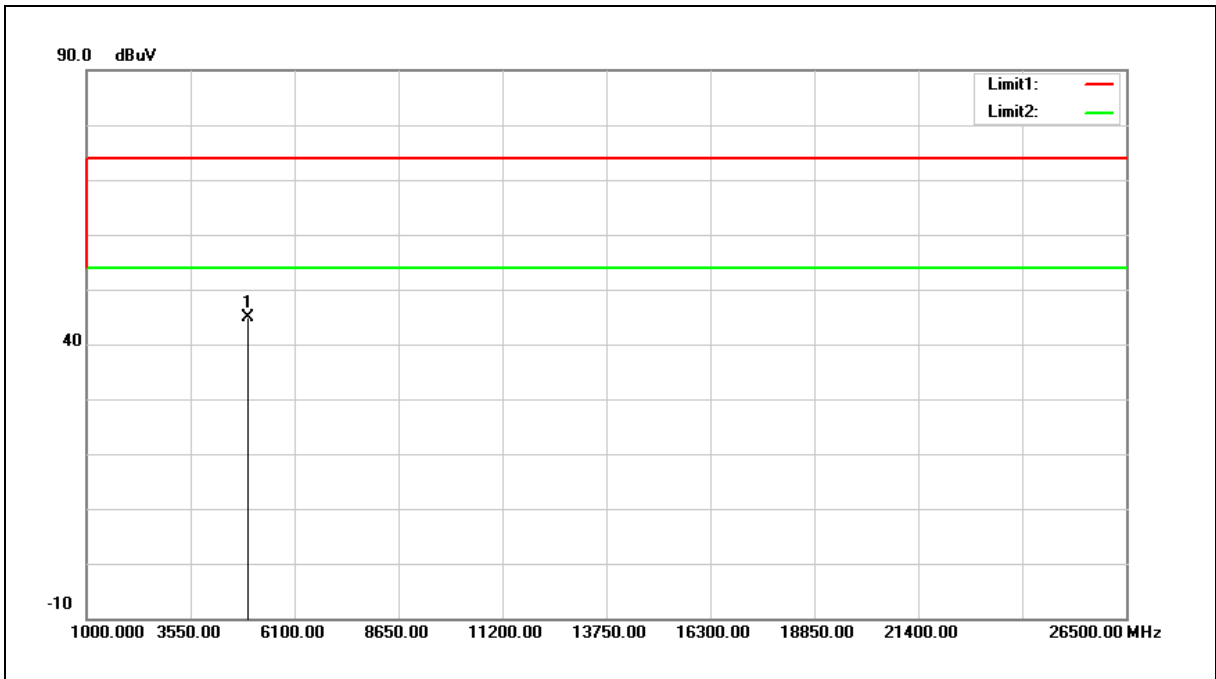

No.	Frequency (MHz)	Reading (dBuV)	Correct Factor (dB)	Result (dBuV)	Limit (dBuV)	Margin (dB)	Remark
1	4960.000	49.19	-4.39	44.80	74.00	-29.20	peak

Note:1.Result (dBuV/m) = Correct Factor (dB/m) + Reading(dBuV).

2.Correction factor (dB/m) = Antenna Factor (dB/m) + Cable loss (dB) – Pre-Amplifier gain (dB).

3.When the peak results are less than average limit, so not need to evaluate the average.



Band Edge

Standard:	FCC Part 15.247	Test Distance:	3m
Test item:	Band edge	Power:	AC 120V/60Hz
Frequency:	2402MHz	Temp.(°C)/Hum.(%RH):	26(°C)/60%RH
Mode:	Mode 2		
Ant.Polar.:	Horizontal		

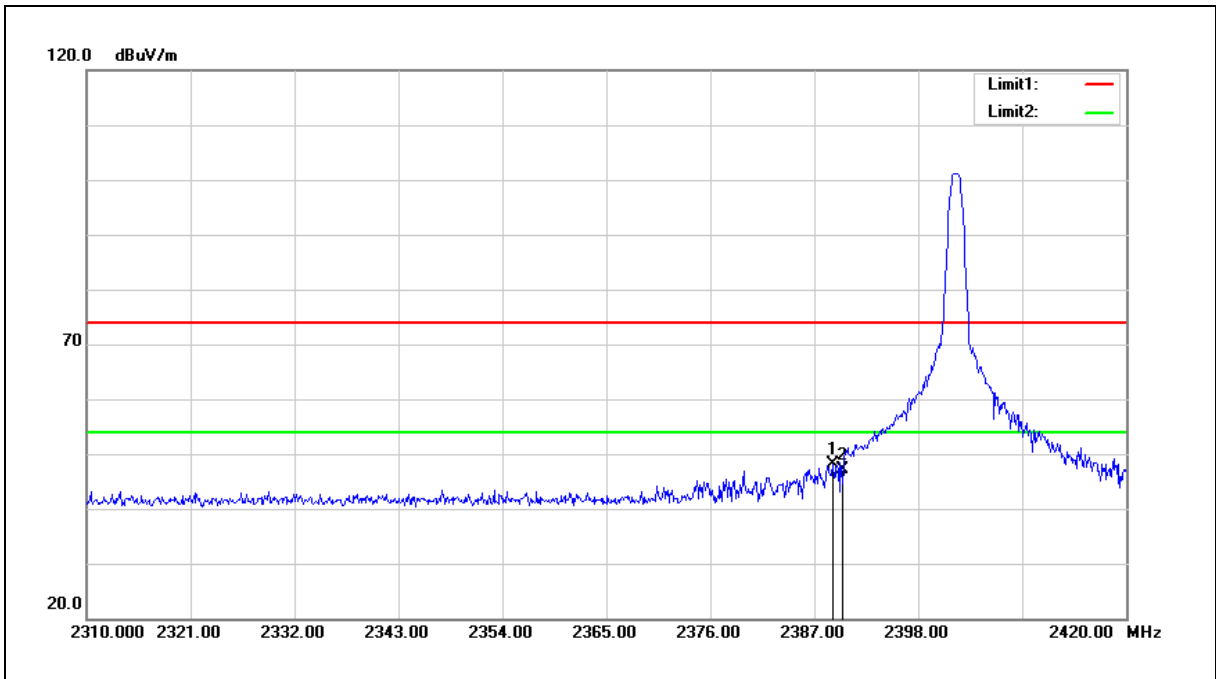

No.	Frequency (MHz)	Reading (dBuV)	Correct Factor (dB/m)	Result (dBuV/m)	Limit (dBuV/m)	Margin (dB)	Remark
1	2388.980	57.79	-9.63	48.16	74.00	-25.84	peak
2	2390.000	56.78	-9.62	47.16	74.00	-26.84	peak

Note:1.Result (dBuV/m) = Correct Factor (dB/m) + Reading(dBuV).

2.Correction factor (dB/m) = Antenna Factor (dB/m) + Cable loss (dB) – Pre-Amplifier gain (dB).

3.When the peak results are less than average limit, so not need to evaluate the average.



Standard:	FCC Part 15.247	Test Distance:	3m
Test item:	Band edge	Power:	AC 120V/60Hz
Frequency:	2402MHz	Temp.(°C)/Hum.(%RH):	26(°C)/60%RH
Mode:	Mode 2		
Ant.Polar.:	Vertical		

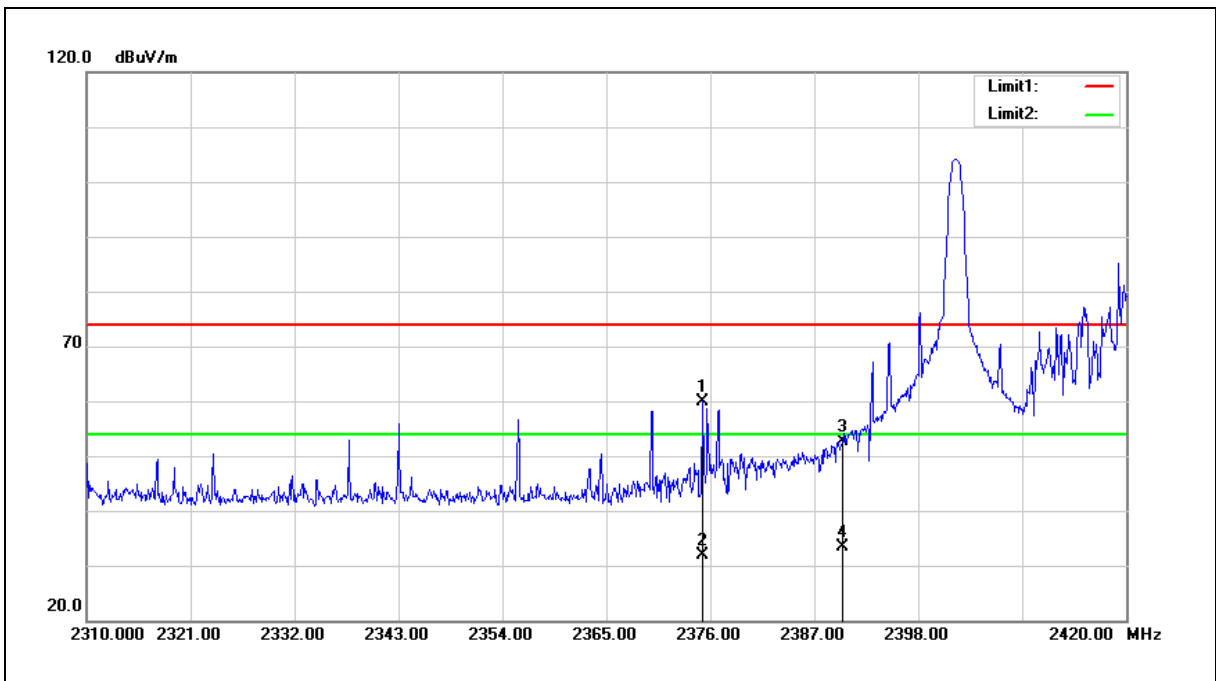

No.	Frequency (MHz)	Reading (dBuV)	Correct Factor (dB/m)	Result (dBuV/m)	Limit (dBuV/m)	Margin (dB)	Remark
1	2375.120	69.51	-9.70	59.81	74.00	-14.19	peak
2	2375.120	41.49	-9.70	31.79	54.00	-22.21	AVG
3	2390.000	62.36	-9.62	52.74	74.00	-21.26	peak
4	2390.000	43.06	-9.62	33.44	54.00	-20.56	AVG

Note:1.Result (dBuV/m) = Correct Factor (dB/m) + Reading(dBuV).

2.Correction factor (dB/m) = Antenna Factor (dB/m) + Cable loss (dB) – Pre-Amplifier gain (dB).

3.When the peak results are less than average limit, so not need to evaluate the average.



Standard:	FCC Part 15.247	Test Distance:	3m
Test item:	Band edge	Power:	AC 120V/60Hz
Frequency:	2480MHz	Temp.(°C)/Hum.(%RH):	26(°C)/60%RH
Mode:	Mode 2		
Ant.Polar.:	Horizontal		

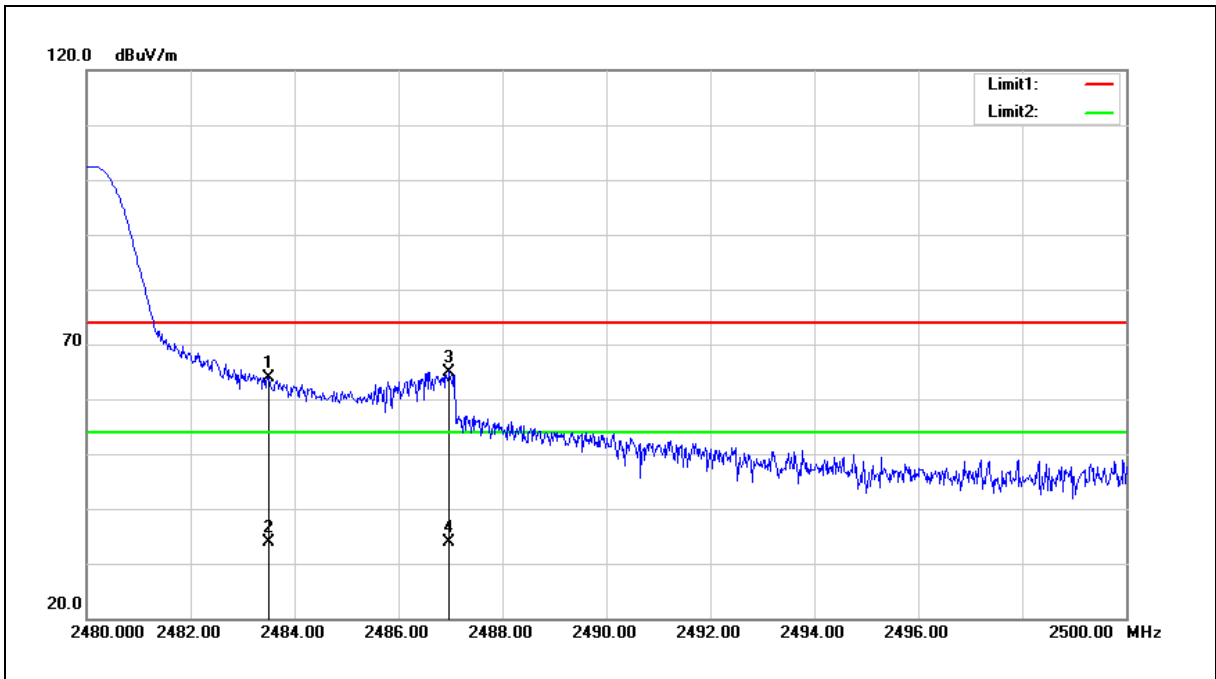

No.	Frequency (MHz)	Reading (dBuV)	Correct Factor (dB/m)	Result (dBuV/m)	Limit (dBuV/m)	Margin (dB)	Remark
1	2483.500	73.09	-9.20	63.89	74.00	-10.11	peak
2	2483.500	43.01	-9.20	33.81	54.00	-20.19	AVG
3	2486.980	74.19	-9.19	65.00	74.00	-9.00	peak
4	2486.980	43.16	-9.19	33.97	54.00	-20.03	AVG

Note:1.Result (dBuV/m) = Correct Factor (dB/m) + Reading(dBuV).

2.Correction factor (dB/m) = Antenna Factor (dB/m) + Cable loss (dB) – Pre-Amplifier gain (dB).

3.When the peak results are less than average limit, so not need to evaluate the average.



Standard:	FCC Part 15.247	Test Distance:	3m
Test item:	Band edge	Power:	AC 120V/60Hz
Frequency:	2480MHz	Temp.(°C)/Hum.(%RH):	26(°C)/60%RH
Mode:	Mode 2		
Ant.Polar.:	Vertical		

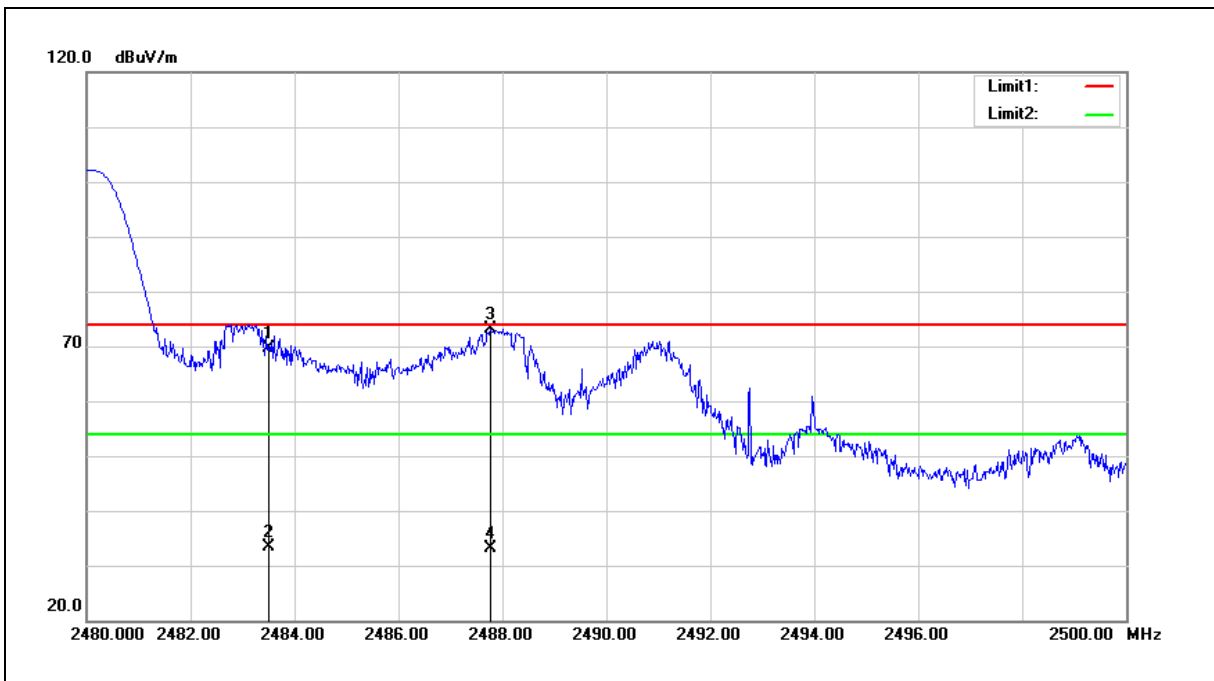

No.	Frequency (MHz)	Reading (dBuV)	Correct Factor (dB/m)	Result (dBuV/m)	Limit (dBuV/m)	Margin (dB)	Remark
1	2483.500	78.80	-9.20	69.60	74.00	-4.40	peak
2	2483.500	42.63	-9.20	33.43	54.00	-20.57	AVG
3	2487.760	82.25	-9.19	73.06	74.00	-0.94	peak
4	2487.760	42.33	-9.19	33.14	54.00	-20.86	AVG

Note:1.Result (dBuV/m) = Correct Factor (dB/m) + Reading(dBuV).

2.Correction factor (dB/m) = Antenna Factor (dB/m) + Cable loss (dB) – Pre-Amplifier gain (dB).

3.When the peak results are less than average limit, so not need to evaluate the average.



Standard:	FCC Part 15.247	Test Distance:	3m
Test item:	Band edge	Power:	AC 120V/60Hz
Frequency:	2402MHz	Temp.(°C)/Hum.(%RH):	26(°C)/60%RH
Mode:	Mode 4		
Ant.Polar.:	Horizontal		

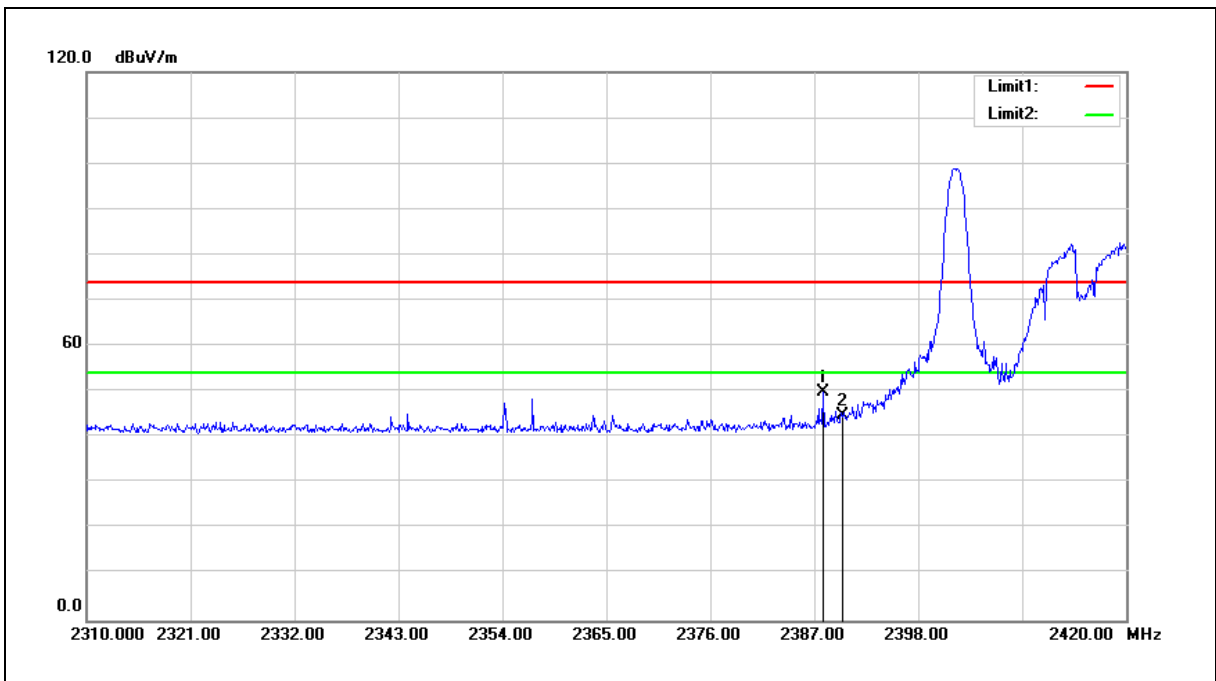

No.	Frequency (MHz)	Reading (dBuV)	Correct Factor (dB/m)	Result (dBuV/m)	Limit (dBuV/m)	Margin (dB)	Remark
1	2387.880	59.73	-9.64	50.09	74.00	-23.91	peak
2	2390.000	54.54	-9.62	44.92	74.00	-29.08	peak

Note:1.Result (dBuV/m) = Correct Factor (dB/m) + Reading(dBuV).

2.Correction factor (dB/m) = Antenna Factor (dB/m) + Cable loss (dB) – Pre-Amplifier gain (dB).

3.When the peak results are less than average limit, so not need to evaluate the average.



Standard:	FCC Part 15.247	Test Distance:	3m
Test item:	Band edge	Power:	AC 120V/60Hz
Frequency:	2402MHz	Temp.(°C)/Hum.(%RH):	26(°C)/60%RH
Mode:	Mode 4		
Ant.Polar.:	Vertical		

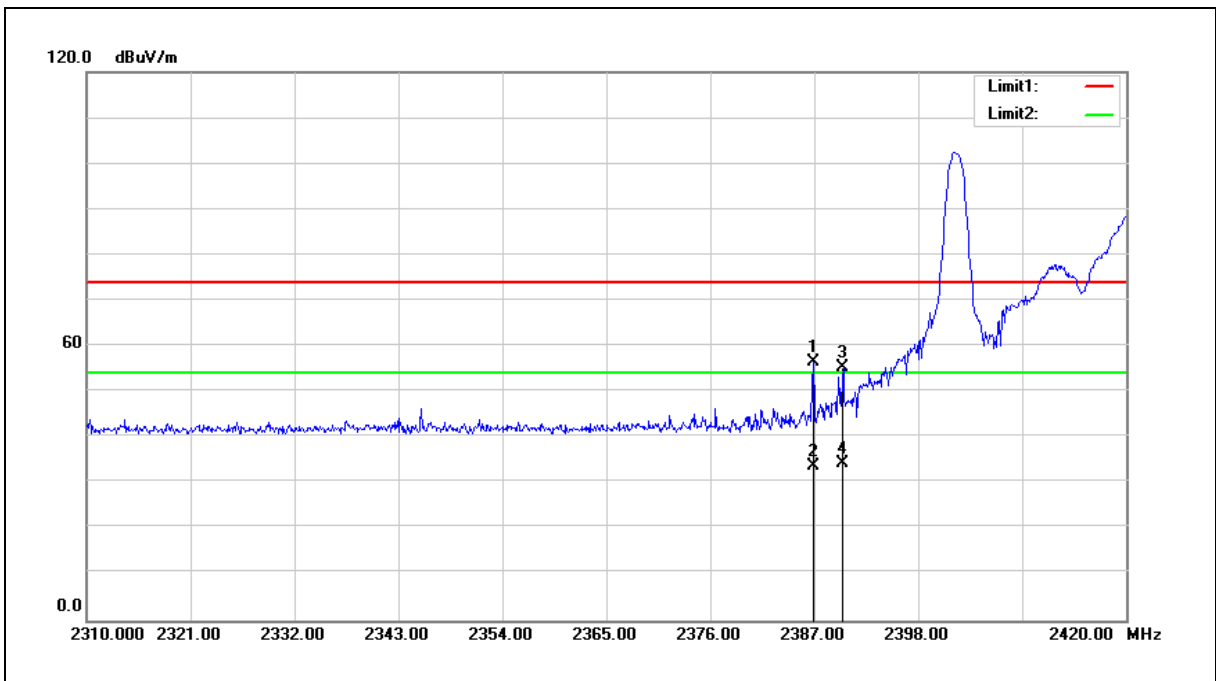

No.	Frequency (MHz)	Reading (dBuV)	Correct Factor (dB/m)	Result (dBuV/m)	Limit (dBuV/m)	Margin (dB)	Remark
1	2386.890	66.10	-9.64	56.46	74.00	-17.54	peak
2	2386.890	43.37	-9.64	33.73	54.00	-20.27	AVG
3	2390.000	65.04	-9.62	55.42	74.00	-18.58	peak
4	2390.000	43.86	-9.62	34.24	54.00	-19.76	AVG

Note:1.Result (dBuV/m) = Correct Factor (dB/m) + Reading(dBuV).

2.Correction factor (dB/m) = Antenna Factor (dB/m) + Cable loss (dB) – Pre-Amplifier gain (dB).

3.When the peak results are less than average limit, so not need to evaluate the average.



Standard:	FCC Part 15.247	Test Distance:	3m
Test item:	Band edge	Power:	AC 120V/60Hz
Frequency:	2480MHz	Temp.(°C)/Hum.(%RH):	26(°C)/60%RH
Mode:	Mode 4		
Ant.Polar.:	Horizontal		

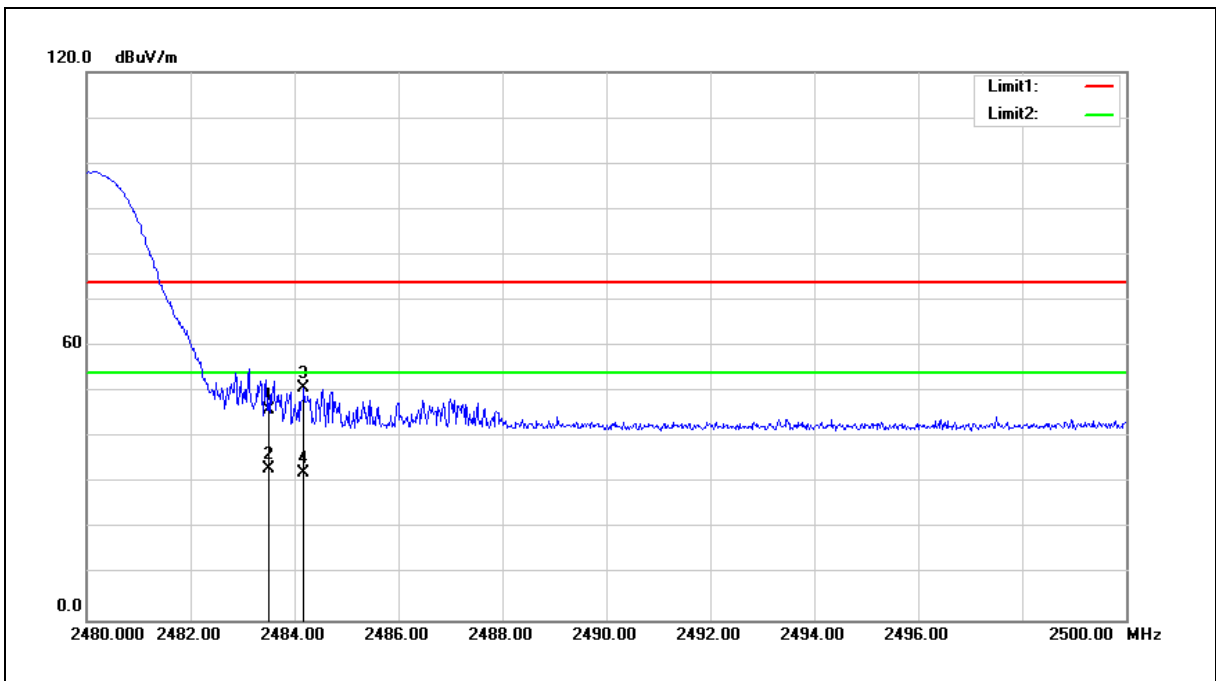

No.	Frequency (MHz)	Reading (dBuV)	Correct Factor (dB/m)	Result (dBuV/m)	Limit (dBuV/m)	Margin (dB)	Remark
1	2483.500	55.12	-9.20	45.92	74.00	-28.08	peak
2	2483.500	42.46	-9.20	33.26	54.00	-20.74	AVG
3	2484.180	59.96	-9.20	50.76	74.00	-23.24	peak
4	2484.180	41.33	-9.20	32.13	54.00	-21.87	AVG

Note:1.Result (dBuV/m) = Correct Factor (dB/m) + Reading(dBuV).

2.Correction factor (dB/m) = Antenna Factor (dB/m) + Cable loss (dB) – Pre-Amplifier gain (dB).

3.When the peak results are less than average limit, so not need to evaluate the average.



Standard:	FCC Part 15.247	Test Distance:	3m
Test item:	Band edge	Power:	AC 120V/60Hz
Frequency:	2480MHz	Temp.(°C)/Hum.(%RH):	26(°C)/60%RH
Mode:	Mode 4		
Ant.Polar.:	Vertical		

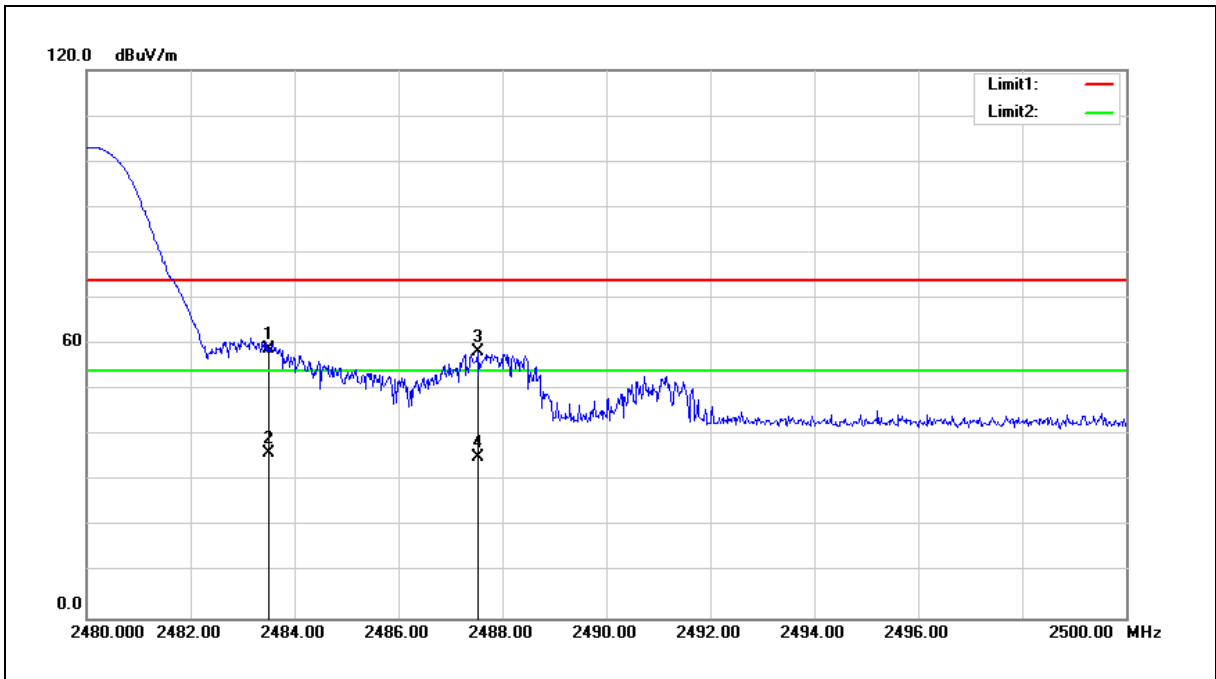

No.	Frequency (MHz)	Reading (dBuV)	Correct Factor (dB/m)	Result (dBuV/m)	Limit (dBuV/m)	Margin (dB)	Remark
1	2483.500	68.10	-9.20	58.90	74.00	-15.10	peak
2	2483.500	45.36	-9.20	36.16	54.00	-17.84	AVG
3	2487.520	67.47	-9.19	58.28	74.00	-15.72	peak
4	2487.520	44.29	-9.19	35.10	54.00	-18.90	AVG

Note:1.Result (dBuV/m) = Correct Factor (dB/m) + Reading(dBuV).

2.Correction factor (dB/m) = Antenna Factor (dB/m) + Cable loss (dB) – Pre-Amplifier gain (dB).

3.When the peak results are less than average limit, so not need to evaluate the average.