



ZHIYUN Professional Stabilizer with
Image Transmission WEEBILL LAB

Quick Start Guide

Quick Start Guide

Download ZY Play



"ZY Play" is an integrated part of the gimbal. Please make sure to download it on your phone. Search "ZY Play" in APP Store or Google Play or directly scan the QR code on the left to download (Android 5.0 above or iOS 9.0 above required).

Read Complete User Guide

To protect the environment and reduce resource consumption, we now offer you a paper version of Quick Start Guide instead of Complete User Guide. Before using this product, you can read the Complete User Guide through one of the three following ways.

1. Scan the QR code on the right side by applying the mobile browser scan code function.
2. Click the ② icon on the top right corner of starting page of the corresponding product in "ZY Play".
3. Log in to the official website of ZHIYUN www.zhiyun-tech.com to download.



Quick Start Guide

Quick Start Guide

By following the steps below you can experience the basic performance of WEEBILL LAB quickly. Before you start using WEEBILL LAB, be sure to read the Complete User Guide carefully.

1.Installation

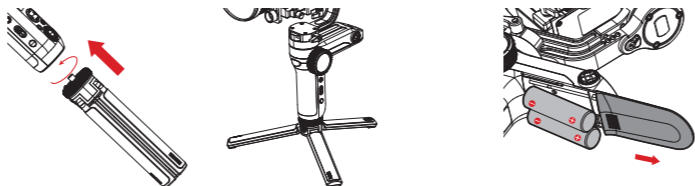

- Get the tripod ready and mount it to the 1/4"-3/8" threaded hole at the bottom of the stabilizer, then unfold the tripod on a flat surface.

- Slide out the cover of the battery compartment and load two original 18650 lithium batteries (note the positive and negative directions).

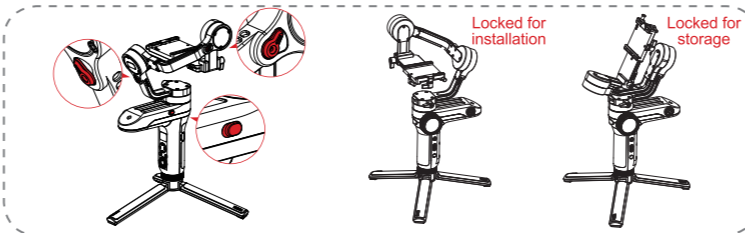

- Each axis of the gimbal is equipped with a latch. You can use these latches to lock the axes for convenient installation and storage.

Quick Start Guide

Quick Start Guide



- Camera Mounting
 - ① Take out the quick release plate module and press the lock to take out the quick release plate.
 - ② Mount the camera on the backing base as above, then mount it on the quick-release plate and tighten the 1/4" screw at its bottom.
 - ③ Adjust the lens holder on the quick release plate to support the lens and ensure it is stable.
 - ④ Mount the quick release plate with the camera on it into the quick release module, and then install and lock the whole module on the three-axis stabilizer.

1. Before mounting the camera, make sure it is prepared ahead of time. Remove the lens cap and make sure the camera's battery and memory card are already inserted.
2. The backing base is needed when the size of the lens is larger than that of the bottom of the camera. You can decide whether to install the backing base according to the actual situation.

2.Balance Adjustment

- To facilitate the adjustment procedure, we recommend locking the three axes before the adjustment and unlock and adjust them one by one.

- Unlock the tilt axis and the camera locking latch, push the camera to move forward or backward until the camera can stay still and almost level with its lens facing front (as shown on the right). Complete this step by tightening up the camera mounting thumb screw.

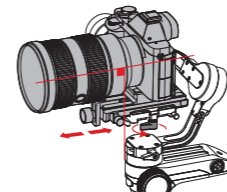

Quick Start Guide

Quick Start Guide

- Make the lens face up, slightly loosen the thumb screw of the tilt axis, push the camera to move forward or backward until the camera can stay still with the lens facing up (i.e.the camera stays still and vertical to the ground as shown on the right). Complete this step by tightening up thumb screw.

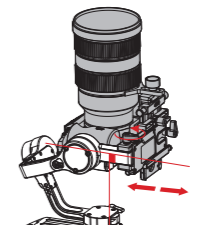

- Unlock the roll axis, slightly loosen the thumb screw of it, push the camera to move left or right until the camera can stay still and horizontal to the ground (as shown on the right). Complete this step by tightening up thumb screw.

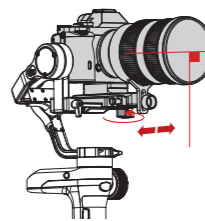

- Unlock the pan axis, slightly loosen the thumb screw on it, then adjust the pan axis until it stays still and horizontal to the ground (as shown on the right). Complete this step by tightening up thumb screw.

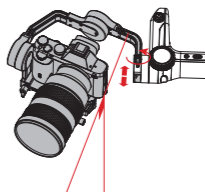

Quick Start Guide

Quick Start Guide

3.Turn On/Turn Off

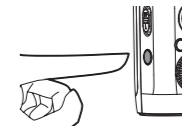

Press and hold the power button for three seconds to turn on or turn off the stabilizer.

4.Basic Operation

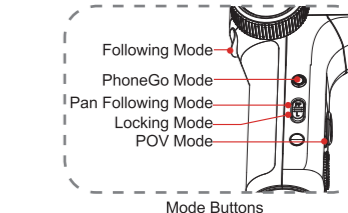

Mode Buttons

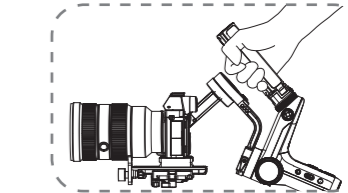

Underslung

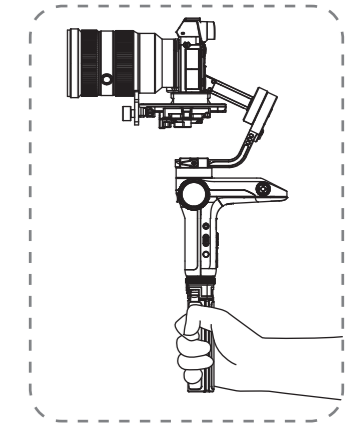

Upright

5.Connecting “ZY Play” APP

1. Connect the stabilizer and the camera with the corresponding cable. Power on the stabilizer and activate Bluetooth and WIFI.
2. Open “ZY Play” App, and click “Please connect device”. Choose your stabilizer to connect. Click on the WIFI icon or go to the setting of your phone to connect your phone with the stabilizer via WIFI.

▲ Paired with the professional WEEBILL LAB customized APP “ZY Play”, you can use the image transmission and other functions of the stabilizer. Please refer to Complete User Guide for the specific usage.

💡 Search and follow “Zhiyun Tech” on Facebook, Instagram, Twitter, YouTube and Vimeo to connect with us.

Thank you for purchasing ZHIYUN WEEBILL LAB. The information contains herein affects your safety, legitimate rights and obligation. Please read this instruction carefully to ensure proper configuration before use. Failure to read and follow this instruction and warnings herein may result in serious injury to you or bystanders, or damage to your device or property. Guilin Zhishen Information Technology Co., Ltd. reserves all rights for final explanation on this instruction and other documents related to WEEBILL LAB. The information is subject to update without notice. Please visit www.zhiyun-tech.com to obtain the latest product information.

By using this product, you hereby signify that you have read this document carefully and that you understand and agree to abide by the terms and conditions herein. You agree that you are solely responsible for your own conduct while using this product, and for any consequences thereof. You agree to use this product only for purposes that are proper and in accordance with all terms, precautions, practices, policies and guidelines ZHIYUN has made and may make available.

ZHIYUN accepts no liability for damage, injury or any legal responsibility incurred directly or indirectly from the use of this product. Users shall observe safe and lawful practices including, but not limited to, those set forth herein.

ZHIYUN™ is the trademark of Guilin Zhishen Information Technology Co., Ltd. (hereinafter referred to as “ZHIYUN” or “ZHIYUN TECH”) and its affiliates. All product names or marks referred to hereunder are trademarks or registered trademarks of their respective holders.

Reading Tips

Legends: **💡** Hints and Tips **▲** Important

Warnings

Read the ENTIRE User Guide to become familiar with the features of this product before operating. Failure to operate the product correctly can result in damage to the product or personal property and cause serious injury. This is a sophisticated product. It must be operated with caution and common sense and requires some basic mechanical ability. Failure to operate this product in a safe and responsible manner could result in injury or damage to the product or other property. This product is not intended for use by children without direct adult supervision. DO NOT use with incompatible components or in any way otherwise as mentioned or instructed in the product documents provided by ZHIYUN. The safety guidelines herein contain instructions for safety, operation and maintenance. It is essential to read and follow all of the instructions and warnings in the User Guide, prior to assembly, setup or use, in order to operate the product correctly and avoid damage or serious injury.

Safe Operation Guidelines

■ CAUTION:

1. WEEBILL LAB is a high-precision control device. Damage may be caused to WEEBILL LAB if it is dropped or subject to external force, and this may result in malfunction.
2. Make sure the rotation of the gimbal axes is not blocked by external force when WEEBILL LAB is turned on.
3. WEEBILL LAB is not waterproof. Prevent contacts of any kind of liquid or cleaner with WEEBILL LAB. It is recommended to use dry cloth for cleaning.
4. Protect WEEBILL LAB from dust and sand during use.

■ WARNING

To avoid fire, serious injury, and property damage, observe the following safety guidelines when using, charging, or storing your batteries.

Battery Use

1. Prevent the batteries to come into contact with any kind of liquid. Do not leave batteries out in the rain or near a source of moisture. Do not drop the battery into water. If the inside of the battery comes into contact with water, chemical decomposition may occur, potentially resulting in the battery catching on fire, and may even lead to an explosion.
2. If the battery falls into water with the stabilizer during use, take it out immediately and put it in a safe and open area. Maintain a safe distance from the battery until it is completely dry. Never use the battery again, and dispose of the battery properly as described in the Battery Disposal section below.
3. If the battery catches fire, use water, water spray, sand, fire blanket, dry powder, or carbon dioxide fire extinguisher immediately to put out the fire. Battery-caused fire may lead to explosion. Please extinct the fire by applying the methods recommended above according to the actual situation.
4. Never use non-ZHIYUN batteries. If replacement or backup is needed, please purchase new batteries from ZHIYUN's official website or authorized channels. ZHIYUN takes no responsibility for any damage caused by non-ZHIYUN batteries.
5. Never use or charge swollen, leaky, or damaged batteries. Never use or charge if the battery smells, or overheats (exceeding maximum temperature of 160°F / 71°C). If your batteries are abnormal, contact ZHIYUN or a ZHIYUN authorized dealer for further assistance.
6. The battery should be used within the temperature range from -10°C to 45°C. Use of battery in environments above 45°C may lead to a fire or explosion. Use of battery below -10°C may lead to serious battery damage.
7. Do not use the battery in strong electrostatic or electromagnetic environments. Otherwise, the battery protection board may malfunction.
8. Do not disassemble or use any sharp object to puncture the battery in any way. Otherwise, the battery may leak, catch fire or explode.
9. Do not mechanically strike, crush, or throw the battery. Do not place heavy objects on the battery or charger.
10. Electrolytes inside the battery are highly corrosive. In case of accidental contact of any electrolytes with your skin or eyes, rinse immediately with water for at least 15 minutes and seek medical advice as soon as possible.
11. Do not use the battery if it has been involved in a crash or heavy impact.
12. Do not heat the battery and never put the battery in a microwave oven or in a pressurized container.
13. Do not place the battery on a conductive surface (such as a metal desk surface, eye-glasses, watch, jewelry, etc.)
14. Prevent use of wires or other metal objects that could cause positive and negative short-circuit to the battery.
15. If the battery terminal is dirty, wipe it with a clean, dry cloth. Otherwise it will cause a bad battery connection, which may result in energy loss or charging failure.

Battery Charging

1. The battery will automatically stop charging once it is full. Please disconnect the battery and the charger when fully charged.
2. Do not attach the batteries to a wall outlet or car charger socket directly. Always use a ZHIYUN approved adapter for charging. ZHIYUN takes no responsibility if the battery is charged using a non-ZHIYUN charger.
3. Do not put the battery and charger near flammable materials or on flammable surfaces (such as carpet or wood). Never leave the battery unattended during charging to prevent any accident.
4. Do not charge the battery immediately after use, because the battery temperature may be too high. Do not charge the battery until it cools down to normal room temperature. Charging the battery with its temperature over 45°C or lower than 0°C may lead to leakage, overheating, or damage.
5. Examine the charger before use, make sure there is no damage to the enclosure, cord, plug, or other parts. Never use a damaged charger. Do not clean the charger with any liquid containing alcohol or other flammable solvents. Disconnect the charger when not in use.

Battery Storage

1. Keep batteries out of the reach of children and pets.
2. Do not leave the battery near heat sources such as a furnace or heater, or inside of a vehicle on hot days. Never expose the battery in any environment with temperature of over 60°C. The ideal storage temperature is 22°C-28°C.
3. Store batteries in a dry environment.
4. Do not leave the battery unused for too long after it has been completely discharged to prevent over-discharge of battery which may result in battery damage and permanent failure.

Battery Maintenance

1. Do not over-charge or over-discharge the battery, which will damage the battery;
2. The battery performance will be affected for not being used for a long time;
3. Never use the battery when the temperature is too high or too low;
4. Do not store the battery in any environment with a temperature of over 60°C.

Battery Disposal

1. Please fully discharge the battery before putting it in the designated recycling bin. Batteries contain hazardous constituents and it is forbidden to put the battery in general waste bin. For related details please abide by the local laws and regulations on battery recycling and disposal.
2. If the battery cannot be fully discharged, never put it in battery recycling bin. Please contact battery recycling companies for a proper solution.

FCC Statement

Any changes or modifications not expressly approved by the party responsible for compliance could void the user's authority to operate this equipment.

This device complies with Part 15 of the FCC Rules. Operation is subject to the following two conditions:

1. This device may not cause harmful interference,
2. this device must accept any interference received, including interference that may cause undesired operation.

Note: This equipment has been tested and found to comply with the limits for a Class B digital device, pursuant to part 15 of the FCC Rules. These limits are designed to provide reasonable protection against harmful interference in a residential installation. This equipment generates, uses and can radiate radio frequency energy and, if not installed and used in accordance with the instructions, may cause harmful interference to radio communications. However, there is no guarantee that interference will not occur in a particular installation. If this equipment does cause harmful interference to radio or television reception, which can be determined by turning the equipment off and on, the user is encouraged to try to correct the interference by one or more of the following measures:

- Reorient or relocate the receiving antenna.
- Increase the separation between the equipment and receiver.
- Connect the equipment into an outlet on a circuit different from that to which the receiver is connected.
- Consult the dealer or an experienced radio/TV technician for help.

FCC Radiated Exposure Statement: This device complies with FCC radiated exposure limits set forth for an uncontrolled environment.

This transmitter must not be co-located operating in conjunction with any other antenna or transmitter.

Please do not put any metal substance like coin when charging. It can cause product damage and serious burns.

Warranty Period

1. Customers are entitled to replacement or free repair service in case of quality defect(s) found in the product within 15 days upon receipt of the product.
2. Customers are entitled to free repair service from ZHIYUN for any product proven defective in material or workmanship that results in product failure during normal consumer usage and conditions within the valid warranty period, which is 12 months counting from the date of selling.
3. Some states or countries do not allow limitations on how long an implied warranty lasts, so the above warranty term may not apply to you.

This warranty does not apply to the followings

1. Products subjected to unauthorized repair, misuse, collision, neglect, mishandling, soaking, accident, and unauthorized alteration.
2. Products subjected to improper use or whose labels or security tags have been torn off or altered.
3. Products whose warranty has expired.
4. Products damaged due to force majeure, such as fire, flood, lightning, etc.

Warranty Claim Procedure

1. If failure or any problem occurs to your product after purchase, please contact a local agent for assistant, or you can always contact ZHIYUN's customer service through email at service@zhiyun-tech.com or website at www.zhiyun-tech.com.
2. Your local agent or ZHIYUN's customer service will guide you through the whole service procedure regarding any product issue or problem you have encountered. ZHIYUN reserves the right to reexamine damaged or returned products.

Tel: +86-773-2320856

USA Hotline: +1 808-319-6137, 9:00-18:00 GMT-7, Mon-Fri

Europe Hotline: 0031-297303057, 10:00-17:00 GMT+1, Mon-Fri

Web: www.zhiyun-tech.com

E-mail: service@zhiyun-tech.com

Address: 6th floor Building No.13 Creative Industrial Park, GuiMo Road, Qixing District, Guilin

Product model: CR104

Customer information

Customer Name : _____ Contact No : _____

Address : _____

Sales Information

Sales Date : _____ Prod. Serial No : _____

Dealer : _____

Contact No : _____

#1 Maintenance Record

Service Date : _____ Signature of Repairman : _____

Cause of Problem : _____

Service Result : Solved Unsolved Refunded (Replaced)



Please download the latest version from www.zhiyun-tech.com. This document is subject to change without notice. ZHIYUN™ is a trademark of ZHISHEN. Copyright © 2018 ZHISHEN. All rights reserved.