

TEST REPORT

FCC ID: 2AIGYD18T

Product: TPMS

Model No.: D18T

Additional Model: N/A

Trade Mark: N/A

Report No.: TCT161028E002

Issued Date: Nov. 07, 2016

Issued for:

Dongguan Saftire Auto Safety Technology Co., Ltd
1, 3rd Floor, Small technology companies Pioneer Park, Songshan Lake,
Dongguan City, Gangdong Province, China

Issued By:

Shenzhen Tongce Testing Lab.
1F, Leinuo Watch Building, Fuyong Town, Baoan Dist, Shenzhen, China
TEL: +86-755-27673339
FAX: +86-755-27673332

Note: This report shall not be reproduced except in full, without the written approval of Shenzhen Tongce Testing Lab.

This document may be altered or revised by Shenzhen Tongce Testing Lab. personnel only, and shall be noted in the revision section of the document. The test results in the report only apply to the tested sample.

TABLE OF CONTENTS

1. Test Certification..... 3

2. Test Result Summary 4

3. EUT Description 5

4. Genera Information..... 6

 4.1. Test Environment and Mode 6

 4.2. Description of Support Units 6

5. Facilities and Accreditations 7

 5.1. Facilities 7

 5.2. Location 7

 5.3. Measurement Uncertainty 7

6. Test Results and Measurement Data 8

 6.1. Antenna Requirement..... 8

 6.2. Conducted Emission..... 9

 6.3. Radiated Emission Measurement..... 10

 6.4. Occupied Bandwidth..... 17

 6.5. Duration Time 19

Appendix A: Photographs of Test Setup

Appendix B: Photographs of EUT

1. Test Certification

Product:	TPMS
Model No.:	D18T
Additional Model:	N/A
Applicant:	Dongguan Saftire Auto Safety Technology Co., Ltd
Address:	1, 3rd Floor, Small technollgy companies Pioneer Park, Songshan Lake, Dongguan City, Gangdong Province, China
Manufacturer:	Dongguan Saftire Auto Safety Technology Co., Ltd
Address:	1, 3rd Floor, Small technollgy companies Pioneer Park, Songshan Lake, Dongguan City, Gangdong Province, China
Date of Test:	Oct. 28 – Nov. 04, 2016
Applicable Standards:	FCC CFR Title 47 Part 15 Subpart C Section 15.231

The above equipment has been tested by Shenzhen Tongce Testing Lab. and found compliance with the requirements set forth in the technical standards mentioned above. The results of testing in this report apply only to the product/system, which was tested. Other similar equipment will not necessarily produce the same results due to production tolerance and measurement uncertainties.

Tested By:

Garen

Date:

Nov. 04, 2016

Reviewed By:

Joe Zhou

Date:

Nov. 07, 2016

Approved By:

Tomsin

Date:

Nov. 07, 2016

2. Test Result Summary

Requirement	CFR 47 Section	Result
Conduction Emission, 0.15MHz to 30MHz	§15.207	N/A
Duration Time	§15.231(e)	PASS
Radiation Emission	§15.231(e), §15.205, §15.209, §15.35	PASS
Occupied Bandwidth	§15.231(c)	PASS

Note:

1. PASS: Test item meets the requirement.
2. Fail: Test item does not meet the requirement.
3. N/A: Test case does not apply to the test object.
4. The test result judgment is decided by the limit of test standard.

3. EUT Description

Product Name:	TPMS
Model :	D18T
Additional Model:	N/A
Trade Mark:	N/A
Operation Frequency:	433.92MHz
Modulation Technology:	FSK
Antenna Type:	Internal Spring Antenna
Antenna Gain:	0dBi
Power Supply:	DC 24V or DC 3.7V Rechargeable Li-ion battery

4. Genera Information

4.1. Test Environment and Mode

Operating Environment:	
Temperature:	24.0 °C
Humidity:	54 % RH
Atmospheric Pressure:	1010 mbar
Test Mode:	
Operation mode:	Keep the EUT in continuous transmitting with modulation
<p>The sample was placed (0.8m below 1GHz, 1.5m above 1GHz) above the ground plane of 3m chamber. Measurements in both horizontal and vertical polarities were performed. During the test, each emission was maximized by: having the EUT continuously working, investigated all operating modes, rotated about all 3 axis (X, Y & Z) and considered typical configuration to obtain worst position, manipulating interconnecting cables, rotating the turntable, varying antenna height from 1m to 4m in both horizontal and vertical polarizations. The emissions worst-case are shown in Test Results of the following pages.</p>	

4.2. Description of Support Units

The EUT has been tested as an independent unit together with other necessary accessories or support units. The following support units or accessories were used to form a representative test configuration during the tests.

Equipment	Model No.	Serial No.	FCC ID	Trade Name
Sensor	VS-62U009	/	ZPNVS62U009	Cud

Note:

1. All the equipment/cables were placed in the worst-case configuration to maximize the emission during the test.
2. Grounding was established in accordance with the manufacturer's requirements and conditions for the intended use.
3. The only transmitter (i.e. Sensor) that is approved to work with this repeater is FCC ID: ZPNVS62U009. And the transmitters with its maximum transmit power to the repeater.

5. Facilities and Accreditations

5.1. Facilities

The test facility is recognized, certified, or accredited by the following organizations:

- FCC - Registration No.: 572331

Shenzhen Tongce Testing Lab

The 3m Semi-anechoic chamber has been registered and fully described in a report with the (FCC) Federal Communications Commission. The acceptance letter from the FCC is maintained in our files.

- IC - Registration No.: 10668A-1

The 3m Semi-anechoic chamber of Shenzhen TCT Testing Technology Co., Ltd. has been registered by Certification and Engineering Bureau of Industry Canada for radio equipment testing

- CNAS - Registration No.: CNAS L6165

Shenzhen TCT Testing Technology Co., Ltd. is accredited to ISO/IEC 17025:2005 General Requirements for the Competence of Testing and Calibration laboratories for the competence of testing. The Registration No. is CNAS L6165.

5.2. Location

Shenzhen Tongce Testing Lab

Address: 1F, Leinuo Watch Building, Fuyong Town, Baoan Dist, Shenzhen, China

Tel: 86-755-36638142

5.3. Measurement Uncertainty

The reported uncertainty of measurement $y \pm U$, where expanded uncertainty U is based on a standard uncertainty multiplied by a coverage factor of $k=2$, providing a level of confidence of approximately 95 %.

No.	Item	MU
1	Conducted Emission	$\pm 2.56\text{dB}$
2	RF power, conducted	$\pm 0.12\text{dB}$
3	Spurious emissions, conducted	$\pm 0.11\text{dB}$
4	All emissions, radiated(<1G)	$\pm 3.92\text{dB}$
5	All emissions, radiated(>1G)	$\pm 4.28\text{dB}$
6	Temperature	$\pm 0.1^\circ\text{C}$
7	Humidity	$\pm 1.0\%$

6. Test Results and Measurement Data

6.1. Antenna Requirement

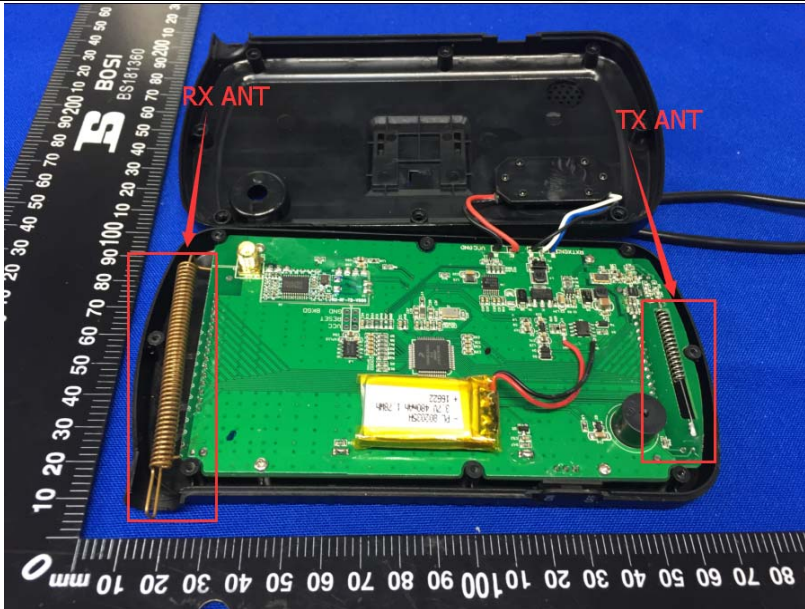
Standard requirement:	FCC Part15 C Section 15.203 /247(c)
<p>15.203 requirement: An intentional radiator shall be designed to ensure that no antenna other than that furnished by the responsible party shall be used with the device. The use of a permanently attached antenna or of an antenna that uses a unique coupling to the intentional radiator, the manufacturer may design the unit so that a broken antenna can be replaced by the user, but the use of a standard antenna jack or electrical connector is prohibited.</p>	
E.U.T Antenna:	
<p>The antenna is an internal Spring antenna which permanently attached, and the best case gain of the antenna is 0dBi.</p>	
	

6.2. Conducted Emission

6.2.1. Test Specification

Test Requirement:	FCC Part15 C Section 15.207														
Test Method:	ANSI C63.4:2014														
Frequency Range:	150 kHz to 30 MHz														
Receiver setup:	RBW=9 kHz, VBW=30 kHz, Sweep time=auto														
Limits:	<table border="1"> <thead> <tr> <th rowspan="2">Frequency range (MHz)</th> <th colspan="2">Limit (dBuV)</th> </tr> <tr> <th>Quasi-peak</th> <th>Average</th> </tr> </thead> <tbody> <tr> <td>0.15-0.5</td> <td>66 to 56*</td> <td>56 to 46*</td> </tr> <tr> <td>0.5-5</td> <td>56</td> <td>46</td> </tr> <tr> <td>5-30</td> <td>60</td> <td>50</td> </tr> </tbody> </table>	Frequency range (MHz)	Limit (dBuV)		Quasi-peak	Average	0.15-0.5	66 to 56*	56 to 46*	0.5-5	56	46	5-30	60	50
Frequency range (MHz)	Limit (dBuV)														
	Quasi-peak	Average													
0.15-0.5	66 to 56*	56 to 46*													
0.5-5	56	46													
5-30	60	50													
Test Setup:	<p><i>Remark</i> E.U.T: Equipment Under Test LISN: Line Impedance Stabilization Network Test table height=0.8m</p>														
Test Mode:	Transmitting Mode														
Test Procedure:	<ol style="list-style-type: none"> 1. The E.U.T and simulators are connected to the main power through a line impedance stabilization network (L.I.S.N.). This provides a 50ohm/50uH coupling impedance for the measuring equipment. 2. The peripheral devices are also connected to the main power through a LISN that provides a 50ohm/50uH coupling impedance with 50ohm termination. (Please refer to the block diagram of the test setup and photographs). 3. Both sides of A.C. line are checked for maximum conducted interference. In order to find the maximum emission, the relative positions of equipment and all of the interface cables must be changed according to ANSI C63.4: 2014 on conducted measurement. 														
Test Result:	N/A; The EUT is powered by car's power DC 24V, So not applicable.														

6.3. Radiated Emission Measurement

6.3.1. Test Specification

Test Requirement:	FCC Part15 C Section 15.231(a) and 15.209				
Test Method:	ANSI C63.4: 2014 and ANSI C63.10:2013				
Frequency Range:	9 kHz to 5 GHz				
Measurement Distance:	3 m				
Antenna Polarization:	Horizontal & Vertical				
Receiver Setup:	Frequency	Detector	RBW	VBW	Remark
	9kHz- 150kHz	Quasi-peak	200Hz	1kHz	Quasi-peak Value
	150kHz- 30MHz	Quasi-peak	9kHz	30kHz	Quasi-peak Value
	30MHz-1GHz	Quasi-peak	100KHz	300KHz	Quasi-peak Value
	Above 1GHz	Peak	1MHz	3MHz	Peak Value
Peak		1MHz	10Hz	Average Value	
	<ol style="list-style-type: none"> The EUT was placed on the top of a rotating table 0.8 meters above the ground at a 3 meter camber in below 1GHz, 1.5m above the ground in above 1GHz. The table was rotated 360 degrees to determine the position of the highest radiation. The EUT was set 3 meters away from the interference-receiving antenna, which was mounted on the top of a variable-height antenna tower. The antenna height is varied from one meter to four meters above the ground to determine the maximum value of the field strength. Both horizontal and vertical polarizations of the antenna are set to make the measurement. For each suspected emission, the EUT was arranged to its worst case and then the antenna was tuned to heights from 1 meter to 4 meters and the rotatable table was turned from 0 degrees to 360 degrees to find the maximum reading. The test-receiver system was set to Peak Detect Function and Specified Bandwidth with Maximum Hold Mode. If the emission level of the EUT in peak mode was 10dB lower than the limit specified, then testing could be stopped and the peak values of the EUT would be reported. Otherwise the emissions that did not have 10dB margin would be re-tested one by one using peak, quasi-peak or average method as specified and then reported in a data sheet. 				

Test setup:

For radiated emissions below 30MHz

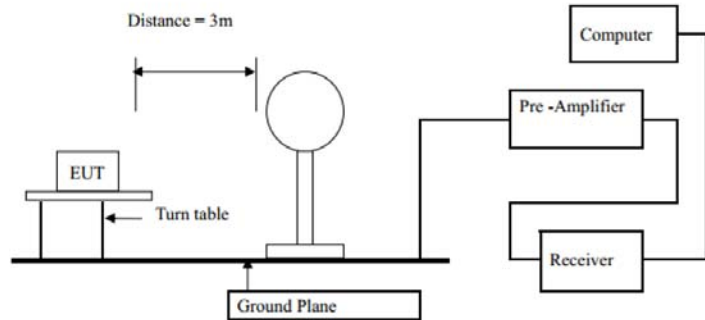

30MHz to 1GHz

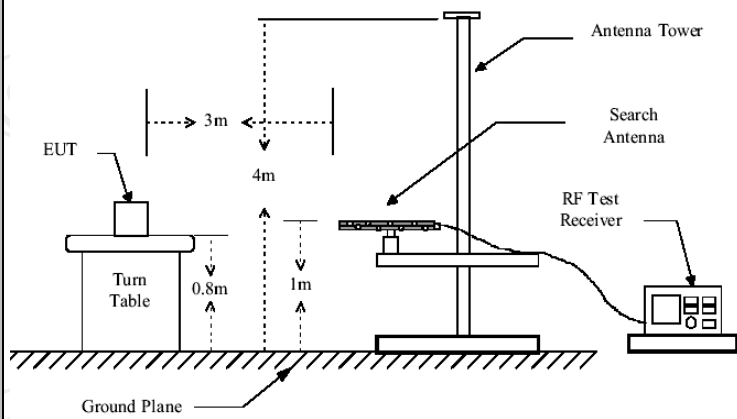

Above 1GHz

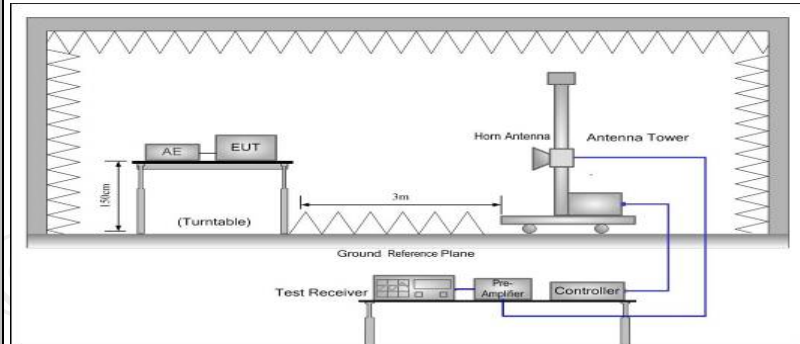

Test Mode:

Transmitting Mode

Test results:

PASS

6.3.2. Limit

Fundamental Frequency (MHz)	Filed Strength of Fundamental (microvolts/meter)	Filed Strength of Spurious Emission (microvolts/meter)
40.66-40.70	1000	100
70-130	500	50
130-174	500 to 1500*	50 to 150*
174-260	1500	150
260-470	1500 to 5000*	150 to 500*
Above 470	5000	500
Horn Antenna	Schwarzbeck	BBHA 9120D

*Linear interpolations

[Where F is the frequency in MHz, the formulas for calculating the maximum permitted fundamental field strengths are as follows:

For the band 130-174 MHz, $\mu\text{V/m}$ at 3 meters = $56.81818(F) - 6136.3636$;

for the band 260-470 MHz, $\mu\text{V/m}$ at 3 meters = $41.6667(F) - 7083.3333$. The maximum permitted unwanted emission level is 20 dB below the maximum permitted fundamental level.]

For EUT

Fundamental Frequency (MHz)	Filed Strength of Fundamental (microvolts/meter)	Filed Strength of Spurious Emission(dB $\mu\text{V/m}$)
433.92	72.87	52.87

Note:

1. Intentional radiators operating under the provisions of this Section shall demonstrate compliance with the limits on the field strength of emissions, as shown in the above table, based on the average value of the measured emissions.
2. According to 15.35, on any frequency or frequencies below or equal to 1000 MHz, the limits shown are based on measuring equipment employing a CISPR quasi-peak detector function and related measurement bandwidths, unless otherwise specified the limit on peak radio frequency emissions is 20dB above the maximum permitted average emission limit applicable to the equipment under test.
3. According to 15.231(b), The limits on the field strength of the spurious emissions in the above table is based on the fundamental frequency of the intentional radiator. Spurious emissions shall be attenuated to the average (or, alternatively, CISPR quasi-peak) limits shown in this table or to the general limits shown in Section 15.209, whichever limit permits one higher field strength.

Frequencies in restricted band are complied to limit on Paragraph 15.209

Frequency Range (MHz)	Distance (m)	Field strength (dB μ V/m)
0.009-0.490	3	20log 2400/F (kHz) + 80
0.490-1.705	3	20log 24000/F (kHz) + 40
1.705-30	3	20log 30 + 40
30-88	3	40.0
88-216	3	43.5
216-960	3	46.0
Above 960	3	54.0

Note:

1. RF Voltage (dBuV) = 20 log RF Voltage (μ V)
2. In the Above Table, the tighter limit applies at the band edges.
3. Distance refers to the distance in meters between the measuring instrument antenna and the EUT
4. The radiated emissions should be tested under 3-axes position (Lying, Side, and Stand), After pre-test. It was found that the worse radiated emission was get at the lying position.
5. If measurement is made at 3m distance, then F.S Limitation at 3m distance is adjusted by using the formula $Ld1 = Ld2 * (d2/d1)$

6.3.3. Test Instruments

Radiated Emission Test Site (966)				
Name of Equipment	Manufacturer	Model	Serial Number	Calibration Due
ESPI Test Receiver	ROHDE&SCHWARZ	ESVD	100008	Aug. 11, 2017
Spectrum Analyzer	ROHDE&SCHWARZ	FSEM	848597/001	Aug. 11, 2017
Pre-amplifier	EM Electronics Corporation CO.,LTD	EM30265	07032613	Aug. 11, 2017
Pre-amplifier	HP	8447D	2727A05017	Aug. 11, 2017
Loop antenna	ZHINAN	ZN30900A	12024	Aug. 13, 2017
Broadband Antenna	Schwarzbeck	VULB9163	340	Aug. 13, 2017
Horn Antenna	Schwarzbeck	BBHA 9120D	631	Aug. 13, 2017
Coax cable	TCT	N/A	N/A	Aug. 12, 2017
Coax cable	TCT	N/A	N/A	Aug. 12, 2017
Coax cable	TCT	N/A	N/A	Aug. 12, 2017
Coax cable	TCT	N/A	N/A	Aug. 12, 2017
EMI Test Software	Shurple Technology	EZ-EMC	N/A	N/A

Note: The calibration interval of the above test instruments is 12 months and the calibrations are traceable to international system unit (SI).

6.3.4. Test Data

Duty Cycle Test Data:

Total time one cycle(ms)	Effective time one cycle(ms)	Duty Cycle	AV Factor(dB)
513.53	95.26	0.742	-2.59

Note: Effective time one cycle=91.83
 Duty Cycle= Effective time one cycle/ Total time one cycle=0.742
 AV Factor = 20 log(Duty Cycle)

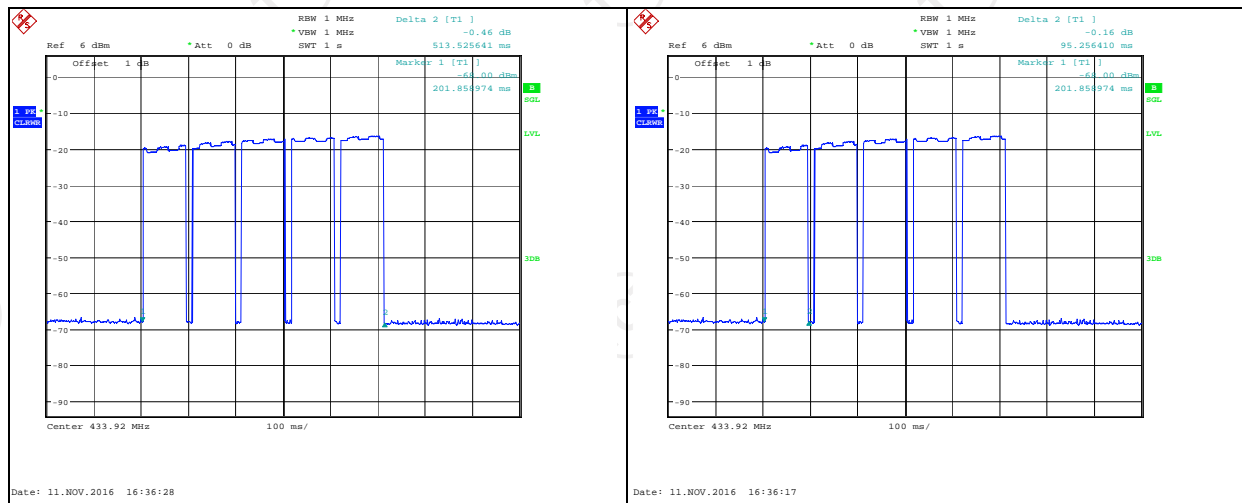

Field Strength of Fundamental

Frequency (MHz)	Emission PK (dBuV/m)	Horizontal /Vertical	Limits PK (dBuV/m)	Margin (dB)
433.92	63.24	H	92.87	-29.63
433.92	60.36	V	92.87	-32.51

Frequency (MHz)	Emission PK (dBuV/m)	AV Factor (dB)	Horizontal /Vertical	Emission AVG (dBuV/m)	Limits AV (dBuV/m)	Margin (dB)
433.92	63.24	-2.59	H	66.74	72.87	-12.22
433.92	60.36	-2.59	V	65.81	72.87	-15.10

Harmonics and Spurious Emissions

Frequency Range (9 kHz-30MHz)

Frequency (MHz)	Level@3m (dBμV/m)	Limit@3m (dBμV/m)
--	--	--
--	--	--
--	--	--
--	--	--

Note: 1. Emission Level=Reading+ Cable loss-Antenna factor-Amp factor

2. The emission levels are 20 dB below the limit value, which are not reported. It is deemed to comply with the requirement

Frequency Range (30MHz–1GHz)

Horizontal:

Frequency (MHz)	Emission Level@3m (dBμV/m)	Antenna Polarity	Limit@3m (dBμV/m)	Remark	Margin (dB)
867.84	43.25	H	52.87	QP	-9.62
Frequency (MHz)	Emission Level@3m (dBμV/m)	Antenna Polarity	Limit@3m (dBμV/m)	Remark	Margin (dB)
867.84	44.31	V	52.87	QP	-8.56

Frequency Range (1GHz–5GHz)

Frequency (MHz)	Emission Level@3m (dBμV/m)	Antenna Polarity	Limit@3m (dBμV/m)	Remark	Margin (dB)
1301.76	25.35	H	74.0	Peak	-48.65
1301.76	26.69	V	74.0	Peak	-47.31

Frequency (MHz)	Emission Level@3m (dBμV/m)	AV Factor (dB)	Antenna Polarity	Limit@3m (dBμV/m)	Remark	Margin (dB)
1301.76	25.35	-2.59	H	54.0	AV	-31.24
1301.76	26.69	-2.59	V	54.0	AV	-29.90

Note:

- Emission Level=Reading+ Cable loss+ Antenna factor-Amp factor
AV=Average
AV Emission level = Peak Emissions level +AV Factor
- Measurements were conducted from 1 GHz to the 10th harmonic of highest fundamental frequency. The highest test frequency is 5GHz.
- Data of measurement which is not shown in the above table mean that the reading of emissions is attenuated more than 40 dB below the limits or the field strength is too small to be measured.

6.4. Occupied Bandwidth

6.4.1. Test Specification

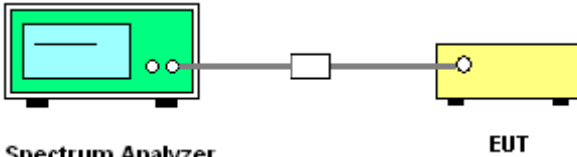
Test Requirement:	FCC Part15 C Section 15.215(c)
Test Method:	ANSI C63.10: 2013
Limit:	According to 15.231(c), The bandwidth of the emission shall be no wider than 0.25% of the centre frequency for devices operating above 70 MHz and below 900 MHz. For devices operating above 900 MHz, the emission shall be no wider than 0.5% of the centre frequency. Bandwidth is determined at the points 20 dB down from the modulated carrier.
	<ol style="list-style-type: none"> 1. According to the follow Test-setup, keep the relative position between the artificial antenna and the EUT. 2. Set to the maximum power setting and enable the EUT transmit continuously. 3. Use the following spectrum analyzer settings for 20dB Bandwidth measurement. Span = approximately 2 to 3 times the 20 dB bandwidth, centered on a hopping channel; RBW \geq 1% of the 20 dB bandwidth; VBW \geq RBW; Sweep = auto; Detector function = peak; Trace = max hold. 4. Measure and record the results in the test report.
Test setup:	 <p style="text-align: center;">Spectrum Analyzer EUT</p>
Test Mode:	Transmitting Mode
Test results:	PASS

6.4.2. Test Instruments

RF Test Room				
Equipment	Manufacturer	Model	Serial Number	Calibration Due
Spectrum Analyzer	R&S	FSU	200054	Aug. 11, 2017

Note: The calibration interval of the above test instruments is 12 months and the calibrations are traceable to international system unit (SI).

6.4.3. Test data

Test Channel (MHz)	20dB Occupy Bandwidth (kHz)	Limit (kHz)	Conclusion
433.92	61.70	1084.8	PASS

Note: Limit = 433.92MHz * 0.25% = 1084.8 kHz

Test plots as follows:

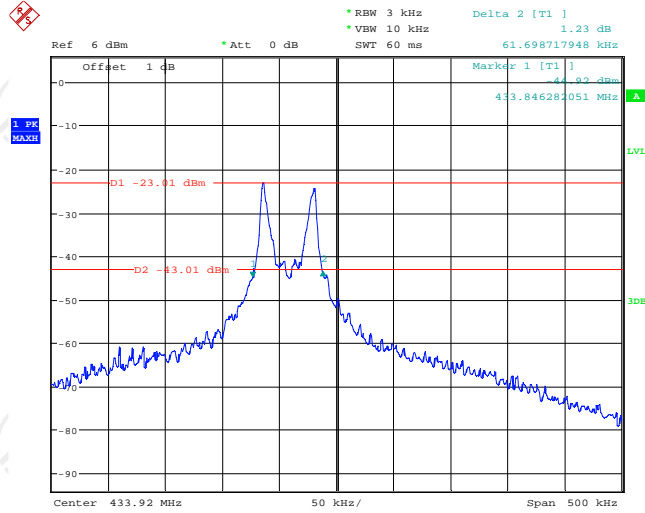

Date: 7.NOV.2016 12:16:27

6.5. Duration Time

6.5.1. Test Specification

Test Requirement:	FCC Part15 C Section 15.231(e)
Test Method:	ANSI C63.10: 2013
Limit:	Per 15.231(e) , devices operated under the provisions of this paragraph shall be provided with a means for automatically limiting operation so that the duration of each transmission shall not be greater than one second and the silent period between transmissions shall be at least 30 times the duration of the transmission but in no case less than 10 seconds.
Test Procedure:	<ol style="list-style-type: none"> 1. According to the follow Test-setup, keep the relative position between the artificial antenna and the EUT. 2. Set the EUT to proper test channel. 3. Single scan the transmission, and read the transmission time.
Test setup:	 <p style="text-align: center;">Spectrum Analyzer EUT</p>
Test Mode:	Transmitting Mode
Test results:	PASS

6.5.2. Test Instruments

RF Test Room				
Equipment	Manufacturer	Model	Serial Number	Calibration Due
Spectrum Analyzer	R&S	FSU	200054	Aug. 11, 2017

Note: The calibration interval of the above test instruments is 12 months and the calibrations are traceable to international system unit (SI).

6.5.3. Test data

Items	Test Data	Limit (second)	Conclusion
Duration time	0.09183 s	<1.0 s	Pass
Silent Time	45 s	>10 s	Pass

Note: The silent period between transmissions shall be at least 30 times the duration of the transmission but in no case less than 10 seconds.

The duration time is 0.263s, $0.263 \times 30 = 2.75s$

Test plot as follows:

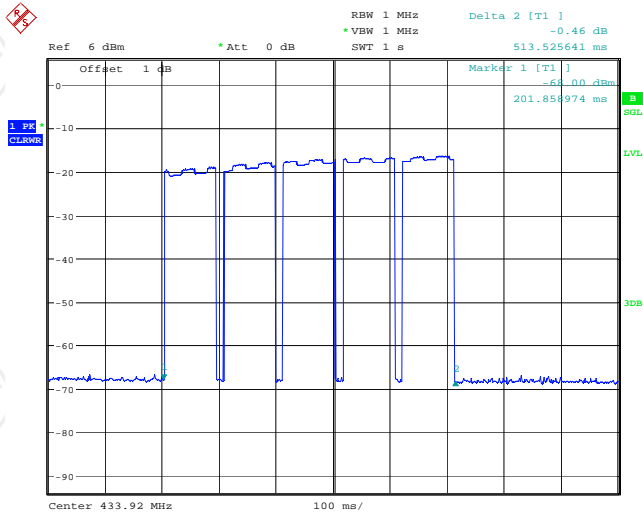

Date: 11.NOV.2016 16:36:28

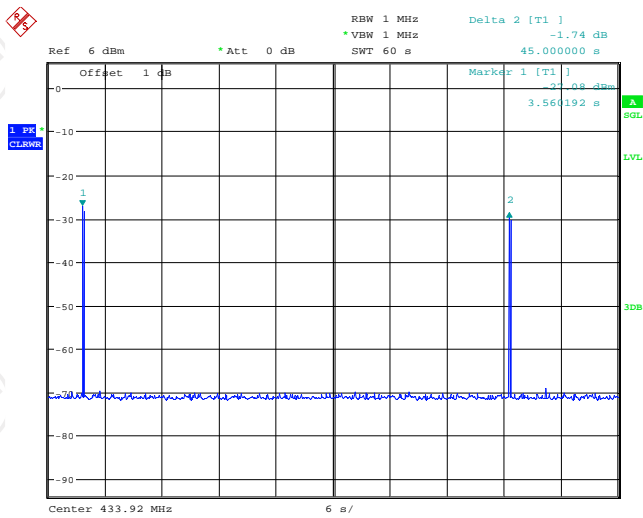

Date: 7.NOV.2016 12:19:55

Appendix A: Photographs of Test Setup

Product: TPMS
Model: D18T
Radiated Emission

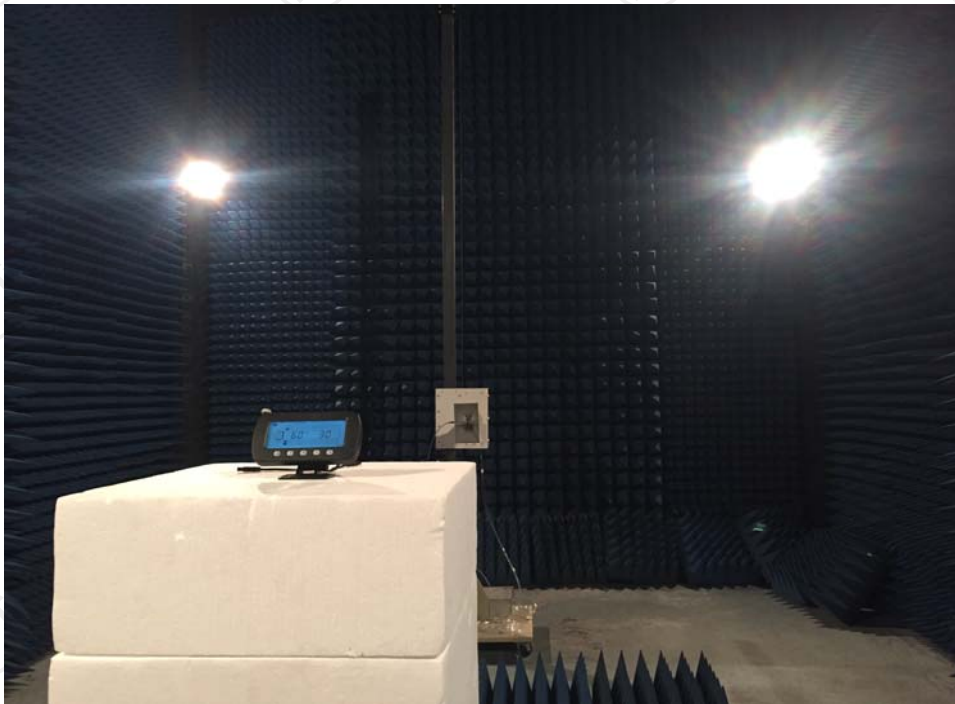

Appendix B: Photographs of EUT
Product: TPMS
Model: D18T
External Photos







Product: TPMS
Model: D18T
Internal Photos



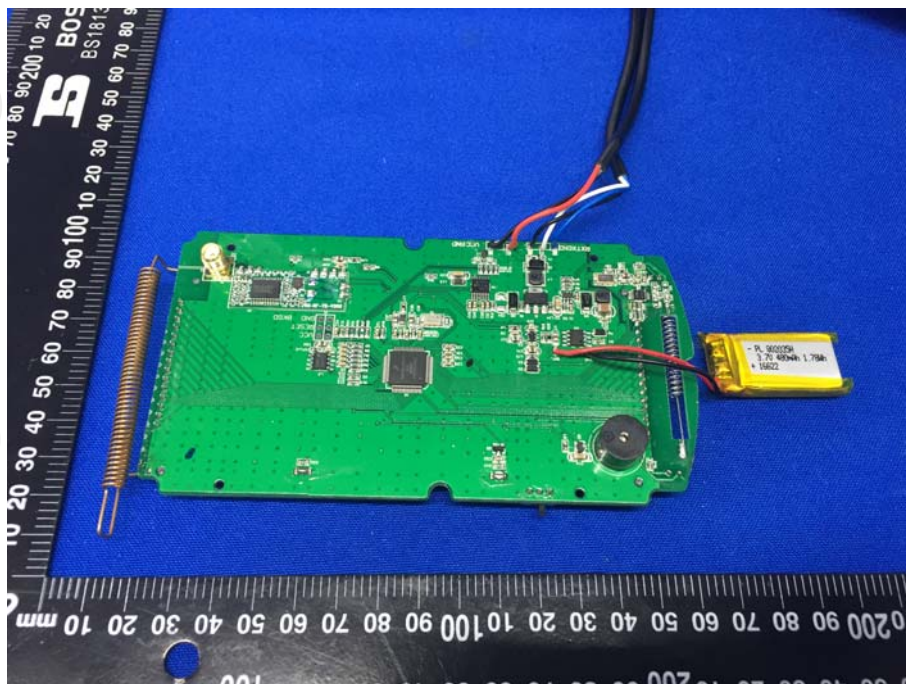
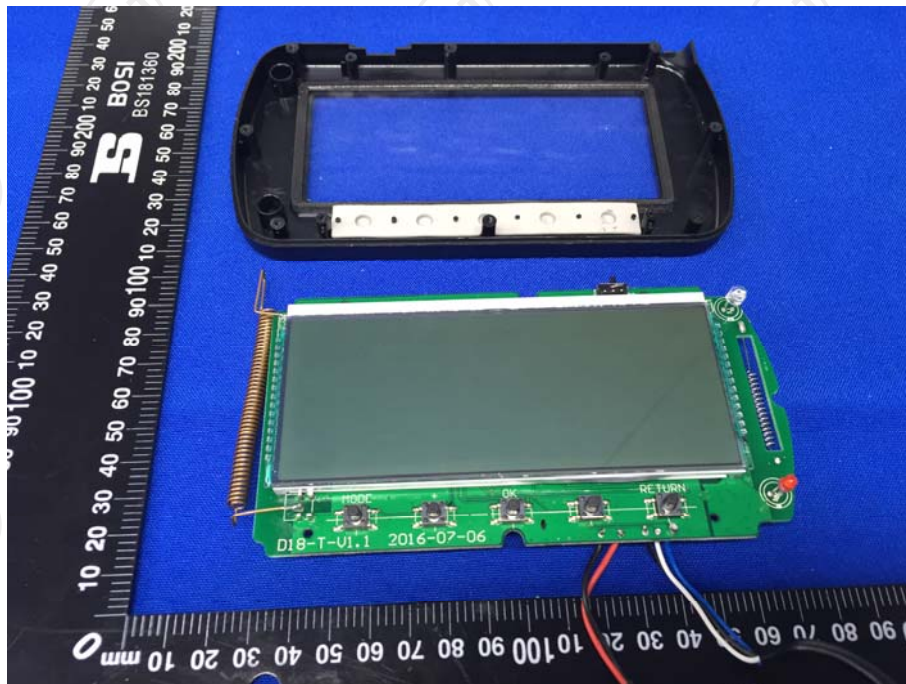

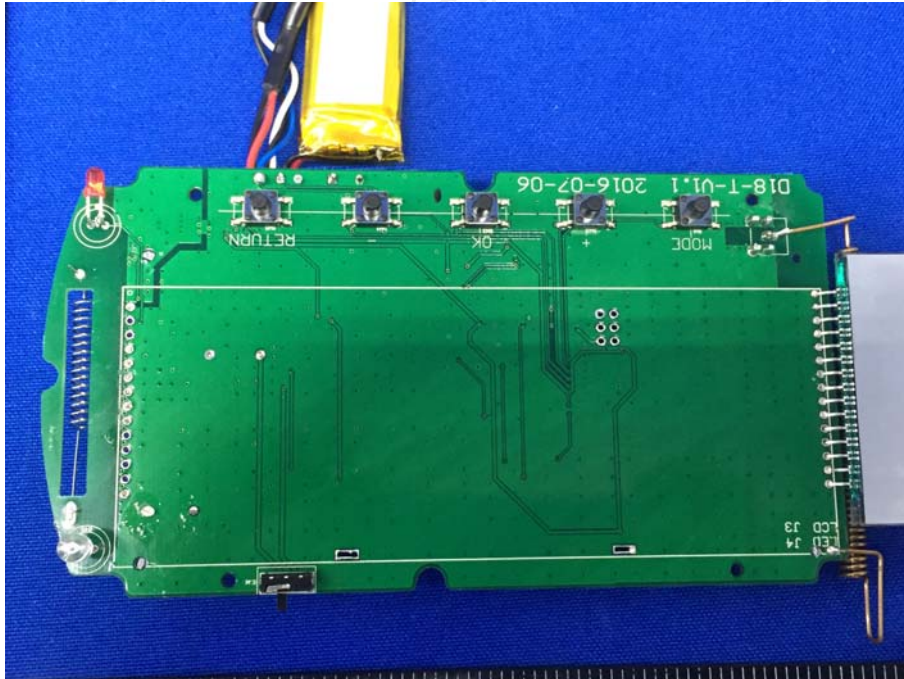



*******END OF REPORT*******