

# SAR TEST REPORT

**FCC ID: 2AIFYSD50**

**Product: MOBILE PHONE**

**Model No.: SD50**

**Additional Model: N/A**

**Trade Mark: UNEONE**

**Report No.: TCT190514E001**

**Issued Date: Jun. 05, 2019**

Issued for:

**Darmuoba, S.A. de C.V**

**Mar Negro 1, Col. Tacuba, CDMX. C.P 11410 Miguel Hidalgo, Distrito Federal,  
Mexico**

Issued By:

**Shenzhen Tongce Testing Lab.**

**1B/F., Building 1, Yibaolai Industrial Park, Qiaotou, Fuyong, Baoan District,  
Shenzhen, Guangdong, China**

**TEL: +86-755-27673339**

**FAX: +86-755-27673332**

**Note:** This report shall not be reproduced except in full, without the written approval of Shenzhen Tongce Testing Lab..

This document may be altered or revised by Shenzhen Tongce Testing Lab. personnel only, and shall be noted in the revision section of the document. The test results in the report only apply to the tested sample.

**TABLE OF CONTENTS**

1.	Test Certification .....	3
2.	Facilities and Accreditations .....	4
2.1.	Facilities.....	4
2.2.	Location.....	4
2.3.	Environment Condition: .....	4
3.	Test Result Summary .....	5
4.	EUT Description.....	7
5.	RF Exposure Limit.....	8
6.	SAR Measurement System Configuration.....	9
6.1.	SAR Measurement Set-up .....	9
6.2.	E-field Probe.....	10
6.3.	Phantom.....	10
6.4.	Device Holder .....	11
6.5.	Data Storage and Evaluation.....	12
6.6.	Position of the wireless device in relation to the phantom .....	13
6.7.	Tissue Dielectric Parameters .....	16
6.8.	Tissue-equivalent Liquid Properties .....	17
6.9.	System Check.....	18
7.	Measurement Procedure.....	19
8.	Conducted Output Power .....	22
9.	Exposure Position Consideration .....	37
9.1.	EUT Antenna Location.....	37
9.2.	Test Position Consideration.....	37
10.	SAR Test Results Summary .....	38
10.1.	Head 1g SAR Data.....	38
10.2.	Body-Worn 1g SAR Data .....	40
10.3.	Hotspot 1g SAR Data .....	42
10.4.	Simultaneous Transmission Conclusion.....	45
10.5.	SAR Simultaneous Transmission Analysis .....	46
10.6.	Measurement Uncertainty (450MHz-3GHz) .....	53
10.7.	Test Equipment List.....	55
11.	System Check Results .....	56
12.	SAR Test Data.....	76
	Appendix A: EUT Photos.....	134
	Appendix B: Test Setup Photos.....	137
	Appendix C: Probe Calibration Certificate.....	139
	Appendix D: Dipole Calibration Report.....	155
	Appendix E: SAR SYSTEM VALIDATION .....	210
	Appendix F: The Check Data of Impedance and Return Loss .....	211

## 1. Test Certification

<b>Product:</b>	MOBIE PHONE
<b>Model No.:</b>	SD50
<b>Additional Model No.</b>	N/A
<b>Trade Mark:</b>	<b>UNEONE</b>
<b>Applicant:</b>	Darmuoba, S.A. de C.V
<b>Address:</b>	Mar Negro 1, Col. Tacuba, CDMX. C.P 11410 Miguel Hidalgo, Distrito Federal, Mexico
<b>Manufacturer:</b>	Z-TECH COMMUNICATION(SZ)CO; LTD
<b>Address:</b>	7L BLK D BAO'AN ZHIGU YIN'TIAN ROAD NO.4 XI'XIANG, BAO'AN DISTRICT SZ CHINA
<b>Date of Test:</b>	May 15 – Jun. 04, 2019
<b>SAR Max. Values:</b>	<b>0.66 W/Kg (1g) for head; 1.33W/Kg (1g) for Body-worn; 1.35 W/Kg (1g) for Hotspot;</b>
<b>Applicable Standards:</b>	FCC 47 CFR § 2.1093 IEEE1528-2013:Recommended Practice for Determining the Peak Spatial-Average Specific Absorption Rate in the Human Head from Wireless Communications Devices: Measurement Techniques KDB447498 D01:General RF Exposure Guidance v06 KDB865664 D01:SAR measurement 100MHz to 6GHz v01r04 KDB865664 D02:RF Exposure Reporting v01r02. KDB941225 D01:3G SAR Procedures v03r01 KDB248227 D01:802.11 wi-fi SAR v02r02 KDB941225 D05:SAR for LTE devices v02r05 KDB941225 D06:Hotspot Mode v02r01 KDB941225 D07:UMPC Mini Tablet v01r02 KDB690783 D01:SAR Listings on Grant v01r03

The above equipment has been tested by Shenzhen Tongce Testing Lab. and found compliance with the requirements set forth in the technical standards mentioned above. The results of testing in this report apply only to the product/system, which was tested. Other similar equipment will not necessarily produce the same results due to production tolerance and measurement uncertainties.

**Tested By:** Aaron Mo **Date:** Jun. 04, 2019  
Aaron Mo

**Reviewed By:** Beryl Zhao **Date:** Jun. 05, 2019  
Beryl Zhao

**Approved By:** Tomsin **Date:** Jun. 05, 2019  
Tomsin

## 2. Facilities and Accreditations

### 2.1. Facilities

The test facility is recognized, certified, or accredited by the following organizations:

- FCC - Registration No.: 645098

Shenzhen Tongce Testing Lab

The 3m Semi-anechoic chamber has been registered and fully described in a report with the (FCC) Federal Communications Commission. The acceptance letter from the FCC is maintained in our files.

- IC - Registration No.: 10668A-1

The 3m Semi-anechoic chamber of Shenzhen Tongce Testing Lab.. has been registered by Certification and Engineering Bureau of Industry Canada for radio equipment testing

### 2.2. Location

Shenzhen Tongce Testing Lab

Address: 1B/F., Building 1, Yibaolai Industrial Park, Qiaotou, Fuyong, Baoan District, Shenzhen, Guangdong, China

### 2.3. Environment Condition:

Temperature:	18°C ~25°C
Humidity:	35%~75% RH
Atmospheric Pressure:	1011 mbar

### 3. Test Result Summary

The maximum results of Specific Absorption Rate (SAR) found during test as bellows:  
<Highest Reported standalone SAR Summary>

Exposure Position	Frequency Band	Reported SAR (W/kg)	Equipment Class	Highest Reported SAR (W/kg)
Head 1-g SAR	GSM 850	0.41	PCE	<b>0.66</b>
	GSM 1900	0.46		
	WCDMA Band II	0.42		
	WCDMA Band V	0.30		
	LTE Band 4	<b>0.66</b>		
	LTE Band 5	0.14		
	LTE Band 7	0.11		
	LTE Band 66	0.33		
	WLAN 2.4 GHz	0.12	DTS	
Body-worn 1-g SAR (10 mm Gap)	GSM 850	0.34	PCE	<b>1.33</b>
	GSM 1900	<b>1.33</b>		
	WCDMA Band II	0.78		
	WCDMA Band V	0.18		
	LTE Band 4	0.75		
	LTE Band 5	0.15		
	LTE Band 7	0.63		
	LTE Band 66	0.73		
	WLAN 2.4 GHz	0.06	DTS	
Hotspot 1-g SAR (10 mm Gap)	GSM 850	0.38	PCE	<b>1.35</b>
	GSM 1900	<b>1.35</b>		
	WCDMA Band II	1.08		
	WCDMA Band V	0.19		
	LTE Band 4	0.76		
	LTE Band 5	0.16		
	LTE Band 7	0.69		
	LTE Band 66	0.75		
	WLAN 2.4 GHz	0.07	DTS	

<Highest Reported simultaneous SAR Summary>

Exposure Position	Frequency Band	Highest Reported Simultaneous Transmission SAR (W/kg)
Head 1-g SAR	LTE Band 4 + WIFI	0.78
Body-worn 1-g SAR (10 mm Gap)	GSM 1900 + WIFI	1.39
Hotspot 1-g SAR (10 mm Gap)	GSM 1900 + WIFI	1.42

**Note:**

1. The highest simultaneous transmission is scalar summation of Reported standalone SAR per FCC KDB 690783 D01 v01r03, and scalar SAR summation of all possible simultaneous transmission scenarios are < 1.6W/kg.
2. This device is compliance with Specific Absorption Rate (SAR) for general population/uncontrolled exposure limits specified in FCC 47 CFR part 2 (2.1093) and ANSI/IEEE C95.1-2005, and had been tested in accordance with the measurement methods and procedures specified in IEEE 1528-2013.

## 4. EUT Description

Product Name:	MOBIE PHONE
Model :	SD50
Additional Model:	N/A
Trade Mark:	<b>UNEONE</b>
Hardware Version:	SD50_V1.1
Software Version:	SD50_002R
Power Supply:	Rechargeable Li-ion Battery DC 3.8V
<b>2G</b>	
Operation Band:	GSM850, GSM1900
Supported type:	GSM/GPRS/EGPRS
Power Class:	GSM850:Power Class 5; GSM1900:Power Class 0
Modulation Type:	GMSK for GSM/GPRS; 8PSK for EGPRS
GSM Release Version:	R99
GPRS Multislot Class:	12
EGPRS Multislot Class:	12
<b>3G</b>	
Operation Band:	FDD Band II & FDD Band V
Power Class:	Power Class 3
Modulation Type:	QPSK for WCDMA/HSDPA/HSUPA
WCDMA Release Version:	R99
HSDPA Release Version:	Release 5
HSUPA Release Version:	Release 6
DC-HSUPA Release Version:	Not Supported
<b>LTE</b>	
Operation Band:	LTE Band 4 & LTE Band 5 & LTE Band 7 & LTE Band 66
Power Class:	Power Class 3
Modulation Type:	QPSK & 16-QAM for LTE
<b>Wi-Fi 2.4G</b>	
Supported type:	802.11b/802.11g/802.11n
Modulation:	802.11b: DSSS 802.11g/802.11n: OFDM
Operation frequency:	802.11b/802.11g/802.11n(HT20):2412MHz~2462MHz; 802.11n(HT40):2422MHz~2452MHz
Channel number:	802.11b/802.11g/802.11n(HT20):11; 802.11n(HT40):7
Channel separation:	5MHz
<b>Bluetooth</b>	
Bluetooth Version:	Supported 4.2
Modulation:	GFSK(1Mbps) , $\pi/4$ -DQPSK(2Mbps) , 8-DPSK(3Mbps)
Operation frequency:	2402MHz~2480MHz
Channel number:	79/40
Channel separation:	1MHz/2MHz

## 5. RF Exposure Limit

Type Exposure	SAR (W/kg)
	Uncontrolled Exposure Limit
Spatial Peak SAR (averaged over any 1 g of tissue)	1.60
Spatial Peak SAR (hands/wrists/feet/ankles averaged over 10g)	4.00
Spatial Peak SAR (averaged over the whole body)	0.08

**Note:**

1. The Spatial Peak value of the SAR averaged over any 1 gram of tissue (defined as a tissue volume in the shape of a cube) and over the appropriate averaging time.
2. The Spatial Average value of the SAR averaged over the whole body.
3. The Spatial Peak value of the SAR averaged over any 10 grams of tissue (defined as a tissue volume in the shape of a cube) and over the appropriate averaging time.



## 6. SAR Measurement System Configuration

### 6.1. SAR Measurement Set-up

The OPENSAR system for performing compliance tests consist of the following items:

A standard high precision 6-axis robot (KUKA) with controller and software.

KUKA Control Panel (KCP)

A dosimetric probe, i.e., an isotropic E-field probe optimized and calibrated for usage in tissue simulating liquid. The probe is equipped with a Video Positioning System (VPS).

The stress sensor is composed with mechanical and electronic when the electronic part detects a change on the electro-mechanical switch; it sends an "Emergency signal" to the robot controller that to stop robot's moves A computer operating Windows XP.

OPENSAR software Remote control with teaches pendant and additional circuitry for robot safety such as warning lamps, etc.

The SAM phantom enabling testing left-hand right-hand and body usage.

The Position device for handheld EUT

Tissue simulating liquid mixed according to the given recipes.

System validation dipoles to validate the proper functioning of the system.

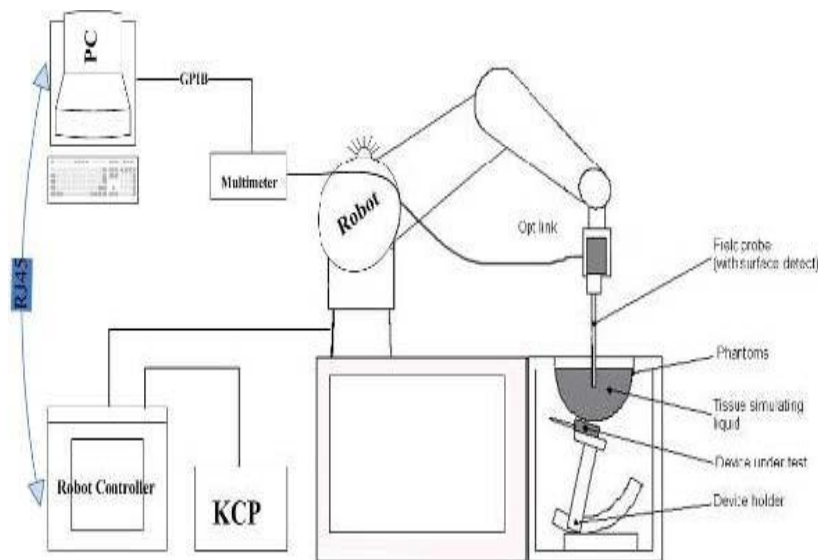

**KUKA SAR Test System Configuration**

## 6.2. E-field Probe

The SAR measurement is conducted with the dosimetric probe (manufactured by MVG). The probe is specially designed and calibrated for use in liquid with high permittivity. The dosimetric probe has special calibration in liquid at different frequency. This probe has a built in optical surface detection system to prevent from collision with phantom.

### Probe Specification

Construction Symmetrical design with triangular core  
Interleaved sensors  
Built-in shielding against static charges  
PEEK enclosure material (resistant to organic solvents, e.g., DGBE)  
Calibration ISO/IEC 17025 calibration service available.

Device Type	COMOSAR DOSIMETRIC E FIELD PROBE
Manufacturer	MVG
Model	SSE5
Serial Number	SN 07/15 EP248
Frequency Range of Probe	0.45 GHz-3GHz
Resistance of Three Dipoles at Connector	Dipole 1:R1=0.218MΩ Dipole 2:R3=0.217MΩ Dipole 3:R3=0.215MΩ



Photo of E-Field Probe

## 6.3. Phantom

The SAM Phantom SAM120 is constructed of a fiberglass shell integrated in a wooden table. The shape of the shell is in compliance with the specification set in IEEE P1528 and CENELEC IEC 62209-1, IEC 62209-2:2010.

The phantom enables the dosimetric evaluation of left and right hand phone usage as well as body mounted usage at the flat phantom region.

A cover prevents the evaporation of the liquid.

Reference markings on the Phantom allow the complete setup of all predefined phantom positions and measurement grids by manually teaching three points in the robot

System checking was performed using the flat section, whilst Head SAR tests used the left and right head profile sections.

Body SAR testing also used the flat section between the head profiles.

Name: COMOSAR IEEE SAM PHANTOM

S/N: SN 19/15 SAM 120

Manufacture: MVG



SAM Twin Phantom

#### 6.4. Device Holder

In combination with the Generic Twin Phantom SAM120, the Mounting Device enables the rotation of the mounted transmitter in spherical coordinates whereby the rotation points is the ear opening. The devices can be easily, accurately, and repeatedly positioned according to the FCC and CENELEC specifications. The device holder can be locked at different phantom locations (left head, right head, flat phantom).

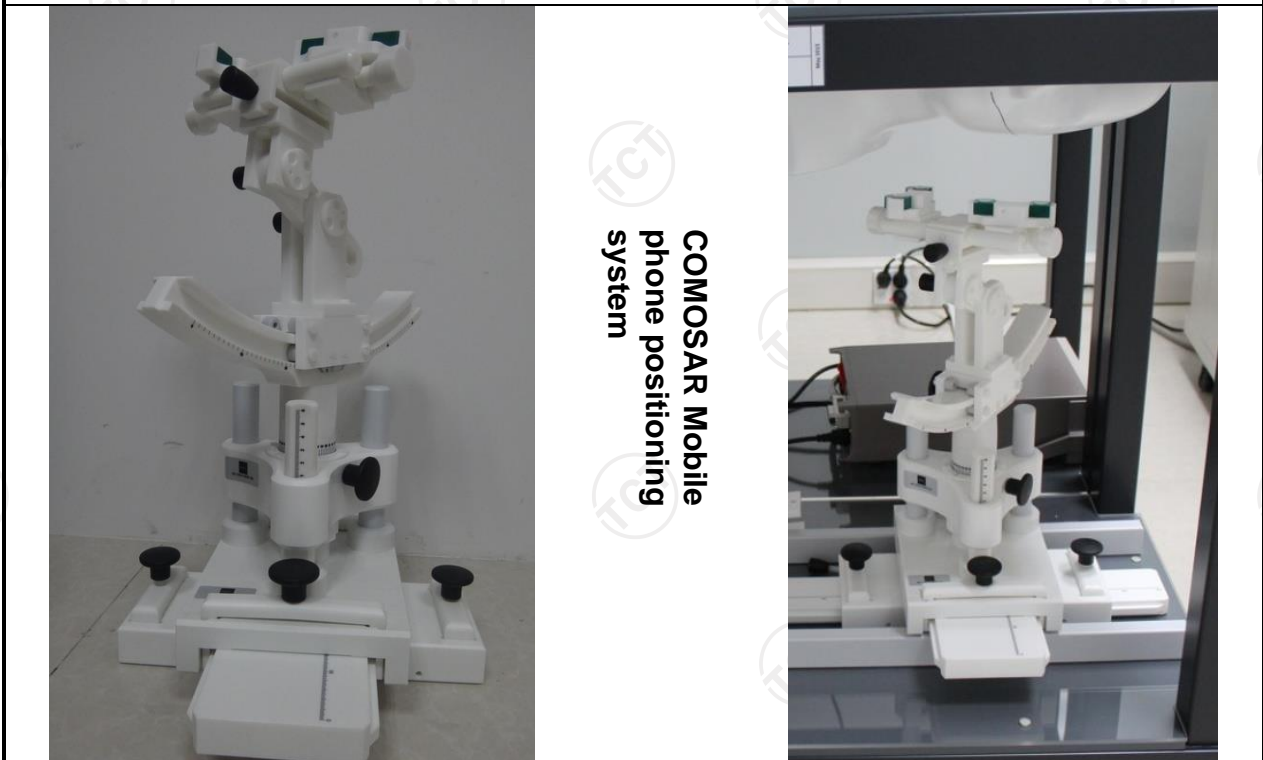

COMOSAR Mobile  
phone positioning  
system

## 6.5. Data Storage and Evaluation

### Data Storage

The OPENSAR software stores the acquired data from the data acquisition electronics as raw data (in microvolt readings from the probe sensors), together with all necessary software parameters for the data evaluation (probe calibration data, liquid parameters and device frequency and modulation data) in measurement files. The software evaluates the desired unit and format for output each time the data is visualized or exported. This allows verification of the complete software setup even after the measurement and allows correction of incorrect parameter settings. For example, if a measurement has been performed with a wrong crest factor parameter in the device setup, the parameter can be corrected afterwards and the data can be re-evaluated.

The measured data can be visualized or exported in different units or formats, depending on the selected probe type ([V/m], [A/m], [°C], [mW/g], [mW/cm<sup>2</sup>], [dBrel], etc.). Some of these units are not available in certain situations or show meaningless results, e.g., a SAR output in a lossless media will always be zero. Raw data can also be exported to perform the evaluation with other software packages.

### Data Evaluation

The OPENSAR software automatically executes the following procedures to calculate the field units from the microvolt readings at the probe connector. The parameters used in the evaluation are stored in the configuration modules of the software:

Probe parameters:	- Sensitivity	Normi, ai0, ai1, ai2
	- Conversion factor	ConvFi
	- Diode compression point	Dcpi
Device parameters:	- Frequency	f
	- Crest factor	cf
Media parameters:	- Conductivity	σ
	- Density	ρ

These parameters must be set correctly in the software. They can be found in the component documents or they can be imported into the software from the configuration files issued for the OPENSAR components. In the direct measuring mode of the millimeter option, the parameters of the actual system setup are used. In the scan visualization and export modes, the parameters stored in the corresponding document files are used.

The first step of the evaluation is a linearization of the filtered input signal to account for the compression characteristics of the detector diode. The compensation depends on the input signal, the diode type and the DC-transmission factor from the diode to the evaluation electronics. If the exciting field is pulsed, the crest factor of the signal must be known to correctly compensate for peak power. The formula for each channel can be given as:

$$V_i = U_i + U_i^2 \cdot c f / d c p_i$$

With	$V_i$	= compensated signal of channel i	(i = x, y, z)
	$U_i$	= input signal of channel i	(i = x, y, z)
	cf	= crest factor of exciting field	(MVG parameter)
	dcpi	= diode compression point	(MVG parameter)

From the compensated input signals the primary field data for each channel can be evaluated:

$$\text{E-field probes: } E_i = (V_i / \text{Normi} \cdot \text{ConvF})^{1/2}$$

$$\text{H-field probes: } H_i = (V_i)^{1/2} \cdot (ai_0 + ai_1 f + ai_2 f^2) / f$$

With	$V_i$	= compensated signal of channel i	(i = x, y, z)
	Normi	= sensor sensitivity of channel i	(i = x, y, z)
		[mV/(V/m) <sup>2</sup> ] for E-field Probes	
	ConvF	= sensitivity enhancement in solution	
	aij	= sensor sensitivity factors for H-field probes	
	f	= carrier frequency [GHz]	
	$E_i$	= electric field strength of channel i in V/m	
	$H_i$	= magnetic field strength of channel i in A/m	

The RSS value of the field components gives the total field strength (Hermitian magnitude):

$$E_{tot} = (E_x^2 + E_y^2 + E_z^2)^{1/2}$$

The primary field data are used to calculate the derived field units.

$$SAR = (E_{tot})^2 \cdot \sigma / (\rho \cdot 1000)$$

- with SAR = local specific absorption rate in mW/g
- E<sub>tot</sub> = total field strength in V/m
- σ = conductivity in [mho/m] or [Siemens/m]
- ρ = equivalent tissue density in g/cm<sup>3</sup>

Note that the density is normally set to 1 (or 1.06), to account for actual brain density rather than the density of the simulation liquid. The power flow density is calculated assuming the excitation field to be a free space field.

### 6.6. Position of the wireless device in relation to the phantom

#### Handset Reference Points

$$P_{pwe} = E_{tot}^2 / 3770 \text{ or } P_{pwe} = H_{tot}^2 \cdot 37.7$$

- With P<sub>pwe</sub> = equivalent power density of a plane wave in mW/cm<sup>2</sup>
- E<sub>tot</sub> = total electric field strength in V/m
- H<sub>tot</sub> = total magnetic field strength in A/m

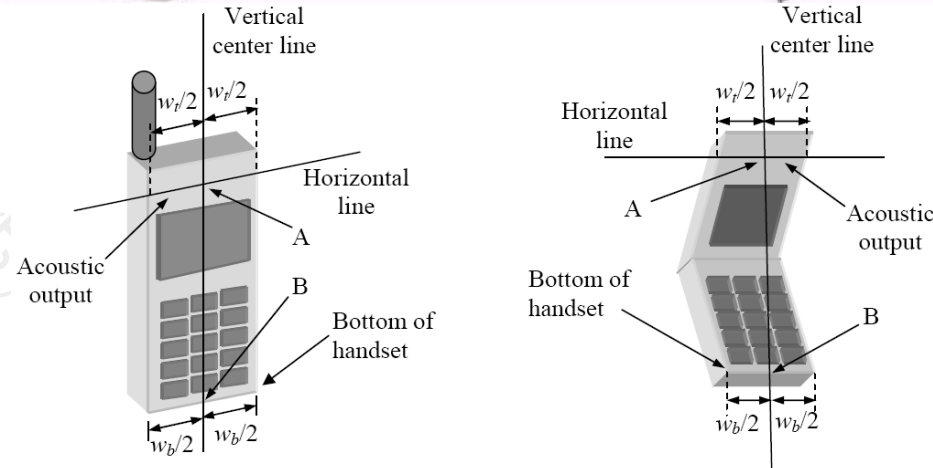

- W<sub>t</sub> Width of the handset at the level of the acoustic
- W<sub>b</sub> Width of the bottom of the handset
- A Midpoint of the width w<sub>t</sub> of the handset at the level of the acoustic output
- B Midpoint of the width w<sub>b</sub> of the bottom of the handset

#### Positioning for Cheek / Touch



**Positioning for Ear / 15° Tilt**

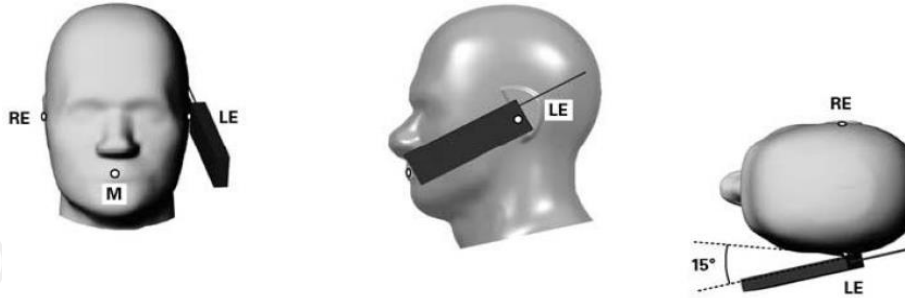

**Body Worn Accessory Configurations**

To position the device parallel to the phantom surface with either keypad up or down.

To adjust the device parallel to the flat phantom.

To adjust the distance between the device surface and the flat phantom to 15mm or holster surface and the flat phantom to 0 mm.

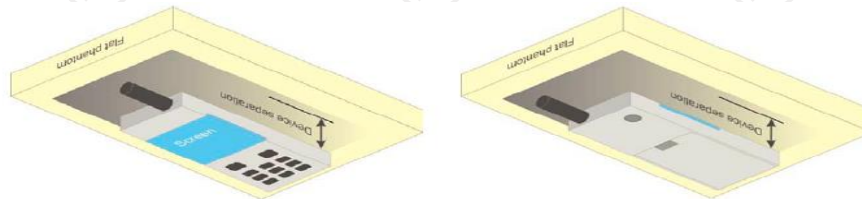

**Illustration for Body Worn Position**

**Wireless Router (Hotspot) Configurations**

Some battery-operated handsets have the capability to transmit and receive internet connectivity through simultaneous transmission of WIFI in conjunction with a separate licensed transmitter. The FCC has provided guidance in KDB Publication 941225 D06 where SAR test considerations for handsets (L x W ≥

9 cm x 5 cm) are based on a composite test separation distance of 10 mm from the front, back and edges of the device with antennas 2.5 cm or closer to the edge of the device, determined from general mixed use conditions for this type of devices. Since the hotspot SAR results may overlap with the body-worn accessory SAR requirements, the more conservative configurations can be considered, thus excluding some body-worn accessory SAR tests.

When the user enables the personal wireless router functions for the handset, actual operations include simultaneous transmission of both the WIFI transmitter and another licensed transmitter. Both transmitters often do not transmit at the same transmitting frequency and thus cannot be evaluated for SAR under actual use conditions. Therefore, SAR must be evaluated for each frequency transmission and mode separately and summed with the WIFI transmitter according to KDB 648474 publication procedures. The "Portable Hotspot" feature on the handset was NOT activated, to ensure the SAR measurements were evaluated for a single transmission frequency RF signal.

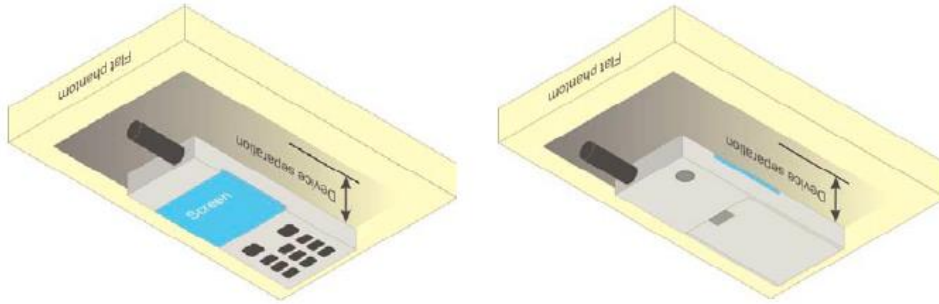
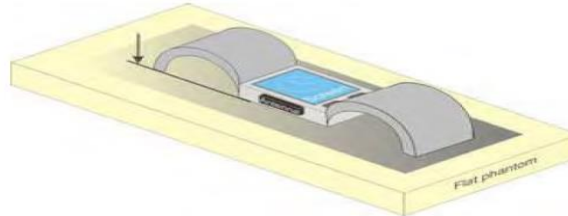

**Illustration for Hotspot Position**

**Limb-worn device**

A limb-worn device is a unit whose intended use includes being strapped to the arm or leg of the user while transmitting (except in idle mode). It is similar to a body-worn device. Therefore, the test positions of 6.1.4.4 also apply. The strap shall be opened so that it is divided into two parts as shown in Figure 9. The device shall be positioned directly against the phantom surface with the strap straightened as much as possible and the back of the device towards the phantom.

If the strap cannot normally be opened to allow placing in direct contact with the phantom surface, it may be necessary to break the strap of the device but ensuring to not damage the antenna.



**Test position for limb-worn devices**

## 6.7. Tissue Dielectric Parameters

The liquid used for the frequency range of 100MHz-6G consisted of water, sugar, salt and Cellulose. The liquid has been previously proven to be suited for worst-case. The following Table shows the detail solution. It's satisfying the latest tissue dielectric parameters requirements proposed by the IEEE 1528 and IEC 62209. The simulating liquids should be checked at the beginning of a series of SAR measurements to determine of the determine of the dielectric parameter are within the tolerances of the specified target values. The measured conductivity and relative permittivity should be within  $\pm 5\%$  of the target values.

The following materials are used for producing the tissue-equivalent materials

Targets for tissue simulating liquid

Frequency (MHz)	Liquid Type	Liquid Type ( $\sigma$ )	$\pm 5\%$ Range	Permittivity ( $\epsilon$ )	$\pm 5\%$ Range
300	Head	0.87	0.83~0.91	45.3	43.04~47.57
450	Head	0.87	0.83~0.91	43.5	41.33~45.68
835	Head	0.90	0.86~0.95	41.5	39.43~43.58
900	Head	0.97	0.92~1.02	41.5	39.43~43.58
1800-2000	Head	1.40	1.33~1.47	40.0	38.00~42.00
2450	Head	1.80	1.71~1.89	39.2	37.24~41.16
2600	Head	1.96	1.86~2.06	39.0	37.05~40.95
3000	Head	2.40	2.28~2.52	38.5	36.58~40.43
5800	Head	5.27	5.01~5.53	35.3	33.54~37.07
300	Body	0.92	0.87~0.97	58.2	55.29~61.11
450	Body	0.94	0.89~0.99	56.7	53.87~59.54
835	Body	0.97	0.92~1.02	55.2	52.44~57.96
900	Body	1.05	1.00~1.10	55.0	52.25~57.75
1800-2000	Body	1.52	1.44~1.60	53.3	50.64~55.97
2450	Body	1.95	1.85~2.05	52.7	50.07~55.34
2600	Body	2.16	2.05~2.27	52.5	49.88~55.13
3000	Body	2.73	2.60~2.87	52.0	49.40~54.60
5800	Body	6.00	5.70~6.30	48.2	45.79~50.61

( $\epsilon_r$  = relative permittivity,  $\sigma$  = conductivity and  $\rho = 1000 \text{ kg/m}^3$ )



### 6.8. Tissue-equivalent Liquid Properties

Test Date dd/mm/yy	Temp °C	Tissue Type	Measured Frequency ( MHz )	$\epsilon_r$	$\sigma$ (s/m)	Dev $\epsilon_r$ (%)	Dev $\sigma$ (%)
05/15/2019	22°C	835H	825	41.43	0.86	-0.17	-4.44
			835	41.42	0.87	-0.19	-3.33
			850	40.39	0.88	-2.67	-2.22
05/22/2019	22°C	1800H	1710	39.11	1.34	-2.23	-4.29
			1720	39.10	1.35	-2.25	-3.57
			1750	39.08	1.37	-2.30	-2.14
			1800	39.07	1.38	-2.33	-1.43
05/27/2019	22°C	1900H	1850	39.11	1.34	-2.23	-4.29
			1880	39.10	1.35	-2.25	-3.57
			1900	39.08	1.37	-2.30	-2.14
			1910	39.07	1.38	-2.33	-1.43
05/29/2019	22°C	2450H	2410	37.84	1.79	-3.47	-0.56
			2435	37.85	1.81	-3.44	0.56
			2450	37.82	1.83	-3.52	1.67
			2460	37.80	1.84	-3.57	2.22
05/31/2019	22°C	2600H	20850	38.86	1.93	-0.36	-1.53
			21100	38.85	1.92	-0.39	-2.04
			21350	38.89	1.90	-0.28	-3.06
05/15/2019	22°C	835B	825	55.26	0.93	0.11	-4.12
			835	55.24	0.94	0.07	-3.09
			850	55.21	0.97	0.02	0.00
05/22/2019	22°C	1800B	1710	53.34	1.49	0.08	-1.97
			1720	53.32	1.50	0.04	-1.32
			1750	53.31	1.51	0.02	-0.66
			1800	53.29	1.53	-0.02	0.66
05/27/2019	22°C	1900B	1850	53.34	1.49	0.08	-1.97
			1880	53.32	1.50	0.04	-1.32
			1900	53.31	1.51	0.02	-0.66
			1910	53.29	1.53	-0.02	0.66
05/29/2019	22°C	2450B	2410	54.65	1.97	3.70	1.03
			2435	54.63	1.98	3.66	1.54
			2450	54.62	2.01	3.64	3.08
			2460	54.59	2.03	3.59	4.10
05/31/2019	22°C	2600B	20850	51.96	2.10	-1.02	-2.78
			21100	52.01	2.11	-0.93	-2.31
			21350	52.13	2.13	-0.70	-1.39

### 6.9. System Check

The SAR system must be validated against its performance specifications before it is deployed. When SAR probe and system component or software are changed, upgraded or recalibrated, these must be validated with the SAR system(s) that operates with such component. Reference dipoles are used with the required tissue-equivalent media for system validation.

System check results have to be equal or near the values determined during dipole calibration with the relevant liquids and test system ( $\pm 10\%$ ).

System check is performed regularly on all frequency bands where tests are performed with the OPENSAR system.

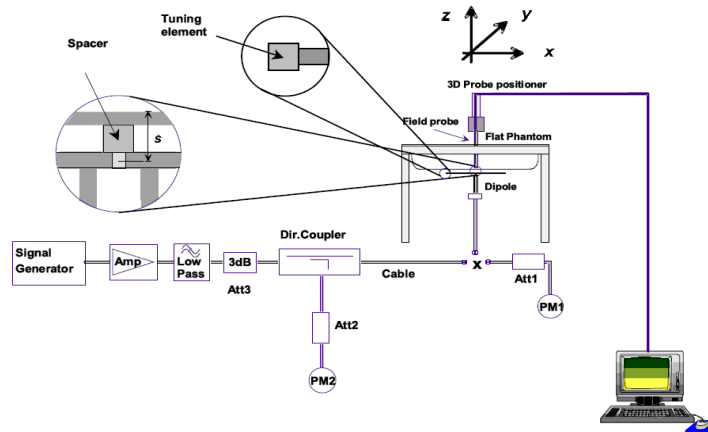

System Check Set-up

#### Verification Results

Frequency (MHz)	Liquid Type	Measured Value in 100mW (W/kg)		Normalized to 1W (W/kg)		Target Value (W/kg)		Deviation (%)	
		1 g Average	10 g Average	1 g Average	10 g Average	1 g Average	10 g Average	1 g Average	10 g Average
835	Head	0.89	0.57	8.90	5.70	9.60	6.24	-7.29	-8.65
1800	Head	3.75	2.20	37.53	21.98	37.69	20.28	-0.42	8.38
1900	Head	3.58	1.90	35.80	19.00	39.19	20.43	-8.65	-7.00
2450	Head	4.99	2.36	49.90	23.60	53.21	24.14	-6.22	-2.24
2600	Head	5.41	2.43	54.14	24.30	54.31	24.14	-0.31	0.66
835	Body	0.95	0.63	9.50	6.30	9.60	6.36	-1.04	-0.94
1800	Body	3.78	2.05	37.79	20.46	37.63	20.53	0.43	-0.34
1900	Body	3.77	1.99	37.70	19.90	38.73	20.48	-2.66	-2.83
2450	Body	5.07	2.42	50.70	24.16	50.72	23.43	-0.04	3.12
2600	Body	5.37	2.38	53.65	23.81	53.17	23.86	0.90	-0.21

Comparing to the original SAR value provided by MVG, the verification data should be within its specification of 10%. Below table shows the target SAR and measured SAR after normalized to 1W input power. The table as below indicates the system performance check can meet the variation criterion and the plots can be referred to Section 10 of this report.

## 7. Measurement Procedure

### Conducted power measurement

For WWAN power measurement, use base station simulator to configure EUT WWAN transition in conducted connection with RF cable, at maximum power in each supported wireless interface and frequency band.

Read the WWAN RF power level from the base station simulator.

For WLAN/BT power measurement, use engineering software to configure EUT WLAN/BT continuously transmission, at maximum RF power in each supported wireless interface and frequency band.

Connect EUT RF port through RF cable to the power meter or spectrum analyser, and measure WLAN/BT output power.

### Conducted power measurement

Use base station simulator to configure EUT WWAN transmission in radiated connection, and engineering software to configure EUT WLAN/BT continuously transmission, at maximum RF power, in the highest power channel.

Place the EUT in positions as Appendix B demonstrates.

Set scan area, grid size and other setting on the MVG software.

Measure SAR results for the highest power channel on each testing position.

Find out the largest SAR result on these testing positions of each band.

Measure SAR results for other channels in worst SAR testing position if the Reported SAR or highest power channel is larger than 0.8 W/kg.

According to the test standard, the recommended procedure for assessing the peak spatial-average SAR value consists of the following steps:

Power reference measurement

Area scan

Zoom scan

Power drift measurement

### Spatial Peak SAR Evaluation

The procedure for spatial peak SAR evaluation has been implemented according to the test standard. It can be conducted for 1g and 10g, as well as for user-specific masses. The MVG software includes all numerical procedures necessary to evaluate the spatial peak SAR value.

The base for the evaluation is a “cube” measurement. The measured volume must include the 1g and 10g cubes with the highest averaged SAR values. For that purpose, the center of the measured volume is aligned to the interpolated peak SAR value of a previously performed area scan.

The entire evaluation of the spatial peak values is performed within the post-processing engine (SEMCAD). The system always gives the maximum values for 1g and 10g cubes. The algorithm to find the cube with highest averaged SAR is divided into the following stages:

Extraction of the measured data (grid and values) from the Zoom Scan.

Calculation of the SAR value at every measurement point based on all stored data (A/D values and measurement parameters).

Generation of a high-resolution mesh within the measured volume.

Interpolation of all measured values from the measurement grid to the high-resolution grid

Extrapolation of the entire 3-D field distribution to the phantom surface over the distance from sensor to surface

Calculation of the averaged SAR within masses of 1g and 10g.

### Power Reference Measurement

The Power Reference Measurement and Power Drift Measurement are for monitoring the power drift of the device under test in the batch process. The minimum distance of probe sensors to surface determines the closest measurement point to phantom surface. This distance cannot be smaller than the distance of sensor calibration points to probe tip as defined in the probe properties

### Area & Zoom Scan Procedures

First Area Scan is used to locate the approximate location(s) of the local peak SAR value(s). The measurement grid within an Area Scan is defined by the grid extent, grid step size and grid offset. Next, in order to determine the EM field distribution in a three-dimensional spatial extension, Zoom Scan is required. The Zoom Scan is performed around the highest E-field value to determine the averaged SAR-distribution over 10g. Area scan and zoom scan resolution setting follows KDB 865664 D01v01r03 quoted below.

		$\leq 3$ GHz	$> 3$ GHz	
Maximum distance from closest measurement point (geometric center of probe sensors) to phantom surface		5 mm $\pm$ 1 mm	$\frac{1}{2} \cdot \delta \cdot \ln(2)$ mm $\pm$ 0.5 mm	
Maximum probe angle from probe axis to phantom surface normal at the measurement location		30° $\pm$ 1°	20° $\pm$ 1°	
Maximum area scan spatial resolution: $\Delta X_{Area}$ , $\Delta Y_{Area}$		$\leq 2$ GHz: $\leq 15$ mm 2 – 3 GHz: $\leq 12$ mm	3 – 4 GHz: $\leq 12$ mm 4 – 6 GHz: $\leq 10$ mm	
		When the x or y dimension of the test device, in the measurement plane orientation, is smaller than the above, the measurement resolution must be $\leq$ the corresponding x or y dimension of the test device with at least one measurement point on the test device.		
Maximum zoom scan spatial resolution: $\Delta X_{Zoom}$ , $\Delta Y_{Zoom}$		$\leq 2$ GHz: $\leq 8$ mm 2 – 3 GHz: $\leq 5$ mm*	3 – 4 GHz: $\leq 5$ mm* 4 – 6 GHz: $\leq 4$ mm*	
Maximum zoom scan spatial resolution, normal to phantom surface	uniform grid: $\Delta Z_{Zoom}(n)$	$\leq 5$ mm	3 – 4 GHz: $\leq 4$ mm 4 – 5 GHz: $\leq 3$ mm 5 – 6 GHz: $\leq 2$ mm	
	graded grid	$\Delta Z_{Zoom}(1)$ : between 1 <sup>st</sup> two points closest to phantom surface	$\leq 4$ mm	3 – 4 GHz: $\leq 3$ mm 4 – 5 GHz: $\leq 2.5$ mm 5 – 6 GHz: $\leq 2$ mm
		$\Delta Z_{Zoom}(n>1)$ : between subsequent points	$\leq 1.5 \cdot \Delta Z_{Zoom}(n-1)$ mm	
Minimum zoom scan volume	x, y, z	$\geq 30$ mm	3 – 4 GHz: $\geq 28$ mm 4 – 5 GHz: $\geq 25$ mm 5 – 6 GHz: $\geq 22$ mm	
Note: $\delta$ is the penetration depth of a plane-wave at normal incidence to the tissue medium; see IEEE Std 1528-2013 for details.				
* When zoom scan is required and the <i>reported</i> SAR from the <i>area scan based 1-g SAR estimation</i> procedures of KDB Publication 447498 is $\leq 1.4$ W/kg, $\leq 8$ mm, $\leq 7$ mm and $\leq 5$ mm zoom scan resolution may be applied, respectively, for 2 GHz to 3 GHz, 3 GHz to 4 GHz and 4 GHz to 6 GHz.				

### Volume Scan Procedures

The volume scan is used for assess overlapping SAR distributions for antennas transmitting in different frequency bands. It is equivalent to an oversized zoom scan used in standalone measurements. The measurement volume will be used to enclose all the simultaneous transmitting antennas. For antennas transmitting simultaneously in different frequency bands, the volume scan is measured separately in each frequency band. In order to sum correctly to compute the 1g aggregate SAR, the EUT remain in the same test position for all measurements and all volume scan use the same spatial resolution and grid spacing. When all volume scan were completed, the software, SEMCAD post-processor scan combine and subsequently superpose these measurement data to calculating the multiband SAR.

**SAR Averaged Methods**

In MVG, the interpolation and extrapolation are both based on the modified Quadratic Shepard's method. The interpolation scheme combines a least-square fitted function method and a weighted average method which are the two basic types of computational interpolation and approximation.

Extrapolation routines are used to obtain SAR values between the lowest measurement points and the inner phantom surface. The extrapolation distance is determined by the surface detection distance and the probe sensor offset. The uncertainty increases with the extrapolation distance. To keep the uncertainty within 1% for the 1g and 10g cubes, the extrapolation distance should not be larger than 5 mm.

**Power Drift Monitoring**

All SAR testing is under the EUT install full charged battery and transmit maximum output power. In MVG measurement software, the power reference measurement and power drift measurement procedures are used for monitoring the power drift of EUT during SAR test. Both these procedures measure the field at a specified reference position before and after the SAR testing. The software will calculate the field difference in dB. If the power drifts more than 5%, the SAR will be retested.

**Power Drift measurement**

The drift job measures the field at the same location as the most recent reference job within the same procedure, and with the same settings. The drift measurement gives the field difference in dB from the reading conducted within the last reference measurement. Several drift measurements are possible for

**Measurement Uncertainty**

Per KDB 865664 D01 SAR Measurement 100KHz to 6GHz ,when the highest measurement 1-g SAR within a frequency band is  $<1.5\text{W/kg}$ , the extensive SAR measurement uncertainty analysis described IEEE Std 1528-2013 is not required in SAR report submitted for equipment approval.

## 8. Conducted Output Power

Band: GSM 850	Measured Power (dBm)			Calculation (dB)	Averaged Power (dBm)		
	Channel	128	190		251	128	190
Frequency	824.2	836.6	848.8		824.2	836.6	848.8
GSM (GMSK, Voice)	33.58	33.51	33.47	-9.03	24.55	24.48	24.44
GPRS (GMSK, 1-slot)	32.36	32.33	32.42	-9.03	23.33	23.30	23.39
GPRS (GMSK, 2-slot)	31.25	31.36	31.40	-6.02	25.23	25.34	25.38
GPRS (GMSK, 3-slot)	30.83	30.76	30.81	-4.26	26.57	26.50	26.55
GPRS (GMSK, 4-slot)	29.62	29.64	29.69	-3.01	26.61	26.63	<b>26.68</b>
EGPRS (GMSK, 1-slot)	31.52	31.59	31.53	-9.03	22.49	22.56	22.50
EGPRS (GMSK, 2-slot)	30.36	30.37	30.34	-6.02	24.34	24.35	24.32
EGPRS (GMSK, 3-slot)	29.53	29.59	29.52	-4.26	25.27	25.33	25.26
EGPRS (GMSK, 4-slot)	28.41	28.50	28.48	-3.01	25.40	25.49	25.47

Note:

- Division Factors  
To average the power, the division factor is as follows:  
1TX-slot = 1 transmit time slot out of 8 time slots=> conducted power divided by (8/1) => -9.03dB  
2TX-slots = 2 transmit time slots out of 8 time slots=> conducted power divided by (8/2) => -6.02dB  
3TX-slots = 3 transmit time slots out of 8 time slots=> conducted power divided by (8/3) => -4.26dB  
4TX-slots = 4 transmit time slots out of 8 time slots=> conducted power divided by (8/4) => -3.01dB
- According to the conducted power as above, the body measurements are performed with 4Tx slots for 850MHz for GPRS.
- The device do not support power reduction, so power of hotspot activated as the same as hotspot disabled

Band: GSM 1900 Channel Frequency	Measured Power (dBm)			Calculation (dB)	Averaged Power (dBm)		
	512	661	810		512	661	810
	1850.2	1880.0	1909.8		1850.2	1880.0	1909.8
GSM (GMSK, Voice)	30.65	30.52	30.57	-9.03	21.62	21.49	21.54
GPRS (GMSK, 1-slot)	29.36	29.35	29.41	-9.03	20.33	20.32	20.38
GPRS (GMSK, 2-slot)	28.21	28.25	28.31	-6.02	22.19	22.23	22.29
GPRS (GMSK, 3-slot)	27.72	27.75	27.63	-4.26	23.46	23.49	23.37
GPRS (GMSK, 4-slot)	26.54	26.58	26.55	-3.01	23.53	<b>23.57</b>	23.54
EGPRS (GMSK, 1-slot)	29.75	29.74	29.70	-9.03	20.72	20.71	20.67
EGPRS (GMSK, 2-slot)	28.53	28.59	28.56	-6.02	22.51	22.57	22.54
EGPRS (GMSK, 3-slot)	27.42	27.39	27.40	-4.26	23.16	23.13	23.14
EGPRS (GMSK, 1-slot)	26.83	26.65	26.72	-3.01	23.82	23.64	23.71

Note:

- Division Factors  
To average the power, the division factor is as follows:  
1TX-slot = 1 transmit time slot out of 8 time slots=> conducted power divided by (8/1) => -9.03dB  
2TX-slots = 2 transmit time slots out of 8 time slots=> conducted power divided by (8/2) => -6.02dB  
3TX-slots = 3 transmit time slots out of 8 time slots=> conducted power divided by (8/3) => -4.26dB  
4TX-slots = 4 transmit time slots out of 8 time slots=> conducted power divided by (8/4) => -3.01dB
- According to the conducted power as above, the body measurements are performed with 4Tx slots for 1900MHz for GPRS.
- The device do not support power reduction, so power of hotspot activated as the same as hotspot disabled

Band	WCDMA Band II			WCDMA Band V		
Channel	9262	9400	9538	4132	4182	4233
Frequency	1852.40	1880.00	1907.60	826.40	836.40	846.60
RMC 12.2Kbps	22.61	<b>22.64</b>	22.60	22.54	22.53	<b>22.55</b>
HSDPA Subtest-1	22.42	22.45	22.48	22.36	22.32	22.30
HSDPA Subtest-2	21.37	21.33	21.30	21.45	21.49	21.48
HSDPA Subtest-3	21.18	21.20	21.23	21.36	21.34	21.30
HSDPA Subtest-4	21.09	21.07	21.11	21.30	21.29	21.26
HSUPA Subtest-1	22.25	22.20	22.21	22.48	22.45	22.43
HSUPA Subtest-2	21.47	21.45	21.43	21.42	21.36	21.38
HSUPA Subtest-3	21.21	21.20	21.23	21.25	21.28	21.34
HSUPA Subtest-4	21.18	21.15	21.13	21.20	21.18	21.16
HSUPA Subtest-5	21.10	21.11	21.08	21.12	21.15	21.10

Note:

1. According to the power listed above, the HSDPA and HSUPA were not determined for SAR testing.
2. The default test configuration is to measure SAR with an established radio link between the EUT and a communication test set using a 12.2kbps RMC(reference measurement channel) configuration in test loop mode
3. The device do not support power reduction, so power of hotspot activated as the same as hotspot disabled



WLAN 2.4G						
Mode	802.11b			802.11g		
Channel	1	6	11	1	6	11
Frequency	2412	2437	2462	2412	2437	2462
Average Power (dBm)	15.68	<b>15.84</b>	15.29	12.79	12.67	12.32
Mode	802.11n(HT20)			802.11n(HT40)		
Channel	1	6	11	3	6	9
Frequency	2412	2437	2462	2422	2437	2452
Average Power (dBm)	12.32	12.79	12.29	11.12	10.90	10.60

**Note**

1. Per KDB 248227 D01 v02r02, choose the highest output power channel to test SAR and determine further SAR exclusion.
2. The output power of all data rate were prescan , just the worst case (the lowest data rate) of all mode were shown in report

Bluetooth						
Mode	GFSK			Pi/4DQPSK		
Channel	0	39	78	0	39	78
Frequency	2402	2441	2480	2402	2441	2480
Average Power (dBm)	0.80	0.67	<b>1.37</b>	-0.36	-0.46	-0.13
Mode	8DPSK			BLE		
Channel	0	39	78	0	20	39
Frequency	2402	2441	2480	2402	2440	2480
Average Power (dBm)	-0.18	-0.30	-0.07	0.69	0.52	1.19

Channel	Frequency (GHz)	Max. Tune-up Power (dBm)	Max. Power (mW)	Test distance (mm)	Result	Exclusion thresholds for 1-g SAR	Exclusion thresholds for 10-g SAR
78	2.480	1.50	1.41	5	0.44	3.0	7.5

**Note**

- Per KDB 447498 D01v06, the 1-g SAR test exclusion thresholds for 100 MHz to 6 GHz at *test separation distances* ≤ 50 mm are determined by:  

$$[(\text{max. power of channel, including tune-up tolerance, mW}) / (\text{min. test separation distance, mm})] \cdot [\sqrt{f(\text{GHz})}] \leq 3.0$$
 for 1-g SAR, where  
 ·f(GHz) is the RF channel transmit frequency in GHz  
 ·Power and distance are rounded to the nearest mW and mm before calculation  
 ·The result is rounded to one decimal place for comparison
- Base on the result of note1, RF exposure evaluation of BT is not required.
- Per KDB 248227 D01 v02r02, choose the highest output power channel to test SAR and determine further SAR exclusion.
- The output power of all data rate were prescan, just the worst case (the lowest data rate) of all mode were shown in report.

LTE Band 4

Conducted Power of LTE Band 4								
Bandwidth	Modulation	RB size	RB offset	Channel	Channel	Channel		
				19957	20175	20393		
1.4MHz	QPSK	1	0.00	22.38	<b>22.68</b>	22.23		
			2.00	22.34	22.26	22.38		
			5.00	22.24	22.25	22.64		
		3	0.00	22.02	21.83	22.24		
			1.00	22.35	22.12	22.29		
			2.00	22.33	22.01	22.07		
		6	0.00	22.43	22.57	22.21		
			16QAM	1	0.00	22.45	22.32	22.22
					2.00	22.28	22.42	22.35
	5.00	22.07			22.16	22.23		
	3	0.00		22.01	22.00	22.02		
		1.00		22.09	22.10	21.92		
		2.00		22.04	22.15	21.74		
	6	0.00	22.30	22.25	22.06			
		Bandwidth	Modulation	RB size	RB offset	Channel	Channel	Channel
						19965	20175	20385
	3MHz	QPSK	1	0.00	22.35	22.23	22.29	
				8.00	22.15	21.97	21.82	
14.00				22.24	22.05	22.04		
8			0.00	22.35	22.20	21.86		
			4.00	22.19	22.14	21.97		
			7.00	22.25	21.97	21.89		
15			0.00	22.33	22.37	22.14		
			16QAM	1	0.00	22.14	21.88	21.48
					8.00	22.15	21.92	21.93
14.00		21.78			21.91	21.95		
8		0.00		21.86	21.94	21.86		
		4.00		22.01	22.21	21.77		
		7.00		22.06	22.01	22.04		
15		0.00		22.23	21.97	21.89		

**Conducted Power of LTE Band 4**

Bandwidth	Modulation	RB size	RB offset	Channel	Channel	Channel	
				19975	20175	20375	
5MHz	QPSK	1	0.00	22.22	22.12	22.41	
			13.00	22.41	22.05	22.12	
			24.00	21.88	21.73	22.12	
		12	0.00	22.25	21.89	22.05	
			6.00	22.30	21.94	21.99	
			13.00	22.19	21.86	21.85	
	25	0.00	22.29	21.93	22.02		
	16QAM	1	0.00	22.31	22.14	22.03	
			13.00	21.87	22.28	21.75	
			24.00	21.33	22.31	21.36	
		12	0.00	22.18	22.05	21.17	
			6.00	21.90	21.83	21.90	
			13.00	22.38	22.32	22.35	
		25	0.00	22.13	21.93	22.11	
		Bandwidth	Modulation	RB size	RB offset	Channel	Channel
					20000	20175	20350
10MHz	QPSK	1	0.00	22.17	22.12	22.37	
			25.00	21.66	22.13	22.03	
			49.00	21.50	22.21	21.44	
		25	0.00	21.33	22.02	22.20	
			13.00	21.74	21.79	21.98	
			25.00	22.27	22.01	22.18	
	50	0.00	22.12	21.78	21.95		
	16QAM	1	0.00	21.67	21.67	22.09	
			25.00	22.14	21.61	22.14	
			49.00	21.36	22.08	21.71	
		25	0.00	21.65	21.92	21.99	
			13.00	22.23	21.77	22.19	
			25.00	21.13	22.08	21.45	
		50	0.00	21.98	21.97	21.79	

**Conducted Power of LTE Band 4**

Bandwidth	Modulation	RB size	RB offset	Channel	Channel	Channel		
				20025	20175	20325		
15MHz	QPSK	1	0.00	22.24	22.09	22.33		
			38.00	22.13	21.81	22.05		
			74.00	21.96	21.76	21.49		
		36	0.00	21.65	22.49	22.22		
			18.00	21.50	21.70	21.96		
			39.00	22.11	22.52	22.10		
	75	0.00	22.13	21.96	21.43			
	16QAM	1	0.00	22.19	22.07	22.14		
			38.00	21.47	22.28	21.78		
			74.00	21.77	22.38	22.05		
		36	0.00	22.40	22.31	22.21		
			18.00	21.82	21.45	21.94		
			39.00	22.01	22.18	22.27		
	75	0.00	22.14	22.27	21.21			
Bandwidth	Modulation	RB size	RB offset	Channel	Channel	Channel		
20MHz	QPSK	1	0.00	22.40	22.35	22.48		
			50.00	22.19	21.91	21.83		
			99.00	22.27	22.08	22.46		
		50	0.00	22.04	22.32	22.39		
			25.00	21.66	22.09	22.12		
			50.00	22.06	21.92	22.15		
		100	0.00	22.04	22.08	21.81		
		16QAM	1	0.00	22.23	22.27	22.35	
				50.00	22.08	22.12	22.27	
	99.00			22.39	22.29	22.43		
	50		0.00	21.93	22.05	21.96		
			25.00	22.19	22.34	22.28		
			50.00	22.38	22.21	21.63		
	100		0.00	22.37	22.22	21.95		
	Bandwidth		Modulation	RB size	RB offset	Channel	Channel	Channel
	20MHz		QPSK	1	0.00	22.40	22.35	22.48
		50.00			22.19	21.91	21.83	
		99.00			22.27	22.08	22.46	
50		0.00		22.04	22.32	22.39		
		25.00		21.66	22.09	22.12		
		50.00		22.06	21.92	22.15		
100		0.00		22.04	22.08	21.81		
16QAM		1		0.00	22.23	22.27	22.35	
				50.00	22.08	22.12	22.27	
			99.00	22.39	22.29	22.43		
		50	0.00	21.93	22.05	21.96		
			25.00	22.19	22.34	22.28		
			50.00	22.38	22.21	21.63		
		100	0.00	22.37	22.22	21.95		

LTE Band 5

Conducted Power of LTE Band 5						
Bandwidth	Modulation	RB size	RB offset	Channel	Channel	Channel
				20407	20525	20643
1.4MHz	QPSK	1	0.00	22.34	22.43	22.14
			2.00	21.95	21.98	21.94
			5.00	21.96	22.30	21.85
		3	0.00	21.95	22.39	21.69
			1.00	21.86	21.94	21.94
			2.00	21.76	22.43	21.70
	6	0.00	21.94	22.55	22.20	
	16QAM	1	0.00	21.64	22.25	22.00
			2.00	21.86	22.63	21.78
			5.00	21.57	22.35	22.01
		3	0.00	21.26	21.96	21.68
			1.00	22.09	22.90	22.25
2.00			21.79	22.77	21.97	
6	0.00	21.81	22.45	22.14		
Bandwidth	Modulation	RB size	RB offset	Channel	Channel	Channel
				20415	20525	20635
3MHz	QPSK	1	0.00	21.95	22.06	22.00
			8.00	21.45	21.97	21.81
			14.00	21.65	21.86	21.83
		8	0.00	21.26	21.80	21.46
			4.00	21.45	21.85	21.56
			7.00	21.65	21.66	21.68
	15	0.00	21.95	21.94	21.78	
	16QAM	1	0.00	21.54	21.66	21.92
			8.00	21.73	21.69	21.80
			14.00	21.23	21.88	21.65
		8	0.00	21.25	21.93	21.92
			4.00	21.46	21.98	21.78
			7.00	21.47	21.69	21.45
		15	0.00	21.57	21.72	21.84

Conducted Power of LTE Band 5

Bandwidth	Modulation	RB size	RB offset	Channel	Channel	Channel		
				20425	20525	20625		
5MHz	QPSK	1	0.00	22.08	22.20	22.22		
			13.00	21.75	22.16	22.08		
			24.00	21.53	22.01	22.02		
		12	0.00	21.94	21.89	21.69		
			6.00	21.56	22.00	21.89		
			13.00	21.53	21.78	22.01		
	25	0.00	21.90	21.40	22.13			
	16QAM	1	0.00	21.83	21.31	22.18		
			13.00	21.76	21.35	22.16		
			24.00	21.56	21.54	22.10		
		12	0.00	21.91	21.50	21.97		
			6.00	21.56	21.23	21.86		
13.00			21.53	21.31	22.01			
25	0.00	21.92	21.70	22.12				
Bandwidth	Modulation	RB size	RB offset	Channel	Channel	Channel		
10MHz	QPSK	1	0.00	22.17	22.09	22.12		
			25.00	21.75	22.31	22.03		
			49.00	22.04	<b>22.67</b>	22.30		
		25	0.00	21.72	22.46	22.03		
			13.00	21.92	22.47	21.98		
			25.00	21.68	22.36	22.00		
		50	0.00	21.19	22.04	21.56		
		16QAM	1	0.00	21.64	22.37	21.94	
				25.00	21.53	22.16	21.71	
	49.00			21.45	21.97	21.53		
	25		0.00	21.63	22.18	21.42		
			13.00	21.69	22.30	21.93		
			25.00	21.66	22.24	21.86		
	50		0.00	21.67	22.24	21.77		
	Bandwidth		Modulation	RB size	RB offset	Channel	Channel	Channel
	10MHz		QPSK	1	0.00	22.17	22.09	22.12
		25.00			21.75	22.31	22.03	
		49.00			22.04	<b>22.67</b>	22.30	
25		0.00		21.72	22.46	22.03		
		13.00		21.92	22.47	21.98		
		25.00		21.68	22.36	22.00		
50		0.00		21.19	22.04	21.56		
16QAM		1		0.00	21.64	22.37	21.94	
				25.00	21.53	22.16	21.71	
			49.00	21.45	21.97	21.53		
		25	0.00	21.63	22.18	21.42		
			13.00	21.69	22.30	21.93		
			25.00	21.66	22.24	21.86		
		50	0.00	21.67	22.24	21.77		

LTE Band 7

Conducted Power of LTE Band 7

Bandwidth	Modulation	RB size	RB offset	Channel	Channel	Channel	
				20775	21100	21425	
5MHz	QPSK	1	0.00	22.20	22.26	22.31	
			13.00	22.25	22.05	22.33	
			24.00	21.86	22.19	22.25	
		12	0.00	21.96	22.12	22.26	
			6.00	22.12	22.36	22.34	
			13.00	22.13	22.28	22.35	
		25	0.00	21.96	22.12	22.36	
		16QAM	1	0.00	21.78	22.26	22.22
				13.00	22.15	22.28	22.28
	24.00			22.13	22.08	22.25	
	12		0.00	22.19	22.02	22.30	
			6.00	21.85	22.01	22.25	
			13.00	21.74	22.10	22.34	
	25	0.00	21.76	22.01	22.35		
	Bandwidth	Modulation	RB size	RB offset	Channel	Channel	Channel
				20800	21100	21400	
10MHz	QPSK	1	0.00	22.31	22.27	22.25	
			25.00	22.18	22.26	22.20	
			49.00	22.29	22.15	22.27	
		25	0.00	22.11	22.12	22.30	
			13.00	21.91	22.24	22.13	
			25.00	22.11	22.25	22.11	
		50	0.00	22.01	22.18	22.28	
		16QAM	1	0.00	21.82	22.32	22.26
				25.00	22.20	22.32	22.24
	49.00			22.29	22.31	22.23	
	25		0.00	22.11	22.05	22.21	
			13.00	22.33	22.15	22.22	
			25.00	22.30	22.21	22.30	
	50		0.00	22.21	22.36	22.32	



**Conducted Power of LTE Band 7**

Bandwidth	Modulation	RB size	RB offset	Channel	Channel	Channel
				20825	21100	21375
15MHz	QPSK	1	0.00	22.25	22.28	22.27
			38.00	22.25	22.29	22.24
			74.00	22.10	22.02	22.28
		36	0.00	22.21	22.10	22.26
			18.00	22.11	22.20	22.24
			39.00	22.14	22.22	22.18
	75	0.00	22.20	22.07	22.09	
	16QAM	1	0.00	22.08	22.18	22.21
			38.00	22.20	22.05	22.13
			74.00	22.11	22.13	22.24
		36	0.00	22.12	22.06	22.17
			18.00	22.24	22.18	22.22
			39.00	22.19	22.22	22.28
	75	0.00	22.12	22.05	22.16	
Bandwidth	Modulation	RB size	RB offset	Channel	Channel	Channel
				20850	21100	21350
20MHz	QPSK	1	0.00	<b>22.45</b>	22.01	22.42
			50.00	21.89	22.02	22.27
			99.00	21.74	22.17	22.14
		50	0.00	22.23	22.31	21.99
			25.00	22.07	22.15	22.15
			50.00	22.31	21.96	21.91
	100	0.00	22.12	22.30	22.24	
	16QAM	1	0.00	21.89	22.21	22.25
			50.00	21.78	21.97	22.17
			99.00	21.89	22.36	22.02
		50	0.00	22.13	22.31	22.27
			25.00	21.98	22.38	22.26
			50.00	21.96	22.04	22.26
	100	0.00	21.76	22.15	22.27	

LTE Band 66

Conducted Power of LTE Band 66						
Bandwidth	Modulation	RB size	RB offset	Channel	Channel	Channel
				131979	132322	132665
1.4MHz	QPSK	1	0.00	23.47	23.10	22.77
			2.00	23.56	23.16	22.92
			5.00	23.45	23.13	22.68
		3	0.00	23.53	23.12	22.89
			1.00	23.55	23.14	22.89
			2.00	23.56	23.25	22.66
	6	0.00	22.55	22.13	21.90	
	16QAM	1	0.00	22.59	22.20	21.88
			2.00	22.72	22.36	22.09
			5.00	22.61	22.23	21.87
		3	0.00	22.43	22.07	21.76
			1.00	22.45	22.06	21.84
2.00			22.45	22.09	21.80	
6	0.00	21.38	20.97	20.76		
Bandwidth	Modulation	RB size	RB offset	Channel	Channel	Channel
				131987	132322	132657
3MHz	QPSK	1	0.00	23.58	23.12	22.86
			8.00	23.58	23.15	22.85
			14.00	23.52	23.19	22.53
		8	0.00	22.60	22.21	22.00
			4.00	22.60	22.18	21.97
			7.00	22.54	22.20	21.98
	15	0.00	22.49	22.16	21.94	
	16QAM	1	0.00	22.75	22.30	22.12
			8.00	22.72	22.35	22.02
			14.00	22.68	22.36	22.00
		8	0.00	21.56	21.24	21.00
			4.00	21.57	21.22	21.03
			7.00	21.54	21.24	20.97
		15	0.00	21.42	21.18	20.97

**Conducted Power of LTE Band 66**

Bandwidth	Modulation	RB size	RB offset	Channel	Channel	Channel
				131997	132322	132647
5MHz	QPSK	1	0.00	23.58	23.12	22.92
			13.00	23.61	23.30	22.99
			24.00	23.50	23.22	22.87
		12	0.00	22.48	22.15	21.93
			6.00	22.49	22.16	21.97
			13.00	22.56	22.23	21.87
	25	0.00	22.54	22.25	21.95	
		0.00	22.54	22.13	21.89	
	16QAM	1	13.00	22.61	22.28	21.97
			24.00	22.49	22.22	21.81
			0.00	21.46	21.16	20.95
		12	6.00	21.48	21.17	20.98
			13.00	21.57	21.21	20.88
			25	0.00	21.52	21.23
25		0.00	21.52	21.23	20.96	
		0.00	21.52	21.23	20.96	
Bandwidth		Modulation	RB size	RB offset	Channel	Channel
				132022	132322	132622
10MHz	QPSK	1	0.00	23.53	23.12	22.93
			25.00	23.62	23.29	23.05
			49.00	23.52	23.23	22.85
		25	0.00	22.57	22.26	22.08
			13.00	22.57	22.28	22.06
			25.00	22.63	22.33	22.01
	50	0.00	22.62	22.31	22.01	
		0.00	22.70	22.29	22.12	
	16QAM	1	25.00	22.69	22.47	22.17
			49.00	22.68	22.42	22.02
			0.00	21.54	21.24	21.04
		25	13.00	21.53	21.24	21.07
			25.00	21.60	21.27	21.02
			50	0.00	21.55	21.25
		50	0.00	21.55	21.25	21.04
			0.00	21.55	21.25	21.04

**Conducted Power of LTE Band 66**

Bandwidth	Modulation	RB size	RB offset	Channel	Channel	Channel		
				132047	132322	132597		
15MHz	QPSK	1	0.00	23.55	23.06	22.91		
			38.00	23.51	23.19	22.97		
			74.00	23.54	23.20	22.98		
		36	0.00	22.75	22.26	22.10		
			18.00	22.77	22.44	22.17		
			39.00	22.80	22.39	21.96		
		75	0.00	22.61	22.31	22.19		
		16QAM	1	0.00	22.79	22.22	22.11	
				38.00	22.76	22.38	22.15	
	74.00			22.76	22.42	21.95		
	36		0.00	22.77	22.26	22.11		
			18.00	22.79	22.42	22.15		
			39.00	22.77	22.37	21.97		
	75	0.00	21.58	21.24	21.08			
Bandwidth	Modulation	RB size	RB offset	Channel	Channel	Channel		
20MHz	QPSK	1	0.00	23.41	23.01	23.35		
			50.00	<b>23.70</b>	23.55	23.68		
			99.00	23.60	23.16	23.34		
		50	0.00	22.49	22.24	22.67		
			25.00	22.49	22.24	22.71		
			50.00	22.61	22.27	22.59		
		100	0.00	22.54	22.24	22.60		
		16QAM	1	0.00	22.43	22.02	22.42	
				50.00	22.65	22.45	22.75	
	99.00			22.60	22.22	22.22		
	50		0.00	21.47	21.23	21.66		
			25.00	21.49	21.22	21.70		
			50.00	21.57	21.30	21.59		
	100		0.00	21.54	21.23	21.64		
	Bandwidth		Modulation	RB size	RB offset	Channel	Channel	Channel
	20MHz		QPSK	1	0.00	23.41	23.01	23.35
		50.00			<b>23.70</b>	23.55	23.68	
		99.00			23.60	23.16	23.34	
50		0.00		22.49	22.24	22.67		
		25.00		22.49	22.24	22.71		
		50.00		22.61	22.27	22.59		
100		0.00		22.54	22.24	22.60		
16QAM		1		0.00	22.43	22.02	22.42	
				50.00	22.65	22.45	22.75	
			99.00	22.60	22.22	22.22		
		50	0.00	21.47	21.23	21.66		
			25.00	21.49	21.22	21.70		
			50.00	21.57	21.30	21.59		
		100	0.00	21.54	21.23	21.64		

## 9. Exposure Position Consideration

### 9.1. EUT Antenna Location

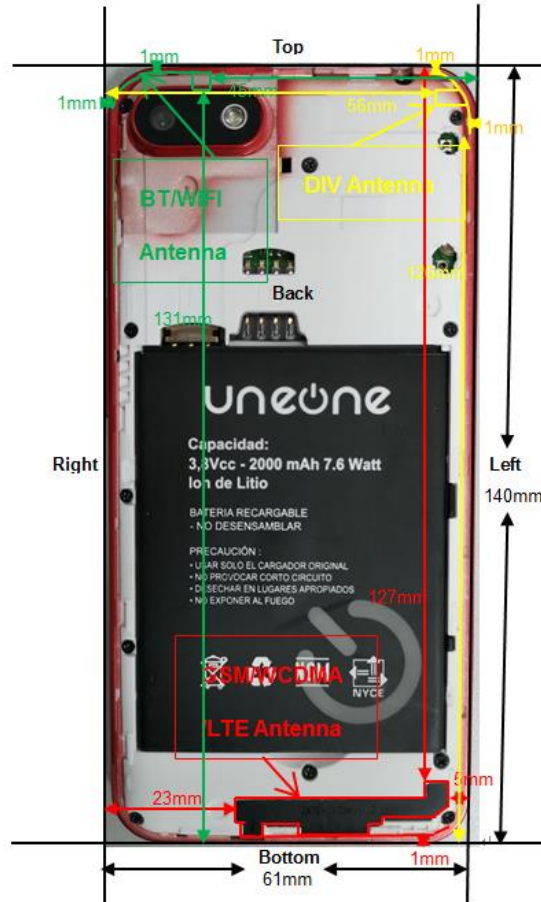

### 9.2. Test Position Consideration

Test Positions						
Mode	Back	Front	Top Side	Bottom Side	Right Side	Left Side
GSM/WCDMA/LTE HOTSPOT	Yes	Yes	No	Yes	Yes	Yes
WIFI/BT	Yes	Yes	Yes	No	Yes	No

**Note:**

1. KDB 447498 D01v06, particular DUT edges were not required to be evaluated for SAR if the antenna-to-edge distance is greater than 2.5cm.

## 10. SAR Test Results Summary

### 10.1. Head 1g SAR Data

Band	Mode	Test Position	CH.	Freq. (MHz)	Ave. Power (dBm)	Tune-Up Limit (dBm)	Power Drift (%)	Meas. SAR1g (W/kg)	Scaling Factor	Reported SAR1g (W/kg)	Limit (W/Kg)
GSM850	voice	Left Cheek	128	824.2	33.58	34.00	-1.25	0.37	1.102	<b>0.41</b>	1.60
		Left Tilt	128	824.2	33.58	34.00	0.94	0.37	1.102	0.41	
		Right Cheek	128	824.2	33.58	34.00	1.51	0.32	1.102	0.35	
		Right Tilt	128	824.2	33.58	34.00	1.49	0.33	1.102	0.36	
GSM1900	voice	Left Cheek	512	1850.2	30.65	31.00	-3.38	0.42	1.084	<b>0.46</b>	
		Left Tilt	512	1850.2	30.65	31.00	-0.21	0.07	1.084	0.08	
		Right Cheek	512	1850.2	30.65	31.00	-2.98	0.23	1.084	0.25	
		Right Tilt	512	1850.2	30.65	31.00	0.15	0.07	1.084	0.08	
WCDMA Band II	RMC	Left Cheek	9400	1880	22.64	23.00	-0.18	0.39	1.086	<b>0.42</b>	
		Left Tilt	9400	1880	22.64	23.00	-3.11	0.07	1.086	0.08	
		Right Cheek	9400	1880	22.64	23.00	-4.34	0.21	1.086	0.23	
		Right Tilt	9400	1880	22.64	23.00	-0.97	0.08	1.086	0.09	
WCDMA Band V	RMC	Left Cheek	4233	846.6	22.55	23.00	2.25	0.27	1.109	<b>0.30</b>	
		Left Tilt	4233	846.6	22.55	23.00	0.45	0.25	1.109	0.28	
		Right Cheek	4233	846.6	22.55	23.00	-0.98	0.26	1.109	0.29	
		Right Tilt	4233	846.6	22.55	23.00	-0.08	0.23	1.109	0.26	
2.4G	802.11b	Left Cheek	6	2437	15.84	16.00	0.76	0.12	1.038	<b>0.12</b>	
		Left Tilt	6	2437	15.84	16.00	-1.23	0.12	1.038	0.12	
		Right Cheek	6	2437	15.84	16.00	-1.38	0.06	1.038	0.06	
		Right Tilt	6	2437	15.84	16.00	-2.19	0.06	1.038	0.06	

Band	Mode	Test Position	CH.	Freq. (MHz)	RB allocation	RB offset	Ave. Power (dBm)	Tune-Up Limit (dBm)	Power Drift (%)	Meas. SAR1g (W/kg)	Scaling Factor	Reported SAR1g (W/kg)
LTE Band 4	QPSK (1.4MHz)	Right Cheek	20175	1732.5	1	0	22.68	23.00	4.63	0.39	1.076	0.42
					3	1	22.12	22.50	0.17	0.36	1.091	0.39
		Right Tilt	20175	1732.5	1	0	22.68	23.00	0.85	0.09	1.076	0.10
					3	1	22.12	22.50	-1.65	0.05	1.091	0.05
		Left Cheek	20175	1732.5	1	0	22.68	23.00	-1.15	0.61	1.076	<b>0.66</b>
					3	1	22.12	22.50	2.48	0.50	1.091	0.55
Left Tilt	20175	1732.5	1	0	22.68	23.00	0.31	0.14	1.076	0.15		
			3	1	22.12	22.50	0.99	0.05	1.091	0.05		
LTE Band 5	QPSK (10MHz)	Right Cheek	20525	836.5	1	25	22.31	22.50	-2.64	0.12	1.045	0.13
					25	13	22.47	22.50	-0.66	0.07	1.007	0.07
		Right Tilt	20525	836.5	1	25	22.31	22.50	-1.35	0.08	1.045	0.08
					25	13	22.47	22.50	2.16	0.04	1.007	0.04
		Left Cheek	20525	836.5	1	25	22.31	22.50	3.74	0.13	1.045	<b>0.14</b>
					25	13	22.47	22.50	-3.36	0.07	1.007	0.07
Left Tilt	20525	836.5	1	25	22.31	22.50	0.66	0.12	1.045	0.13		
			25	13	22.47	22.50	0.98	0.06	1.007	0.06		
LTE Band 7	QPSK (20MHz)	Right Cheek	20850	2510	1	0	22.45	22.50	-1.24	0.11	1.012	<b>0.11</b>
					50	0	22.23	22.50	-1.24	0.08	1.064	0.09
		Right Tilt	20850	2510	1	0	22.45	22.50	-3.09	0.06	1.012	0.06
					50	0	22.23	22.50	0.63	0.04	1.064	0.04
		Left Cheek	20850	2510	1	0	22.45	22.50	2.44	0.11	1.012	0.11
					50	0	22.23	22.50	1.97	0.07	1.064	0.07
Left Tilt	20850	2510	1	0	22.45	22.50	-2.01	0.05	1.012	0.05		
			50	0	22.23	22.50	-1.94	0.03	1.064	0.03		
LTE Band 66	QPSK (20MHz)	Right Cheek	13207 2	1720	1	50	23.70	24.00	-1.31	0.16	1.072	0.17
					50	25	22.49	23.00	0.44	0.08	1.125	0.09
		Right Tilt	13207 2	1720	1	50	23.70	24.00	1.72	0.05	1.072	0.05
					50	25	22.49	23.00	1.88	0.02	1.125	0.02
		Left Cheek	13207 2	1720	1	50	23.70	24.00	0.95	0.31	1.072	<b>0.33</b>
					50	25	22.49	23.00	-0.63	0.17	1.125	0.19
Left Tilt	13207 2	1720	1	50	23.70	24.00	-0.61	0.07	1.072	0.08		
			50	25	22.49	23.00	-0.78	0.03	1.125	0.03		

### 10.2. Body-Worn 1g SAR Data

Band	Mode	Test Position with 10mm	CH.	Freq. (MHz)	Ave. Power (dBm)	Tune-Up Limit (dBm)	Power Drift (%)	Meas. SAR1g (W/kg)	Scaling Factor	Reported SAR1g (W/kg)	Limit (W/Kg)
GSM850	voice	Front	128	824.2	33.58	34.00	-0.95	0.17	1.102	0.19	<b>1.60</b>
		Back	128	824.2	33.58	34.00	-2.27	0.20	1.102	0.22	
	GPRS 4 slots	Front	251	848.8	29.69	30.00	-0.10	0.27	1.074	0.29	
		Back	251	848.8	29.69	30.00	-0.75	0.32	1.074	<b>0.34</b>	
GSM1900	voice	Front	512	1850.2	30.65	31.00	3.11	0.40	1.084	0.43	
		Back	512	1850.2	30.65	31.00	1.19	0.50	1.084	0.54	
	GPRS 4 slots	Front	661	1880	26.58	27.00	1.60	0.77	1.102	0.85	
			512	1850.2	26.54	27.00	4.71	0.93	1.112	1.03	
			661	1880	26.58	27.00	4.33	1.06	1.102	1.17	
		Back	810	1909.8	26.55	27.00	-2.38	1.20	1.109	<b>1.33</b>	
			810-repeated	1909.8	26.55	27.00	-1.82	1.19	1.109	1.32	
WCDMA Band II	RMC	Front	9400	1880	22.64	23.00	4.15	0.68	1.086	0.74	
		Back	9400	1880	22.64	23.00	-2.73	0.72	1.086	<b>0.78</b>	
WCDMA Band V	RMC	Front	4233	846.6	22.55	23.00	-1.63	0.11	1.109	0.12	
		Back	4233	846.6	22.55	23.00	-2.98	0.16	1.109	<b>0.18</b>	
2.4G	802.11b	Front	6	2437	15.84	16.00	0.73	0.04	1.038	0.04	
		Back	6	2437	15.84	16.00	3.04	0.06	1.038	<b>0.06</b>	



Band	Mode	Test Position with 10mm	CH.	Freq. (MHz)	RB allocation	RB offset	Ave. Power (dBm)	Tune-Up Limit (dBm)	Power Drift (%)	Meas. SAR1g (W/kg)	Scaling Factor	Reported SAR1g (W/kg)
LTE Band 4	QPSK (1.4MHz)	Front	20175	1732.5	1	0	22.68	23.00	-2.97	0.62	1.076	0.67
					3	1	22.12	22.50	1.67	0.49	1.091	0.53
		Back	20175	1732.5	1	0	22.68	23.00	1.05	0.70	1.076	<b>0.75</b>
					3	1	22.12	22.50	-1.57	0.62	1.091	0.68
LTE Band 5	QPSK (10MHz)	Front	20525	836.5	1	25	22.31	22.50	0.13	0.11	1.045	0.11
					25	13	22.47	22.50	-1.67	0.05	1.007	0.05
		Back	20525	836.5	1	25	22.31	22.50	-2.51	0.14	1.045	<b>0.15</b>
					25	13	22.47	22.50	-2.77	0.06	1.007	0.06
LTE Band 7	QPSK (20MHz)	Front	20850	2510	1	0	22.45	22.50	4.03	0.28	1.012	0.28
					50	0	22.23	22.50	1.68	0.24	1.064	0.26
		Back	20850	2510	1	0	22.45	22.50	-1.56	0.62	1.012	<b>0.63</b>
					50	0	22.23	22.50	-0.47	0.51	1.064	0.54
LTE Band 66	QPSK (20MHz)	Front	132072	1720	1	50	23.70	24.00	2.08	0.61	1.072	0.65
					50	25	22.49	23.00	1.08	0.51	1.125	0.57
		Back	132072	1720	1	50	23.70	24.00	-1.10	0.68	1.072	<b>0.73</b>
					50	25	22.49	23.00	-1.74	0.52	1.125	0.58

**Note:**

- Per KDB 447498 D01 v06, for each exposure position, if the highest output power channel Reported SAR  $\leq 0.8W/kg$ , other channels SAR testing is not necessary.
- Per KDB 447498 D01 v06, body-worn use is evaluated with the device positioned at 10 mm from a flat phantom filled with head tissue-equivalent medium.
- Per KDB 447498 D01 v06, the report SAR is measured SAR value adjusted for maximum tune-up tolerance. Scaling Factor =  $10^{\frac{\text{tune-up limit power (dBm)} - \text{Ave. power power (dBm)}}{10}}$ , where tune-up limit is the maximum rated power among all production units.  
Reported SAR(W/kg) = Measured SAR (W/kg) \* Scaling Factor.
- Per KDB865664D01 v01r04 perform a second repeated measurement only the ratio of largest to smallest SAR for the original and first repeated measurement is  $>1.20$  or when the original or repeated measurement is  $\geq 1.45W/kg$ .
- Perform a second measurement only if the original, first and second repeated measurement is  $\geq 1.5W/kg$  and the ratio of largest to smallest SAR for the original, first and second repeated measurement is  $>1.20$ .

**10.3. Hotspot 1g SAR Data**

Band	Mode	Test Position with10mm	CH.	Freq. (MHz)	Ave. Power (dBm)	Tune-Up Limit (dBm)	Power Drift (%)	Meas. SAR1g (W/kg)	Scaling Factor	Reported SAR1g (W/kg)	Limit (W/Kg)
GSM850	GPRS 4 slots	Front	251	848.8	29.69	30.00	1.10	0.26	1.074	0.28	1.60
		Back	251	848.8	29.69	30.00	1.57	0.30	1.074	0.32	
		Left	251	848.8	29.69	30.00	-0.07	0.35	1.074	<b>0.38</b>	
		Right	251	848.8	29.69	30.00	-0.96	0.22	1.074	0.24	
		Bottom	251	848.8	29.69	30.00	3.26	0.06	1.074	0.06	
GSM1900	GPRS 4 slots	Front	661	1880	26.58	27.00	2.23	0.71	1.102	0.78	
		Back	512	1850.2	26.54	27.00	3.57	0.95	1.112	1.06	
			661	1880	26.58	27.00	-1.49	1.16	1.102	1.28	
			810	1909.8	26.55	27.00	3.38	1.22	1.109	<b>1.35</b>	
			810-repeated	1909.8	26.55	27.00	-0.15	1.20	1.109	1.33	
		Left	661	1880	26.58	27.00	0.43	0.22	1.102	0.24	
		Right	661	1880	26.58	27.00	-4.22	0.07	1.102	0.08	
		Bottom	512	1850.2	26.54	27.00	-1.20	0.91	1.112	1.01	
			661	1880	26.58	27.00	0.97	1.11	1.102	1.22	
			810	1909.8	26.55	27.00	0.63	1.20	1.109	1.33	
810-repeated	1909.8		26.55	27.00	1.97	1.19	1.109	1.32			
UMTS Band II	RMC	Front	9400	1880	22.64	23.00	-0.49	0.73	1.086	0.79	
		Back	9262	1852.4	22.61	23.00	-1.15	0.93	1.094	1.02	
			9400	1880	22.64	23.00	-1.92	0.98	1.086	1.06	
			9400-repeated	1880	22.64	23.00	-0.49	0.99	1.086	<b>1.08</b>	
			9538	1907.6	22.60	23.00	-2.25	0.93	1.096	1.02	
		Left	9400	1880	22.64	23.00	2.42	0.26	1.086	0.28	
		Right	9400	1880	22.64	23.00	1.72	0.19	1.086	0.21	
		Bottom	9400	1880	22.64	23.00	-1.31	0.68	1.086	0.74	
UMTS Band V	RMC	Front	4233	846.6	22.55	23.00	-2.50	0.14	1.109	0.16	
		Back	4233	846.6	22.55	23.00	-0.95	<b>0.15</b>	1.109	0.17	
		Left	4233	846.6	22.55	23.00	1.16	0.17	1.109	<b>0.19</b>	
		Right	4233	846.6	22.55	23.00	-2.09	0.11	1.109	0.12	
		Bottom	4233	846.6	22.55	23.00	1.32	0.03	1.109	0.03	

2.4G	802.11b	Front	6	2437	15.84	16.00	1.98	0.05	1.038	0.05
		Back	6	2437	15.84	16.00	0.06	0.07	1.038	<b>0.07</b>
		Right	6	2437	15.84	16.00	-0.45	0.04	1.038	0.04
		Top	6	2437	15.84	16.00	1.40	0.04	1.038	0.04

Band	Mode	Test Position with 10mm	CH.	Freq. (MHz)	RB allocation	RB offset	Ave. Power (dBm)	Tune-Up Limit (dBm)	Power Drift (%)	Meas. SAR1g (W/kg)	Scaling Factor	Reported SAR1g (W/kg)		
LTE Band 4	QPSK (1.4MHz)	Front	20175	1732.5	1	0	22.68	23.00	2.31	0.46	1.076	0.50		
					3	1	22.12	22.50	-0.18	0.35	1.091	0.38		
		Back	20175	1732.5	1	0	22.68	23.00	-3.54	0.48	1.076	0.52		
					3	1	22.12	22.50	0.83	0.36	1.091	0.39		
		Left	20175	1732.5	1	0	22.68	23.00	-2.60	0.11	1.076	0.12		
					3	1	22.12	22.50	-1.33	0.05	1.091	0.05		
		Right	20175	1732.5	1	0	22.68	23.00	-2.20	0.06	1.076	0.06		
					3	1	22.12	22.50	-1.27	0.03	1.091	0.03		
		Bottom	20175	1732.5	1	0	22.68	23.00	-2.36	0.71	1.076	<b>0.76</b>		
					3	1	22.12	22.50	0.78	0.60	1.091	0.65		
		LTE Band 5	QPSK (10MHz)	Front	20525	836.5	1	25	22.31	22.50	0.51	0.11	1.045	0.11
							25	13	22.47	22.50	-1.75	0.04	1.007	0.04
Back	20525			836.5	1	25	22.31	22.50	-0.67	0.15	1.045	<b>0.16</b>		
					25	13	22.47	22.50	-3.78	0.07	1.007	0.07		
Left	20525			836.5	1	25	22.31	22.50	-3.09	0.13	1.045	0.14		
					25	13	22.47	22.50	0.69	0.07	1.007	0.07		
Right	20525			836.5	1	25	22.31	22.50	-2.16	0.08	1.045	0.08		
					25	13	22.47	22.50	0.24	0.04	1.007	0.04		
Bottom	20525			836.5	1	25	22.31	22.50	-1.06	0.02	1.045	0.02		
					25	13	22.47	22.50	-1.67	0.01	1.007	0.01		
LTE Band 7	QPSK (20MHz)			Front	20850	2510	1	0	22.45	22.50	0.51	0.30	1.012	0.30
							50	0	22.23	22.50	-1.63	0.19	1.064	0.20
		Back	20850	2510	1	0	22.45	22.50	-1.69	0.67	1.012	0.68		
					50	0	22.23	22.50	-0.57	0.60	1.064	0.64		
		Left	20850	2510	1	0	22.45	22.50	1.35	0.04	1.012	0.04		
					50	0	22.23	22.50	0.69	0.02	1.064	0.02		
		Right	20850	2510	1	0	22.45	22.50	-0.26	0.08	1.012	0.08		
					50	0	22.23	22.50	-1.55	0.05	1.064	0.05		
		Bottom	20850	2510	1	0	22.45	22.50	4.69	0.68	1.012	<b>0.69</b>		
					50	0	22.23	22.50	-1.08	0.58	1.064	0.62		

LTE Band 66	QPSK (20MHz)	Front	132072	1720	1	50	23.70	24.00	0.06	0.59	1.072	0.63
					50	25	22.49	23.00	-1.65	0.39	1.125	0.44
		Back	132072	1720	1	50	23.70	24.00	1.44	0.65	1.072	0.70
					50	25	22.49	23.00	-3.05	0.57	1.125	0.64
		Left	132072	1720	1	50	23.70	24.00	-3.09	0.11	1.072	0.12
					50	25	22.49	23.00	-0.74	0.08	1.125	0.09
		Right	132072	1720	1	50	23.70	24.00	1.98	0.05	1.072	0.05
					50	25	22.49	23.00	-0.17	0.02	1.125	0.02
		Bottom	132072	1720	1	50	23.70	24.00	2.86	0.70	1.072	<b>0.75</b>
					50	25	22.49	23.00	0.36	0.61	1.125	0.69

**Note:**

1. Per KDB 447498 D01 v06, for each exposure position, if the highest output power channel Reported SAR  $\leq 0.8W/kg$ , other channels SAR testing is not necessary.
2. Per KDB 447498 D01 v06, body-worn with hotspot use is evaluated with the device positioned at 10 mm from a flat phantom filled with head tissue-equivalent medium.
3. Per KDB 447498 D01 v06, the report SAR is measured SAR value adjusted for maximum tune-up tolerance. Scaling Factor =  $10^{\frac{(\text{tune-up limit power (dBm)} - \text{Ave. power (dBm)})}{10}}$ , where tune-up limit is the maximum rated power among all production units.  
Reported SAR(W/kg) = Measured SAR (W/kg) \* Scaling Factor.
4. Per KDB865664D01 v01r04 perform a second repeated measurement only the ratio of largest to smallest SAR for the original and first repeated measurement is  $>1.20$  or when the original or repeated measurement is  $\geq 1.45W/kg$ .
5. Perform a second measurement only if the original, first and second repeated measurement is  $\geq 1.5w/kg$  and the ratio of largest to smallest SAR for the original, first and second repeated measurement is  $>1.20$ .

## 10.4. Simultaneous Transmission Conclusion

### Multi-Band Simultaneous Transmission Considerations

According to FCC KDB Publication 447498 D01v05r02, transmitters are considered to be transmitting simultaneously when there is overlapping transmission, with the exception of transmissions during network hand-offs with maximum hand-off duration less than 30 seconds. Possible transmission paths for the EUT are shown in below Figure and are color-coded to indicate communication modes which share the same path. Modes which share the same transmission path cannot transmit simultaneously with one another.



### Simultaneous Transmission Procedures

This device contains transmitters that may operate simultaneously. Therefore simultaneous transmission analysis is required. Per FCC KDB 447498 D01v05r02, simultaneous transmission SAR test exclusion may be applied when the sum of the 1-g SAR for all the simultaneous transmitting antennas in a specific physical test configuration is  $\leq 1.6$  W/kg. When standalone SAR is not required to be measured, per FCC KDB 447498 D01v05r02 4.3.2.2), the following equation must be used to estimate the standalone 1g SAR and 10g extremity SAR for simultaneous transmission assessment involving that transmitter.

$$\text{Estimated SAR} = \frac{\sqrt{f(\text{GHz})}}{7.5(18.75)} \cdot \frac{\text{Max. power of channel, mW}}{\text{Min. Separation Distance, mm}}$$

Mode	Max. tune-up Power (dBm)	Exposure Position	Head	Body -worn
		Test Distance (mm)	5	5
BT	1.5	Estimated SAR (W/kg)	0.06	0.06

**Note:**

- When the minimum *test separation distance* is  $< 5$  mm, a distance of 5 mm according is applied to determine estimated SAR.
- $(\text{max. power of channel, including tune-up tolerance, mW}) / (\text{min. test separation distance, mm}) \cdot [\sqrt{f(\text{GHz})} / x]$  W/kg for test separation distances  $\leq 50$  mm; where  $x = 7.5$  for 1-g SAR, and  $x = 18.75$  for 10-g SAR.
- Next to the mouth exposure requires 1-g SAR, and the wrist-worn condition requires 10-g extremity SAR.

### Simultaneous Transmission Possibilities

The Simultaneous Transmission Possibilities of this device are as below:

NO.	Configuration	Head	Body-Worn	Hotspot
1	GSM850/1900(Voice)+WIFI	YES	YES	NO
2	GPRS 850/1900(DATA)+WIFI	NO	YES	YES
3	WCDMA+ WIFI	YES	YES	YES
4.	LTE+WIFI	YES	YES	YES
5.	GSM850/1900(Voice)+BT	YES	YES	NO
6	GPRS/EDGE 850/1900(DATA)+BT	YES	YES	NO
7.	WCDMA+ BT	YES	YES	NO
8.	LTE+BT	YES	YES	NO

**10.5. SAR Simultaneous Transmission Analysis**

Band	Test Position	Scaled SAR			$\Sigma$ SAR (W/kg)	SPLSR	Remark
		Head	WIFI 2.4G	BT			
GSM850 (voice)	Left Cheek	0.41	0.12	0.06	0.53	N/A	N/A
	Left Tilt	0.41	0.12	0.06	0.53	N/A	N/A
	Right Cheek	0.35	0.06	0.06	0.41	N/A	N/A
	Right Tilt	0.36	0.06	0.06	0.42	N/A	N/A
GSM1900 (voice)	Left Cheek	0.46	0.12	0.06	0.58	N/A	N/A
	Left Tilt	0.08	0.12	0.06	0.20	N/A	N/A
	Right Cheek	0.25	0.06	0.06	0.31	N/A	N/A
	Right Tilt	0.08	0.06	0.06	0.14	N/A	N/A
WCDMA Band II	Left Cheek	0.42	0.12	0.06	0.54	N/A	N/A
	Left Tilt	0.08	0.12	0.06	0.20	N/A	N/A
	Right Cheek	0.23	0.06	0.06	0.29	N/A	N/A
	Right Tilt	0.09	0.06	0.06	0.15	N/A	N/A
WCDMA Band V	Left Cheek	0.30	0.12	0.06	0.42	N/A	N/A
	Left Tilt	0.28	0.12	0.06	0.40	N/A	N/A
	Right Cheek	0.29	0.06	0.06	0.35	N/A	N/A
	Right Tilt	0.26	0.06	0.06	0.32	N/A	N/A

Band	Test Position	RB allocation	Scaled			$\Sigma$ SAR (W/kg)	SPLSR	Remark
			Head	WiFi2.4G	Bluetooth			
LTE Band 4 QPSK (1.4MHz)	Right Cheek	1	0.42	0.06	0.06	0.48	N/A	N/A
		3	0.39	0.06	0.06	0.45	N/A	N/A
	Right Tilt	1	0.1	0.06	0.06	0.16	N/A	N/A
		3	0.05	0.06	0.06	0.11	N/A	N/A
	Left Cheek	1	0.66	0.12	0.06	<b>0.78</b>	N/A	N/A
		3	0.55	0.12	0.06	0.67	N/A	N/A
	Left Tilt	1	0.15	0.12	0.06	0.27	N/A	N/A
		3	0.05	0.12	0.06	0.17	N/A	N/A
LTE Band 5 QPSK (10MHz)	Right Cheek	1	0.13	0.06	0.06	0.19	N/A	N/A
		25	0.07	0.06	0.06	0.13	N/A	N/A
	Right Tilt	1	0.08	0.06	0.06	0.14	N/A	N/A
		25	0.04	0.06	0.06	0.10	N/A	N/A
	Left Cheek	1	0.14	0.12	0.06	0.26	N/A	N/A
		25	0.07	0.12	0.06	0.19	N/A	N/A
	Left Tilt	1	0.13	0.12	0.06	0.25	N/A	N/A
		25	0.06	0.12	0.06	0.18	N/A	N/A
LTE Band 7 QPSK (20MHz)	Right Cheek	1	0.11	0.06	0.06	0.17	N/A	N/A
		50	0.09	0.06	0.06	0.15	N/A	N/A
	Right Tilt	1	0.06	0.06	0.06	0.12	N/A	N/A
		50	0.04	0.06	0.06	0.10	N/A	N/A
	Left Cheek	1	0.11	0.12	0.06	0.23	N/A	N/A
		50	0.07	0.12	0.06	0.19	N/A	N/A
	Left Tilt	1	0.05	0.12	0.06	0.17	N/A	N/A
		50	0.03	0.12	0.06	0.15	N/A	N/A
LTE Band 66 QPSK (20MHz)	Right Cheek	1	0.17	0.06	0.06	0.23	N/A	N/A
		50	0.09	0.06	0.06	0.15	N/A	N/A
	Right Tilt	1	0.05	0.06	0.06	0.11	N/A	N/A
		50	0.02	0.06	0.06	0.08	N/A	N/A
	Left Cheek	1	0.33	0.12	0.06	0.45	N/A	N/A
		50	0.19	0.12	0.06	0.31	N/A	N/A
	Left Tilt	1	0.08	0.12	0.06	0.20	N/A	N/A
		50	0.03	0.12	0.06	0.15	N/A	N/A

Band	Test Position	Scaled SAR			$\Sigma$ SAR (W/kg)	SPLSR	Remark
		Body-Worn	WIFI 2.4G	BT			
GSM850 (voice)	Front	0.19	0.04	0.06	0.25	N/A	N/A
	Back	0.22	0.06	0.06	0.28	N/A	N/A
GSM850 (GPRS 4slot)	Front	0.29	0.04	0.06	0.35	N/A	N/A
	Back	0.34	0.06	0.06	0.40	N/A	N/A
GSM1900 (voice)	Front	0.43	0.04	0.06	0.49	N/A	N/A
	Back	0.54	0.06	0.06	0.60	N/A	N/A
GSM1900 (GPRS 4slot)	Front	0.85	0.04	0.06	0.91	N/A	N/A
	Back	1.03	0.06	0.06	1.09	N/A	N/A
		1.17	0.06	0.06	1.23	N/A	N/A
		1.33	0.06	0.06	<b>1.39</b>	N/A	N/A
		1.32	0.06	0.06	1.38	N/A	N/A
WCDMA Band II	Front	0.74	0.04	0.06	0.80	N/A	N/A
	Back	0.78	0.06	0.06	0.84	N/A	N/A
WCDMA Band V	Front	0.12	0.04	0.06	0.18	N/A	N/A
	Back	0.18	0.06	0.06	0.24	N/A	N/A



Band	Test Position	RB allocation	Scaled			$\Sigma$ SAR (W/kg)	SPLSR	Remark
			Body-Worn	WIFI 2.4G	Bluetooth			
LTE Band 4 QPSK (1.4MHz)	Front	1	0.67	0.04	0.06	0.73	N/A	N/A
		3	0.53	0.04	0.06	0.59	N/A	N/A
	Back	1	0.75	0.06	0.06	0.81	N/A	N/A
		3	0.68	0.06	0.06	0.74	N/A	N/A
LTE Band 5 QPSK (10MHz)	Front	1	0.11	0.04	0.06	0.17	N/A	N/A
		25	0.05	0.04	0.06	0.11	N/A	N/A
	Back	1	0.15	0.06	0.06	0.21	N/A	N/A
		25	0.06	0.06	0.06	0.12	N/A	N/A
LTE Band 7 QPSK (20MHz)	Front	1	0.28	0.04	0.06	0.34	N/A	N/A
		50	0.26	0.04	0.06	0.32	N/A	N/A
	Back	1	0.63	0.06	0.06	0.69	N/A	N/A
		50	0.54	0.06	0.06	0.60	N/A	N/A
LTE Band 66 QPSK (20MHz)	Front	1	0.65	0.04	0.06	0.71	N/A	N/A
		50	0.57	0.04	0.06	0.63	N/A	N/A
	Back	1	0.73	0.06	0.06	0.79	N/A	N/A
		50	0.58	0.06	0.06	0.64	N/A	N/A

Band	Test Position	Scaled SAR		Σ SAR (W/kg)	SPLSR	Remark
		Hotspot	WIFI 2.4G			
GSM850 (GPRS)	Front	0.28	0.05	0.33	N/A	N/A
	Back	0.32	0.07	0.39	N/A	N/A
	Left	0.38	/	0.38	N/A	N/A
	Right	0.24	0.04	0.28	N/A	N/A
	Bottom	0.06	0.04	0.10	N/A	N/A
	Top	/	/	/	N/A	N/A
GSM1900(GPRS)	Front	0.78	0.05	0.83	N/A	N/A
	Back	1.06	0.07	1.13	N/A	N/A
		1.28	0.07	1.35	N/A	N/A
		1.35	0.07	<b>1.42</b>	N/A	N/A
		1.33	0.07	1.40	N/A	N/A
	Left	0.24	/	0.24	N/A	N/A
	Right	0.08	0.04	0.12	N/A	N/A
	Bottom	1.01	0.04	1.05	N/A	N/A
		1.22	0.04	1.26	N/A	N/A
		1.33	0.04	1.37	N/A	N/A
		0.24	0.04	0.28	N/A	N/A
		1.32	0.04	1.36	N/A	N/A
	Top	/	/	/	N/A	N/A
WCDMA Band II	Front	0.79	0.05	0.84	N/A	N/A
	Back	1.02	0.07	1.09	N/A	N/A
		1.06	0.07	1.13	N/A	N/A
		1.08	0.07	1.15	N/A	N/A
		1.02	0.07	1.09	N/A	N/A
	Left	0.28	/	0.28	N/A	N/A
	Right	0.21	0.04	0.25	N/A	N/A
	Bottom	0.74	0.04	0.78	N/A	N/A
Top	/	/	/	N/A	N/A	
WCDMA Band V	Front	0.16	0.05	0.21	N/A	N/A
	Back	0.17	0.07	0.24	N/A	N/A
	Left	0.19	/	0.19	N/A	N/A
	Right	0.12	0.04	0.16	N/A	N/A
	Bottom	0.03	0.04	0.07	N/A	N/A
	Top	/	/	/	N/A	N/A

Band	Test Position	RB allocation	Scaled		$\Sigma$ SAR (W/kg)	SPLSR	Remark	
			Hotspot	WiFi2.4G				
LTE Band 4 QPSK (1.4MHz)	Front	1	0.5	0.05	0.55	N/A	N/A	
		3	0.38	0.05	0.43	N/A	N/A	
	Back	1	0.52	0.07	0.59	N/A	N/A	
		3	0.39	0.07	0.46	N/A	N/A	
	Left	1	0.12	/	0.12	N/A	N/A	
		3	0.05	/	0.05	N/A	N/A	
	Right	1	0.06	0.04	0.10	N/A	N/A	
		3	0.03	0.04	0.07	N/A	N/A	
	Bottom	1	0.76	/	0.76	N/A	N/A	
		3	0.65	/	0.65	N/A	N/A	
	Top	1	/	0.04	0.04	N/A	N/A	
		3	/	0.04	0.04	N/A	N/A	
	LTE Band 4 QPSK (20MHz)	Front	1	0.11	0.05	0.16	N/A	N/A
			25	0.04	0.05	0.09	N/A	N/A
		Back	1	0.16	0.07	0.23	N/A	N/A
			25	0.07	0.07	0.14	N/A	N/A
Left		1	0.14	/	0.14	N/A	N/A	
		25	0.07	/	0.07	N/A	N/A	
Right		1	0.08	0.04	0.12	N/A	N/A	
		25	0.04	0.04	0.08	N/A	N/A	
Bottom		1	0.02	/	0.02	N/A	N/A	
		25	0.01	/	0.01	N/A	N/A	
Top		1	/	0.04	0.04	N/A	N/A	
		50	/	0.04	0.04	N/A	N/A	
LTE Band 7 QPSK (10MHz)		Front	1	0.30	0.05	0.35	N/A	N/A
			50	0.20	0.05	0.25	N/A	N/A
		Back	1	0.68	0.07	0.75	N/A	N/A
			50	0.64	0.07	0.71	N/A	N/A
	Left	1	0.04	/	0.04	N/A	N/A	
		50	0.02	/	0.02	N/A	N/A	
	Right	1	0.08	0.04	0.12	N/A	N/A	
		50	0.05	0.04	0.09	N/A	N/A	
	Bottom	1	0.69	/	0.69	N/A	N/A	
		25	0.62	/	0.62	N/A	N/A	
	Top	1	/	0.04	0.04	N/A	N/A	
		25	/	0.04	0.04	N/A	N/A	

LTE Band 66 QPSK (20MHz)	Front	1	0.63	0.05	0.68	N/A	N/A
		50	0.44	0.05	0.49	N/A	N/A
	Back	1	0.7	0.07	0.77	N/A	N/A
		50	0.64	0.07	0.71	N/A	N/A
	Left	1	0.12	/	0.12	N/A	N/A
		50	0.09	/	0.09	N/A	N/A
	Right	1	0.05	0.04	0.09	N/A	N/A
		50	0.02	0.04	0.06	N/A	N/A
	Bottom	1	0.75	/	0.75	N/A	N/A
		50	0.69	/	0.69	N/A	N/A
	Top	1	/	0.04	0.04	N/A	N/A
		50	/	0.04	0.04	N/A	N/A

### Simultaneous Transmission Conclusion

The above numerical summed SAR results for all the case simultaneous transmission conditions were below the SAR limit. Therefore, the above analysis is sufficient to determine that simultaneous transmission cases will not exceed the SAR limit and therefore measured volumetric simultaneous SAR summation is not required per FCC KDB Publication 447498 D01v05r02.

**10.6. Measurement Uncertainty (450MHz-3GHz)**

**UNCERTAINTY EVALUATION FOR HEADSET SAR**

Uncertainty Component	Description	Uncertainty Value(%)	Probably Distribution	Div.	(Ci) 1g	(Ci) 10g	Std. Unc. 1g(%)	Std. Unc. 10g(%)	v
<b>Measurement system</b>									
Probe calibration	7.2.1	5.8	N	1	1	1	5.8	5.8	∞
Axial isotropy	7.2.1.1	3.5	R	$\sqrt{3}$	$(1-C_p)^{1/2}$	$(1-C_p)^{1/2}$	1.43	1.43	∞
Hemispherical isotropy	7.2.1.1	5.9	R	$\sqrt{3}$	$\sqrt{C_p}$	$\sqrt{C_p}$	2.41	2.41	∞
Boundary Effects	7.2.1.4	1.00	R	$\sqrt{3}$	1	1	0.58	0.58	∞
Linearity	7.2.1.2	4.70	R	$\sqrt{3}$	1	1	2.71	2.71	∞
System detection limits	7.2.1.2	1	R	$\sqrt{3}$	1	1	0.58	0.58	∞
Modulation Response	7.2.1.3	3	N	1	1	1	3.00	3.00	∞
Readout Electronics	7.2.1.5	0.5	N	1	1	1	0.50	0.50	∞
Response Time	7.2.1.6	0	R	$\sqrt{3}$	1	1	0.00	0.00	∞
Integration Time	7.2.1.7	1.4	R	$\sqrt{3}$	1	1	0.81	0.81	∞
RF Ambient Conditions-Noise	7.2.3.7	3	R	$\sqrt{3}$	1	1	1.73	1.73	∞
RF Ambient Conditions-Reflection	7.2.3.7	3	R	$\sqrt{3}$	1	1	1.73	1.73	∞
Probe positioned mechanical Tolerance	7.2.2.1	1.4	R	$\sqrt{3}$	1	1	0.81	0.81	∞
Probe positioning with respect to phantom shell	7.2.2.3	1.4	R	$\sqrt{3}$	1	1	0.81	0.81	∞
Extrapolation interpolation and integration algorithms for Max.SAR evaluation	7.2.4	2.3	R	1	1	1	1.33	1.33	∞
<b>Test sample related</b>									
Test sample positioning	7.2.2.4.4	2.6	N	1	1	1	2.60	2.60	∞
Device holder uncertainty	7.2.2.4.2 7.2.2.4.3	3	N	1	1	1	3.00	3.00	∞
output power variation-SAR drift measurement	7.2.3.6	5	R	$\sqrt{3}$	1	1	2.89	2.89	∞
SAR scaling	7.2.5	2	R	$\sqrt{3}$	1	1	1.15	1.15	∞
<b>Phantom and tissue parameters</b>									
Phantom uncertainty (shape and thickness tolerances)	7.2.2.2	4	R	$\sqrt{3}$	1	1	2.31	2.31	∞
uncertainty in SAR correction for deviation (in permittivity and conductivity)	7.2.6	2	N	1	1	0.84	2.00	1.68	∞
Liquid conductivity (temperature uncertainty)	7.2.3.5	2.5	N	1	0.78	0.71	1.95	1.78	∞
Liquid conductivity -measurement uncertainty	7.2.3.3	4	N	1	0.23	0.26	0.92	1.04	∞
Liquid permittivity (temperature uncertainty)	7.2.3.5	2.5	N	1	0.78	0.71	1.95	1.78	∞
Liquid permittivity measurement uncertainty	7.2.3.4	5	N	1	0.23	0.26	1.15	1.30	∞
Combined standard uncertainty			RSS				10.83	10.54	
Expanded uncertainty (95%CONFIDENCEINTERVAL)			k				21.26	21.08	

**UNCERTAINTY FOR PERFORMANCE CHECK**

Uncertainty Component	Description	Uncertainty Value(%)	Probably Distribution	Div.	(Ci) 1g	(Ci) 10g	Std. Unc. 1g(%)	Std. Unc. 10g(%)	v
<b>Measurement system</b>									
Probe calibration	7.2.1	5.8	N	1	1	1	5.8	5.8	∞
Axial isotropy	7.2.1.1	3.5	R	$\sqrt{3}$	$(1-C_p)^{1/2}$	$(1-C_p)^{1/2}$	1.43	1.43	∞
Hemispherical isotropy	7.2.1.1	5.9	R	$\sqrt{3}$	$\sqrt{C_p}$	$\sqrt{C_p}$	2.41	2.41	∞
Boundary Effects	7.2.1.4	1.00	R	$\sqrt{3}$	1	1	0.58	0.58	∞
Linearity	7.2.1.2	4.70	R	$\sqrt{3}$	1	1	2.71	2.71	∞
System detection limits	7.2.1.2	1	R	$\sqrt{3}$	1	1	0.58	0.58	∞
Modulation Response	7.2.1.3	3	N	1	1	1	0.00	0.00	∞
Readout Electronics	7.2.1.5	0.5	N	1	1	1	0.50	0.50	∞
Response Time	7.2.1.6	0	R	$\sqrt{3}$	1	1	0.00	0.00	∞
Integration Time	7.2.1.7	1.4	R	$\sqrt{3}$	1	1	0.81	0.81	∞
RF Ambient Conditions-Noise	7.2.3.7	3	R	$\sqrt{3}$	1	1	1.73	1.73	∞
RF Ambient Conditions-Reflection	7.2.3.7	3	R	$\sqrt{3}$	1	1	1.73	1.73	∞
Probe positioned mechanical Tolerance	7.2.2.1	1.4	R	$\sqrt{3}$	1	1	0.81	0.81	∞
Probe positioning with respect to phantom shell	7.2.2.3	1.4	R	$\sqrt{3}$	1	1	0.81	0.81	∞
Extrapolation interpolation and integration algorithms for Max.SAR evaluation	7.2.4	2.3	R	1	1	1	1.33	1.33	∞
<b>Dipole</b>									
Deviation of experimental source from numerical source		4	N	1	1	1	4.00	4.00	∞
Input power and SAR drift measurement	7.2.3.6	5	R	$\sqrt{3}$	1	1	2.89	2.89	∞
Dipole axis to liquid distance		2	R	$\sqrt{3}$	1	1			∞
<b>Phantom and tissue parameters</b>									
Phantom uncertainty (shape and thickness tolerances)	7.2.2.2	4	R	$\sqrt{3}$	1	1	2.31	2.31	∞
uncertainty in SAR correction for deviation (in permittivity and conductivity)	7.2.6	2	N	1	1	0.84	2.00	1.68	∞
Liquid conductivity (temperature uncertainty)	7.2.3.5	2.5	N	1	0.78	0.71	1.95	1.78	∞
Liquid conductivity -measurement uncertainty	7.2.3.3	4	N	1	0.23	0.26	0.92	1.04	∞
Liquid permittivity (temperature uncertainty)	7.2.3.5	2.5	N	1	0.78	0.71	1.95	1.78	∞
Liquid permittivity measurement uncertainty	7.2.3.4	5	N	1	0.23	0.26	1.15	1.30	∞
Combined standard uncertainty			RSS				10.15	10.05	
Expanded uncertainty (95%CONFIDENCEINTERVAL)			k				20.29	20.10	

### 10.7. Test Equipment List

Test Equipment	Manufacturer	Model	Serial Number	Calibration	
				Calibration Date (D.M.Y)	Calibration Due (D.M.Y)
PC	Lenovo	H3050	N/A	N/A	N/A
Signal Generator	Agilent	N5182A	MY47070282	Sep. 28, 2018	Sep. 27, 2019
Multimeter	Keithley	Multimeter 2000	4078275	Sep. 28, 2018	Sep. 27, 2019
Network Analyzer	Agilent	8753E	US38432457	Sep. 28, 2018	Sep. 27, 2019
Wireless Communication Test Set	R & S	CMU200	111382	Sep. 28, 2018	Sep. 27, 2019
Wideband Radio Communication Tester	R&S	CMW500	114220	Sep. 28, 2018	Sep. 27, 2019
Power Meter	Agilent	E4418B	GB43312526	Sep. 28, 2018	Sep. 27, 2019
Power Meter	Agilent	E4416A	MY45101555	Sep. 28, 2018	Sep. 27, 2019
Power Meter	Agilent	N1912A	MY50001018	Sep. 28, 2018	Sep. 27, 2019
Power Sensor	Agilent	E9301A	MY41497725	Sep. 28, 2018	Sep. 27, 2019
Power Sensor	Agilent	E9327A	MY44421198	Sep. 28, 2018	Sep. 27, 2019
Power Sensor	Agilent	E9323A	MY53070005	Sep. 28, 2018	Sep. 27, 2019
Power Amplifier	PE	PE15A4019	112342	N/A	N/A
Directional Coupler	Agilent	722D	MY52180104	N/A	N/A
Attenuator	Chensheng	FF779	134251	N/A	N/A
E-Field PROBE	MVG	SSE5	SN 07/15 EP248	Jan. 09, 2019	Jan. 08, 2020
DIPOLE 835	MVG	SID835	SN 16/15 DIP 0G835-369	Jun. 05, 2018	Jun. 04, 2021
DIPOLE 1800	MVG	SID 1800	SN 16/15 DIP 1G800-371	Jun. 05, 2018	Jun. 04, 2021
DIPOLE 1900	MVG	SID1900	SN 16/15 DIP 1G900-372	Jun. 05, 2018	Jun. 04, 2021
DIPOLE 2450	MVG	SID 2450	SN 16/15 DIP 2G450-374	Jun. 05, 2018	Jun. 04, 2021
DIPOLE 2600	MVG	SID 2600	SN 16/15 DIP 2G600-375	Jun. 05, 2018	Jun. 04, 2021
Limesar Dielectric Probe	MVG	SCLMP	SN 19/15 OCPG71	Jun. 05, 2018	Jun. 04, 2021
Communication Antenna	MVG	ANTA59	SN 39/14 ANTA59	N/A	N/A
Mobile Phone Position Device	MVG	MSH101	SN 19/15 MSH101	N/A	N/A
Dummy Probe	MVG	DP66	SN 13/15 DP66	N/A	N/A
SAM PHANTOM	MVG	SAM120	SN 19/15 SAM120	N/A	N/A
PHANTOM TABLE	MVG	TABP101	SN 19/15 TABP101	N/A	N/A
Robot TABLE	MVG	TABP61	SN 19/15 TABP61	N/A	N/A
6 AXIS ROBOT	KUKA	KR6-R900	501822	N/A	N/A

- Note:**
- 1.N/A means this equipment no need to calibrate
  - 2.Each Time means this device need to calibrate every use time
  3. The dipole was not damaged properly repaired.
  4. The measured SAR deviates from the calibrated SAR value by less than 10%
  5. The most recent return-loss result meets the required 20 dB minimum return-loss requirement
  6. The most recent measurement of the real or imaginary parts of the impedance deviates by less than 5 Ω from the previous measurement.