



BNetzA-CAB-02/21-102

## TEST REPORT

Test report no.: 1-2685/21-03-13

### Testing laboratory

**CTC advanced GmbH**  
Untertuerkheimer Strasse 6 – 10  
66117 Saarbruecken / Germany  
Phone: + 49 681 5 98 - 0  
Fax: + 49 681 5 98 - 9075  
Internet: <https://www.ctcadvanced.com>  
e-mail: [mail@ctcadvanced.com](mailto:mail@ctcadvanced.com)

#### Accredited Testing Laboratory:

The testing laboratory (area of testing) is accredited according to DIN EN ISO/IEC 17025 (2018-03) by the Deutsche Akkreditierungsstelle GmbH (DAkkS). The accreditation is valid for the scope of testing procedures as stated in the accreditation certificate starting with the registration number: D-PL-12076-01.

### Applicant

**Berlinger & Co.AG**  
Mitteldorfstrasse 2  
9608 Ganterschwil / SWITZERLAND  
Phone: +41 71 982 88 11  
Contact: Bernd Heisterkamp  
e-mail: [RnD@berlinger.com](mailto:RnD@berlinger.com)

### Manufacturer

**Berlinger & Co.AG**  
Mitteldorfstrasse 2  
9608 Ganterschwil / SWITZERLAND

### Test standard/s

FCC - Title 47 CFR Part 22      FCC - Title 47 of the Code of Federal Regulations; Chapter I; Part 22 - Public mobile services  
FCC - Title 47 CFR Part 24      FCC - Title 47 of the Code of Federal Regulations; Chapter I; Part 24 - Personal communications services  
For further applied test standards please refer to section 3 of this test report.

### Test Item

**Kind of test item:**                      **SmartMonitor**  
**Model name:**                            **Shipment Logger L/M; Site Logger**  
**FCC ID:**                                    **2AIEO-SMSHL, 2AIEO-SMSIL**  
**ISED certification number:**        **21299-SMSHL, 21299-SMSIL**  
**Frequency:**                              **LTE band 2; 4; 5; 12 and 13**  
**Technology tested:**                    **LTE Cat M**  
**Antenna:**                                 **Integrated antenna**  
**Power supply:**                         **5 V DC by external mains adapter / 3.6 V DC by battery**  
**Temperature range:**                    **-30°C to +75°C**

This test report is electronically signed and valid without handwritten signature. For verification of the electronic signatures, the public keys can be requested at the testing laboratory.

### Test report authorized:

Andreas Luckenbill  
Head of Department  
Radio Communications

### Test performed:

Marco Bertolino  
Lab Manager  
Radio Communications

## 1 Table of contents

<b>1</b>	<b>Table of contents</b>	<b>2</b>
<b>2</b>	<b>General information</b>	<b>4</b>
2.1	Notes and disclaimer	4
2.2	Application details	4
2.3	Test laboratories sub-contracted	4
<b>3</b>	<b>Test standard/s, references and accreditations</b>	<b>5</b>
<b>4</b>	<b>Reporting statements of conformity – decision rule</b>	<b>6</b>
<b>5</b>	<b>Test environment</b>	<b>7</b>
<b>6</b>	<b>Test item</b>	<b>7</b>
6.1	General description	7
6.2	Additional information	7
<b>7</b>	<b>Description of the test setup</b>	<b>8</b>
7.1	Shielded semi anechoic chamber	9
7.2	Shielded fully anechoic chamber	10
7.3	Radiated measurements > 18 GHz	11
7.4	Conducted measurements normal and extreme conditions	12
<b>8</b>	<b>Sequence of testing</b>	<b>13</b>
8.1	Sequence of testing radiated spurious 9 kHz to 30 MHz	13
8.2	Sequence of testing radiated spurious 30 MHz to 1 GHz	14
8.3	Sequence of testing radiated spurious 1 GHz to 18 GHz	15
8.4	Sequence of testing radiated spurious above 18 GHz	16
<b>9</b>	<b>Measurement uncertainty</b>	<b>17</b>
<b>10</b>	<b>Summary of measurement results</b>	<b>18</b>
10.1	Part 22/RSS-132: LTE band 5	18
<b>11</b>	<b>RF measurements</b>	<b>19</b>
11.1	Description of test setup	19
11.2	Results LTE band 5	19
11.2.1	RF output power	19
11.2.2	Frequency stability	22
11.2.3	Spurious emissions radiated	24
11.2.4	Spurious emissions conducted	31
11.2.5	Block edge compliance	40
11.2.6	Occupied bandwidth	44
<b>12</b>	<b>Summary of measurement results</b>	<b>52</b>
12.1	Part 24/RSS-133: LTE band 2	52
<b>13</b>	<b>RF measurements</b>	<b>53</b>
13.1	Description of test setup	53
13.2	Results LTE band 2	53
13.2.1	RF output power	53

13.2.2	Frequency stability .....	58
13.2.3	Spurious emissions radiated .....	60
13.2.4	Spurious emissions conducted .....	67
13.2.5	Block edge compliance.....	76
13.2.6	Occupied bandwidth .....	80
<b>14</b>	<b>Summary of measurement results .....</b>	<b>88</b>
<b>14.1</b>	<b>Part 27/RSS-139: LTE band 4 .....</b>	<b>88</b>
<b>14.2</b>	<b>Part 27/RSS-130: LTE band 12 .....</b>	<b>89</b>
<b>14.3</b>	<b>Part 27/RSS-130: LTE band 13 .....</b>	<b>89</b>
<b>15</b>	<b>RF measurements .....</b>	<b>90</b>
<b>15.1</b>	<b>Description of test setup .....</b>	<b>90</b>
<b>15.2</b>	<b>LTE technologies supported by EUT .....</b>	<b>90</b>
<b>15.3</b>	<b>Results LTE band 4 .....</b>	<b>91</b>
15.3.1	RF output power .....	91
15.3.2	Frequency stability .....	95
15.3.3	Spurious emissions radiated .....	97
15.3.4	Spurious emissions conducted .....	104
15.3.5	Block edge compliance.....	113
15.3.6	Occupied bandwidth .....	117
<b>15.4</b>	<b>Results LTE band 12 .....</b>	<b>125</b>
15.4.1	RF output power .....	125
15.4.2	Frequency stability .....	129
15.4.3	Spurious emissions radiated .....	131
15.4.4	Spurious emissions conducted .....	137
15.4.5	Block edge compliance.....	145
15.4.6	Occupied bandwidth .....	148
<b>15.5</b>	<b>Results LTE band 13 .....</b>	<b>156</b>
15.5.1	RF output power .....	156
15.5.2	Frequency stability .....	158
15.5.3	Spurious emissions radiated .....	160
15.5.4	Spurious emissions conducted .....	166
15.5.5	Block edge compliance.....	174
15.5.6	Occupied bandwidth .....	177
<b>16</b>	<b>Observations.....</b>	<b>185</b>
<b>17</b>	<b>Glossary .....</b>	<b>186</b>
<b>18</b>	<b>Document history .....</b>	<b>187</b>
<b>19</b>	<b>Accreditation Certificate – D-PL-12076-01-04 .....</b>	<b>187</b>
<b>20</b>	<b>Accreditation Certificate – D-PL-12076-01-05 .....</b>	<b>188</b>

## 2 General information

### 2.1 Notes and disclaimer

The test results of this test report relate exclusively to the test item specified in this test report. CTC advanced GmbH does not assume responsibility for any conclusions and generalizations drawn from the test results with regard to other specimens or samples of the type of the equipment represented by the test item.

The test report may only be reproduced or published in full. Reproduction or publication of extracts from the report requires the prior written approval of CTC advanced GmbH.

The testing service provided by CTC advanced GmbH has been rendered under the current "General Terms and Conditions for CTC advanced GmbH".

CTC advanced GmbH will not be liable for any loss or damage resulting from false, inaccurate, inappropriate or incomplete product information provided by the customer.

Under no circumstances does the CTC advanced GmbH test report include any endorsement or warranty regarding the functionality, quality or performance of any other product or service provided.

Under no circumstances does the CTC advanced GmbH test report include or imply any product or service warranties from CTC advanced GmbH, including, without limitation, any implied warranties of merchantability, fitness for purpose, or non-infringement, all of which are expressly disclaimed by CTC advanced GmbH.

All rights and remedies regarding vendor's products and services for which CTC advanced GmbH has prepared this test report shall be provided by the party offering such products or services and not by CTC advanced GmbH. In no case this test report can be considered as a Letter of Approval.

This test report is electronically signed and valid without handwritten signature. For verification of the electronic signatures, the public keys can be requested at the testing laboratory.

### 2.2 Application details

Date of receipt of order:	2021-10-19
Date of receipt of test item:	2022-02-04
Start of test:*	2022-02-04
End of test:*	2022-03-30
Person(s) present during the test:	-/-

\*Date of each measurement, if not shown in the plot, can be requested. Dates are stored in the measurement software.

### 2.3 Test laboratories sub-contracted

None

### 3 Test standard/s, references and accreditations

Test standard	Date	Description
FCC - Title 47 CFR Part 22	-/-	FCC - Title 47 of the Code of Federal Regulations; Chapter I; Part 22 - Public mobile services
FCC - Title 47 CFR Part 24	-/-	FCC - Title 47 of the Code of Federal Regulations; Chapter I; Part 24 - Personal communications services
FCC - Title 47 CFR Part 27	-/-0	FCC - Title 47 of the Code of Federal Regulations; Chapter I; Part 27 - Miscellaneous wireless communications services
RSS - 132 Issue 3	January 2013	Spectrum Management and Telecommunications Radio Standards Specification - Cellular Telephone Systems Operating in the Bands 824-849 MHz and 869-894 MHz
RSS - 133 Issue 6	January 2018	Spectrum Management and Telecommunications Policy - Radio Standards Specifications, 2 GHz Personal Communication Services
RSS - 130 Issue 2	February 2019	Equipment Operating in the Frequency Bands 617-652 MHz, 663-698 MHz, 698-756 MHz and 777-787 MHz

Guidance	Version	Description
ANSI C63.4-2014	-/-	American National Standard for Methods of Measurement of Radio-Noise Emissions from Low-Voltage Electrical and Electronic Equipment in the Range of 9 kHz to 40 GHz
ANSI C63.26-2015	-/-	American National Standard for Compliance Testing of Transmitters Used in Licensed Radio Services
Power Meas License Systems: KDB 971168 D01	v03r01	Measurement Guidance for Certification of Licensed Digital Transmitters

Accreditation	Description
D-PL-12076-01-04	Telecommunication and EMC Canada <a href="https://www.dakks.de/as/ast/d/D-PL-12076-01-04e.pdf">https://www.dakks.de/as/ast/d/D-PL-12076-01-04e.pdf</a>
D-PL-12076-01-05	Telecommunication FCC requirements <a href="https://www.dakks.de/as/ast/d/D-PL-12076-01-05e.pdf">https://www.dakks.de/as/ast/d/D-PL-12076-01-05e.pdf</a>



ISED Testing Laboratory Recognized Listing Number: DE0001  
FCC designation number: DE0002

#### 4 Reporting statements of conformity – decision rule

Only the measured values related to their corresponding limits will be used to decide whether the equipment under test meets the requirements of the test standards listed in chapter 3.

The measurement uncertainty is mentioned in this test report, see chapter 9, but is not taken into account - neither to the limits nor to the measurement results. Measurement results with a smaller margin to the corresponding limits than the measurement uncertainty have a potential risk of more than 5% that the decision might be wrong."

measured value, measurement uncertainty, verdict

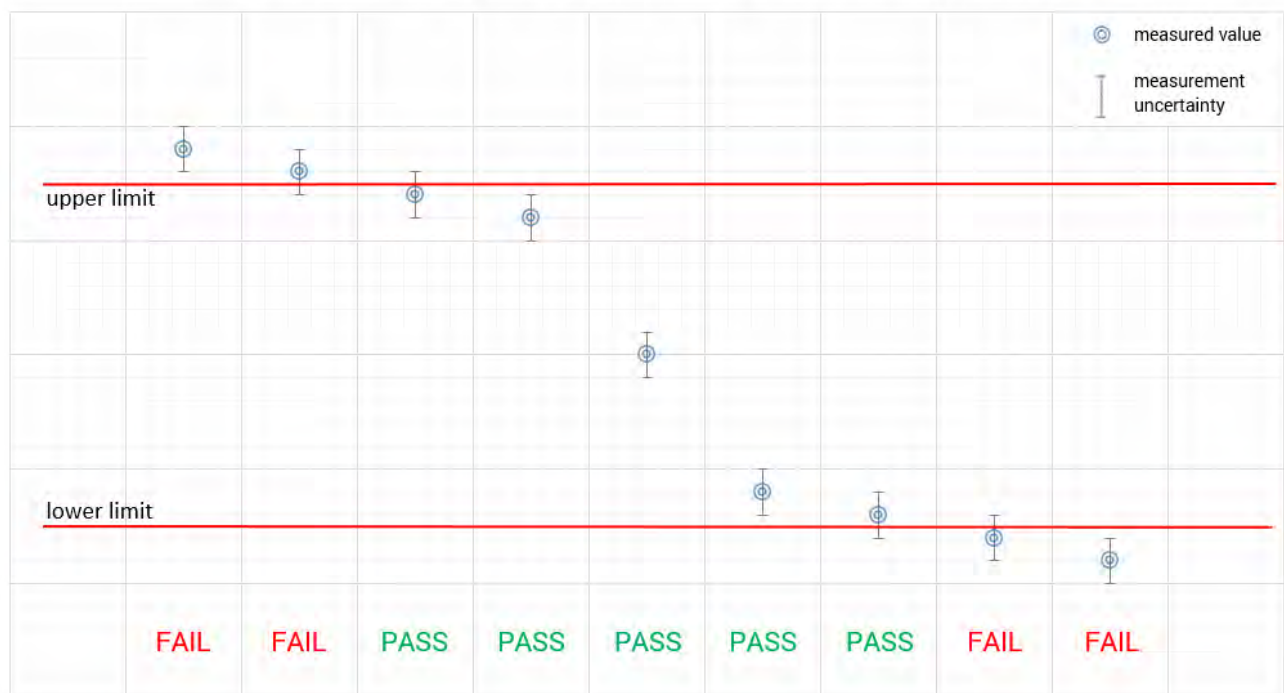

## 5 Test environment

Temperature	:	$T_{nom}$ +20 °C during room temperature tests $T_{max}$ +75 °C during high temperature tests $T_{min}$ -30 °C during low temperature tests
Relative humidity content	:	42 %
Barometric pressure	:	1018 hpa
Power supply	:	$V_{nom}$ 5 V DC by external mains adapter 3.6 V DC by battery $V_{max}$ 4.0 $V_{min}$ 3.2

## 6 Test item

### 6.1 General description

Kind of test item	:	SmartMonitor
Model name	:	Shipment Logger L/M
HMN	:	-/-
PMN	:	SmartMonitor
HVIN	:	BE14002 / BE14003; BE14001
FVIN	:	V01
S/N serial number	:	Radiated unit: AL008 Conducted unit: AL010
Hardware status	:	V3
Software status	:	n.a.
Firmware status	:	V0.2.3
Frequency band	:	LTE band 2; 4; 5; 12 and 13
Type of radio transmission	:	modulated carrier
Use of frequency spectrum	:	
Type of modulation	:	QPSK and 64-QAM
Antenna	:	Integrated antenna
Power supply	:	5 V DC by external mains adapter 3.6 V DC by battery
Temperature range	:	-30°C to +75°C

### 6.2 Additional information

The content of the following annexes is defined in the QA. It may be that not all of the listed annexes are necessary for this report, thus some values in between may be missing.

Test setup and EUT photos are included in test report:

- 1-2685/21-03-01\_AnnexA
- 1-2685/21-03-01\_AnnexB
- 1-2685/21-03-01\_AnnexD

## 7 Description of the test setup

Typically, the calibrations of the test apparatus are commissioned to and performed by an accredited calibration laboratory. The calibration intervals are determined in accordance with the DIN EN ISO/IEC 17025. In addition to the external calibrations, the laboratory executes comparison measurements with other calibrated test systems or effective verifications. Weekly chamber inspections and range calibrations are performed. Where possible, RF generating and signaling equipment as well as measuring receivers and analyzers are connected to an external high-precision 10 MHz reference (GPS-based or rubidium frequency standard).

In order to simplify the identification of the equipment used at some special tests, some items of test equipment and ancillaries can be provided with an identifier or number in the equipment list below (Lab/Item).

Each block diagram listed can contain several test setup configurations. All devices belonging to a test setup are identified with the same letter syntax. For example: Column Setup and all devices with an A.

### **Agenda:** Kind of Calibration

k	calibration / calibrated	EK	limited calibration
ne	not required (k, ev, izw, zw not required)	zw	cyclical maintenance (external cyclical maintenance)
ev	periodic self verification	izw	internal cyclical maintenance
Ve	long-term stability recognized	g	blocked for accredited testing
vlk!	Attention: extended calibration interval		
NK!	Attention: not calibrated	*)	next calibration ordered / currently in progress



## 7.1 Shielded semi anechoic chamber

The radiated measurements are performed in vertical and horizontal plane in the frequency range from 30 MHz to 1 GHz in semi-anechoic chambers. The EUT is positioned on a non-conductive support with a height of 0.80 m above a conductive ground plane that covers the whole chamber. The receiving antennas are conform to specifications ANSI C63. These antennas can be moved over the height range between 1.0 m and 4.0 m in order to search for maximum field strength emitted from EUT. The measurement distances between EUT and receiving antennas are indicated in the test setups for the various frequency ranges. For each measurement, the EUT is rotated in all three axes until the maximum field strength is received. The wanted and unwanted emissions are received by spectrum analyzers where the detector modes and resolution bandwidths over various frequency ranges are set according to requirement ANSI C63.

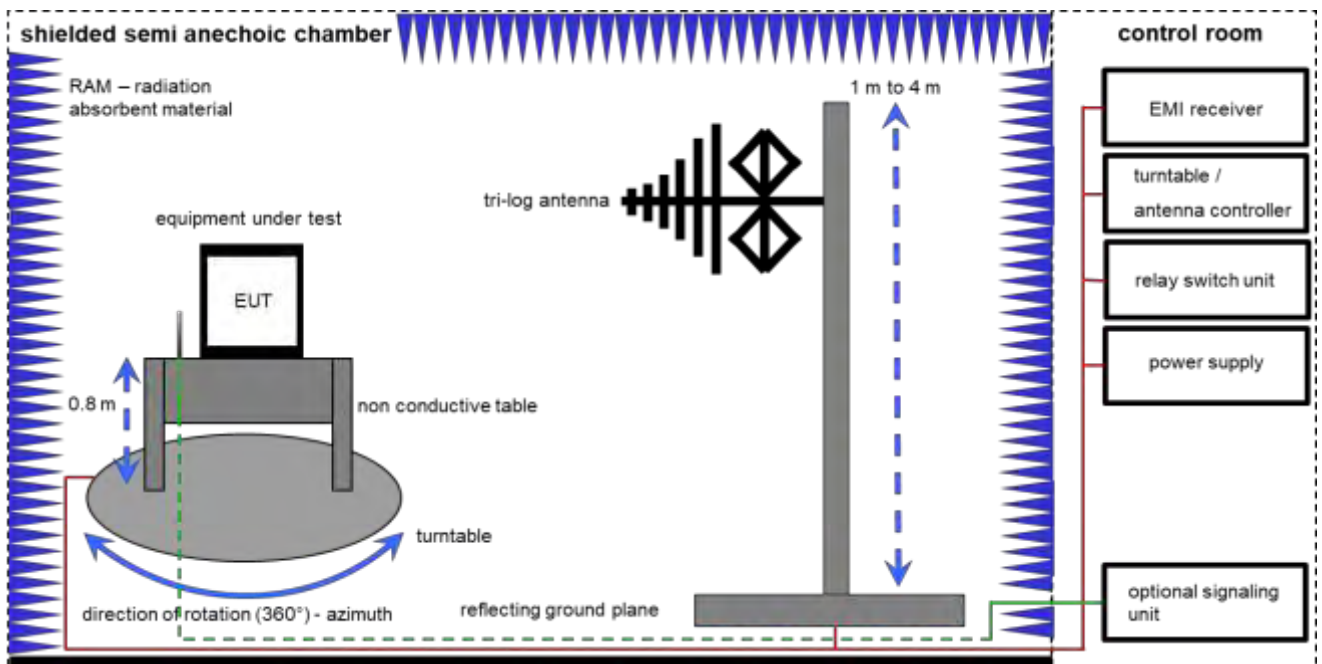

Measurement distance: tri-log antenna 10 meter; EMC32 software version: 10.59.00

FS = UR + CL + AF

(FS-field strength; UR-voltage at the receiver; CL-loss of the cable; AF-antenna factor)

Example calculation:

FS [dB $\mu$ V/m] = 12.35 [dB $\mu$ V/m] + 1.90 [dB] + 16.80 [dB/m] = 31.05 [dB $\mu$ V/m] (35.69  $\mu$ V/m)

### Equipment table:

No.	Setup	Equipment	Type	Manufacturer	Serial No.	INV. No.	Kind of Calibration	Last Calibration	Next Calibration
1	A	Switch-Unit	3488A	HP	2719A14505	300000368	ev	-/-	-/-
2	A	Semi anechoic chamber	3000023	MWB AG	-/-	300000551	ne	-/-	-/-
3	A	Analyzer-Reference-System (Harmonics and Flicker)	ARS 16/1	SPS	A3509 07/0 0205	3000003314	vKI!	29.12.2021	28.12.2023
4	A	Antenna Tower	Model 2175	ETS-Lindgren	64762	300003745	izw	-/-	-/-
5	A	Positioning Controller	Model 2090	ETS-Lindgren	64672	300003746	izw	-/-	-/-
6	A	Turntable Interface-Box	Model 105637	ETS-Lindgren	44583	300003747	izw	-/-	-/-
7	A	TRILOG Broadband Test-Antenna 30 MHz - 3 GHz	VULB9163	Schwarzbeck Mess - Elektronik	318	300003696	vKI!	30.09.2021	29.09.2023
8	A	Turntable	2089-4.0	EMCO	-/-	300004394	ne	-/-	-/-
9	A	PC	TecLine	F+W	-/-	300004388	ne	-/-	-/-
10	A	EMI Test Receiver	ESR3	Rohde & Schwarz	102587	300005771	k	08.12.2021	07.12.2022
11	A	Wideband radio communication tester	CMW500	Rohde & Schwarz	166977	300005718	k	30.09.2020	29.09.2022

## 7.2 Shielded fully anechoic chamber

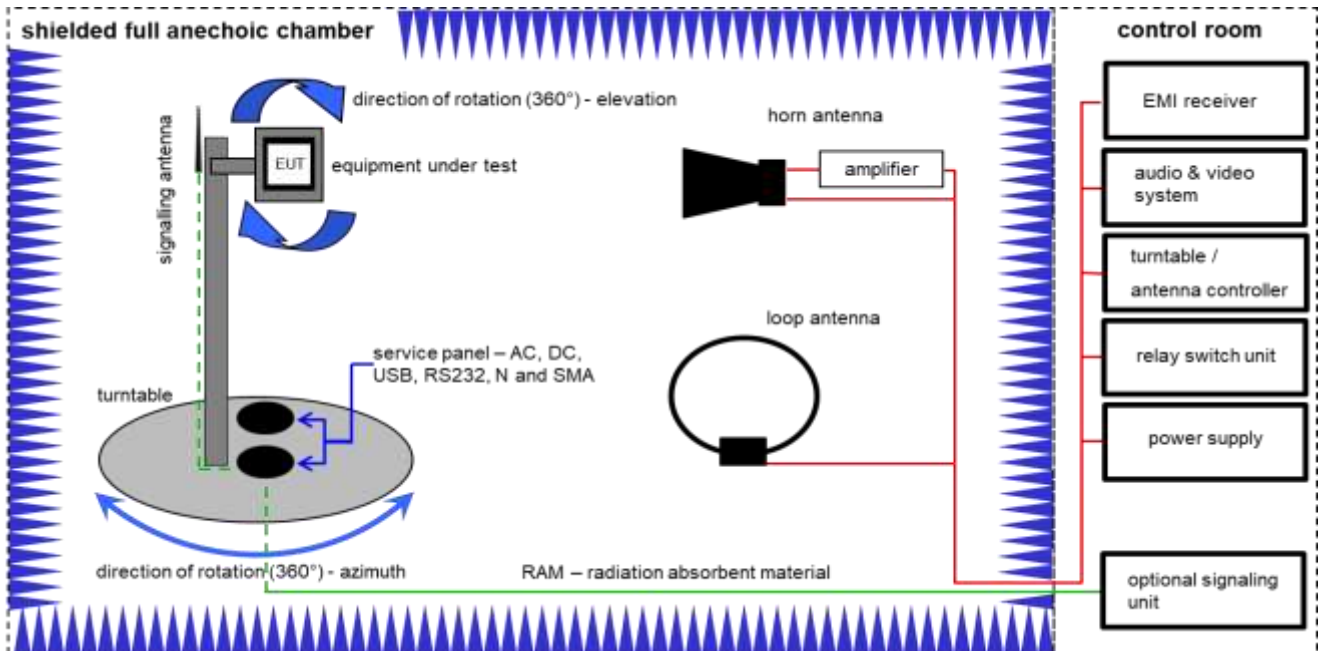

Measurement distance: horn antenna 3 meter; loop antenna 3 meter

$$OP = AV + D - G + CA$$

(OP-radiated output power; AV-analyzer value; D-free field attenuation of measurement distance; G-antenna gain+amplifier gain; CA-loss signal path)

Example calculation:

$$OP [dBm] = -39.0 [dBm] + 57.0 [dB] - 12.0 [dBi] + (-36.0) [dB] = -30 [dBm] (1 \mu W)$$

### Equipment table:

No.	Setup	Equipment	Type	Manufacturer	Serial No.	INV. No.	Kind of Calibration	Last Calibration	Next Calibration
1	A, B, C	Double-Ridged Waveguide Horn Antenna 1-18.0GHz	3115	EMCO	9107-3696	300001604	vIKI!	12.03.2021	11.03.2023
2	A, B	Highpass Filter	WHK1.1/15G-10SS	Wainwright	37	400000148	ne	-/-	-/-
3	B	Band Reject Filter	WRCG1850/1910-1835/1925-40/8SS	Wainwright	23	400000149	ne	-/-	-/-
4	A, B	Highpass Filter	WHKX7.0/18G-8SS	Wainwright	18	300003789	ne	-/-	-/-
5	A	Band Reject Filter	WRCG824/849-810/863-60/9SS	Wainwright	6	300003791	ne	-/-	-/-
6	A, B	Broadband Amplifier 0.5-18 GHz	CBLU5184540	CERNEX	22051	300004483	ev	-/-	-/-
7	A, B, C	4U RF Switch Platform	L4491A	Agilent Technologies	MY50000032	300004510	ne	-/-	-/-
8	A, B, C	Computer	Intel Core i3 3220/3,3 GHz, Prozessor	-/-	2V2403033A 5421	300004591	ne	-/-	-/-
9	A, B, C	NEXIO EMV-Software	BAT EMC V3.21.0.27	EMCO	-/-	300004682	ne	-/-	-/-
10	A, B, C	Anechoic chamber	-/-	TDK	-/-	300003726	ne	-/-	-/-
11	A, B, C	EMI Test Receiver 9kHz-26,5GHz	ESR26	Rohde & Schwarz	101376	300005063	k	15.12.2021	14.12.2022
12	A, B	RF-Amplifier	AMF-6F06001800-30-10P-R	NARDA-MITEQ Inc	2011571	300005240	ev	-/-	-/-
13	A, B, C	Wideband radio communication tester	CMW500	Rohde & Schwarz	166977	300005718	k	30.09.2020	29.09.2022
14	A, B	Active Loop Antenna 9 kHz to 30 MHz	6502	EMCO	2210	300001015	vIKI!	01.07.2021	30.06.2023

### 7.3 Radiated measurements > 18 GHz

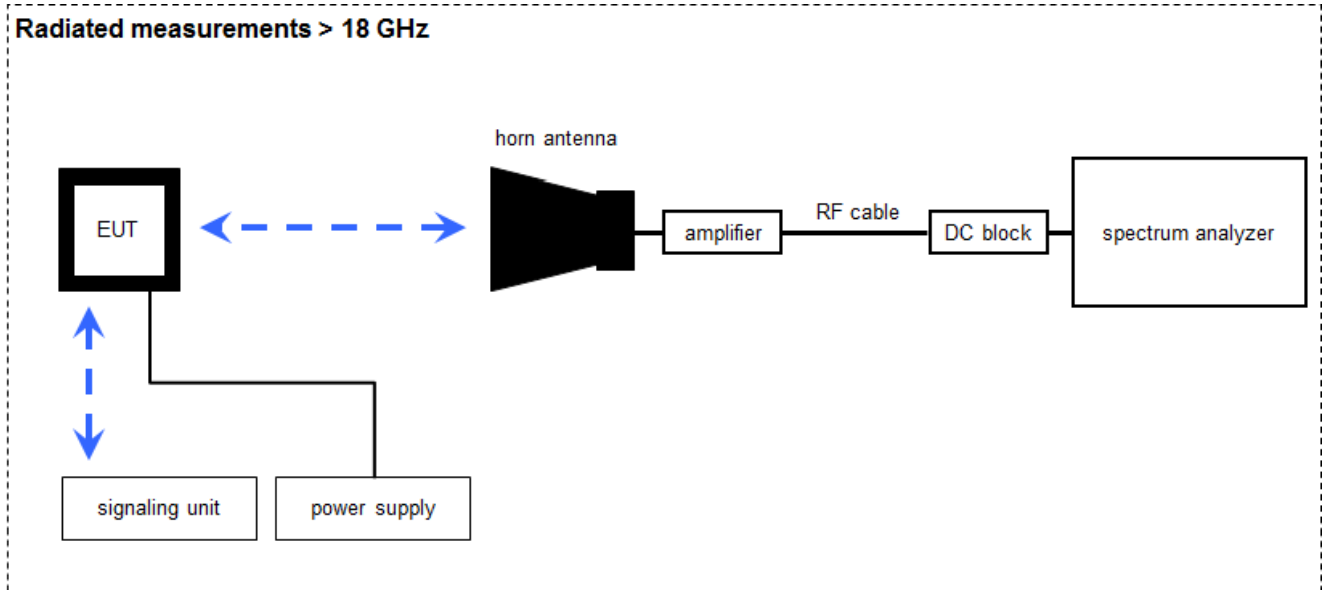

Measurement distance: horn antenna 50 cm

$$OP = AV + D - G + CA$$

(OP-radiated output power; AV-analyzer value; D-free field attenuation of measurement distance; G-antenna gain+amplifier gain; CA-loss signal path)

Example calculation:

$$OP \text{ [dBm]} = -59.0 \text{ [dBm]} + 44.0 \text{ [dB]} - 20.0 \text{ [dBi]} + 5.0 \text{ [dB]} = -30 \text{ [dBm]} \text{ (1 } \mu\text{W)}$$

**Equipment table:**

No.	Setup	Equipment	Type	Manufacturer	Serial No.	INV. No.	Kind of Calibration	Last Calibration	Next Calibration
1	A	Microwave System Amplifier, 0.5-26.5 GHz	83017A	HP	00419	300002268	ev	-/-	-/-
2	A	Std. Gain Horn Antenna 18.0-26.5 GHz	638	Narda	01096	300000486	vIKI!	-/-	-/-
3	A	Signal analyzer	FSV40	Rohde&Schwarz	101042	300004517	k	25.01.2022	24.01.2023
4	A	RF-Cable	ST18/SMAM/SMAM /48	Huber & Suhner	Batch no. 127377	400001183	ev	-/-	-/-
5	A	DC-Blocker 0.1-40 GHz	8141A	Inmet	-/-	400001185	ev	-/-	-/-
6	A	Wideband radio communication tester	CMW500	Rohde & Schwarz	166977	300005718	k	30.09.2020	29.09.2022

## 7.4 Conducted measurements normal and extreme conditions

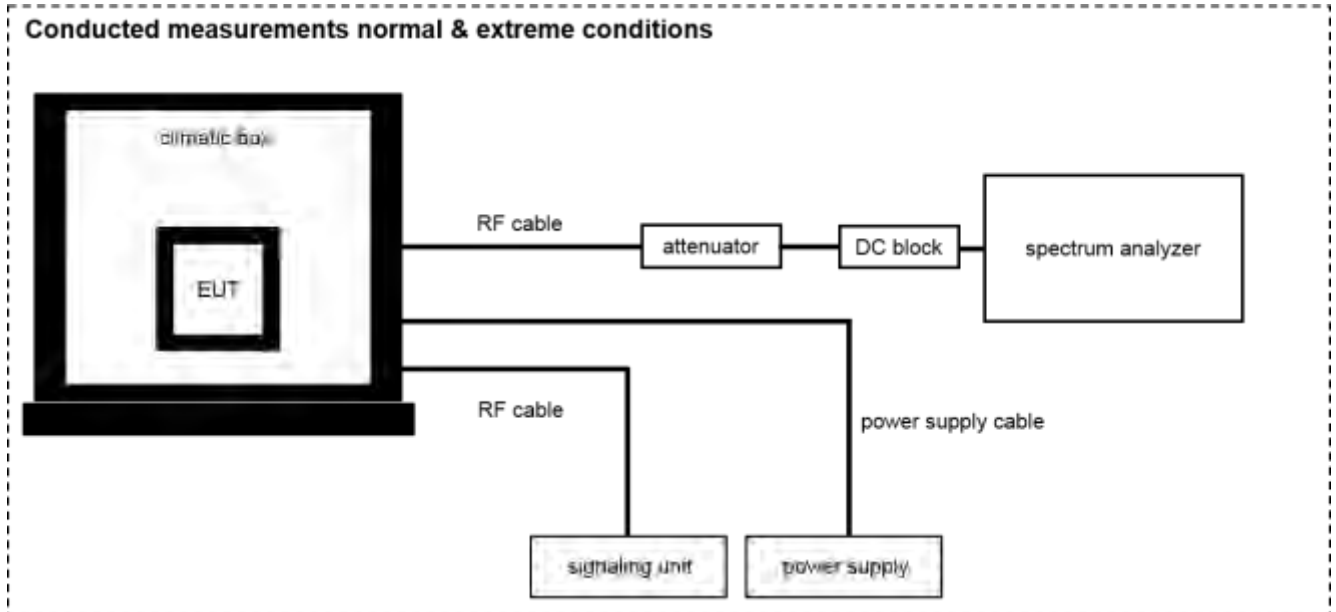

OP = AV + CA  
(OP-output power; AV-analyzer value; CA-loss signal path)

Example calculation:

OP [dBm] = 6.0 [dBm] + 11.7 [dB] = 17.7 [dBm] (58.88 mW)

**Equipment table:**

No.	Setup	Equipment	Type	Manufacturer	Serial No.	INV. No.	Kind of Calibration	Last Calibration	Next Calibration
1	A	Temperature Test Chamber	VT 4002	Heraeus Voetsch	521/83761	300002326	g	-/-	-/-
2	A	Wideband radio communication tester	CMW500	Rohde & Schwarz	166977	300005718	k	30.09.2020	29.09.2022
3	A	Hygro-Thermometer	-/, 5-45°C, 20-100%rF	Thies Clima	-/-	400000108	ev	13.08.2020	12.08.2022
4	A	PC Tester R005	Intel Core i3 3220/3,3 GHz, Prozessor	-/-	2V2403033A45 23	300004589	ne	-/-	-/-
5	A	Teststand	Teststand Custom Sequence Editor	National Instruments GmbH	-/-	300004590	ne	-/-	-/-
6	A	Resistive Power Dividers, DC-40 GHz, 1W	1575	MRC COMPONENTS	-/-	300004671	ne	-/-	-/-
7	A	USB-GPIB-Adapter	GPIB-USB-HS	National Instruments	1829974	400001136	ne	-/-	-/-
8	A	RF-Cable	ST18/SMAm/SMAm /72	Huber & Suhner	Batch no. 699714	400001184	ev	-/-	-/-
9	A	Synchron Power Meter	SPM-4	CTC	1	300005580	ev	-/-	-/-
10	A	Signal analyzer	FSV40	Rohde&Schwarz	101042	300004517	k	25.01.2022	24.01.2023
11	A	RF-Cable	ST18/SMAm/SMAm /36	Huber & Suhner	Batch no. 601494	400001309	ev	-/-	-/-
12	A	DC-Blocker 0.1-40 GHz	8141A	Inmet	-/-	400001185	ev	-/-	-/-

## 8 Sequence of testing

### 8.1 Sequence of testing radiated spurious 9 kHz to 30 MHz

#### Setup

- The equipment is set up to simulate normal operation mode as described in the user manual or defined by the manufacturer.
- If the EUT is a tabletop system, it is placed on a table with 0.8 m height.
- If the EUT is a floor standing device, it is placed directly on the turn table.
- Auxiliary equipment and cables are positioned to simulate normal operation conditions as described in ANSI C 63.4.
- The AC power port of the EUT (if available) is connected to a power outlet below the turntable.
- Measurement distance is 3 m (see ANSI C 63.4) – see test details.
- EUT is set into operation.

#### Premeasurement\*

- The turntable rotates from 0° to 315° using 45° steps.
- The antenna height is 1 m.
- At each turntable position the analyzer sweeps with positive-peak detector to find the maximum of all emissions.

#### Final measurement

- Identified emissions during the pre-measurement are maximized by the software by rotating the turntable from 0° to 360°.
- Loop antenna is rotated about its vertical axis for maximum response at each azimuth about the EUT. (For certain applications, the loop antenna plane may also need to be positioned horizontally at the specified distance from the EUT)
- The final measurement is done in the position (turntable and elevation) causing the highest emissions with quasi-peak (as described in ANSI C 63.4).
- Final levels, frequency, measuring time, bandwidth, turntable position, correction factor, margin to the limit and limit will be recorded. A plot with the graph of the premeasurement and the limit is stored.

\*Note: The sequence will be repeated three times with different EUT orientations.

## 8.2 Sequence of testing radiated spurious 30 MHz to 1 GHz

### Setup

- The equipment is set up to simulate normal operation mode as described in the user manual or defined by the manufacturer.
- If the EUT is a tabletop system, a table with 0.8 m height is used, which is placed on the ground plane.
- If the EUT is a floor standing device, it is placed on the ground plane with insulation between both.
- Auxiliary equipment and cables are positioned to simulate normal operation conditions as described in ANSI C 63.4.
- The AC power port of the EUT (if available) is connected to a power outlet below the turntable.
- Measurement distance is 10 m or 3 m (see ANSI C 63.4) – see test details.
- EUT is set into operation.

### Premeasurement

- The turntable rotates from 0° to 315° using 45° steps.
- The antenna is polarized vertical and horizontal.
- The antenna height changes from 1 m to 3 m.
- At each turntable position, antenna polarization and height the analyzer sweeps three times in peak to find the maximum of all emissions.

### Final measurement

- The final measurement is performed for at least six highest peaks according to the requirements of the ANSI C63.4.
- Based on antenna and turntable positions at which the peak values are measured the software maximize the peaks by changing turntable position  $\pm 45^\circ$  and antenna height between 1 and 4 m.
- The final measurement is done with quasi-peak detector (as described in ANSI C 63.4).
- Final levels, frequency, measuring time, bandwidth, antenna height, antenna polarization, turntable angle, correction factor, margin to the limit and limit are recorded. A plot with the graph of the premeasurement with marked maximum final results and the limit is stored.

### 8.3 Sequence of testing radiated spurious 1 GHz to 18 GHz

#### Setup

- The equipment is set up to simulate normal operation mode as described in the user manual or defined by the manufacturer.
- If the EUT is a tabletop system, a 2-axis positioner with 1.5 m height is used.
- If the EUT is a floor standing device, it is placed directly on the turn table.
- Auxiliary equipment and cables are positioned to simulate normal operation conditions as described in ANSI C 63.4.
- The AC power port of the EUT (if available) is connected to a power outlet below the turntable.
- Measurement distance is 3 m (see ANSI C 63.4) – see test details.
- EUT is set into operation.

#### Premeasurement

- The turntable rotates from 0° to 315° using 45° steps.
- The antenna is polarized vertical and horizontal.
- The antenna height is 1.5 m.
- At each turntable position and antenna polarization the analyzer sweeps with positive peak detector to find the maximum of all emissions.

#### Final measurement

- The final measurement is performed for at least six highest peaks according to the requirements of the ANSI C63.4.
- Based on antenna and turntable positions at which the peak values are measured the software maximizes the peaks by rotating the turntable from 0° to 360°. This measurement is repeated for different EUT-table positions (0° to 150° in 30°-steps) and for both antenna polarizations.
- The final measurement is done in the position (turntable, EUT-table and antenna polarization) causing the highest emissions with Peak and RMS detector (as described in ANSI C 63.4).
- Final levels, frequency, measuring time, bandwidth, turntable position, EUT-table position, antenna polarization, correction factor, margin to the limit and limit are recorded. A plot with the graph of the premeasurement with marked maximum final results and the limit is stored.

## 8.4 Sequence of testing radiated spurious above 18 GHz

### Setup

- The equipment is set up to simulate normal operation mode as described in the user manual or defined by the manufacturer.
- Auxiliary equipment and cables are positioned to simulate normal operation conditions as described in ANSI C 63.4.
- The AC power port of the EUT (if available) is connected to a power outlet.
- The measurement distance is as appropriate (e.g. 0.5 m).
- The EUT is set into operation.

### Premeasurement

- The test antenna is handheld and moved carefully over the EUT to cover the EUT's whole sphere and different polarizations of the antenna.

### Final measurement

- The final measurement is performed at the position and antenna orientation causing the highest emissions with Peak and RMS detector (as described in ANSI C 63.4).
- Final levels, frequency, measuring time, bandwidth, correction factor, margin to the limit and limit are recorded. A plot with the graph of the premeasurement and the limit is stored.



**9 Measurement uncertainty**

Measurement uncertainty	
Test case	Uncertainty
RF output power conducted	$\pm 1$ dB
RF output power radiated	$\pm 3$ dB
Frequency stability	$\pm 20$ Hz
Spurious emissions radiated below 30 MHz	$\pm 3$ dB
Spurious emissions radiated 30 MHz to 1 GHz	$\pm 3$ dB
Spurious emissions radiated 1 GHz to 12.75 GHz	$\pm 3.7$ dB
Spurious emissions radiated above 12.75 GHz	$\pm 4.5$ dB
Spurious emissions conducted	$\pm 3$ dB
Block edge compliance	$\pm 3$ dB
Occupied bandwidth	$\pm$ RBW

## 10 Summary of measurement results

<input checked="" type="checkbox"/>	No deviations from the technical specifications were ascertained
<input type="checkbox"/>	There were deviations from the technical specifications ascertained
<input type="checkbox"/>	This test report is only a partial test report. The content and verdict of the performed test cases are listed below.

TC identifier	Description	verdict	date	Remark
RF-Testing	FCC: CFR Part 2 & Part 22 ISED: RSS-Gen, Issue 5 & RSS 132, Issue 3	See table!	2022-04-14	-/-

### 10.1 Part 22/RSS-132: LTE band 5

Test Case	temperature conditions	power source voltages	C	NC	NA	NP	Remark
RF Output Power	Nominal	Nominal	<input checked="" type="checkbox"/>	<input type="checkbox"/>	<input type="checkbox"/>	<input type="checkbox"/>	-/-
Frequency Stability	Extreme	Extreme	<input checked="" type="checkbox"/>	<input type="checkbox"/>	<input type="checkbox"/>	<input type="checkbox"/>	-/-
Spurious Emissions Radiated	Nominal	Nominal	<input checked="" type="checkbox"/>	<input type="checkbox"/>	<input type="checkbox"/>	<input type="checkbox"/>	-/-
Spurious Emissions Conducted	Nominal	Nominal	<input checked="" type="checkbox"/>	<input type="checkbox"/>	<input type="checkbox"/>	<input type="checkbox"/>	-/-
Block Edge Compliance	Nominal	Nominal	<input checked="" type="checkbox"/>	<input type="checkbox"/>	<input type="checkbox"/>	<input type="checkbox"/>	-/-
Occupied Bandwidth	Nominal	Nominal	<input checked="" type="checkbox"/>	<input type="checkbox"/>	<input type="checkbox"/>	<input type="checkbox"/>	-/-

**Note:** C – Compliant; NC – Not compliant; NA = Not applicable; NP = Not performed

## 11 RF measurements

### 11.1 Description of test setup

For the spurious measurements we use the substitution method according TIA/EIA 603.

### 11.2 Results LTE band 5

The EUT was set to transmit the maximum power.

#### 11.2.1 RF output power

##### Description:

This paragraph contains conducted average power, ERP and Peak-to-Average Power Ratio measurements for the mobile station.

##### Measurement:

The mobile was set up for the maximum output power with pseudo random data modulation.

To determine the Peak-To-Average Power Ratio (PAPR) the measurement was performed with the Power Complementary Cumulative Distribution Function (CCDF).

Measurement parameters	
Detector:	Sample
AQT:	See plot
Resolution bandwidth:	1 MHz
Used equipment:	See chapter 7.1 – A & 7.4 – A
Measurement uncertainty:	see chapter 9
Measurement procedure:	FCC: § 2.1046 ISED: RSS-Gen, 6.12

##### Limits:

FCC	ISED
§ 22.913(a)(5) & (d)	RSS-132, 5.4
(a)(5) The ERP of mobile transmitters and auxiliary test transmitters must not exceed 7 W. (d) The peak-to-average ratio (PAR) of the transmission must not exceed 13 dB.	The EIRP power for mobile equipment shall not exceed 11.5 W. The peak-to-average power ratio (PAPR) of the transmitter shall not exceed 13 dB [...].
Power: <b>38.45 dBm ERP</b> PAPR: <b>13 dB</b>	

**Results:**

Output Power (conducted)						
Bandwidth (MHz)	Frequency (MHz)	Resource block allocation	Average Output Power (dBm) QPSK	Peak to Average Ratio (dB)	Average Output Power (dBm) 16-QAM	Peak to Average Ratio (dB)
1.4	20407 / 824.7	1 RB low	17.9	6.1	16.6	7.2
		1 RB high	17.8	6.2	16.6	7.2
		100% RB	15.9	6.8	15.9	7.5
	20525 / 836.5	1 RB low	18.4	6.1	17.1	7.2
		1 RB high	18.4	6.1	17.1	7.2
		100% RB	16.3	6.7	16.4	7.4
	20643 / 848.3	1 RB low	18.2	6.1	16.9	7.1
		1 RB high	18.0	6.1	16.8	7.1
		100% RB	16.1	6.8	16.2	7.4
3	20415 / 825.5	1 RB low	18.0	6.1	16.7	7.2
		1 RB high	17.9	6.1	16.6	7.2
		100% RB	15.1	7.5	15.8	7.5
	20525 / 836.5	1 RB low	18.3	6.0	17.1	7.1
		1 RB high	18.2	6.1	16.2	8.0
		100% RB	16.3	6.7	15.7	8.2
	20635 / 847.5	1 RB low	18.1	6.1	16.9	7.1
		1 RB high	17.2	6.9	16.9	7.1
		100% RB	16.1	6.8	16.2	7.4
5	20425 / 826.5	1 RB low	19.9	4.3	20.3	4.8
		1 RB high	19.7	4.4	20.2	4.8
		100% RB	18.6	5.0	17.7	5.9
	20525 / 836.5	1 RB low	20.4	4.1	20.2	4.7
		1 RB high	20.5	4.1	20.0	4.8
		100% RB	18.8	5.0	17.9	5.9
	20625 / 846.5	1 RB low	20.2	4.2	20.6	4.6
		1 RB high	20.1	4.3	20.4	4.7
		100% RB	18.8	5.0	18.0	5.9
10	20450 / 829.0	1 RB low	20.0	4.3	20.1	4.9
		1 RB high	20.0	4.3	20.1	4.8
		100% RB	18.6	5.0	18.7	5.7
	20525 / 836.5	1 RB low	20.6	4.1	20.1	4.8
		1 RB high	20.3	4.2	20.0	4.8
		100% RB	18.8	4.9	18.8	5.7
	20600 / 844.0	1 RB low	20.2	4.3	20.6	4.6
		1 RB high	20.0	4.3	20.4	4.6
		100% RB	18.8	5.0	18.9	5.6

The radiated output power is measured in the mode with the highest conducted output power.

Output Power (ERP)			
Bandwidth (MHz)	Frequency (MHz)	Average Output Power (dBm)	Average Output Power (dBm)
		QPSK	16-QAM
1.4	824.7	15.0	13.7
	836.5	14.9	13.6
	848.3	15.1	13.8
3	825.5	15.1	13.8
	836.5	14.8	13.6
	847.5	15.0	13.8
5	826.5	17.0	17.4
	836.5	17.0	16.7
	846.5	17.1	17.5
10	829.0	17.1	17.2
	836.5	17.1	16.6
	844.0	17.1	17.5

## 11.2.2 Frequency stability

### Description:

In order to measure the carrier frequency under normal conditions it is necessary to make measurements with the mobile station connected to a R&S CMW500 Wideband Radio Communication Tester.

1. Measure the carrier frequency at room temperature.
2. Subject the mobile station to overnight soak at -30 C.
3. With the mobile station, powered with  $V_{nom}$ , connected to the CMW500 on the center channel with channel bandwidth of 10 MHz, measure the carrier frequency. These measurements should be made within two minutes of powering up the mobile station, to prevent significant self warming.
4. Repeat the above measurements at 10°C increments from -30°C to +50°C. Allow at least 15 minutes at each temperature, unpowered, before making measurements.
5. Re-measure carrier frequency at room temperature with  $V_{nom}$ . Vary supply voltage to  $V_{min}$  and measure the carrier frequency then setup  $V_{max}$  and repeat the measurement.
6. At all temperature levels hold the temperature to +/- 0.5°C during the measurement procedure.

### Measurement:

Measurement parameters	
Detector:	Measured with CMW500
Sweep time:	
Video bandwidth:	
Resolution bandwidth:	
Span:	
Trace-Mode:	
Test setup:	See chapter 7.4 setup A
Measurement uncertainty:	See chapter 9
Measurement procedure:	FCC: § 2.1055 ISED: RSS-Gen, 6.11

### Limits:

FCC	ISED
§ 22.355 (Mobile Station, 821 – 896 MHz)	RSS-132, 5.3 (Mobile Station)
The carrier frequency of each transmitter in the Public Mobile Services must be maintained within the tolerances given in Table C-1.	The carrier frequency shall not depart from the reference frequency in excess of $\pm 2.5$ ppm for mobile stations and $\pm 1.5$ ppm for base stations.
<b><math>\pm 2.5</math> ppm</b>	

**Results:****AFC FREQ ERROR versus VOLTAGE**

Voltage (V)	Frequency Error (Hz)	Frequency Error (ppm)
3.2	-18	-0.0215
3.6	-18	-0.0215
4.0	-18	-0.0215

**AFC FREQ ERROR versus TEMPERATURE**

Temperature (°C)	Frequency Error (Hz)	Frequency Error (ppm)
-30	22	0.0263
-20	16	0.0191
-10	10	0.0120
± 0	14	0.0167
10	-17	-0.0203
20	-18	-0.0215
30	-24	-0.0287
40	-26	-0.0311
50	-35	-0.0418

### 11.2.3 Spurious emissions radiated

#### **Description:**

The following steps outline the procedure used to measure the radiated emissions from the mobile station. The site is constructed in accordance with ANSI C63.4:2014 requirements and is recognized by the FCC to be in compliance for a 3 and a 10 meter site. The spectrum was scanned from 30 MHz to the 10th harmonic of the highest frequency generated within the equipment, which is the transmitted carrier that can be as high as 844 MHz. Measurement made up to 9 GHz. The resolution bandwidth is set as outlined in Part 22.917. The spectrum was scanned with the mobile station transmitting at carrier frequencies that pertain to low, mid and high channels of the LTE band V.

#### **Measurement:**

Measurement parameters	
Detector:	Peak
Sweep time:	2 s
Resolution bandwidth:	100 kHz
Video bandwidth:	300 kHz
Span:	100 MHz Steps
Trace mode:	Max Hold
Used equipment:	See chapter 7.1 – A & 7.2 – A
Measurement uncertainty:	See chapter 9
Measurement procedure:	FCC: § 2.1053 ISED: RSS-Gen, 6.13



**Limits:**

FCC	ISED
§ 22.917(a) & (b)	RSS-132, 5.5
<p>(a) The power of any emission outside of the authorized operating frequency ranges must be attenuated below the transmitting power (P) by a factor of at least <math>43 + 10 \log(P)</math> dB.</p> <p>(b)(1) In the spectrum below 1 GHz, instrumentation should employ a reference bandwidth of 100 kHz or greater. In the 1 MHz bands immediately outside and adjacent to the frequency block, a RBW of at least one percent of the emission bandwidth of the fundamental emission of the transmitter may be employed. A narrower resolution bandwidth is permitted in all cases to improve measurement accuracy, provided that the measured power is integrated over the full required reference bandwidth (i.e., 100 kHz or 1 percent of emission bandwidth, as specified). The emission bandwidth is defined as the width of the signal between two points, one below the carrier center frequency and one above the carrier center frequency, outside of which all emissions are attenuated at least 26 dB below the transmitter power.</p> <p>(b)(2) In the spectrum above 1 GHz, instrumentation should employ a reference bandwidth of 1 MHz.</p>	<p>i. In the first 1.0 MHz band immediately outside and adjacent to each of the sub-bands specified in Section 5.1, the power of emissions per any 1% of the occupied bandwidth shall be attenuated (in dB) below the transmitter output power P ( dBW) by at least <math>43 + 10 \log_{10}(P)</math> (watts).</p> <p>ii. After the first 1.0 MHz immediately outside and adjacent to each of the sub-bands, the power of emissions in any 100 kHz bandwidth shall be attenuated (in dB) below the transmitter output power P (dBW) by at least <math>43 + 10 \log_{10}(P)</math> (watts). If the measurement is performed using 1% of the occupied bandwidth, power integration over 100 kHz is required.</p>
<b>-13 dBm</b>	

**Results:**

**QPSK:**

SPURIOUS EMISSION LEVEL								
Harmonic	Lowest channel Freq. (MHz)	Level [dBm]	Harmonic	Middle channel Freq. (MHz)	Level [dBm]	Harmonic	Highest channel Freq. (MHz)	Level [dBm]
2	1658.0	All detected emissions are more than 20 dB below the limit.	2	1673.0	All detected emissions are more than 20 dB below the limit.	2	1688.0	All detected emissions are more than 20 dB below the limit.
3	2487.0		3	2509.5		3	2532.0	
4	3316.0		4	3346.0		4	3376.0	
5	4145.0		5	4182.5		5	4220.0	
6	4974.0		6	5019.0		6	5064.0	
7	5803.0		7	5855.5		7	5908.0	
8	6632.0		8	6692.0		8	6752.0	
9	7461.0		9	7528.5		9	7596.0	
10	8290.0		10	8365.0		10	8440.0	

**16-QAM:**

SPURIOUS EMISSION LEVEL								
Harmonic	Lowest channel Freq. (MHz)	Level [dBm]	Harmonic	Middle channel Freq. (MHz)	Level [dBm]	Harmonic	Highest channel Freq. (MHz)	Level [dBm]
2	1658.0	All detected emissions are more than 20 dB below the limit.	2	1673.0	-48.2	2	1688.0	All detected emissions are more than 20 dB below the limit.
3	2487.0		3	2509.5	-35.6	3	2532.0	
4	3316.0		4	3346.0	-/-	4	3376.0	
5	4145.0		5	4182.5	-/-	5	4220.0	
6	4974.0		6	5019.0	-/-	6	5064.0	
7	5803.0		7	5855.5	-/-	7	5908.0	
8	6632.0		8	6692.0	-/-	8	6752.0	
9	7461.0		9	7528.5	-/-	9	7596.0	
10	8290.0		10	8365.0	-/-	10	8440.0	

**QPSK**

**Plot 1: Mid channel (9 kHz - 30 MHz)**

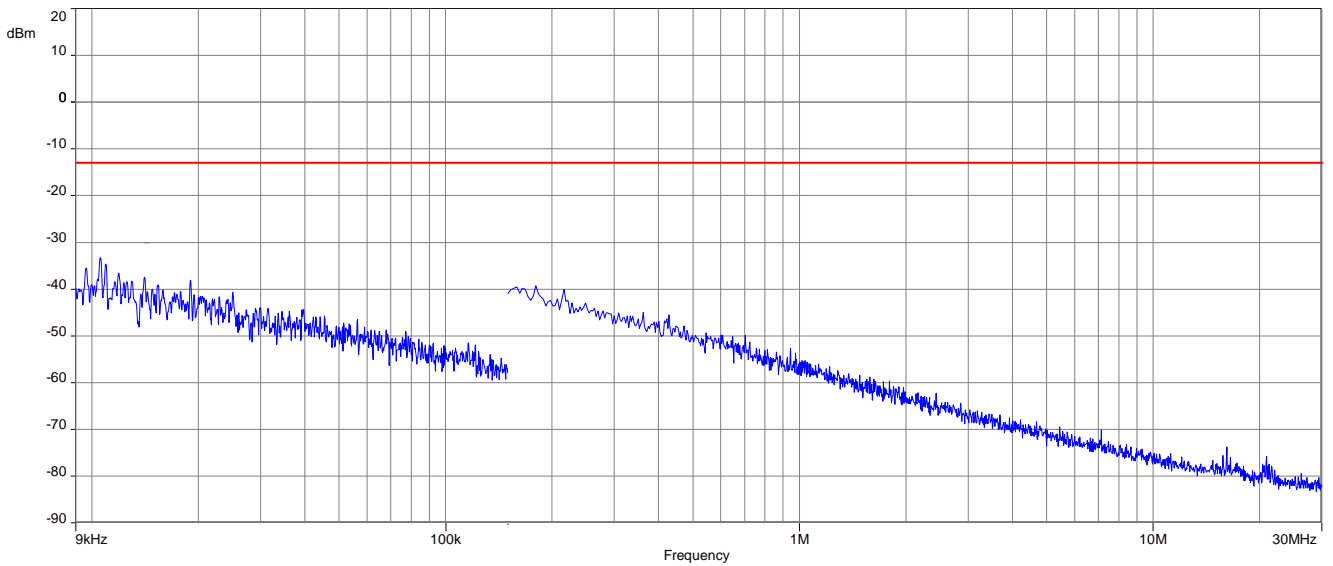

**Plot 2: Mid channel (30 MHz – 1 GHz)**

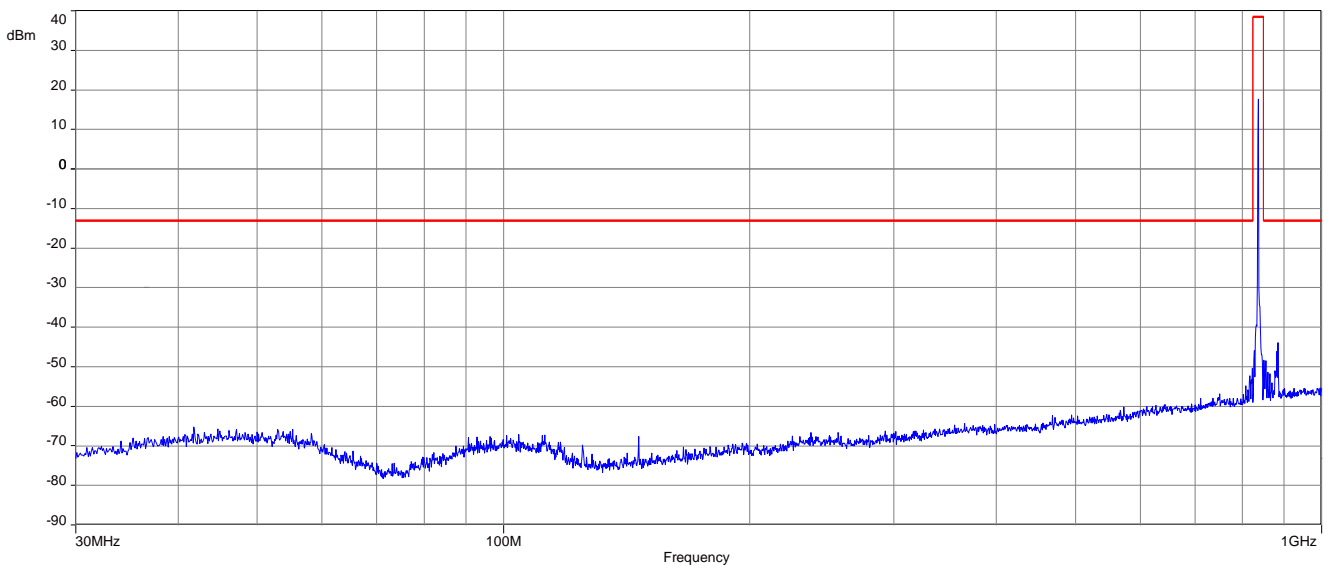

**Plot 3:** Mid channel (1 GHz – 9 GHz)

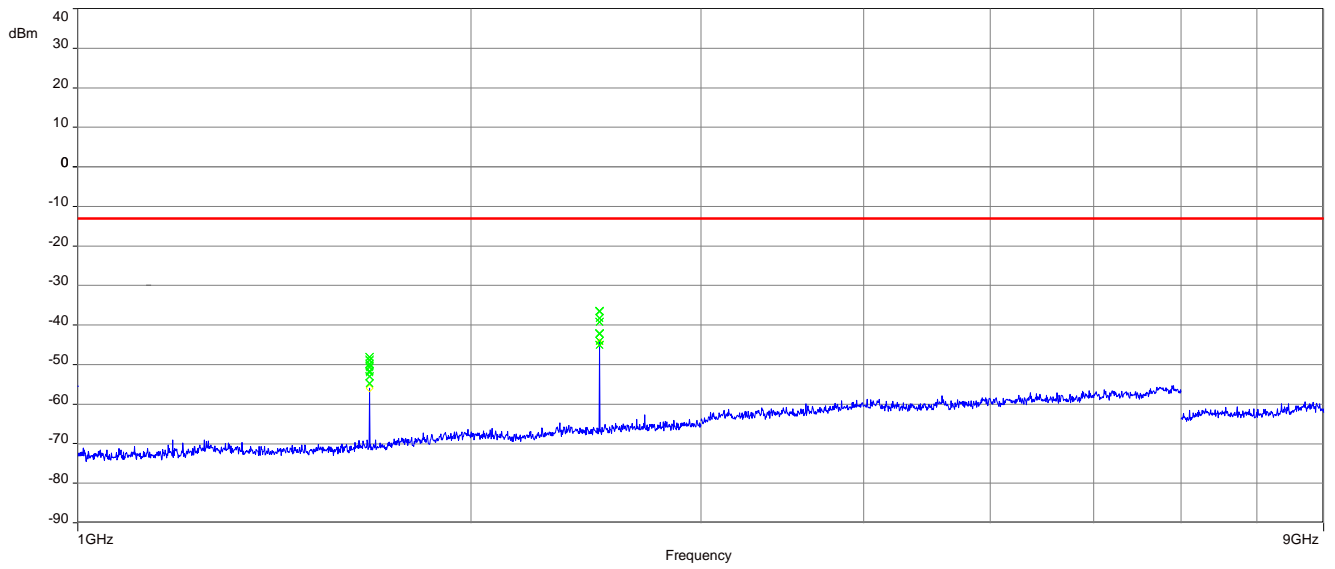

## 16-QAM

**Plot 1:** Mid channel (9 kHz - 30 MHz)

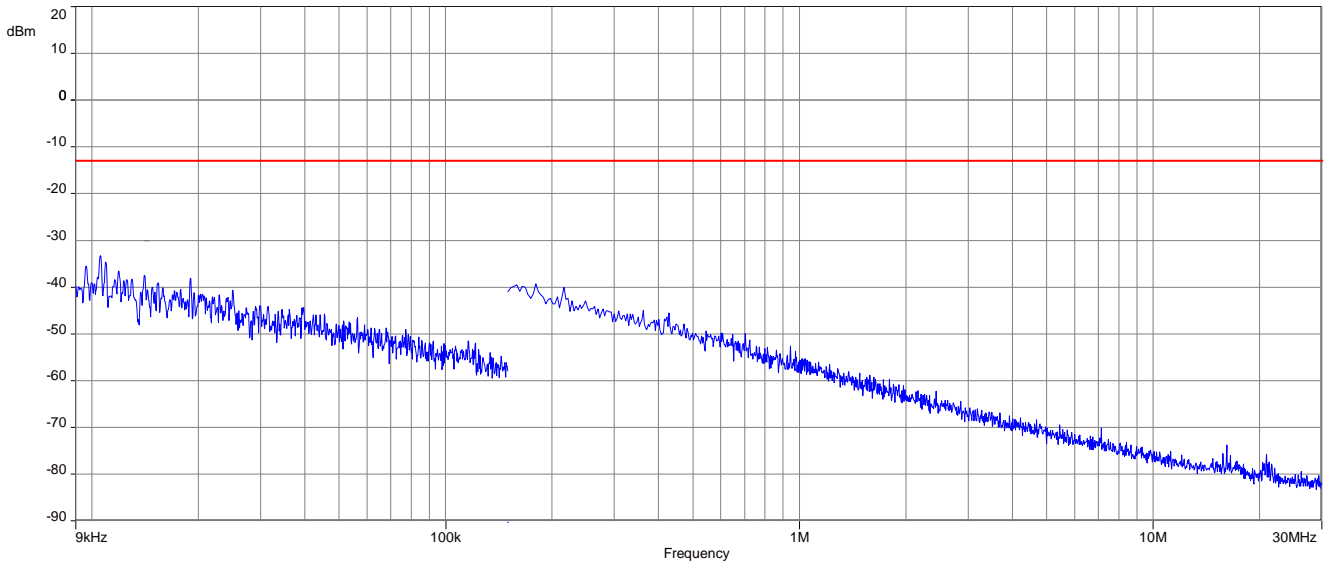

**Plot 2:** Mid channel (30 MHz – 1 GHz)

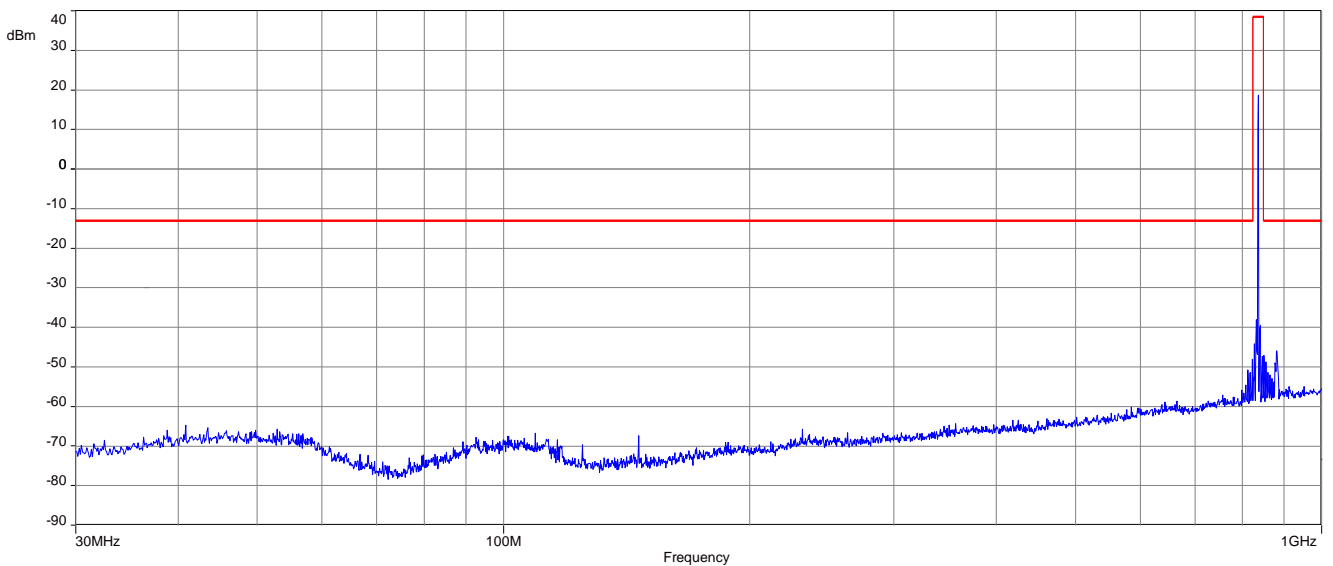

**Plot 3:** Mid channel (1 GHz – 9 GHz)

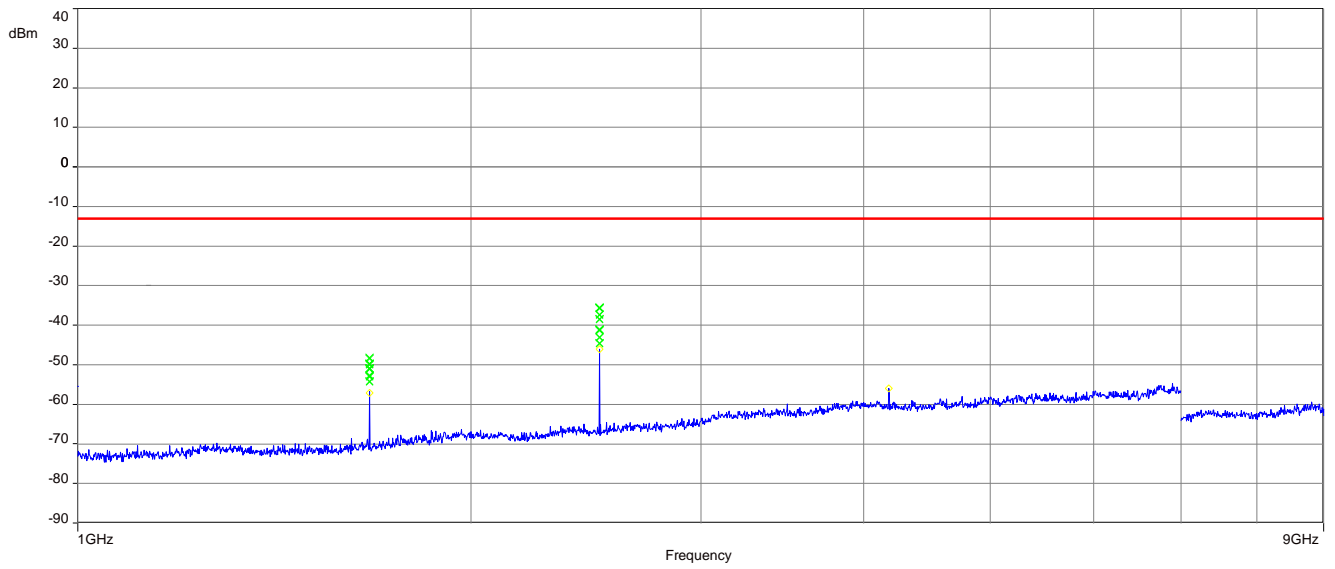

## 11.2.4 Spurious emissions conducted

### Description:

The following steps outline the procedure used to measure the conducted emissions from the mobile station.

1. Determine frequency range for measurements: From § 2.1057 & RSS-Gen, 6.13.2 the spectrum should be investigated from the lowest radio frequency generated in the equipment up to at least the 10th harmonic of the carrier frequency.

2. Determine mobile station transmits frequencies: below outlines the band edge frequencies pertinent to conducted emissions testing.

### Measurement:

Measurement parameters	
Detector:	Peak
Sweep time:	Auto
Resolution bandwidth:	100 kHz
Video bandwidth:	300 kHz
Span:	10 MHz – 8.5 GHz
Trace mode:	Max Hold
Used equipment:	See chapter 7.4 - A
Measurement uncertainty:	See chapter 9
Measurement procedure:	FCC: § 2.1051 ISED: RSS-Gen, 6.13

**Limits:**

FCC	ISED
§ 22.917(a) & (b)	RSS-132, 5.5
<p>(a) The power of any emission outside of the authorized operating frequency ranges must be attenuated below the transmitting power (P) by a factor of at least <b>43 + 10 log(P) dB</b>.</p> <p>(b)(1) In the spectrum below 1 GHz, instrumentation should employ a reference bandwidth of 100 kHz or greater. In the 1 MHz bands immediately outside and adjacent to the frequency block, a RBW of at least one percent of the emission bandwidth of the fundamental emission of the transmitter may be employed. A narrower resolution bandwidth is permitted in all cases to improve measurement accuracy, provided that the measured power is integrated over the full required reference bandwidth (i.e., 100 kHz or 1 percent of emission bandwidth, as specified). The emission bandwidth is defined as the width of the signal between two points, one below the carrier center frequency and one above the carrier center frequency, outside of which all emissions are attenuated at least 26 dB below the transmitter power.</p> <p>(b)(2) In the spectrum above 1 GHz, instrumentation should employ a reference bandwidth of 1 MHz.</p>	<p>i. In the first 1.0 MHz band immediately outside and adjacent to each of the sub-bands specified in Section 5.1, the power of emissions per any 1% of the occupied bandwidth shall be attenuated (in dB) below the transmitter output power P ( dBW) by at least <b>43 + 10 log10(P) (watts)</b>.</p> <p>ii. After the first 1.0 MHz immediately outside and adjacent to each of the sub-bands, the power of emissions in any 100 kHz bandwidth shall be attenuated (in dB) below the transmitter output power P (dBW) by at least <b>43 + 10 log10(P) (watts)</b>. If the measurement is performed using 1% of the occupied bandwidth, power integration over 100 kHz is required.</p>
<b>-13 dBm</b>	



**Results: for 1.4 MHz channel bandwidth****QPSK**

SPURIOUS EMISSION LEVEL								
Harmonic	Lowest channel Freq. (MHz)	Level [dBm]	Harmonic	Middle channel Freq. (MHz)	Level [dBm]	Harmonic	Highest channel Freq. (MHz)	Level [dBm]
2	1649.4	-	2	1673.0	-	2	1696.6	-
3	2474.1	-	3	2509.5	-	3	2544.9	-
4	3298.8	-	4	3346.0	-	4	3393.2	-
5	4123.5	-	5	4182.5	-	5	4241.5	-
6	4948.2	-	6	5019.0	-	6	5089.8	-
7	5772.9	-	7	5855.5	-	7	5938.1	-
8	6597.6	-	8	6692.0	-	8	6786.4	-
9	7422.3	-	9	7258.5	-	9	7634.7	-
10	8247.0	-	10	8365.0	-	10	8483	-

**16-QAM**

SPURIOUS EMISSION LEVEL								
Harmonic	Lowest channel Freq. (MHz)	Level [dBm]	Harmonic	Middle channel Freq. (MHz)	Level [dBm]	Harmonic	Highest channel Freq. (MHz)	Level [dBm]
2	1649.4	-	2	1673.0	-	2	1696.6	-
3	2474.1	-	3	2509.5	-	3	2544.9	-
4	3298.8	-	4	3346.0	-	4	3393.2	-
5	4123.5	-	5	4182.5	-	5	4241.5	-
6	4948.2	-	6	5019.0	-	6	5089.8	-
7	5772.9	-	7	5855.5	-	7	5938.1	-
8	6597.6	-	8	6692.0	-	8	6786.4	-
9	7422.3	-	9	7258.5	-	9	7634.7	-
10	8247.0	-	10	8365.0	-	10	8483.0	-

**Plots: QPSK with 1.4 MHz channel bandwidth**

**Plot 1: Lowest Channel (10 MHz – 8.5 GHz)**

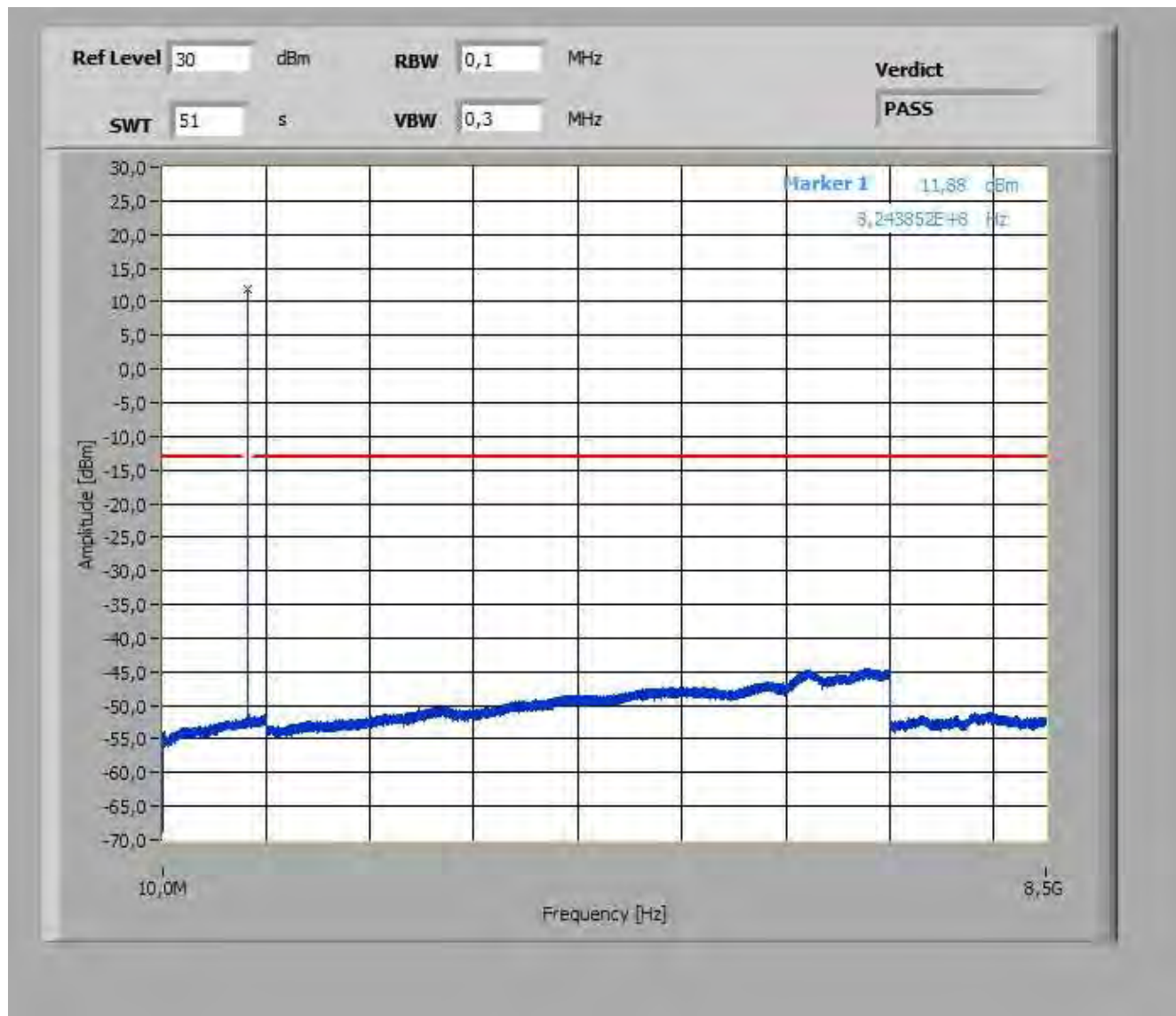

**Plot 2: Middle Channel (10 MHz – 8.5 GHz)**

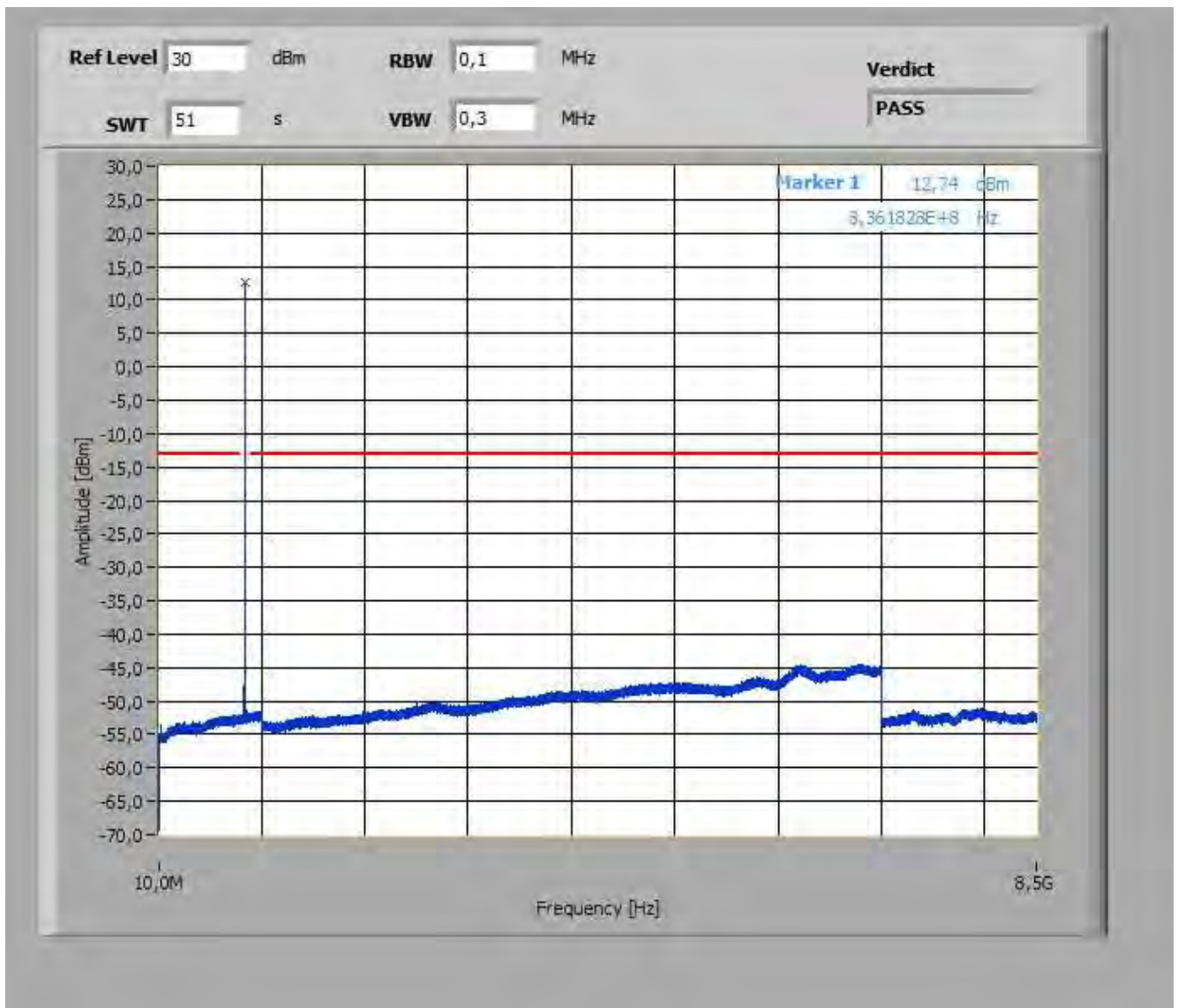

**Plot 3: Highest Channel (10 MHz – 8.5 GHz)**



**Plots: 16-QAM with 1.4 MHz channel bandwidth**

**Plot 1: Lowest Channel (10 MHz – 8.5 GHz)**

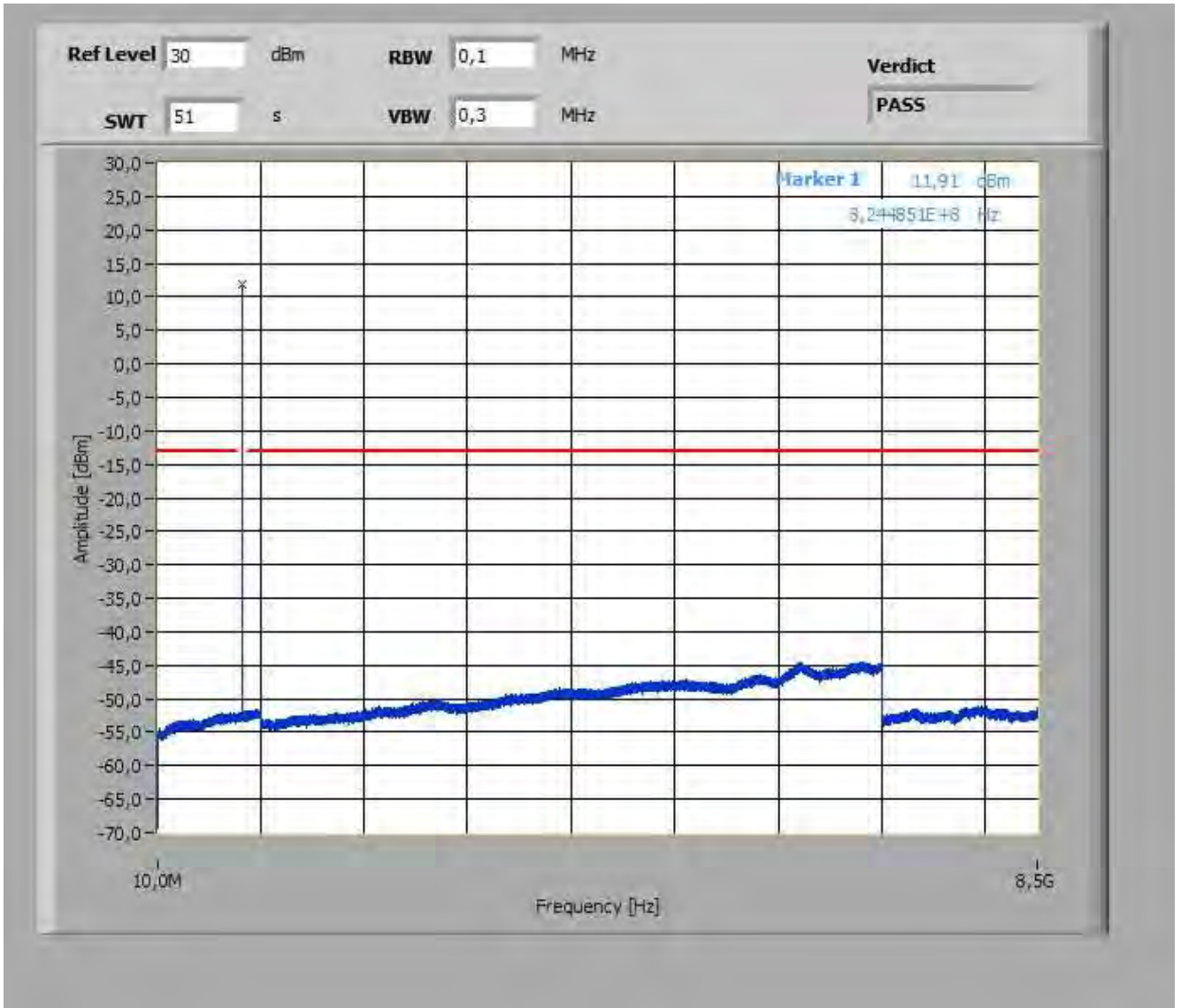

**Plot 2: Middle Channel (10 MHz – 8.5 GHz)**



**Plot 3: Highest Channel (10 MHz – 8.5 GHz)**



## 11.2.5 Block edge compliance

### Description:

The spectrum at the band edges must comply with the spurious emissions limits.

### Measurement:

Measurement parameters	
Detector:	RMS
Sweep time:	180s
Video bandwidth:	100 kHz
Resolution bandwidth:	20 kHz
Span:	1 MHz steps
Trace mode:	Max Hold
Used equipment:	See chapter 7.4 – A
Measurement uncertainty:	See chapter 9
Measurement procedure:	FCC: § 2.1051 ISED: RSS-Gen, 6.13



**Limits:**

FCC	ISED
§ 22.917(a) & (b)	RSS-132, 5.5
<p>(a) The power of any emission outside of the authorized operating frequency ranges must be attenuated below the transmitting power (P) by a factor of at least <b>43 + 10 log(P) dB</b>.</p> <p>(b)(1) In the spectrum below 1 GHz, instrumentation should employ a reference bandwidth of 100 kHz or greater. In the 1 MHz bands immediately outside and adjacent to the frequency block, a RBW of at least one percent of the emission bandwidth of the fundamental emission of the transmitter may be employed. A narrower resolution bandwidth is permitted in all cases to improve measurement accuracy, provided that the measured power is integrated over the full required reference bandwidth (i.e., 100 kHz or 1 percent of emission bandwidth, as specified). The emission bandwidth is defined as the width of the signal between two points, one below the carrier center frequency and one above the carrier center frequency, outside of which all emissions are attenuated at least 26 dB below the transmitter power.</p> <p>(b)(2) In the spectrum above 1 GHz, instrumentation should employ a reference bandwidth of 1 MHz.</p>	<p>i. In the first 1.0 MHz band immediately outside and adjacent to each of the sub-bands specified in Section 5.1, the power of emissions per any 1% of the occupied bandwidth shall be attenuated (in dB) below the transmitter output power P ( dBW) by at least <b>43 + 10 log10(P) (watts)</b>.</p> <p>ii. After the first 1.0 MHz immediately outside and adjacent to each of the sub-bands, the power of emissions in any 100 kHz bandwidth shall be attenuated (in dB) below the transmitter output power P (dBW) by at least <b>43 + 10 log10(P) (watts)</b>. If the measurement is performed using 1% of the occupied bandwidth, power integration over 100 kHz is required.</p>
<p><b>-13 dBm</b></p> <p>Correction factor according to KDB 890810 if RBW &lt; 1 % emission bandwidth:  <input checked="" type="checkbox"/> N/A here  <input type="checkbox"/> <math>10 \log (RBW1/RBW2) = X \text{ dB}</math>; whereas: <math>RBW1 = Y, RBW2 = Z</math></p>	

**Results: 1.4 MHz channel bandwidth**

**Plot 1: Lowest channel – QPSK**

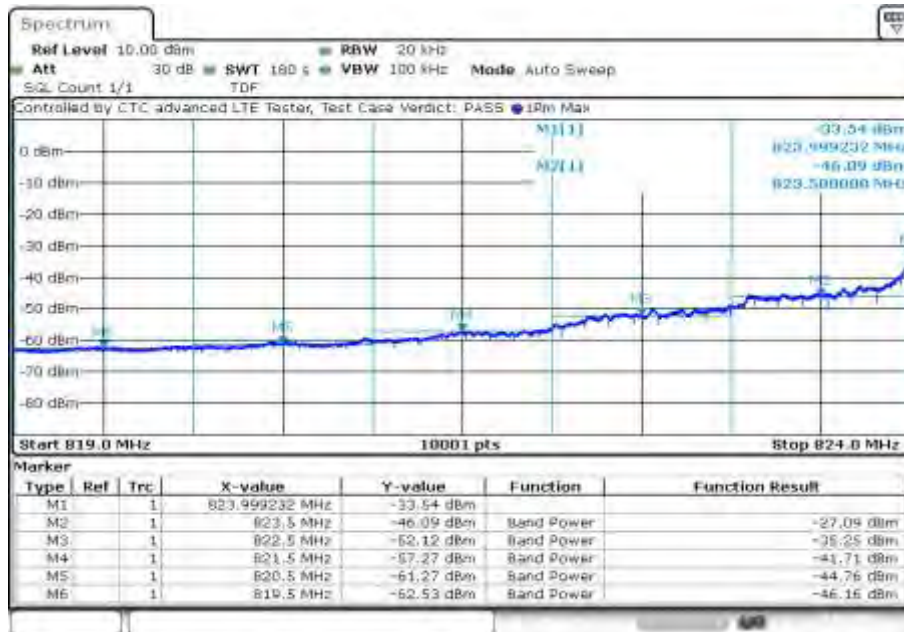

Date: 23.FEB.2022 10:03:42

**Plot 2: Highest channel – QPSK**

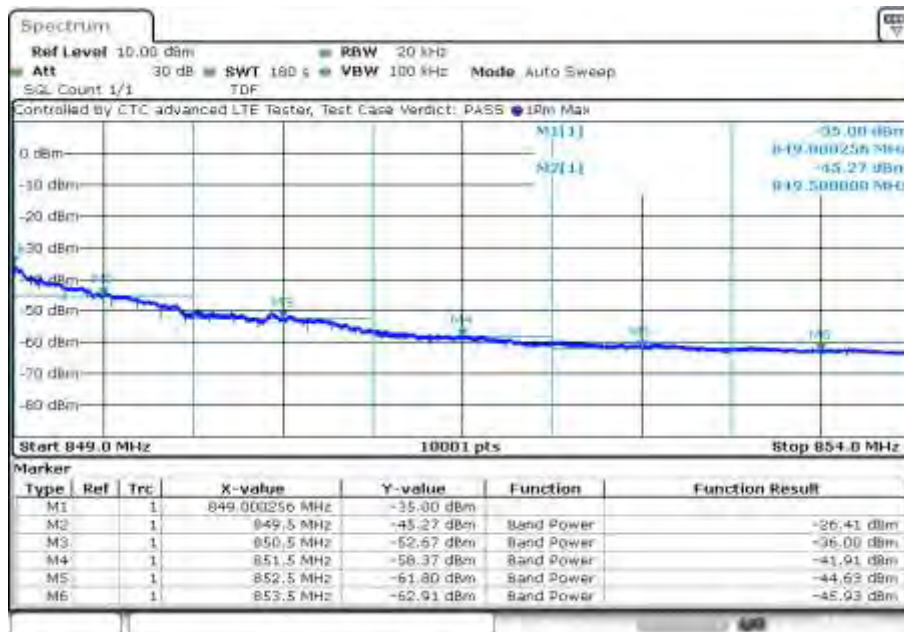

Date: 23.FEB.2022 10:47:50

**Plot 3: Lowest channel – 16-QAM**

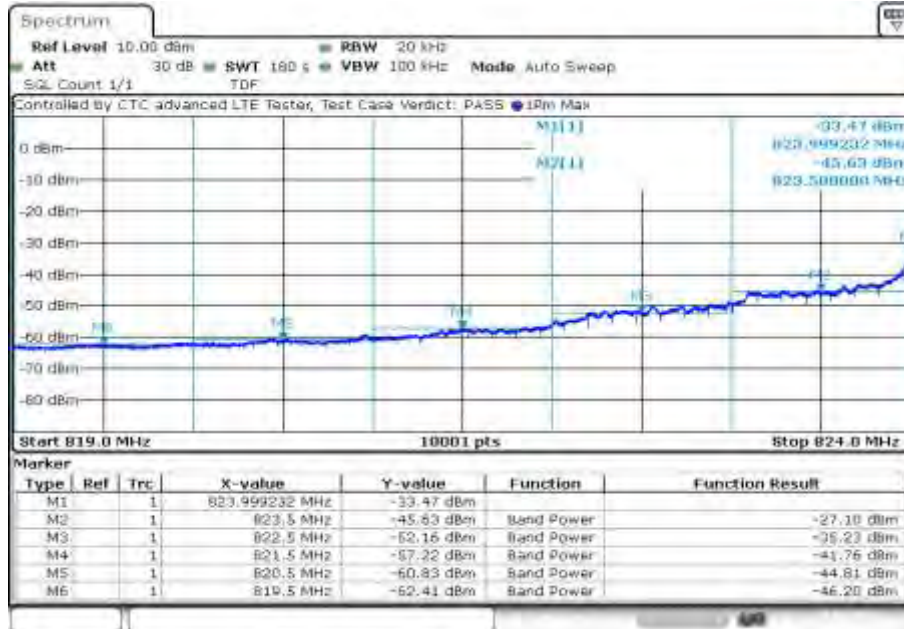

Date: 23.FEB.2022 10:16:19

**Plot 4: Highest channel – 16-QAM**

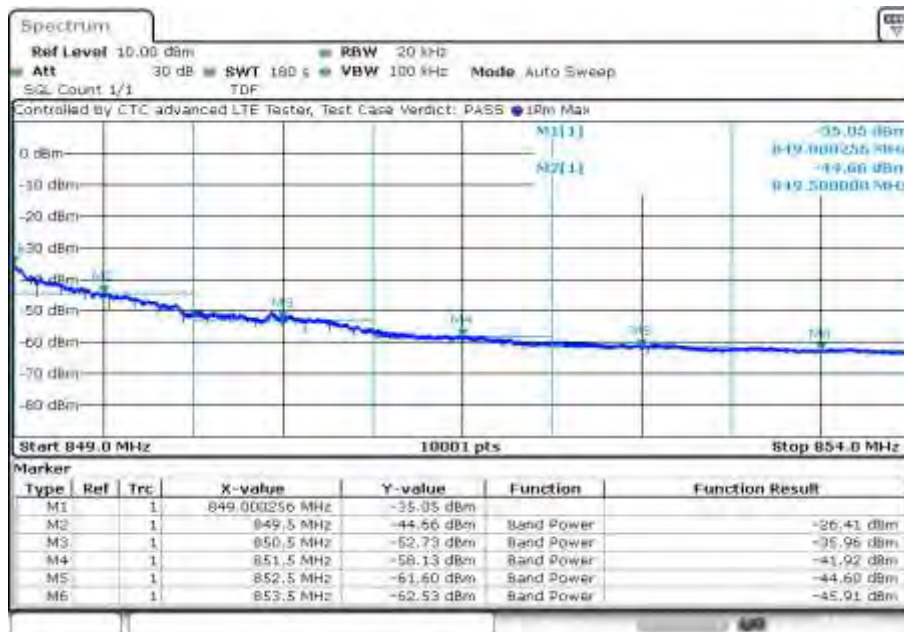

Date: 23.FEB.2022 11:00:23

## 11.2.6 Occupied bandwidth

### Description:

Measurement of the occupied bandwidth of the transmitted signal.

### Measurement:

Similar to conducted emissions, occupied bandwidth measurements are only provided for selected frequencies in order to reduce the amount of submitted data. Data were taken at the extreme and mid frequencies of the LTE band V. The table below lists the measured 99% power and -26dBc occupied bandwidths. Spectrum analyzer plots are included on the following pages.

Measurement parameters	
Detector:	Peak
Sweep time:	180s
Resolution bandwidth:	30 kHz
Video bandwidth:	100 kHz
Span:	2 x nominal BW
Trace mode:	Max Hold
Used equipment:	See chapter 7.4 – A
Measurement uncertainty:	See chapter 9
Measurement procedure:	FCC: § 2.1049 ISED: RSS-Gen, 6.7

### Limits:

FCC	ISED
§ 2.1049	RSS-Gen, 6.7
Reporting only	

**Results:**

Occupied Bandwidth – QPSK		
Frequency (MHz)	99% OBW (kHz)	-26 dBc BW (kHz)
824.7	1101	1308
836.5	1092	1280
848.3	1090	1276

Occupied Bandwidth – 16-QAM		
Frequency (MHz)	99% OBW (kHz)	-26 dBc BW (kHz)
824.7	1102	1310
836.5	1092	1283
848.3	1090	1276

**Plots: QPSK**

**Plot 1: low channel (99% - OBW)**



Date: 23.FEB.2022 10:06:52

**Plot 2: low channel (-26 dBc BW)**



Date: 23.FEB.2022 10:10:02

**Plot 3: mid channel (99% - OBW)**

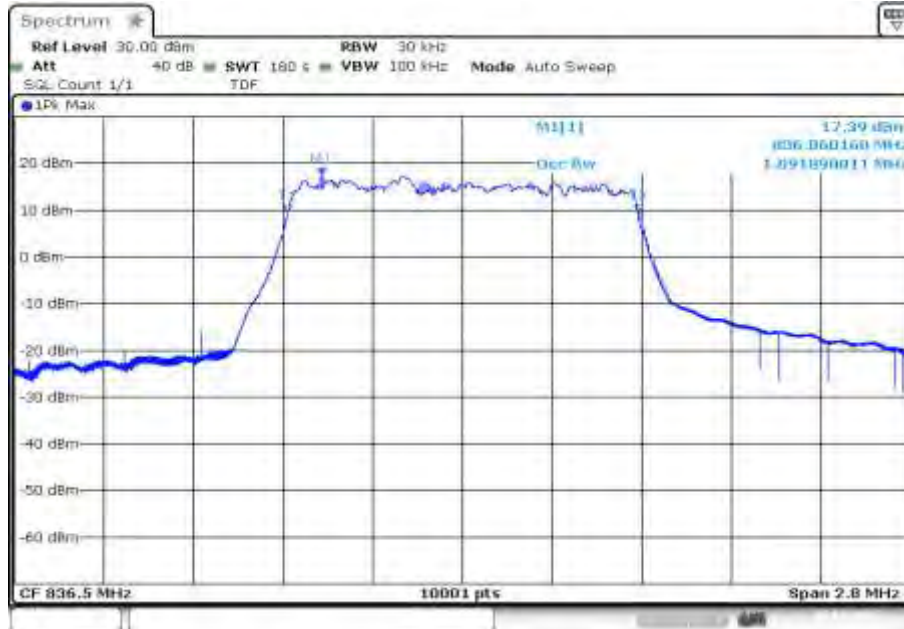

Date: 23.FEB.2022 10:28:57

**Plot 4: mid channel (-26 dBc BW)**



Date: 23.FEB.2022 10:32:06

**Plot 5: high channel (99% - OBW)**

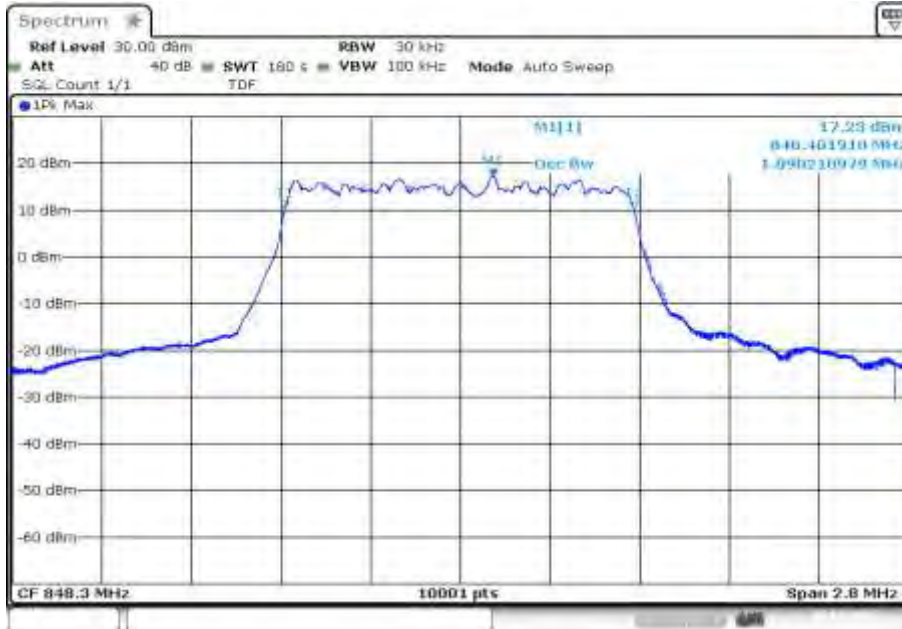

Date: 23.FEB.2022 10:50:59

**Plot 6: high channel (-26 dBc BW)**



Date: 23.FEB.2022 10:54:08



**Plots: 16-QAM**

**Plot 1: low channel (99% - OBW)**

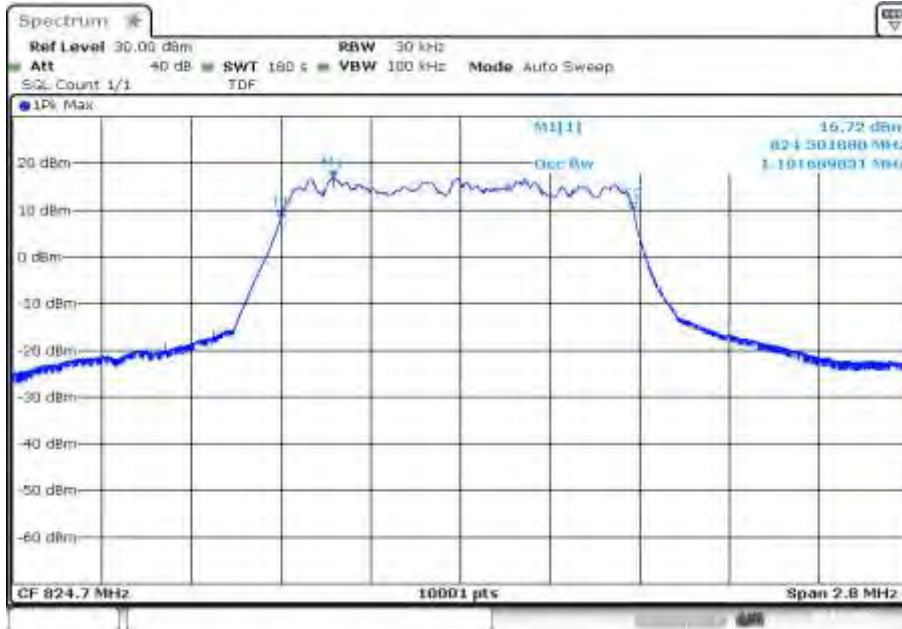

Date: 23.FEB.2022 10:19:29

**Plot 2: low channel (-26 dBc BW)**

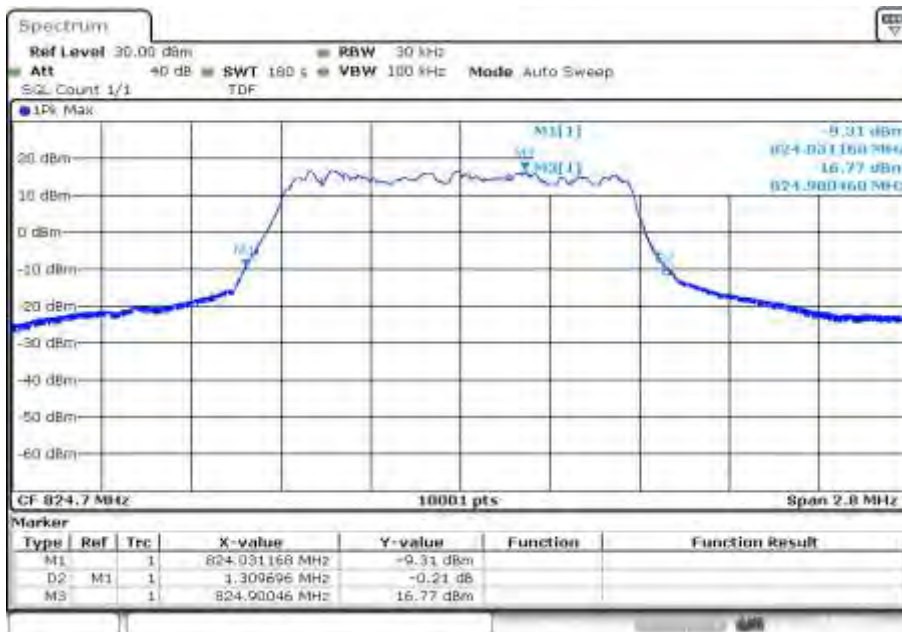

Date: 23.FEB.2022 10:22:39

**Plot 3: mid channel (99% - OBW)**

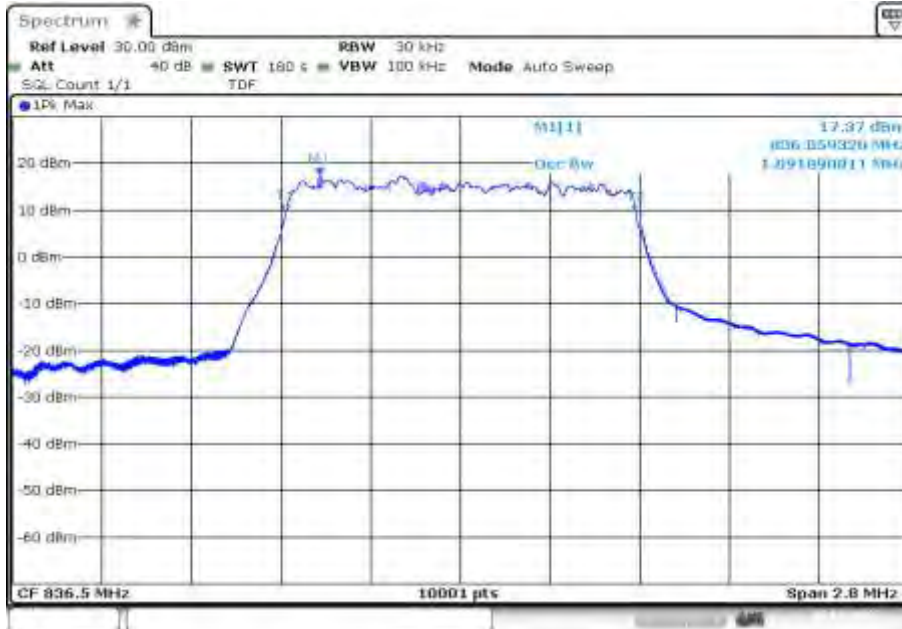

Date: 23.FEB.2022 10:38:20

**Plot 4: mid channel (-26 dBc BW)**



Date: 23.FEB.2022 10:41:29

**Plot 5: high channel (99% - OBW)**

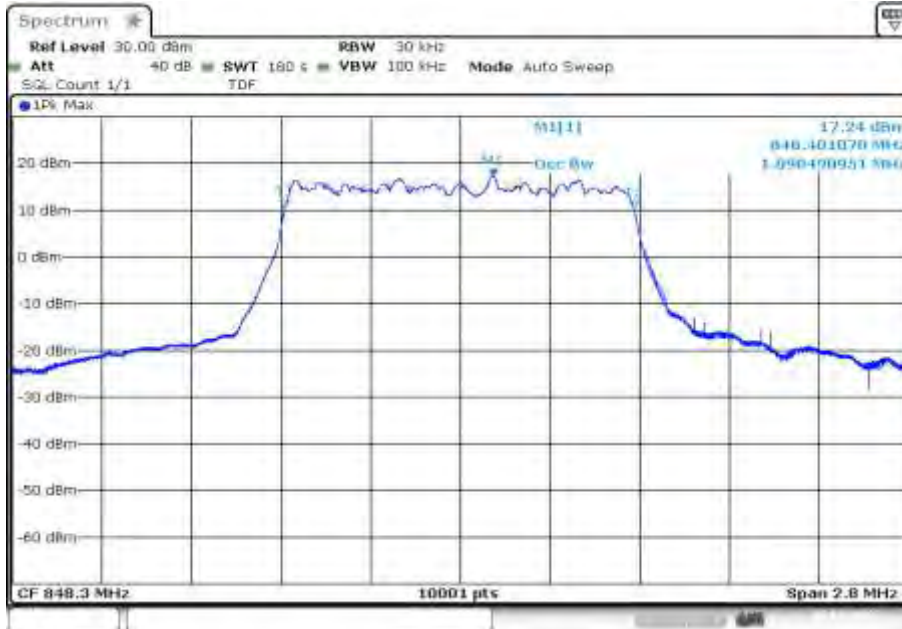

Date: 23.FEB.2022 11:03:32

**Plot 6: high channel (-26 dBc BW)**



Date: 23.FEB.2022 11:06:41

## 12 Summary of measurement results

<input checked="" type="checkbox"/>	No deviations from the technical specifications were ascertained
<input type="checkbox"/>	There were deviations from the technical specifications ascertained
<input type="checkbox"/>	This test report is only a partial test report. The content and verdict of the performed test cases are listed below.

TC identifier	Description	verdict	date	Remark
RF-Testing	FCC: CFR Part 2 & Part 24 ISED: RSS-Gen, Issue 5 RSS 133, Issue 6 & SRSP-510, Issue 5	See table!	2022-04-14	-/-

### 12.1 Part 24/RSS-133: LTE band 2

Test Case	temperature conditions	power source voltages	C	NC	NA	NP	Remark
RF Output Power	Nominal	Nominal	<input checked="" type="checkbox"/>	<input type="checkbox"/>	<input type="checkbox"/>	<input type="checkbox"/>	-/-
Frequency Stability	Extreme	Extreme	<input checked="" type="checkbox"/>	<input type="checkbox"/>	<input type="checkbox"/>	<input type="checkbox"/>	-/-
Spurious Emissions Radiated	Nominal	Nominal	<input checked="" type="checkbox"/>	<input type="checkbox"/>	<input type="checkbox"/>	<input type="checkbox"/>	-/-
Spurious Emissions Conducted	Nominal	Nominal	<input checked="" type="checkbox"/>	<input type="checkbox"/>	<input type="checkbox"/>	<input type="checkbox"/>	-/-
Block Edge Compliance	Nominal	Nominal	<input checked="" type="checkbox"/>	<input type="checkbox"/>	<input type="checkbox"/>	<input type="checkbox"/>	-/-
Occupied Bandwidth	Nominal	Nominal	<input checked="" type="checkbox"/>	<input type="checkbox"/>	<input type="checkbox"/>	<input type="checkbox"/>	-/-

**Note:** C – Compliant; NC – Not compliant; NA = Not applicable; NP = Not performed

## 13 RF measurements

### 13.1 Description of test setup

For the spurious measurements we use the substitution method according TIA/EIA 603.

### 13.2 Results LTE band 2

The EUT was set to transmit the maximum power.

#### 13.2.1 RF output power

##### Description:

This paragraph contains average power, peak output power and EIRP measurements for the mobile station. In all cases, the peak output power is within the required mask (this mask is specified in the JTC standards, TIA PN3389 Vol. 1 Chap 7, and is no FCC requirement).

##### Measurement:

The mobile was set up for the maximum output power with pseudo random data modulation.

To determine the Peak-To-Average Power Ratio (PAPR) the measurement was performed with the Power Complementary Cumulative Distribution Function (CCDF).

Measurement parameters	
Detector:	Sample
AQT:	See plot
Resolution bandwidth:	1 MHz
Used equipment:	See chapter 7.2 – C & 7.4 – A
Measurement uncertainty:	See chapter 9
Measurement procedure:	FCC: § 2.1046 ISED: RSS-Gen, 6.12

**Limits:**

FCC	ISED
§ 24.232(c)	RSS-133, 6.4 (referring to: SRSP-510, Issue 5)
<p>(c) Mobile and portable stations are limited to 2 watts EIRP and the equipment must employ a means for limiting power to the minimum necessary for successful communications.</p> <p>(d) In measuring transmissions in this band using an average power technique, the peak-to-average ratio (PAR) of the transmission may not exceed 13 dB.</p>	<p>SRSP-510, 5.1: Mobile stations and hand-held portables are limited to 2 watts maximum e.i.r.p.</p> <p>RSS-133, 6.4: In addition, the transmitter's peak-to-average power ratio (PAPR) shall not exceed 13 dB for more than 0.1% of the time using a signal corresponding to the highest PAPR during periods of continuous transmission.</p>
<p>Power: <b>33 dBm EIRP</b> PAPR: <b>13 dB</b></p>	

**Results:**

Output Power (conducted)						
Bandwidth (MHz)	Frequency (MHz)	Resource block allocation	Average Output Power (dBm) QPSK	Peak to Average Ratio (dB)	Average Output Power (dBm) 16-QAM	Peak to Average Ratio (dB)
1.4	18607 / 1850.7	1 RB low	18.5	5.9	17.0	7.2
		1 RB high	18.4	5.9	16.6	7.2
		100% RB	16.4	6.8	16.4	7.4
	18900 / 1880.0	1 RB low	18.7	5.9	17.8	6.9
		1 RB high	18.6	5.9	17.7	6.9
		100% RB	16.7	6.7	16.8	7.4
	19193 / 1909.3	1 RB low	19.1	5.6	17.5	6.8
		1 RB high	18.9	5.7	17.7	6.8
		100% RB	17.0	6.6	17.1	7.2
3	18615 / 1851.5	1 RB low	18.4	5.9	17.2	7.0
		1 RB high	18.2	6.0	17.1	7.1
		100% RB	16.4	6.8	16.3	7.4
	18900 / 1880.0	1 RB low	18.7	5.8	17.8	6.8
		1 RB high	18.6	5.9	17.5	7.0
		100% RB	16.6	6.8	16.8	7.3
	19185 / 1908.5	1 RB low	19.2	5.6	17.8	6.7
		1 RB high	19.0	5.7	17.7	6.8
		100% RB	16.2	7.4	17.1	7.2
5	18625 / 1852.5	1 RB low	20.3	4.1	20.5	4.5
		1 RB high	20.2	4.1	20.2	4.6
		100% RB	19.2	4.8	18.2	5.8
	18900 / 1880.0	1 RB low	20.7	4.0	20.2	4.6
		1 RB high	20.5	4.1	20.3	4.6
		100% RB	19.4	4.7	18.4	5.8
	19175 / 1907.5	1 RB low	21.0	3.8	21.2	4.0
		1 RB high	20.9	3.8	21.0	4.2
		100% RB	19.8	4.6	18.9	5.5

10	18650 / 1855.0	1 RB low	20.4	4.0	20.4	4.5
		1 RB high	20.1	4.2	20.2	4.6
		100% RB	19.0	4.8	19.2	5.4
	18900 / 1880.0	1 RB low	20.5	4.0	20.4	4.5
		1 RB high	20.3	4.1	20.1	4.6
		100% RB	19.4	4.7	19.3	5.3
	19150 / 1905.0	1 RB low	21.0	3.8	21.2	4.0
		1 RB high	20.8	3.9	20.9	4.1
		100% RB	19.7	4.6	19.9	5.0
15	18675 / 1857.5	1 RB low	20.1	4.1	20.3	4.4
		1 RB high	20.0	4.2	20.2	4.5
		100% RB	20.0	4.4	20.1	4.8
	18900 / 1880.0	1 RB low	20.4	4.0	20.2	4.5
		1 RB high	20.4	4.0	20.3	4.5
		100% RB	20.2	4.3	20.3	4.7
	19125 / 1902.5	1 RB low	20.9	3.7	21.0	4.0
		1 RB high	20.6	3.9	20.7	4.1
		100% RB	20.5	4.1	20.6	4.4
20	18700 / 1860.0	1 RB low	19.7	4.1	20.0	4.4
		1 RB high	19.8	4.1	19.9	4.6
		100% RB	19.7	4.4	19.8	4.7
	18900 / 1880.0	1 RB low	20.1	4.0	20.1	4.4
		1 RB high	20.0	4.1	19.5	4.7
		100% RB	19.9	4.3	19.8	4.8
	19100 / 1900.0	1 RB low	20.7	3.8	21.0	3.9
		1 RB high	20.6	3.8	20.6	4.1
		100% RB	20.3	4.1	20.5	4.4



The radiated output power is measured in the mode with the highest conducted output power.

Output Power (EIRP)			
Bandwidth (MHz)	Frequency (MHz)	Average Output Power (dBm)	Average Output Power (dBm)
		QPSK	16-QAM
1.4	1850.7	19.0	17.5
	1880.0	19.9	19.0
	1909.3	22.1	20.7
3	1851.5	18.9	17.7
	1880.0	19.9	19.0
	1908.5	22.2	20.8
5	1852.5	20.8	21.0
	1880.0	21.9	21.5
	1907.5	24.0	24.2
10	1855.0	20.9	20.9
	1880.0	21.7	21.6
	1905.0	24.0	24.2
15	1857.5	20.6	20.8
	1880.0	21.6	21.5
	1902.5	23.9	24.0
20	1860.0	20.3	20.5
	1880.0	21.3	21.3
	1900.0	23.7	24.0

### 13.2.2 Frequency stability

**Description:**

In order to measure the carrier frequency under the condition of AFC lock, it is necessary to make measurements with the mobile station in a “call mode”. This is accomplished with the use of a R&S CMW500 DIGITAL RADIOCOMMUNICATION TESTER.

1. Measure the carrier frequency at room temperature.
2. Subject the mobile station to overnight soak at -30 C.
3. With the mobile station, powered with  $V_{nom}$ , connected to the CMW500 and in a simulated call on channel 9400 (centre channel), measure the carrier frequency. These measurements should be made within two minutes of powering up the mobile station, to prevent significant self warming.
4. Repeat the above measurements at 10°C increments from -30°C to +50°C. Allow at least 1.5 hours at each temperature, unpowered, before making measurements.
5. Remeasure carrier frequency at room temperature with  $V_{nom}$ . Vary supply voltage from  $V_{min}$  to  $V_{max}$ , in 0.1 Volt steps remeasuring carrier frequency at each voltage. Pause at  $V_{nom}$  for 1.5 hours unpowered, to allow any self heating to stabilize, before continuing.
6. At all temperature levels hold the temperature to +/- 0.5°C during the measurement procedure.

**Measurement:**

Measurement parameters	
Detector:	Measured with CMW500
Sweep time:	
Video bandwidth:	
Resolution bandwidth:	
Span:	
Trace-Mode:	
Used equipment:	See chapter 7.4 setup A
Measurement uncertainty:	See chapter 9
Measurement procedure:	FCC: § 2.1055 ISED: RSS-Gen, 6.11

**Limits:**

FCC	ISED
§ 24.235	RSS-133, 6.3
The frequency stability shall be sufficient to ensure that the fundamental emission stays within the authorized frequency block.	The carrier frequency shall not depart from the reference frequency, in excess of ±2.5 ppm for mobile stations and ±1.0 ppm for base stations.
<b>± 2.5 ppm (ISED only)</b>	

**Results:****AFC FREQ ERROR versus VOLTAGE**

Voltage (V)	Frequency Error (Hz)	Frequency Error (ppm)
3.2	-27	-0.0144
3.6	-27	-0.0144
4.0	-27	-0.0144

**AFC FREQ ERROR versus TEMPERATURE**

Temperature (°C)	Frequency Error (Hz)	Frequency Error (ppm)
-30	25	0.0133
-20	30	0.0160
-10	33	0.0176
± 0	26	0.0138
10	-62	-0.0330
20	-27	-0.0144
30	-44	-0.0234
40	-57	-0.0303
50	-66	-0.0351

### 13.2.3 Spurious emissions radiated

#### Description:

The following steps outline the procedure used to measure the radiated emissions from the mobile station. The site is constructed in accordance with ANSI C63.4:2014 requirements and is recognized by the FCC to be in compliance for a 3 and a 10 meter site. The spectrum was scanned from 30 MHz to the 10th harmonic of the highest frequency generated within the equipment. The resolution bandwidth is set as outlined in Part 24.238. The spectrum was scanned with the mobile station transmitting at carrier frequencies that pertain to low, mid and high channels of the LTE band II.

#### Measurement:

Measurement parameters	
Detector:	Peak
Sweep time:	2 sec.
Resolution bandwidth:	1 MHz
Video bandwidth:	3 MHz
Span:	100 MHz Steps
Trace mode:	Max Hold
Used equipment:	See chapter 7.1 – A & 7.2 – B
Measurement uncertainty:	See chapter 9
Measurement procedure	FCC: § 2.1053 ISED: RSS-Gen, 6.13

**Limits:**

FCC	ISED
§ 24.238 (a) & (b)	RSS-133, 6.5
<p>(a) The power of any emission outside of the authorized operating frequency ranges must be attenuated below the transmitting power (P) by a factor of at least <b>43 + 10 log(P) dB</b>.</p> <p>(b) Compliance with these rules is based on the use of measurement instrumentation employing a resolution bandwidth of 1 MHz or greater. However, in the 1 MHz bands immediately outside and adjacent to the frequency block a resolution bandwidth of at least one percent of the emission bandwidth of the fundamental emission of the transmitter may be employed. A narrower resolution bandwidth is permitted in all cases to improve measurement accuracy provided the measured power is integrated over the full required measurement bandwidth (i.e. 1 MHz or 1 percent of emission bandwidth, as specified). The emission bandwidth is defined as the width of the signal between two points, one below the carrier center frequency and one above the carrier center frequency, outside of which all emissions are attenuated at least 26 dB below the transmitter power.</p>	<p>In the 1.0 MHz bands immediately outside and adjacent to the equipment's operating frequency block, the emission power per any 1% of the emission bandwidth shall be attenuated (in dB) below the transmitter output power P (dBW) by at least <b>43 + 10 log(P) (watts)</b>.</p> <p>After the first 1.0 MHz, the emission power in any 1 MHz bandwidth shall be attenuated (in dB) below the transmitter output power P (dBW) by at least <b>43 + 10 log(P) (watts)</b>. If the measurement is performed using 1% of the emission bandwidth, power integration over 1.0 MHz is required.</p>
<b>-13 dBm</b>	

**Results:**

**QPSK:**

SPURIOUS EMISSION LEVEL								
Harmonic	Lowest channel Freq. (MHz)	Level [dBm]	Harmonic	Middle channel Freq. (MHz)	Level [dBm]	Harmonic	Highest channel Freq. (MHz)	Level [dBm]
2	3710.0	-	2	3760.0	-	2	3810.0	-
3	5565.0	-	3	5640.0	-	3	5715.0	-
4	7420.0	-	4	7520.0	-	4	7620.0	-
5	9275.0	-	5	9400.0	-	5	9525.0	-
6	11130.0	-	6	11280.0	-	6	11430.0	-
7	12985.0	-	7	13160.0	-	7	13335.0	-
8	14840.0	-	8	15040.0	-	8	15240.0	-
9	16695.0	-	9	16920.0	-	9	17145.0	-
10	18550.0	-	10	18800.0	-	10	19050.0	-

**16-QAM:**

SPURIOUS EMISSION LEVEL								
Harmonic	Lowest channel Freq. (MHz)	Level [dBm]	Harmonic	Middle channel Freq. (MHz)	Level [dBm]	Harmonic	Highest channel Freq. (MHz)	Level [dBm]
2	3710.0	-	2	3760.0	-	2	3810.0	-
3	5565.0	-	3	5640.0	-	3	5715.0	-
4	7420.0	-	4	7520.0	-	4	7620.0	-
5	9275.0	-	5	9400.0	-	5	9525.0	-
6	11130.0	-	6	11280.0	-	6	11430.0	-
7	12985.0	-	7	13160.0	-	7	13335.0	-
8	14840.0	-	8	15040.0	-	8	15240.0	-
9	16695.0	-	9	16920.0	-	9	17145.0	-
10	18550.0	-	10	18800.0	-	10	19050.0	-

**QPSK**

**Plot 1: Mid channel (9 kHz - 30 MHz)**

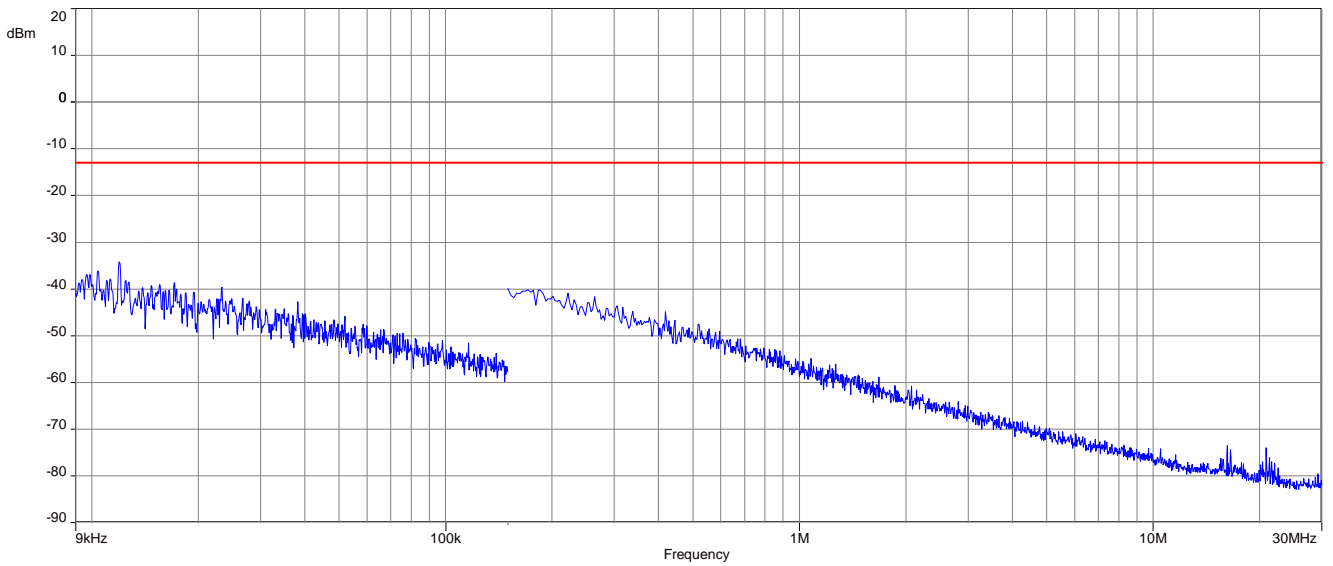

**Plot 2: Mid channel (30 MHz – 1 GHz)**

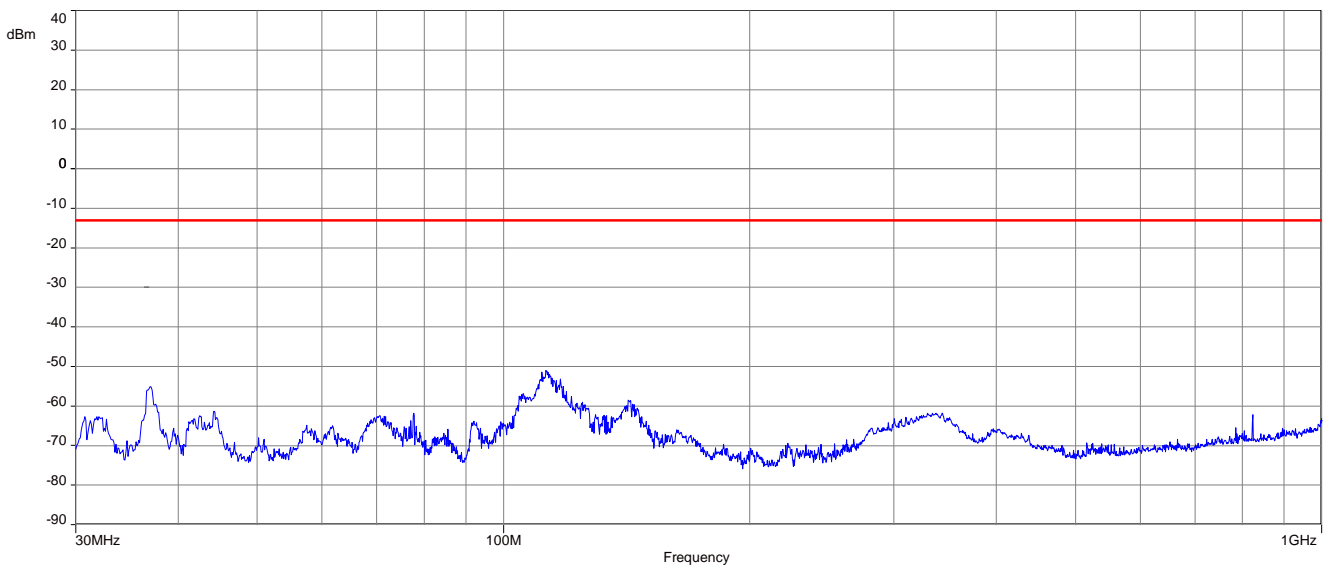

**Plot 3: Mid channel (1 GHz – 18 GHz)**

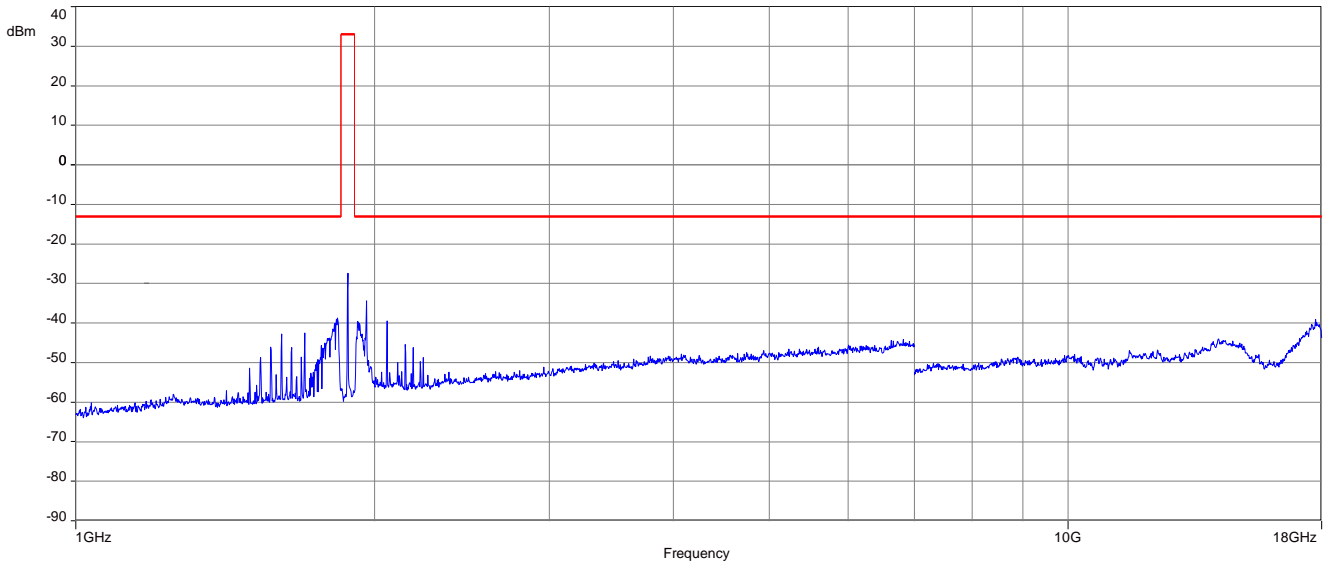

*Carrier notched with 1.9 GHz rejection filter*

**Plot 4: Mid channel (18 GHz – 20 GHz)**

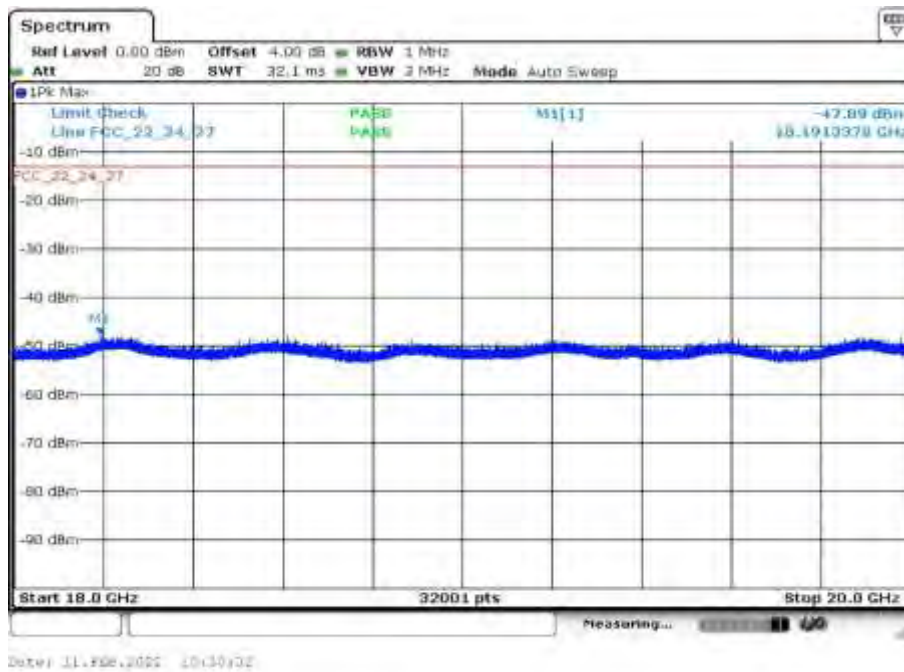



**16-QAM**

**Plot 1: Mid channel (9 kHz - 30 MHz)**

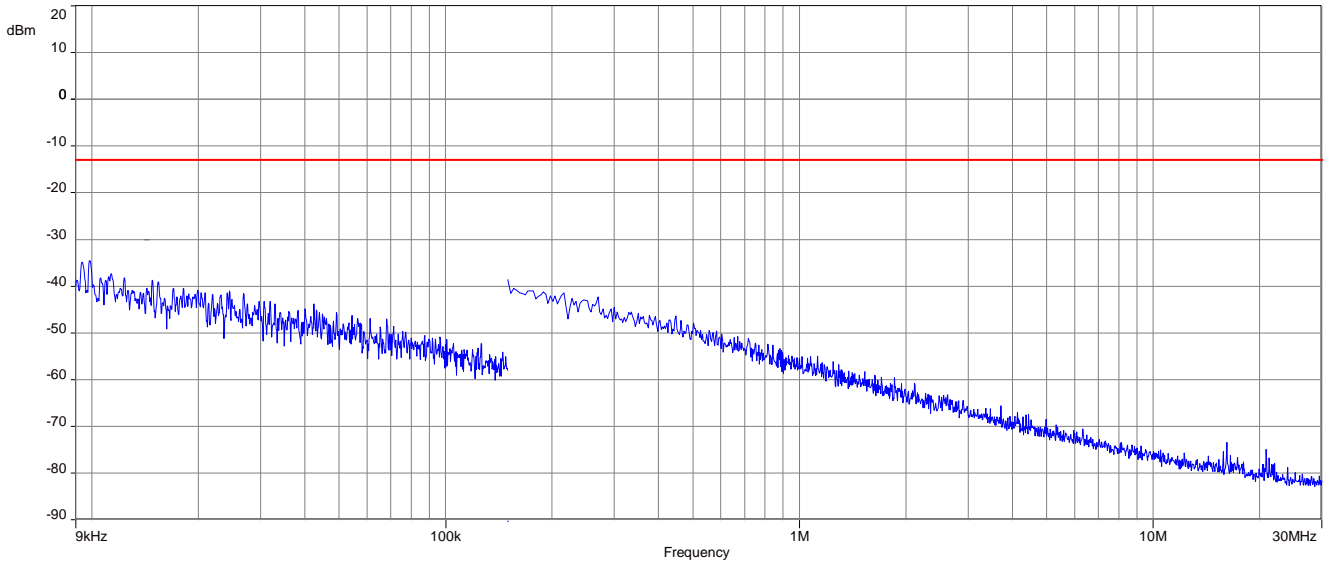

**Plot 2: Mid channel (30 MHz – 1 GHz)**

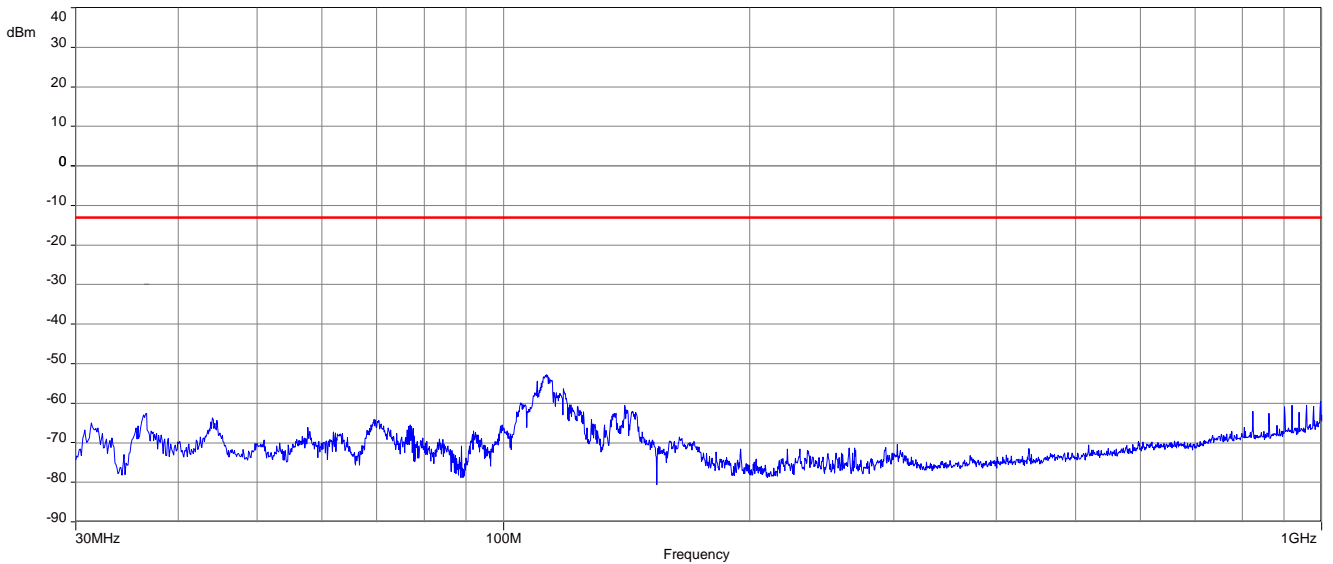

**Plot 3: Mid channel (1 GHz – 18 GHz)**

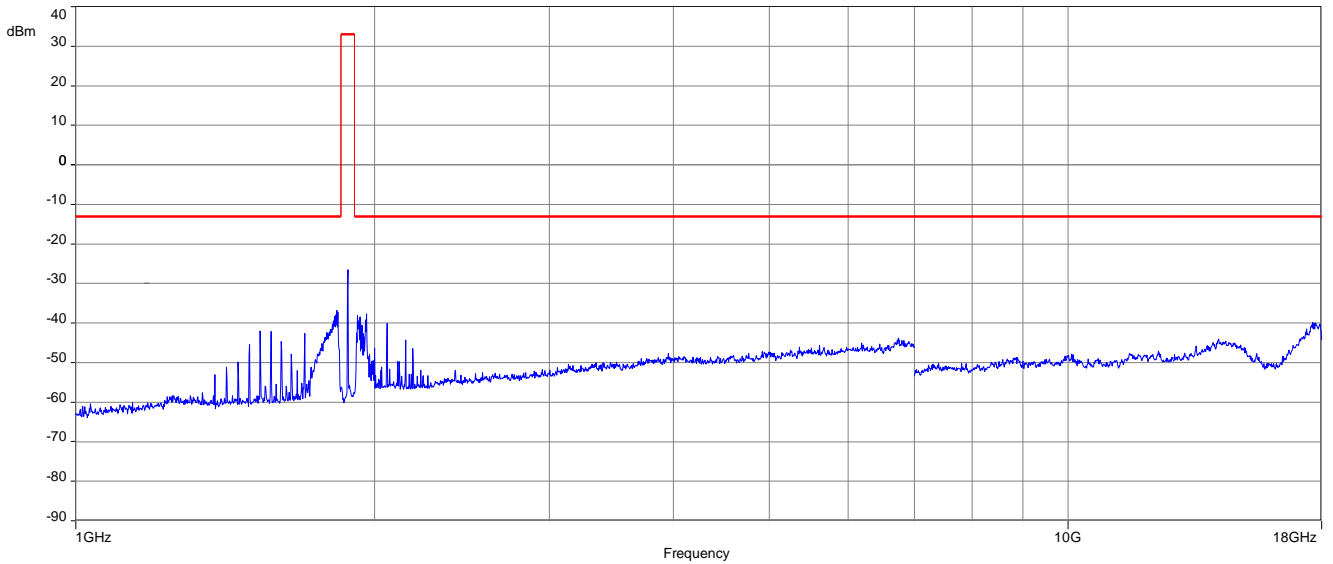

*Carrier notched with 1.9 GHz rejection filter*

**Plot 4: Mid channel (18 GHz – 20 GHz)**

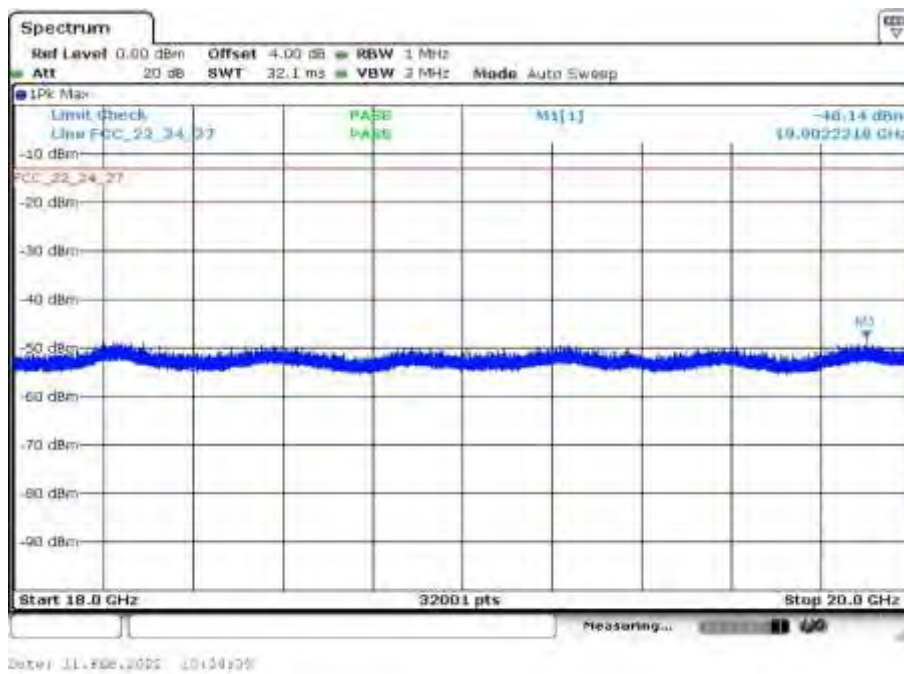

### 13.2.4 Spurious emissions conducted

#### Description:

The following steps outline the procedure used to measure the conducted emissions from the mobile station.

1. Determine frequency range for measurements: From § 2.1057 & RSS-Gen, 6.13.2 the spectrum should be investigated from the lowest radio frequency generated in the equipment up to at least the 10th harmonic of the carrier frequency.
2. Determine mobile station transmits frequencies: below outlines the band edge frequencies pertinent to conducted emissions testing.

#### Measurement:

Measurement parameters	
Detector:	Peak
Sweep time:	Auto
Video bandwidth:	300 kHz
Resolution bandwidth:	100 kHz
Span:	30 MHz – 19.5 GHz
Trace-Mode:	Max Hold
Used equipment:	See chapter
Measurement uncertainty:	see chapter 9
Measurement procedure	FCC: § 2.1051 ISED: RSS-Gen, 6.13

**Limits:**

FCC	IC
§ 24.238 (a) & (b)	RSS-133, 6.5
<p>(a) The power of any emission outside of the authorized operating frequency ranges must be attenuated below the transmitting power (P) by a factor of at least <b>43 + 10 log(P) dB</b>.</p> <p>(b) Compliance with these rules is based on the use of measurement instrumentation employing a resolution bandwidth of 1 MHz or greater. However, in the 1 MHz bands immediately outside and adjacent to the frequency block a resolution bandwidth of at least one percent of the emission bandwidth of the fundamental emission of the transmitter may be employed. A narrower resolution bandwidth is permitted in all cases to improve measurement accuracy provided the measured power is integrated over the full required measurement bandwidth (i.e. 1 MHz or 1 percent of emission bandwidth, as specified). The emission bandwidth is defined as the width of the signal between two points, one below the carrier center frequency and one above the carrier center frequency, outside of which all emissions are attenuated at least 26 dB below the transmitter power.</p>	<p>In the 1.0 MHz bands immediately outside and adjacent to the equipment's operating frequency block, the emission power per any 1% of the emission bandwidth shall be attenuated (in dB) below the transmitter output power P (dBW) by at least <b>43 + 10 log(P) (watts)</b>.</p> <p>After the first 1.0 MHz, the emission power in any 1 MHz bandwidth shall be attenuated (in dB) below the transmitter output power P (dBW) by at least <b>43 + 10 log(P) (watts)</b>. If the measurement is performed using 1% of the emission bandwidth, power integration over 1.0 MHz is required.</p>
<b>-13 dBm</b>	

**Results: for 1.4 MHz channel bandwidth**

**QPSK:**

SPURIOUS EMISSION LEVEL								
Harmonic	Lowest channel Freq. (MHz)	Level [dBm]	Harmonic	Middle channel Freq. (MHz)	Level [dBm]	Harmonic	Highest channel Freq. (MHz)	Level [dBm]
2	3701.4	-	2	3760.0	-	2	3818.6	-
3	5552.1	-	3	5640.0	-	3	5727.9	-
4	7402.8	-	4	7520.0	-	4	7637.2	-
5	9253.5	-	5	9400.0	-	5	9546.5	-
6	11104.2	-	6	11280.0	-	6	11455.8	-
7	12954.9	-	7	13160.0	-	7	13365.1	-
8	14805.6	-	8	15040.0	-	8	15274.4	-
9	16656.3	-	9	16920.0	-	9	17183.7	-
10	18507.0	-	10	18800.0	-	10	19093.0	-

**16-QAM:**

SPURIOUS EMISSION LEVEL								
Harmonic	Lowest channel Freq. (MHz)	Level [dBm]	Harmonic	Middle channel Freq. (MHz)	Level [dBm]	Harmonic	Highest channel Freq. (MHz)	Level [dBm]
2	3701.4	-	2	3760.0	-	2	3818.6	-
3	5552.1	-	3	5640.0	-	3	5727.9	-
4	7402.8	-	4	7520.0	-	4	7637.2	-
5	9253.5	-	5	9400.0	-	5	9546.5	-
6	11104.2	-	6	11280.0	-	6	11455.8	-
7	12954.9	-	7	13160.0	-	7	13365.1	-
8	14805.6	-	8	15040.0	-	8	15274.4	-
9	16656.3	-	9	16920.0	-	9	17183.7	-
10	18507.0	-	10	18800.0	-	10	19093.0	-

**Plots: QPSK with 1.4 MHz channel bandwidth**

**Plot 1: Lowest Channel (10 MHz – 19.5 GHz)**

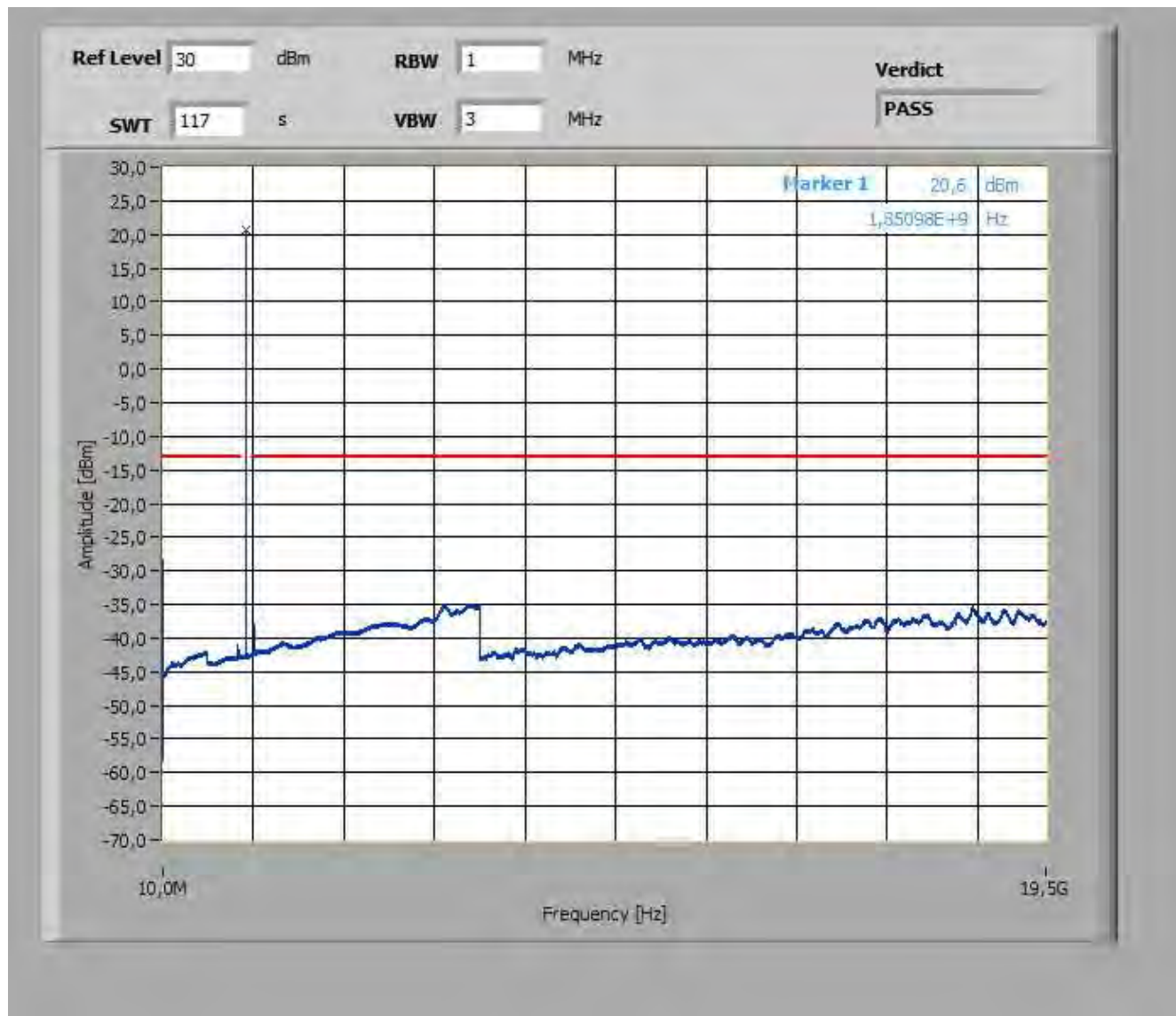

**Plot 2: Middle Channel (10 MHz – 19.5 GHz)**

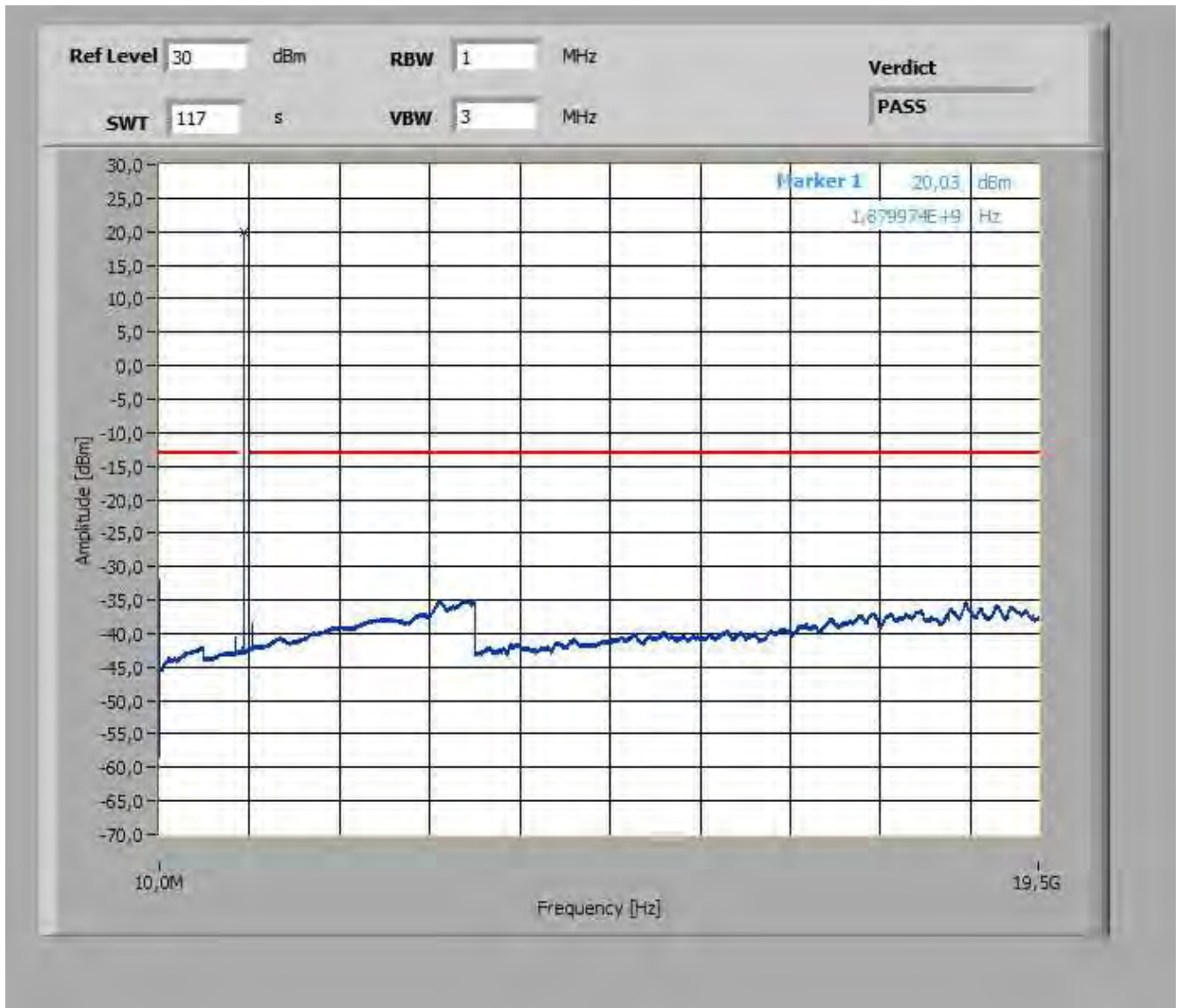

**Plot 3:** Highest Channel (10 MHz – 19.5 GHz)

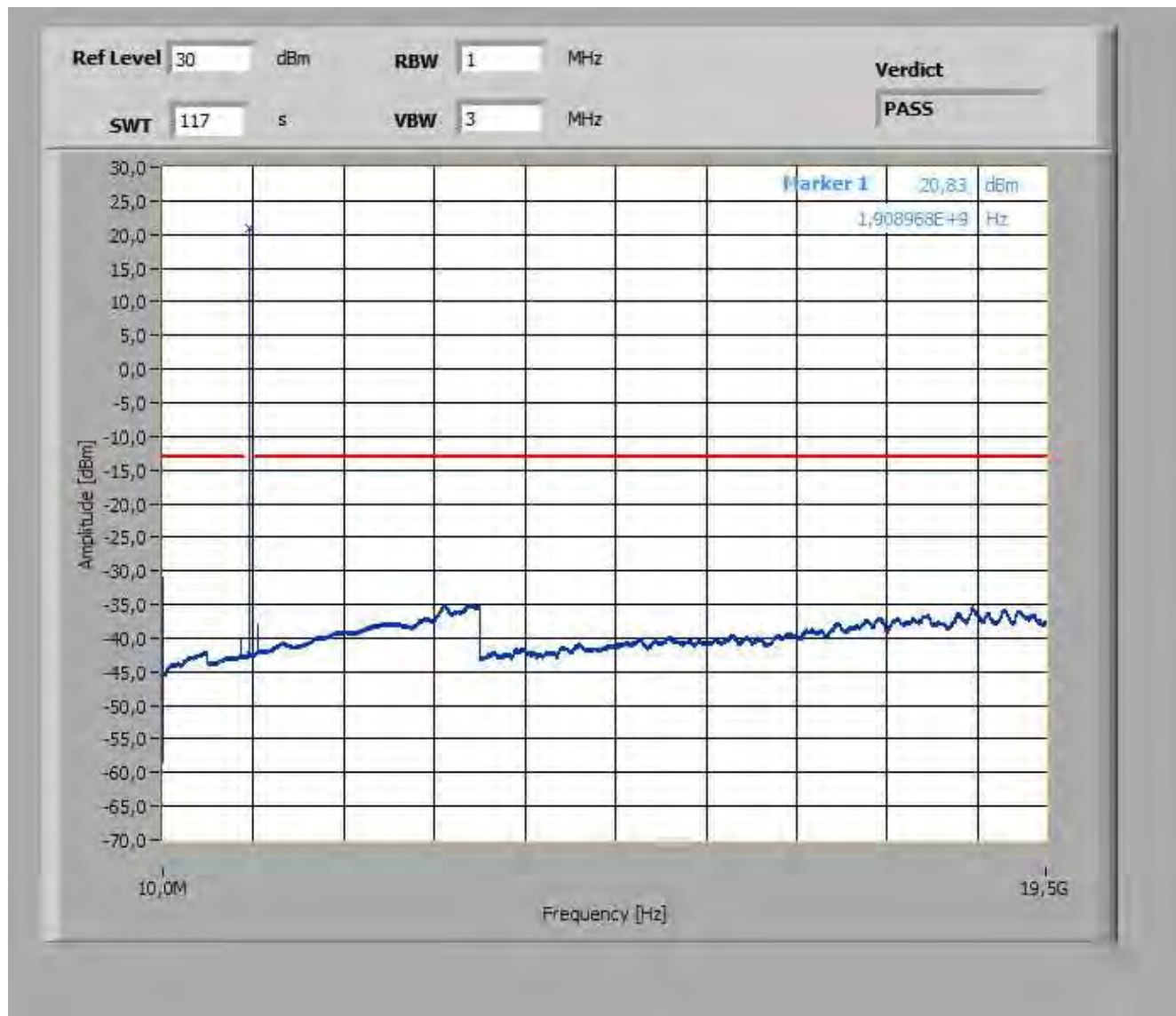



**Plots: 16-QAM with 1.4 MHz channel bandwidth**

**Plot 1: Lowest Channel (10 MHz – 19.5 GHz)**

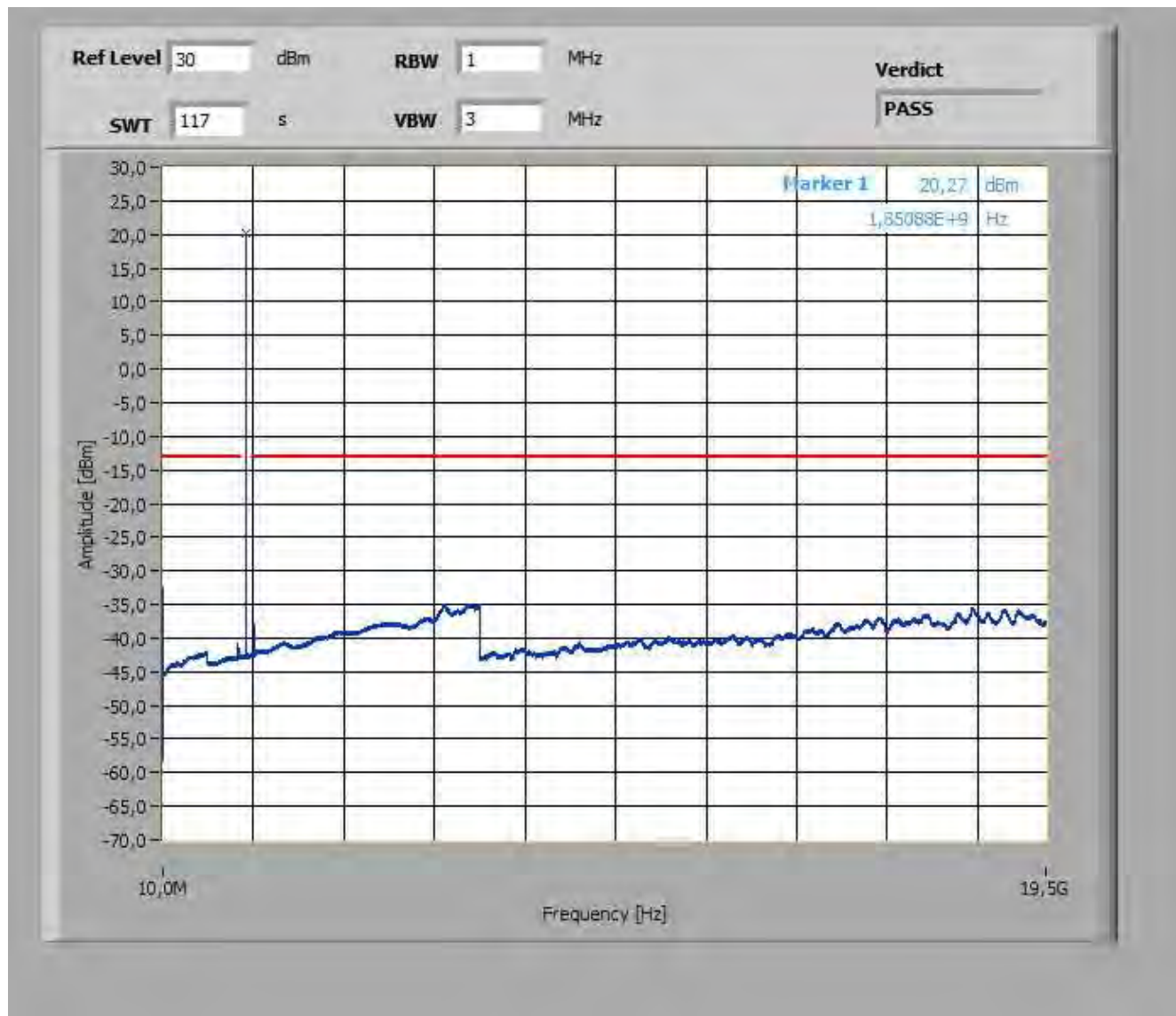

**Plot 2: Middle Channel (10 MHz – 19.5 GHz)**

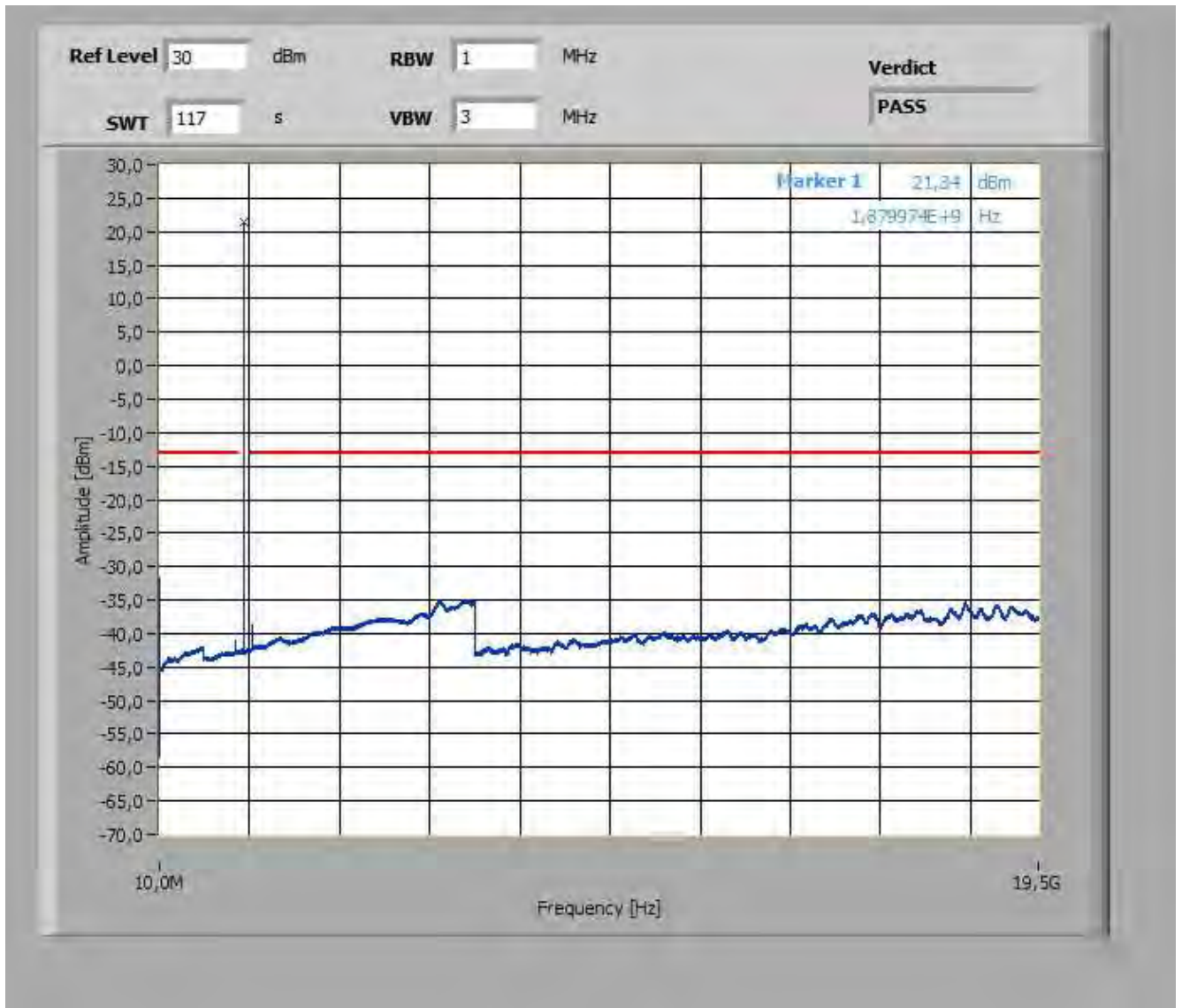

**Plot 3:** Highest Channel (10 MHz – 19.5 GHz)

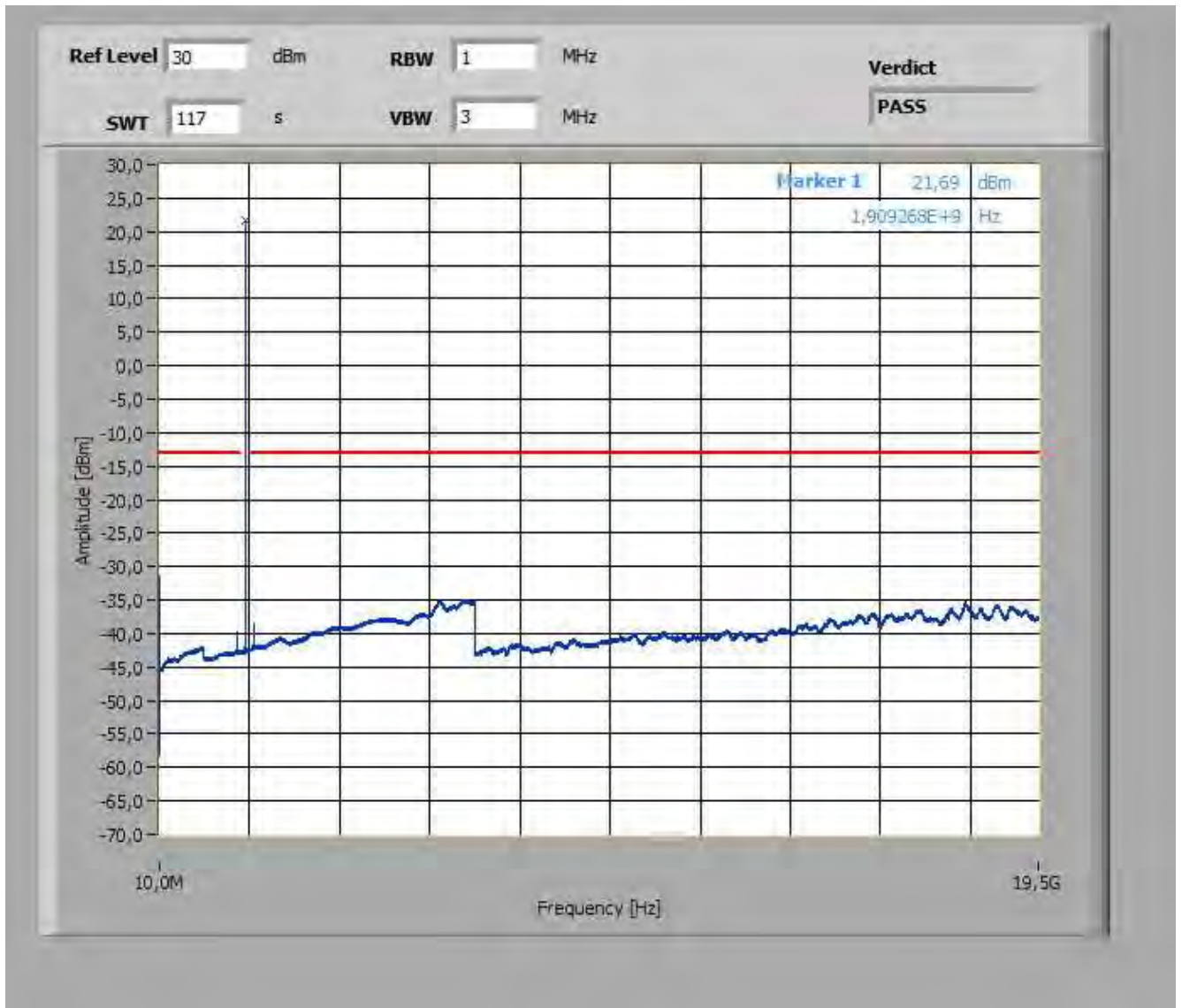

### 13.2.5 Block edge compliance

**Description:**

The spectrum at the band edges must comply with the spurious emissions limits.

**Measurement:**

Measurement parameters	
Detector:	RMS
Sweep time:	180 sec.
Video bandwidth:	100 kHz
Resolution bandwidth:	20 kHz
Span:	1 MHz steps
Trace-Mode:	Max Hold
Used equipment:	See chapter
Measurement uncertainty:	See chapter 9
Measurement procedure	FCC: § 2.1051 ISED: RSS-Gen, 6.13

**Limits:**

FCC	ISED
§ 24.238 (a) & (b)	RSS-133, 6.5
<p>(a) The power of any emission outside of the authorized operating frequency ranges must be attenuated below the transmitting power (P) by a factor of at least <b>43 + 10 log(P) dB</b>.</p> <p>(b) Compliance with these rules is based on the use of measurement instrumentation employing a resolution bandwidth of 1 MHz or greater. However, in the 1 MHz bands immediately outside and adjacent to the frequency block a resolution bandwidth of at least one percent of the emission bandwidth of the fundamental emission of the transmitter may be employed. A narrower resolution bandwidth is permitted in all cases to improve measurement accuracy provided the measured power is integrated over the full required measurement bandwidth (i.e. 1 MHz or 1 percent of emission bandwidth, as specified). The emission bandwidth is defined as the width of the signal between two points, one below the carrier center frequency and one above the carrier center frequency, outside of which all emissions are attenuated at least 26 dB below the transmitter power.</p>	<p>In the 1.0 MHz bands immediately outside and adjacent to the equipment's operating frequency block, the emission power per any 1% of the emission bandwidth shall be attenuated (in dB) below the transmitter output power P (dBW) by at least <b>43 + 10 log(P) (watts)</b>.</p> <p>After the first 1.0 MHz, the emission power in any 1 MHz bandwidth shall be attenuated (in dB) below the transmitter output power P (dBW) by at least <b>43 + 10 log(P) (watts)</b>. If the measurement is performed using 1% of the emission bandwidth, power integration over 1.0 MHz is required.</p>
<p><b>-13 dBm</b></p> <p>Correction factor according to KDB 890810 if RBW &lt; 1 % emission bandwidth:  <input checked="" type="checkbox"/> N/A here  <input type="checkbox"/> <math>10 \log (RBW1/RBW2) = X \text{ dB}</math>; whereas: <math>RBW1 = Y, RBW2 = Z</math></p>	

**Results: 1.4 MHz channel bandwidth**

**Plot 1: Lowest channel – QPSK**

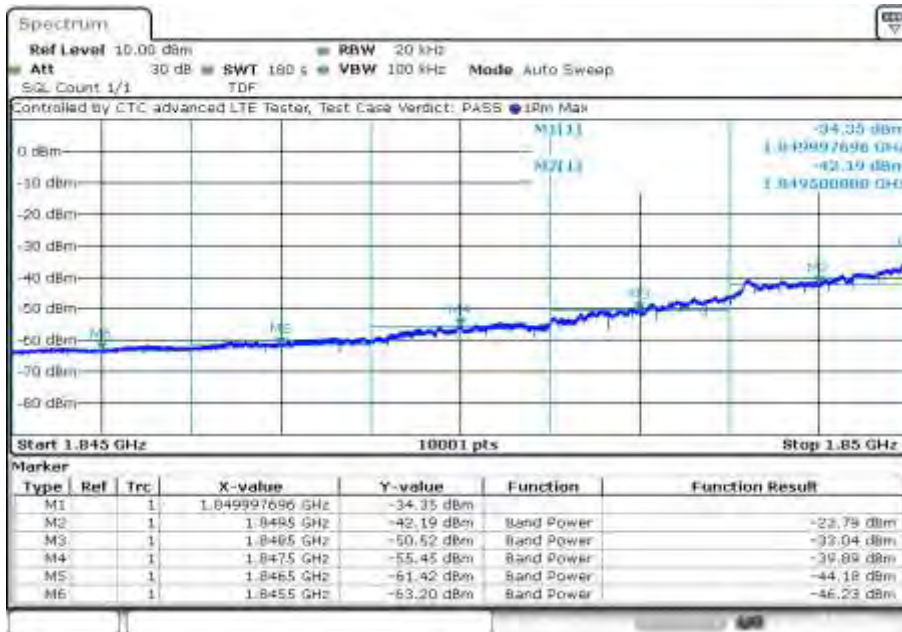

Date: 23.FEB.2022 16:24:31

**Plot 2: Highest channel – QPSK**

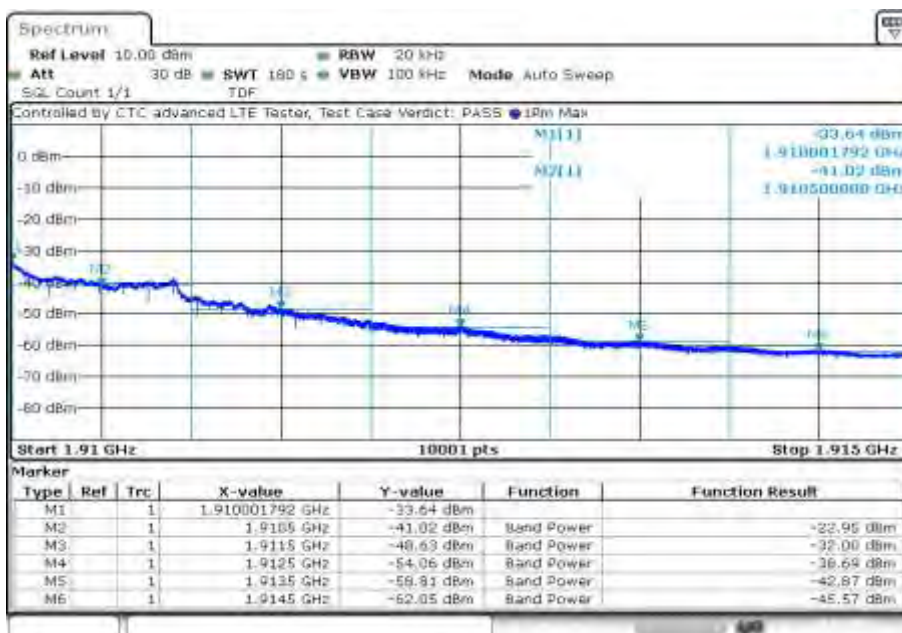

Date: 23.FEB.2022 17:24:09

**Plot 3: Lowest channel – 16-QAM**

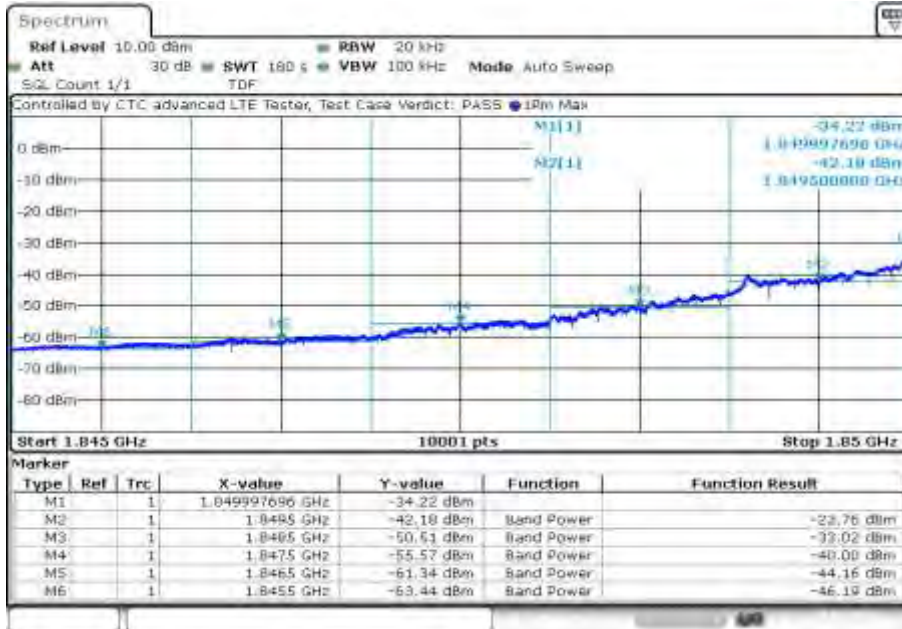

Date: 23.FEB.2022 16:40:56

**Plot 4: Highest channel – 16-QAM**

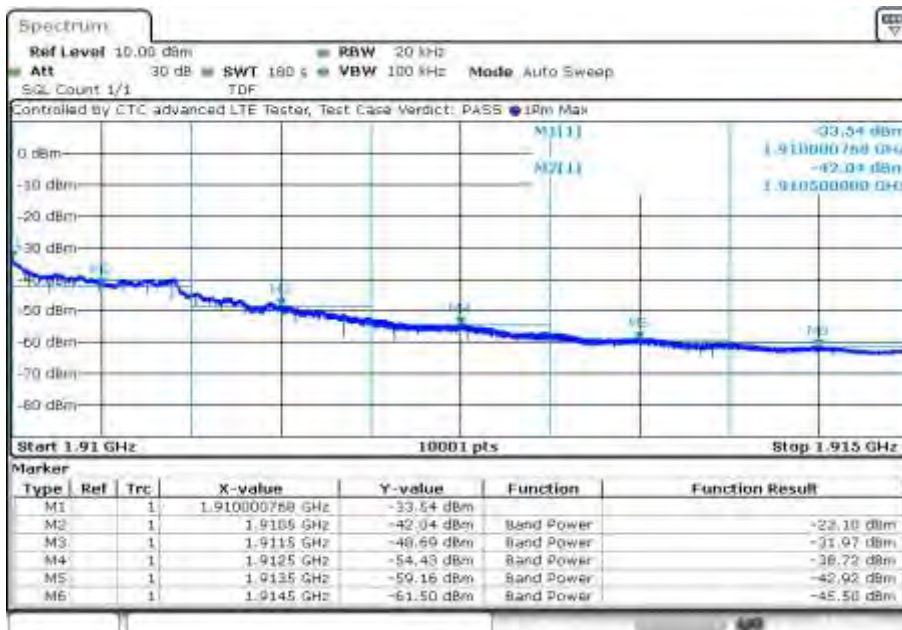

Date: 23.FEB.2022 17:40:38

### 13.2.6 Occupied bandwidth

**Description:**

Measurement of the occupied bandwidth of the transmitted signal.

**Measurement:**

Similar to conducted emissions, occupied bandwidth measurements are only provided for selected frequencies in order to reduce the amount of submitted data. Data were taken at the extreme and mid frequencies of the LTE band II frequency band. The table below lists the measured 99% power and -26dBc occupied bandwidths. Spectrum analyzer plots are included on the following pages.

Measurement parameters	
Detector:	Peak
Sweep time:	180s
Video bandwidth:	100 kHz
Resolution bandwidth:	30 kHz
Span:	2 x nominal bandwidth
Trace-Mode:	Max Hold
Used equipment:	See chapter 7.4 setup A
Measurement uncertainty:	See chapter 9
Measurement procedure	FCC: § 2.1049 ISED: RSS-Gen, 6.7

**Limits:**

FCC	ISED
§ 2.1049	RSS-Gen, 6.7
Reporting only	



**Results:**

Occupied Bandwidth – QPSK		
Frequency (MHz)	99% OBW (kHz)	-26 dBc BW (kHz)
1850.7	1091	1268
1880.0	1093	1282
1909.3	1090	1276

Occupied Bandwidth – 16-QAM		
Frequency (MHz)	99% OBW (kHz)	-26 dBc BW (kHz)
1850.7	1091	1267
1880.0	1093	1282
1909.3	1091	1279

**Plots: QPSK**

**Plot 1: low channel (99% - OBW)**

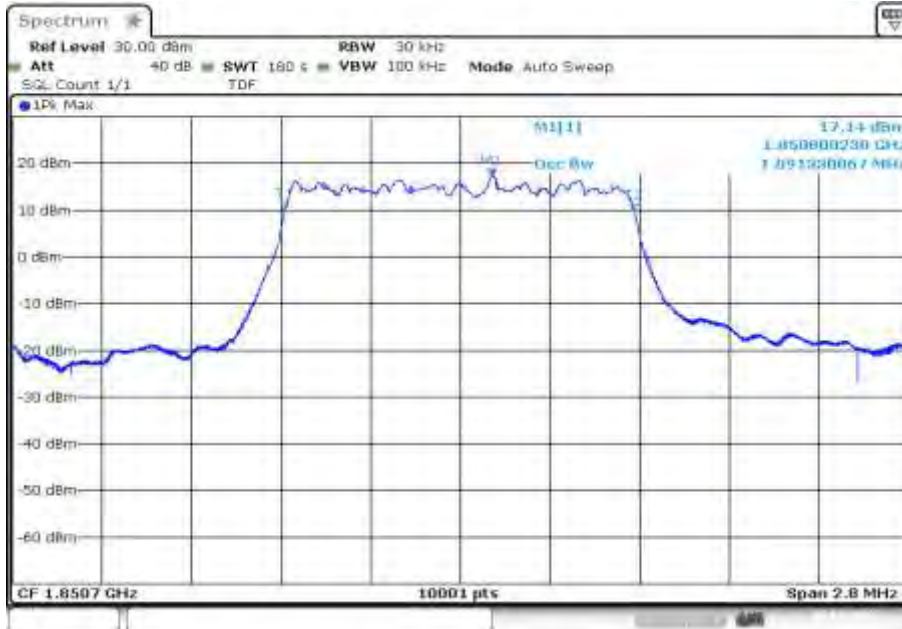

Date: 23.FEB.2022 16:27:40

**Plot 2: low channel (-26 dBc BW)**

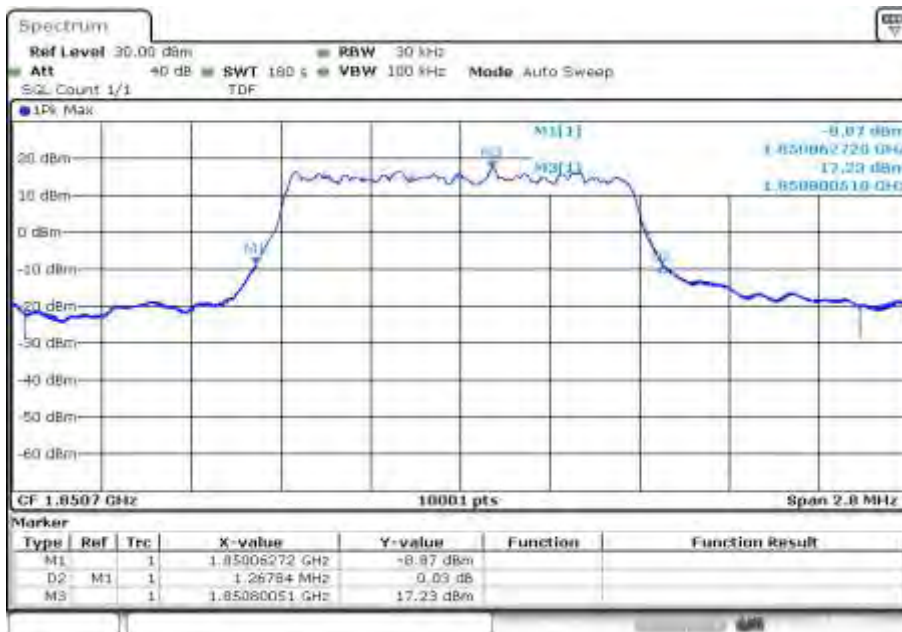

Date: 23.FEB.2022 16:30:48

**Plot 3: mid channel (99% - OBW)**

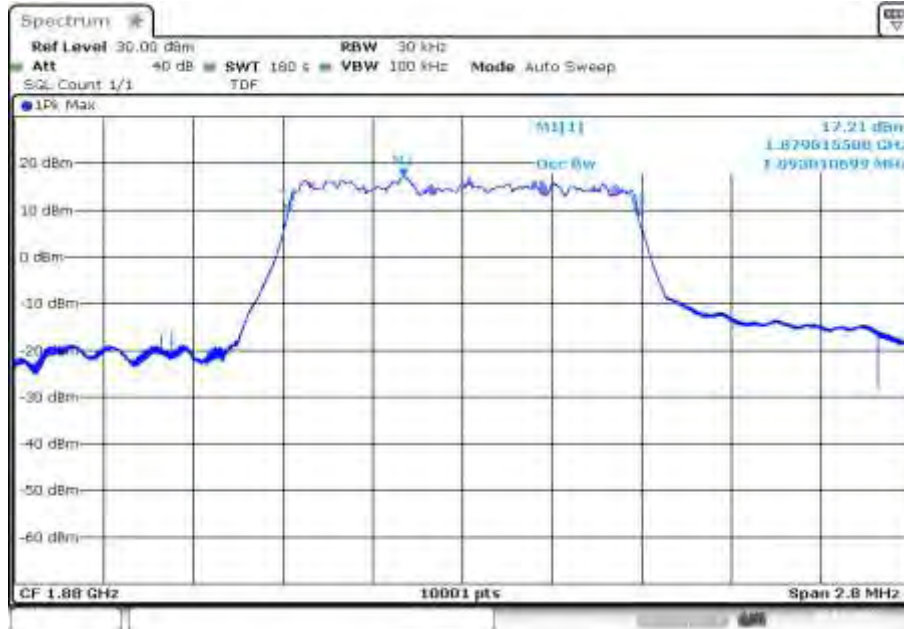

Date: 23.FEB.2022 16:57:28

**Plot 4: mid channel (-26 dBc BW)**

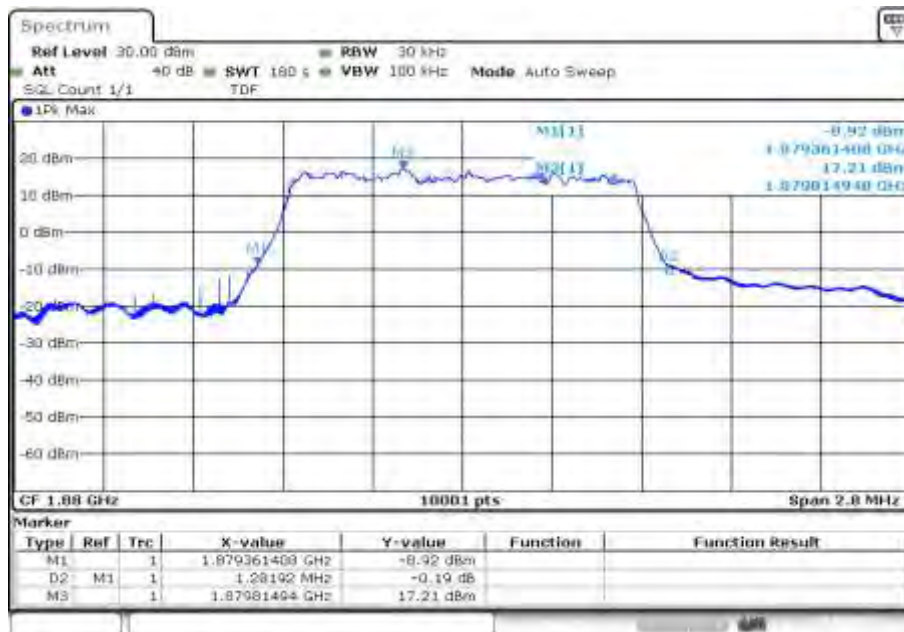

Date: 23.FEB.2022 17:00:37

**Plot 5: high channel (99% - OBW)**

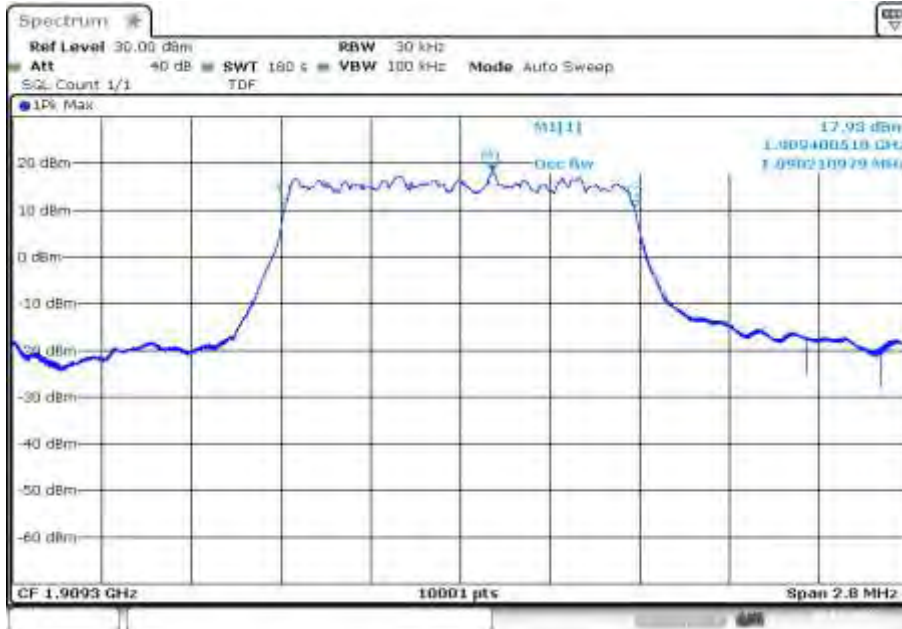

Date: 23.FEB.2022 17:27:19

**Plot 6: high channel (-26 dBc BW)**

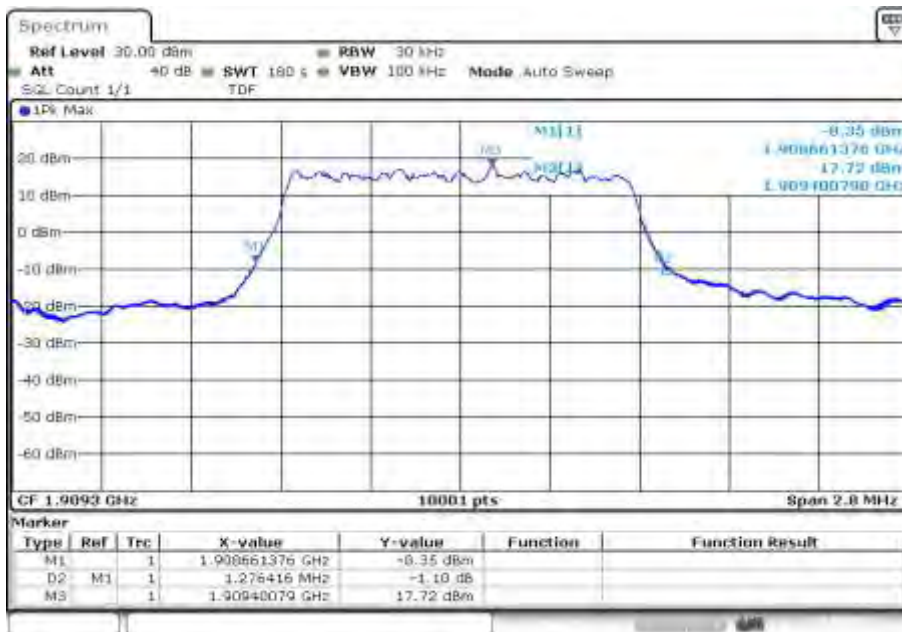

Date: 23.FEB.2022 17:30:29

**Plots: 16-QAM**

**Plot 1: low channel (99% - OBW)**

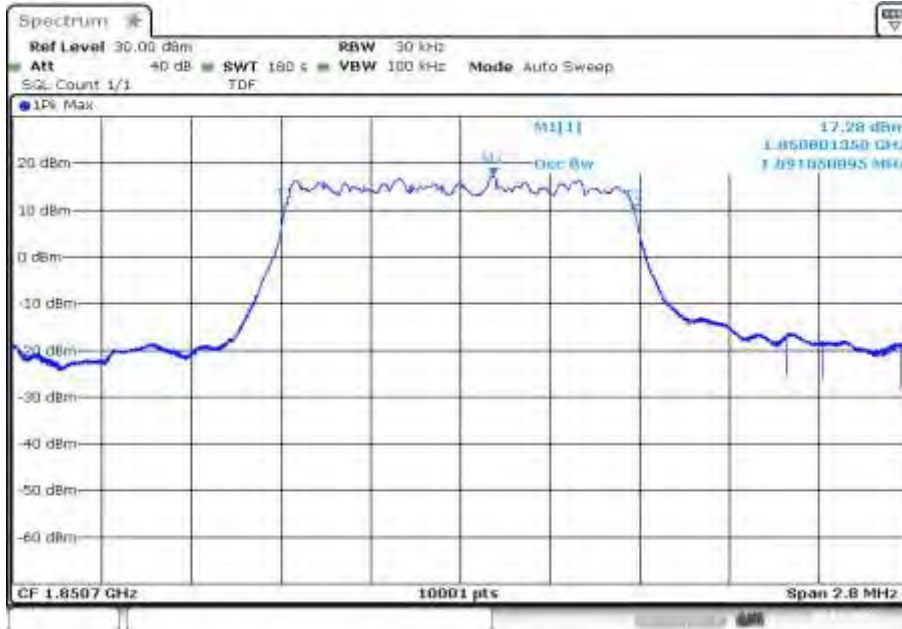

Date: 23.FEB.2022 16:44:05

**Plot 2: low channel (-26 dBc BW)**

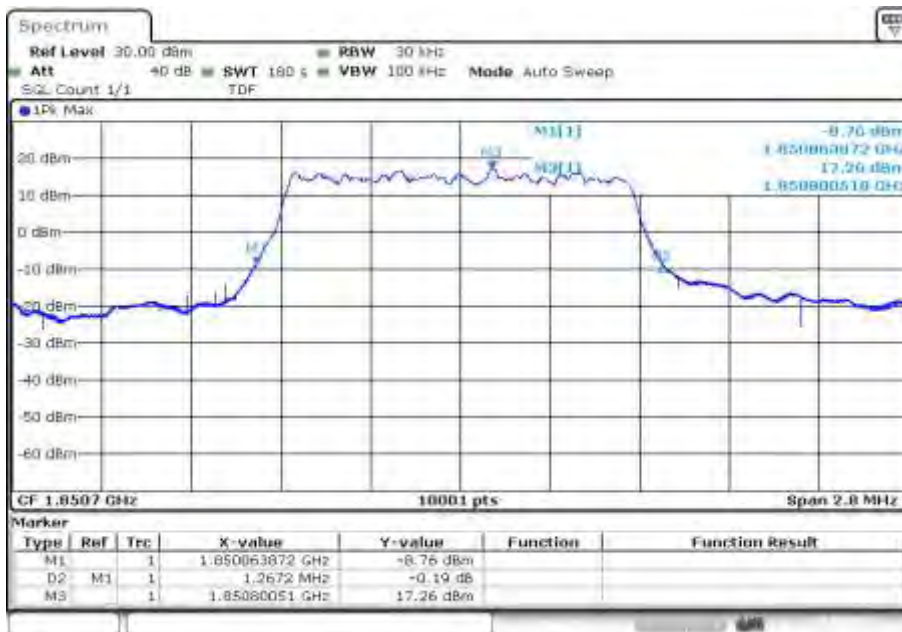

Date: 23.FEB.2022 16:47:13

**Plot 3: mid channel (99% - OBW)**

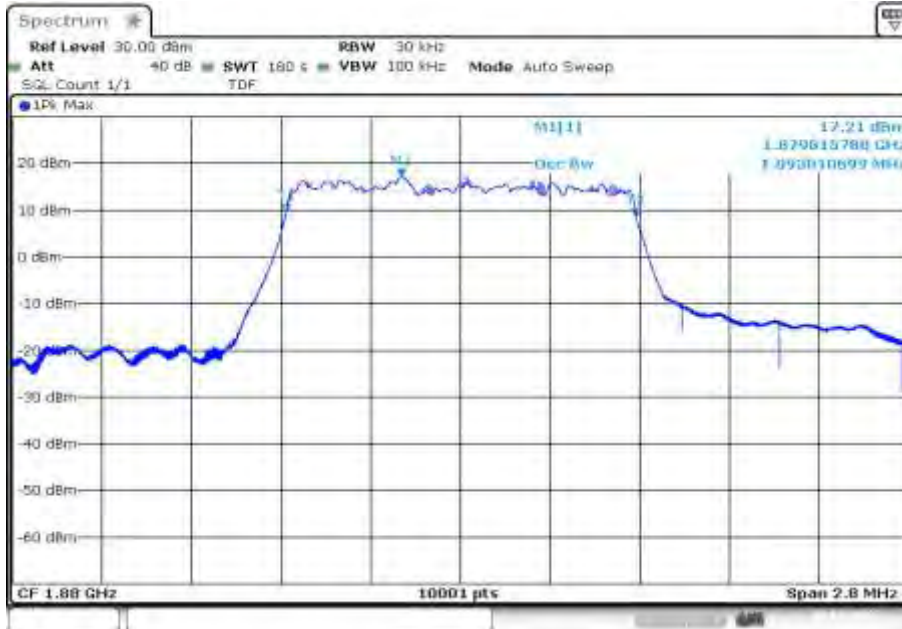

Date: 23.FEB.2022 17:10:46

**Plot 4: mid channel (-26 dBc BW)**

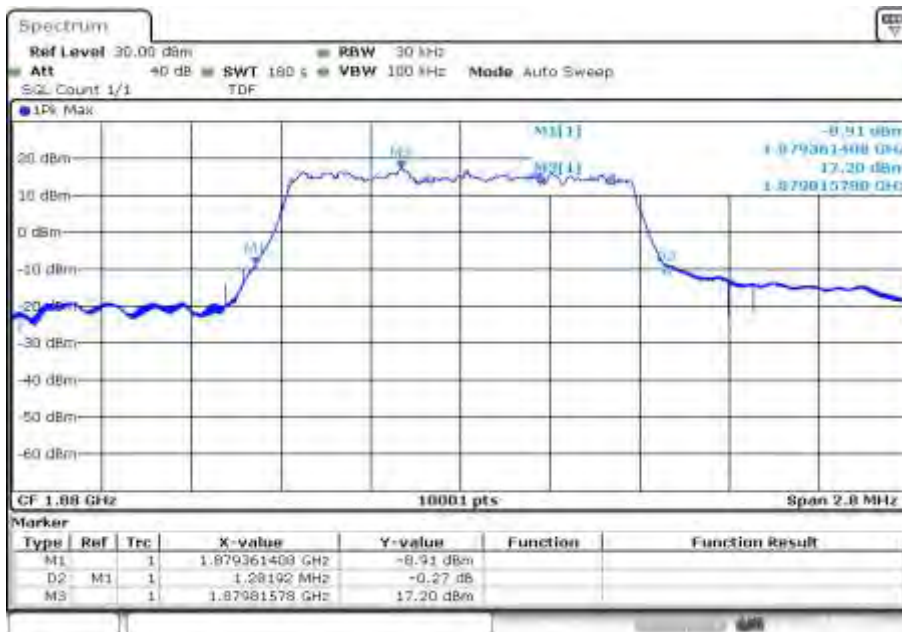

Date: 23.FEB.2022 17:13:56

**Plot 5: high channel (99% - OBW)**

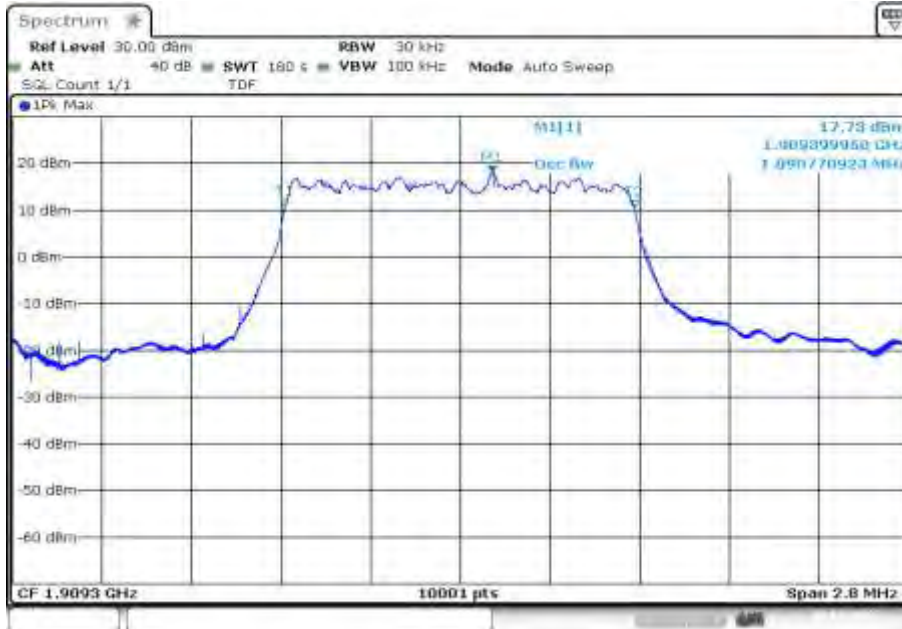

Date: 23.FEB.2022 17:43:47

**Plot 6: high channel (-26 dBc BW)**



Date: 23.FEB.2022 17:46:57

## 14 Summary of measurement results

<input checked="" type="checkbox"/>	No deviations from the technical specifications were ascertained
<input type="checkbox"/>	There were deviations from the technical specifications ascertained
<input type="checkbox"/>	This test report is only a partial test report. The content and verdict of the performed test cases are listed below.

TC identifier	Description	verdict	date	Remark
RF-Testing	FCC: CFR Part 2 & Part 27 ISED: RSS-Gen, Issue 5 RSS-130, Issue 2 (LTE Bands 12, 13) RSS-139, Issue 3 (LTE Band 4)	See table!	2022-04-14	-/-

### 14.1 Part 27/RSS-139: LTE band 4

Test Case	temperature conditions	power source voltages	C	NC	NA	NP	Remark
RF Output Power	Nominal	Nominal	<input checked="" type="checkbox"/>	<input type="checkbox"/>	<input type="checkbox"/>	<input type="checkbox"/>	-/-
Frequency Stability	Extreme	Extreme	<input checked="" type="checkbox"/>	<input type="checkbox"/>	<input type="checkbox"/>	<input type="checkbox"/>	-/-
Spurious Emissions Radiated	Nominal	Nominal	<input checked="" type="checkbox"/>	<input type="checkbox"/>	<input type="checkbox"/>	<input type="checkbox"/>	-/-
Spurious Emissions Conducted	Nominal	Nominal	<input checked="" type="checkbox"/>	<input type="checkbox"/>	<input type="checkbox"/>	<input type="checkbox"/>	-/-
Block Edge Compliance	Nominal	Nominal	<input checked="" type="checkbox"/>	<input type="checkbox"/>	<input type="checkbox"/>	<input type="checkbox"/>	-/-
Occupied Bandwidth	Nominal	Nominal	<input checked="" type="checkbox"/>	<input type="checkbox"/>	<input type="checkbox"/>	<input type="checkbox"/>	-/-

**Note:** C – Compliant; NC – Not compliant; NA = Not applicable; NP = Not performed



**14.2 Part 27/RSS-130: LTE band 12**

Test Case	temperature conditions	power source voltages	C	NC	NA	NP	Remark
RF Output Power	Nominal	Nominal	<input checked="" type="checkbox"/>	<input type="checkbox"/>	<input type="checkbox"/>	<input type="checkbox"/>	-/-
Frequency Stability	Extreme	Extreme	<input checked="" type="checkbox"/>	<input type="checkbox"/>	<input type="checkbox"/>	<input type="checkbox"/>	-/-
Spurious Emissions Radiated	Nominal	Nominal	<input checked="" type="checkbox"/>	<input type="checkbox"/>	<input type="checkbox"/>	<input type="checkbox"/>	-/-
Spurious Emissions Conducted	Nominal	Nominal	<input checked="" type="checkbox"/>	<input type="checkbox"/>	<input type="checkbox"/>	<input type="checkbox"/>	-/-
Block Edge Compliance	Nominal	Nominal	<input checked="" type="checkbox"/>	<input type="checkbox"/>	<input type="checkbox"/>	<input type="checkbox"/>	-/-
Occupied Bandwidth	Nominal	Nominal	<input checked="" type="checkbox"/>	<input type="checkbox"/>	<input type="checkbox"/>	<input type="checkbox"/>	-/-

**Note:** C – Compliant; NC – Not compliant; NA = Not applicable; NP = Not performed

**14.3 Part 27/RSS-130: LTE band 13**

Test Case	temperature conditions	power source voltages	C	NC	NA	NP	Remark
RF Output Power	Nominal	Nominal	<input checked="" type="checkbox"/>	<input type="checkbox"/>	<input type="checkbox"/>	<input type="checkbox"/>	-/-
Frequency Stability	Extreme	Extreme	<input checked="" type="checkbox"/>	<input type="checkbox"/>	<input type="checkbox"/>	<input type="checkbox"/>	-/-
Spurious Emissions Radiated	Nominal	Nominal	<input checked="" type="checkbox"/>	<input type="checkbox"/>	<input type="checkbox"/>	<input type="checkbox"/>	-/-
Spurious Emissions Conducted	Nominal	Nominal	<input checked="" type="checkbox"/>	<input type="checkbox"/>	<input type="checkbox"/>	<input type="checkbox"/>	-/-
Block Edge Compliance	Nominal	Nominal	<input checked="" type="checkbox"/>	<input type="checkbox"/>	<input type="checkbox"/>	<input type="checkbox"/>	-/-
Occupied Bandwidth	Nominal	Nominal	<input checked="" type="checkbox"/>	<input type="checkbox"/>	<input type="checkbox"/>	<input type="checkbox"/>	-/-

**Note:** C – Compliant; NC – Not compliant; NA = Not applicable; NP = Not performed

## 15 RF measurements

### 15.1 Description of test setup

For the spurious measurements we use the substitution method according TIA/EIA 603.

### 15.2 LTE technologies supported by EUT

#### Channel bandwidth

	Band 4	Band 12	Band 13	-/-
[MHz]				-/-
1.4	<input checked="" type="checkbox"/>	<input checked="" type="checkbox"/>	<input type="checkbox"/>	
3	<input checked="" type="checkbox"/>	<input checked="" type="checkbox"/>	<input type="checkbox"/>	
5	<input checked="" type="checkbox"/>	<input checked="" type="checkbox"/>	<input checked="" type="checkbox"/>	
10	<input checked="" type="checkbox"/>	<input checked="" type="checkbox"/>	<input checked="" type="checkbox"/>	
15	<input checked="" type="checkbox"/>	<input type="checkbox"/>	<input type="checkbox"/>	
20	<input checked="" type="checkbox"/>	<input type="checkbox"/>	<input type="checkbox"/>	

## 15.3 Results LTE band 4

The EUT was set to transmit the maximum power.

### 15.3.1 RF output power

#### Description:

This paragraph contains average power, peak output power and EIRP measurements for the mobile station. In all cases, the peak output power is within the required mask (this mask is specified in the JTC standards, TIA PN3389 Vol. 1 Chap 7, and is no FCC requirement).

#### Measurement:

The mobile was set up for the maximum output power with pseudo random data modulation.

To determine the Peak-To-Average Power Ratio (PAPR) the measurement was performed with the Power Complementary Cumulative Distribution Function (CCDF).

Measurement parameters	
Detector:	Sample
AQT:	See plot
Resolution bandwidth:	1 MHz
Used equipment:	See chapter 7.4 setup A
Measurement uncertainty:	See chapter 9
Measurement procedure	FCC: § 2.1046 ISED: RSS-Gen, 6.12

#### Limits:

FCC	ISED
§ 27.50(d)(4) & (5)	RSS-139, 6.5
(4) Fixed, mobile, and portable (hand-held) stations operating in the 1710-1755 MHz band and mobile and portable stations operating in the 1695-1710 MHz and 1755-1780 MHz bands are limited to 1 watt EIRP. (5) In measuring transmissions in this band using an average power technique, the peak-to-average ratio (PAR) of the transmission may not exceed 13 dB.	The equivalent isotropically radiated power (e.i.r.p.) for mobile and portable transmitters shall not exceed one watt. In addition, the peak to average power ratio (PAPR) of the equipment shall not exceed 13 dB for more than 0.1% of the time, using a signal that corresponds to the highest PAPR during periods of continuous transmission.
Power: <b>33 dBm EIRP</b> PAPR: <b>13 dB</b>	

**Results:**

Output Power (conducted)						
Bandwidth (MHz)	Frequency (MHz)	Resource block allocation	Average Output Power (dBm) QPSK	Peak to Average Ratio (dB)	Average Output Power (dBm) 16-QAM	Peak to Average Ratio (dB)
1.4	19957 / 1710.7	1 RB low	18.6	5.9	17.0	7.1
		1 RB high	18.4	6.0	17.1	7.1
		100% RB	16.5	6.8	16.5	7.4
	20175 / 1732.5	1 RB low	18.7	6.0	17.1	7.2
		1 RB high	18.5	6.1	17.0	7.2
		100% RB	16.5	6.8	16.6	7.5
	20393 / 1754.3	1 RB low	18.4	6.1	17.3	7.1
		1 RB high	18.2	6.2	17.1	7.2
		100% RB	16.4	7.0	16.4	7.6
3	19965 / 1711.5	1 RB low	18.5	5.9	17.0	7.1
		1 RB high	18.3	6.0	17.0	7.1
		100% RB	16.4	6.8	16.4	7.4
	20175 / 1732.5	1 RB low	18.7	5.9	16.3	7.9
		1 RB high	17.7	6.8	16.2	8.0
		100% RB	16.5	6.8	16.6	7.4
	20385 / 1753.5	1 RB low	18.5	6.1	17.3	7.2
		1 RB high	18.3	6.1	16.4	8.0
		100% RB	16.4	7.0	16.4	7.6
5	19975 / 1712.5	1 RB low	20.5	4.1	20.6	4.5
		1 RB high	20.4	4.1	20.4	4.6
		100% RB	19.1	4.9	18.2	5.9
	20175 / 1732.5	1 RB low	20.5	4.1	20.5	4.6
		1 RB high	20.2	4.3	20.1	4.8
		100% RB	19.3	4.9	18.3	5.9
	20375 / 1752.5	1 RB low	20.3	4.3	20.5	4.7
		1 RB high	20.3	4.3	20.3	4.8
		100% RB	19.1	5.1	18.2	6.0

10	20000 / 1715.0	1 RB low	20.5	4.1	20.3	4.6
		1 RB high	20.3	4.2	20.1	4.7
		100% RB	19.0	4.9	19.1	5.4
	20175 / 1732.5	1 RB low	20.3	4.2	20.3	4.6
		1 RB high	20.2	4.2	19.9	4.8
		100% RB	19.1	4.9	19.1	5.5
	20350 / 1750.0	1 RB low	20.4	4.3	20.5	4.7
		1 RB high	20.2	4.3	20.3	4.8
		100% RB	19.0	5.0	19.1	5.7
15	20025 / 1717.5	1 RB low	20.2	4.1	20.4	4.5
		1 RB high	20.0	4.3	20.0	4.8
		100% RB	20.0	4.5	20.2	4.8
	20175 / 1732.5	1 RB low	20.3	4.1	20.2	4.6
		1 RB high	20.2	4.2	20.1	4.7
		100% RB	20.1	4.5	20.1	4.9
	20325 / 1747.5	1 RB low	20.2	4.2	20.3	4.6
		1 RB high	20.1	4.3	20.0	4.8
		100% RB	19.9	4.6	20.1	5.0
20	20050 / 1720.0	1 RB low	19.8	4.1	20.0	4.6
		1 RB high	19.9	4.2	20.0	4.6
		100% RB	19.8	4.4	19.9	4.9
	20175 / 1732.5	1 RB low	20.1	4.1	20.0	4.6
		1 RB high	19.8	4.2	19.8	4.7
		100% RB	19.8	4.4	19.9	4.9
	20300 / 1745.0	1 RB low	20.1	4.2	20.3	4.6
		1 RB high	19.9	4.3	19.9	4.8
		100% RB	19.8	4.6	19.9	5.0

The radiated output power is measured in the mode with the highest conducted output power.

Output Power (EIRP)			
Bandwidth (MHz)	Frequency (MHz)	Average Output Power (dBm)	Average Output Power (dBm)
		QPSK	16-QAM
1.4	1710.7	21.0	19.4
	1732.5	22.5	20.9
	1754.3	21.3	20.2
3	1711.5	20.9	19.4
	1732.5	22.5	20.4
	1753.5	21.4	20.2
5	1712.5	22.9	23.0
	1732.5	24.3	24.3
	1752.5	23.2	23.4
10	1715.0	22.9	22.7
	1732.5	24.1	24.1
	1750.0	23.3	23.4
15	1717.5	22.6	22.8
	1732.5	24.1	24.0
	1747.5	23.1	23.2
20	1720.0	22.3	22.4
	1732.5	23.9	23.8
	1745.0	23.0	23.2

### 15.3.2 Frequency stability

**Description:**

In order to measure the carrier frequency under the condition of AFC lock, it is necessary to make measurements with the mobile station in a “call mode”. This is accomplished with the use of a R&S CMW500 DIGITAL RADIOCOMMUNICATION TESTER.

1. Measure the carrier frequency at room temperature.
2. Subject the mobile station to overnight soak at -30 C.
3. With the mobile station, powered with  $V_{nom}$ , connected to the CMW500 and in a simulated call on channel 1412 (center channel), measure the carrier frequency. These measurements should be made within two minutes of powering up the mobile station, to prevent significant self warming.
4. Repeat the above measurements at 10°C increments from -30°C to +50°C. Allow at least 1.5 hours at each temperature, unpowered, before making measurements.
5. Re-measure carrier frequency at room temperature with  $V_{nom}$ . Vary supply voltage from  $V_{min}$  to  $V_{max}$ , in 0.1 Volt steps re-measuring carrier frequency at each voltage. Pause at  $V_{nom}$  for 1.5 hours unpowered, to allow any self heating to stabilize, before continuing.
6. At all temperature levels hold the temperature to +/- 0.5°C during the measurement procedure.

This measurement was performed with the highest channel bandwidth supported from the EUT on the middle channel

**Measurement:**

Measurement parameters	
Detector:	Measured with CMW500
Sweep time:	
Video bandwidth:	
Resolution bandwidth:	
Span:	
Trace-Mode:	
Used equipment:	See chapter
Measurement uncertainty:	See chapter 9
Measurement procedure	FCC: § 2.1055 ISED: RSS-Gen, 6.11

**Limits:**

FCC	ISED
§ 27.54	RSS-139, 6.4
The frequency stability shall be sufficient to ensure that the fundamental emissions stay within the authorized bands of operation.	The frequency stability shall be sufficient to ensure that the occupied bandwidth stays within the operating frequency block when tested to the temperature and supply voltage variations specified in RSS-Gen.

**Results:****FREQ ERROR versus VOLTAGE**

Voltage (V)	Frequency Error (Hz)	Frequency Error (ppm)
3.2	-31	-0.0179
3.6	-31	-0.0179
4.0	-31	-0.0179

**FREQ ERROR versus TEMPERATURE**

Temperature (°C)	Frequency Error (Hz)	Frequency Error (ppm)
-30	36	0.0208
-20	24	0.0139
-10	16	0.0092
± 0	-30	-0.0173
10	-18	-0.0104
20	-31	-0.0179
30	-62	-0.0358
40	-24	-0.0139
50	-56	-0.0232



### 15.3.3 Spurious emissions radiated

#### Description:

The following steps outline the procedure used to measure the radiated emissions from the mobile station. The site is constructed in accordance with ANSI C63.4:2014 requirements and is recognized by the FCC to be in compliance for a 3 and a 10 meter site. The spectrum was scanned from 30 MHz to the 10th harmonic of the highest frequency generated within the equipment, which is the transmitted carrier that can be as high as 1750 MHz. Measurement made up to 18 GHz. The resolution bandwidth is set as outlined in Part 27.53. The spectrum was scanned with the mobile station transmitting at carrier frequencies that pertain to low, mid and high channels of the LTE band 4.

#### Measurement:

Measurement parameters	
Detector:	Peak
Sweep time:	2 sec.
Resolution bandwidth:	1 MHz
Video bandwidth:	3 MHz
Span:	100 MHz Steps
Trace mode:	Max Hold
Used equipment:	See chapter
Measurement uncertainty:	See chapter 9
Measurement procedure	FCC: § 2.1053 ISED: RSS-Gen, 6.13

**Limits:**

FCC	ISED
§ 27.53(h)(1) & (3)	RSS-139, 6.6
<p>(1) Except as otherwise specified below, for operations in the 1695-1710 MHz, 1710-1755 MHz, 1755-1780 MHz, 1915-1920 MHz, 1995-2000 MHz, 2000-2020 MHz, 2110-2155 MHz, 2155-2180 MHz, and 2180-2200 bands, the power of any emission outside a licensee's frequency block shall be attenuated below the transmitter power (P) in watts by at least <math>43 + 10 \log_{10}(P)</math> dB.</p> <p>(3) Compliance with this provision is based on the use of measurement instrumentation employing a resolution bandwidth of 1 megahertz or greater. However, in the 1 megahertz bands immediately outside and adjacent to the licensee's frequency block, a resolution bandwidth of at least one percent of the emission bandwidth of the fundamental emission of the transmitter may be employed. The emission bandwidth is defined as the width of the signal between two points, one below the carrier center frequency and one above the carrier center frequency, outside of which all emissions are attenuated at least 26 dB below the transmitter power.</p>	<p>i. In the first 1.0 MHz bands immediately outside and adjacent to the equipment's smallest operating frequency block, which can contain the equipment's occupied bandwidth, the emission power per any 1% of the emission bandwidth shall be attenuated below the transmitter output power P (in dBW) by at least <math>43 + 10 \log_{10}(P)</math> (watts) dB.</p> <p>ii. After the first 1.0 MHz outside the equipment's smallest operating frequency block, which can contain the equipment's occupied bandwidth, the emission power in any 1 MHz bandwidth shall be attenuated below the transmitter output power P (in dBW) by at least <math>43 + 10 \log_{10}(P)</math> (watts) dB.</p>
<b>-13 dBm</b>	

**Results:**

**QPSK**

SPURIOUS EMISSION LEVEL					
LOWEST CHANNEL		MIDDLE CHANNEL		HIGHEST CHANNEL	
Spurious emissions	Level [dBm]	Spurious emissions	Level [dBm]	Spurious emissions	Level [dBm]
All detected spurious emissions are more than 20 dB below the limit.		All detected spurious emissions are more than 20 dB below the limit.		All detected spurious emissions are more than 20 dB below the limit.	

**16-QAM**

SPURIOUS EMISSION LEVEL					
LOWEST CHANNEL		MIDDLE CHANNEL		HIGHEST CHANNEL	
Spurious emissions	Level [dBm]	Spurious emissions	Level [dBm]	Spurious emissions	Level [dBm]
All detected spurious emissions are more than 20 dB below the limit.		All detected spurious emissions are more than 20 dB below the limit.		All detected spurious emissions are more than 20 dB below the limit.	

**QPSK**

**Plot 1:** Middle channel, up to 30 MHz

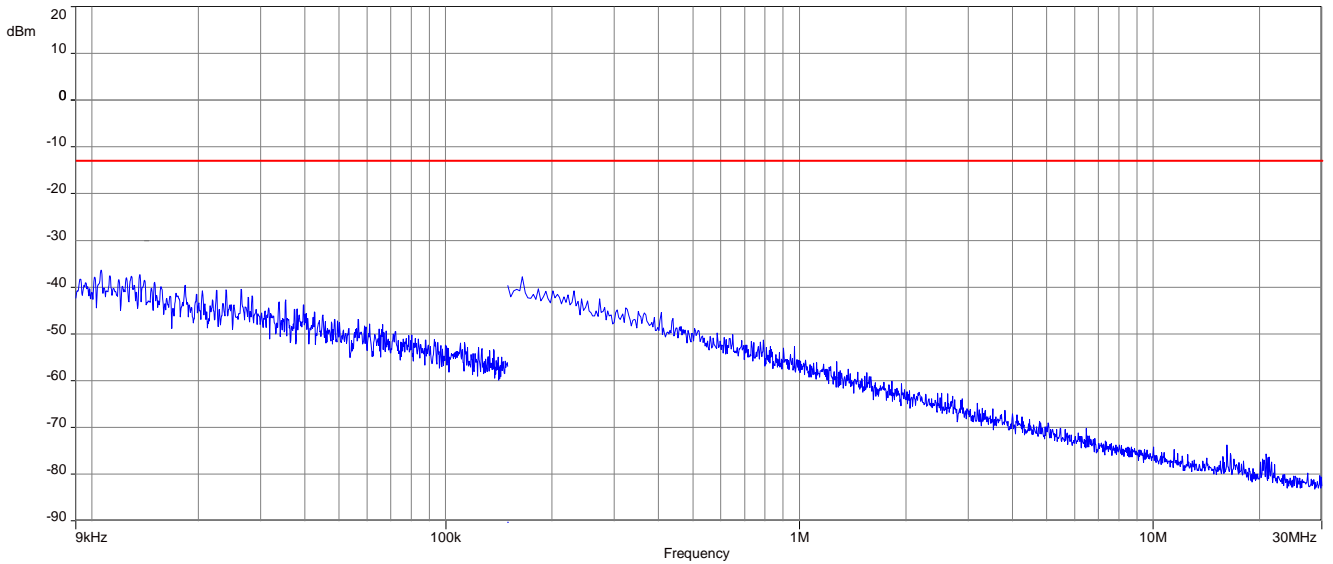

**Plot 2:** Middle channel, 30 MHz to 1GHz

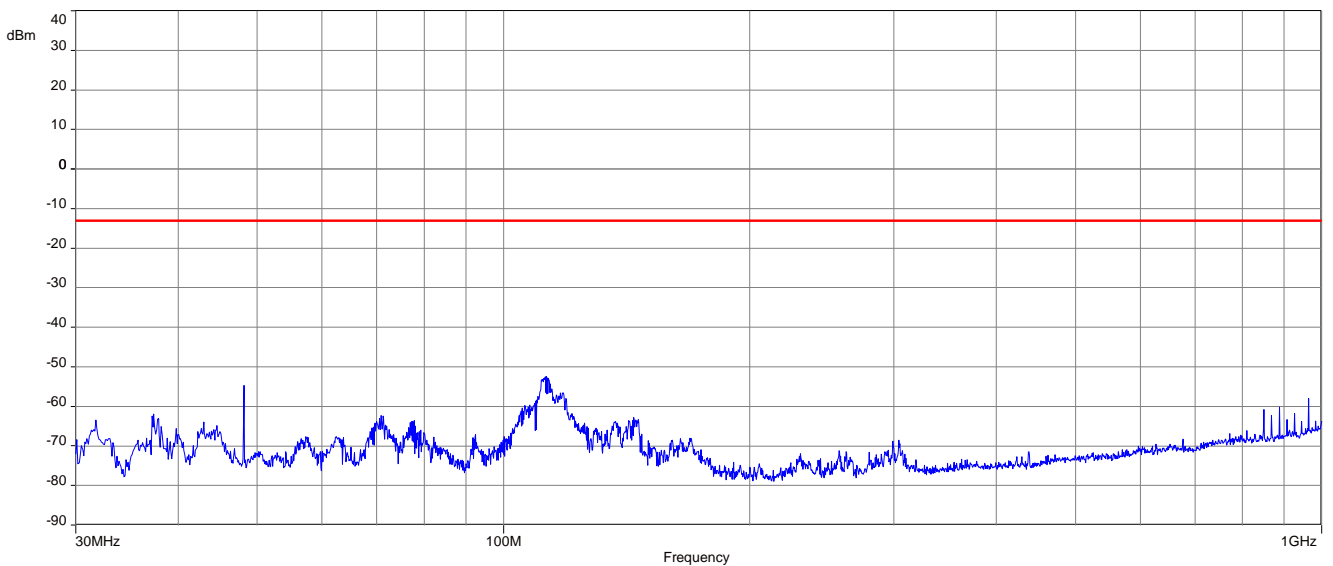

**Plot 3:** Middle channel, 1 GHz to 18GHz

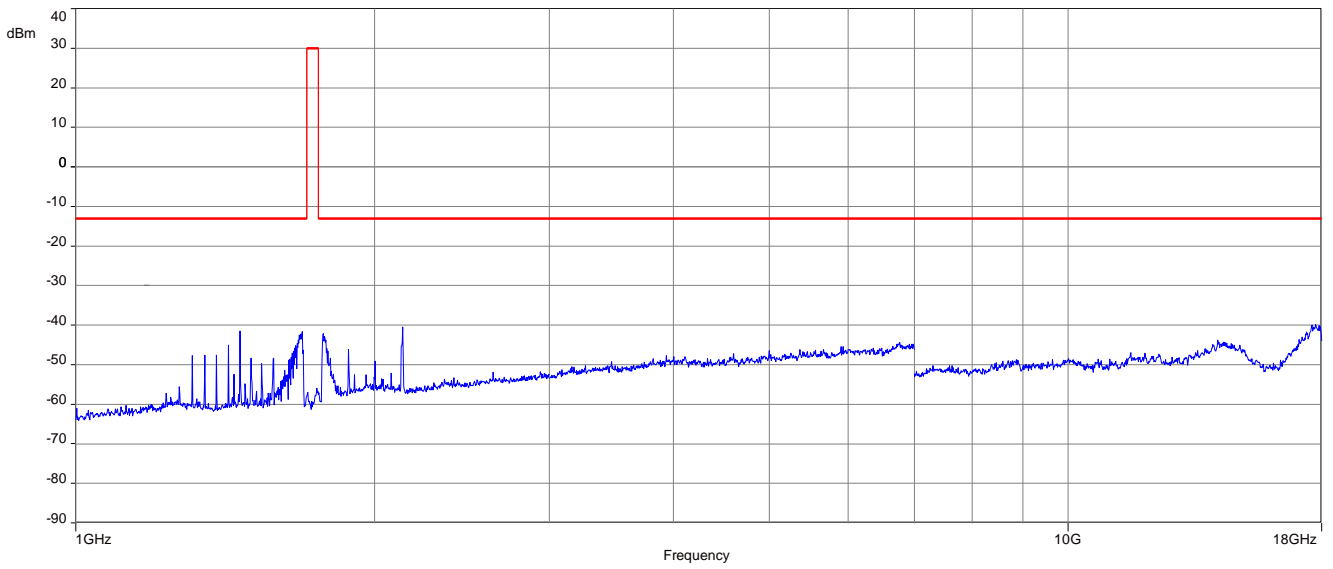

### 16-QAM

**Plot 1:** Middle channel, up to 30 MHz

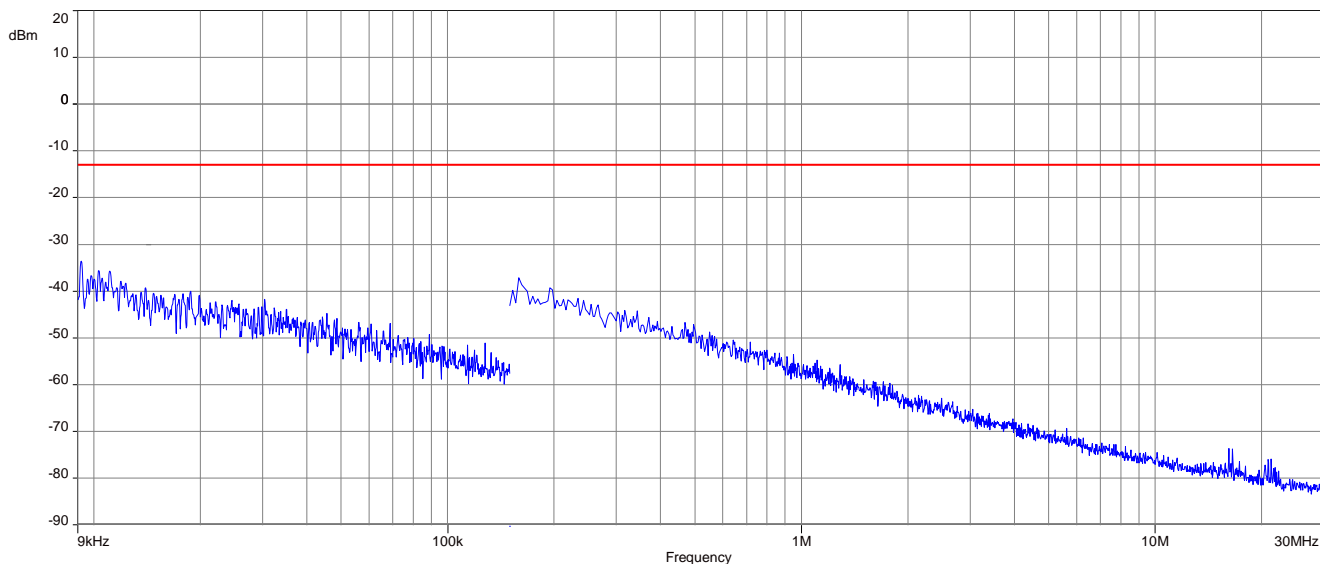

**Plot 2:** Middle channel, 30 MHz to 1 GHz

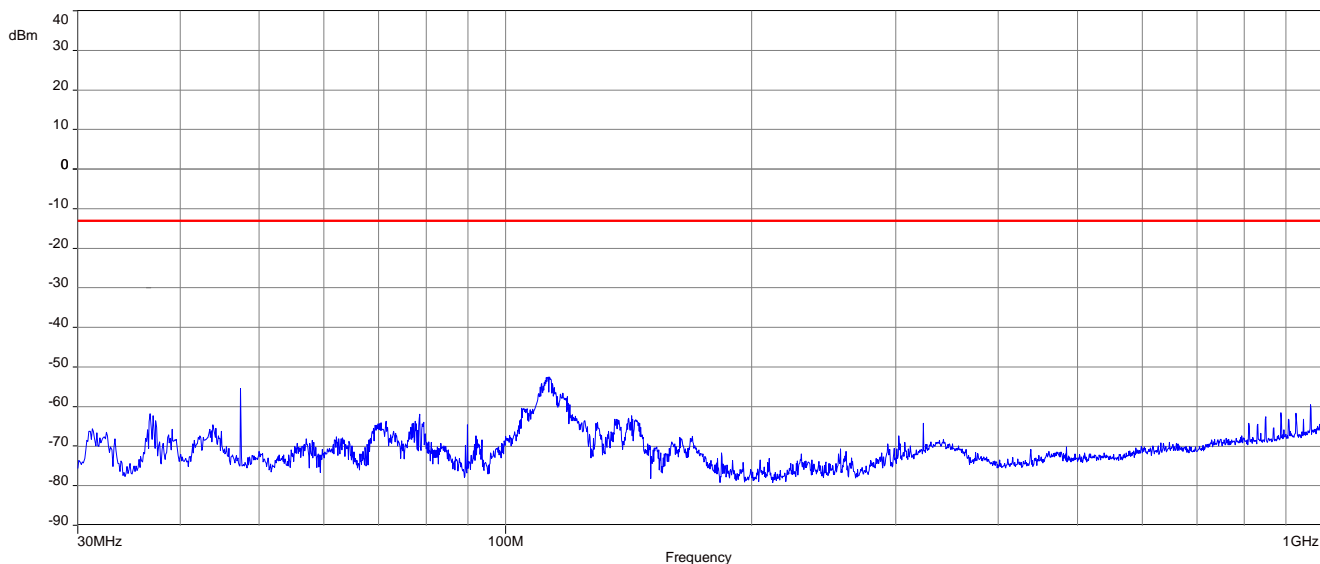

**Plot 3:** Middle channel, 1 GHz to 18 GHz

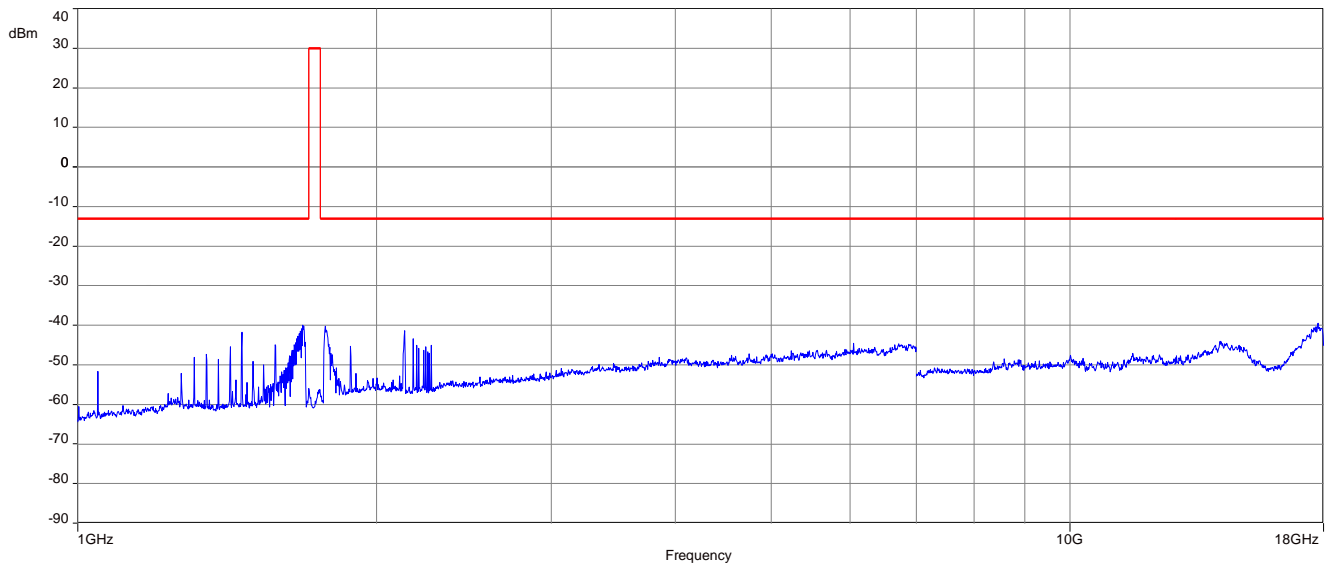

### 15.3.4 Spurious emissions conducted

#### **Description:**

The following steps outline the procedure used to measure the conducted emissions from the mobile station.

1. Determine frequency range for measurements: From § 2.1057 & RSS-Gen, 6.13.2 the spectrum should be investigated from the lowest radio frequency generated in the equipment up to at least the 10th harmonic of the carrier frequency.
2. Determine mobile station transmits frequencies: below outlines the band edge frequencies pertinent to conducted emissions testing.

For the measurement the lowest, middle and highest channel bandwidth was used. If spurious were found the other bandwidths were measured, too.

#### **Measurement:**

Measurement parameters	
Detector:	Peak
Sweep time:	Auto
Video bandwidth:	300 kHz
Resolution bandwidth:	100 kHz
Span:	10 MHz – 18 GHz
Trace-Mode:	Max Hold
Used equipment:	See chapter
Measurement uncertainty:	See chapter 9
Measurement procedure	FCC: § 2.1051 ISED: RSS-Gen, 6.13



**Limits:**

FCC	ISED
§ 27.53(h)(1) & (3)	RSS-139, 6.6
<p>(1) Except as otherwise specified below, for operations in the 1695-1710 MHz, 1710-1755 MHz, 1755-1780 MHz, 1915-1920 MHz, 1995-2000 MHz, 2000-2020 MHz, 2110-2155 MHz, 2155-2180 MHz, and 2180-2200 bands, the power of any emission outside a licensee’s frequency block shall be attenuated below the transmitter power (P) in watts by at least <math>43 + 10 \log_{10}(P)</math> dB.</p> <p>(3) Compliance with this provision is based on the use of measurement instrumentation employing a resolution bandwidth of 1 megahertz or greater. However, in the 1 megahertz bands immediately outside and adjacent to the licensee’s frequency block, a resolution bandwidth of at least one percent of the emission bandwidth of the fundamental emission of the transmitter may be employed. The emission bandwidth is defined as the width of the signal between two points, one below the carrier center frequency and one above the carrier center frequency, outside of which all emissions are attenuated at least 26 dB below the transmitter power.</p>	<p>i. In the first 1.0 MHz bands immediately outside and adjacent to the equipment’s smallest operating frequency block, which can contain the equipment’s occupied bandwidth, the emission power per any 1% of the emission bandwidth shall be attenuated below the transmitter output power P (in dBW) by at least <math>43 + 10 \log_{10}(P)</math> (watts) dB.</p> <p>ii. After the first 1.0 MHz outside the equipment’s smallest operating frequency block, which can contain the equipment’s occupied bandwidth, the emission power in any 1 MHz bandwidth shall be attenuated below the transmitter output power P (in dBW) by at least <math>43 + 10 \log_{10}(P)</math> (watts) dB.</p>
<b>-13 dBm</b>	

**Results:** for 1.4 MHz channel bandwidth

**QPSK**

SPURIOUS EMISSION LEVEL					
LOWEST CHANNEL		MIDDLE CHANNEL		HIGHEST CHANNEL	
Spurious emissions	Level [dBm]	Spurious emissions	Level [dBm]	Spurious emissions	Level [dBm]
3421.4	-	3465.0	-	3508.6	-
5132.1	-	5197.5	-	5262.9	-
6842.8	-	6930.0	-	7017.2	-
8553.5	-	8662.5	-	8771.5	-
10264.2	-	10395.0	-	10525.8	-
11974.9	-	12127.5	-	12280.1	-
13685.6	-	13860.0	-	14034.4	-
15396.3	-	15592.5	-	15788.7	-
17107.0	-	17325.0	-	17543.0	-

**16-QAM**

SPURIOUS EMISSION LEVEL					
LOWEST CHANNEL		MIDDLE CHANNEL		HIGHEST CHANNEL	
Spurious emissions	Level [dBm]	Spurious emissions	Level [dBm]	Spurious emissions	Level [dBm]
3421.4	-	3465.0	-	3508.6	-
5132.1	-	5197.5	-	5262.9	-
6842.8	-	6930.0	-	7017.2	-
8553.5	-	8662.5	-	8771.5	-
10264.2	-	10395.0	-	10525.8	-
11974.9	-	12127.5	-	12280.1	-
13685.6	-	13860.0	-	14034.4	-
15396.3	-	15592.5	-	15788.7	-
17107.0	-	17325.0	-	17543.0	-

**Plots for 1.4 MHz channel bandwidth, QPSK**

**Plot 1:** Lowest channel, 10 MHz to 18 GHz

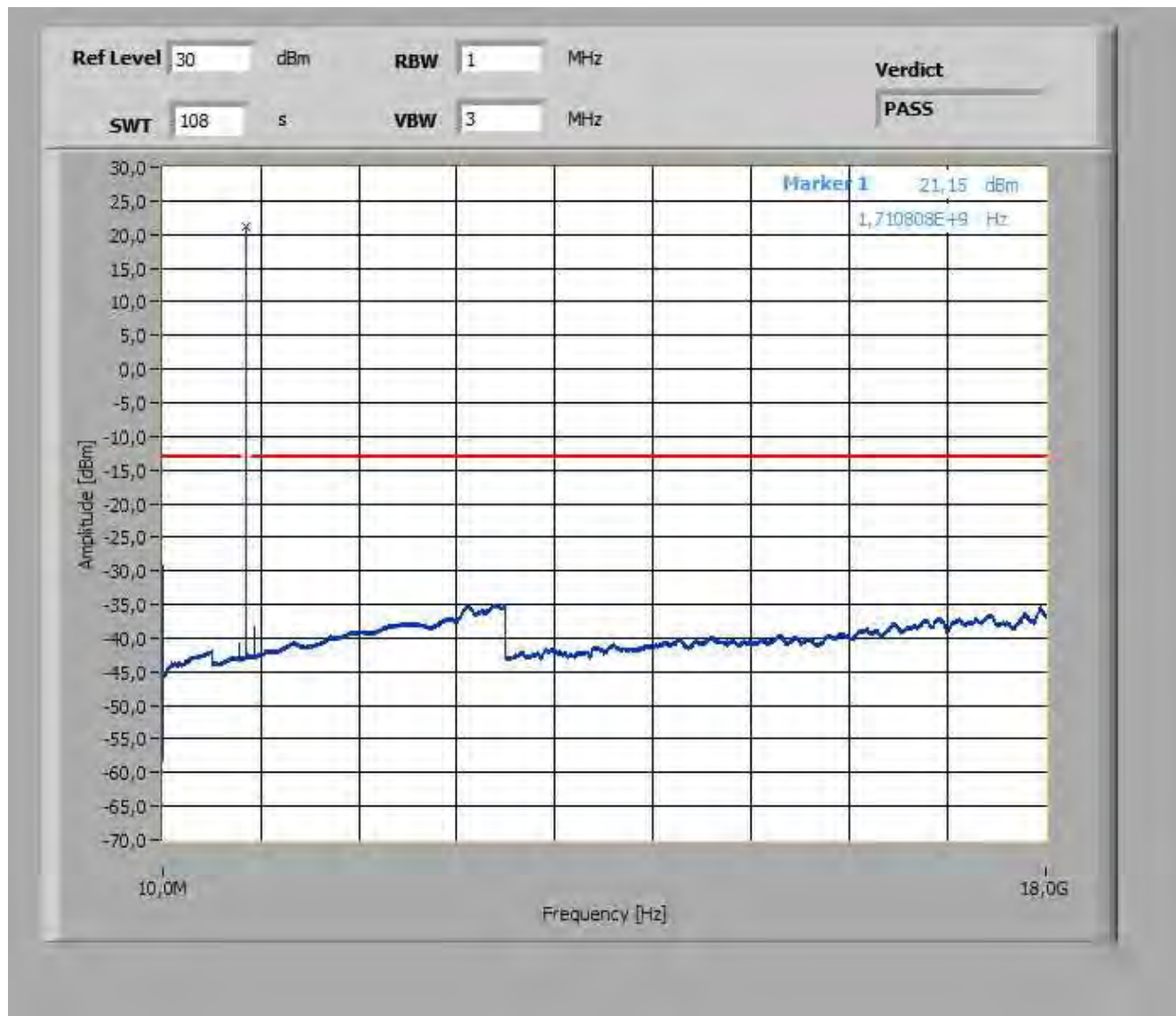

**Plot 2:** Middle channel, 10 MHz to 18 GHz

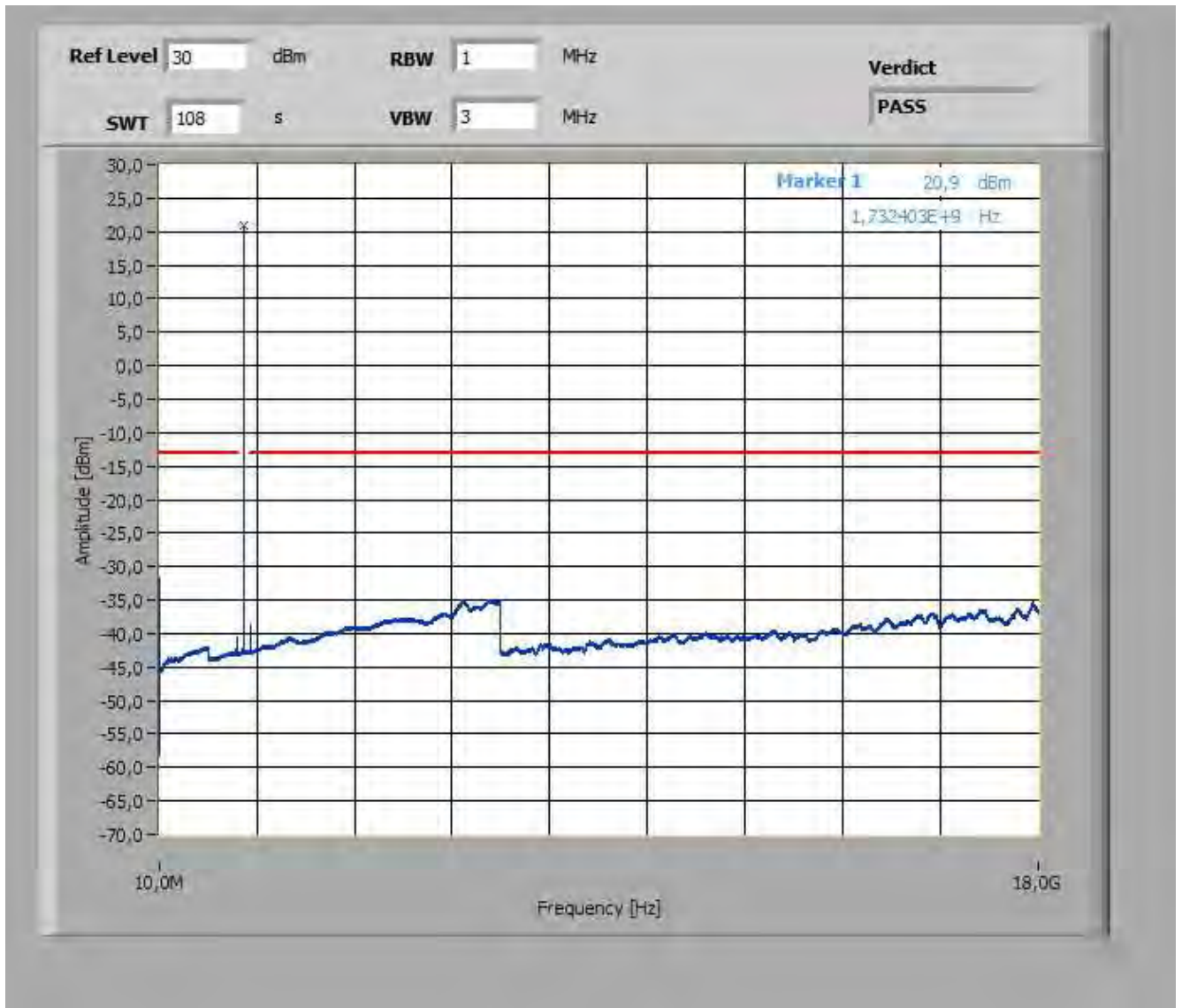

**Plot 3:** Highest channel, 10 MHz to 18 GHz

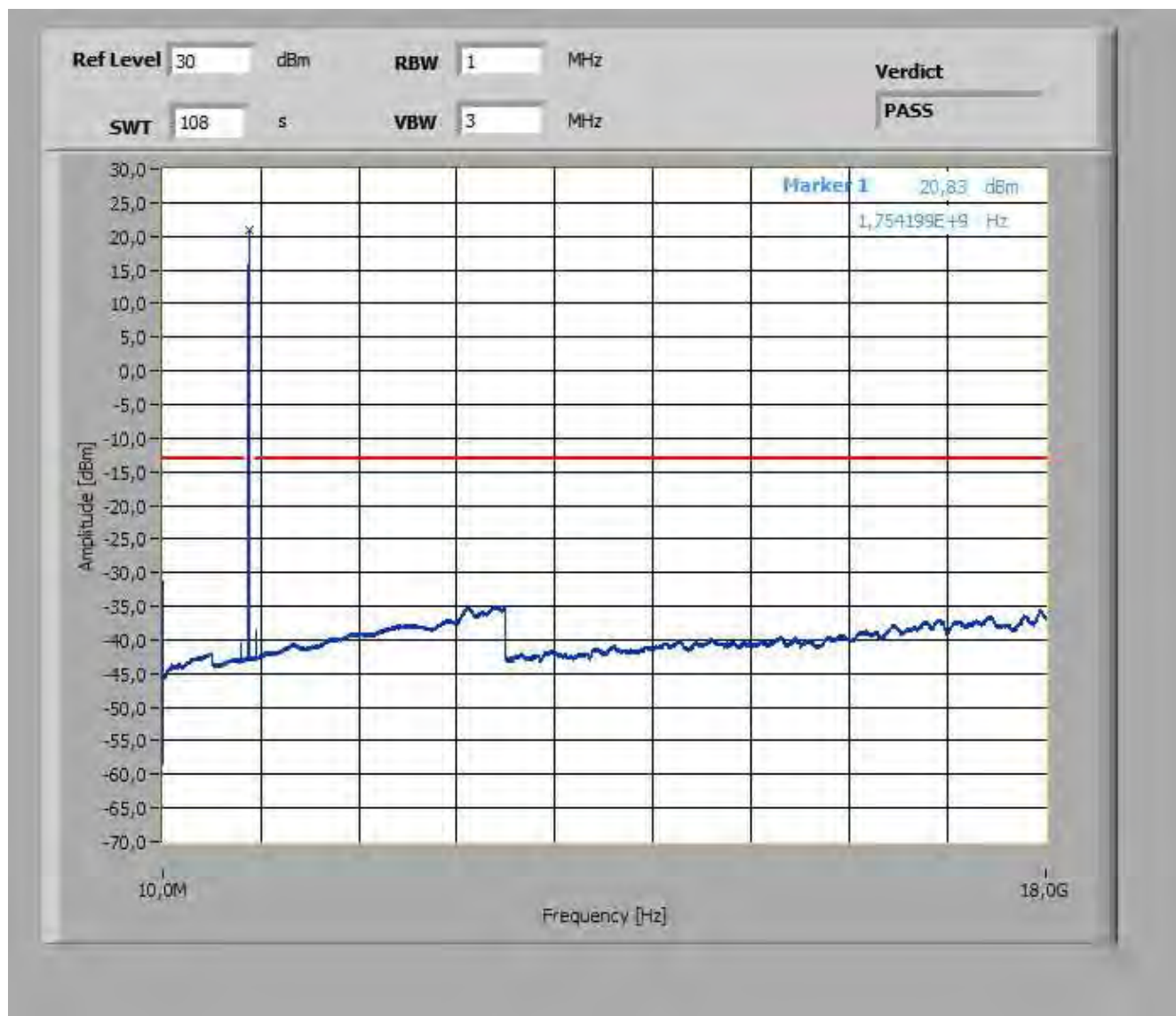

**Plots for 1.4 MHz channel bandwidth, 16-QAM**

**Plot 1:** Lowest channel, 10 MHz to 18 GHz

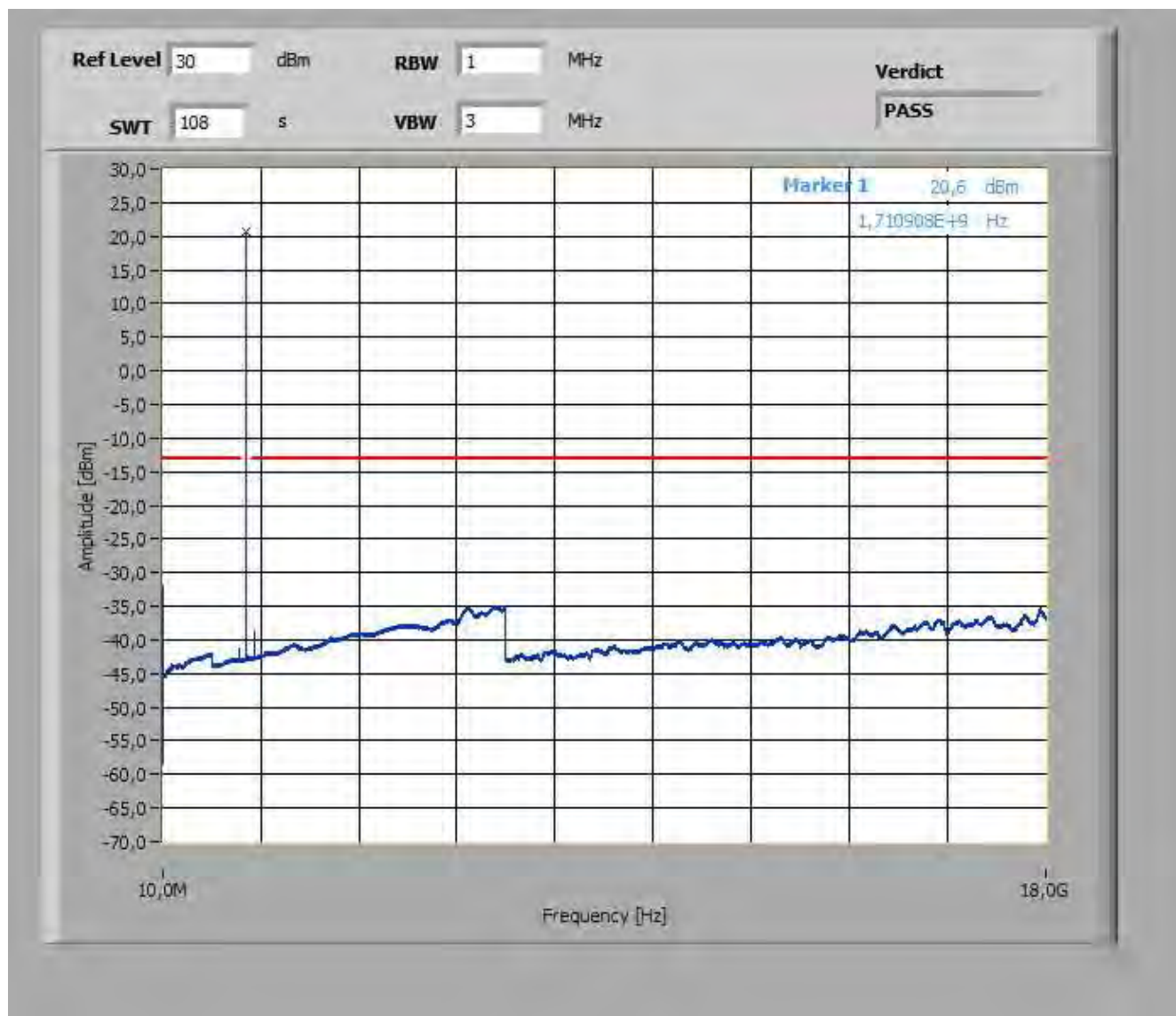

**Plot 2:** Middle channel, 10 MHz to 18 GHz

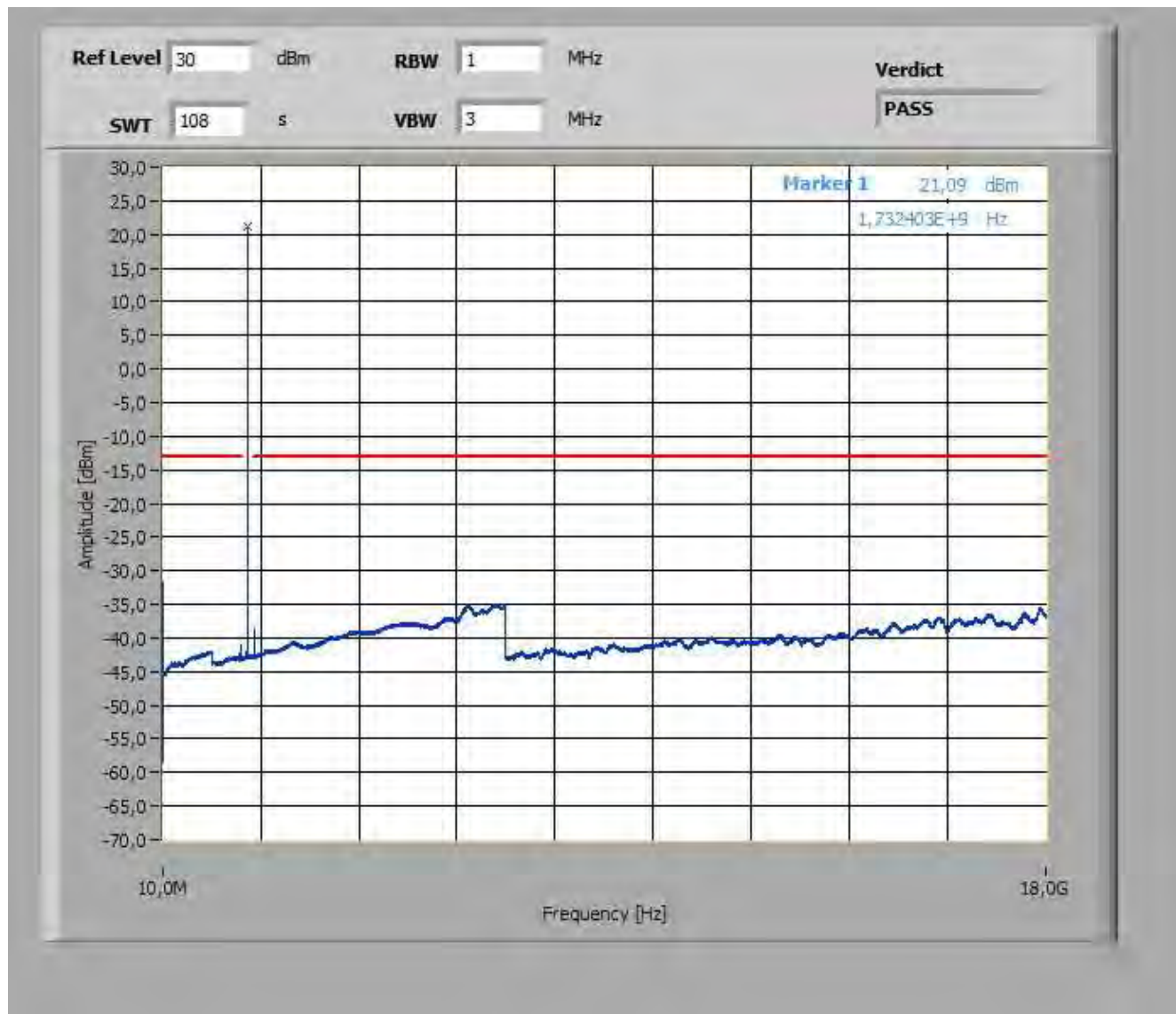

**Plot 3:** Highest channel, 10 MHz to 18 GHz

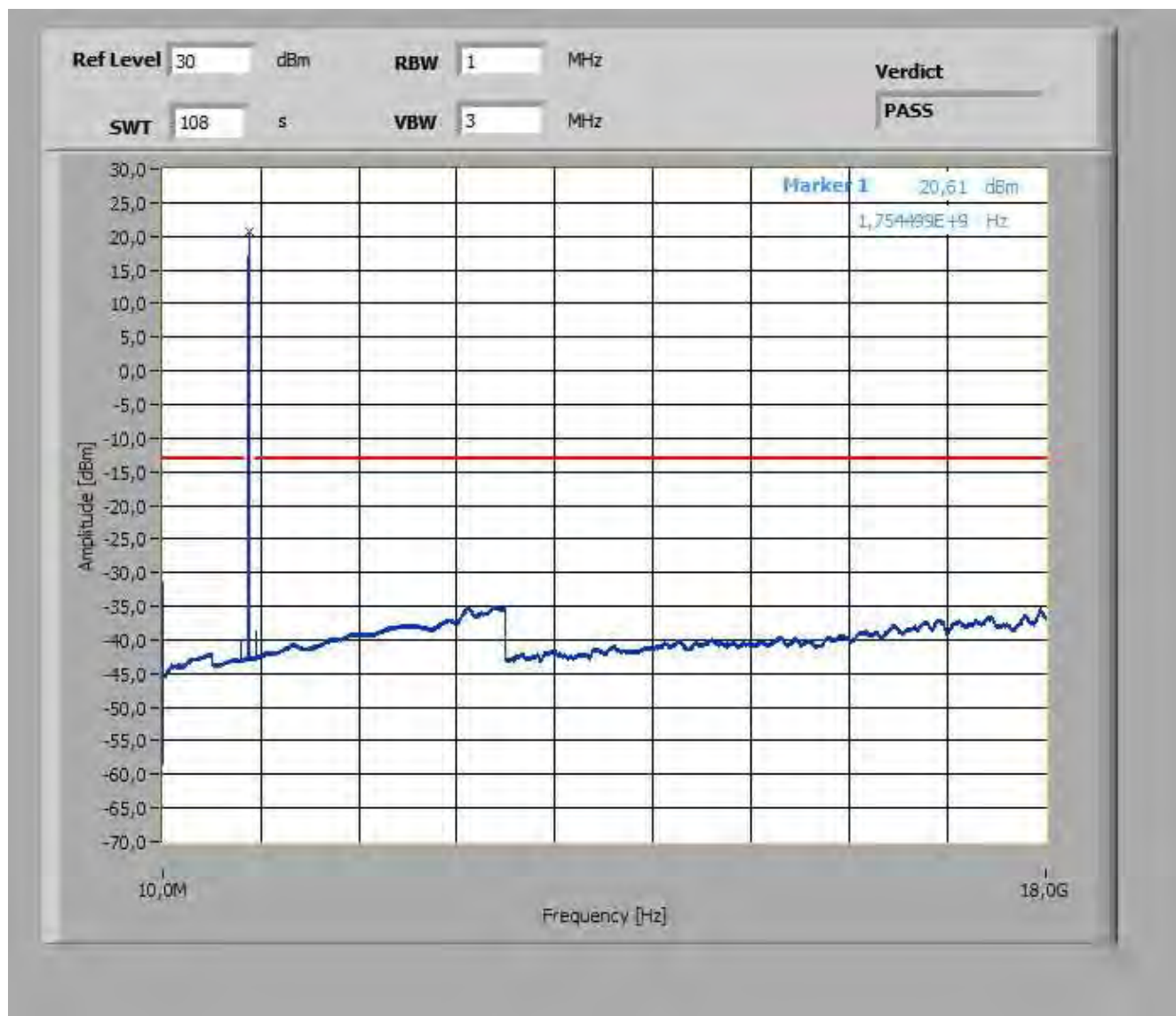



### 15.3.5 Block edge compliance

#### **Description:**

The spectrum at the band edges must comply with the spurious emissions limits.

For the measurement the lowest, middle and highest channel bandwidth was used. If spurious were found the other bandwidths were measured, too.

#### **Measurement:**

Measurement parameters	
Detector:	RMS
Sweep time:	180s
Video bandwidth:	100 kHz
Resolution bandwidth:	20 kHz
Span:	1 MHz
Trace-Mode:	Max Hold
Used equipment:	See chapter 7.2 setup A
Measurement uncertainty:	See chapter 9
Measurement procedure	FCC: § 2.1051 ISED: RSS-Gen, 6.13

**Limits:**

FCC	ISED
§ 27.53(h)(1) & (3)	RSS-139, 6.6
<p>(1) Except as otherwise specified below, for operations in the 1695-1710 MHz, 1710-1755 MHz, 1755-1780 MHz, 1915-1920 MHz, 1995-2000 MHz, 2000-2020 MHz, 2110-2155 MHz, 2155-2180 MHz, and 2180-2200 bands, the power of any emission outside a licensee's frequency block shall be attenuated below the transmitter power (P) in watts by at least <math>43 + 10 \log_{10}(P)</math> dB.</p> <p>(3) Compliance with this provision is based on the use of measurement instrumentation employing a resolution bandwidth of 1 megahertz or greater. However, in the 1 megahertz bands immediately outside and adjacent to the licensee's frequency block, a resolution bandwidth of at least one percent of the emission bandwidth of the fundamental emission of the transmitter may be employed. The emission bandwidth is defined as the width of the signal between two points, one below the carrier center frequency and one above the carrier center frequency, outside of which all emissions are attenuated at least 26 dB below the transmitter power.</p>	<p>i. In the first 1.0 MHz bands immediately outside and adjacent to the equipment's smallest operating frequency block, which can contain the equipment's occupied bandwidth, the emission power per any 1% of the emission bandwidth shall be attenuated below the transmitter output power P (in dBW) by at least <math>43 + 10 \log_{10}(P)</math> (watts) dB.</p> <p>ii. After the first 1.0 MHz outside the equipment's smallest operating frequency block, which can contain the equipment's occupied bandwidth, the emission power in any 1 MHz bandwidth shall be attenuated below the transmitter output power P (in dBW) by at least <math>43 + 10 \log_{10}(P)</math> (watts) dB.</p>
<p><b>-13 dBm</b></p> <p>Correction factor according to KDB 890810 if RBW &lt; 1 % emission bandwidth:  <input checked="" type="checkbox"/> N/A here  <input type="checkbox"/> <math>10 \log(RBW1/RBW2) = X</math> dB; whereas: RBW1 = Y, RBW2 = Z</p>	

**Results: 1.4 MHz channel bandwidth**

**Plot 1: Lowest channel, QPSK modulation**

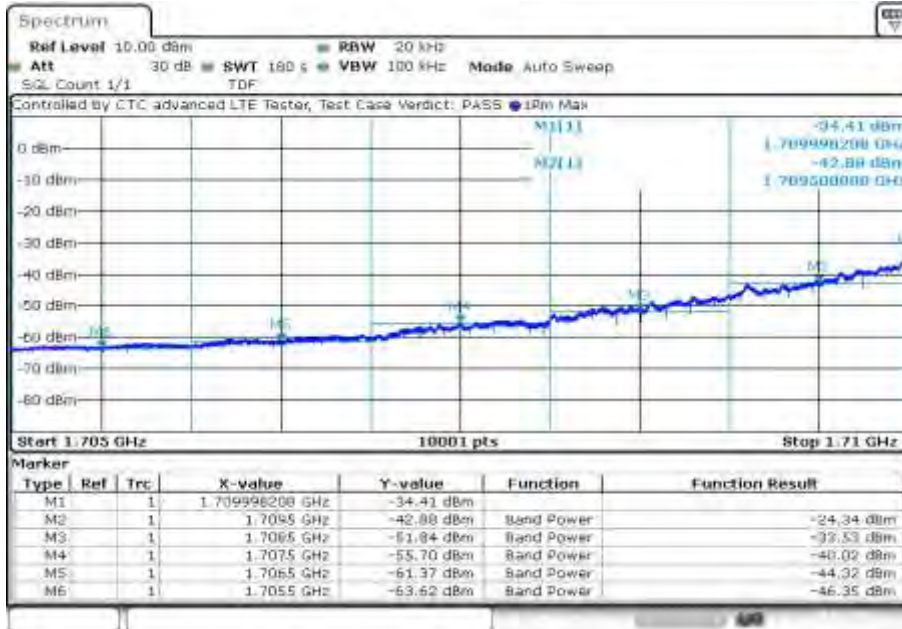

Date: 23.FEB.2022 08:23:24

**Plot 2: Highest channel, QPSK modulation**

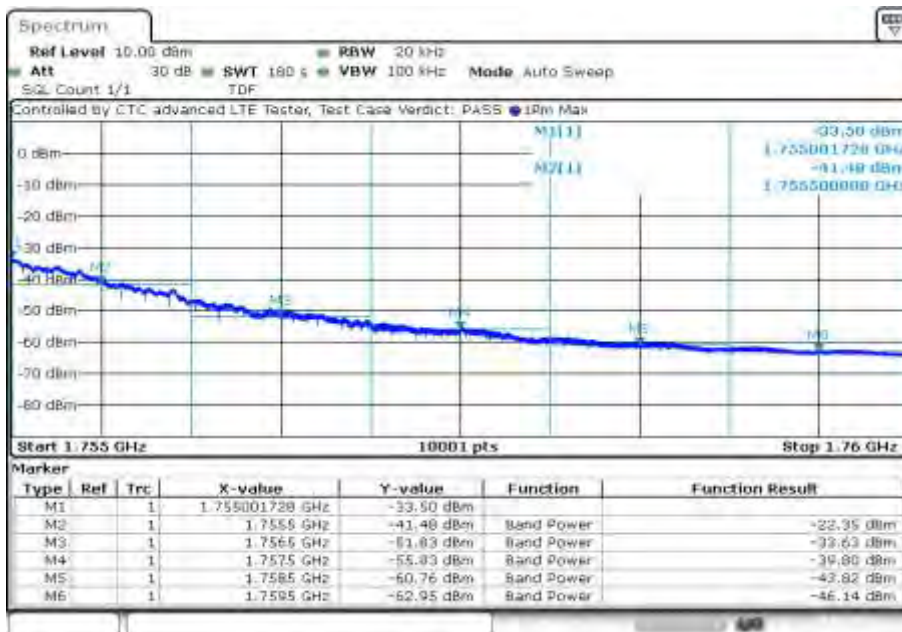

Date: 23.FEB.2022 09:21:11

**Plot 3: Lowest channel, 16 – QAM modulation**

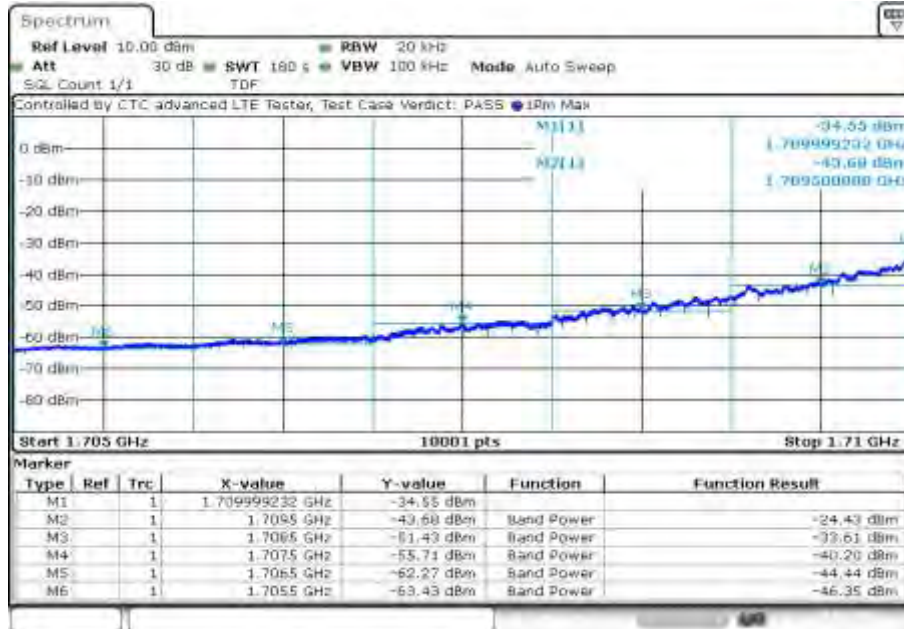

Date: 23.FEB.2022 08:39:22

**Plot 4: Highest channel, 16 – QAM modulation**

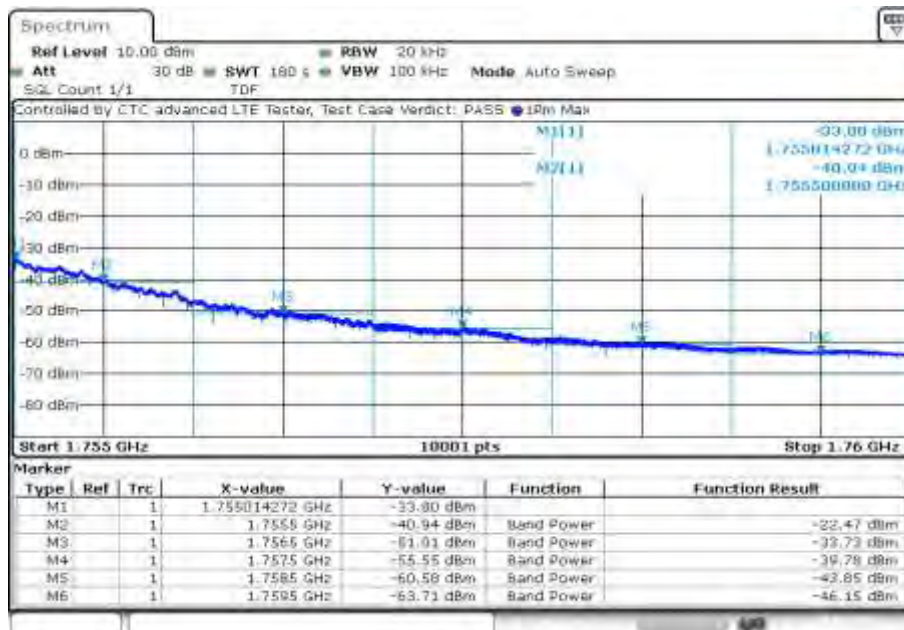

Date: 23.FEB.2022 09:37:10

### 15.3.6 Occupied bandwidth

#### Description:

Measurement of the occupied bandwidth of the transmitted signal.

#### Measurement:

Similar to conducted emissions, occupied bandwidth measurements are only provided for selected frequencies in order to reduce the amount of submitted data. Data were taken at the mid frequencies of the LTE band 4 frequency band. The table below lists the measured 99% power and -26dBc occupied bandwidths. Spectrum analyzer plots are included on the following pages.

Part 27.53 requires a measurement bandwidth of at least 1% of the occupied bandwidth.

Measurement parameters	
Detector:	Peak
Sweep time:	180s
Video bandwidth:	100 kHz
Resolution bandwidth:	30 kHz
Span:	2 x nominal bandwidth
Trace-Mode:	Max Hold
Used equipment:	See chapter 7.4 setup A
Measurement uncertainty:	See chapter 9
Measurement procedure	FCC: § 2.1049 ISED: RSS-Gen, 6.7

#### Limits:

FCC	ISED
§ 2.1049	RSS-Gen, 6.7
Reporting only	

**Results:**

Occupied Bandwidth – QPSK		
Frequency (MHz)	99% OBW (kHz)	-26 dBc BW (kHz)
1710.7	1091	1271
1732.5	1093	1278
1754.3	1091	1275

Occupied Bandwidth – 16-QAM		
Frequency (MHz)	99% OBW (kHz)	-26 dBc BW (kHz)
1710.7	1091	1270
1732.5	1093	1284
1754.3	1091	1269

**Plots: QPSK**

**Plot 1: low channel, 99% OBW**



Date: 23.FEB.2022 08:26:34

**Plot 2: low channel, -26 dBc OBW**

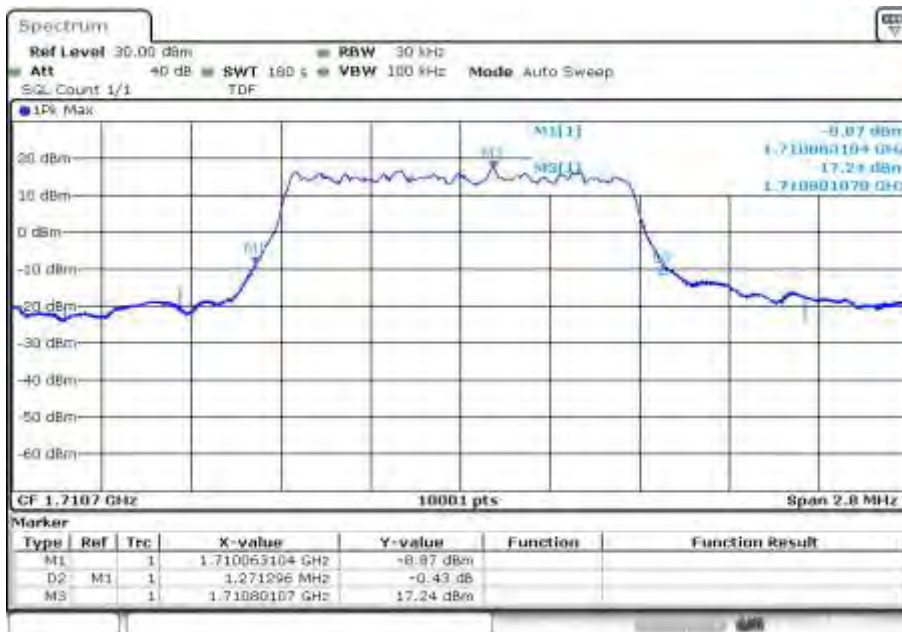

Date: 23.FEB.2022 08:29:44

**Plot 3:** mid channel, 99% OBW

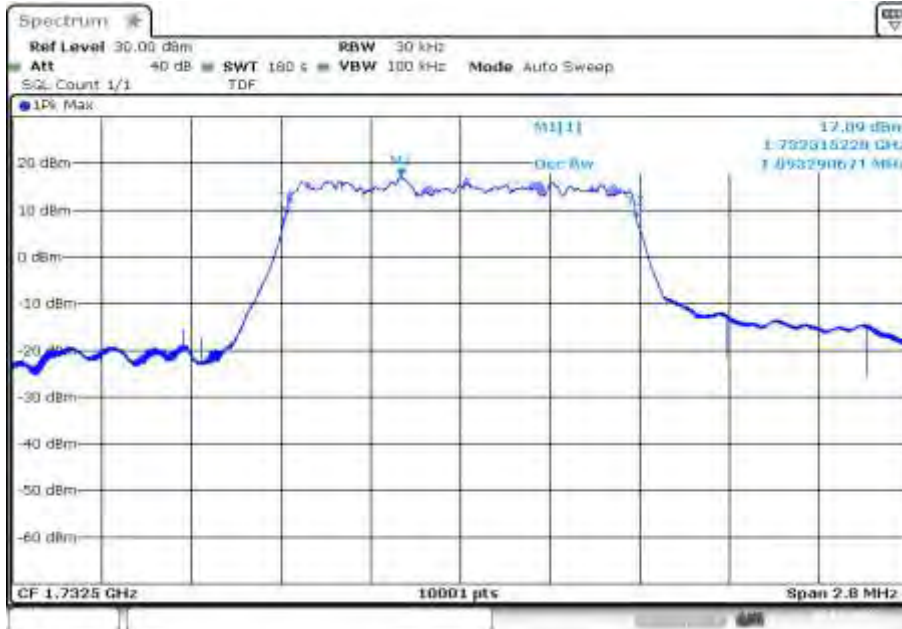

Date: 23.FEB.2022 08:55:25

**Plot 4:** mid channel, -26 dBc OBW



Date: 23.FEB.2022 08:58:37



**Plot 5: high channel, 99% OBW**

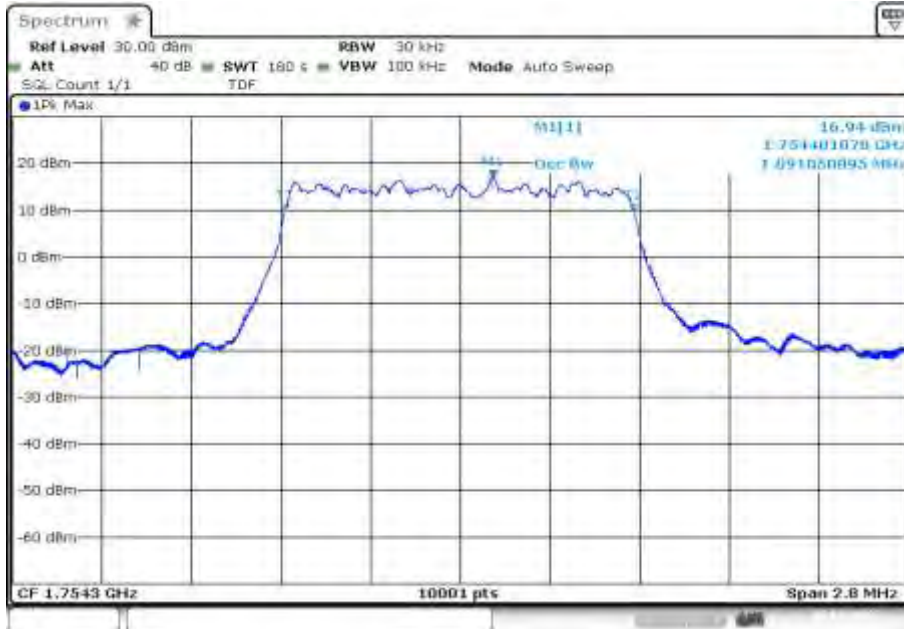

Date: 23.FEB.2022 09:24:21

**Plot 6: high channel, -26 dBc OBW**

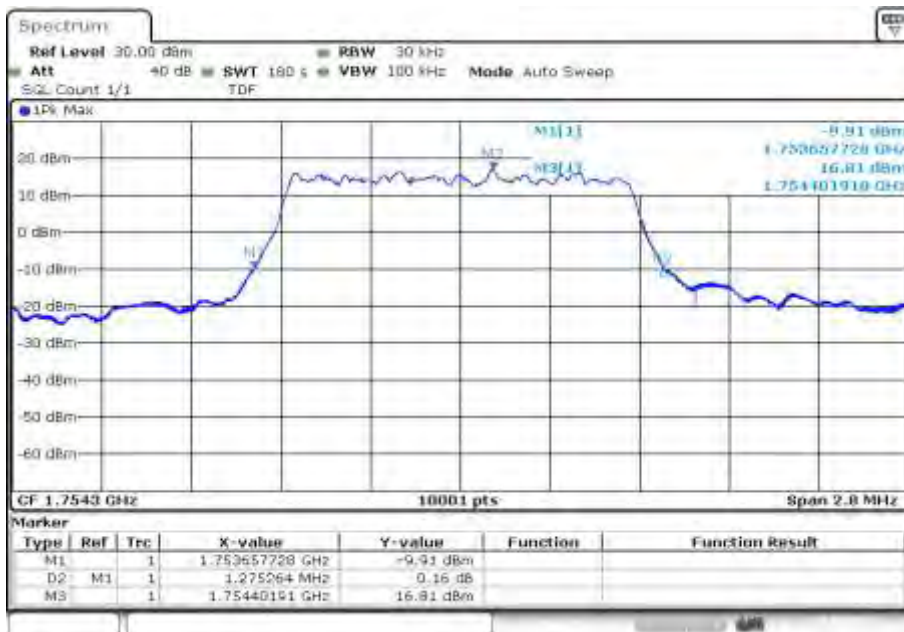

Date: 23.FEB.2022 09:27:32

**Plots: 16-QAM**

**Plot 1: low channel, 99% OBW**



Date: 23.FEB.2022 08:42:32

**Plot 2: low channel, -26 dBc OBW**

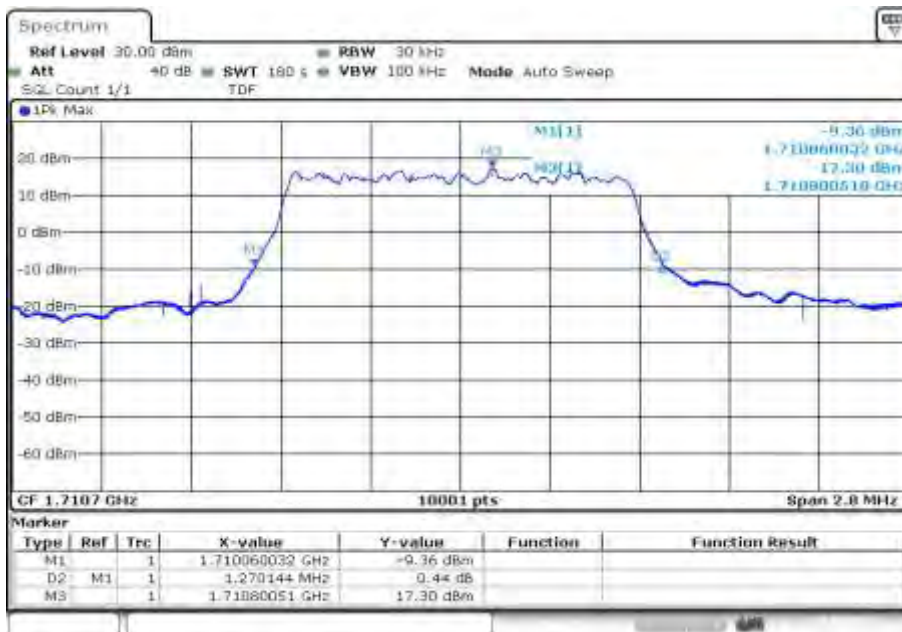

Date: 23.FEB.2022 08:45:41

**Plot 3:** mid channel, 99% OBW

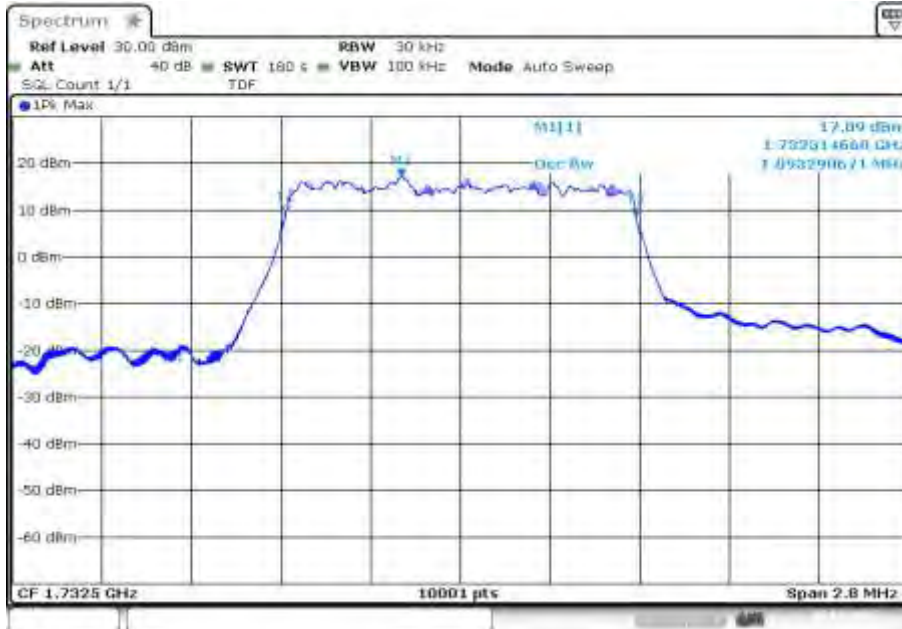

Date: 23.FEB.2022 09:08:16

**Plot 4:** mid channel, -26 dBc OBW



Date: 23.FEB.2022 09:11:28

**Plot 5: high channel, 99% OBW**

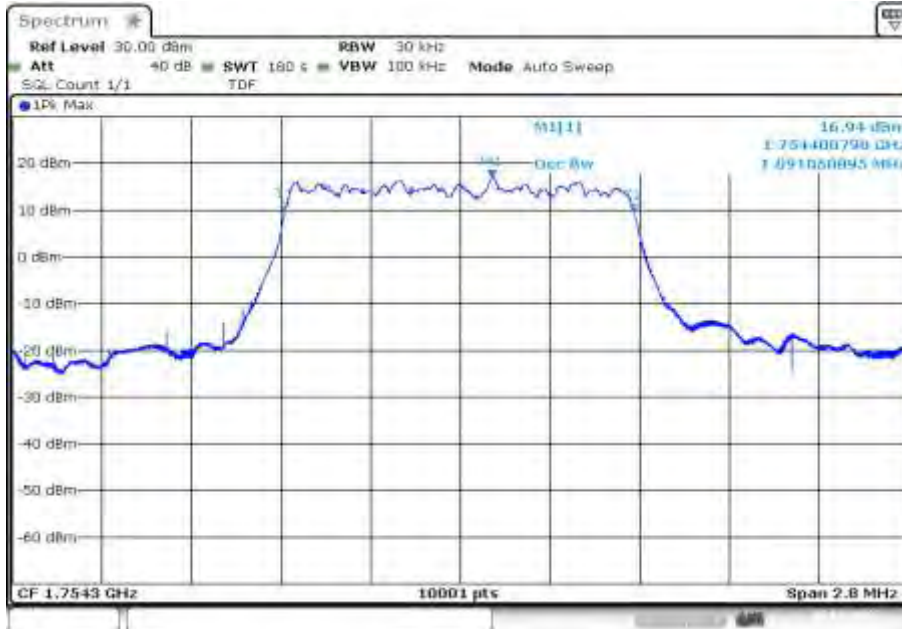

Date: 23.FEB.2022 09:40:20

**Plot 6: high channel, -26 dBc OBW**

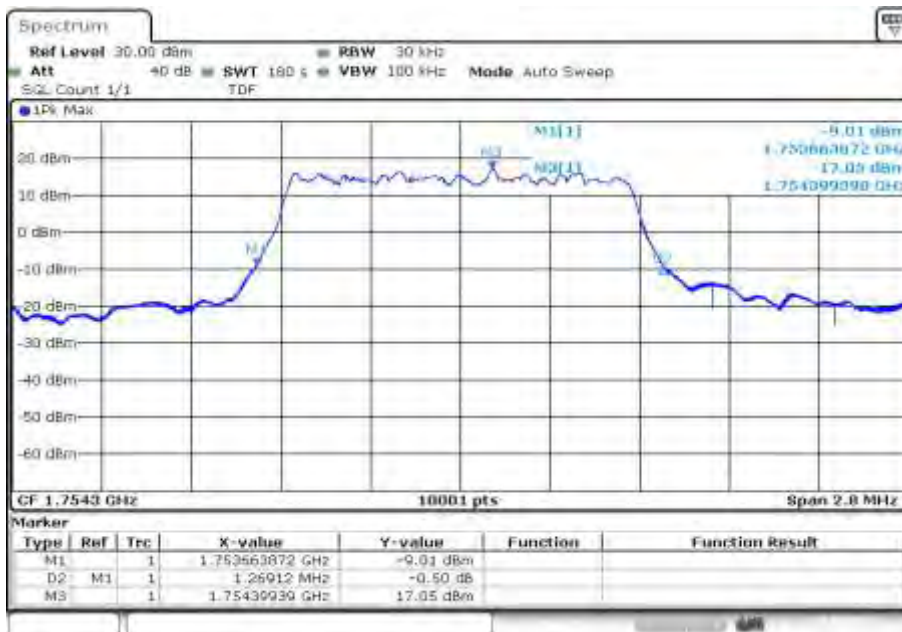

Date: 23.FEB.2022 09:43:31

## 15.4 Results LTE band 12

The EUT was set to transmit the maximum power.

### 15.4.1 RF output power

#### **Description:**

This paragraph contains average power, peak output power and EIRP measurements for the mobile station. In all cases, the peak output power is within the required mask (this mask is specified in the JTC standards, TIA PN3389 Vol. 1 Chap 7, and is no FCC requirement).

#### **Measurement:**

The mobile was set up for the maximum output power with pseudo random data modulation.

To determine the Peak-To-Average Power Ratio (PAPR) the measurement was performed with the Power Complementary Cumulative Distribution Function (CCDF).

Measurement parameters	
Detector:	Sample
AQT:	See plot
Resolution bandwidth:	1 MHz
Used equipment:	See chapter 7.2 setup A
Measurement uncertainty:	See chapter 9
Measurement procedure	FCC: § 2.1046 ISED: RSS-Gen, 6.12

**Limits:**

FCC	ISED
47 CFR 27.50(c)(9)	RSS-130, 4.6.1 & 4.6.3
<p>Portable stations (hand-held devices) in the 600 MHz uplink band and the 698-746 MHz band, and fixed and mobile stations in the 600 MHz uplink band are limited to 3 watts ERP.</p>	<p>4.6.1: The transmitter output power shall be measured in terms of average power. In addition, the peak-to-average power ratio (PAPR) of the transmitter shall not exceed 13 dB for more than 0.1% of the time and shall use a signal corresponding to the highest PAPR during periods of continuous transmission.</p> <p>4.6.3: The e.r.p. shall not exceed 30 watts for mobile equipment and outdoor fixed subscriber equipment. The e.r.p. shall not exceed 3 watts for portable equipment and indoor fixed subscriber equipment.</p>
<p>Power: <b>34.77 dBm ERP</b> PAPR: <b>13 dB</b> (ISED only)</p>	

**Results:**

Output Power (conducted)						
Bandwidth (MHz)	Frequency (MHz)	Resource block allocation	Average Output Power (dBm) QPSK	Peak to Average Ratio (dB)	Average Output Power (dBm) 16-QAM	Peak to Average Ratio (dB)
1.4	23017 / 699.7	1 RB low	17.5	5.9	16.3	7.0
		1 RB high	17.6	5.9	16.2	7.0
		100% RB	15.7	6.5	15.5	7.2
	23095 / 707.5	1 RB low	17.8	5.9	16.8	6.9
		1 RB high	17.7	5.9	16.8	6.9
		100% RB	15.9	6.4	16.0	7.2
	23173 / 715.3	1 RB low	18.0	5.8	16.6	6.9
		1 RB high	17.9	5.9	16.5	6.9
		100% RB	15.4	5.2	16.1	7.2
3	23025 / 700.5	1 RB low	17.5	5.9	15.5	7.7
		1 RB high	17.5	6.0	16.2	7.0
		100% RB	15.7	6.5	15.5	7.2
	23095 / 707.5	1 RB low	17.7	5.9	16.7	6.9
		1 RB high	17.7	5.9	16.5	7.0
		100% RB	15.8	6.5	16.0	7.2
	23165 / 714.5	1 RB low	17.3	6.6	16.7	6.9
		1 RB high	18.0	5.9	16.6	6.9
		100% RB	16.1	6.5	15.7	6.8
5	23035 / 701.5	1 RB low	19.5	4.2	19.6	4.7
		1 RB high	19.4	4.2	19.2	5.0
		100% RB	18.2	4.7	17.5	5.7
	23095 / 707.5	1 RB low	19.7	4.1	19.5	4.6
		1 RB high	19.6	4.1	19.3	4.7
		100% RB	18.3	4.7	17.5	5.7
	23155 / 713.5	1 RB low	20.1	4.0	20.5	4.2
		1 RB high	20.0	4.0	20.4	4.3
		100% RB	18.7	4.7	17.9	5.6
10	23060 / 704.0	1 RB low	19.4	4.1	19.4	4.7
		1 RB high	19.3	4.2	19.5	4.7
		100% RB	18.2	4.7	18.4	5.5
	23095 / 707.5	1 RB low	19.6	4.1	19.3	4.7
		1 RB high	19.5	4.1	19.2	4.7
		100% RB	18.3	4.7	18.3	5.4
	23130 / 711.0	1 RB low	20.1	4.0	20.4	4.3
		1 RB high	19.9	4.0	20.4	4.3
		100% RB	18.8	4.7	18.8	5.3

The radiated output power is measured in the mode with the highest conducted output power.

Output Power (ERP)			
Bandwidth (MHz)	Frequency (MHz)	Average Output Power (dBm)	Average Output Power (dBm)
		QPSK	16-QAM
1.4	699.7	10.7	9.4
	707.5	10.6	9.6
	715.3	10.6	9.2
3	700.5	10.6	9.3
	707.5	10.5	9.5
	714.5	10.6	9.3
5	701.5	12.6	12.7
	707.5	12.5	12.3
	713.5	12.7	13.1
10	704.0	12.5	12.6
	707.5	12.4	12.1
	711.0	12.7	13.0



## 15.4.2 Frequency stability

### Description:

In order to measure the carrier frequency under the condition of AFC lock, it is necessary to make measurements with the mobile station in a "call mode". This is accomplished with the use of a R&S CMW500 DIGITAL RADIOCOMMUNICATION TESTER.

1. Measure the carrier frequency at room temperature.
2. Subject the mobile station to overnight soak at -30 C.
3. With the mobile station, powered with  $V_{nom}$ , connected to the CMW500 and in a simulated call on channel 1412 (centre channel), measure the carrier frequency. These measurements should be made within two minutes of powering up the mobile station, to prevent significant self warming.
4. Repeat the above measurements at 10°C increments from -30°C to +50°C. Allow at least 1.5 hours at each temperature, unpowered, before making measurements.
5. Remeasure carrier frequency at room temperature with  $V_{nom}$ . Vary supply voltage from  $V_{min}$  to  $V_{max}$ , in 0.1 Volt steps remeasuring carrier frequency at each voltage. Pause at  $V_{nom}$  for 1.5 hours unpowered, to allow any self heating to stabilize, before continuing.
6. At all temperature levels hold the temperature to +/- 0.5°C during the measurement procedure.

This measurement was performed with the highest channel bandwidth supported from the EUT on the middle channel

### Measurement:

Measurement parameters	
Detector:	Measured with CMW500
Sweep time:	
Video bandwidth:	
Resolution bandwidth:	
Span:	
Trace-Mode:	
Used equipment:	See chapter 7.4 setup A
Measurement uncertainty:	See chapter 9
Measurement procedure	FCC: § 2.1055 ISED: RSS-Gen, 6.11

**Limits:**

FCC	ISED
§ 27.54	RSS-130, 4.5
The frequency stability shall be sufficient to ensure that the fundamental emissions stay within the authorized bands of operation.	The frequency stability shall be sufficient to ensure that the occupied bandwidth remains within each frequency block range when tested at the temperature and supply voltage variations specified in RSS-Gen.

**Results:**

**FREQ ERROR versus VOLTAGE**

Voltage (V)	Frequency Error (Hz)	Frequency Error (ppm)
3.2	-16	-0.0226
3.6	-16	-0.0226
4.0	-16	-0.0226

**FREQ ERROR versus TEMPERATURE**

Temperature (°C)	Frequency Error (Hz)	Frequency Error (ppm)
-30	17	0.0240
-20	18	0.0254
-10	20	0.0283
± 0	-16	-0.0226
10	-11	-0.0155
20	-16	-0.0226
30	-15	-0.0212
40	-37	-0.0523
50	-24	-0.0339

**Additional measurements for RSS-130 (4.3 b)**

$f_L = 699.047104 \text{ MHz}$	$f_H = 715.943104 \text{ MHz}$
$f_L - (\text{max freq. error}) = 699.047067 \text{ MHz}$	$f_H + (\text{max freq. error}) = 715.943141 \text{ MHz}$

### 15.4.3 Spurious emissions radiated

#### Description:

The following steps outline the procedure used to measure the radiated emissions from the mobile station. The site is constructed in accordance with ANSI C63.4:2014 requirements and is recognized by the FCC to be in compliance for a 3 and a 10 meter site. The spectrum was scanned from 30 MHz to the 10th harmonic of the highest frequency generated within the equipment, which is the transmitted carrier that can be as high as 711 MHz. Measured up to 8 GHz. The resolution bandwidth is set as outlined in Part 27.53. The spectrum was scanned with the mobile station transmitting at carrier frequencies that pertain to low, mid and high channels of the LTE band 12.

#### Measurement:

Measurement parameters	
Detector:	Peak
Sweep time:	2 sec.
Resolution bandwidth:	1 MHz
Video bandwidth:	3 MHz
Span:	100 MHz Steps
Trace mode:	Max Hold
Used equipment:	See chapter
Measurement uncertainty:	See chapter 9
Measurement procedure	FCC: § 2.1053 ISED: RSS-Gen, 6.13

#### Limits:

FCC	ISED
§ 27.53(g)	RSS-130, 4.7.1
For operations in the 600 MHz band and the 698-746 MHz band, the power of any emission outside a licensee's frequency band(s) of operation shall be attenuated below the transmitter power (P) within the licensed band(s) of operation, measured in watts, by at least $43 + 10 \log(P)$ dB. Compliance with this provision is based on the use of measurement instrumentation employing a resolution bandwidth of 100 kilohertz or greater. However, in the 100 kilohertz bands immediately outside and adjacent to a licensee's frequency block, a resolution bandwidth of at least 30 kHz may be employed.	The unwanted emissions in any 100 kHz bandwidth on any frequency outside the low frequency edge and the high frequency edge of each frequency block range(s), shall be attenuated below the transmitter power, P (dBW), by at least $43 + 10 \log_{10}(P)$ (watts), dB. However, in the 100 kHz band immediately outside of the equipment's frequency block range, a resolution bandwidth of 30 kHz may be employed.
<b>-13 dBm</b>	

**Results:**

**QPSK**

SPURIOUS EMISSION LEVEL					
LOWEST CHANNEL		MIDDLE CHANNEL		HIGHEST CHANNEL	
Spurious emissions	Level [dBm]	Spurious emissions	Level [dBm]	Spurious emissions	Level [dBm]
All detected spurious emissions are more than 20 dB below the limit.		All detected spurious emissions are more than 20 dB below the limit.		All detected spurious emissions are more than 20 dB below the limit.	

**16-QAM**

SPURIOUS EMISSION LEVEL					
LOWEST CHANNEL		MIDDLE CHANNEL		HIGHEST CHANNEL	
Spurious emissions	Level [dBm]	Spurious emissions	Level [dBm]	Spurious emissions	Level [dBm]
All detected spurious emissions are more than 20 dB below the limit.		All detected spurious emissions are more than 20 dB below the limit.		All detected spurious emissions are more than 20 dB below the limit.	

**QPSK**

**Plot 1:** Middle channel, up to 30 MHz

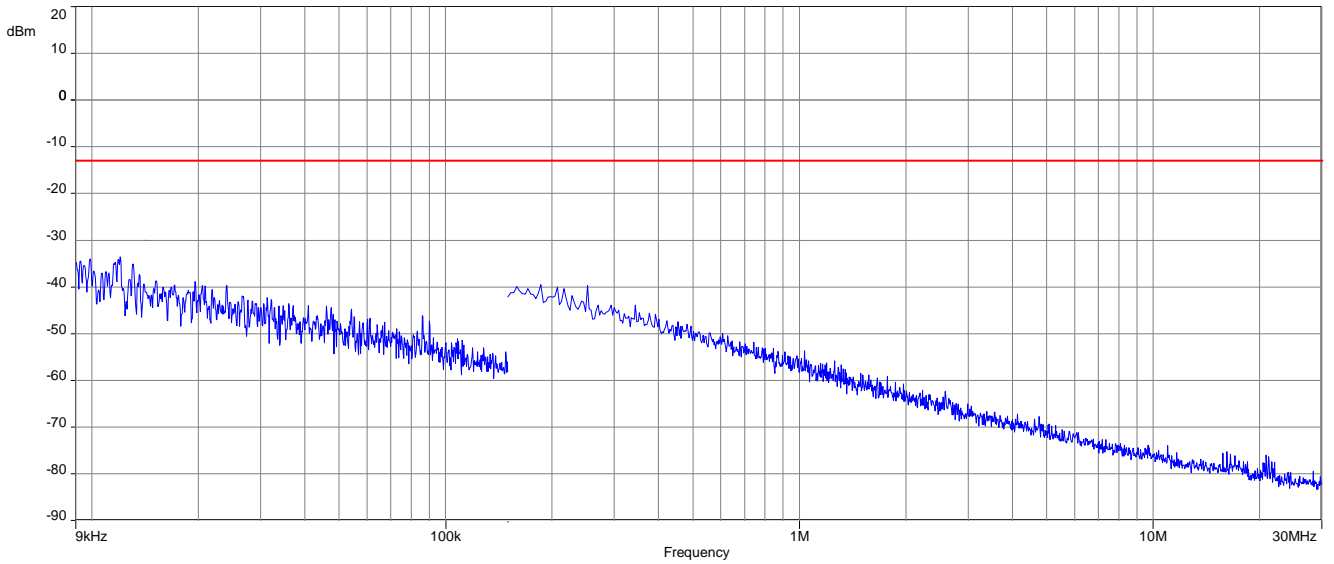

**Plot 2:** Middle channel, 30 MHz to 1 GHz

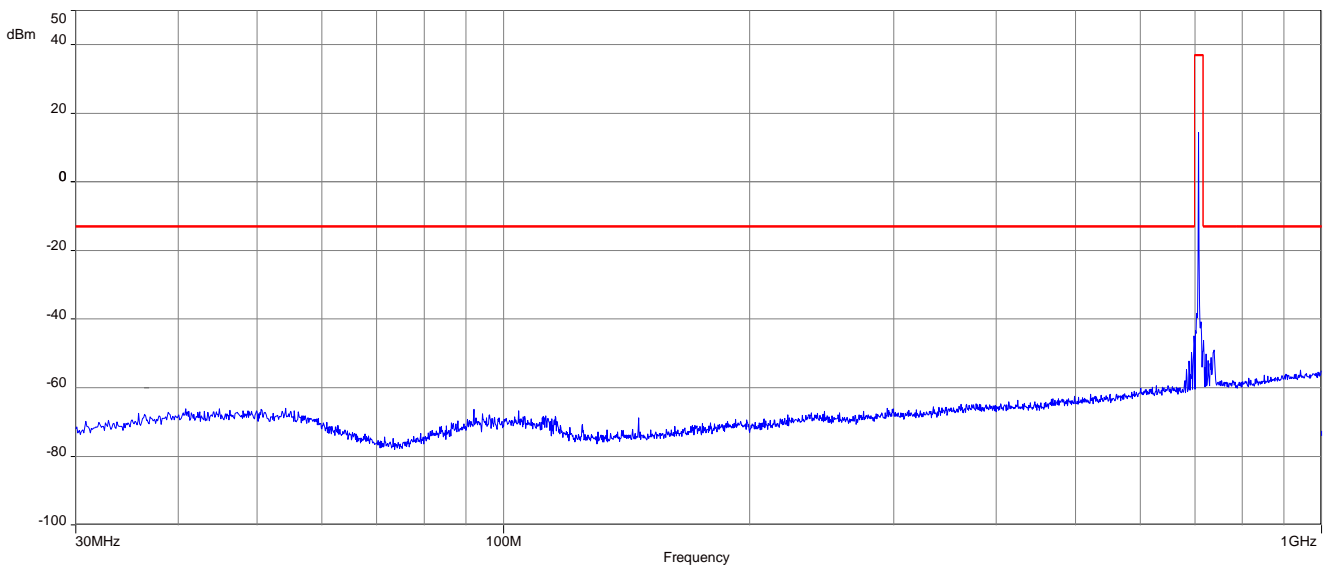

**Plot 3:** Middle channel, 1 GHz to 8 GHz

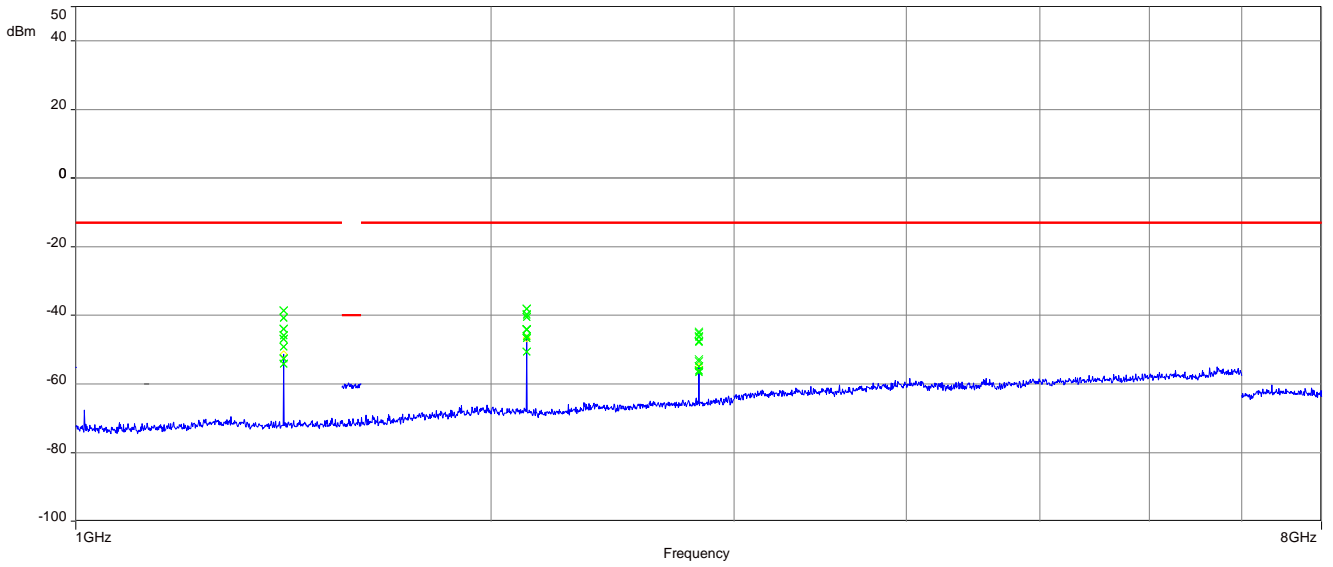

### 16-QAM

**Plot 1:** Middle channel, up to 30 MHz

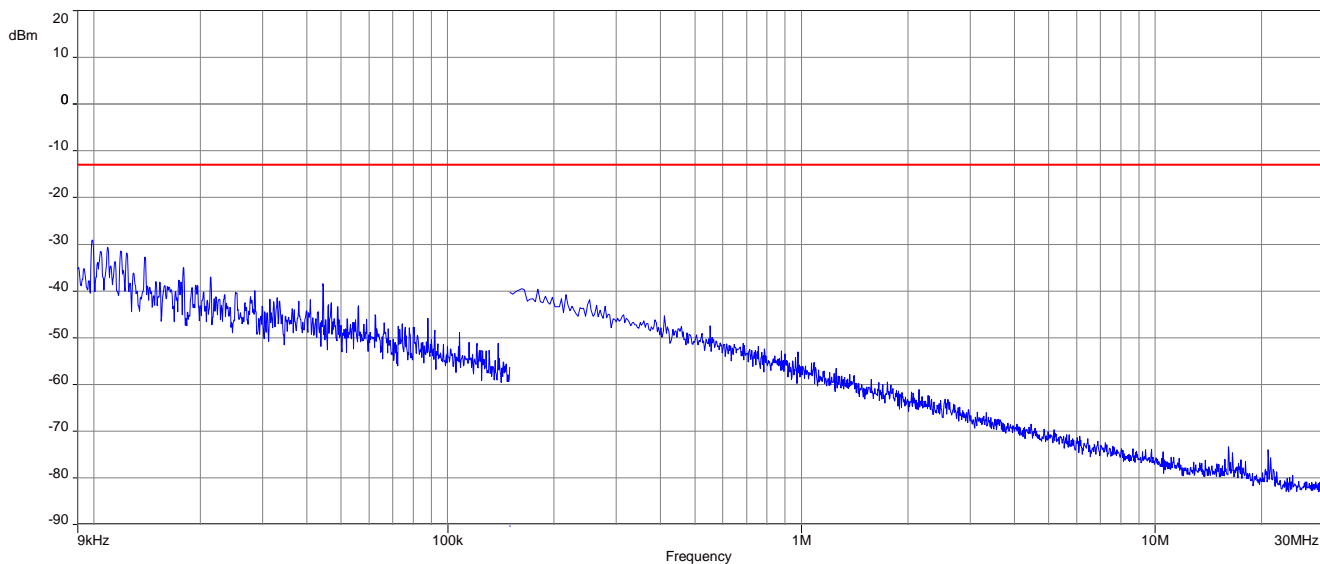

**Plot 2:** Middle channel, 30 MHz to 1 GHz

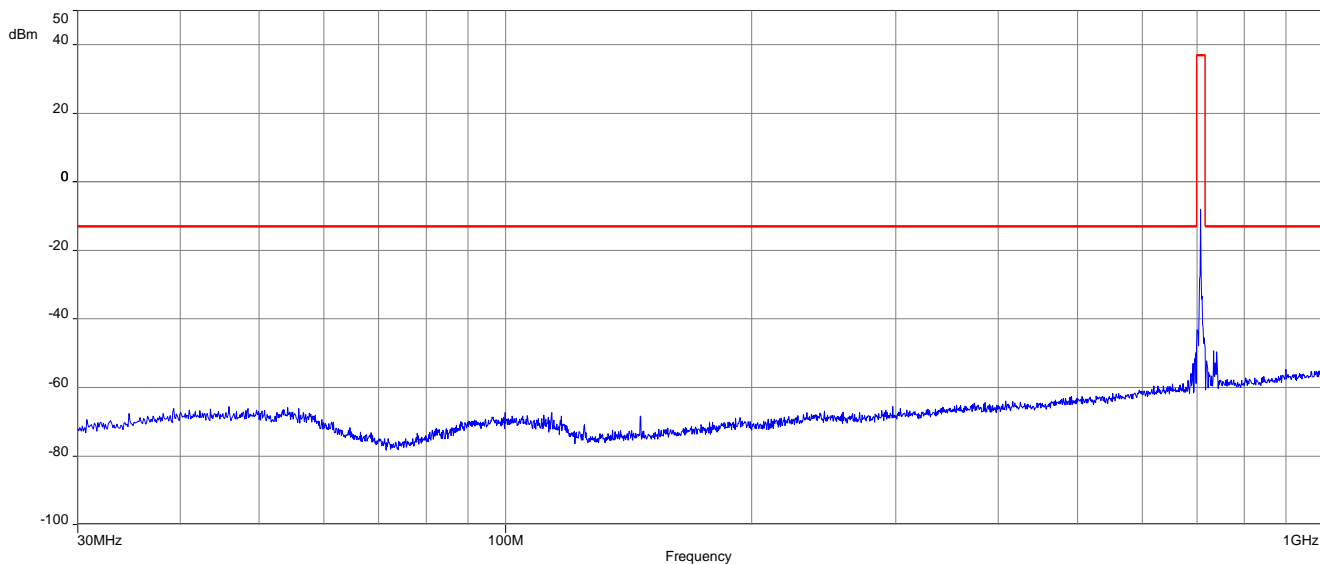

**Plot 3:** Middle channel, 1 GHz to 8 GHz

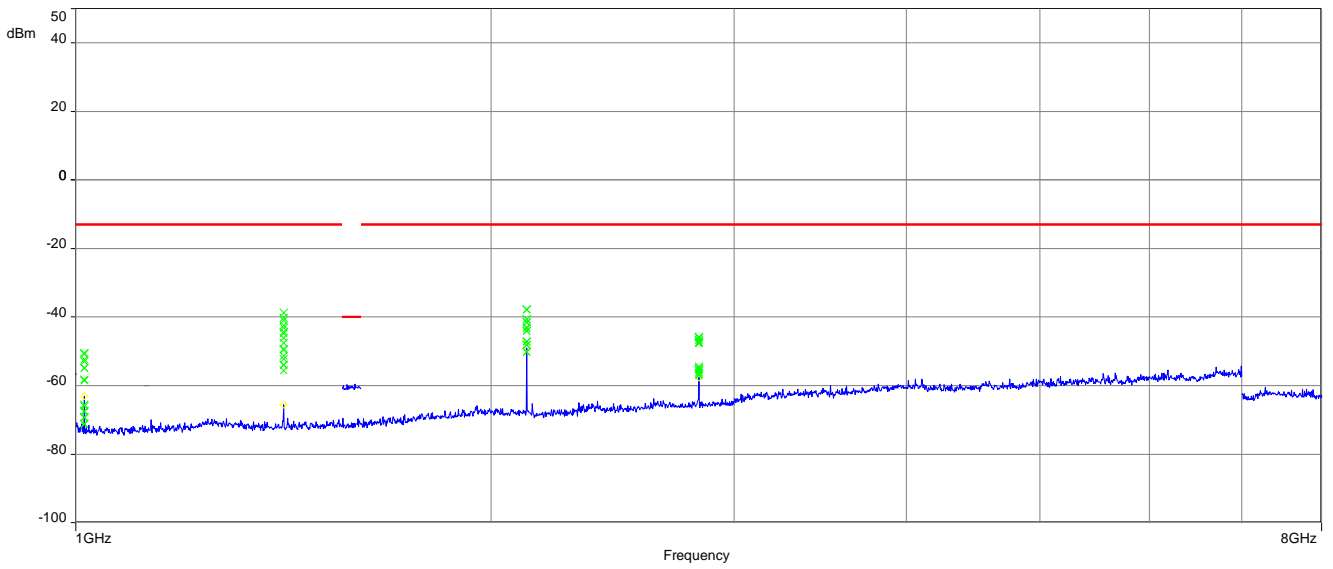



### 15.4.4 Spurious emissions conducted

**Description:**

The following steps outline the procedure used to measure the conducted emissions from the mobile station.

1. Determine frequency range for measurements: From § 2.1057 & RSS-Gen, 6.13.2 the spectrum should be investigated from the lowest radio frequency generated in the equipment up to at least the 10th harmonic of the carrier frequency.
2. Determine mobile station transmits frequencies: below outlines the band edge frequencies pertinent to conducted emissions testing.

**Measurement:**

Measurement parameters	
Detector:	Peak
Sweep time:	Auto
Video bandwidth:	300 kHz
Resolution bandwidth:	100 kHz
Span:	10 MHz – 7.5 GHz
Trace-Mode:	Max Hold
Used equipment:	See chapter 7.4 setup A
Measurement uncertainty:	See chapter 9
Measurement procedure	FCC: § 2.1051 ISED: RSS-Gen, 6.13

**Limits:**

FCC	ISED
§ 27.53(g)	RSS-130, 4.7.1
For operations in the 600 MHz band and the 698-746 MHz band, the power of any emission outside a licensee’s frequency band(s) of operation shall be attenuated below the transmitter power (P) within the licensed band(s) of operation, measured in watts, by at least $43 + 10 \log(P)$ dB. Compliance with this provision is based on the use of measurement instrumentation employing a resolution bandwidth of 100 kilohertz or greater. However, in the 100 kilohertz bands immediately outside and adjacent to a licensee’s frequency block, a resolution bandwidth of at least 30 kHz may be employed.	The unwanted emissions in any 100 kHz bandwidth on any frequency outside the low frequency edge and the high frequency edge of each frequency block range(s), shall be attenuated below the transmitter power, P (dBW), by at least $43 + 10 \log_{10}(P)$ (watts), dB. However, in the 100 kHz band immediately outside of the equipment’s frequency block range, a resolution bandwidth of 30 kHz may be employed.
<b>-13 dBm</b>	

**Results:** for 1.4 MHz channel bandwidth

**QPSK**

SPURIOUS EMISSION LEVEL					
LOWEST CHANNEL		MIDDLE CHANNEL		HIGHEST CHANNEL	
Spurious emissions	Level [dBm]	Spurious emissions	Level [dBm]	Spurious emissions	Level [dBm]
1399.4	-	1415.0	-	1430.6	-
2099.1	-	2122.5	-	2145.9	-
2798.8	-	2830.0	-	2861.2	-
3498.5	-	3537.5	-	3576.5	-
4198.2	-	4245.0	-	4291.8	-
4897.9	-	4952.5	-	5007.1	-
5597.6	-	5660.0	-	5722.4	-
6297.3	-	6367.5	-	6437.7	-
6997.0	-	7075.0	-	7153.0	-

**16-QAM**

SPURIOUS EMISSION LEVEL					
LOWEST CHANNEL		MIDDLE CHANNEL		HIGHEST CHANNEL	
Spurious emissions	Level [dBm]	Spurious emissions	Level [dBm]	Spurious emissions	Level [dBm]
1399.4	-	1415.0	-	1430.6	-
2099.1	-	2122.5	-	2145.9	-
2798.8	-	2830.0	-	2861.2	-
3498.5	-	3537.5	-	3576.5	-
4198.2	-	4245.0	-	4291.8	-
4897.9	-	4952.5	-	5007.1	-
5597.6	-	5660.0	-	5722.4	-
6297.3	-	6367.5	-	6437.7	-
6997.0	-	7075.0	-	7153.0	-

**Plots for 1.4 MHz channel bandwidth, QPSK**

**Plot 1:** Lowest channel, 10 MHz to 7.5 GHz

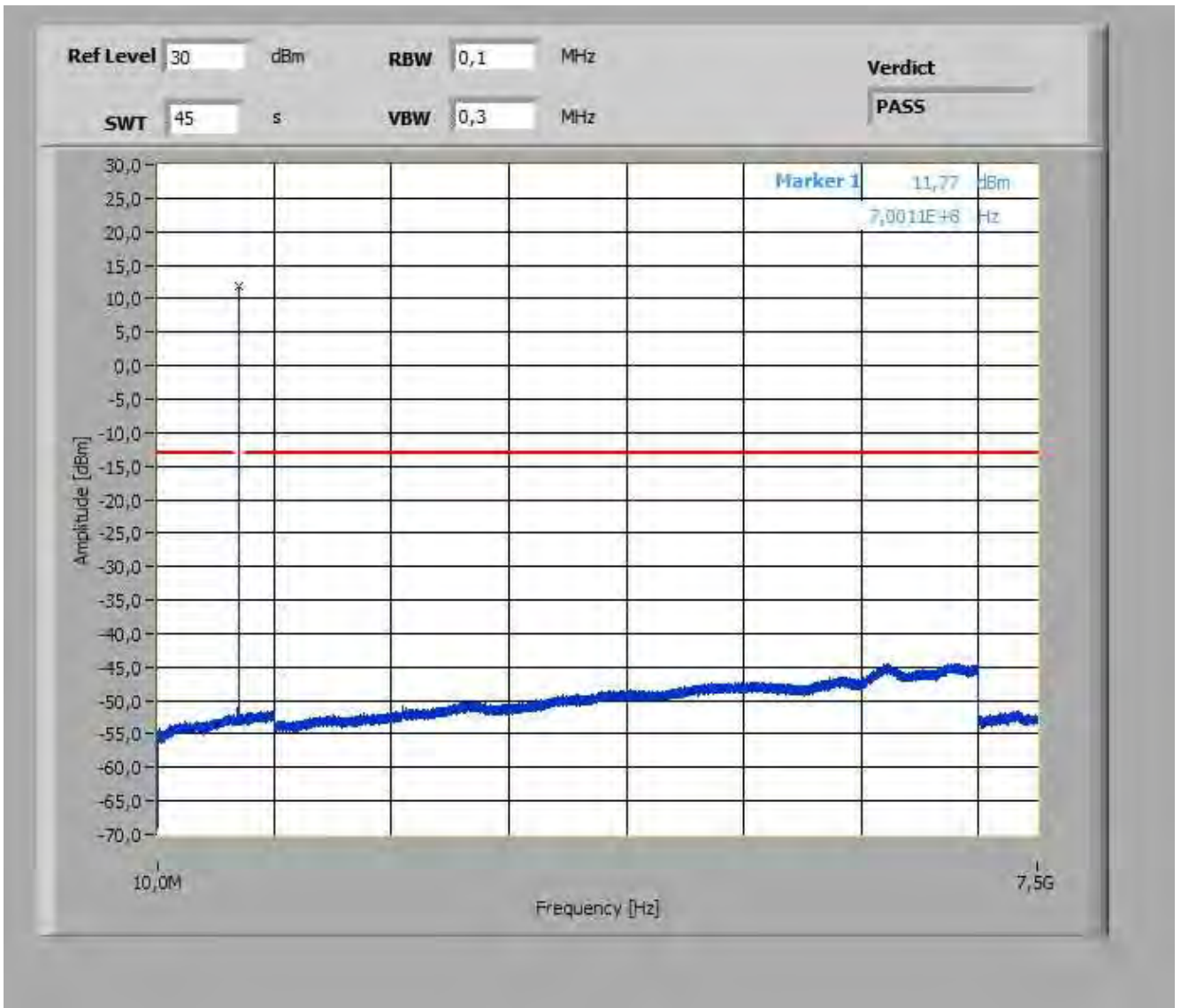

**Plot 2:** Middle channel, 10 MHz to 7.5 GHz

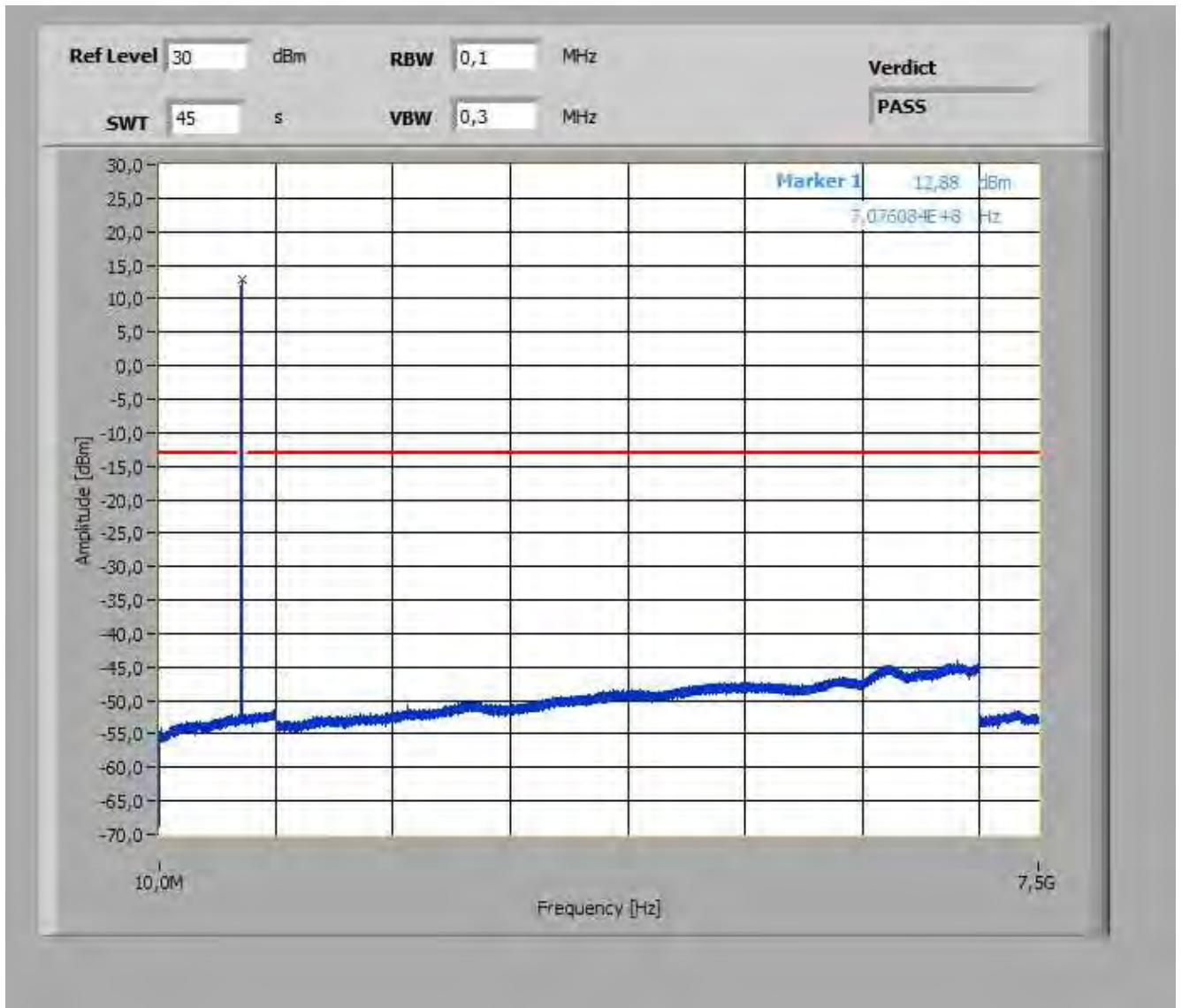

**Plot 3:** Highest channel, 10 MHz to 7.5 GHz

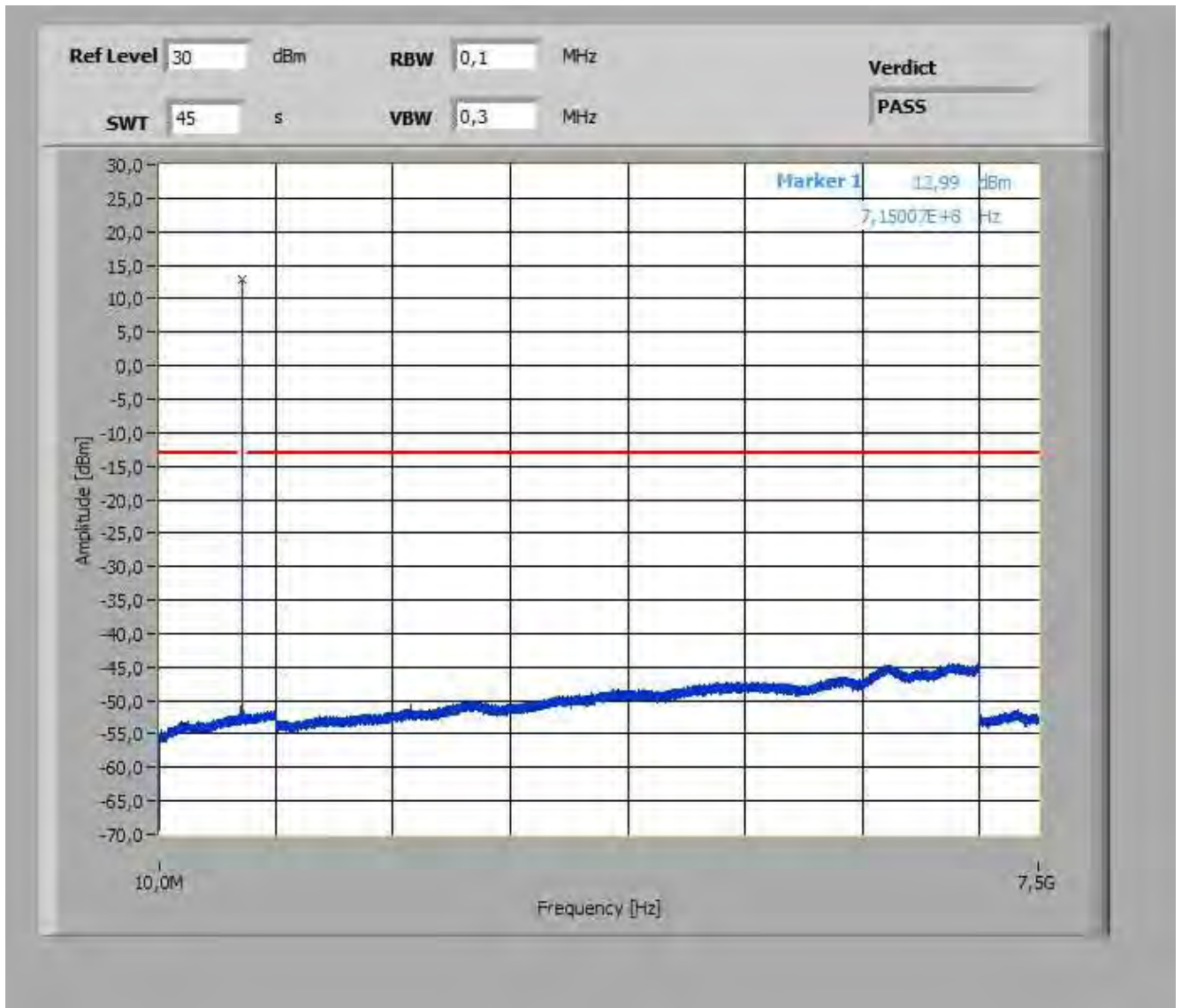

**Plots for 1.4 MHz channel bandwidth, 16-QAM**

**Plot 1:** Lowest channel, 10 MHz to 7.5 GHz

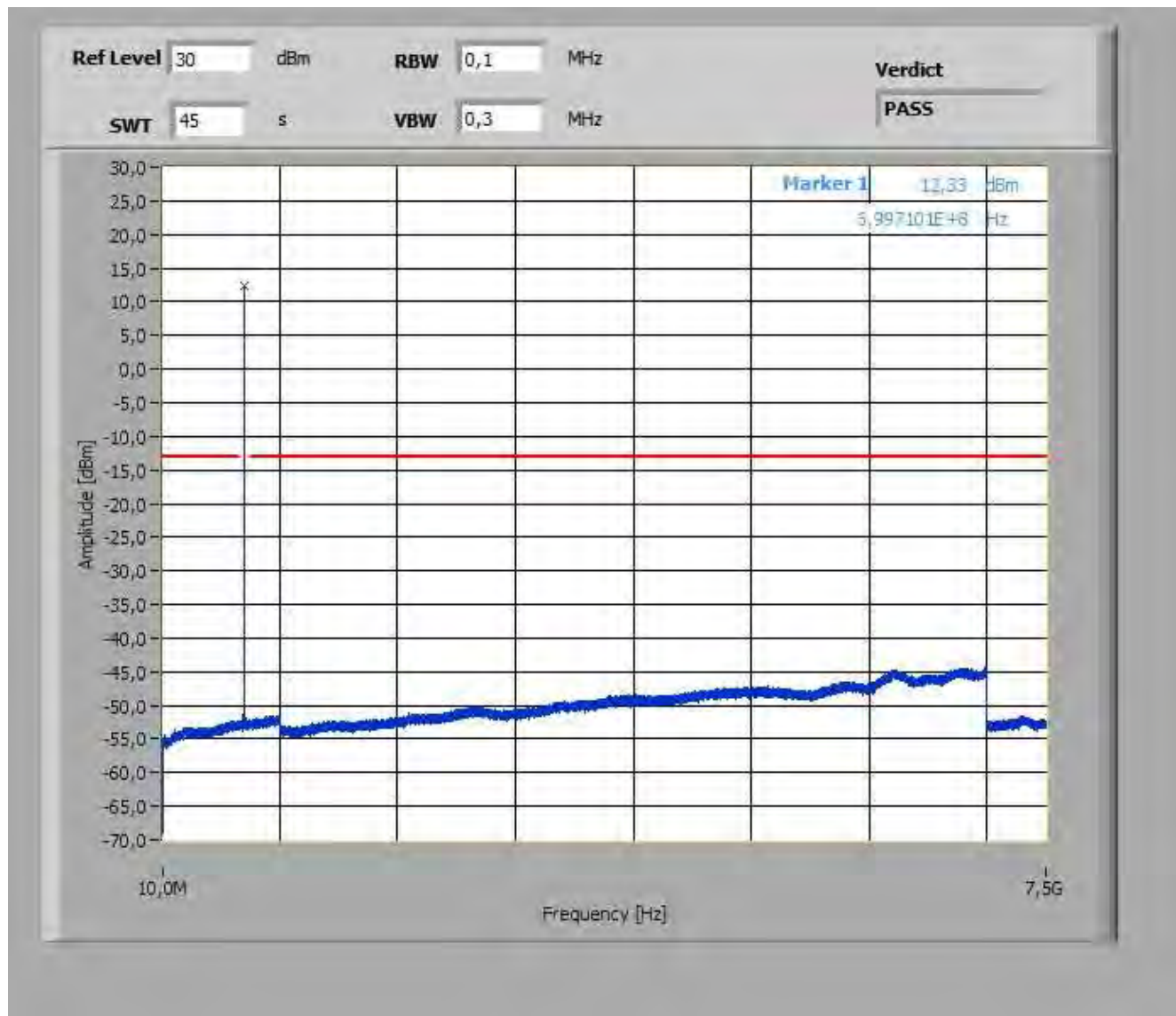

**Plot 2:** Middle channel, 10 MHz to 7.5 GHz

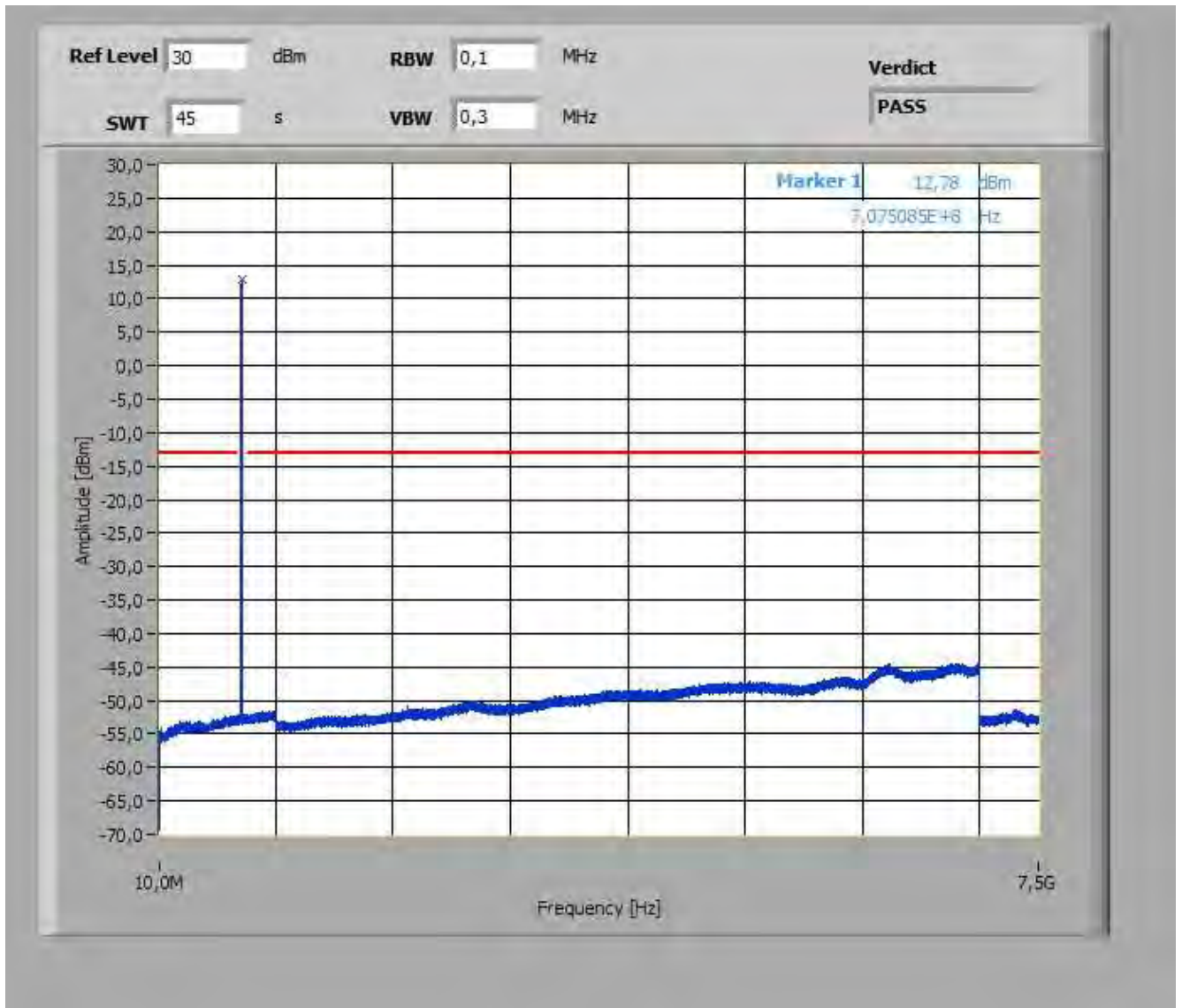

**Plot 3:** Highest channel, 10 MHz to 7.5 GHz

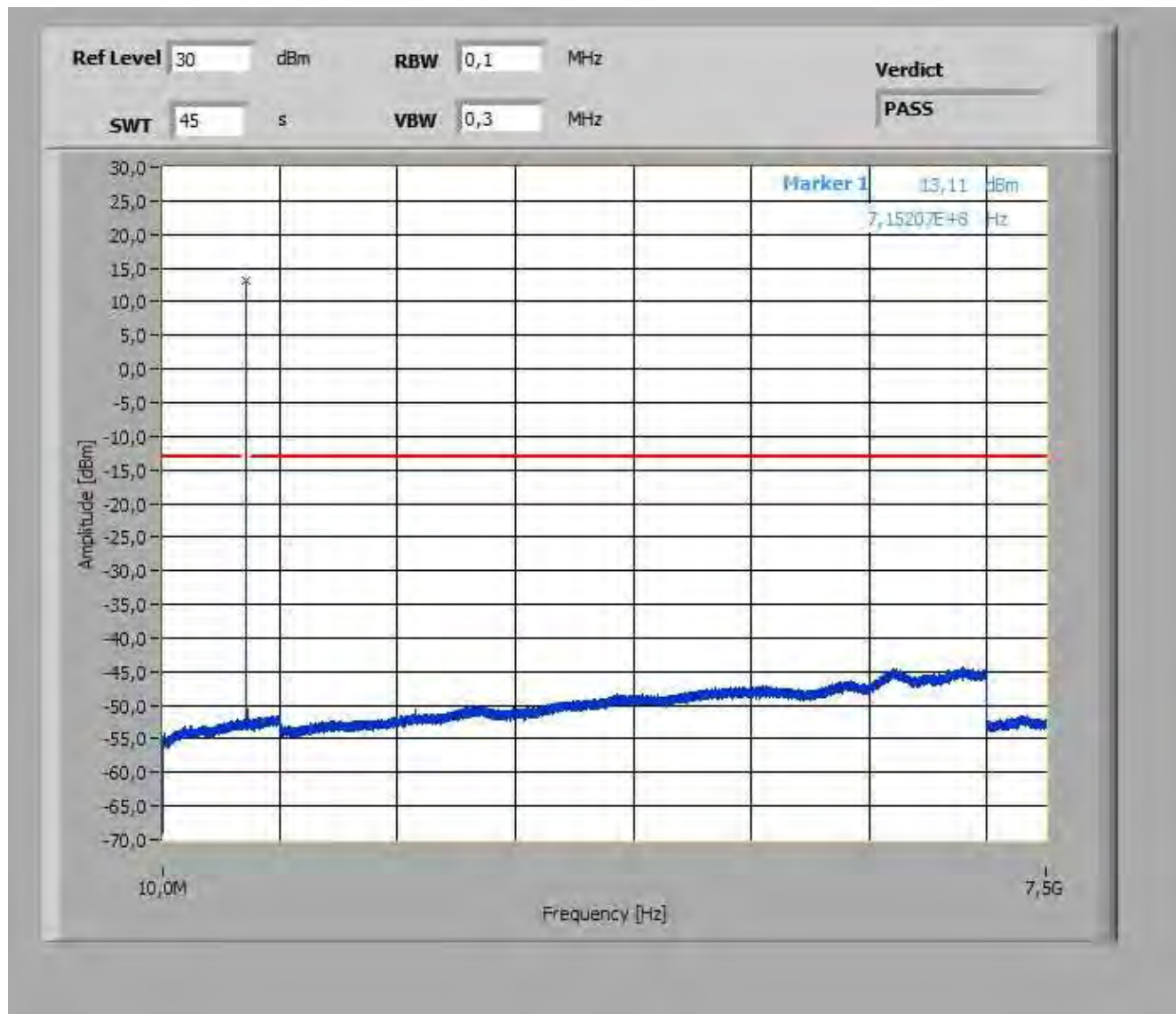



### 15.4.5 Block edge compliance

**Description:**

The spectrum at the band edges must comply with the spurious emissions limits.

**Measurement:**

Measurement parameters	
Detector:	RMS
Sweep time:	180s
Video bandwidth:	300 kHz
Resolution bandwidth:	100 kHz
Span:	1 MHz
Trace-Mode:	Max Hold
Used equipment:	See chapter 7.4 setup A
Measurement uncertainty:	See chapter 9
Measurement procedure	FCC: § 2.1051 ISED: RSS-Gen, 6.13

**Limits:**

FCC	ISED
§ 27.53(g)	RSS-130, 4.7.1
For operations in the 600 MHz band and the 698-746 MHz band, the power of any emission outside a licensee's frequency band(s) of operation shall be attenuated below the transmitter power (P) within the licensed band(s) of operation, measured in watts, by at least $43 + 10 \log(P)$ dB. Compliance with this provision is based on the use of measurement instrumentation employing a resolution bandwidth of 100 kilohertz or greater. However, in the 100 kilohertz bands immediately outside and adjacent to a licensee's frequency block, a resolution bandwidth of at least 30 kHz may be employed.	The unwanted emissions in any 100 kHz bandwidth on any frequency outside the low frequency edge and the high frequency edge of each frequency block range(s), shall be attenuated below the transmitter power, P (dBW), by at least $43 + 10 \log_{10}(P)$ (watts), dB. However, in the 100 kHz band immediately outside of the equipment's frequency block range, a resolution bandwidth of 30 kHz may be employed.
<b>-13 dBm</b>	
Correction factor according to KDB 890810 if $RBW < 1\%$ emission bandwidth: <input checked="" type="checkbox"/> N/A here <input type="checkbox"/> $10 \log(RBW1/RBW2) = X$ dB; whereas: $RBW1 = Y, RBW2 = Z$	

**Results: 1.4 MHz channel bandwidth**

**Plot 1: Lowest channel, QPSK modulation**

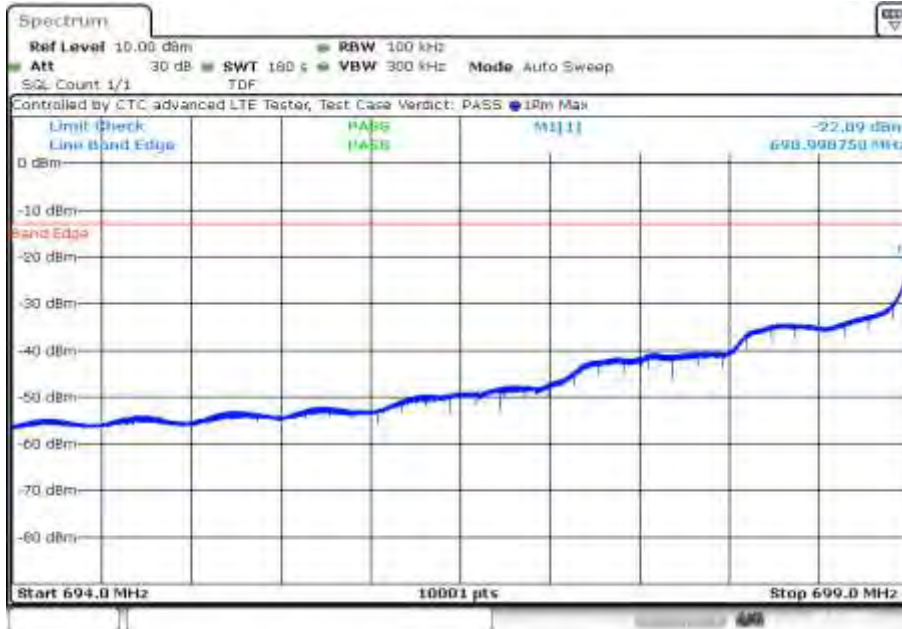

Date: 23.FEB.2022 11:18:54

**Plot 2: Highest channel, QPSK modulation**



Date: 23.FEB.2022 12:36:13

**Plot 3:** Lowest channel, 16 – QAM modulation

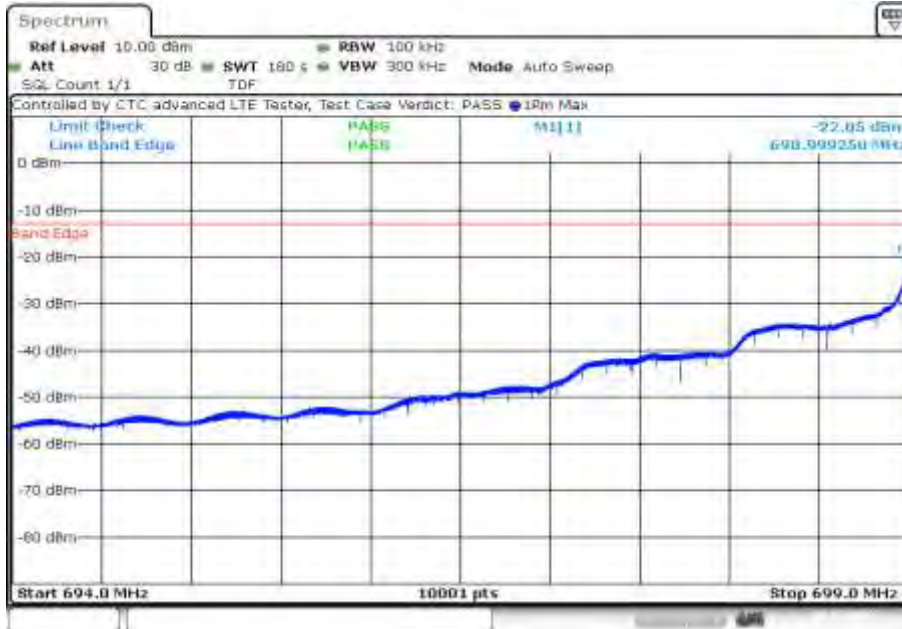

Date: 23.FEB.2022 11:31:09

**Plot 4:** Highest channel, 16 – QAM modulation



Date: 23.FEB.2022 12:48:28

### 15.4.6 Occupied bandwidth

#### Description:

Measurement of the occupied bandwidth of the transmitted signal.

#### Measurement:

Similar to conducted emissions, occupied bandwidth measurements are only provided for selected frequencies in order to reduce the amount of submitted data. Data were taken at the mid frequencies of the LTE band 12 frequency band. The table below lists the measured 99% power and -26dBc occupied bandwidths. Spectrum analyzer plots are included on the following pages.

Part 27.53 requires a measurement bandwidth of at least 1% of the occupied bandwidth.

Measurement parameters	
Detector:	Peak
Sweep time:	180s
Video bandwidth:	100 kHz
Resolution bandwidth:	30 kHz
Span:	2 x nominal bandwidth
Trace-Mode:	Max Hold
Used equipment:	See chapter 7.4 setup A
Measurement uncertainty:	See chapter 9
Measurement procedure	FCC: § 2.1049 ISED: RSS-Gen, 6.7

#### Limits:

FCC	ISED
§ 2.1049	RSS-Gen, 6.7
Reporting only	

**Results:**

Occupied Bandwidth – QPSK		
Frequency (MHz)	99% OBW (kHz)	-26 dBc BW (kHz)
699.7	1099	1301
707.5	1098	1295
715.3	1098	1295

Occupied Bandwidth – 16-QAM		
Frequency (MHz)	99% OBW (kHz)	-26 dBc BW (kHz)
699.7	1099	1293
707.5	1098	1293
715.3	1098	1293

**Plots: QPSK**

**Plot 1: low channel, 99% OBW**



Date: 23.FEB.2022 11:22:05

**Plot 2: low channel, -26 dBc OBW**



Date: 23.FEB.2022 11:25:16

**Plot 3:** mid channel, 99% OBW

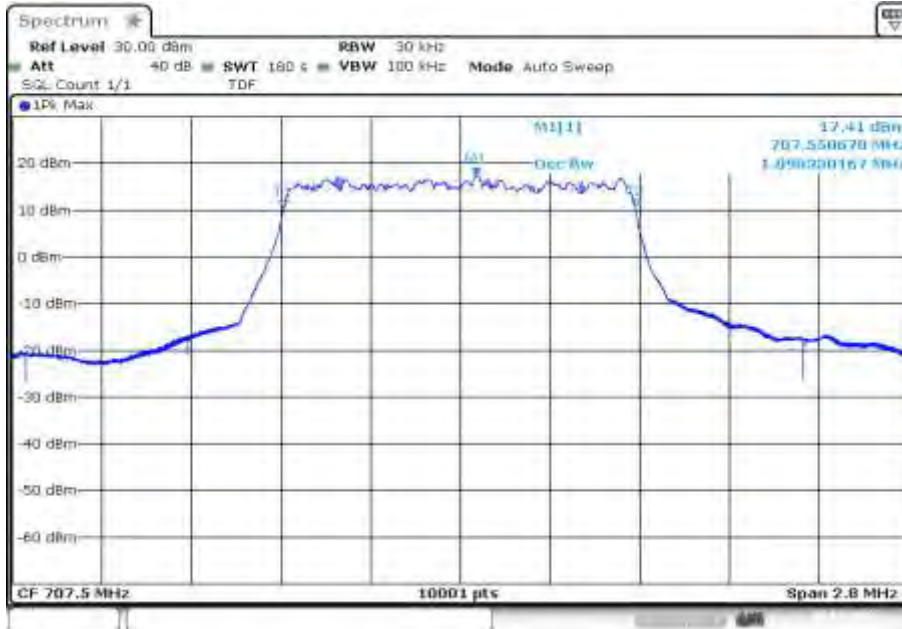

Date: 23.FEB.2022 11:44:38

**Plot 4:** mid channel, -26 dBc OBW



Date: 23.FEB.2022 11:47:49

**Plot 5: high channel, 99% OBW**

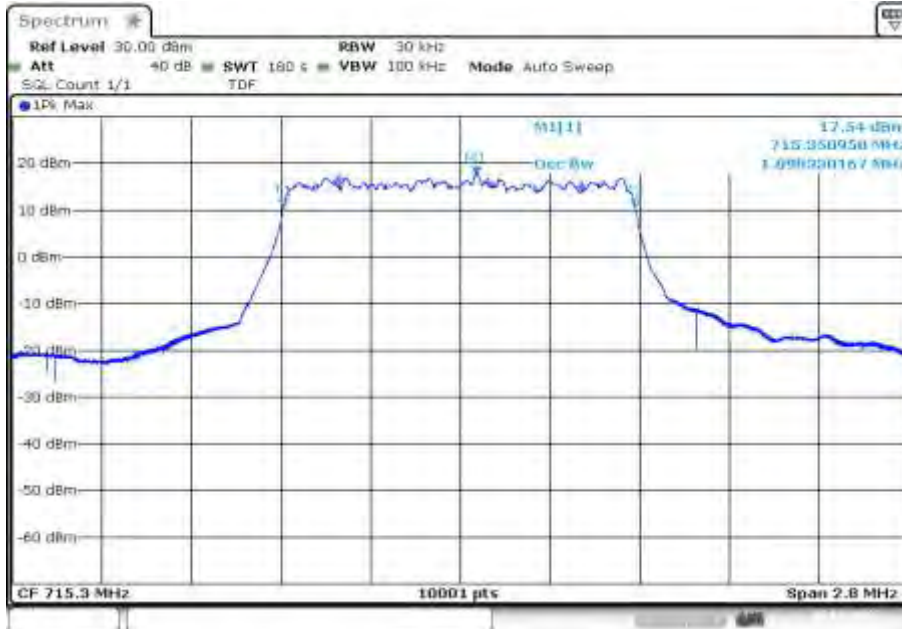

Date: 23.FEB.2022 12:39:23

**Plot 6: high channel, -26 dBc OBW**



Date: 23.FEB.2022 12:42:33



**Plots: 16-QAM**

**Plot 1: low channel, 99% OBW**

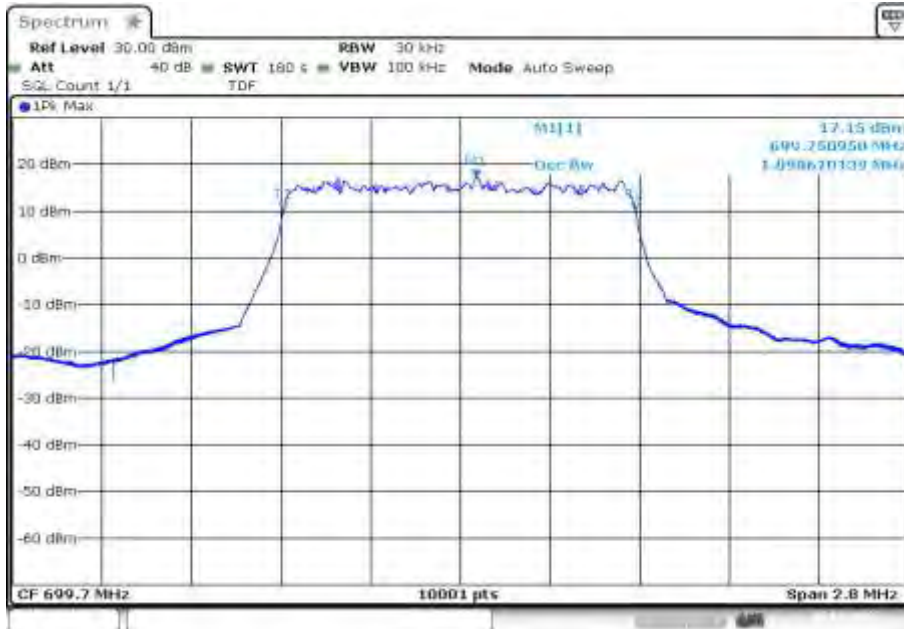

Date: 23.FEB.2022 11:34:20

**Plot 2: low channel, -26 dBc OBW**



Date: 23.FEB.2022 11:37:31

**Plot 3:** mid channel, 99% OBW



Date: 23.FEB.2022 11:53:43

**Plot 4:** mid channel, -26 dBc OBW



Date: 23.FEB.2022 11:56:54

**Plot 5: high channel, 99% OBW**



Date: 23.FEB.2022 12:51:38

**Plot 6: high channel, -26 dBc OBW**



Date: 23.FEB.2022 12:54:48

## 15.5 Results LTE band 13

The EUT was set to transmit the maximum power.

### 15.5.1 RF output power

#### Description:

This paragraph contains average power, peak output power and EIRP measurements for the mobile station. In all cases, the peak output power is within the required mask (this mask is specified in the JTC standards, TIA PN3389 Vol. 1 Chap 7, and is no FCC requirement).

#### Measurement:

The mobile was set up for the maximum output power with pseudo random data modulation.

To determine the Peak-To-Average Power Ratio (PAPR) the measurement was performed with the Power Complementary Cumulative Distribution Function (CCDF).

Measurement parameters	
Detector:	Sample
AQT:	See plot
Resolution bandwidth:	1 MHz
Used equipment:	See chapter 7.4 setup A
Measurement uncertainty:	See chapter 9
Measurement procedure	FCC: § 2.1046 ISED: RSS-Gen, 6.12

#### Limits:

FCC	ISED
§ 27.50(b)(10)	RSS-130, 4.6.1 & 4.6.3
Portable stations (hand-held devices) transmitting in the 746-757 MHz, 776-788 MHz, and 805-806 MHz bands are limited to 3 watts ERP.	<p>4.6.1: The transmitter output power shall be measured in terms of average power. In addition, the peak-to-average power ratio (PAPR) of the transmitter shall not exceed 13 dB for more than 0.1% of the time and shall use a signal corresponding to the highest PAPR during periods of continuous transmission.</p> <p>4.6.3: The e.r.p. shall not exceed 30 watts for mobile equipment and outdoor fixed subscriber equipment. The e.r.p. shall not exceed 3 watts for portable equipment and indoor fixed subscriber equipment.</p>
Power: <b>34.77 dBm ERP</b> PAPR: <b>13 dB</b> (ISED only)	

**Results:**

Output Power (conducted)						
Bandwidth (MHz)	Frequency (MHz)	Resource block allocation	Average Output Power (dBm) QPSK	Peak to Average Ratio (dB)	Average Output Power (dBm) 16-QAM	Peak to Average Ratio (dB)
5	23205 / 779.5	1 RB low	19.5	4.5	20.1	4.8
		1 RB high	19.7	4.4	20.1	4.8
		100% RB	18.5	5.0	17.7	6.0
	23230 / 782	1 RB low	20.2	4.2	20.0	4.8
		1 RB high	20.1	4.3	19.9	4.8
		100% RB	18.7	5.0	17.8	6.0
	23255 / 784.5	1 RB low	20.2	4.3	20.5	4.6
		1 RB high	20.0	4.3	20.3	4.7
		100% RB	18.8	5.0	17.9	5.9
10	23230 / 782	1 RB low	19.9	4.3	20.4	4.7
		1 RB high	19.6	4.4	20.3	4.7
		100% RB	18.7	4.9	18.9	5.7

The radiated output power is measured in the mode with the highest conducted output power.

Output Power (ERP)			
Bandwidth (MHz)	Frequency (MHz)	Average Output Power (dBm) QPSK	Average Output Power (dBm) 16-QAM
5	779.5	14.5	14.9
	782.0	14.9	14.7
	784.5	14.7	15.0
10	782.0	14.7	15.2

## 15.5.2 Frequency stability

### Description:

In order to measure the carrier frequency under the condition of AFC lock, it is necessary to make measurements with the mobile station in a "call mode". This is accomplished with the use of a R&S CMW500 DIGITAL RADIOCOMMUNICATION TESTER.

1. Measure the carrier frequency at room temperature.
2. Subject the mobile station to overnight soak at -30 C.
3. With the mobile station, powered with  $V_{nom}$ , connected to the CMW500 and in a simulated call on channel 1412 (center channel), measure the carrier frequency. These measurements should be made within two minutes of powering up the mobile station, to prevent significant self warming.
4. Repeat the above measurements at 10°C increments from -30°C to +50°C. Allow at least 1.5 hours at each temperature, unpowered, before making measurements.
5. Re-measure carrier frequency at room temperature with  $V_{nom}$ . Vary supply voltage from  $V_{min}$  to  $V_{max}$ , in 0.1 Volt steps re-measuring carrier frequency at each voltage. Pause at  $V_{nom}$  for 1.5 hours unpowered, to allow any self heating to stabilize, before continuing.
6. At all temperature levels hold the temperature to +/- 0.5°C during the measurement procedure.

This measurement was performed with the highest channel bandwidth supported from the EUT on the middle channel

### Measurement:

Measurement parameters	
Detector:	Measured with CMW500
Sweep time:	
Video bandwidth:	
Resolution bandwidth:	
Span:	
Trace-Mode:	
Used equipment:	See chapter 7.4 setup A
Measurement uncertainty:	See chapter 9
Measurement procedure	FCC: § 2.1055 ISED: RSS-Gen, 6.11

### Limits:

FCC	ISED
§ 27.54	RSS-130, 4.5
The frequency stability shall be sufficient to ensure that the fundamental emissions stay within the authorized bands of operation.	The frequency stability shall be sufficient to ensure that the occupied bandwidth remains within each frequency block range when tested at the temperature and supply voltage variations specified in RSS-Gen.

**Results:**

**FREQ ERROR versus VOLTAGE**

Voltage (V)	Frequency Error (Hz)	Frequency Error (ppm)
3.2	-60	-0.0767
3.6	-60	-0.0767
4.0	-60	-0.0767

**FREQ ERROR versus TEMPERATURE**

Temperature (°C)	Frequency Error (Hz)	Frequency Error (ppm)
-30	32	0.0409
-20	31	0.0396
-10	27	0.0345
± 0	16	0.0205
10	19	0.0243
20	-60	-0.0767
30	-39	-0.0499
40	-30	-0.0384
50	-37	-0.0473

**Additional measurements for RSS-130 (4.3 b)**

$f_L = 777.065216 \text{ MHz}$	$f_H = 783.636096 \text{ MHz}$
$f_L - (\text{max freq. error}) = 777.065156 \text{ MHz}$	$f_H + (\text{max freq. error}) = 783.636156 \text{ MHz}$

### 15.5.3 Spurious emissions radiated

#### Description:

The following steps outline the procedure used to measure the radiated emissions from the mobile station. The site is constructed in accordance with ANSI C63.4:2014 requirements and is recognized by the FCC to be in compliance for a 3 and a 10 meter site. The spectrum was scanned from 30 MHz to the 10th harmonic of the highest frequency generated within the equipment, which is the transmitted carrier that can be as high as 782 MHz. Measured up to 8 GHz. The resolution bandwidth is set as outlined in Part 27.53. The spectrum was scanned with the mobile station transmitting at carrier frequencies that pertain to low, mid and high channels of the LTE band 13.

#### Measurement:

Measurement parameters	
Detector:	Peak / RMS
Sweep time:	2 sec.
Resolution bandwidth:	1 MHz
Video bandwidth:	3 MHz
Span:	100 MHz Steps
Trace mode:	Max Hold
Used equipment:	See chapter
Measurement uncertainty:	See chapter 9
Measurement procedure	FCC: § 2.1053 ISED: RSS-Gen, 6.13

#### Limits:

FCC	ISED
§ 27.53(c)	RSS-130, 4.7.1
(c) For operations in the 746-758 MHz band and the 776-788 MHz band, the power of any emission outside the licensee's frequency band(s) of operation shall be attenuated below the transmitter power (P) within the licensed band(s) of operation, measured in watts, in accordance with the following: (c)(2) On any frequency outside the 776-788 MHz band, the power of any emission shall be attenuated outside the band below the transmitter power (P) by at least $43 + 10 \log (P)$ dB.	The unwanted emissions in any 100 kHz bandwidth on any frequency outside the low frequency edge and the high frequency edge of each frequency block range(s), shall be attenuated below the transmitter power, P (dBW), by at least $43 + 10 \log_{10} p$ (watts), dB. However, in the 100 kHz band immediately outside of the equipment's frequency block range, a resolution bandwidth of 30 kHz may be employed.
<b>-13 dBm</b>	



**Results:**

**QPSK**

SPURIOUS EMISSION LEVEL					
LOWEST CHANNEL		MIDDLE CHANNEL		HIGHEST CHANNEL	
Spurious emissions	Level [dBm]	Spurious emissions	Level [dBm]	Spurious emissions	Level [dBm]
-/-		1564	-36.8 PP	-/-	
			-43.2 RMS		
		2346	-41.7 PP		
			-46.2 RMS		

**16-QAM**

SPURIOUS EMISSION LEVEL					
LOWEST CHANNEL		MIDDLE CHANNEL		HIGHEST CHANNEL	
Spurious emissions	Level [dBm]	Spurious emissions	Level [dBm]	Spurious emissions	Level [dBm]
-/-		1564	-36.2 PP	-/-	
			-43.3 RMS		
		2346	-40.2 PP		
			-44.7 RMS		

**QPSK**

**Plot 1:** Middle channel, up to 30 MHz

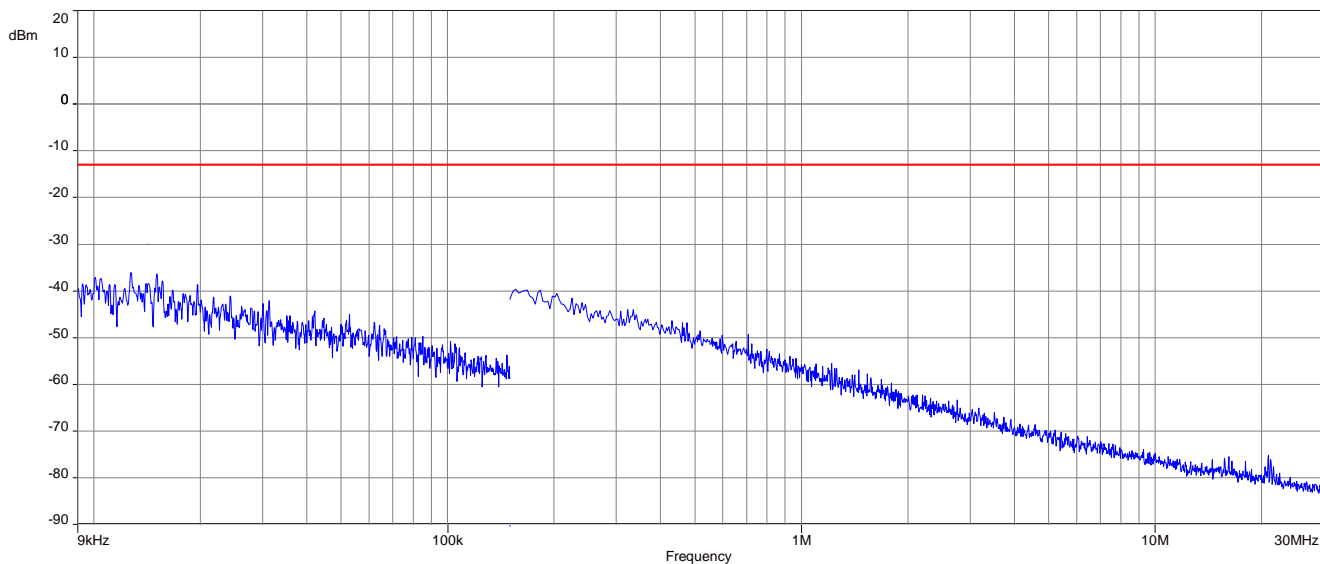

**Plot 2:** Middle channel, 30 MHz to 1 GHz

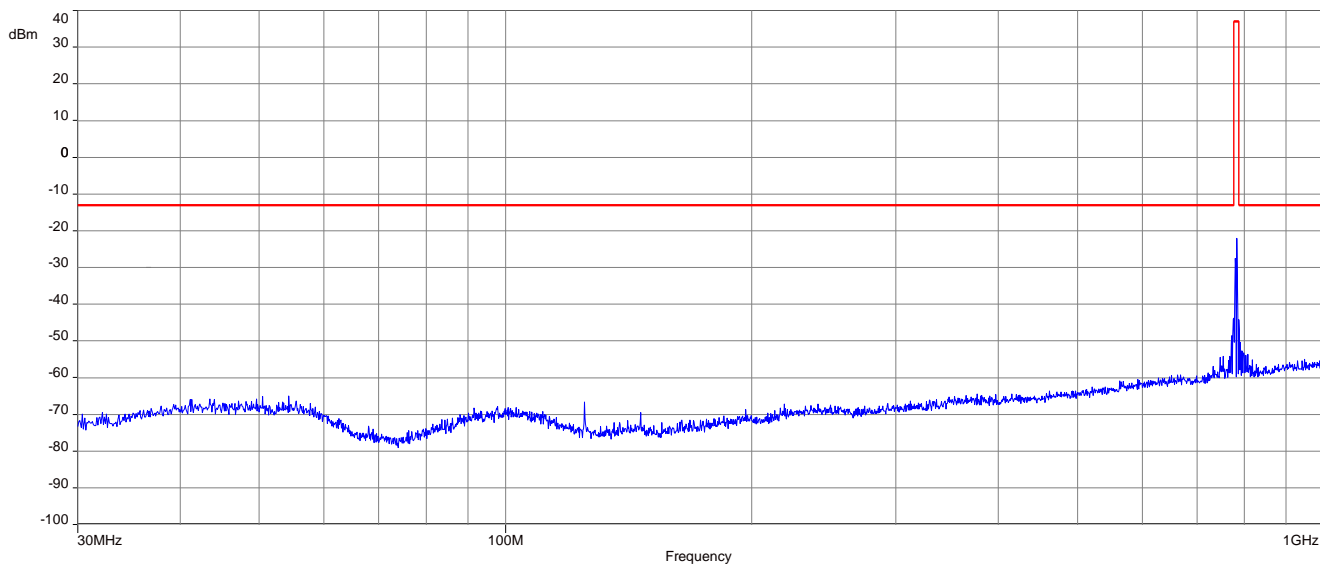

**Plot 3:** Middle channel, 1 MHz to 8 GHz

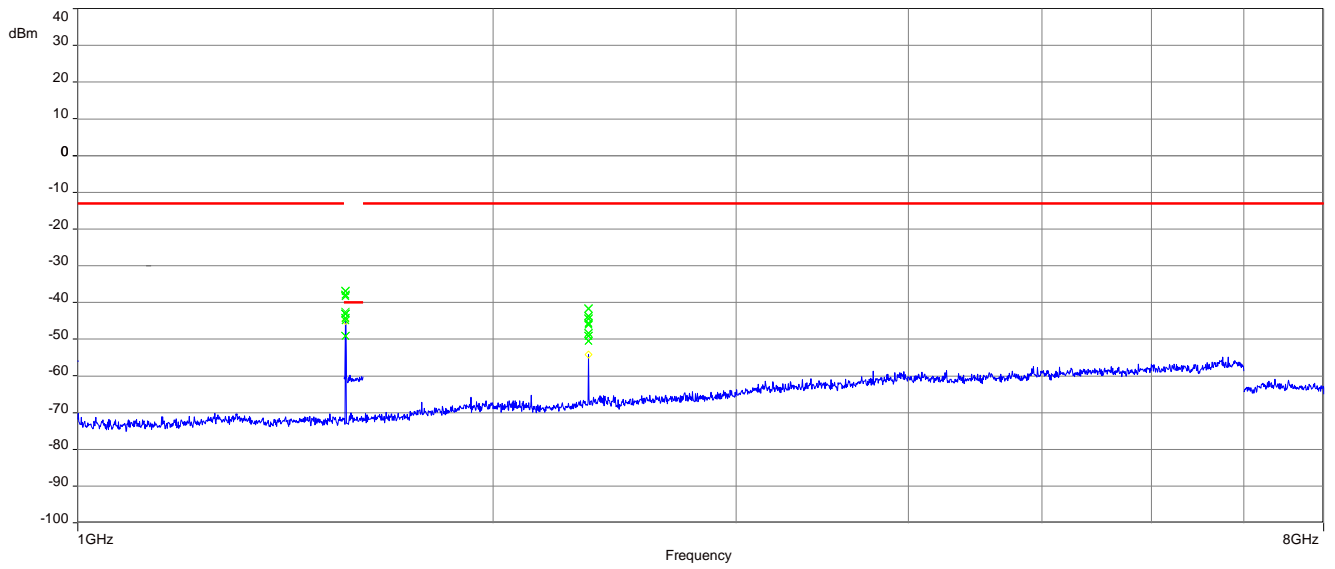

## 16-QAM

**Plot 1:** Middle channel, up to 30 MHz

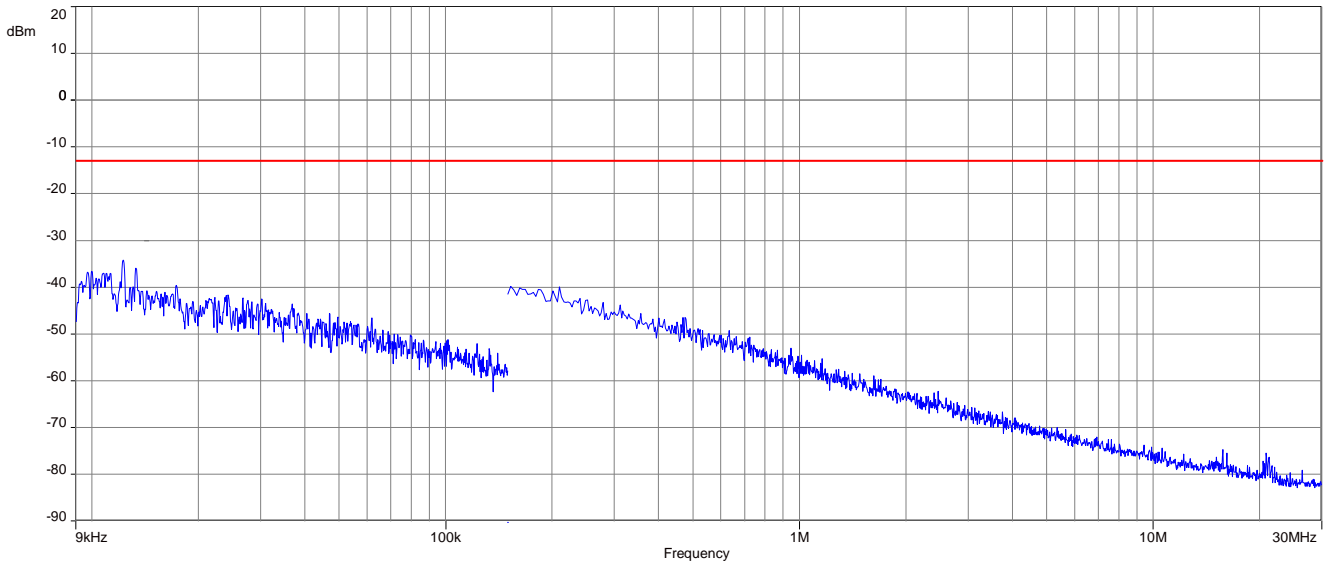

**Plot 2:** Middle channel, 30 MHz to 1 GHz

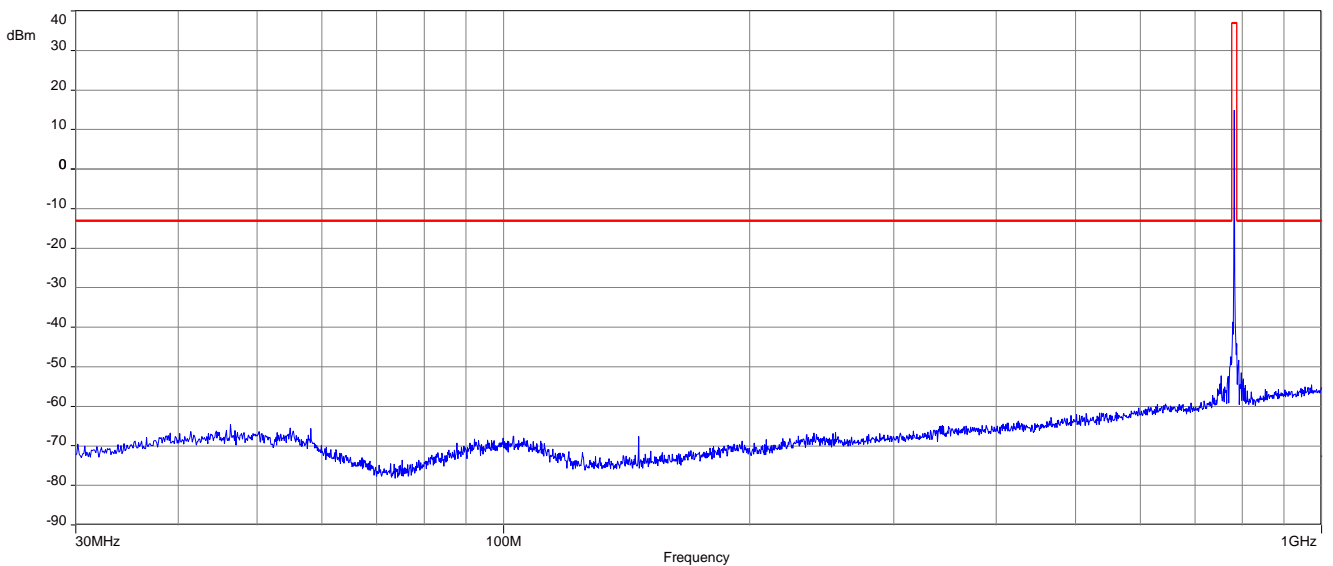

**Plot 3:** Middle channel, 1 MHz to 8 GHz

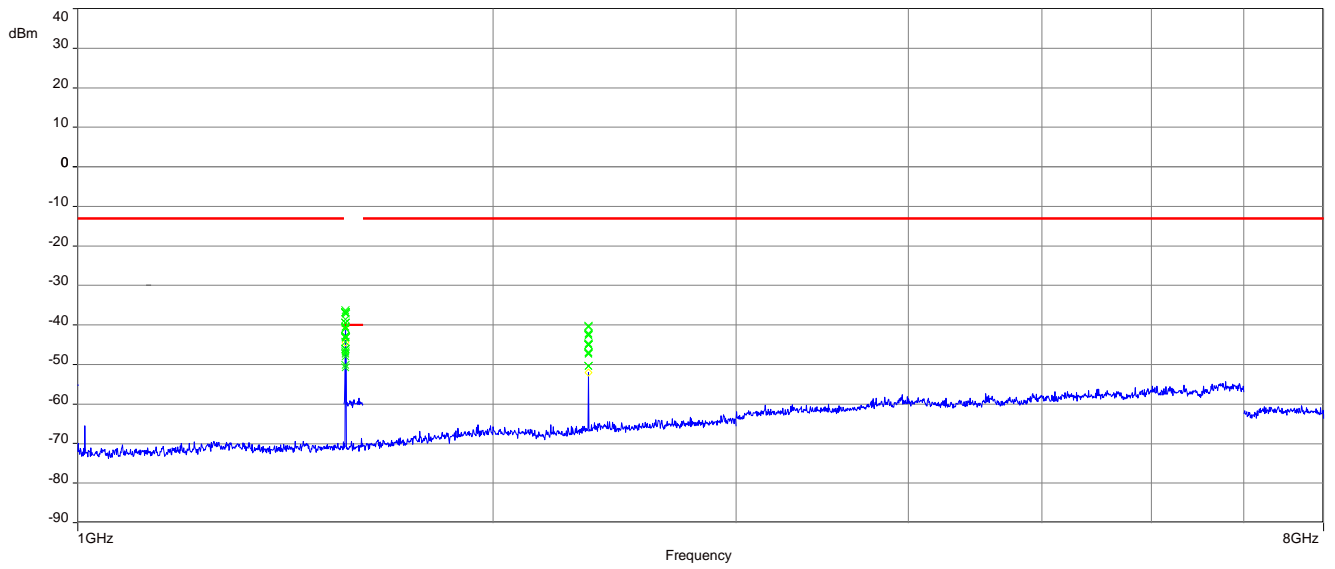

### 15.5.4 Spurious emissions conducted

**Description:**

The following steps outline the procedure used to measure the conducted emissions from the mobile station.

1. Determine frequency range for measurements: From § 2.1057 & RSS-Gen, 6.13.2 the spectrum should be investigated from the lowest radio frequency generated in the equipment up to at least the 10th harmonic of the carrier frequency. For the mobile station equipment tested data taken from 10 MHz to 8 GHz.
2. Determine mobile station transmits frequencies: below outlines the band edge frequencies pertinent to conducted emissions testing.

**Measurement:**

Measurement parameters	
Detector:	Peak
Sweep time:	Auto
Video bandwidth:	300 kHz
Resolution bandwidth:	100 kHz
Span:	10 MHz – 8 GHz
Trace-Mode:	Max Hold
Used equipment:	See chapter 7.4 setup A
Measurement uncertainty:	See chapter 9
Measurement procedure	FCC: § 2.1051 ISED: RSS-Gen, 6.13

**Limits:**

FCC	ISED
§ 27.53(c)	RSS-130, 4.7.1
(c) For operations in the 746-758 MHz band and the 776-788 MHz band, the power of any emission outside the licensee’s frequency band(s) of operation shall be attenuated below the transmitter power (P) within the licensed band(s) of operation, measured in watts, in accordance with the following: (c)(2) On any frequency outside the 776-788 MHz band, the power of any emission shall be attenuated outside the band below the transmitter power (P) by at least $43 + 10 \log (P)$ dB.	The unwanted emissions in any 100 kHz bandwidth on any frequency outside the low frequency edge and the high frequency edge of each frequency block range(s), shall be attenuated below the transmitter power, P (dBW), by at least $43 + 10 \log_{10} p$ (watts), dB. However, in the 100 kHz band immediately outside of the equipment’s frequency block range, a resolution bandwidth of 30 kHz may be employed.
<b>-13 dBm</b>	

**Results:** for 1.4 MHz channel bandwidth

**QPSK**

SPURIOUS EMISSION LEVEL					
LOWEST CHANNEL		MIDDLE CHANNEL		HIGHEST CHANNEL	
Spurious emissions	Level [dBm]	Spurious emissions	Level [dBm]	Spurious emissions	Level [dBm]
1559.0	-	1564.0	-	1569.0	-
2338.5	-	2346.0	-	2353.5	-
3118.0	-	3128.0	-	3138.0	-
3897.5	-	3910.0	-	3922.5	-
4677.0	-	4692.0	-	4707.0	-
5456.5	-	5474.0	-	5491.5	-
6236.0	-	6256.0	-	6276.0	-
7015.5	-	7038.0	-	7060.5	-
7795.0	-	7820.0	-	7845.0	-

**16-QAM**

SPURIOUS EMISSION LEVEL					
LOWEST CHANNEL		MIDDLE CHANNEL		HIGHEST CHANNEL	
Spurious emissions	Level [dBm]	Spurious emissions	Level [dBm]	Spurious emissions	Level [dBm]
1559.0	-	1564.0	-	1569.0	-
2338.5	-	2346.0	-	2353.5	-
3118.0	-	3128.0	-	3138.0	-
3897.5	-	3910.0	-	3922.5	-
4677.0	-	4692.0	-	4707.0	-
5456.5	-	5474.0	-	5491.5	-
6236.0	-	6256.0	-	6276.0	-
7015.5	-	7038.0	-	7060.5	-
7795.0	-	7820.0	-	7845.0	-

**Plots for 1.4 MHz channel bandwidth, QPSK**

**Plot 1:** Lowest channel, 10 MHz to 8 GHz

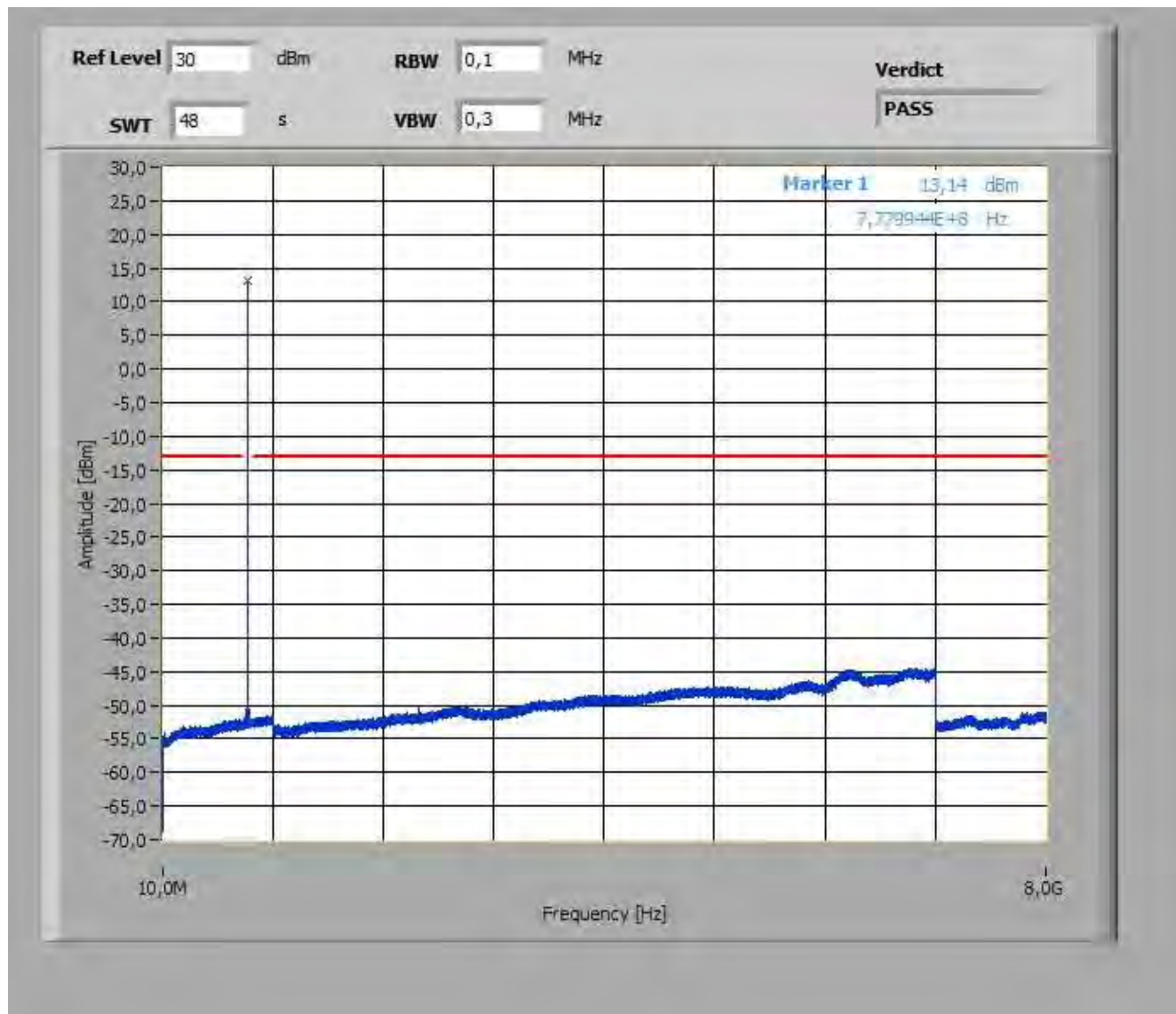



**Plot 2:** Middle channel, 10 MHz to 8 GHz



**Plot 3:** Highest channel, 10 MHz to 8 GHz



**Plots for 1.4 MHz channel bandwidth, 16-QAM**

**Plot 1:** Lowest channel, 10 MHz to 8 GHz

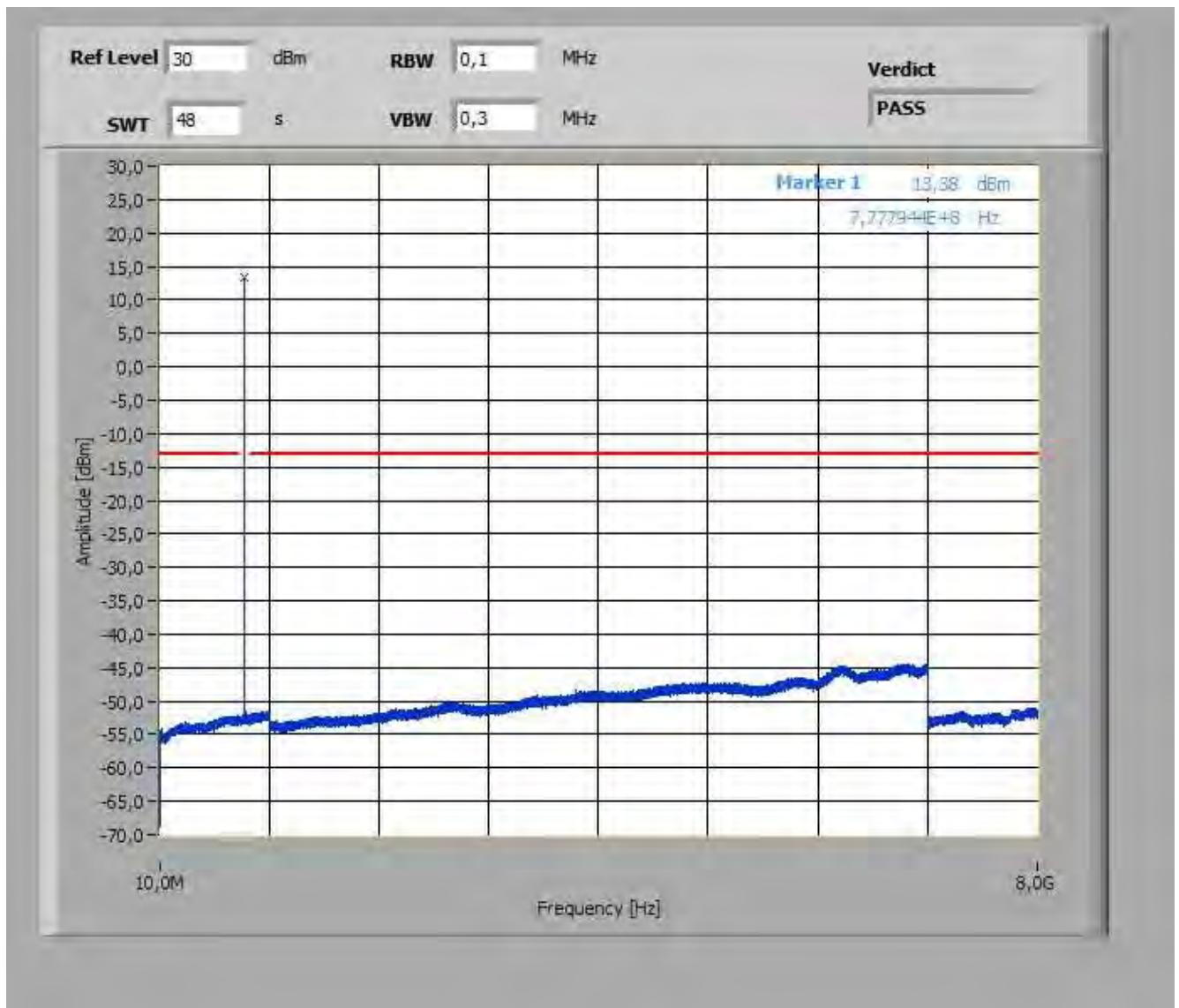

**Plot 2:** Middle channel, 10 MHz to 8 GHz

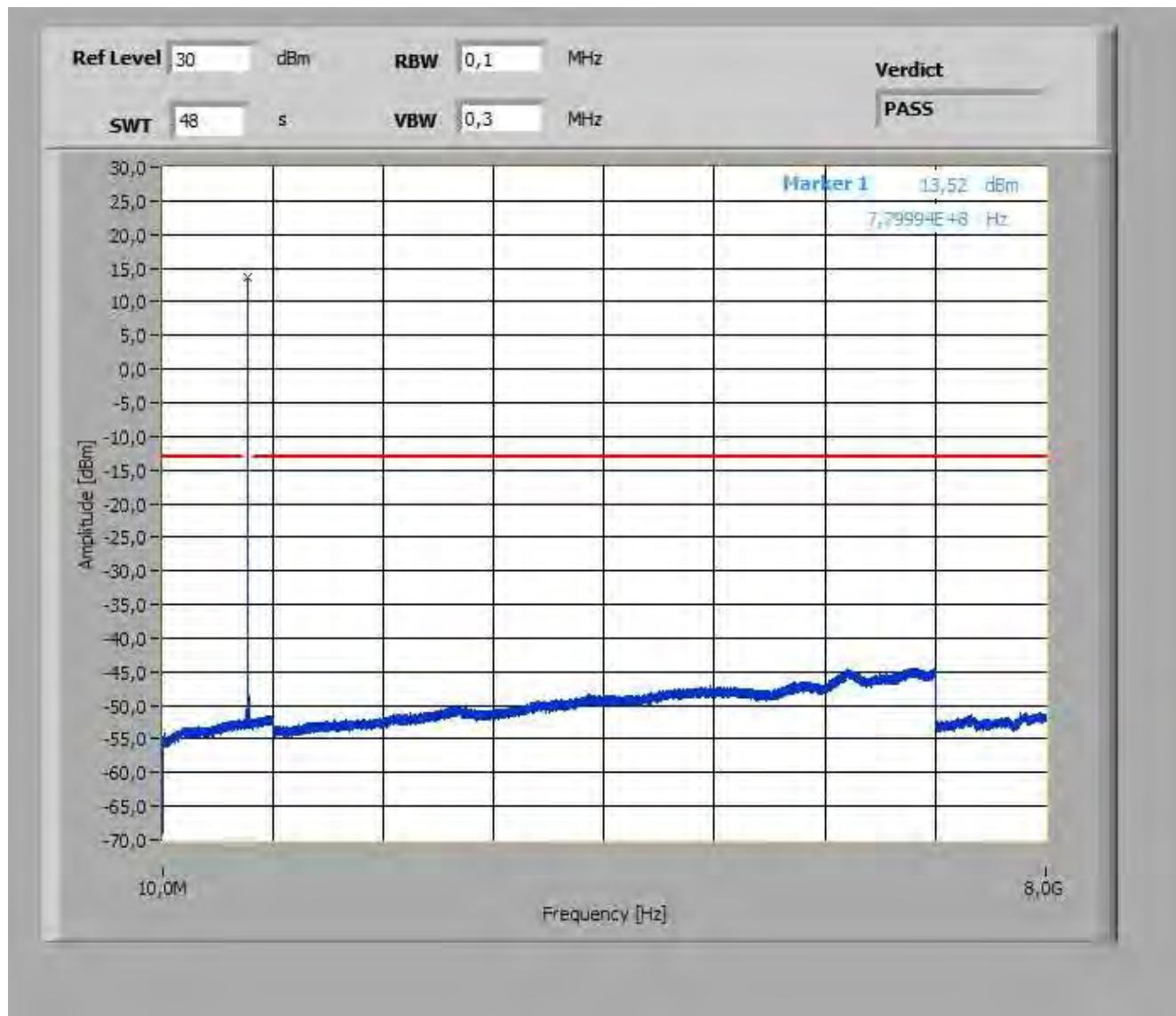

**Plot 3:** Highest channel, 10 MHz to 8 GHz

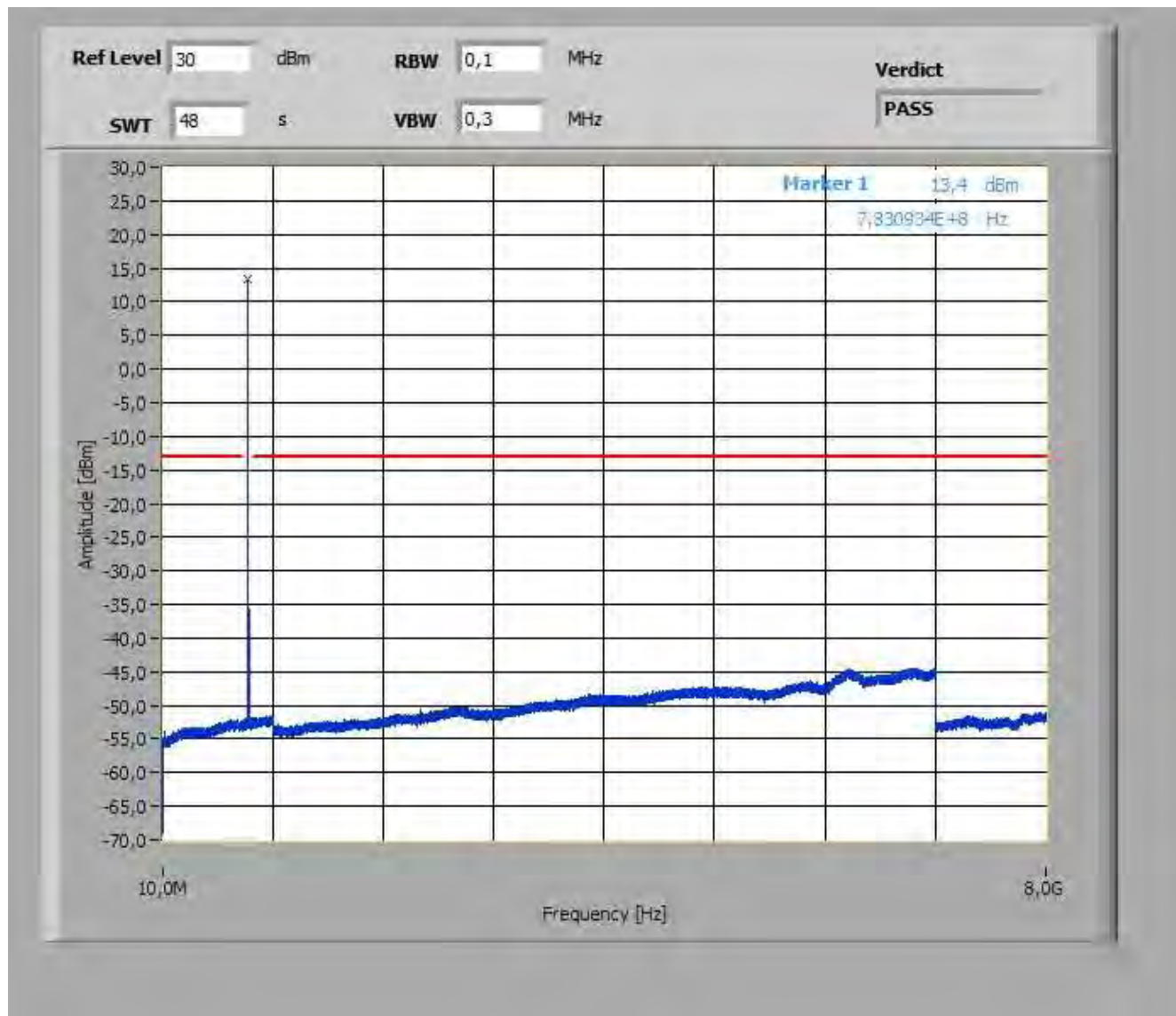

### 15.5.5 Block edge compliance

**Description:**

The spectrum at the band edges must comply with the spurious emissions limits.

**Measurement:**

Measurement parameters	
Detector:	RMS
Sweep time:	180s
Video bandwidth:	300 kHz
Resolution bandwidth:	100 kHz
Span:	1 MHz
Trace-Mode:	Max Hold
Used equipment:	See chapter 7.2 setup A
Measurement uncertainty:	See chapter 9
Measurement procedure	FCC: § 2.1051 ISED: RSS-Gen, 6.13

**Limits:**

FCC	ISED
\$ 27.53(c)	RSS-130, 4.7.1
(c) For operations in the 746-758 MHz band and the 776-788 MHz band, the power of any emission outside the licensee's frequency band(s) of operation shall be attenuated below the transmitter power (P) within the licensed band(s) of operation, measured in watts, in accordance with the following: (c)(2) On any frequency outside the 776-788 MHz band, the power of any emission shall be attenuated outside the band below the transmitter power (P) by at least $43 + 10 \log(P)$ dB.	The unwanted emissions in any 100 kHz bandwidth on any frequency outside the low frequency edge and the high frequency edge of each frequency block range(s), shall be attenuated below the transmitter power, P (dBW), by at least $43 + 10 \log_{10} p$ (watts), dB. However, in the 100 kHz band immediately outside of the equipment's frequency block range, a resolution bandwidth of 30 kHz may be employed.
<b>-13 dBm</b>	
Correction factor according to KDB 890810 if $RBW < 1\%$ emission bandwidth: <input checked="" type="checkbox"/> N/A here <input type="checkbox"/> $10 \log(RBW1/RBW2) = X$ dB; whereas: $RBW1 = Y, RBW2 = Z$	

**Results: 1.4 MHz channel bandwidth**

**Plot 1: Lowest channel, QPSK modulation**

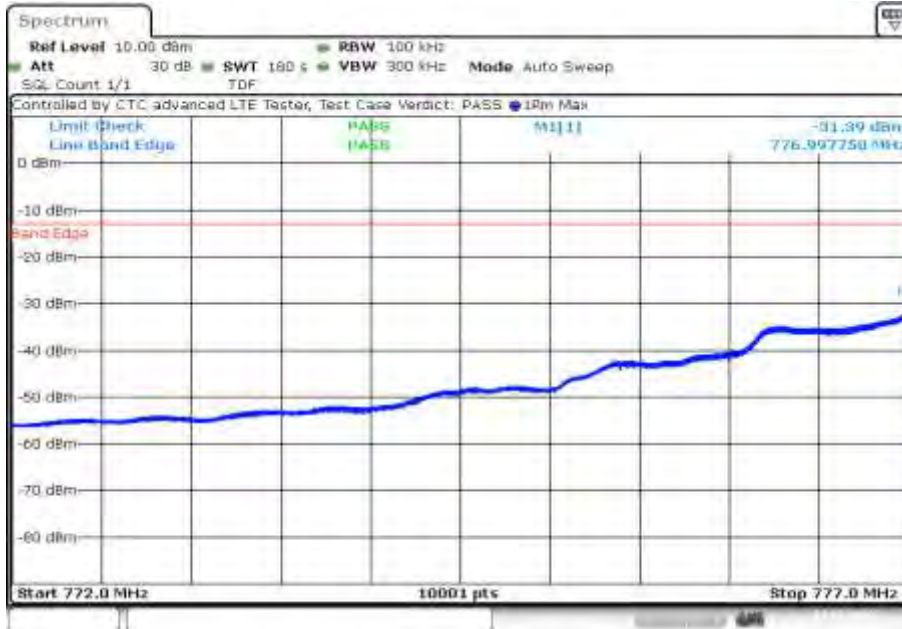

Date: 23.FEB.2022 13:07:17

**Plot 2: Highest channel, QPSK modulation**

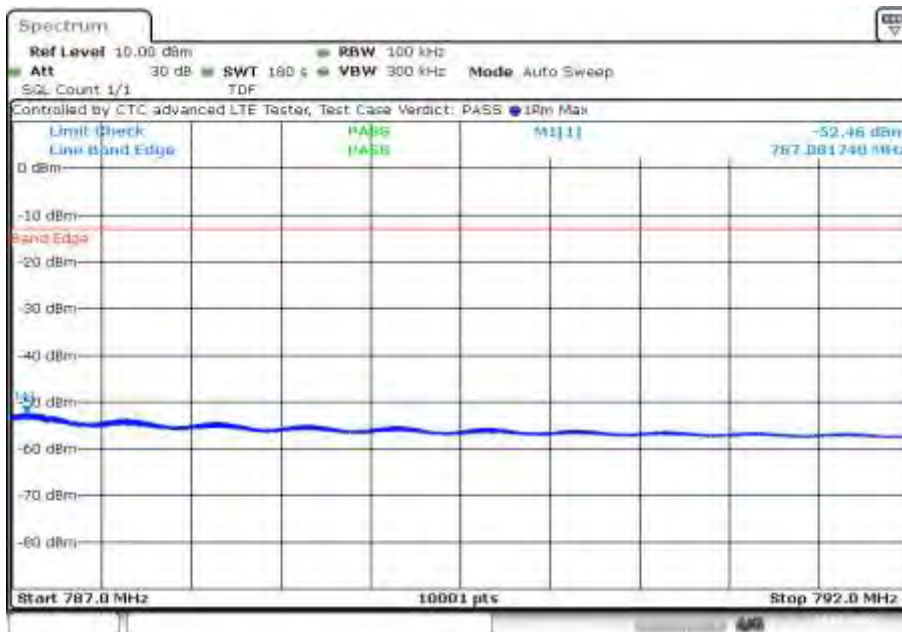

Date: 23.FEB.2022 15:11:48

**Plot 3:** Lowest channel, 16 – QAM modulation

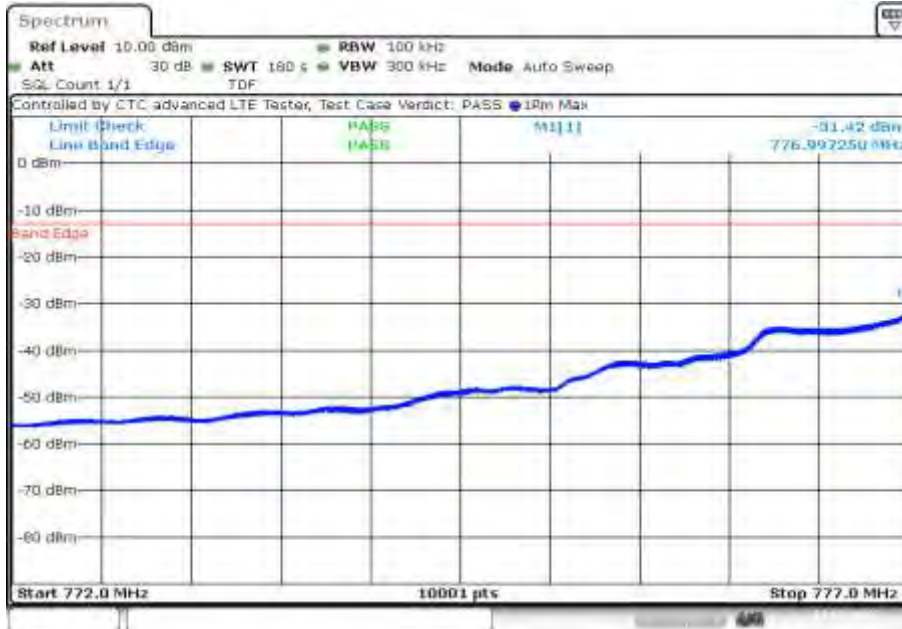

Date: 23.FEB.2022 13:40:27

**Plot 4:** Highest channel, 16 – QAM modulation

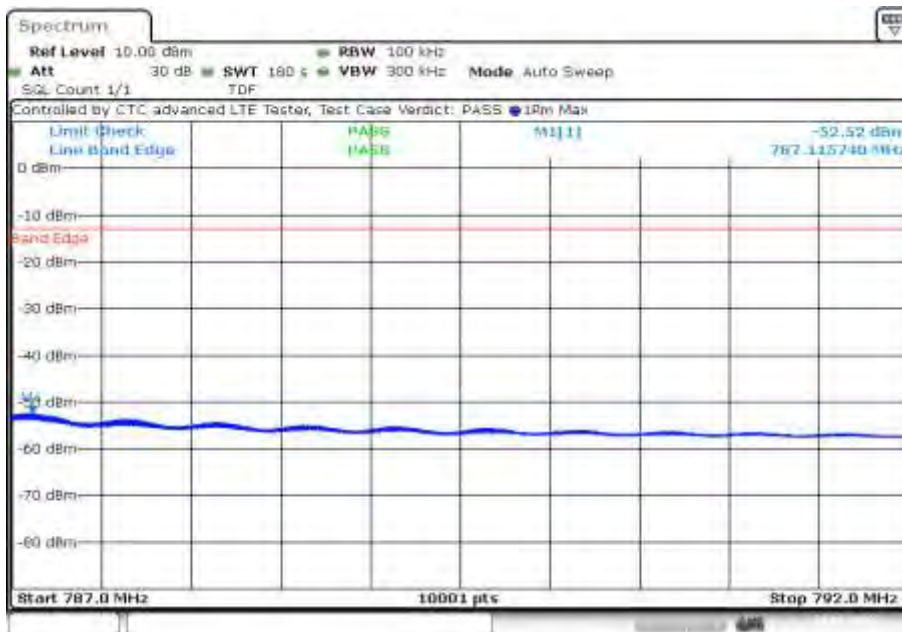

Date: 23.FEB.2022 15:36:28



### 15.5.6 Occupied bandwidth

**Description:**

Measurement of the occupied bandwidth of the transmitted signal.

**Measurement:**

Similar to conducted emissions, occupied bandwidth measurements are only provided for selected frequencies in order to reduce the amount of submitted data. Data were taken at the mid frequencies of the LTE band 13 frequency band. The table below lists the measured 99% power and -26dBc occupied bandwidths. Spectrum analyzer plots are included on the following pages.

Part 27.53 requires a measurement bandwidth of at least 1% of the occupied bandwidth.

Measurement parameters	
Detector:	Peak
Sweep time:	180s
Video bandwidth:	100 kHz
Resolution bandwidth:	300 kHz
Span:	2 x nominal bandwidth
Trace-Mode:	Max Hold
Used equipment:	See chapter 7.4 setup A
Measurement uncertainty:	See chapter 9
Measurement procedure	FCC: § 2.1049 ISED: RSS-Gen, 6.7

**Limits:**

FCC	ISED
§ 2.1049	RSS-Gen, 6.7
Reporting only	

**Results:**

Occupied Bandwidth - QPSK		
Frequency (MHz)	99% OBW (kHz)	-26 dBc BW (kHz)
779.5	1209	1558
782.0	1222	1694
784.5	1218	1677

Occupied Bandwidth – 16-QAM		
Frequency (MHz)	99% OBW (kHz)	-26 dBc BW (kHz)
779.5	1209	1555
782.0	1221	1701
784.5	1219	1681

**Plots: QPSK**

**Plot 1: low channel, 99% OBW**



Date: 23.FEB.2022 13:10:27

**Plot 2: low channel, -26 dBc OBW**

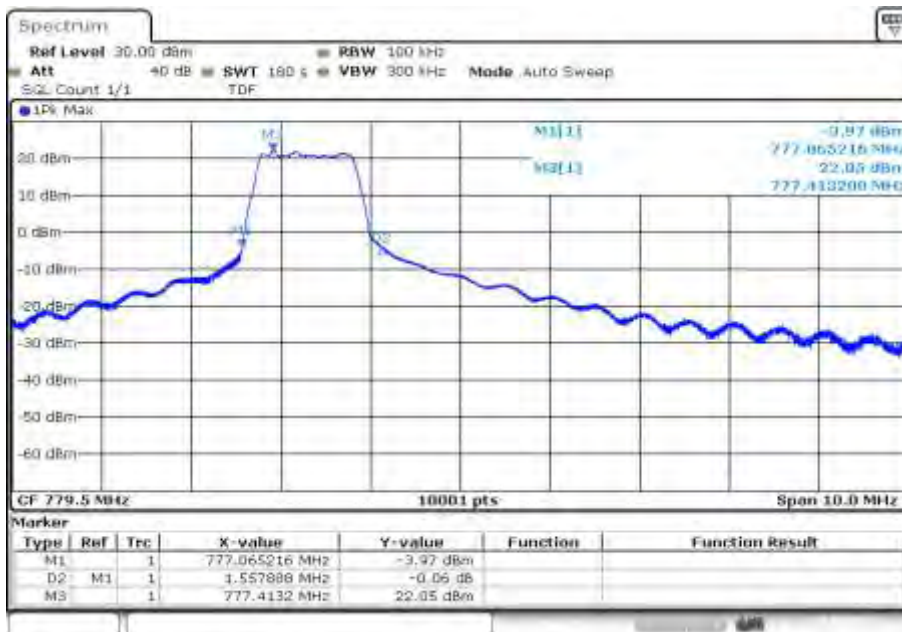

Date: 23.FEB.2022 13:13:37

**Plot 3:** mid channel, 99% OBW



Date: 23.FEB.2022 14:47:12

**Plot 4:** mid channel, -26 dBc OBW



Date: 23.FEB.2022 14:50:21

**Plot 5: high channel, 99% OBW**



Date: 23.FEB.2022 15:14:57

**Plot 6: high channel, -26 dBc OBW**



Date: 23.FEB.2022 15:18:05

**Plots: 16-QAM**

**Plot 1: low channel, 99% OBW**



Date: 23.FEB.2022 13:43:37

**Plot 2: low channel, -26 dBc OBW**



Date: 23.FEB.2022 13:46:47

**Plot 3:** mid channel, 99% OBW



Date: 23.FEB.2022 15:00:51

**Plot 4:** mid channel, -26 dBc OBW

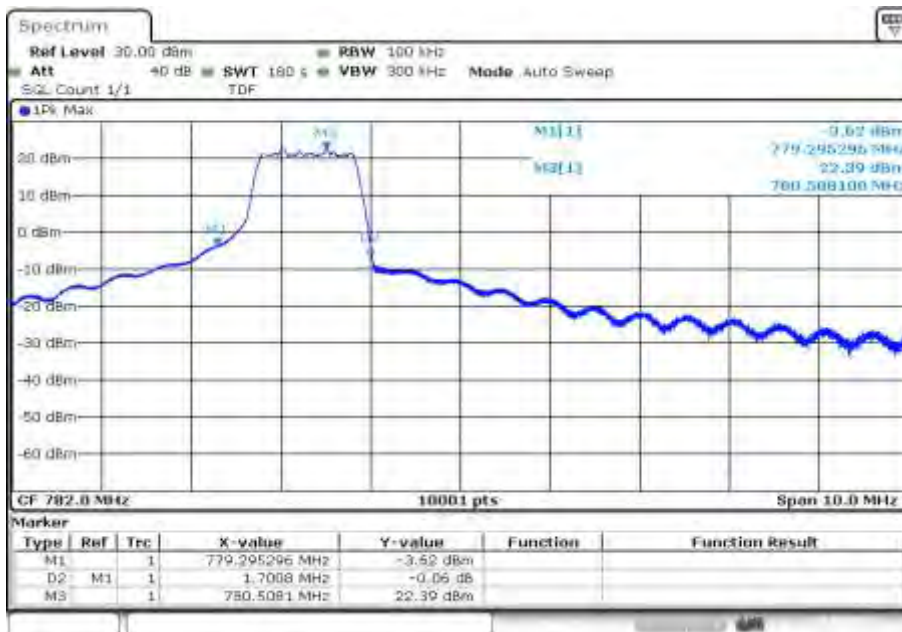

Date: 23.FEB.2022 15:04:00

**Plot 5: high channel, 99% OBW**

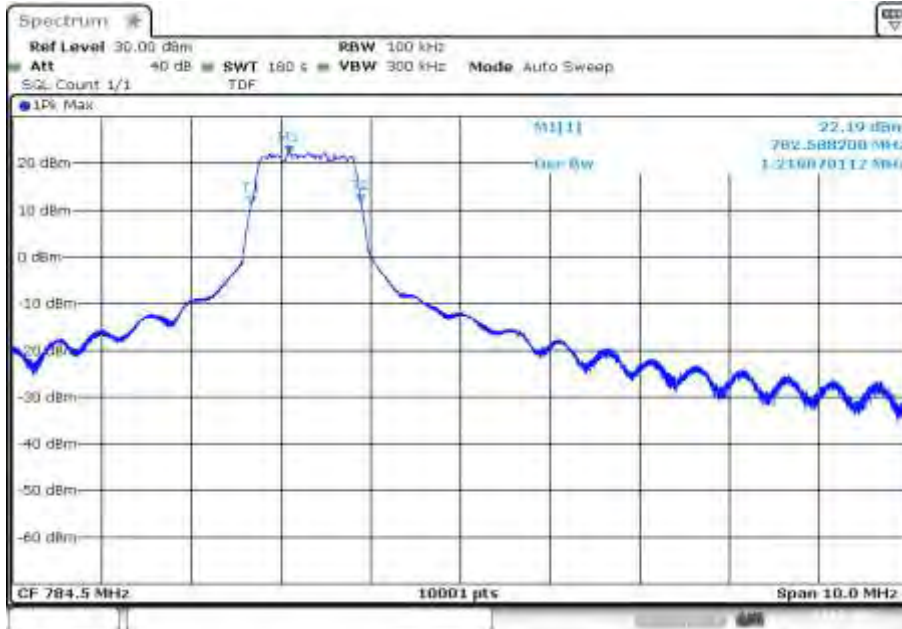

Date: 23.FEB.2022 15:39:36

**Plot 6: high channel, -26 dBc OBW**

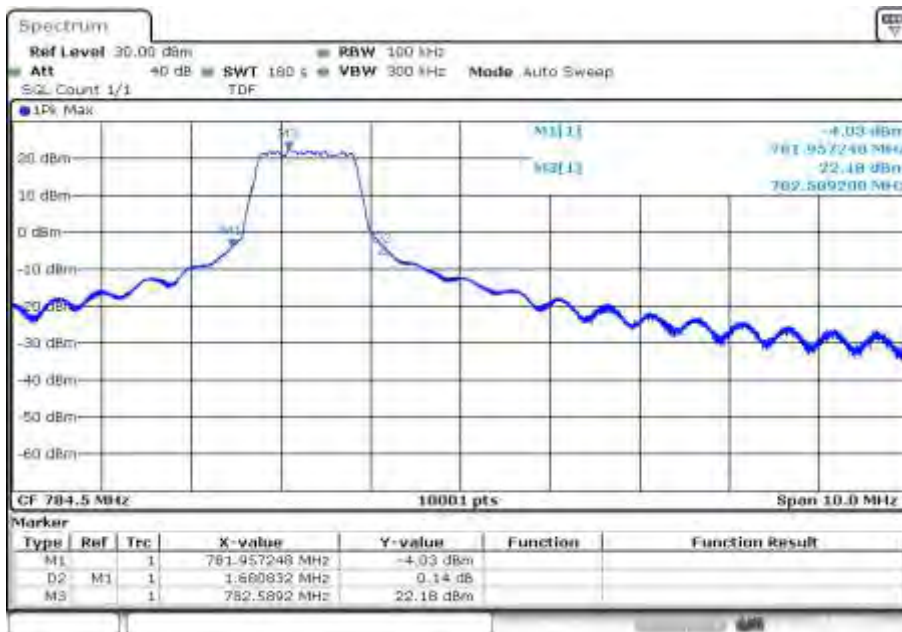

Date: 23.FEB.2022 15:42:45



## 16 Observations

No observations except those reported with the single test cases have been made.

## 17 Glossary

<b>EUT</b>	Equipment under test
<b>DUT</b>	Device under test
<b>UUT</b>	Unit under test
<b>GUE</b>	GNSS User Equipment
<b>ETSI</b>	European Telecommunications Standards Institute
<b>EN</b>	European Standard
<b>FCC</b>	Federal Communications Commission
<b>FCC ID</b>	Company Identifier at FCC
<b>IC</b>	Industry Canada
<b>PMN</b>	Product marketing name
<b>HMN</b>	Host marketing name
<b>HVIN</b>	Hardware version identification number
<b>FVIN</b>	Firmware version identification number
<b>EMC</b>	Electromagnetic Compatibility
<b>HW</b>	Hardware
<b>SW</b>	Software
<b>Inv. No.</b>	Inventory number
<b>S/N or SN</b>	Serial number
<b>C</b>	Compliant
<b>NC</b>	Not compliant
<b>NA</b>	Not applicable
<b>NP</b>	Not performed
<b>PP</b>	Positive peak
<b>QP</b>	Quasi peak
<b>AVG</b>	Average
<b>OC</b>	Operating channel
<b>OCW</b>	Operating channel bandwidth
<b>OBW</b>	Occupied bandwidth
<b>OOB</b>	Out of band
<b>DFS</b>	Dynamic frequency selection
<b>CAC</b>	Channel availability check
<b>OP</b>	Occupancy period
<b>NOP</b>	Non occupancy period
<b>DC</b>	Duty cycle
<b>PER</b>	Packet error rate
<b>CW</b>	Clean wave
<b>MC</b>	Modulated carrier
<b>WLAN</b>	Wireless local area network
<b>RLAN</b>	Radio local area network
<b>DSSS</b>	Dynamic sequence spread spectrum
<b>OFDM</b>	Orthogonal frequency division multiplexing
<b>FHSS</b>	Frequency hopping spread spectrum
<b>GNSS</b>	Global Navigation Satellite System
<b>C/N<sub>0</sub></b>	Carrier to noise-density ratio, expressed in dB-Hz

## 18 Document history

Version	Applied changes	Date of release
-/-	Initial release	2022-04-14

## 19 Accreditation Certificate – D-PL-12076-01-04

first page	last page
<p>The first page of the accreditation certificate includes the DAkkS logo, the name 'Deutsche Akkreditierungsstelle GmbH', and states it is restricted according to Section 8 subsection 1 AkkStellG. It mentions the accreditation is for Mutual Recognition Signatory for the Multilateral Agreements of EA, IAC and IAF for Mutual Recognition. The accreditation is for 'Telecommunication (TC) and Electromagnetic Compatibility (EMC) for Canadian Standards'. The certificate number is D-PL-12076-01-04.</p>	<p>The last page of the certificate provides contact information for Deutsche Akkreditierungsstelle GmbH, including office addresses in Berlin, Frankfurt am Main, and Bonn. It also contains a disclaimer stating that the accreditation is subject to the joint agreement by DAkkS, IAF, and IAC, and is limited to the unchanged State of reference dissemination of the cover sheet by the conformity assessment body mentioned therein.</p>

**Note: The current certificate annex is published on the websites (link see below).**

<https://www.dakks.de/files/data/as/pdf/D-PL-12076-01-04e.pdf>

or

[https://ctcadvanced.com/app/uploads/2020/06/D-PL-12076-01-04\\_Canada\\_TCEMC.pdf](https://ctcadvanced.com/app/uploads/2020/06/D-PL-12076-01-04_Canada_TCEMC.pdf)

**20 Accreditation Certificate – D-PL-12076-01-05**

first page	last page
 <p>The image shows the first page of the accreditation certificate. It features the DAKKS logo (Deutsche Akkreditierungsstelle GmbH) and the company name 'CTC advanced GmbH'. The text indicates accreditation according to Section 8 subsection 1 of the Accreditation Act (AAkStellG) in connection with Section 1 subsection 1 of the AAkStellG-GVV. The accreditation is for 'Telekommunikation (FCC Requirements)'. The certificate number is D-PL-12076-01-05. A signature is visible at the bottom right.</p>	 <p>The image shows the last page of the accreditation certificate. It contains contact information for Deutsche Akkreditierungsstelle GmbH, including three office addresses: Berlin, Frankfurt am Main, and Bonn. It also includes a disclaimer stating that the accreditation is not a guarantee of quality and that the certificate is not a contract. The accreditation was granted pursuant to the Act on the Accreditation Body (AAkStellG) of 31 July 2009.</p>

**Note: The current certificate annex is published on the websites (link see below).**

<https://www.dakks.de/files/data/as/pdf/D-PL-12076-01-05e.pdf>

or

[https://ctcadvanced.com/app/uploads/2020/06/D-PL-12076-01-05\\_TCB\\_USA.pdf](https://ctcadvanced.com/app/uploads/2020/06/D-PL-12076-01-05_TCB_USA.pdf)

##### END OF TEST REPORT #####