

The alarm clock radio speaker system

Model Name: B11 Pro



**B11 Pro** Alarm Clock Radio Speaker System for iPhone

Lightning Connector

Bluetooth



Limited



homtime.com

Homtime 美时



## Safety

1	Features	1
2	Standard Configuration	1
3	Technology Specifications	2
4	Buttons /Display Indications	3
4.1	Main unit	3
4.2	Remote control	4
4.3	LCD Display	5
5	Setting and operation	5
5.1	Battery Installation	5
5.2	Power adaptor Connecting	6
5.3	Standby and power on	6
5.4	Time Setting	6
5.5	Syncing up time with Apple devices	7
5.6	Alarm clock Setting	7
5.6.1	Alarm clock Time Setting	7
5.6.2	Alarm clock Volume	9
5.6.3	SNOOZE	9
5.6.4	Alarm clock turn-off	9
5.6.5	Alarm clock duration and relive automatically	9
5.6.6	Alarm clock time memory	9

6	Playing music	10
6.1	DOCK playing mode	10
6.2	USB1 playing mode	11
6.3	Bluetooth playing mode	12
6.4	AUX IN playing mode	13
7	Hands-free calls	14
8	FM radio	14
9	Charging for smart devices	14
10	SLEEP Function	15
11	LCD light adjustment	15
12	MUTE	15
13	RESET quickly	15

**Safety Information**

**IMPORTANT:**



Please read all safety instructions before proceeding.

The answers to must set up and performance questions can be found in this manual. If you have any further questions about the operation or use of this product, please contact our customer service team for assistance before returning it to the place of purchase.

**IMPORTANT SAFETY INSTRUCTIONS**

- All safety and operation instructions should be read thoroughly before attempting to operate this unit
- Please keep this handbook for future reference
- All warning on this unit and in the operating instructions should be adhere to
- All operating and use instructions should be followed
- To prevent the risk of electric shock, do not remove the cover or back. Please refer all serving to qualified service personnel
- Do not expose the unit to liquid or solvent
- Do not expose the unit to temperature or humidity extremes, direct sunlight, excessive dust, or vibrations
- If cleaning is required, use a soft dry cloth. If necessary, please use a damp cloth without solvent
- Please do not place the unit near a fluorescent or neon light.



- 
- Although the unit are magnetically shielded, please keep the magnetic memory medium (eg: disks or tapes) at least four inches away from the unit to avoid data loss
  - If cleaning is required, use a soft dry cloth. If necessary, please use a damp cloth without solvent
  - Please do not place the unit near a fluorescent or neon light.
  - Although the unit are magnetically shielded, please keep the magnetic memory medium (eg: disks or tapes) at least four inches away from the unit to avoid data loss
  - **WARNING:** To reduce the risk of fire or electric shock, do not expose the unit to rain or moisture
  - Use only this approved power supply, otherwise it may cause danger
  - Only use attachments/accessories specifies by the manufacturer

## 1 Product Features

- Playing music by Apple lightning USB socket or USB cable, compatible with all apple products.
- FM Radio with 20 stations storage
- Built-in Bluetooth, playing music without wire connections
- Bluetooth hands-free calls
- Double USB charging jack, 2A output (support iPad), charging three devices simultaneously
- Clock, top socket can synchronize with iphone
- Easy alarm clock, Snooze
- LCD display
- Infrared Remote control
- 3.5mm AUX IN
- High Sense touch-key

## 2 Standard Configuration

(Please check the accessories included in this package after purchasing)

◎ Unit	1pc	◎ Remote control	1pc
◎ AC Adaptor	1pc	◎ User Manual	1pc
◎ AUX IN cable	1pc	◎ Warranty Card	1pc
◎ 3V Button Batteries	2pcs		

### 3 Technology Specifications

Connecting: Lightning Connector  
Output Power: 5W+5W  
Size: 148x122x118mm  
Net weight: 0.93Kg  
Power Adaptor: 100-240V 50/60Hz DC 12V 3A  
Cable: 3.5MM jack audio cable  
Frequency: 70Hz ~ 20KHz  
S/N Ratio: > 70dB  
Distortion: < 1%



## 4 Product buttons and display

### 4.1 Unit

#### • Front View /Back View

- ① Top knob: Sound Volume/ turn-on/ turn-off/ light-dimmer/ Snooze/Alarm time setting/Reset
- ② Apple Lightning Connector
- ③ USB1: Apple Playing, charging
- ④ USB2: Charging(2A)
- ⑤ AUX IN jack
- ⑥ Fm external antenna
- ⑦ TIME setting
- ⑧ + time adjustment
- ⑨ - time adjustment
- ⑩ Adaptor DC socket

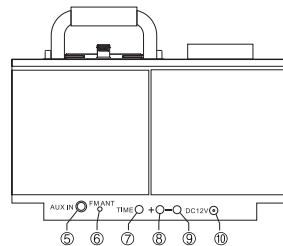
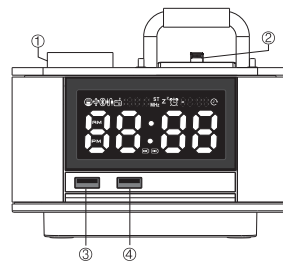



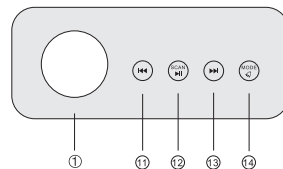

#### • Top buttons

- ⑪ Fast backward/ previous song
- ⑫ Play/Pause/Scan
- ⑬ Fast forward/ next song
- ⑭ Mode selection order(cycle):



-DOCK—USB1—Bluetooth—AUX—Fm-Alarm clock setting

4.2 Remote control

- ⑮  Turn-on/off
- ⑯ "Mode"selection and alarm clock button
- ⑰ "TUN+"Fm mode, short press to backward searching, long press to backward searching automatically
- ⑱ Scan and Store stations under Fm mode
- ⑲ "TUN"Under Fm mode, short press to forward searching, long press to forward searching automatically
- ⑳  LCD light Adjustment
- ㉑  Alarm clock setting
- ㉒ "SNOOZE"
- ㉓ "SLEEP"
- ㉔ "MUTE"
- ㉕  Long press fast forward/ short press next song
- ㉖  Play/Pause
- ㉗  Long press fast backward/ short press previous song
- ㉘ "+"Adjust volume louder,Time setting, Adjust time
- ㉙ Time setting,Adjust time
- ㉚ "-"Adjust volume lower,Time setting,Adjust time setting
- ㉛ "RESET "

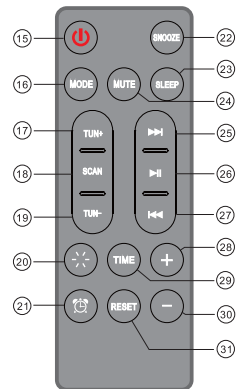

4.3 LCD display

- ③② Clock display(Hour)
- ③③ Clock display(Minute)
- ③④ USB1 audio input playing mode
- ③⑤ Lightning Connector Socket audio input playing mode
- ③⑥ Bluetooth playing mode
- ③⑦ AUX IN playing mode
- ③⑧ 188.8 ST MHz Fm radio mode, frequency display Cancel the second number after decimal. If the actual tuning channel is 0.05, it will be show 0.1 on the screen.
- ③⑨ 12H display mode: AM/PM
- ④① SNOOZE
- ④② Alarm clock
- ④③ Sleep
- ④④ USB1 charging icon
- ④⑤ USB2 charging icon

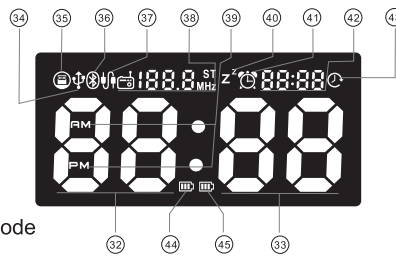

5 Settings and operation

5.1 Backup battery installation

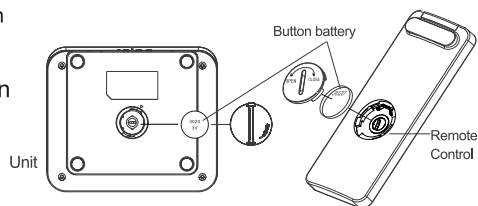

### 5.2 Power on

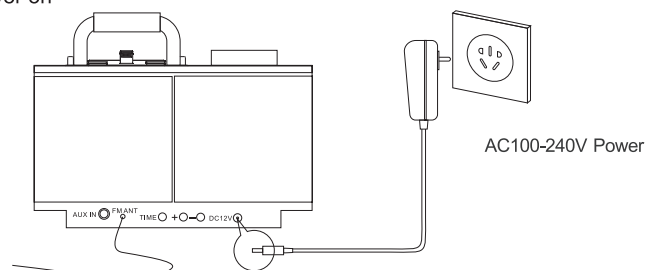

### 5.3 Standby and turn-on

After power on, the unit standby, time and alarm clock (if start) display on the LCD. Press the knob to turn on, the light of touch key and LCD display.

Long press knob ① to turn off, the light of touch key disappears, LCD only displays time and the unit is in standby.

### 5.4 Time setting

#### • Setting time by unit buttons

Under turn-on/off status, press ⑦ once to set time, you can change the display from 12H to 24H **24 hr** by pressing ⑧、⑨. Press again to adjust, the first flash is hours, press ⑧ "+" or ⑨ "-" keys to adjust the time and press ⑦ once again to confirm hour's setting. The next flash is minute, operation method as the previous one. The setting will be automatically stored in 10 seconds.

- Setting time by remote control

Under turn-on/off status, press "TIME" once on the remote control to set time, you can change the display from 12H to 24H by pressing (29), (30). Press "TIME" again to adjust, the first flash is hours, press "+" or "-" keys to adjust the time and press "TIME" once again to confirm hour's setting. The next flash is minute, operation method as the previous one. The setting will be automatically stored in 10 seconds.

#### 5.5 Syncing up time with Apple device

Turn on the unit, put your iPhone to (2) Lightning Connector socket, the unit will synchronize up time with iPhone, there will be sound and display on the LCD after (F J P u) synchronization.

#### 5.6 Alarm clock setting

##### 5.6.1 Alarm clock time setting

- Setting alarm clock by touch key on the unit





clock turn-on



clock turn-off



Turn on the unit, press  key on the unit, enter the alarm settings; the alarm clock icon  flashing on the LCD and the alarm clock time display on the screen. After entering this mode, After rotating the large knob to select "on" or "off" by pressing the large knob to confirm. If selected "on" then turn on the alarm and enter the alarm time setting, then setting the alarm time. To adjust the tone volume, press "+" or "-"; Press ① again to confirm the setting. If you want to turn off the alarm clock, Press the ① then the unit will change into dock playing mode.

- Setting alarm clock by remote control

Turn on the unit, press the remote control key to enter the alarm setting; the alarm clock icon flashing on the LCD and the alarm clock time display on the screen. After entering this mode, choose "+" or "-" to set the alarm volume on/off, there will be 6 models in built-in tone, dock music tone, USB1 audio tone, FM radio audio tone, alarm clock volume and alarm clock. Press ① after choose the option (built-in tone, dock music tone, USB1 audio tone, radio audio tone ) then setting the alarm time. To adjust the tone volume, press "+" or "-"; Press ① again to confirm the setting. If you want to turn off the alarm clock, Press the ① then the unit will change into dock playing mode.



#### 5.6.2 Alarm clock volume

The volume of the alarm clock will getting louder and louder.

#### 5.6.3 SNOOZE

After the alarm clock rings, the icon will display on the LCD, short press the knob on the unit or "SNOOZE" on the remote control to start the snooze, snooze icon display on the LCD. Alarm clock will be on again in 9-minute snooze.

#### 5.6.4 Turn off the alarm clock

- Turn off the alarm clock quickly

Long press the knob until the icon disappear on the LCD.

The alarm clock is available only one time. It is only valid in 24hours.

Turn off the alarm clock and short press the knob under alarm clock setting mode.

#### 5.6.5 Alarm clock duration and automatic remove





If no operation to remove the alarm, the alarm will be removed automatically in 30mins.

#### 5.6.6 Alarm clock time memory

In order to restart the alarm clock quickly, the unit will keep the record settled in previous time.

## 6 Playing music

### 6.1 DOCK Playing mode



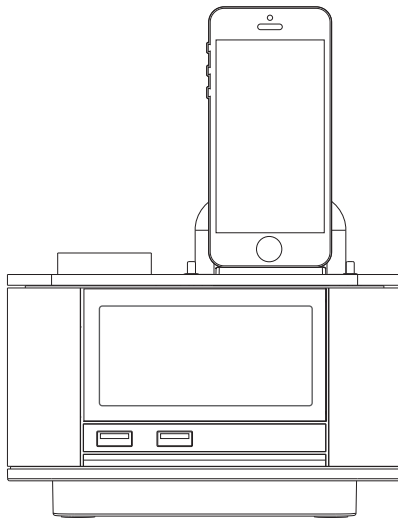



- The initial mode is dock in first time use or restart after turn off the unit. You can choose dock mode by remote control. Then put your iPhone into the Lightning USB socket to play music.
- When playing music: Press  to play or pause on the unit. Short press  is previous song, long press  is fast backward; Short press  is next song, long press  is fast forward; you can adjust the volume by rotating the top knob.





- Operation by remote control: Press ►|| to play or pause on the remote control. Short press ◀◀ is previous song, long press ◀◀ is fast backward; Short press ▶▶ is next song, long press ▶▶ is fast forward; you can adjust the volume by “+”、“-” key

#### 6.2 USB1 Playing mode

- Turn on the unit, press  on the unit or “MODE” key on the remote control to choose USB playing mode, the icon will display on the screen after connecting iPhone/iPod/iPod through digital cable. Before connecting, the icon will just flashing. When playing music, Press  to play or pause on the unit. Short press  is previous song, long press  is fast backward; Short press  is next song, long press  is fast forward; you can adjust the volume by rotating the top knob.
- USB1 socket compatible with iPhone accessories to play music (connecting by digital cable).

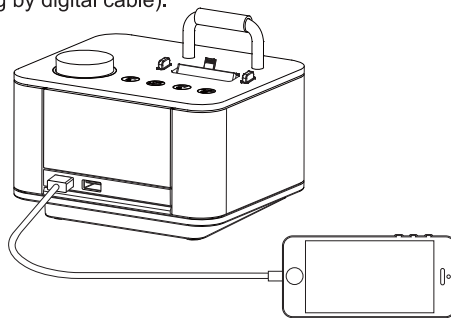







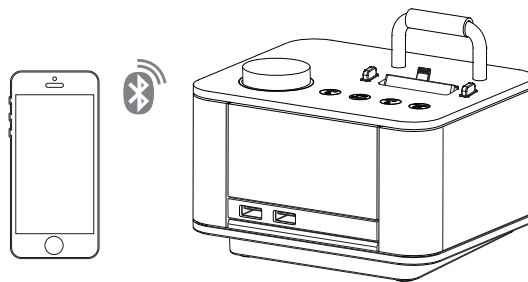

### 6.3 Bluetooth playing mode

- Bluetooth turn-on and connection

Turn on the unit, press  on the unit or "MODE" key on the remote control to choose Bluetooth playing mode, icon flashing indicates the unit does not get connection with iPhone, just turn on the Bluetooth on your iPhone and search the pair name "B11" (no code is needed). After a sound of "DU", the unit is connected with your iPhone and the icon will display on the screen all the time instead of just flashing.



- Playing and control



Through Bluetooth, when playing music, press  to play or pause on the unit. Short press  is previous song, long press  is fast backward; Short press  is next song, long press  is fast forward; you can adjust the volume by rotating the top knob. Operation by remote control: Press  to play or pause on the remote control. Short press  is previous song, long press  is fast backward;

Short press ►► is next song, long press ►► is fast forward; you can adjust the volume by “+”、“-” key.

- Bluetooth disconnection and turn-off

Press  on the unit or “MODE” key on the remote control to change the mode from Bluetooth playing to others, the Bluetooth turn off. The unit can be only connected by one smartphone at one time. If you want to switch the Bluetooth audio player, you need to disconnected the current Bluetooth devices and create a new connection.

#### 6.4 AUX IN playing mode

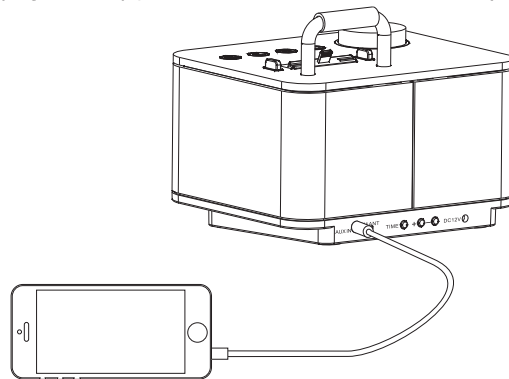

Turn on the unit, press  on the unit or “MODE” key on the remote control to choose AUX IN playing mode, icon  display on the LCD. Playing music by put the 3.5mm cable into the AUX IN jack.









### 7 Hands-free calls

Connecting the unit with smartphone in Bluetooth mode, the hands-free function start when there is a phone call. Short pree the knob to answer the phone and short press again to hang up.

### 8 FM Radio

- Turn on the unit, switch to FM radio mode, long press“SCAN”to auto scan radio station and store the scanned stations accordingly. The frequency starts from 87.5MHz to 108MHz. 20 stations can be stored. Press  and  to select the station.
- If there is a bad connection, please unfold the  FM radio antenna.

### 9 Charging for smart devices

- You can charge your iPhone or other smart handheld devices in any condition as long as the unit is turn om.
- The unit can charge 3pcs iPhones at the same time by jack 、、 The charging state of jack 、 will display on the LCD. After charging finished, the icon  will disappear.
- Jack  USB2 is for fast charging, supporting 2A charging output.



#### 10 SLEEP

When the unit is on, press “SLEEP” on the remote control to set auto-power off time(90,80,70,60,50,40,30,20,10,OFF). It will auto-store the setting in 5 seconds after the setting and turn back to the previous status. To see the remaining sleep time, press “SLEEP”.

#### 11 LCD Light adjustment

- Short press the knob to adjust the Light. It has three different levels.
- When the unit is on or off, press light adjustment key on the remote control to adjust the light.

#### 12 MUTE

Press “MUTE” on the remote control to turn off the sound.

#### 13 RESET

- Press “RESET” on the remote control, reset the mode to dock mode and clear the alarm clock setting. Alarm clock is turned off.
- Press the knob on the unit for more than 8 seconds till “RESET”, alarm clock turn off, reset the mode to dock mode.

**FCC NOTE:**

This device complies with Part 15 of the FCC Rules.

Operation is subject to the following two conditions: (1) this device may not cause harmful interference, and (2) this device must accept any interference received, including interference that may cause undesired operation.

**THE MANUFACTURER IS NOT RESPONSIBLE FOR ANY RADIO OR TV INTERFERENCE CAUSED BY UNAUTHORIZED MODIFICATIONS OR CHANGE TO THIS EQUIPMENT. SUCH MODIFICATIONS OR CHANGE COULD VOID THE USER' S AUTHORITY TO OPERATE THE EQUIPMENT.**

This equipment has been tested and found to comply with the limits for a Class B digital device, pursuant to part 15 of the FCC Rules. These limits are designed to provide reasonable protection against harmful interference in a residential installation. This equipment generates, uses and can radiate radio frequency energy and, if not installed and used in accordance with the instructions, may cause harmful interference to radio communications. However, there is no guarantee that interference will not occur in a particular installation. If this equipment does cause harmful interference to radio or television reception, which can be determined by turning the equipment off and on, the user is encouraged to try to correct the interference by one or more of the following measures:

- Reorient or relocate the receiving antenna.
- Increase the separation between the equipment and receiver.
- Connect the equipment into an outlet on a circuit different from that to which the receiver is connected.
- Consult the dealer or an experienced radio/TV technician for help.