



TEST REPORT

FCC PART 15 SUBPART C 15.247

**Test report
On Behalf of
Migear International Group LLC
For
Bluetooth Speaker
Model No.: BT362, FBT362**

FCC ID: 2AIDL-BT362

Prepared for : Migear International Group LLC
21 West 38th Street, 14th Floor. New York, NY 10018 United States

Prepared By : Shenzhen HUAKE Testing Technology Co., Ltd.
1-2/F., Building B2, Junfeng Zhongcheng Zhizao Innovation Park, Heping, Fuhai Street, Bao'an District, Shenzhen, Guangdong, China

Date of Test: Mar. 28, 2022 ~ Apr. 02, 2022
Date of Report: Apr. 02, 2022
Report Number: HK2203281255-E



TEST RESULT CERTIFICATION

Applicant's name : Migear International Group LLC

Address : 21 West 38th Street, 14th Floor. New York, NY 10018 United States

Manufacture's Name : SHENZHEN YUEYINZHE ELECTRONICS CO.,LTD.

Address : 3 / F, No. 43, Furong Road, Gushu, Bao'an District, Shenzhen, P.R. China.

Factory Name : SHENZHEN JIAHUI YOUPIN ELECTRONIC CO.,LTD.

Address : Floor 2, 92-1, Aobei Village 2, Yuanshan Street, Longgang Shenzhen, P.R. China.

Product description

Trade Mark: 

Product name : Bluetooth Speaker

Model and/or type reference : BT362, FBT362

Standards : **47 CFR FCC Part 15 Subpart C 15.247**

This publication may be reproduced in whole or in part for non-commercial purposes as long as the Shenzhen HUAK Testing Technology Co., Ltd. is acknowledged as copyright owner and source of the material. Shenzhen HUAK Testing Technology Co., Ltd. takes no responsibility for and will not assume liability for damages resulting from the reader's interpretation of the reproduced material due to its placement and context.

Date of Test :

Date (s) of performance of tests : **Mar. 28, 2022 ~ Apr. 02, 2022**

Date of Issue : **Apr. 02, 2022**

Test Result : **Pass**

Prepared by: 

 Project Engineer

Reviewed by: 

 Project Supervisor

Approved by: 

 Technical Director



Table of Contents

Page

1. SUMMARY..... 5

1.1. TEST STANDARDS 5

1.2. TEST DESCRIPTION..... 5

1.3. INFORMATION OF THE TEST LABORATORY 6

1.4. STATEMENT OF THE MEASUREMENT UNCERTAINTY..... 6

2. GENERAL INFORMATION..... 7

2.1. ENVIRONMENTAL CONDITIONS 7

2.2. GENERAL DESCRIPTION OF EUT 7

2.3. DESCRIPTION OF TEST MODES AND TEST FREQUENCY 8

2.4. EQUIPMENTS USED DURING THE TEST 9

2.5. RELATED SUBMITTAL(S) / GRANT (S) 10

2.6. MODIFICATIONS 10

2.7. DESCRIPTION OF TEST SETUP 10

3. TEST CONDITIONS AND RESULTS 11

3.1. CONDUCTED EMISSIONS TEST 11

3.2. RADIATED EMISSIONS AND BAND EDGE 14

3.3. MAXIMUM PEAK CONDUCTED OUTPUT POWER 25

3.4. 20dB BANDWIDTH 26

3.5. FREQUENCY SEPARATION 29

3.6. NUMBER OF HOPPING FREQUENCY 31

3.7. TIME OF OCCUPANCY (DWELL TIME) 33

3.8. OUT-OF-BAND EMISSIONS 36

3.9. PSEUDORANDOM FREQUENCY HOPPING SEQUENCE 43

3.10. ANTENNA REQUIREMENT 44

4. TEST SETUP PHOTOS OF THE EUT 45

5. PHOTOS OF THE EUT 47

The results shown in this test report refer only to the sample(s) tested unless otherwise stated and the sample(s) are retained for 30 days only. The document is issued by HUAK, this document cannot be reproduced except in full with our prior written permission. The more details and the authenticity of the report will be confirmed at <http://www.cer-mark.com>.

TEL : +86-755 2302 9901 FAX : +86-755 2302 9901 E-mail : service@cer-mark.com

Add: 1-2F., Building B2, Junfeng Zhongcheng Zhizao Innovation Park, Heping Community, Fuhai Street, Bao'an District, Shenzhen, Guangdong, China



**** Modified History ****

Revision	Description	Issued Data	Remark
Revision 1.0	Initial Test Report Release	Apr. 02, 2022	Jason Zhou



1. SUMMARY

1.1. TEST STANDARDS

The tests were performed according to following standards:

FCC Rules Part 15.247: Frequency Hopping, Direct Spread Spectrum and Hybrid Systems that are in operation within the bands of 902-928 MHz, 2400-2483.5 MHz, and 5725-5850 MHz

ANSI C63.10:2013 : American National Standard for Testing Unlicensed Wireless Devices

1.2. Test Description

FCC PART 15.247		
FCC Part 15.207	AC Power Conducted Emission	PASS
FCC Part 15.215	20dB Bandwidth& 99% Bandwidth	PASS
FCC Part 15.247(d)	Spurious RF Conducted Emission	PASS
FCC Part 15.247(b)	Maximum Peak Output Power	PASS
FCC Part 15.247 (a) (1)	Pseudorandom Frequency Hopping Sequence	PASS
FCC Part 15.247(a)(1)(iii)	Number of hopping frequency& Time of Occupancy	PASS
FCC Part 15.247(a)(1)	Frequency Separation	PASS
FCC Part 15.205/15.209	Radiated Emissions	PASS
FCC Part 15.247(d)	Band Edge Compliance of RF Emission	PASS



1.3. Information of the Test Laboratory

Shenzhen HUAKE Testing Technology Co., Ltd.
Add.: 1-2/F., Building B2, Junfeng Zhongcheng Zhizao Innovation Park, Heping, Fuhai Street, Bao'an District, Shenzhen, Guangdong, China

Testing Laboratory Authorization :

A2LA Accreditation Code is 4781.01.
FCC Designation Number is CN1229.
Canada IC CAB identifier is CN0045.
CNAS Registration Number is L9589.

1.4. Statement of the measurement uncertainty

The data and results referenced in this document are true and accurate. The reader is cautioned that there may be errors within the calibration limits of the equipment and facilities. The measurement uncertainty was calculated for all measurements listed in this test report acc. to CISPR 16 - 4 "Specification for radio disturbance and immunity measuring apparatus and methods – Part 4: Uncertainty in EMC Measurements" and is documented in the Shenzhen HUAKE Testing Technology Co., Ltd. quality system acc. to DIN EN ISO/IEC 17025. Furthermore, component and process variability of devices similar to that tested may result in additional deviation. The manufacturer has the sole responsibility of continued compliance of the device.

Hereafter the best measurement capability for HUAKE laboratory is reported:

Test	Measurement Uncertainty	Notes
Transmitter power conducted	±0.37dB	(1)
Transmitter power Radiated	±3.35dB	(1)
Conducted spurious emission 9KHz-40 GHz	±2.20dB	(1)
Occupied Bandwidth	±3.68%	(1)
Radiated Emission 30~1000MHz	±3.90dB	(1)
Radiated Emission Above 1GHz	±4.28dB	(1)
Conducted Disturbance0.15~30MHz	±2.71dB	(1)

(1) This uncertainty represents an expanded uncertainty expressed at approximately the 95% confidence level using a coverage factor of k=2.



2. GENERAL INFORMATION

2.1. Environmental conditions

During the measurement the environmental conditions were within the listed ranges:

Normal Temperature:	25°C
Relative Humidity:	55 %
Air Pressure:	101 kPa

2.2. General Description of EUT

Product Name:	Bluetooth Speaker
Model/Type reference:	BT362
Series Model:	FBT362
Model Difference:	All model's the function, software and electric circuit are the same, only with a product color, model named different. Test sample model: BT362
Power supply:	DC 5V 1A From Micro USB or DC 3.7V From Battery
Version:	Supported EDR
Modulation:	GFSK, π/4DQPSK
Operation frequency:	2402MHz~2480MHz
Channel number:	79
Channel separation:	1MHz
Antenna type:	PCB Antenna
Antenna gain:	0dBi
Hardware Version:	V1.0
Software Version:	V1.0

Note: For more details, refer to the user's manual of the EUT.



2.3. Description of Test Modes and Test Frequency

The Applicant provides communication tools software to control the EUT for staying in continuous transmitting and receiving mode for testing.

There are 79 channels provided to the EUT and Channel 00/39/78 was selected for testing.

Operation Frequency :

Channel	Frequency (MHz)
00	2402
01	2403
⋮	⋮
38	2440
39	2441
40	2442
⋮	⋮
77	2479
78	2480

Note: The line display in grey were the channel selected for testing

Preliminary tests were performed in each mode and packet length of BT, and found worst case as bellow, finally test were conducted at those mode and recorded in this report.

Test Items	Worst case
Conducted Emissions	DH5 Middle channel
Radiated Emissions and Band Edge	DH5 low channel
Maximum Conducted Output Power	DH5/2DH5
20dB Bandwidth&99% Bandwidth	DH5/2DH5
Frequency Separation	DH5/2DH5 Middle channel
Number of hopping frequency	DH5/2DH5
Time of Occupancy (Dwell Time)	DH1/DH3/DH5 Middle channel 2DH1/2DH3/2DH5 Middle channel
Out-of-band Emissions	DH5/2DH5



2.4. Equipments Used during the Test

Item	Equipment	Manufacturer	Model No.	Serial No.	Last Cal.	Cal. Interval
1.	L.I.S.N. Artificial Mains Network	R&S	ENV216	HKE-002	Feb. 18, 2022	1 Year
2.	Receiver	R&S	ESCI 7	HKE-010	Feb. 18, 2022	1 Year
3.	RF automatic control unit	Tonscend	JS0806-2	HKE-060	Feb. 18, 2022	1 Year
4.	Spectrum analyzer	R&S	FSP40	HKE-025	Feb. 18, 2022	1 Year
5.	Spectrum analyzer	Agilent	N9020A	HKE-048	Feb. 18, 2022	1 Year
6.	Preamplifier	Schwarzbeck	BBV 9743	HKE-006	Feb. 18, 2022	1 Year
7.	EMI Test Receiver	Rohde & Schwarz	ESCI 7	HKE-010	Feb. 18, 2022	1 Year
8.	Bilog Broadband Antenna	Schwarzbeck	VULB9163	HKE-012	Feb. 18, 2022	1 Year
9.	Loop Antenna	Schwarzbeck	FMZB 1519 B	HKE-014	Feb. 18, 2022	1 Year
10.	Horn Antenna	Schwarzbeck	9120D	HKE-013	Feb. 18, 2022	1 Year
11.	Pre-amplifier	EMCI	EMC051845 SE	HKE-015	Feb. 18, 2022	1 Year
12.	Pre-amplifier	Agilent	83051A	HKE-016	Feb. 18, 2022	1 Year
13.	EMI Test Software EZ-EMC	Tonscend	JS1120-B Version	HKE-083	Feb. 18, 2022	N/A
14.	Power Sensor	Agilent	E9300A	HKE-086	Feb. 18, 2022	1 Year
15.	Spectrum analyzer	Agilent	N9020A	HKE-048	Feb. 18, 2022	1 Year
16.	Signal generator	Agilent	N5182A	HKE-029	Feb. 18, 2022	1 Year
17.	Signal Generator	Agilent	83630A	HKE-028	Feb. 18, 2022	1 Year
18.	Shielded room	Shiel Hong	4*3*3	HKE-039	Dec. 09, 2021	3 Year
19.	Power meter	Agilent	E4419B	HKE-085	Feb. 18, 2022	1 Year
20.	Horn Antenna	Schwarzbeck	BBHA 9170	HKE-017	Feb. 18, 2022	1 Year

The calibration interval was one year



2.5. Related Submittal(s) / Grant (s)

This submittal(s) (test report) is intended to comply with Section 15.247 of the FCC Part 15, Subpart C Rules.

2.6. Modifications

No modifications were implemented to meet testing criteria.

2.7. DESCRIPTION OF TEST SETUP

Operation of EUT during conducted testing and radiation below 1GHz testing:

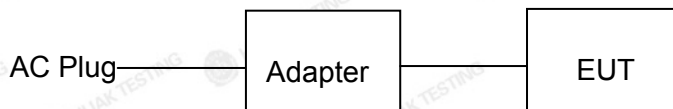

Operation of EUT during radiation above 1GHz testing:



Adapter information

Model: HW-059200CHQ
Input: 100-240V, 50/60Hz, 0.5A
Output: 5VDC, 2A

The sample was placed (0.8m below 1GHz, 1.5m above 1GHz) above the ground plane of 3m chamber. Measurements in both horizontal and vertical polarities were performed. During the test, each emission was maximized by: having the EUT continuously working, investigated all operating modes, rotated about all 3 axis (X, Y & Z) and considered typical configuration to obtain worst position, manipulating interconnecting cables, rotating the turntable, varying antenna height from 1m to 4m in both horizontal and vertical polarizations. The emissions worst-case are shown in Test Results of the following pages. The worst case is X position.

3. TEST CONDITIONS AND RESULTS

3.1. Conducted Emissions Test

LIMIT

According to FCC CFR Title 47 Part 15 Subpart C Section 15.207 and RSS Gen 8.8, AC Power Line Conducted Emissions Limits for Licence-Exempt Radio Apparatus as below:

Frequency range (MHz)	Limit (dBuV)	
	Quasi-peak	Average
0.15-0.5	66 to 56*	56 to 46*
0.5-5	56	46
5-30	60	50

* Decreases with the logarithm of the frequency.

TEST CONFIGURATION

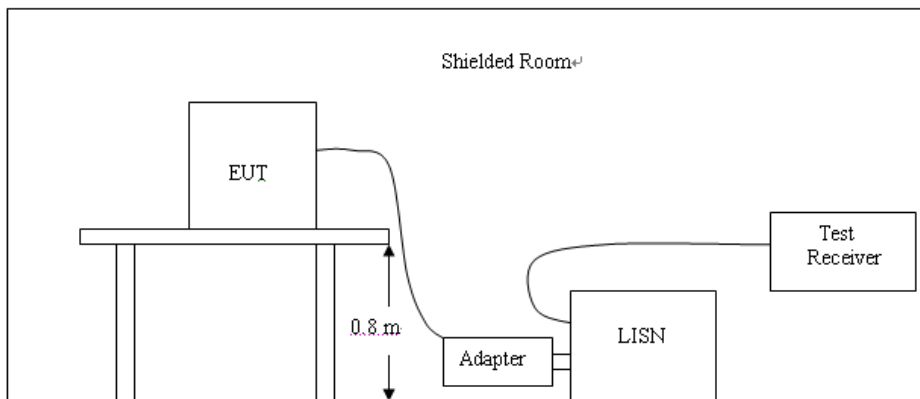

TEST PROCEDURE

1. The equipment was set up as per the test configuration to simulate typical actual usage per the user's manual. The EUT is a tabletop system; a wooden table with a height of 0.8 meters is used and is placed on the ground plane as per ANSI C63.10.
2. Support equipment, if needed, was placed as per ANSI C63.10
3. All I/O cables were positioned to simulate typical actual usage as per ANSI C63.10.
4. The adapter received AC120V/60Hz power through a Line Impedance Stabilization Network (LISN) which supplied power source and was grounded to the ground plane.
5. All support equipments received AC power from a second LISN, if any.
6. The EUT test program was started. Emissions were measured on each current carrying line of the EUT using a spectrum Analyzer / Receiver connected to the LISN powering the EUT. The LISN has two monitoring points: Line 1 (Hot Side) and Line 2 (Neutral Side). Two scans were taken: one with Line 1 connected to Analyzer / Receiver and Line 2 connected to a 50 ohm load; the second scan had Line 1 connected to a 50 ohm load and Line 2 connected to the Analyzer / Receiver.
7. Analyzer / Receiver scanned from 150 KHz to 30MHz for emissions in each of the test modes.
8. During the above scans, the emissions were maximized by cable manipulation.



TEST RESULTS

Remark: All modes of GFSK, Pi/4 DQPSK were test at Low, Middle, and High channel; only the worst result of GFSK High Channel was reported as below:

Test Specification: Line

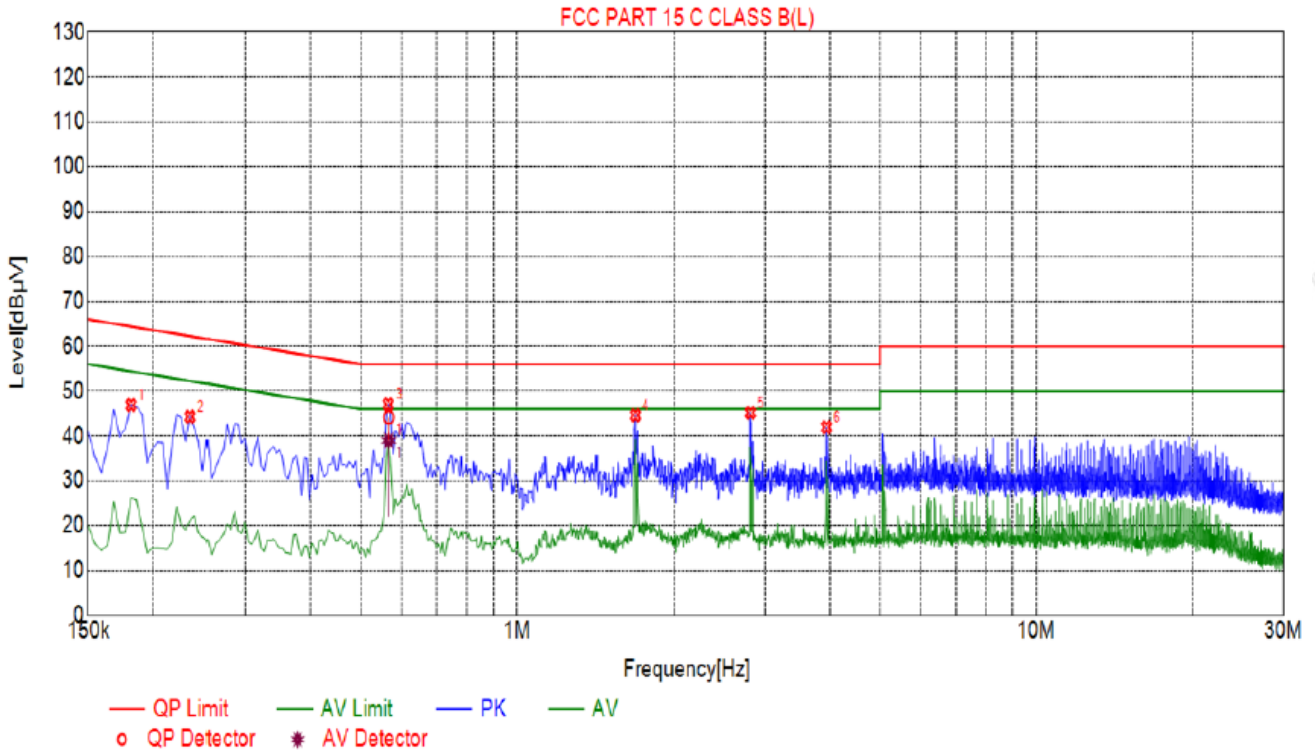

Suspected List								
NO.	Freq. [MHz]	Level [dBµV]	Factor [dB]	Limit [dBµV]	Margin [dB]	Reading [dBµV]	Detector	Type
1	0.1815	46.92	20.06	64.42	17.50	26.86	PK	L
2	0.2355	44.30	20.03	62.25	17.95	24.27	PK	L
3	0.5640	47.05	20.06	56.00	8.95	26.99	PK	L
4	1.6890	44.63	20.13	56.00	11.37	24.50	PK	L
5	2.8140	45.19	20.21	56.00	10.81	24.98	PK	L
6	3.9435	41.96	20.25	56.00	14.04	21.71	PK	L

Final Data List											
NO.	Freq. [MHz]	Correction factor [dB]	QP Value [dBµV]	QP Limit [dBµV]	QP Margin [dB]	QP Reading [dBµV]	AV Value [dBµV]	AV Limit [dBµV]	AV Margin [dB]	AV Reading [dBµV]	Type
1	0.5654	20.06	44.17	56.00	11.83	24.11	39.02	46.00	6.98	18.96	L

Remark: Margin = Limit – Level

Correction factor = Cable lose + LISN insertion loss

Level=Test receiver reading + correction factor



Test Specification: Neutral

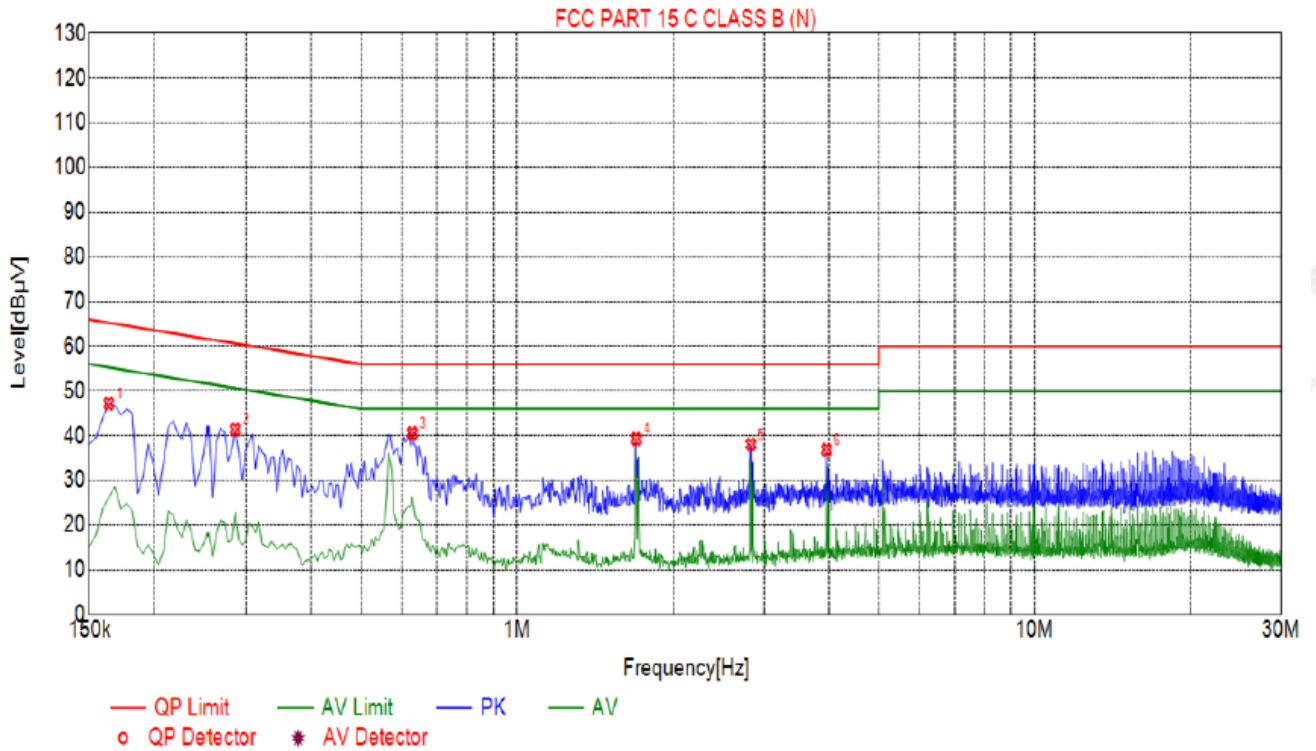

Suspected List								
NO.	Freq. [MHz]	Level [dBµV]	Factor [dB]	Limit [dBµV]	Margin [dB]	Reading [dBµV]	Detector	Type
1	0.1635	47.19	19.98	65.28	18.09	27.21	PK	N
2	0.2850	41.42	20.04	60.67	19.25	21.38	PK	N
3	0.6270	40.59	20.05	56.00	15.41	20.54	PK	N
4	1.6980	39.30	20.13	56.00	16.70	19.17	PK	N
5	2.8275	38.08	20.21	56.00	17.92	17.87	PK	N
6	3.9615	36.88	20.25	56.00	19.12	16.63	PK	N

Remark: Margin = Limit – Level

Correction factor = Cable lose + LISN insertion loss

Level=Test receiver reading + correction factor

3.2. Radiated Emissions and Band Edge

Limit

For intentional device, according to § 15.209(a), the general requirement of field strength of radiated emission out of authorized band shall not exceed the following table at a 3 meters measurement distance.

In addition, radiated emissions which fall in the restricted bands, as defined in §15.205(a), must also comply with the radiated emission limits specified in §15.209(a)

Except when the requirements applicable to a given device state otherwise, emissions from licence-exempt transmitters shall comply with the field strength limits shown in table below.

Additionally, the level of any transmitter emission shall not exceed the level of the transmitter's fundamental emission

Unwanted emissions that fall into restricted bands shall comply with the limits specified in RSS-Gen; and Unwanted emissions that do not fall within the restricted frequency bands shall comply either with the limits specified in the applicable RSS or with those specified in this RSS-Gen.

Radiated emission limits

Frequency (MHz)	Distance (Meters)	Radiated (dBµV/m)	Radiated (µV/m)
0.009-0.49	3	$20\log(2400/F(KHz))+40\log(300/3)$	$2400/F(KHz)$
0.49-1.705	3	$20\log(24000/F(KHz))+ 40\log(30/3)$	$24000/F(KHz)$
1.705-30	3	$20\log(30)+ 40\log(30/3)$	30
30-88	3	40.0	100
88-216	3	43.5	150
216-960	3	46.0	200
Above 960	3	54.0	500

TEST CONFIGURATION

(A) Radiated Emission Test Set-Up, Frequency Below 30MHz

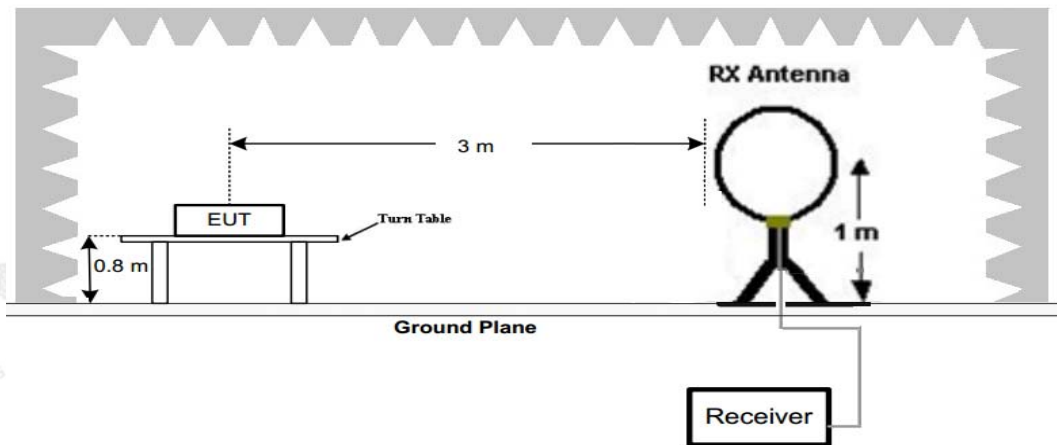

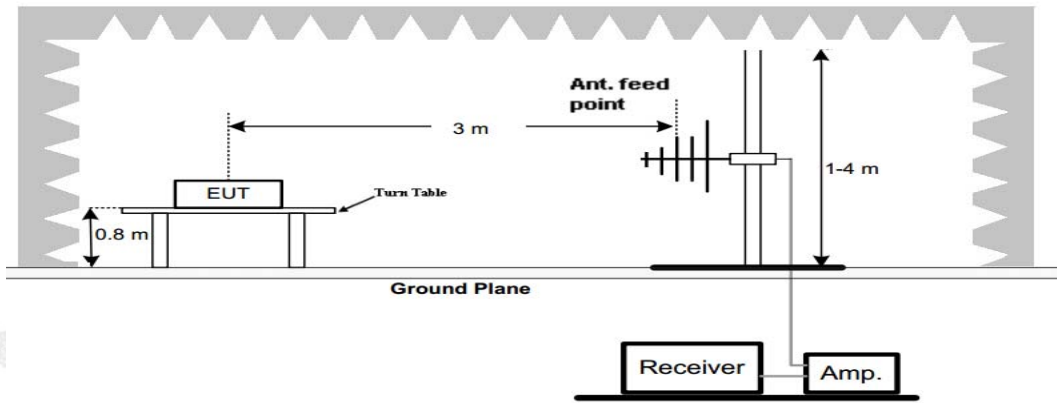
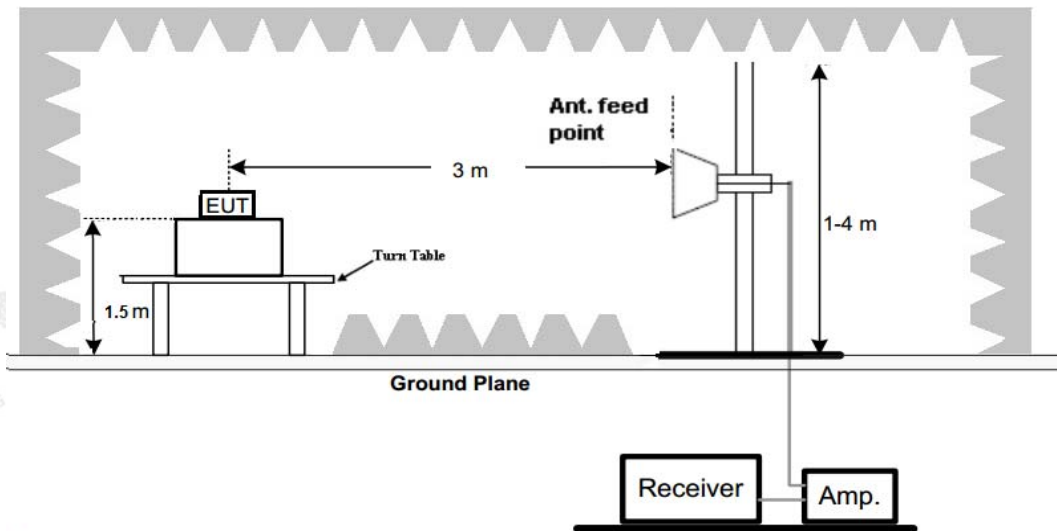
(B) Radiated Emission Test Set-Up, Frequency below 1000MHz**(C) Radiated Emission Test Set-Up, Frequency above 1000MHz**

Test Procedure

1. The EUT was placed on turn table which is 0.8m above ground plane for below 1GHz test, and on a low permittivity and low loss tangent turn table which is 1.5m above ground plane for above 1GHz test.
2. Maximum procedure was performed by raising the receiving antenna from 1m to 4m and rotating the turn table from 0°C to 360°C to acquire the highest emissions from EUT
3. And also, each emission was to be maximized by changing the polarization of receiving antenna both horizontal and vertical.
4. Repeat above procedures until all frequency measurements have been completed.



TEST RESULTS

Remark:

1. Radiated Emission measured at GFSK, π/4 DQPSK mode from 9 KHz to 10th harmonic of fundamental and recorded worst case at GFSK DH5 mode.
2. There is no emission found except system noise floor in 9 KHz to 30MHz and not recorded in this report.
3. For below 1GHz testing recorded worst at GFSK DH5 low channel.

Below 1GHz Test Results:
Antenna polarity: H

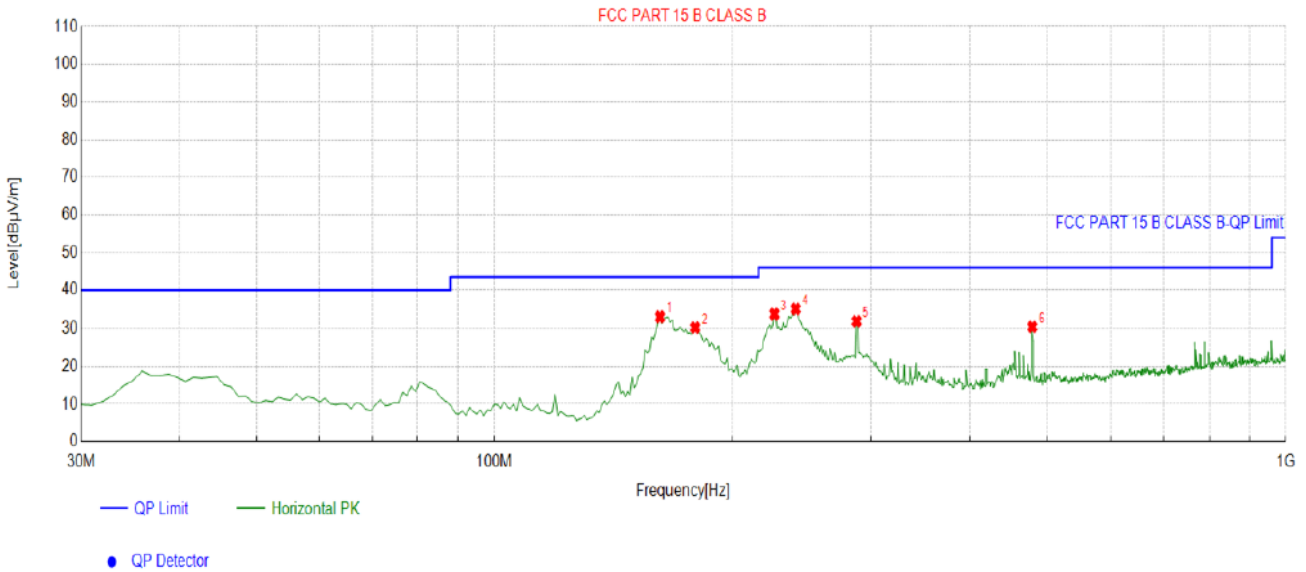

Suspected List									
NO.	Freq. [MHz]	Factor [dB]	Reading [dBµV/m]	Level [dBµV/m]	Limit [dBµV/m]	Margin [dB]	Height [cm]	Angle [°]	Polarity
1	162.0521	-20.45	53.52	33.07	43.50	10.43	100	113	Horizontal
2	179.5295	-16.94	47.28	30.34	43.50	13.16	100	315	Horizontal
3	226.1361	-14.41	48.20	33.79	46.00	12.21	100	90	Horizontal
4	240.7007	-13.82	48.88	35.06	46.00	10.94	100	83	Horizontal
5	287.3073	-12.95	44.94	31.99	46.00	14.01	100	103	Horizontal
6	479.5596	-8.44	38.97	30.53	46.00	15.47	100	269	Horizontal

Remark: Factor = Cable loss + Antenna factor – Pre-amplifier; Level = Reading + Factor; Margin = Limit – Level;



Antenna polarity: V

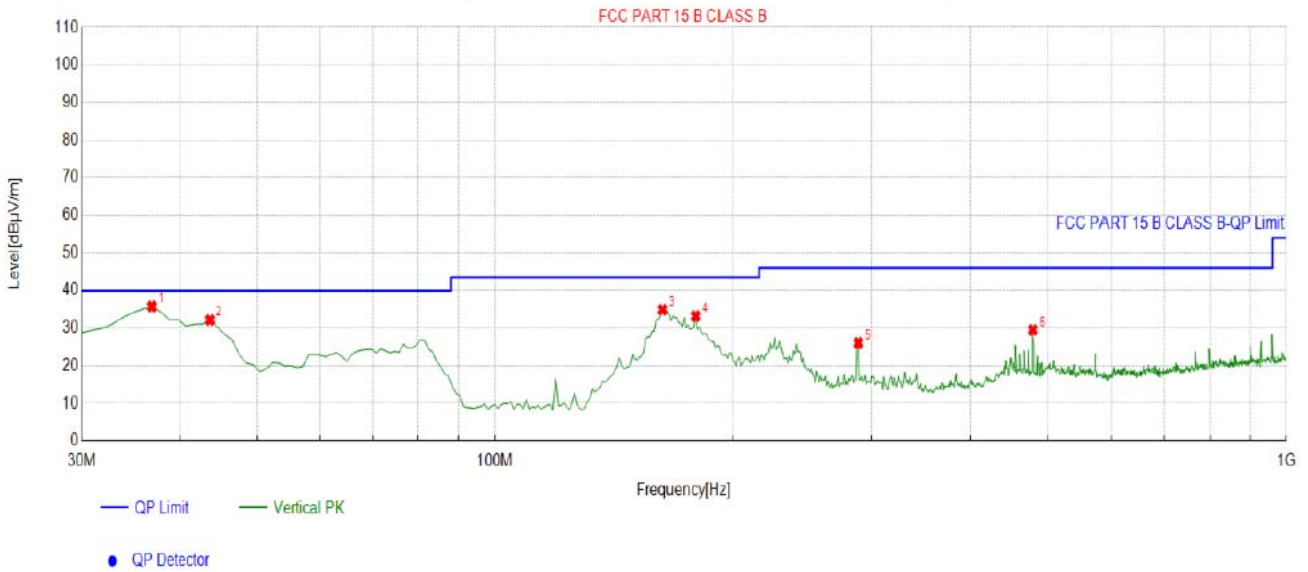

Suspected List									
NO.	Freq. [MHz]	Factor [dB]	Reading [dBµV/m]	Level [dBµV/m]	Limit [dBµV/m]	Margin [dB]	Height [cm]	Angle [°]	Polarity
1	36.7968	-15.57	51.31	35.74	40.00	4.26	100	1	Vertical
2	43.5936	-13.90	46.05	32.15	40.00	7.85	100	128	Vertical
3	163.0230	-20.23	55.12	34.89	43.50	8.61	100	333	Vertical
4	179.5295	-16.94	50.11	33.17	43.50	10.33	100	247	Vertical
5	288.2783	-12.91	38.93	26.02	46.00	19.98	100	15	Vertical
6	479.5596	-8.44	37.94	29.50	46.00	16.50	100	267	Vertical

Remark: Factor = Cable loss + Antenna factor – Pre-amplifier; Level = Reading + Factor; Margin = Limit – Level;

Harmonics and Spurious Emissions

Frequency Range (9 kHz-30MHz)

Frequency (MHz)	Level@3m (dBµV/m)	Limit@3m (dBµV/m)
--	--	--
--	--	--
--	--	--
--	--	--

Note:1. Emission Level=Reading+ Cable loss+ Antenna factor-Amp factor
 2. The emission levels are 20 dB below the limit value, which are not reported. It is deemed to comply with the requirement



For 1GHz to 25GHz

CH Low (2402MHz)

Horizontal:

Frequency (MHz)	Meter Reading (dBμV)	Factor (dB)	Emission Level (dBμV/m)	Limits (dBμV/m)	Margin (dB)	Detector Type
4804.00	50.07	-3.65	46.42	74.00	-27.58	peak
4804.00	37.47	-3.65	33.82	54.00	-20.18	AVG
7206.00	51.21	-0.95	50.26	74.00	-23.74	peak
7206.00	40.08	-0.95	39.13	54.00	-14.87	AVG

Remark: Factor = Antenna Factor + Cable Loss – Pre-amplifier.

Vertical:

Frequency (MHz)	Meter Reading (dBμV)	Factor (dB)	Emission Level (dBμV/m)	Limits (dBμV/m)	Margin (dB)	Detector Type
4804.00	48.73	-3.65	45.08	74.00	-28.92	peak
4804.00	38.05	-3.65	34.40	54.00	-19.60	AVG
7206.00	48.46	-0.95	47.51	74.00	-26.49	peak
7206.00	36.68	-0.95	35.73	54.00	-18.27	AVG

Remark: Factor = Antenna Factor + Cable Loss – Pre-amplifier.



CH Middle (2441MHz)

Horizontal:

Frequency (MHz)	Meter Reading (dBμV)	Factor (dB)	Emission Level (dBμV/m)	Limits (dBμV/m)	Margin (dB)	Detector Type
4882.00	50.74	-3.54	47.20	74.00	-26.80	peak
4882.00	36.43	-3.54	32.89	54.00	-21.11	AVG
7323.00	49.30	-0.81	48.49	74.00	-25.51	peak
7323.00	32.50	-0.81	31.69	54.00	-22.31	AVG

Remark: Factor = Antenna Factor + Cable Loss – Pre-amplifier.

Vertical:

Frequency (MHz)	Meter Reading (dBμV)	Factor (dB)	Emission Level (dBμV/m)	Limits (dBμV/m)	Margin (dB)	Detector Type
4882.00	47.65	-3.54	44.11	74.00	-29.89	peak
4882.00	34.37	-3.54	30.83	54.00	-23.17	AVG
7323.00	48.89	-0.81	48.08	74.00	-25.92	peak
7323.00	36.96	-0.81	36.15	54.00	-17.85	AVG

Remark: Factor = Antenna Factor + Cable Loss – Pre-amplifier.



CH High (2480MHz)

Horizontal:

Frequency (MHz)	Meter Reading (dBµV)	Factor (dB)	Emission Level (dBµV/m)	Limits (dBµV/m)	Margin (dB)	Detector Type
4960.00	46.59	-3.43	43.16	74.00	-30.84	peak
4960.00	37.06	-3.43	33.63	54.00	-20.37	AVG
7440.00	47.25	-0.77	46.48	74.00	-27.52	peak
7440.00	33.37	-0.77	32.60	54.00	-21.40	AVG

Remark: Factor = Antenna Factor + Cable Loss – Pre-amplifier.

Vertical:

Frequency (MHz)	Meter Reading (dBµV)	Factor (dB)	Emission Level (dBµV/m)	Limits (dBµV/m)	Margin (dB)	Detector Type
4960.00	48.02	-3.43	44.59	74.00	-29.41	peak
4960.00	38.75	-3.43	35.32	54.00	-18.68	AVG
7440.00	44.76	-0.77	43.99	74.00	-30.01	peak
7440.00	30.57	-0.77	29.80	54.00	-24.20	AVG

Remark: Factor = Antenna Factor + Cable Loss – Pre-amplifier.

Remark :

- (1) Measuring frequencies from 1 GHz to the 25 GHz.
- (2) "F" denotes fundamental frequency; "H" denotes spurious frequency. "E" denotes band edge frequency.
- (3) * denotes emission frequency which appearing within the Restricted Bands specified in provision of 15.205, then the general radiated emission limits in 15.209 apply.
- (4) The emissions are attenuated more than 20dB below the permissible limits are not recorded in the report.
- (5) The IF bandwidth of EMI Test Receiver between 30MHz to 1GHz was 120KHz, 1 MHz for measuring above 1 GHz, below 30MHz was 10KHz. The resolution bandwidth of test receiver/spectrum analyzer is 1MHz and video bandwidth is 3MHz for peak measurement with peak detector at frequency above 1GHz. The resolution bandwidth of test receiver/spectrum analyzer is 1MHz and video bandwidth is 10Hz for Average measurement with peak detection at frequency above 1GHz.
- (6) When the test results of Peak Detected below the limits of Average Detected, the Average Detected is not need completed. For example: Top Channel at Fundamental 73.16dBuV/m(PK Value) <93.98(AV Limit), at harmonic 53.20 dBuV/m(PK Value) <54 dBuV/m(AV Limit), the Average Detected not need to completed.
- (7) All modes of operation were investigated and the worst-case emissions are reported.



Radiated Band Edge Test:

Hopping

Horizontal (Worst case)

Frequency (MHz)	Meter Reading (dBμV)	Factor (dB)	Emission Level (dBμV/m)	Limits (dBμV/m)	Margin (dB)	Detector Type
2310.00	55.51	-5.81	49.7	74	-24.3	peak
2310.00	/	-5.81	/	54	/	AVG
2390.00	58.49	-5.84	52.65	74	-21.35	peak
2390.00	/	-5.84	/	54	/	AVG

Remark: Factor = Antenna Factor + Cable Loss – Pre-amplifier.

Vertical:

Frequency (MHz)	Meter Reading (dBμV)	Factor (dB)	Emission Level (dBμV/m)	Limits (dBμV/m)	Margin (dB)	Detector Type
2310.00	56.05	-5.81	50.24	74	-23.76	peak
2310.00	/	-5.81	/	54	/	AVG
2390.00	54.68	-5.84	48.84	74	-25.16	peak
2390.00	/	-5.84	/	54	/	AVG

Remark: Factor = Antenna Factor + Cable Loss – Pre-amplifier.



Horizontal (Worst case)

Frequency (MHz)	Meter Reading (dBµV)	Factor (dB)	Emission Level (dBµV/m)	Limits (dBµV/m)	Margin (dB)	Detector Type
2483.50	56.14	-5.81	50.33	74	-23.67	peak
2483.50	/	-5.81	/	54	/	AVG
2500.00	55.89	-6.06	49.83	74	-24.17	peak
2500.00	/	-6.06	/	54	/	AVG

Remark: Factor = Antenna Factor + Cable Loss – Pre-amplifier.

Vertical:

Frequency (MHz)	Meter Reading (dBµV)	Factor (dB)	Emission Level (dBµV/m)	Limits (dBµV/m)	Margin (dB)	Detector Type
2483.50	56.75	-5.81	50.94	74	-23.06	peak
2483.50	/	-5.81	/	54	/	AVG
2500.00	56.21	-6.06	50.15	74	-23.85	peak
2500.00	/	-6.06	/	54	/	AVG

Remark: Factor = Antenna Factor + Cable Loss – Pre-amplifier.

Remark: All the other emissions not reported were too low to read and deemed to comply with FCC limit.



NO hopping

Operation Mode: TX CH Low (2402MHz)

Horizontal (Worst case)

Frequency (MHz)	Meter Reading (dBµV)	Factor (dB)	Emission Level (dBµV/m)	Limits (dBµV/m)	Margin (dB)	Detector Type
2310.00	56.88	-5.81	51.07	74	-22.93	peak
2310.00	/	-5.81	/	54	/	AVG
2390.00	55.14	-5.84	49.3	74	-24.7	peak
2390.00	/	-5.84	/	54	/	AVG

Remark: Factor = Antenna Factor + Cable Loss – Pre-amplifier.

Vertical:

Frequency (MHz)	Meter Reading (dBµV)	Factor (dB)	Emission Level (dBµV/m)	Limits (dBµV/m)	Margin (dB)	Detector Type
2310.00	55.79	-5.81	49.98	74	-24.02	peak
2310.00	/	-5.81	/	54	/	AVG
2390.00	54.03	-5.84	48.19	74	-25.81	peak
2390.00	/	-5.84	/	54	/	AVG

Remark: Factor = Antenna Factor + Cable Loss – Pre-amplifier.



Operation Mode: TX CH High (2480MHz)

Horizontal (Worst case)

Frequency (MHz)	Meter Reading (dBμV)	Factor (dB)	Emission Level (dBμV/m)	Limits (dBμV/m)	Margin (dB)	Detector Type
2483.50	56.56	-5.81	50.75	74	-23.25	peak
2483.50	/	-5.81	/	54	/	AVG
2500.00	54.89	-6.06	48.83	74	-25.17	peak
2500.00	/	-6.06	/	54	/	AVG

Remark: Factor = Antenna Factor + Cable Loss – Pre-amplifier.

Vertical:

Frequency (MHz)	Meter Reading (dBμV)	Factor (dB)	Emission Level (dBμV/m)	Limits (dBμV/m)	Margin (dB)	Detector Type
2483.50	55.24	-5.81	49.43	74	-24.57	peak
2483.50	/	-5.81	/	54	/	AVG
2500.00	56.12	-6.06	50.06	74	-23.94	peak
2500.00	/	-6.06	/	54	/	AVG

Remark: Factor = Antenna Factor + Cable Loss – Pre-amplifier.

Remark: All the other emissions not reported were too low to read and deemed to comply with FCC limit.



3.3. Maximum Peak Conducted Output Power

Limit

Frequency hopping systems shall have hopping channel carrier frequencies separated by a minimum of 25 kHz or the 20 dB bandwidth of the hopping channel, whichever is greater. Alternatively, frequency hopping systems operating in the 2400-2483.5 MHz band may have hopping channel carrier frequencies that are separated by 25 kHz or two-thirds of the 20 dB bandwidth of the hopping channel, whichever is greater, provided the systems operate with an output power no greater than 125 mW. The system shall hop to channel frequencies that are selected at the system hopping rate from a pseudo randomly ordered list of hopping frequencies. Each frequency must be used equally on the average by each transmitter. The system receivers shall have input bandwidths that match the hopping channel bandwidths of their corresponding transmitters and shall shift frequencies in synchronization with the transmitted signals.

Test Procedure

Remove the antenna from the EUT and then connect a low loss RF cable from the antenna port to the power sensor.

Test Configuration

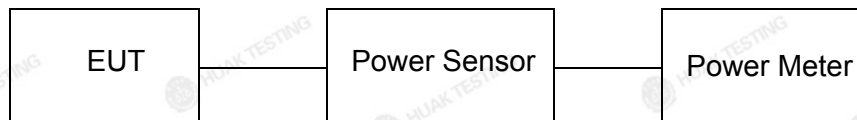

Test Results

Type	Channel	Output power (dBm)	Limit (dBm)	Result
GFSK	00	-3.98	21.00	Pass
	39	-4.17		
	78	-4.92		
π/4DQPSK	00	-3.19	21.00	Pass
	39	-3.54		
	78	-4.24		

Note: 1.The test results including the cable lose.



3.4. 20dB Bandwidth

Limit

For frequency hopping systems operating in the 2400MHz-2483.5MHz no limit for 20dB bandwidth.

Test Procedure

The transmitter output was connected to the spectrum analyzer through an attenuator. The bandwidth of the fundamental frequency was measured by spectrum analyzer with 30 KHz RBW and 100 KHz VBW.

The 20dB bandwidth is defined as the total spectrum the power of which is higher than peak power minus 20dB.

The occupied bandwidth is the frequency bandwidth such that, below its lower and above its upper frequency limits, the mean powers are each equal to 0.5% of the total mean power of the given emission. The following procedure shall be used for measuring 99% power bandwidth:

- RBW=1% to 5% of the OBW
- VBW=approximately 3 X RBW
- Detector=Peak
- Trace Mode: Max Hold

Use the 99% power bandwidth function of the instrument to measure the Occupied Bandwidth and recorded.

Test Configuration



Test Results

Modulation	Channel	20dB bandwidth (MHz)	Result
GFSK	CH00	0.962	Pass
	CH39	0.952	
	CH78	0.944	
$\pi/4$ DQPSK	CH00	1.286	
	CH39	1.320	
	CH78	1.294	



Test plot as follows:
20dB bandwidth

GFSK Modulation



CH00



CH39



CH78

The results shown in this test report refer only to the sample(s) tested unless otherwise stated and the sample(s) are retained for 30 days only. The document is issued by HUAJ, this document cannot be reproduced except in full with our prior written permission. The more details and the authenticity of the report will be confirmed at <http://www.cer-mark.com>.

TEL : +86-755 2302 9901 FAX : +86-755 2302 9901 E-mail : service@cer-mark.com

Add: 1-2F., Building B2, Junfeng Zhongcheng Zhizao Innovation Park, Heping Community, Fuhai Street, Bao'an District, Shenzhen, Guangdong, China



$\pi/4$ DQPSK Modulation



CH00



CH03



CH07

The results shown in this test report refer only to the sample(s) tested unless otherwise stated and the sample(s) are retained for 30 days only. The document is issued by HUAKE, this document cannot be reproduced except in full with our prior written permission. The more details and the authenticity of the report will be confirmed at <http://www.cer-mark.com>.

TEL : +86-755 2302 9901 FAX : +86-755 2302 9901 E-mail : service@cer-mark.com

Add: 1-2F., Building B2, Junfeng Zhongcheng Zhizao Innovation Park, Heping Community, Fuhai Street, Bao'an District, Shenzhen, Guangdong, China



3.5. Frequency Separation

LIMIT

Frequency hopping systems shall have hopping channel carrier frequencies separated by minimum of 25KHz or the 2/3*20dB bandwidth of the hopping channel, whichever is greater.

TEST PROCEDURE

The transmitter output was connected to the spectrum analyzer through an attenuator. The bandwidth of the fundamental frequency was measured by spectrum analyzer with 30 KHz RBW and 100 KHz VBW.

TEST CONFIGURATION



TEST RESULTS

Modulation	Channel	Channel Separation (MHz)	Limit(MHz)	Result
GFSK	CH39	1.000	0.962	Pass
	CH40			
π/4DQPSK	CH39	1.000	0.880	Pass
	CH40			

Note: We have tested all mode at high, middle and low channel, and recorded worst case at middle

Test plot as follows:



Frequency Separation

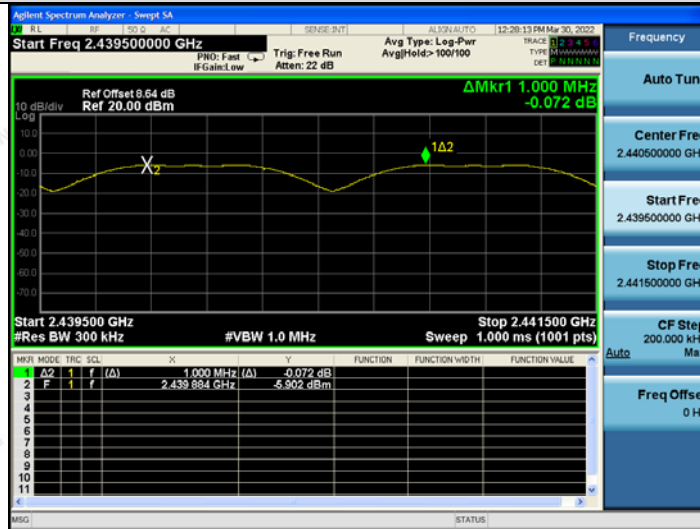

GFSK

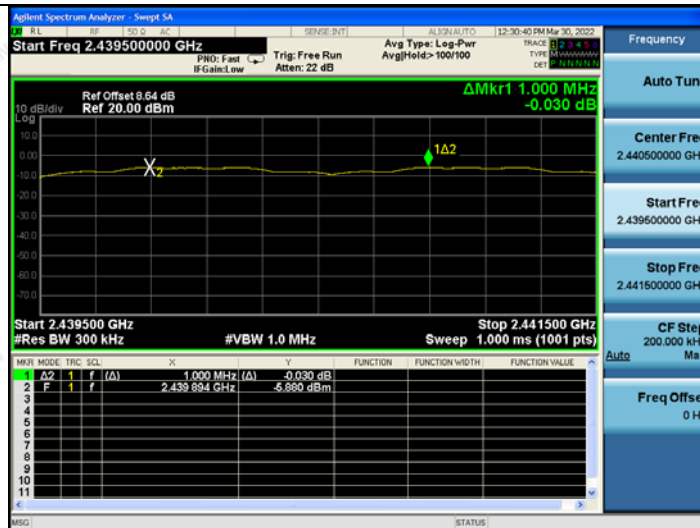

π/4DQPSK

The results shown in this test report refer only to the sample(s) tested unless otherwise stated and the sample(s) are retained for 30 days only. The document is issued by HUAKE, this document cannot be reproduced except in full with our prior written permission. The more details and the authenticity of the report will be confirmed at <http://www.cer-mark.com>.

TEL : +86-755 2302 9901 FAX : +86-755 2302 9901 E-mail : service@cer-mark.com

Add: 1-2F., Building B2, Junfeng Zhongcheng Zhizao Innovation Park, Heping Community, Fuhai Street, Bao'an District, Shenzhen, Guangdong, China



3.6. Number of hopping frequency

Limit

Frequency hopping systems in the 2400–2483.5 MHz band shall use at least 15 channels.

Test Procedure

The transmitter output was connected to the spectrum analyzer through an attenuator. Set spectrum analyzer start 2400MHz to 2483.5MHz.

Test Configuration



Test Results

Modulation	Number of Hopping Channel	Limit	Result
GFSK	79	≥15	Pass
$\pi/4$ DQPSK	79		

Test plot as follows:



GFSK Modulation

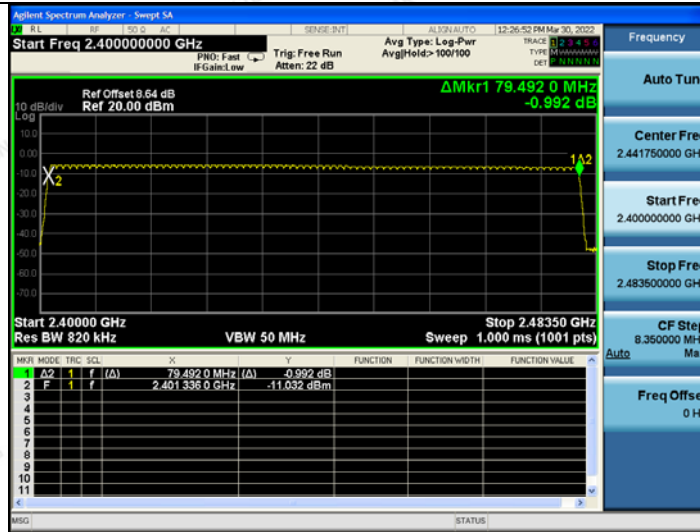

$\pi/4$ DQPSK Modulation

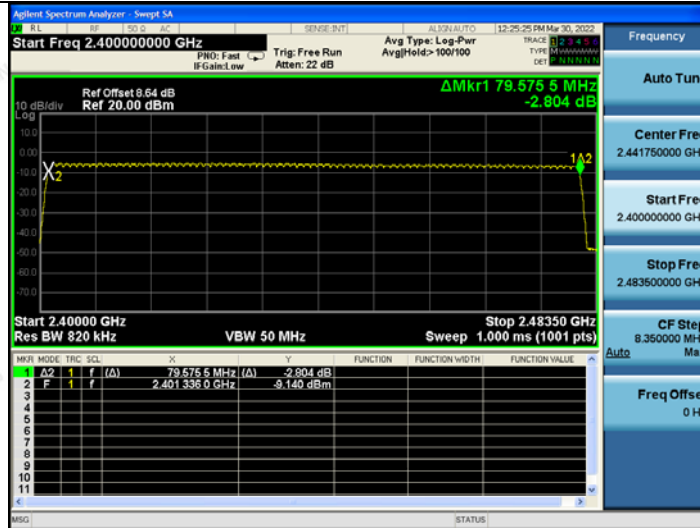

The results shown in this test report refer only to the sample(s) tested unless otherwise stated and the sample(s) are retained for 30 days only. The document is issued by HUAKE, this document cannot be reproduced except in full with our prior written permission. The more details and the authenticity of the report will be confirmed at <http://www.cer-mark.com>.

TEL : +86-755 2302 9901 FAX : +86-755 2302 9901 E-mail : service@cer-mark.com

Add: 1-2F., Building B2, Junfeng Zhongcheng Zhizao Innovation Park, Heping Community, Fuhai Street, Bao'an District, Shenzhen, Guangdong, China



3.7. Time of Occupancy (Dwell Time)

Limit

The average time of occupancy on any channel shall not be greater than 0.4 seconds within a period of 0.4 seconds multiplied by the number of hopping channels employed.

Test Procedure

The transmitter output was connected to the spectrum analyzer through an attenuator. Set center frequency of spectrum analyzer=operating frequency with 1MHz RBW and 3MHz VBW, Span 0Hz.

Test Configuration



Test Results

Modulation	Packet	Pulse time (ms)	Dwell time (second)	Limit (second)	Result
GFSK	DH1	0.37	0.118	0.40	Pass
	DH3	1.63	0.261		
	DH5	2.88	0.307		
π/4DQPSK	2-DH1	0.38	0.122	0.40	Pass
	2-DH3	1.64	0.262		
	2-DH5	2.89	0.308		

Note:

- We have tested all mode at high,middle and low channel,and recoreded worst case at middle channel.
- $Dwell\ time = Pulse\ time\ (ms) \times (1600 \div 2 \div 79) \times 31.6\ Second$ for DH1, 2-DH1, 3-DH1
 $Dwell\ time = Pulse\ time\ (ms) \times (1600 \div 4 \div 79) \times 31.6\ Second$ for DH3, 2-DH3, 3-DH3
 $Dwell\ time = Pulse\ time\ (ms) \times (1600 \div 6 \div 79) \times 31.6\ Second$ for DH5, 2-DH5, 3-DH5

Test plot as follows:



GFSK Modulation

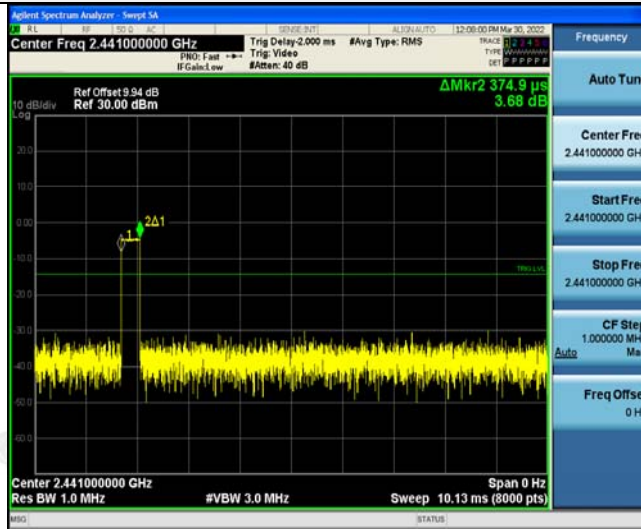

DH1

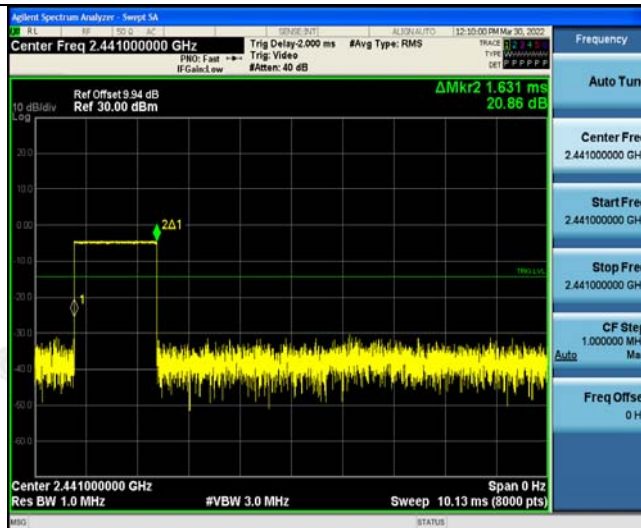

DH3

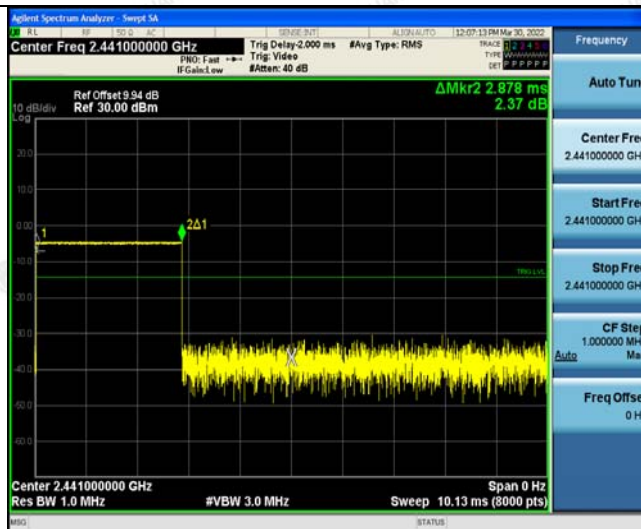

DH5

The results shown in this test report refer only to the sample(s) tested unless otherwise stated and the sample(s) are retained for 30 days only. The document is issued by HUAJ, this document cannot be reproduced except in full with our prior written permission. The more details and the authenticity of the report will be confirmed at <http://www.cer-mark.com>.

TEL : +86-755 2302 9901 FAX : +86-755 2302 9901 E-mail : service@cer-mark.com

Add: 1-2F., Building B2, Junfeng Zhongcheng Zhizao Innovation Park, Heping Community, Fuhai Street, Bao'an District, Shenzhen, Guangdong, China



$\pi/4$ DQPSK Modulation

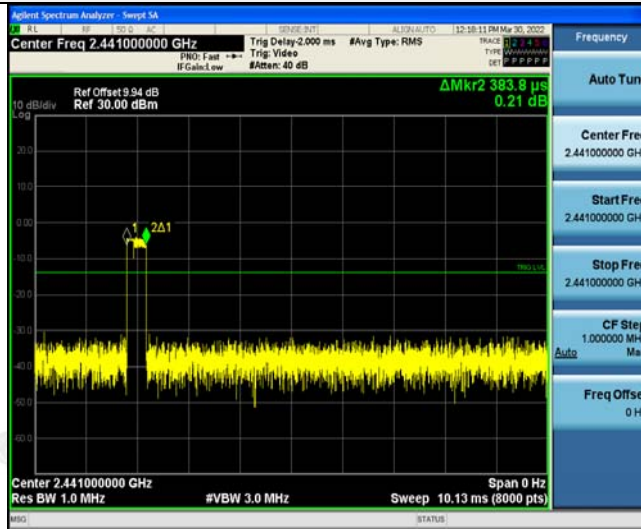

2-DH1

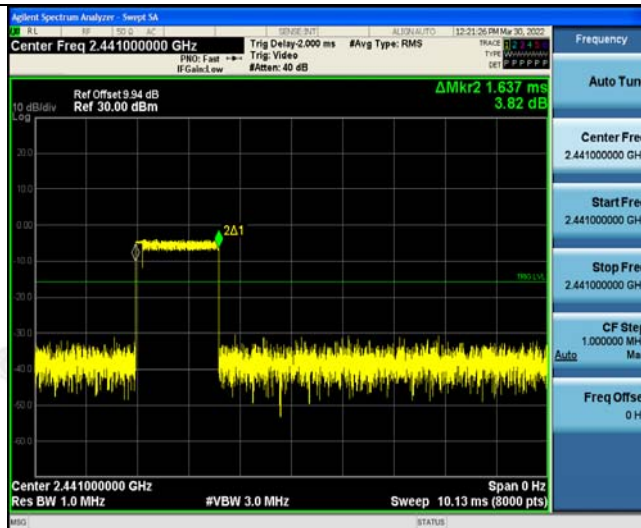

2-DH3

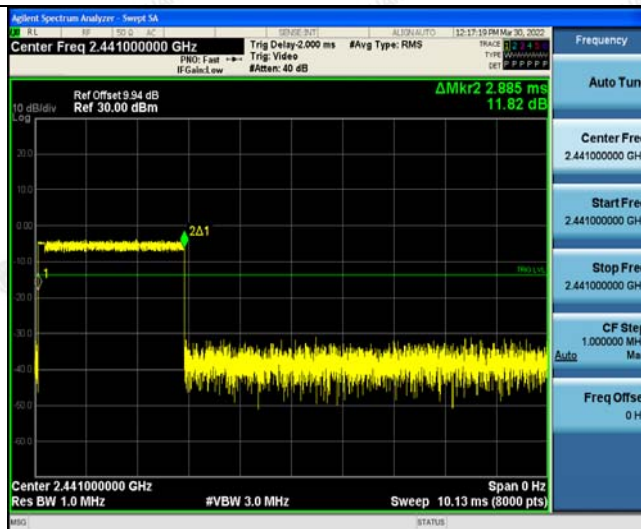

2-DH5

The results shown in this test report refer only to the sample(s) tested unless otherwise stated and the sample(s) are retained for 30 days only. The document is issued by HUAJ, this document cannot be reproduced except in full with our prior written permission. The more details and the authenticity of the report will be confirmed at <http://www.cer-mark.com>.

TEL : +86-755 2302 9901 FAX : +86-755 2302 9901 E-mail : service@cer-mark.com

Add: 1-2F., Building B2, Junfeng Zhongcheng Zhizao Innovation Park, Heping Community, Fuhai Street, Bao'an District, Shenzhen, Guangdong, China



3.8. Out-of-band Emissions

Limit

In any 100 kHz bandwidth outside the frequency band in which the spread spectrum or digitally modulated intentional radiator is operating, the radio frequency power that is produced by the intentional radiator shall be at least 20 dB below that in the 100 kHz bandwidth within the band that contains the highest level of the desired power, based on either an RF conducted or a radiated measurement, provided the transmitter demonstrates compliance with the peak conducted power limits. If the transmitter complies with the conducted power limits based on the use of RMS averaging over a time interval, as permitted under paragraph (b)(3) of this section, the attenuation required under this paragraph shall be 30 dB instead of 20 dB. Attenuation below the general limits specified in §15.209(a) is not required.

In any 100 kHz bandwidth outside the frequency band in which the spread spectrum or digitally modulated device is operating, the RF power that is produced shall be at least 20 dB below that in the 100 kHz bandwidth within the band that contains the highest level of the desired power, based on either an RF conducted or a radiated measurement, provided that the transmitter demonstrates compliance with the peak conducted power limits. If the transmitter complies with the conducted power limits based on the use of root-mean-square averaging over a time interval, as permitted under Section 5.4(4), the attenuation required shall be 30 dB instead of 20 dB. Attenuation below the general field strength limits specified in RSS-Gen is not required.

Test Procedure

Connect the transmitter output to spectrum analyzer using a low loss RF cable, and set the spectrum analyzer to RBW=100 kHz, VBW= 300 kHz, peak detector , and max hold. Measurements utilizing these setting are made of the in-band reference level, bandedge and out-of-band emissions.

Test Configuration



Test Results

Remark: The measurement frequency range is from 30MHz to the 10th harmonic of the fundamental frequency. The lowest, middle and highest channels are tested to verify the spurious emissions and bandage measurement data.

We measured all conditions (DH1, DH3, DH5) and recorded worst case at DH5 and 2DH5

Test plot as follows:



GFSK

CH00

CH39

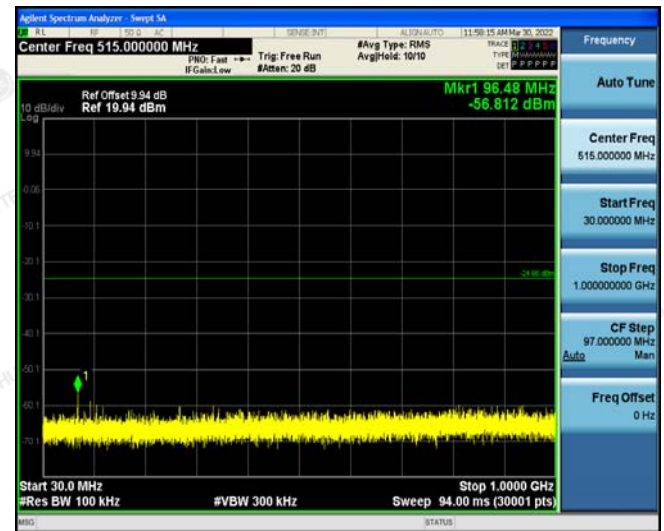
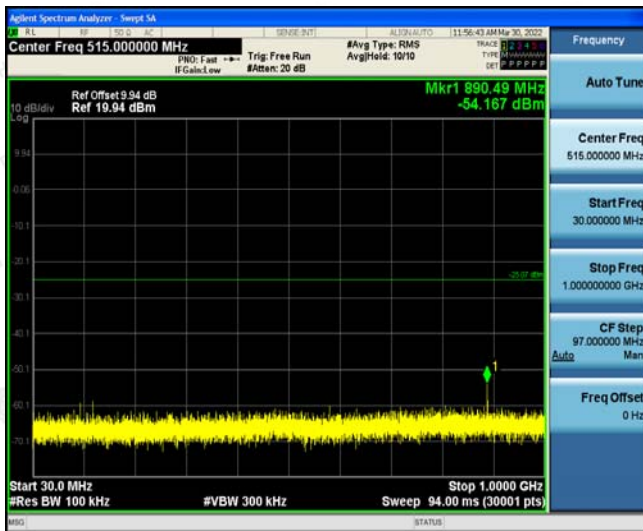

The results shown in this test report refer only to the sample(s) under test unless otherwise stated and the sample(s) are retained for 30 days only. The document is issued by HUAJ, this document cannot be reproduced except in full with our prior written permission. The more details and the authenticity of the report will be confirmed at <http://www.cer-mark.com>.

TEL : +86-755 2302 9901 FAX : +86-755 2302 9901 E-mail : service@cer-mark.com

Add: 1-2F., Building B2, Junfeng Zhongcheng Zhizao Innovation Park, Heping Community, Fuhai Street, Bao'an District, Shenzhen, Guangdong, China



CH78

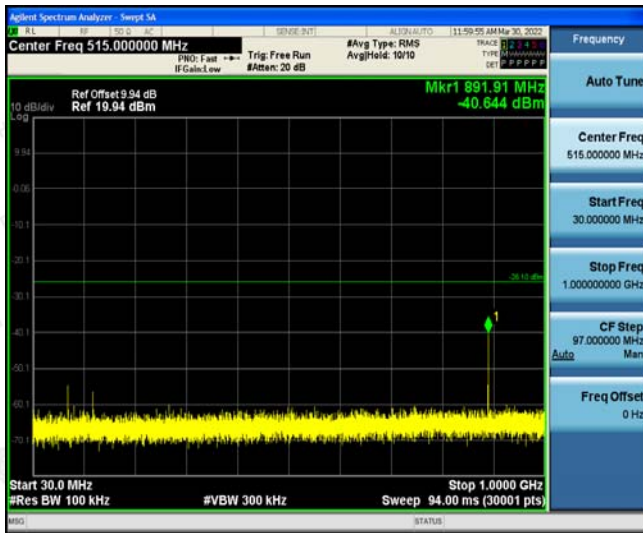

The results shown in this test report refer only to the sample(s) tested unless otherwise stated and the sample(s) are retained for 30 days only. The document is issued by HUAJ, this document cannot be reproduced except in full with our prior written permission. The more details and the authenticity of the report will be confirmed at <http://www.cer-mark.com>.

TEL : +86-755 2302 9901 FAX : +86-755 2302 9901 E-mail : service@cer-mark.com

Add: 1-2F., Building B2, Junfeng Zhongcheng Zhizao Innovation Park, Heping Community, Fuhai Street, Bao'an District, Shenzhen, Guangdong, China

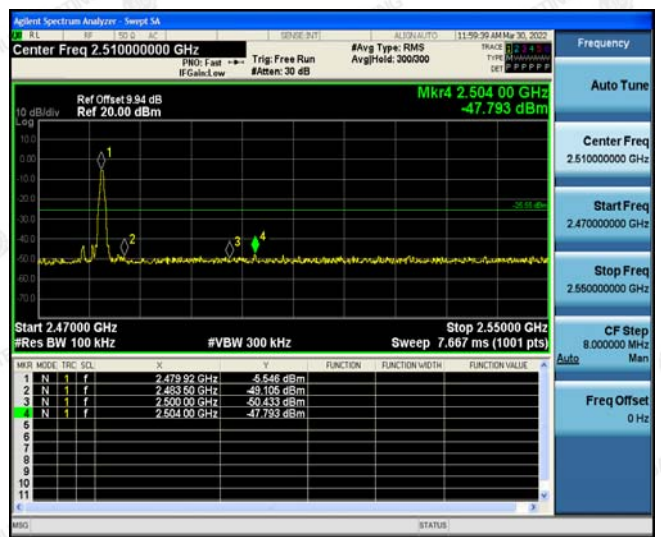
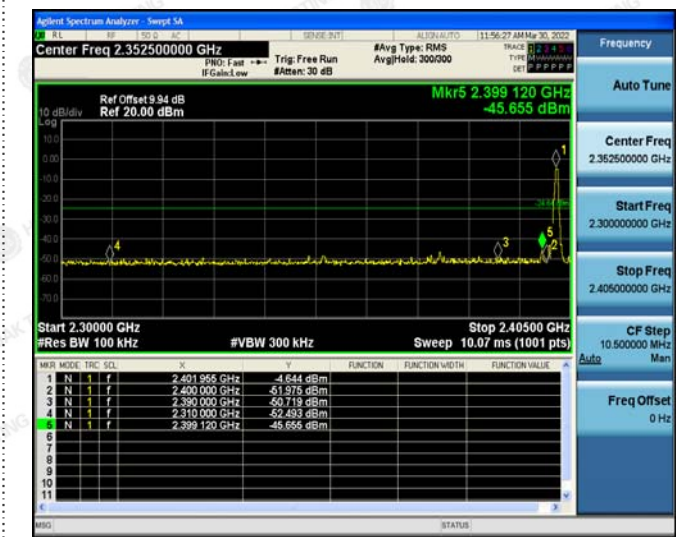

Left Band edge hopping off

Right Band edge hopping off

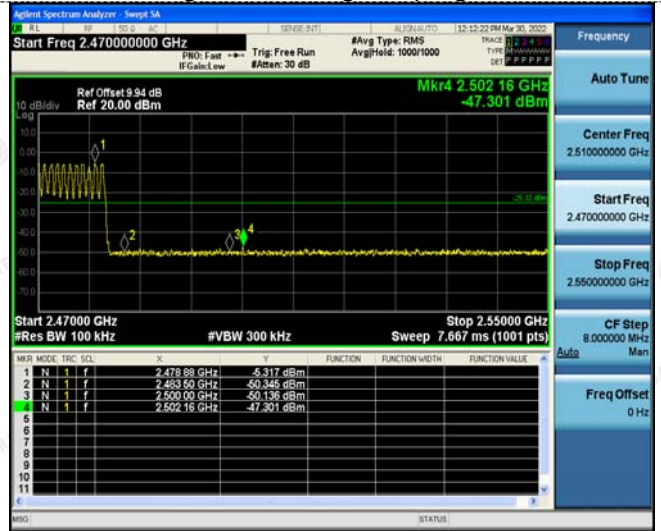
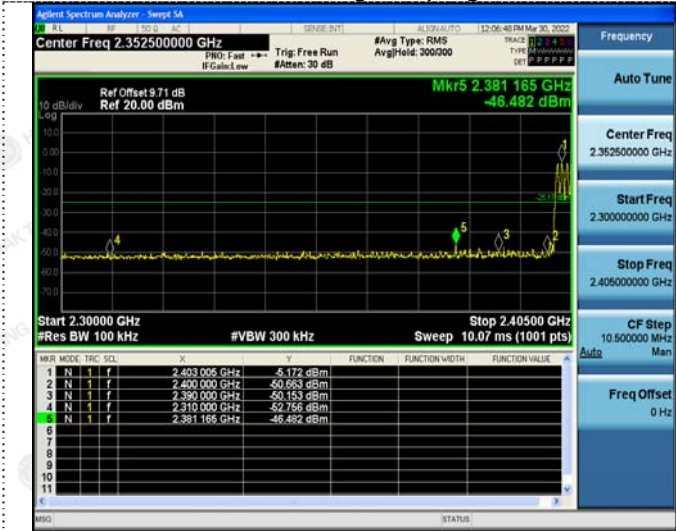

Left Band edge hopping on

Right Band edge hopping on

The results shown in this test report refer only to the sample(s) tested unless otherwise stated and the sample(s) are retained for 30 days only. The document is issued by HUAK, this document cannot be reproduced except in full with our prior written permission. The more details and the authenticity of the report will be confirmed at <http://www.cer-mark.com>.

TEL : +86-755 2302 9901 FAX : +86-755 2302 9901 E-mail : service@cer-mark.com

Add: 1-2F., Building B2, Junfeng Zhongcheng Zhizao Innovation Park, Heping Community, Fuhai Street, Bao'an District, Shenzhen, Guangdong, China



$\pi/4$ DQPSK

CH00

CH39

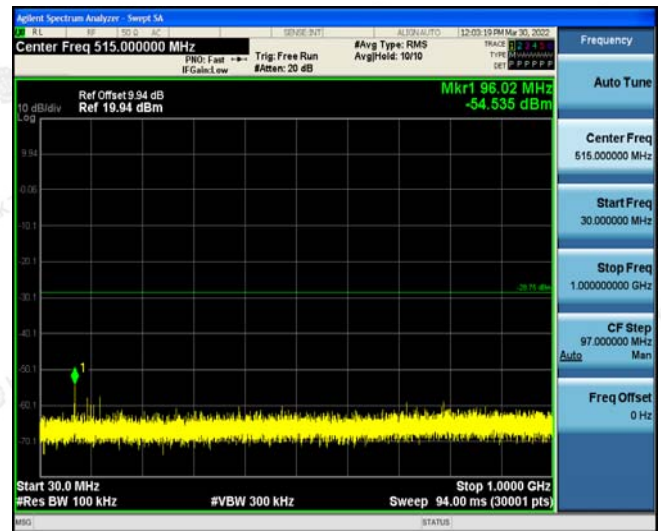
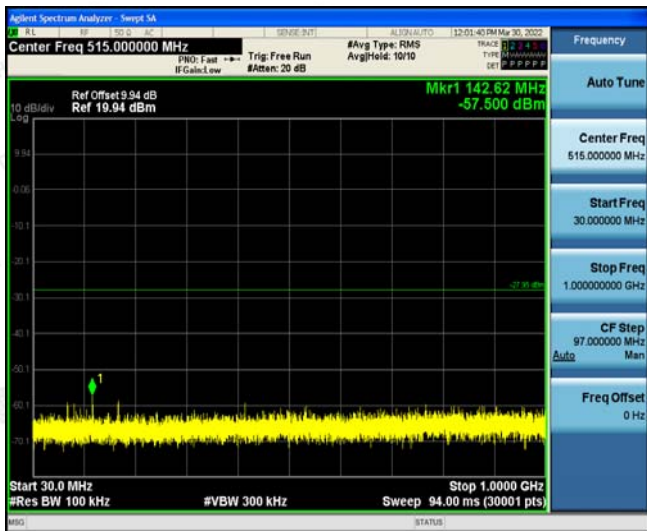

The results shown in this test report refer only to the sample(s) tested unless otherwise stated and the sample(s) are retained for 30 days only. The document is issued by HUAK, this document cannot be reproduced except in full with our prior written permission. The more details and the authenticity of the report will be confirmed at <http://www.cer-mark.com>.

TEL : +86-755 2302 9901 FAX : +86-755 2302 9901 E-mail : service@cer-mark.com

Add: 1-2F., Building B2, Junfeng Zhongcheng Zhizao Innovation Park, Heping Community, Fuhai Street, Bao'an District, Shenzhen, Guangdong, China



CH78

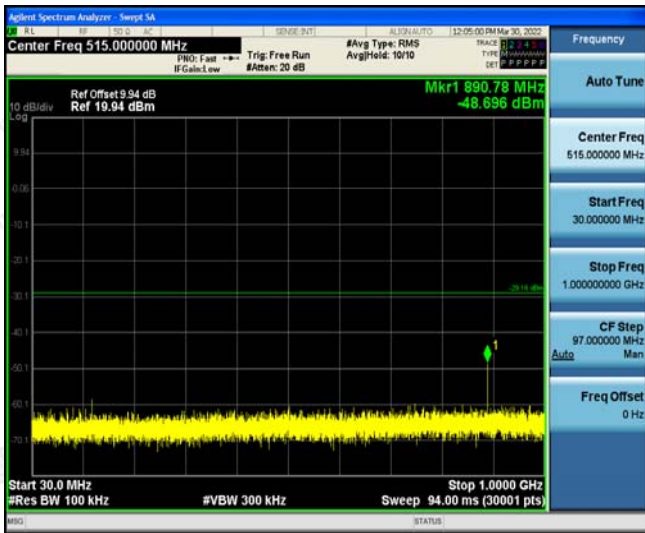

The results shown in this test report refer only to the sample(s) tested unless otherwise stated and the sample(s) are retained for 30 days only. The document is issued by HUAJ, this document cannot be reproduced except in full with our prior written permission. The more details and the authenticity of the report will be confirmed at <http://www.cer-mark.com>.

TEL : +86-755 2302 9901 FAX : +86-755 2302 9901 E-mail : service@cer-mark.com

Add: 1-2F., Building B2, Junfeng Zhongcheng Zhizao Innovation Park, Heping Community, Fuhai Street, Bao'an District, Shenzhen, Guangdong, China

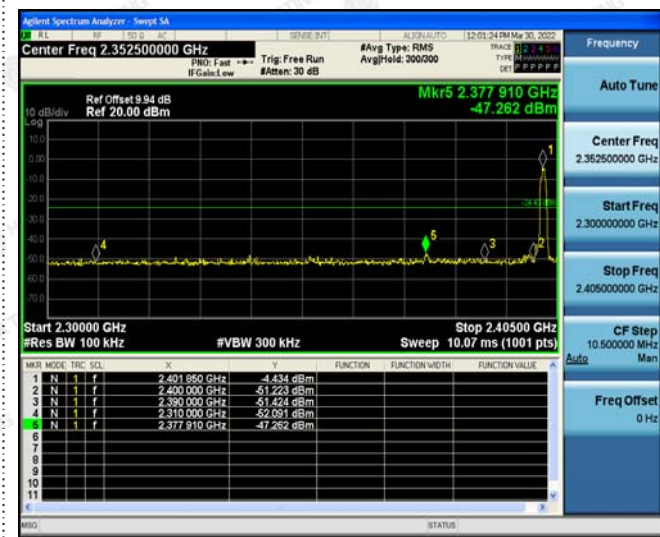

Left Band edge hopping off

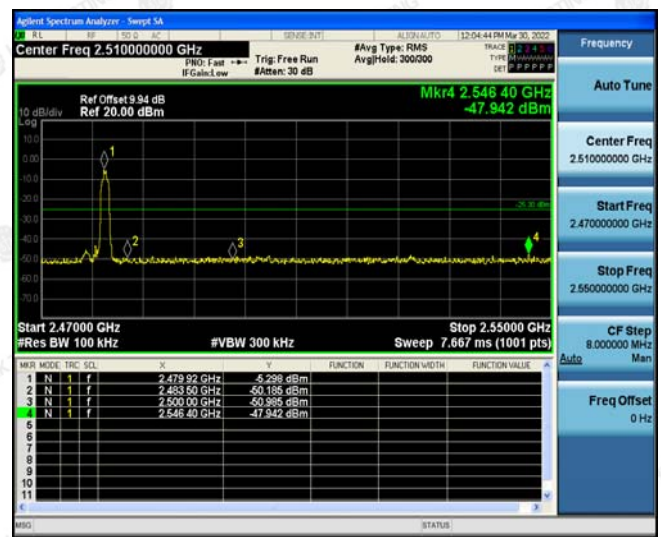

Right Band edge hopping off

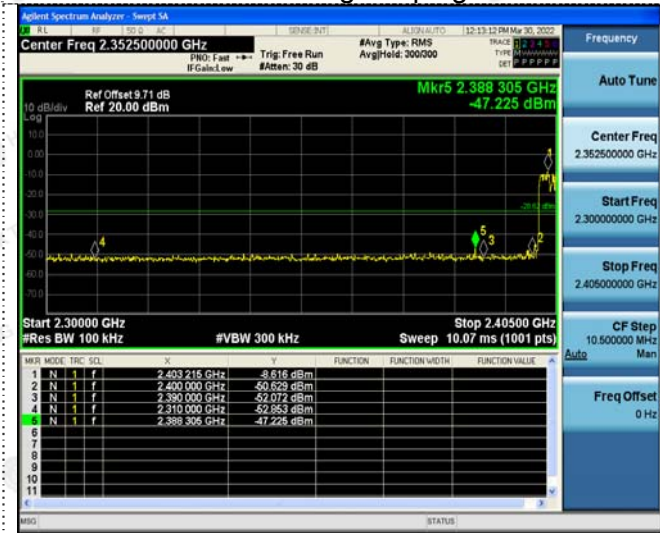

Left Band edge hopping on

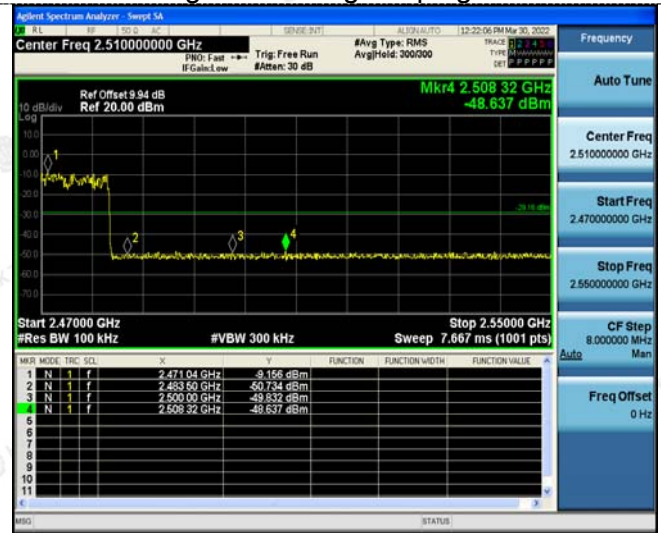

Right Band edge hopping on

3.9. Pseudorandom Frequency Hopping Sequence

TEST APPLICABLE

For 47 CFR Part 15C section 15.247 (a) (1):

Frequency hopping systems shall have hopping channel carrier frequencies separated by a minimum of 25 kHz or the 20 dB bandwidth of the hop-ping channel, whichever is greater. Alternatively, frequency hopping systems operating in the 2400–2483.5 MHz band may have hopping channel carrier frequencies that are separated by 25 kHz or two-thirds of the 20 dB bandwidth of the hopping channel, whichever is greater, provided the systems operate with an output power no greater than 125 mW. The system shall hop to channel frequencies that are selected at the system hopping rate from a pseudo randomly ordered list of hopping frequencies. Each frequency must be used equally on the average by each transmitter. The system receivers shall have input bandwidths that match the hop-ping channel bandwidths of their corresponding transmitters and shall shift frequencies in synchronization with the transmitted signals.

EUT Pseudorandom Frequency Hopping Sequence Requirement

The pseudorandom frequency hopping sequence may be generated in a nine-stage shift register whose 5th and 9th stage outputs are added in a modulo-two addition stage. And the result is fed back to the input of the first stage. The sequence begins with the first one of 9 consecutive ones, for example: the shift register is initialized with nine ones.

- Number of shift register stages:9
- Length of pseudo-random sequence:29-1=511 bits
- Longest sequence of zeros:8(non-inverted signal)



Linear Feedback Shift Register for Generation of the PRBS sequence

An example of pseudorandom frequency hopping sequence as follows:

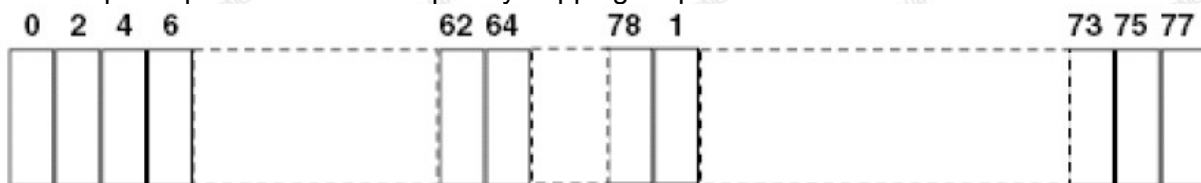

Each frequency used equally one the average by each transmitter.

The system receiver have input bandwidths that match the hopping channel bandwidths of their corresponding transmitter and shift frequencies in synchronization with the transmitted signals.

3.10. ANTENNA REQUIREMENT

Standard Applicable

For intentional device, according to FCC 47 CFR Section 15.203, an intentional radiator shall be designed to ensure that no antenna other than that furnished by the responsible party shall be used with the device. And according to FCC 47 CFR Section 15.247, if transmitting antennas of directional gain greater than 6dBi are used, the power shall be reduced by the amount in dB that the directional gain of the antenna exceeds 6dBi.

Refer to statement below for compliance.

The manufacturer may design the unit so that the user can replace a broken antenna, but the use of a standard antenna jack or electrical connector is prohibited. Further, this requirement does not apply to intentional radiators that must be professionally installed.

Antenna Connected Construction

The antenna used in this product is a PCB Antenna, is a permanently attached antenna on the PCB. It conforms to the standard requirements. The directional gains of antenna used for transmitting is 0dBi.

ANTENNA

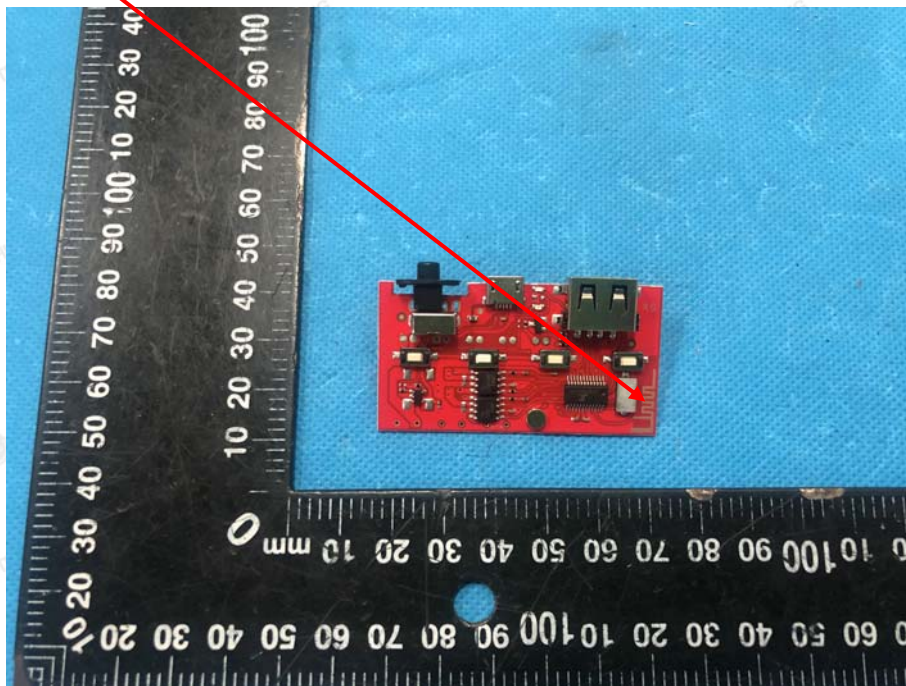



4. Test Setup Photos of the EUT

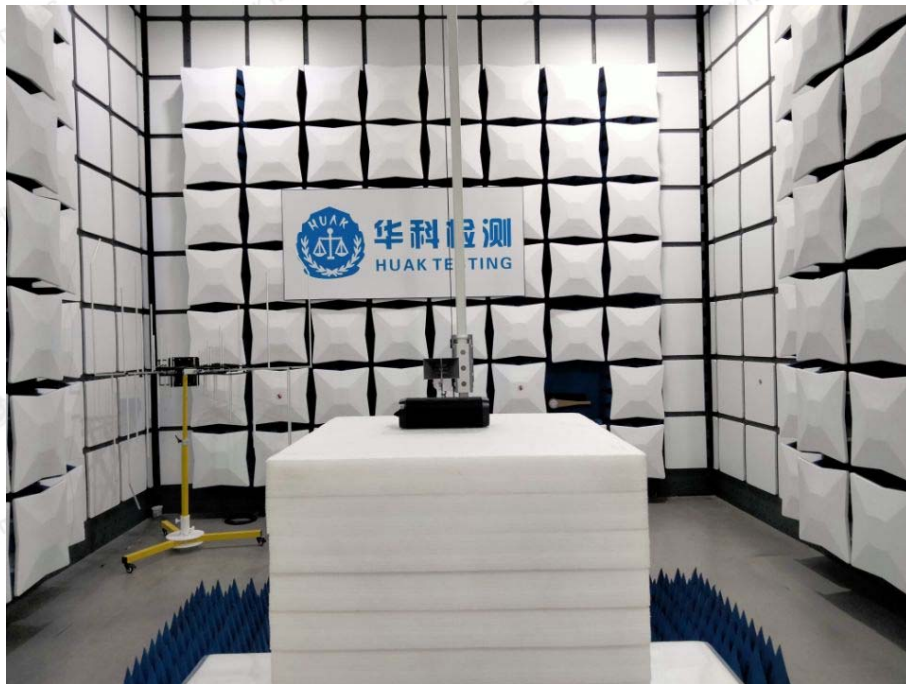
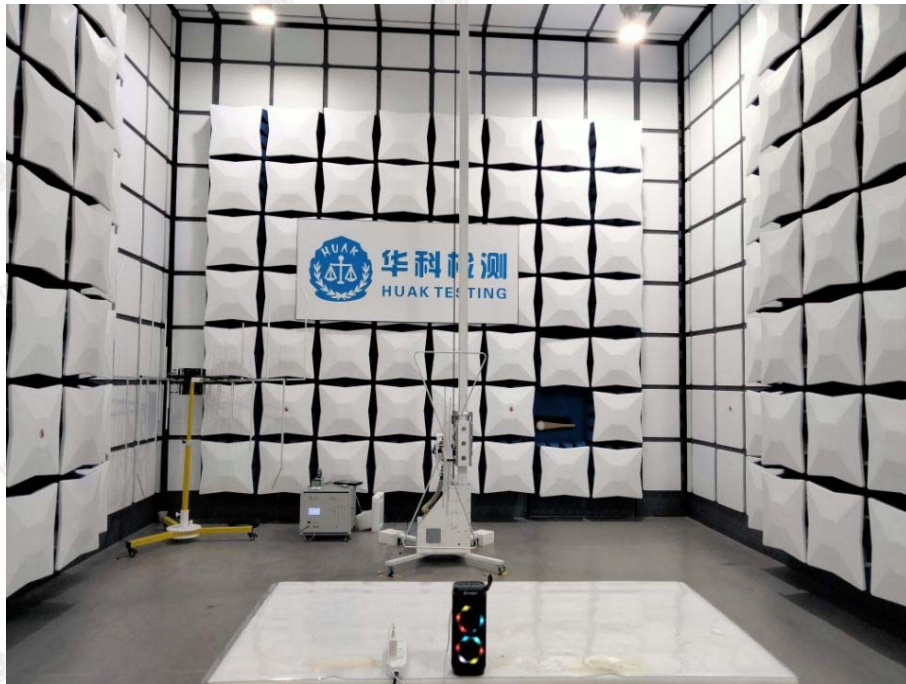

The results shown in this test report refer only to the sample(s) tested unless otherwise stated and the sample(s) are retained for 30 days only. The document is issued by HUAK, this document cannot be reproduced except in full with our prior written permission. The more details and the authenticity of the report will be confirmed at <http://www.cer-mark.com>.

TEL : +86-755 2302 9901 FAX : +86-755 2302 9901 E-mail : service@cer-mark.com

Addr: 1-2F., Building B2, Junfeng Zhongcheng Zhizao Innovation Park, Heping Community, Fuhai Street, Bao'an District, Shenzhen, Guangdong, China

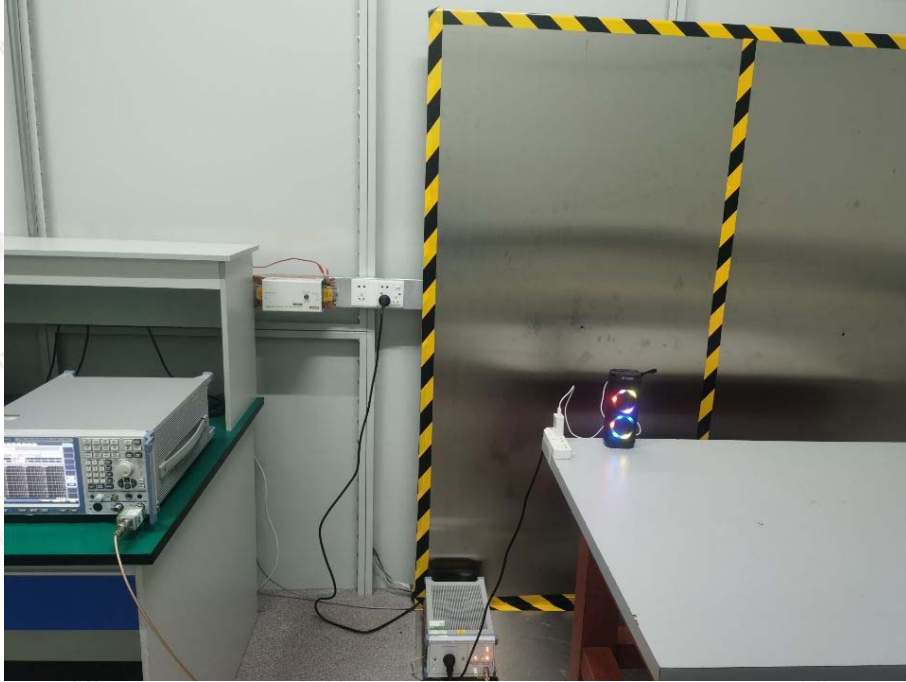

The results shown in this test report refer only to the sample(s) tested unless otherwise stated and the sample(s) are retained for 30 days only. The document is issued by HUAK, this document cannot be reproduced except in full with our prior written permission. The more details and the authenticity of the report will be confirmed at <http://www.cer-mark.com>.

TEL : +86-755 2302 9901 FAX : +86-755 2302 9901 E-mail : service@cer-mark.com

Addr: 1-2F., Building B2, Junfeng Zhongcheng Zhizao Innovation Park, Heping Community, Fuhai Street, Bao'an District, Shenzhen, Guangdong, China



5. PHOTOS OF THE EUT

Reference to the report: ANNEX A of external photos and ANNEX B of internal photos

-----End of test report-----