

TEST REPORT

Reference No...... : WTS17S0374778-2E
FCC ID : 2AICV-SIMTEL2200
Applicant..... : PHONEPAC S.A
Address..... : Ciudadela Nueva Kennedy Calle 3rd and Av.Olimpo, Guayaquil,
Ecuador
Manufacturer : Shenzhen Intel Technology Co.,Ltd.
Address..... : Rm.2168 Block C, Electronics Science &Technology Bldg., Futian
District, Shenzhen, Guangdong, China
Product Name..... : Mobile Phone
Model No..... : 2200, 3580, 2208, 2300
Brand..... : SIMTEL
Standards..... : FCC CFR47 Part 22 Subpart H: 2016
: FCC CFR47 Part 24 Subpart E: 2016
Date of Receipt sample : Mar. 28, 2017
Date of Test : Mar. 29 ~ Apr. 11, 2017
Date of Issue..... : Apr. 12, 2017
Test Result..... : **Pass**

Remarks:

The results shown in this test report refer only to the sample(s) tested, this test report cannot be reproduced, except in full, without prior written permission of the company. The report would be invalid without specific stamp of test institute and the signatures of compiler and approver.

Prepared By:

Waltek Services (Shenzhen) Co., Ltd.

Address: 1/F., Fukangtai Building, West Baima Road, Songgang Street, Baoan District, Shenzhen,
Guangdong, China

Tel :+86-755-83551033

Fax:+86-755-83552400

Compiled by:

Ford Wang

Ford Wang / Test Engineer

Approved by:



Philo Zhong

Philo Zhong / Manager

2 Laboratories Introduction

Waltek Services Test Group Ltd is a professional third-party testing and certification organization with multi-year product testing and certification experience, established strictly in accordance with ISO/IEC 17025 requirements, and accredited by CNAS (China National Accreditation Service for Conformity Assessment) AQS1Q, CMA and IECEE for CBTL. Meanwhile, Waltek has got recognition as registration and accreditation laboratory from EMSD (Electrical and Mechanical Services Department), and American Energy star, FCC(The Federal Communications Commission), CPSC(Consumer Product Safety Commission), CEC(California energy efficiency), IC(Industry Canada) and ELI(Efficient Lighting Initiative). It's the strategic partner and data recognition laboratory of international authoritative organizations, such as UL, Intertek(ETL-SEMKO), CSA, TÜV Rheinland, TÜV SÜD, etc.



Waltek Services Test Group Ltd. is one of the largest and the most comprehensive third party testing organizations in China, our headquarter located in Shenzhen and have branches in Foshan, Dongguan, Zhongshan, Suzhou, Ningbo and Hong Kong, Our test capability covered four large fields: safety test. ElectroMagnetic Compatibility(EMC), reliability and energy performance, Chemical test. As a professional, comprehensive, justice international test organization, we still keep the scientific and rigorous work attitude to help each client satisfy the international standards and assist their product enter into globe market smoothly.

3 Contents

| | Page |
|---|-------------|
| 1 COVER PAGE | 1 |
| 2 LABORATORIES INTRODUCTION | 2 |
| 3 CONTENTS | 3 |
| 4 REVISION HISTORY | 5 |
| 5 GENERAL INFORMATION | 6 |
| 5.1 GENERAL DESCRIPTION OF E.U.T. | 6 |
| 5.2 DETAILS OF E.U.T. | 6 |
| 5.3 TEST MODE | 8 |
| 5.4 TEST FACILITY..... | 8 |
| 6 TEST SUMMARY | 9 |
| 7 EQUIPMENT USED DURING TEST | 10 |
| 7.1 EQUIPMENTS LIST | 10 |
| 7.2 MEASUREMENT UNCERTAINTY | 11 |
| 7.3 TEST EQUIPMENT CALIBRATION | 11 |
| 8 RF OUTPUT POWER | 12 |
| 8.1 EUT OPERATION..... | 12 |
| 8.2 TEST PROCEDURE | 12 |
| 8.3 TEST RESULT | 13 |
| 9 PEAK-TO-AVERAGE RATIO | 16 |
| 9.1 EUT OPERATION..... | 16 |
| 9.2 TEST PROCEDURE | 16 |
| 9.3 TEST RESULT | 17 |
| 10 BANDWIDTH | 19 |
| 10.1 EUT OPERATION..... | 19 |
| 10.2 TEST PROCEDURE..... | 19 |
| 10.3 TEST RESULT | 20 |
| 11 SPURIOUS EMISSIONS AT ANTENNA TERMINALS | 23 |
| 11.1 EUT OPERATION..... | 23 |
| 11.2 TEST PROCEDURE..... | 23 |
| 11.3 TEST RESULT | 24 |
| 12 SPURIOUS RADIATED EMISSIONS | 28 |
| 12.1 EUT OPERATION..... | 28 |
| 12.2 TEST SETUP | 28 |
| 12.3 SPECTRUM ANALYZER SETUP | 29 |
| 12.4 TEST PROCEDURE..... | 30 |
| 12.5 SUMMARY OF TEST RESULTS | 31 |
| 13 BAND EDGE MEASUREMENT | 33 |
| 13.1 EUT OPERATION..... | 33 |
| 13.2 TEST PROCEDURE..... | 33 |
| 13.3 TEST RESULT | 34 |
| 14 FREQUENCY STABILITY | 38 |
| 14.1 EUT OPERATION..... | 38 |
| 14.2 TEST PROCEDURE..... | 38 |

| | | |
|-----------|---|-----------|
| 14.3 | TEST RESULT | 39 |
| 15 | RF EXPOSURE..... | 41 |
| 16 | PHOTOGRAPHS OF TEST SETUP AND EUT..... | 42 |

4 Revision History

| Test report No. | Date of Receipt sample | Date of Test | Date of Issue | Purpose | Comment | Approved |
|------------------|------------------------|----------------------------|---------------|----------|---------|----------|
| WTS17S0374778-2E | Mar. 28, 2017 | Mar. 29 ~ Apr. 11, 2017 | Apr. 12, 2017 | original | - | Valid |
| | | | | | | |

5 General Information

5.1 General Description of E.U.T.

| | |
|---------------------------------------|---|
| Product Name: | Mobile Phone |
| Model No.: | 2200, 3580, 2208, 2300 |
| Model Description: | Only the model names are different. |
| GSM Band(s): | GSM 850/900/1800/1900MHz |
| GPRS Class: | 12 |
| WCDMA Band(s): | N/A |
| LTE Band(s): | N/A |
| Wi-Fi Specification: | N/A |
| Bluetooth Version: | Bluetooth v3.0+EDR |
| GPS: | N/A |
| NFC: | N/A |
| Hardware Version: | Z3117-MB-V1.0 |
| Software Version: | sc6531_64X64_3100_K03_39_Claro_EXP_Spanish_20170303.zip |
| Highest frequency (Exclude Radio): | 312MHz |
| Storage Location: | Internal Storage |

Note: This EUT has two SIM card slots, and use same one RF module. We found that RF parameters are the same, when we insert the card 1 and card 2. So we usually performed the test under main card slot 1.

5.2 Details of E.U.T.

| | |
|-----------------------|--|
| Operation Frequency: | GSM/GPRS 850: 824~849MHz PCS/GPRS 1900: 1850~1910MHz Bluetooth: 2402~2480MHz |
| Max. RF output power: | GSM 850: 33.05dBm PCS1900: 30.01dBm Bluetooth: 0.70dBm |
| Type of Modulation: | GSM,GPRS: GMSK Bluetooth: GFSK, Pi/4 DQPSK, 8DPSK |
| Antenna installation: | GSM: internal permanent antenna Bluetooth: internal permanent antenna |
| Antenna Gain: | GSM 850: -1.5dBi PCS1900: -1.5dBi Bluetooth: -1.5dBi |

Technical Data: Battery DC 3.7V, 600mAh
DC 5.1 ~5.5V =0.5A±0.05A, charging from adapter
(Adapter Input: 100-240V~50Hz 0.35A)

Adapter: Manufacture: Zhongshan Xiongxing Technology Co.,Ltd.
Model No.: 7210

Type of Emission: GSM850: 248KGXW, GPRS850: 245KGXW,
PCS1900: 244KGXW, GPRS1900: 245KGXW,

5.3 Test Mode

All test mode(s) and condition(s) mentioned were considered and evaluated respectively by performing full tests, the worst data were recorded and reported.

| Support Band | Test Mode | Channel Frequency | Channel Number |
|--|-----------|-------------------|----------------|
| GSM 850 | GSM/GPRS | 824.2 MHz | 128 |
| | | 836.6 MHz | 190 |
| | | 848.8 MHz | 251 |
| PCS 1900 | GSM/GPRS | 1850.2 MHz | 512 |
| | | 1880.0 MHz | 661 |
| | | 1909.8 MHz | 810 |
| Remark: All mode(s) were tested and the worst data was recorded. | | | |

5.4 Test Facility

The test facility has a test site registered with the following organizations:

- **IC – Registration No.: 7760A**

Waltek Services(Shenzhen) Co., Ltd. Has been registered and fully described in a report filed with the Industry Canada. The acceptance letter from the Industry Canada is maintained in our files. Registration number 7760A, October 15, 2015.

- **FCC Test Site 1#– Registration No.: 880581**

Waltek Services(Shenzhen) Co., Ltd. EMC Laboratory `has been registered and fully described in a report filed with the (FCC) Federal Communications Commission. The acceptance letter from the FCC is maintained in our files. Registration 880581, April 29, 2014.

- **FCC Test Site 2#– Registration No.: 328995**

Waltek Services(Shenzhen) Co., Ltd. EMC Laboratory `has been registered and fully described in a report filed with the (FCC) Federal Communications Commission. The acceptance letter from the FCC is maintained in our files. Registration 328995, December 3, 2014.

6 Test Summary

| Test Items | Test Requirement | Result |
|--|--------------------------------------|--------|
| RF Output Power | 2.1046 22.913 (a) 24.232 (c) | PASS |
| Peak-to-Average Ratio | 24.232 (d) | PASS |
| Bandwidth | 2.1049 22.905 22.917 24.238 | PASS |
| Spurious Emissions at Antenna Terminal | 2.1051 22.917 (a) 24.238 (a) | PASS |
| Field Strength of Spurious Radiation | 2.1053 22.917 (a) 24.238 (a) | PASS |
| Out of band emission, Band Edge | 22.917 (a) 24.238 (a) | PASS |
| Frequency Stability | 2.1055 22.355 24.235 | PASS |
| Maximum Permissible Exposure (SAR) | 1.1307 2.1093 | PASS |

7 Equipment Used during Test

7.1 Equipments List

| Conducted Emissions Test Site 1# | | | | | | |
|---|--------------------------------------|----------------------|--------------|-----------------|-----------------------|----------------------|
| Item | Equipment | Manufacturer | Model No. | Serial No. | Last Calibration Date | Calibration Due Date |
| 1. | EMI Test Receiver | R&S | ESCI | 100947 | Sep.12,2016 | Sep.11,2017 |
| 2. | LISN | R&S | ENV216 | 101215 | Sep.12,2016 | Sep.11,2017 |
| 3. | Cable | Top | TYPE16(3.5M) | - | Sep.12,2016 | Sep.11,2017 |
| Conducted Emissions Test Site 2# | | | | | | |
| Item | Equipment | Manufacturer | Model No. | Serial No. | Last Calibration Date | Calibration Due Date |
| 1. | EMI Test Receiver | R&S | ESCI | 101155 | Sep.12,2016 | Sep.11,2017 |
| 2. | LISN | SCHWARZBECK | NSLK 8128 | 8128-289 | Sep.12,2016 | Sep.11,2017 |
| 3. | Limiter | York | MTS-IMP-136 | 261115-001-0024 | Sep.12,2016 | Sep.11,2017 |
| 4. | Cable | LARGE | RF300 | - | Sep.12,2016 | Sep.11,2017 |
| 3m Semi-anechoic Chamber for Radiation Emissions Test site 1# | | | | | | |
| Item | Equipment | Manufacturer | Model No. | Serial No. | Last Calibration Date | Calibration Due Date |
| 1 | Spectrum Analyzer | R&S | FSP | 100091 | Apr.29, 2016 | Apr.28, 2017 |
| 2 | Active Loop Antenna | Beijing Dazhi | ZN30900A | - | Apr.09,2017 | Apr.08,2018 |
| 3 | Trilog Broadband Antenna | SCHWARZBECK | VULB9163 | 336 | Apr.09,2016 | Apr.08,2017 |
| 4 | Coaxial Cable (below 1GHz) | Top | TYPE16(13M) | - | Sep.12,2016 | Sep.11,2017 |
| 5 | Broad-band Horn Antenna | SCHWARZBECK | BBHA 9120 D | 667 | Apr.09,2017 | Apr.08,2018 |
| 6 | Broad-band Horn Antenna | SCHWARZBECK | BBHA 9170 | 335 | Apr.09,2017 | Apr.08,2018 |
| 7 | Broadband Pre-amplifier | COMPLIANCE DIRECTION | PAP-1G18 | 2004 | Apr.13,2016 | Apr.12,2017 |
| 8 | Coaxial Cable (above 1GHz) | Top | 1GHz-25GHz | EW02014-7 | Apr.13,2016 | Apr.12,2017 |
| 9 | Universal Radio Communication Tester | R&S | CMU 200 | 112461 | Apr.13,2016 | Apr.12,2017 |
| 10 | Signal Generator | R&S | SMR20 | 100046 | Sep.12,2016 | Sep.11,2017 |
| 11 | Smart Antenna | SCHWARZBECK | HA08 | - | Apr.09,2017 | Apr.08,2018 |
| 3m Semi-anechoic Chamber for Radiation Emissions Test site 2# | | | | | | |
| Item | Equipment | Manufacturer | Model No. | Serial No | Last Calibration Date | Calibration Due Date |

| 1 | Test Receiver | R&S | ESCI | 101296 | Apr.13,2016 | Apr.12,2017 |
|-----------------------------|--|--|-----------|------------|-----------------------|----------------------|
| 2 | Trilog Broadband Antenna | SCHWARZBECK | VULB9160 | 9160-3325 | Apr.09,2017 | Apr.08,2018 |
| 3 | Amplifier | Compliance pirection systems inc | PAP-0203 | 22024 | Apr.13,2016 | Apr.12,2017 |
| 4 | Cable | HUBER+SUHNER | CBL2 | 525178 | Apr.13,2016 | Apr.12,2017 |
| RF Conducted Testing | | | | | | |
| Item | Equipment | Manufacturer | Model No. | Serial No. | Last Calibration Date | Calibration Due Date |
| 1. | EMC Analyzer (9k~26.5GHz) | Agilent | E7405A | MY45114943 | Sep.12,2016 | Sep.11,2017 |
| 2. | Spectrum Analyzer (9k-6GHz) | R&S | FSL6 | 100959 | Sep.12,2016 | Sep.11,2017 |
| 3. | Universal Radio Communication Tester | R&S | CMU 200 | 112461 | Apr.13,2016 | Apr.12,2017 |
| 4 | Signal Analyzer (9k~26.5GHz) | Agilent | N9010A | MY50520207 | Sep.12,2016 | Sep.11,2017 |

7.2 Measurement Uncertainty

| Parameter | Uncertainty |
|---|---|
| Radio Frequency | $\pm 1 \times 10^{-6}$ |
| RF Power | ± 1.0 dB |
| RF Power Density | ± 2.2 dB |
| Radiated Spurious Emissions test | ± 5.03 dB (Bilog antenna 30M~1000MHz) |
| | ± 5.47 dB (Horn antenna 1000M~25000MHz) |
| Conducted Spurious Emissions test | ± 3.64 dB (AC mains 9KHz~30MHz) |
| Confidence interval: 95%. Confidence factor:k=2 | |

7.3 Test Equipment Calibration

All the test equipments used are valid and calibrated by CEPREI Certification Body that address is No.110 Dongguan Zhuang RD. Guangzhou, P.R.China.

8 RF OUTPUT POWER

| | |
|-------------------|--|
| Test Requirement: | FCC Part 2.1046, 22.913 (a), 24.232 (c) |
| Test Method: | TIA/EIA-603-D:2010 KDB971168 D01 v02r02 |
| Test Mode: | TX transmitting |

8.1 EUT Operation

Operating Environment :

| | |
|-----------------------|-----------|
| Temperature: | 22.5 °C |
| Humidity: | 52.1 % RH |
| Atmospheric Pressure: | 101.2kPa |

8.2 Test Procedure

Conducted method:

The RF output of the transmitter was connected to the wireless test set and the spectrum analyzer through sufficient attenuation.

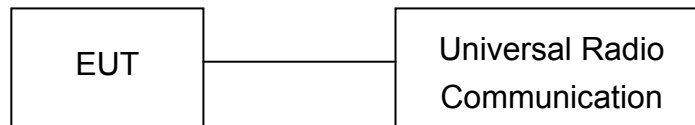

Radiated method:

1. The setup of EUT is according with per TIA/EIA Standard 603D.
2. The measurement antenna was placed at a distance of 3 meters from the EUT. During the tests, the antenna height and polarization as well as EUT azimuth were varied in order to identify the maximum level of emissions from the EUT. The test was performed by placing the EUT on 3-orthogonal axis.
3. The frequency range up to tenth harmonic of the fundamental frequency was investigated.
4. Remove the EUT and replace it with substitution antenna. A signal generator was connected to the substitution antenna by a non-radiating cable. The absolute levels of the spurious emissions were measured by the substitution.

8.3 Test Result

| Conducted Power | | | | | | |
|--|---------------|--------------|--------------|----------------|-------------|---------------|
| GSM - Burst Average Power (dBm) | | | | | | |
| Band | GSM850 | | | PCS1900 | | |
| Channel | 128 | 190 | 251 | 512 | 661 | 810 |
| Frequency (MHz) | 824.2 | 836.6 | 848.8 | 1850.2 | 1880 | 1909.8 |
| GSM | 32.85 | 32.72 | 32.73 | 29.95 | 29.93 | 29.59 |
| GPRS (1 slot) | 33.05 | 33.00 | 32.83 | 29.87 | 30.01 | 29.59 |
| GPRS (2 slots) | 31.48 | 31.69 | 31.47 | 28.59 | 28.69 | 28.47 |
| GPRS (3 slots) | 30.49 | 30.24 | 30.17 | 27.18 | 27.49 | 27.34 |
| GPRS (4 slots) | 29.35 | 29.09 | 29.18 | 26.51 | 26.20 | 26.42 |

Radiated Power

ERP and EIRP

Cellular Band 850 (Part 22H)

| Frequency | Receiver Reading | Turn table Angle | RX Antenna | | Substituted | | | Absolute Level | Part 22H | |
|----------------------|------------------|------------------|------------|-------|-------------|-------|--------------|----------------|----------|--------|
| | | | Height | Polar | SG Level | Cable | Antenna Gain | | Limit | Margin |
| (MHz) | (dBμV) | Degree | (m) | (H/V) | (dBm) | (dB) | (dB) | (dBm) | (dBm) | (dB) |
| GSM 850 Channel 128 | | | | | | | | | | |
| 824.20 | 92.55 | 172 | 2.2 | H | 25.52 | 0.20 | 0.00 | 25.32 | 38.45 | -13.13 |
| 824.20 | 97.96 | 92 | 2.1 | V | 30.86 | 0.20 | 0.00 | 30.66 | 38.45 | -7.79 |
| GSM 850 Channel 190 | | | | | | | | | | |
| 836.60 | 90.41 | 12 | 2.3 | H | 23.38 | 0.20 | 0.00 | 23.18 | 38.45 | -15.27 |
| 836.60 | 97.49 | 290 | 2.2 | V | 30.39 | 0.20 | 0.00 | 30.19 | 38.45 | -8.26 |
| GSM 850 Channel 251 | | | | | | | | | | |
| 848.80 | 90.54 | 109 | 1.3 | H | 23.51 | 0.20 | 0.00 | 23.31 | 38.45 | -15.14 |
| 848.80 | 97.28 | 45 | 2.2 | V | 30.18 | 0.20 | 0.00 | 29.98 | 38.45 | -8.47 |
| GPRS 850 Channel 128 | | | | | | | | | | |
| 824.20 | 92.50 | 155 | 1.2 | H | 25.47 | 0.20 | 0.00 | 25.27 | 38.45 | -13.18 |
| 824.20 | 97.98 | 4 | 1.8 | V | 30.88 | 0.20 | 0.00 | 30.68 | 38.45 | -7.77 |
| GPRS 850 Channel 190 | | | | | | | | | | |
| 836.60 | 92.75 | 353 | 1.8 | H | 25.72 | 0.20 | 0.00 | 25.52 | 38.45 | -12.93 |
| 836.60 | 97.25 | 309 | 1.8 | V | 30.15 | 0.20 | 0.00 | 29.95 | 38.45 | -8.50 |
| GPRS 850 Channel 251 | | | | | | | | | | |
| 848.80 | 93.84 | 131 | 1.4 | H | 26.81 | 0.20 | 0.00 | 26.61 | 38.45 | -11.84 |
| 848.80 | 97.02 | 342 | 2.4 | V | 29.92 | 0.20 | 0.00 | 29.72 | 38.45 | -8.73 |

Cellular Band 1900 (Part 24E)

| Frequency | Receiver Reading | Turn table Angle | RX Antenna | | Substituted | | | Absolute Level | Part 24E | |
|-----------------------|------------------|------------------|------------|-------|-------------|-------|--------------|----------------|----------|--------|
| | | | Height | Polar | SG Level | Cable | Antenna Gain | | Limit | Margin |
| (MHz) | (dBμV) | Degree | (m) | (H/V) | (dBm) | (dB) | (dB) | (dBm) | (dBm) | (dB) |
| PCS 1900 Channel 512 | | | | | | | | | | |
| 1850.20 | 84.74 | 211 | 1.4 | H | 10.77 | 0.31 | 10.40 | 20.86 | 33 | -12.14 |
| 1850.20 | 92.46 | 295 | 2.1 | V | 19.18 | 0.31 | 10.40 | 29.27 | 33 | -3.73 |
| PCS 1900 Channel 661 | | | | | | | | | | |
| 1880.00 | 86.43 | 19 | 1.9 | H | 12.58 | 0.31 | 10.40 | 22.67 | 33 | -10.33 |
| 1880.00 | 92.97 | 191 | 1.7 | V | 19.85 | 0.31 | 10.40 | 29.94 | 33 | -3.06 |
| PCS 1900 Channel 810 | | | | | | | | | | |
| 1909.80 | 86.49 | 67 | 2.4 | H | 12.76 | 0.32 | 10.40 | 22.84 | 33 | -10.16 |
| 1909.80 | 92.01 | 197 | 2.3 | V | 19.05 | 0.32 | 10.40 | 29.13 | 33 | -3.87 |
| GPRS 1900 Channel 512 | | | | | | | | | | |
| 1850.20 | 87.55 | 207 | 1.8 | H | 13.58 | 0.31 | 10.40 | 23.67 | 33 | -9.33 |
| 1850.20 | 92.87 | 103 | 1.1 | V | 19.59 | 0.31 | 10.40 | 29.68 | 33 | -3.32 |
| GPRS 1900 Channel 661 | | | | | | | | | | |
| 1880.00 | 86.42 | 246 | 1.2 | H | 12.57 | 0.31 | 10.40 | 22.66 | 33 | -10.34 |
| 1880.00 | 92.84 | 204 | 1.4 | V | 19.72 | 0.31 | 10.40 | 29.81 | 33 | -3.19 |
| GPRS 1900 Channel 810 | | | | | | | | | | |
| 1909.80 | 85.95 | 57 | 2.5 | H | 12.22 | 0.32 | 10.40 | 22.30 | 33 | -10.70 |
| 1909.80 | 92.17 | 207 | 1.2 | V | 19.21 | 0.32 | 10.40 | 29.29 | 33 | -3.71 |

9 Peak-to-Average Ratio

| | |
|-------------------|-----------------|
| Test Requirement: | 24.232 (d) |
| Test Method: | N/A |
| Test Mode: | TX transmitting |

9.1 EUT Operation

Operating Environment :

| | |
|-----------------------|----------|
| Temperature: | 22.5 °C |
| Humidity: | 52.3% RH |
| Atmospheric Pressure: | 101.2kPa |

9.2 Test Procedure

1. The EUT was connected to spectrum analyzer and system simulator via a power divider.
2. Set EUT to transmit at maximum output power.
3. When the duty cycle is less than 98%, then signal gating will be implemented on the spectrum analyzer by triggering from the system simulator.
4. Set the CCDF (Complementary Cumulative Distribution Function) option of the spectrum analyzer. Record the maximum PAPR level associated with a probability of 0.1%.

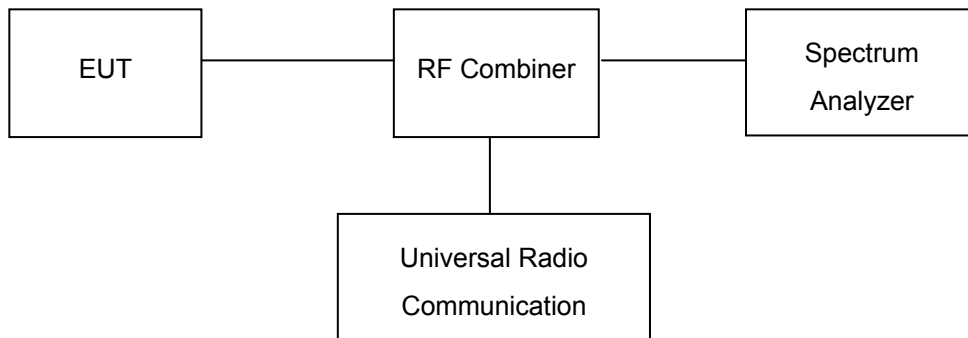

9.3 Test Result

Cellular Band (Part 24E)

Remark: All test data were reported and only the worst case (middle channel mode) test graphs were showed in test report.

| Mode | PCS 1900 | | | GPRS 1900 | | | Limit (dB) |
|----------------------------|----------|--------|--------|-----------|--------|--------|------------|
| Channel | 512 | 661 | 810 | 512 | 661 | 810 | |
| Frequency (MHz) | 1850.2 | 1880.0 | 1909.8 | 1850.2 | 1880.0 | 1909.8 | |
| Peak-to-Average Ratio (dB) | 9.26 | 9.34 | 9.33 | 10.02 | 10.08 | 10.05 | 13 |

Test Plots (Part 24E)

PCS1900 Middle Channel

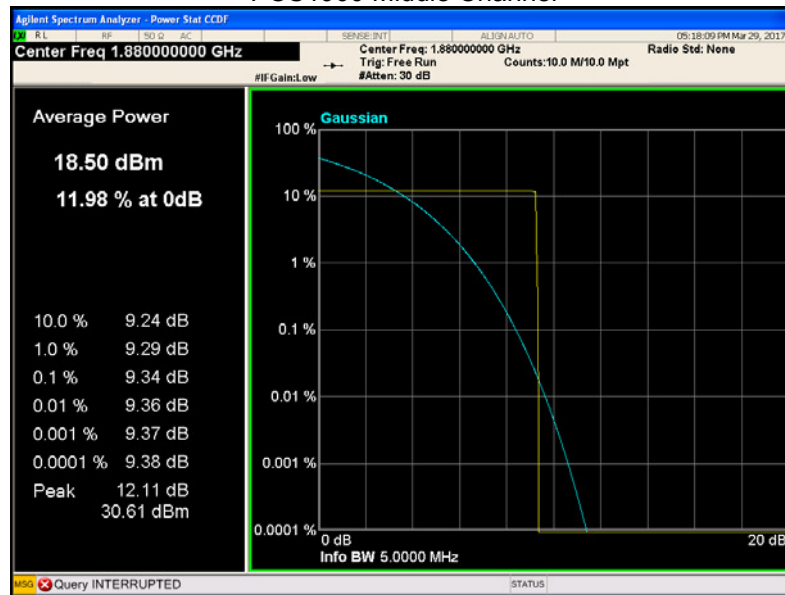

GPRS 1900 Middle Channel

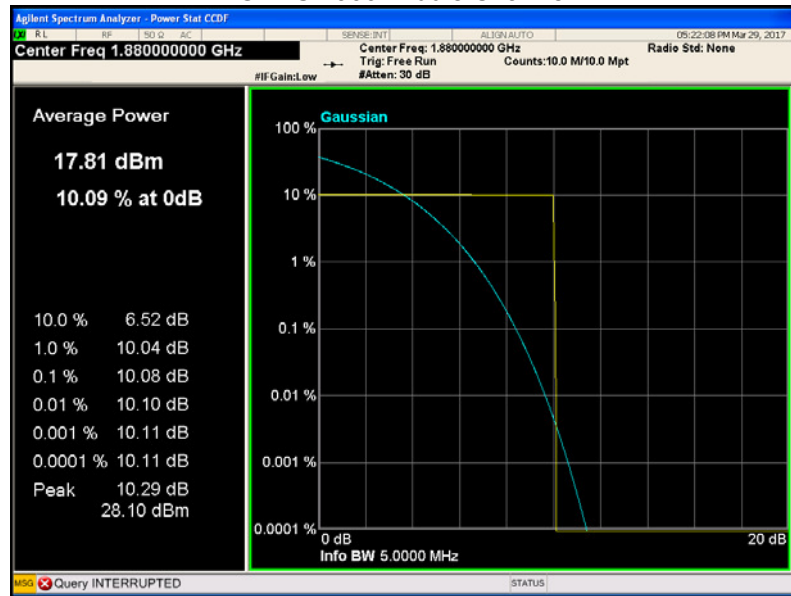

10 BANDWIDTH

| | |
|-------------------|--|
| Test Requirement: | FCC Part 2.1049, 22.917, 22.905, 24.238 |
| Test Method: | TIA/EIA-603-D:2010 KDB971168 D01 v02r02 |
| Test Mode: | TX transmitting |

10.1 EUT Operation

Operating Environment :

| | |
|-----------------------|----------|
| Temperature: | 22.5 °C |
| Humidity: | 52.3% RH |
| Atmospheric Pressure: | 101.2kPa |

10.2 Test Procedure

The RF output of the transmitter was connected to the wireless test set and the spectrum analyzer through sufficient attenuation.

The resolution bandwidth of the spectrum analyzer was set in the range of 1 to 5 % of the anticipated OBW (Cellular /PCS) and the 26 dB & 99%bandwidth was recorded.

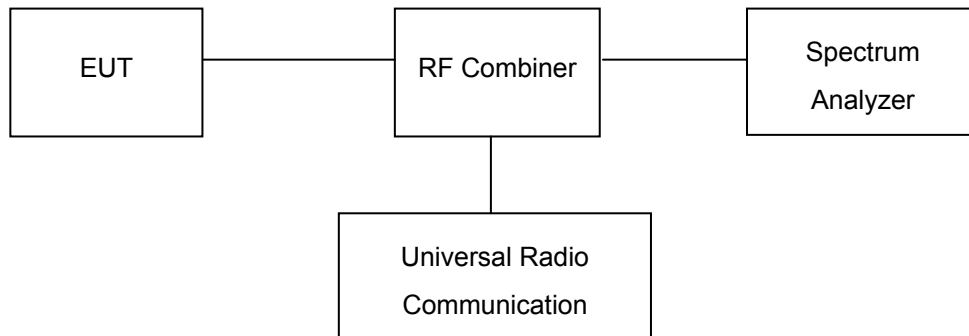

10.3 Test Result

Remark: All test data were reported and only the worst case (middle channel mode) test graphs were showed in test report.

Cellular Band (Part 22H)

| Test Mode | Channel | Frequency (MHz) | 99% Occupied Bandwidth(kHz) | 26 dB Emission Bandwidth(kHz) |
|-----------|---------|-----------------|-----------------------------|-------------------------------|
| GSM 850 | 128 | 824.2 | 248.11 | 311.49 |
| | 190 | 836.6 | 248.11 | 311.50 |
| | 251 | 848.8 | 248.10 | 311.49 |
| GPRS 850 | 128 | 824.2 | 245.27 | 312.69 |
| | 190 | 836.6 | 245.27 | 312.70 |
| | 251 | 848.8 | 245.26 | 312.70 |

Cellular Band (Part 24E)

| Test Mode | Channel | Frequency (MHz) | 99% Occupied Bandwidth(kHz) | 26 dB Emission Bandwidth(kHz) |
|-----------|---------|-----------------|-----------------------------|-------------------------------|
| PCS 1900 | 512 | 1850.2 | 243.77 | 311.60 |
| | 661 | 1880.0 | 243.78 | 311.60 |
| | 810 | 1909.8 | 243.77 | 311.59 |
| GPRS 1900 | 512 | 1850.2 | 245.05 | 314.99 |
| | 661 | 1880.0 | 245.06 | 315.00 |
| | 810 | 1909.8 | 245.05 | 314.99 |

Test Plots (worst case)
 Cellular Band (Part 22H)
 GSM 850

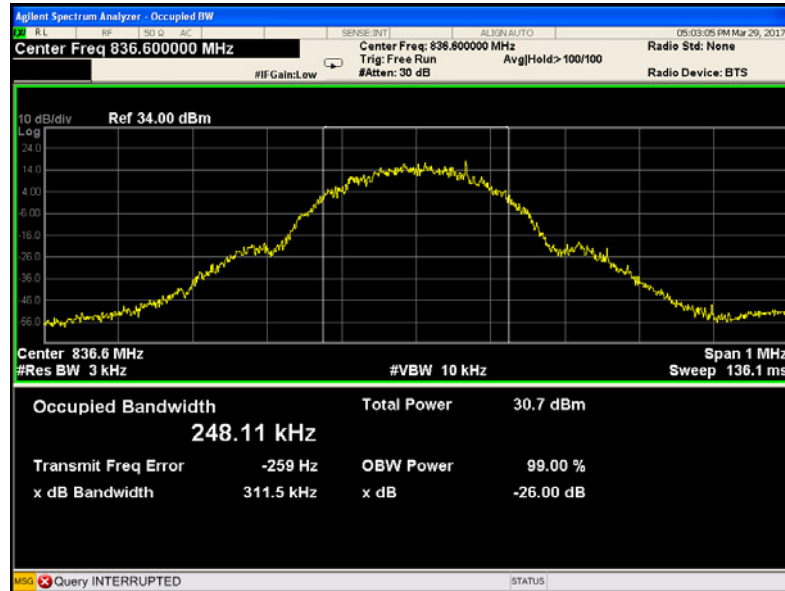

GPRS 850

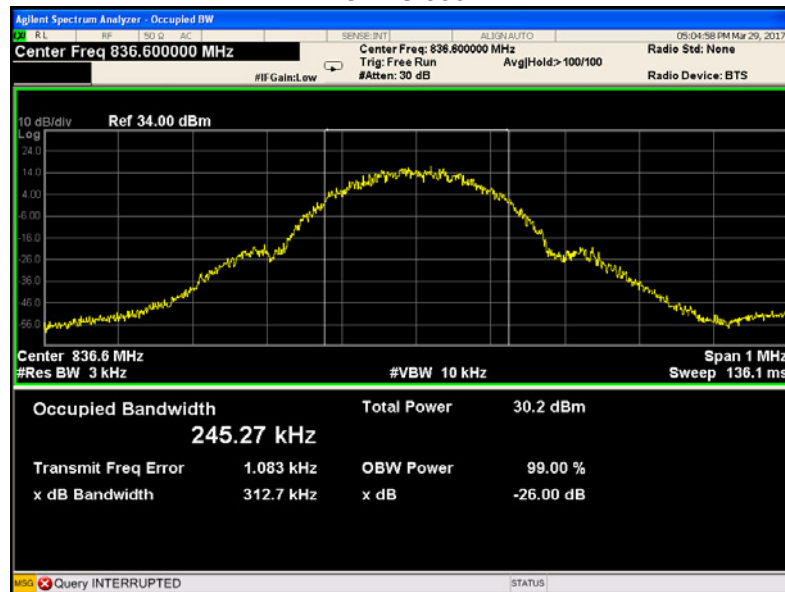

Cellular Band (Part 24E)

PCS 1900

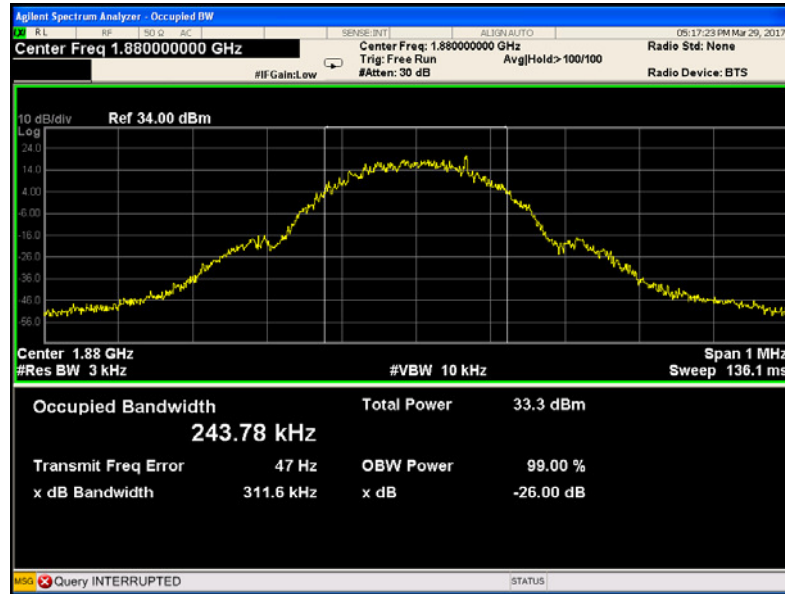

GPRS 1900

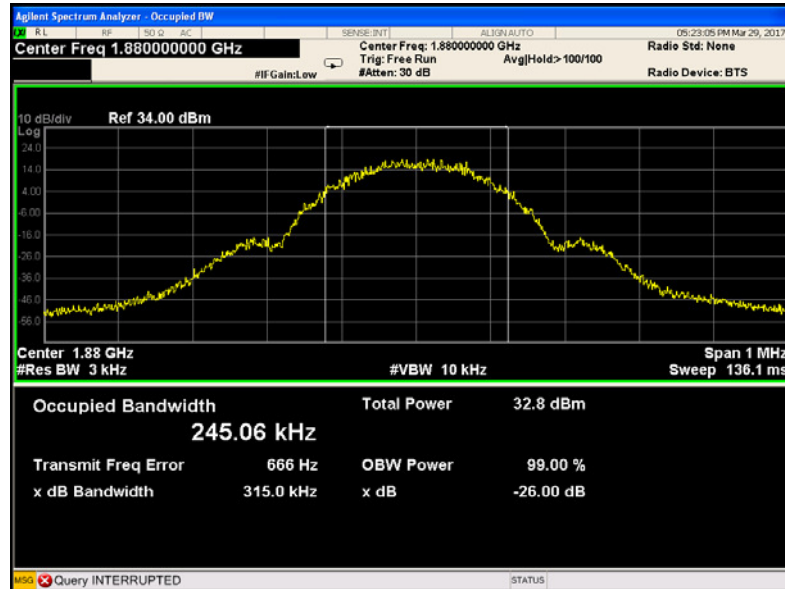

11 SPURIOUS EMISSIONS AT ANTENNA TERMINALS

| | |
|-------------------|--|
| Test Requirement: | FCC Part 2.1051, 22.917(a), 24.238(a) |
| Test Method: | TIA/EIA-603-D:2010 KDB971168 D01 v02r02 |
| Test Mode: | TX transmitting |

11.1 EUT Operation

Operating Environment :

| | |
|-----------------------|-----------|
| Temperature: | 23.5 °C |
| Humidity: | 52.1 % RH |
| Atmospheric Pressure: | 101.3kPa |

11.2 Test Procedure

The RF output of the transceiver was connected to a spectrum analyzer and simulator through appropriate attenuation. The resolution bandwidth of the spectrum analyzer was set at 1MHz. Sufficient scans were taken to show any out of band emissions up to 10th harmonics.

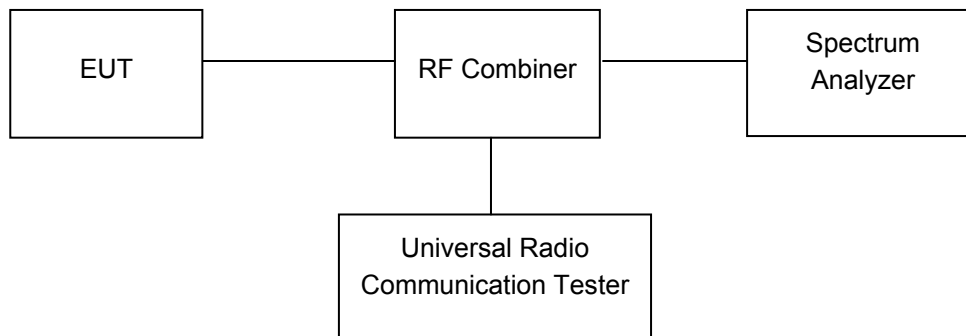

11.3 Test Result

Remark: All test data were reported and only the worst case (low channel mode) test graphs were showed in test report.

Cellular Band (Part 22H)

GSM 850 - channel 128

30MHz-1GHz

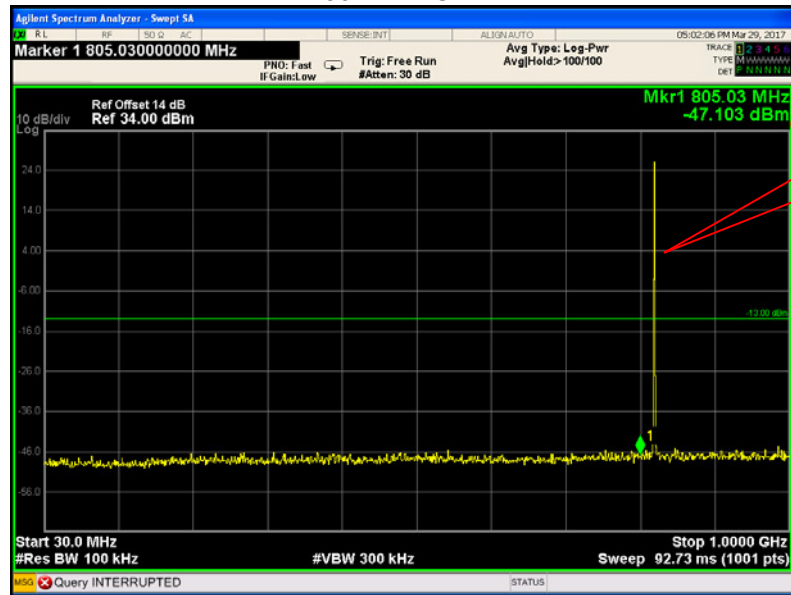

Above 1GHz

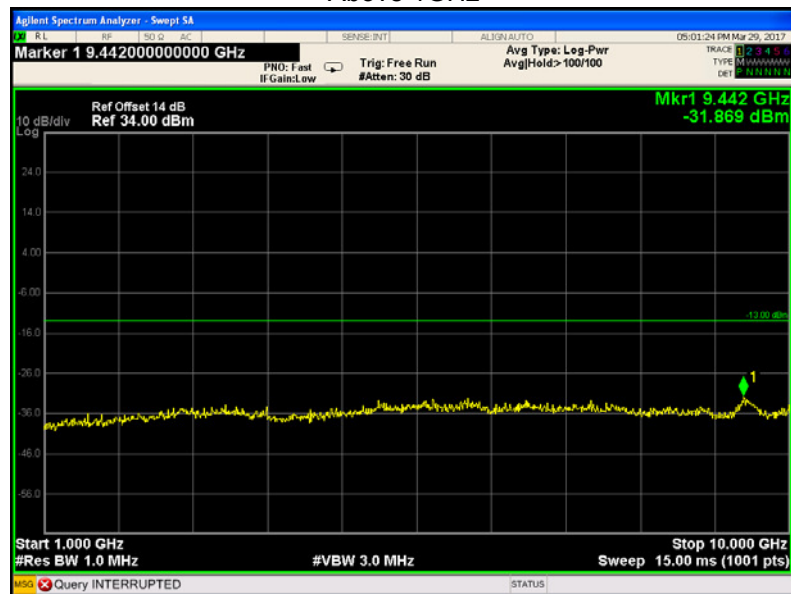

Cellular Band (Part 22H)
GPRS 850 - channel 128
30MHz-1GHz

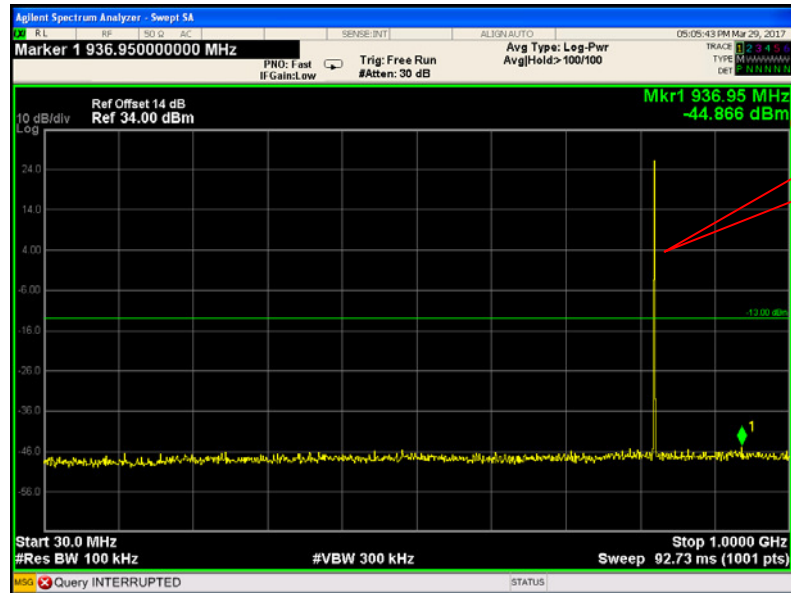

Above 1GHz

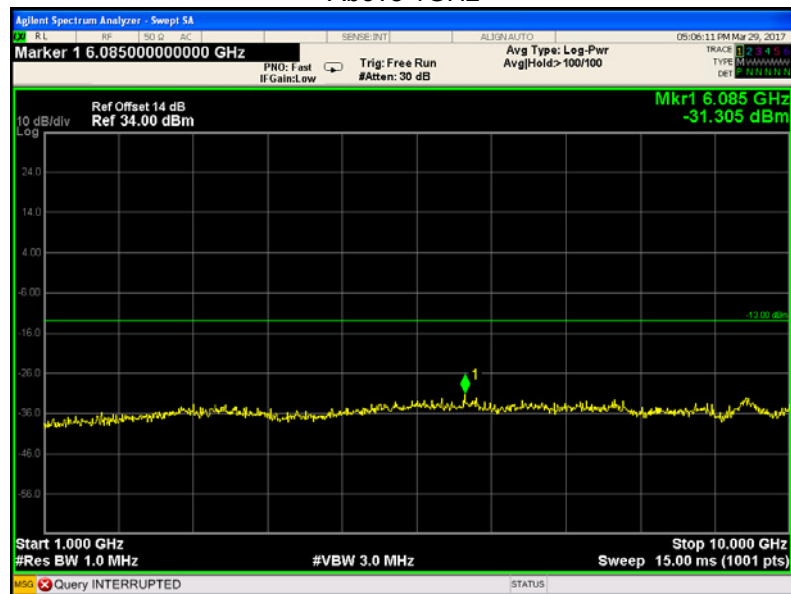

Cellular Band (Part 24E)
PCS 1900 - channel 512
30MHz-1GHz

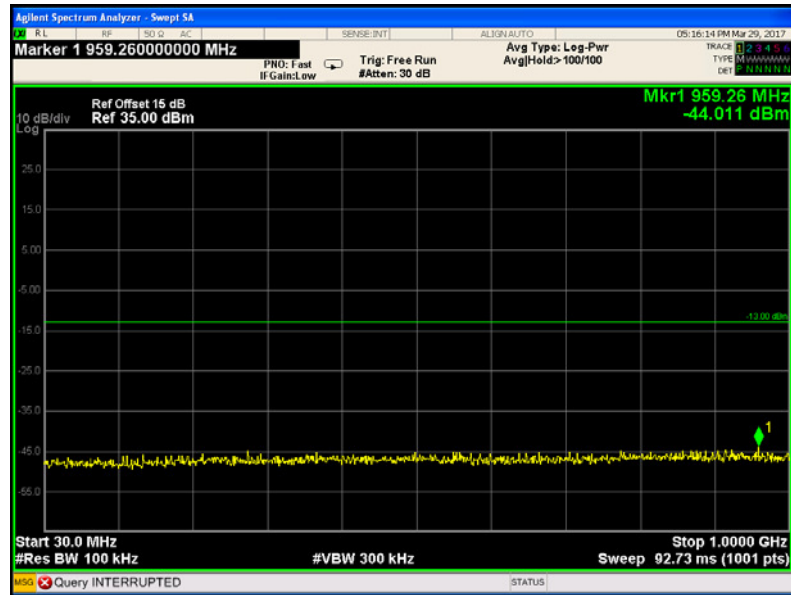

Above 1GHz

Fundamental

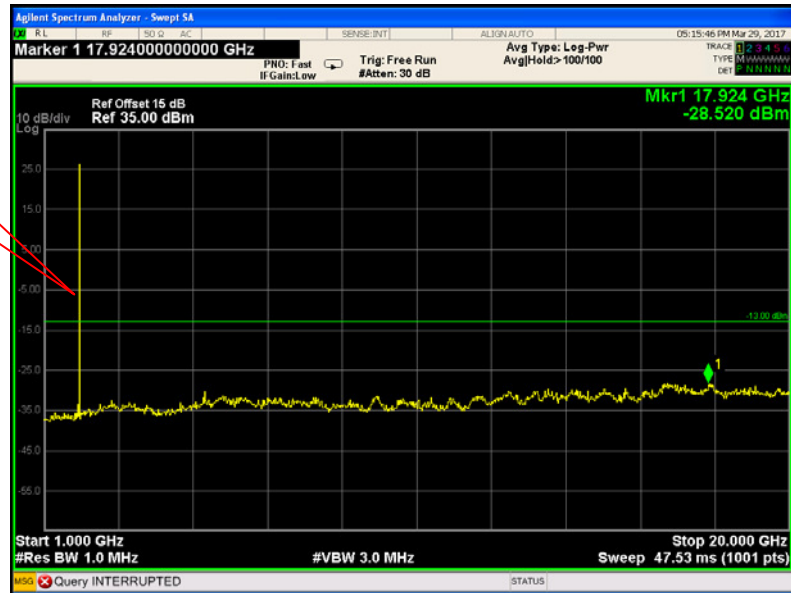

Cellular Band (Part 24E)
GPRS 1900 - channel 512
30MHz-1GHz

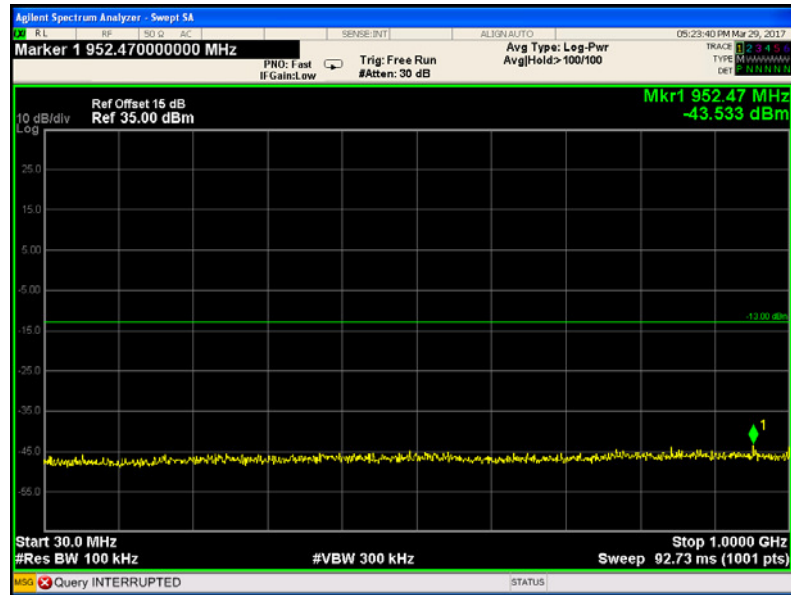

Above 1GHz

Fundamental

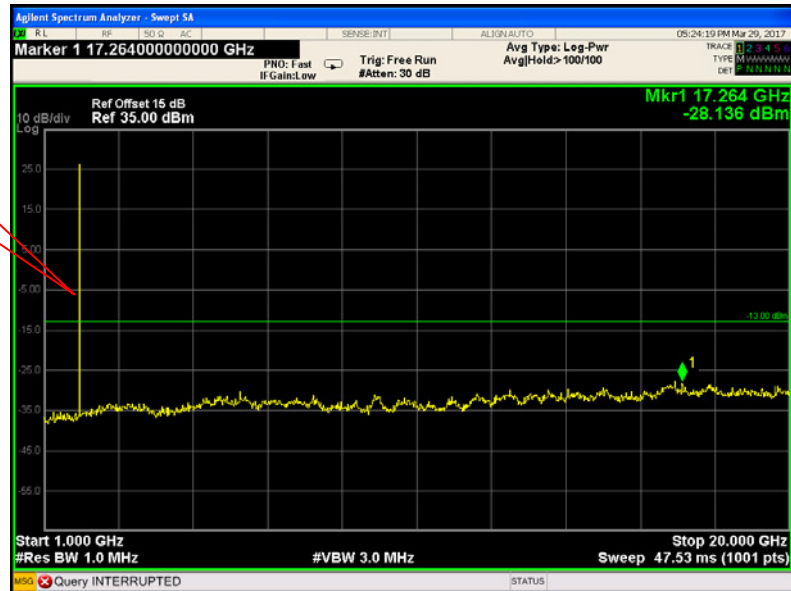

12 SPURIOUS RADIATED EMISSIONS

| | |
|-------------------|--|
| Test Requirement: | FCC Part 2.1053, 22.917, 24.238 |
| Test Method: | TIA/EIA-603-D:2010 KDB971168 D01 v02r02 |
| Test Mode: | TX transmitting |

12.1 EUT Operation

| | |
|-------------------------|-----------|
| Operating Environment : | |
| Temperature: | 23.5 °C |
| Humidity: | 52.1 % RH |
| Atmospheric Pressure: | 101.2kPa |

12.2 Test Setup

The radiated emission tests were performed in the 3m Semi- Anechoic Chamber test site. The test setup for emission measurement from 30 MHz to 1 GHz.

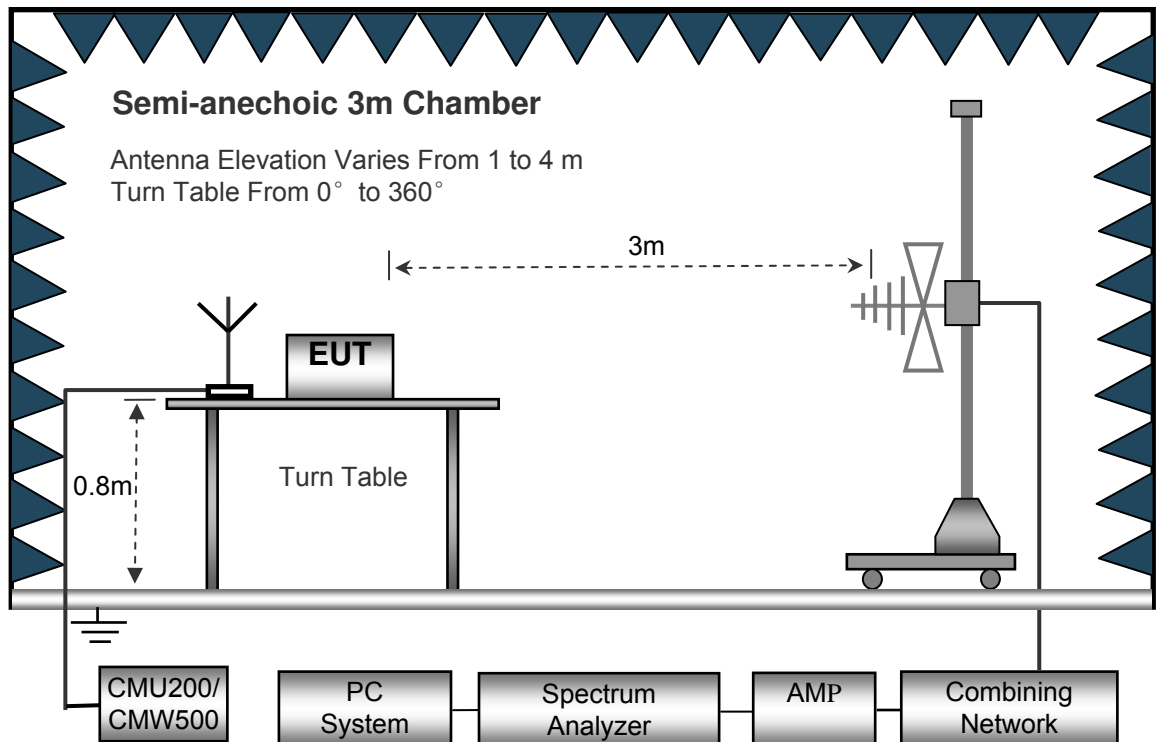

The test setup for emission measurement above 1 GHz.

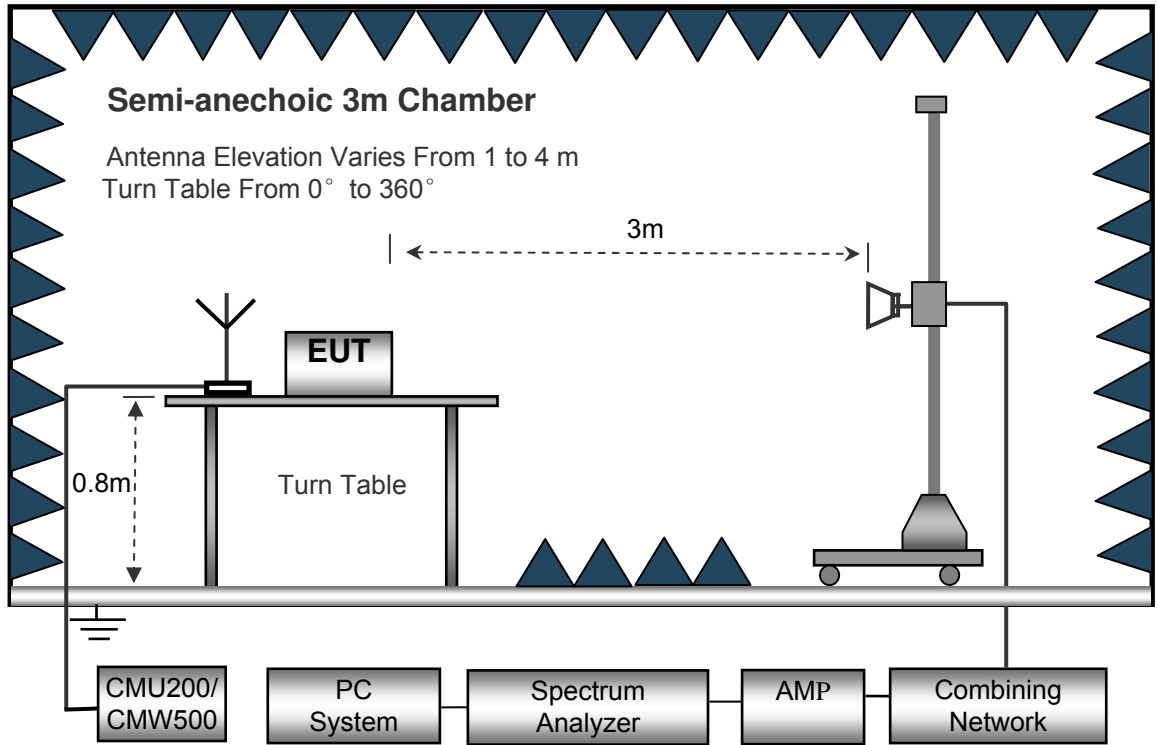

12.3 Spectrum Analyzer Setup

30MHz ~ 1GHz

- Sweep Speed Auto
- Detector PK
- Resolution Bandwidth..... 100kHz
- Video Bandwidth..... 300kHz

Above 1GHz

- Sweep Speed Auto
- Detector PK
- Resolution Bandwidth..... 1MHz
- Video Bandwidth..... 3MHz
- Detector Ave.
- Resolution Bandwidth..... 1MHz
- Video Bandwidth..... 10Hz

12.4 Test Procedure

1. The EUT is placed on a turntable, which is 0.8m above ground plane.
2. The turntable shall be rotated for 360 degrees to determine the position of maximum emission level.
3. EUT is set 3m away from the receiving antenna, which is moved from 1m to 4m to find out the maximum emissions. The spectrum was investigated from 30MHz up to the tenth harmonic of the highest fundamental frequency.
4. Maximum procedure was performed on the six highest emissions to ensure EUT compliance.
5. And also, each emission was to be maximized by changing the polarization of receiving antenna both horizontal and vertical.
6. The radiation measurements are tested under 3-axes(X,Y,Z) position(X denotes lying on the table, Y denotes side stand and Z denotes vertical stand), After pre-test, It was found that the worse radiation emission was get at the Z position. So the data shown was the Z position only.
7. Remove the EUT and replace it with substitution antenna. A signal generator was connected to the substitution antenna by a non-radiating cable. The absolute levels of the spurious emissions were measured by the substitution.
Spurious emissions in dB = $10 \lg(\text{TXpwr in Watts}/0.001)$ – the absolute level
Spurious attenuation limit in dB = $43 + 10 \text{Log}_{10}(\text{power out in Watts})$
8. Repeat above procedures until the measurements for all frequencies are completed.

12.5 Summary of Test Results

For 26MHz~30MHz,

The measurements were more than 20 dB below the limit and not reported.

Remark: Test performed from 30MHz to 10th harmonics with low/middle/high channels, only the worst data were recorded.

Cellular Band (Part 22H)

| Frequency | Receiver Reading | Turn table Angle | RX Antenna | | Substituted | | | Absolute Level | Result | |
|---------------------|------------------|------------------|------------|-------|-------------|-------|--------------|----------------|--------|--------|
| | | | Height | Polar | SG Level | Cable | Antenna Gain | | Limit | Margin |
| (MHz) | (dB μ V) | Degree | (m) | (H/V) | (dBm) | (dB) | (dB) | (dBm) | (dBm) | (dB) |
| GSM 850 Channel 128 | | | | | | | | | | |
| 216.37 | 41.36 | 357 | 1.0 | H | -69.15 | 0.15 | 0.00 | -69.30 | -13.00 | -56.30 |
| 216.37 | 43.17 | 292 | 1.4 | V | -64.42 | 0.15 | 0.00 | -64.57 | -13.00 | -51.57 |
| 1648.40 | 66.43 | 209 | 1.3 | H | -47.54 | 0.30 | 9.40 | -38.44 | -13.00 | -25.44 |
| 1648.40 | 58.33 | 161 | 1.9 | V | -55.20 | 0.30 | 9.40 | -46.10 | -13.00 | -33.10 |
| 2472.60 | 59.13 | 325 | 1.1 | H | -54.87 | 0.43 | 10.60 | -44.70 | -13.00 | -31.70 |
| 2472.60 | 48.94 | 289 | 2.1 | V | -61.34 | 0.43 | 10.60 | -51.17 | -13.00 | -38.17 |

Cellular Band (Part 24E)

| Frequency | Receiver Reading | Turn table Angle | RX Antenna | | Substituted | | | Absolute Level | Result | |
|----------------------|------------------|------------------|------------|-------|-------------|-------|--------------|----------------|--------|--------|
| | | | Height | Polar | SG Level | Cable | Antenna Gain | | Limit | Margin |
| (MHz) | (dBμV) | Degree | (m) | (H/V) | (dBm) | (dB) | (dB) | (dBm) | (dBm) | (dB) |
| PCS 1900 Channel 512 | | | | | | | | | | |
| 216.37 | 50.29 | 192 | 1.9 | H | -60.22 | 0.15 | 0.00 | -60.37 | -13.00 | -47.37 |
| 216.37 | 39.93 | 158 | 1.5 | V | -67.66 | 0.15 | 0.00 | -67.81 | -13.00 | -54.81 |
| 3700.40 | 65.95 | 309 | 1.3 | H | -45.59 | 2.37 | 12.50 | -35.46 | -13.00 | -22.46 |
| 3700.40 | 59.98 | 169 | 1.6 | V | -49.83 | 2.37 | 12.50 | -39.70 | -13.00 | -26.70 |
| 5550.60 | 53.58 | 338 | 1.2 | H | -56.03 | 2.86 | 12.90 | -45.99 | -13.00 | -32.99 |
| 5550.60 | 44.73 | 57 | 1.1 | V | -64.15 | 2.86 | 12.90 | -54.11 | -13.00 | -41.11 |

Note: 1) Absolute Level = SG Level - Cable loss + Antenna Gain

2) Margin = Limit- Absolute Level

13 Band Edge Measurement

| | |
|-------------------|--|
| Test Requirement: | FCC Part 2.1051, 22.917(a), 24.238(a) |
| Test Method: | TIA/EIA-603-D:2010 KDB971168 D01 v02r02 |
| Test Mode: | TX transmitting |

13.1 EUT Operation

Operating Environment :

| | |
|-----------------------|-----------|
| Temperature: | 23.5 °C |
| Humidity: | 52.3 % RH |
| Atmospheric Pressure: | 101.3kPa |

13.2 Test Procedure

The RF output of the transmitter was connected to the input of the spectrum analyzer through sufficient attenuation.

According to FCC Part 22.917(a), the power of any emissions outside of the authorized operating frequency ranges must be attenuated below the TX transmitting power (P) by a factor of at least $43 + 10 \log(P)$ dB.

According to FCC Part 24.238(a), the power of any emissions outside of the authorized operating frequency ranges must be attenuated below the TX transmitting power (P) by a factor of at least $43 + 10 \log(P)$ dB.

The center of the spectrum analyzer was set to block edge frequency

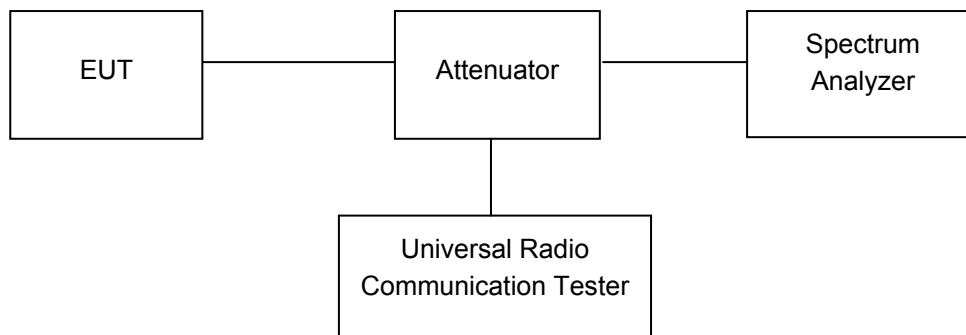

13.3 Test Result

Test plots
Cellular Band (Part 22H)
GSM 850 band edge-left side

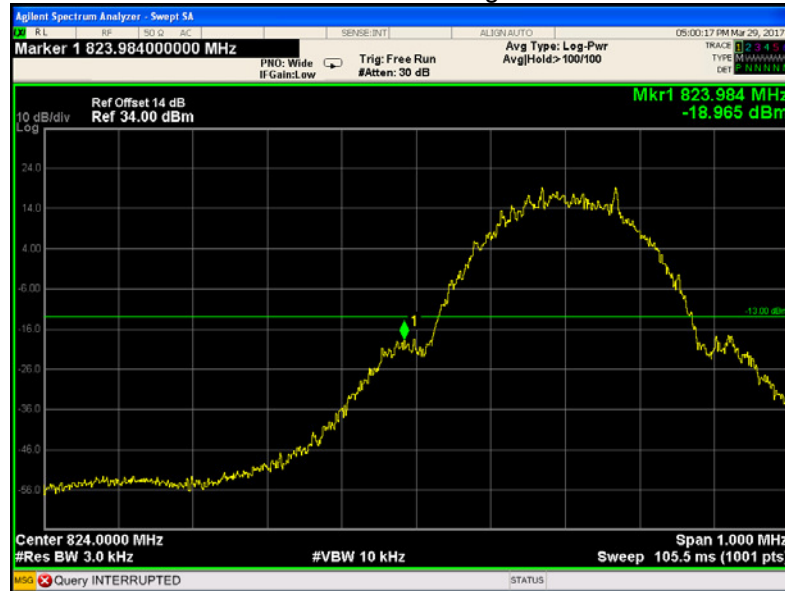

GSM 850 band edge-right side



GPRS 850 band edge-left side

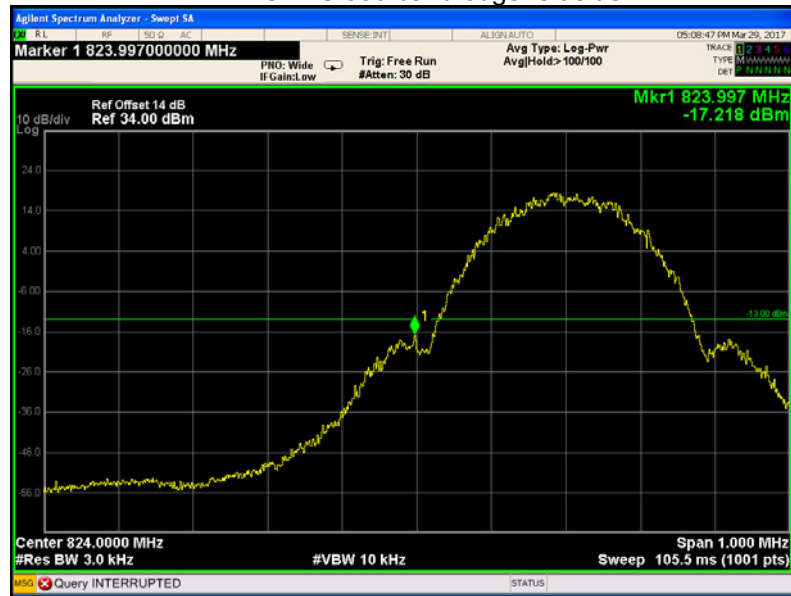

GPRS 850 band edge-right side



Cellular Band (Part 24E)

PCS 1900 band edge-left side

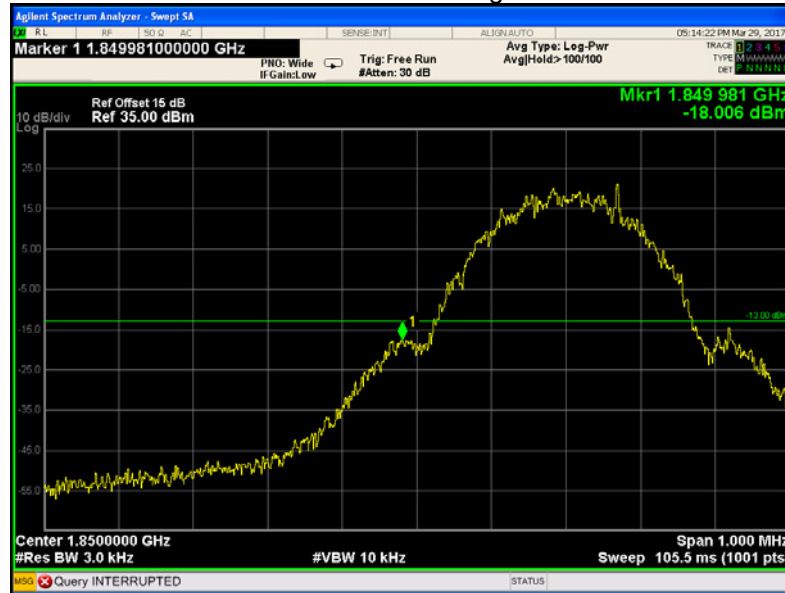

PCS 1900 band edge-right side



GPRS 1900 band edge-left side

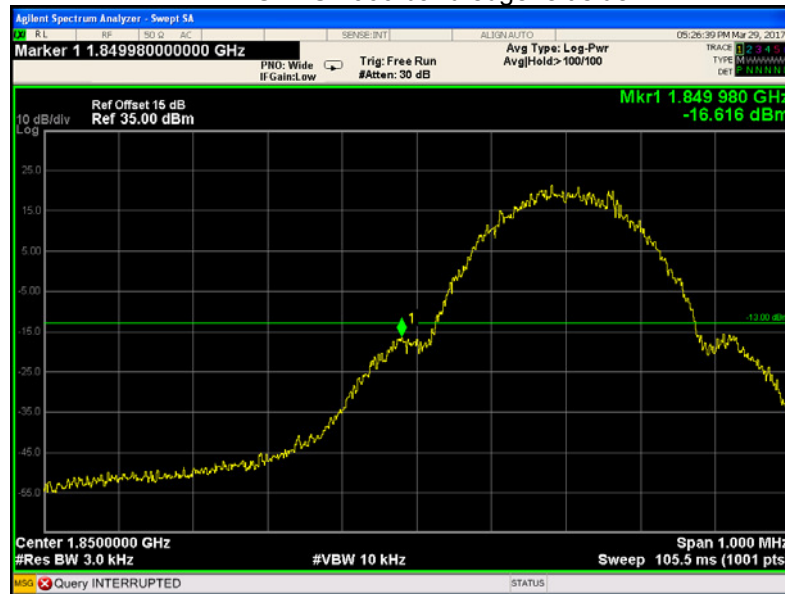

GPRS 1900 band edge-right side

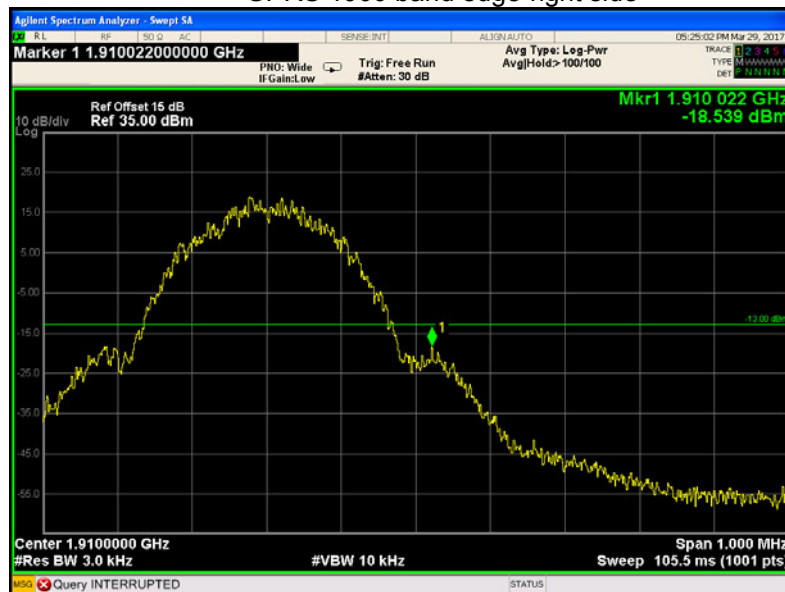

14 FREQUENCY STABILITY

| | |
|-------------------|--|
| Test Requirement: | FCC Part 2.1055, 22.355, 24.235 |
| Test Method: | TIA/EIA-603-D:2010 KDB971168 D01 v02r02 |
| Test Mode: | TX transmitting |

14.1 EUT Operation

Operating Environment :

| | |
|-----------------------|-----------|
| Temperature: | 22.9 °C |
| Humidity: | 52.0 % RH |
| Atmospheric Pressure: | 101.3kPa |

14.2 Test Procedure

Frequency Stability vs. Temperature: The equipment under test was connected to an external DC power supply and the RF output was connected to communication test set via feed-through attenuators. The EUT was placed inside the temperature chamber. The DC leads and RF output cable exited the chamber through an opening made for the purpose.

After the temperature stabilized for approximately 20 minutes, the frequency output was recorded from the communication test set.

Frequency Stability vs. Voltage: For hand carried, battery powered equipment; reduce primary supply voltage to the battery operating end point which shall be specified by the manufacturer.

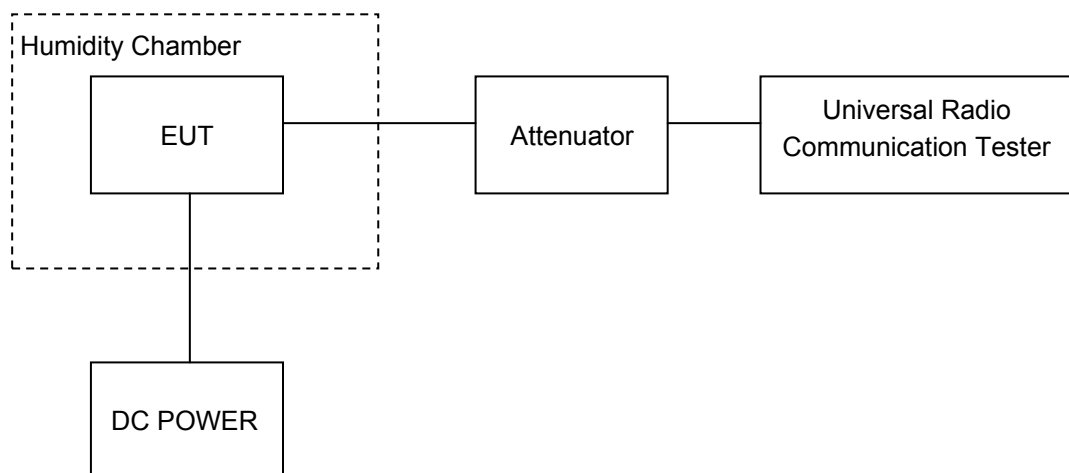

14.3 Test Result

Cellular Band (Part 22H)

| GSM 850 Test Frequency:836.6MHz | | | | |
|---------------------------------|--------------------|----------------------|-----------------------|-------------|
| Temperature (°C) | Power Supply (VDC) | Frequency Error (Hz) | Frequency Error (ppm) | Limit (ppm) |
| 50 | 3.7 | 0 | 0.0000 | 2.5 |
| 40 | | -1 | -0.0012 | 2.5 |
| 30 | | 4 | 0.0048 | 2.5 |
| 20 | | -2 | -0.0024 | 2.5 |
| 10 | | 4 | 0.0048 | 2.5 |
| 0 | | 0 | 0.0000 | 2.5 |
| -10 | | -6 | -0.0072 | 2.5 |
| -20 | | 2 | 0.0024 | 2.5 |
| -30 | | 3 | 0.0036 | 2.5 |
| 20 | | 3.3 | -1 | -0.0012 |
| 20 | 4.2 | 0 | 0.0000 | 2.5 |

| GPRS 850 Test Frequency:836.6MHz | | | | |
|----------------------------------|--------------------|----------------------|-----------------------|-------------|
| Temperature (°C) | Power Supply (VDC) | Frequency Error (Hz) | Frequency Error (ppm) | Limit (ppm) |
| 50 | 3.7 | 4 | 0.0048 | 2.5 |
| 40 | | -9 | -0.0108 | 2.5 |
| 30 | | -5 | -0.0060 | 2.5 |
| 20 | | -3 | -0.0036 | 2.5 |
| 10 | | -1 | -0.0012 | 2.5 |
| 0 | | 5 | 0.0060 | 2.5 |
| -10 | | -11 | -0.0131 | 2.5 |
| -20 | | 6 | 0.0072 | 2.5 |
| -30 | | -9 | -0.0108 | 2.5 |
| 20 | | 3.3 | -5 | -0.0060 |
| 20 | 4.2 | 3 | 0.0036 | 2.5 |

PCS Band (Part 24E)

| PCS 1900 Test Frequency:1880.0MHz | | | | |
|-----------------------------------|--------------------|----------------------|-----------------------|-------------|
| Temperature (°C) | Power Supply (VDC) | Frequency Error (Hz) | Frequency Error (ppm) | Limit (ppm) |
| 50 | 3.7 | -19 | -0.0101 | 2.5 |
| 40 | | -11 | -0.0059 | 2.5 |
| 30 | | -16 | -0.0085 | 2.5 |
| 20 | | -11 | -0.0059 | 2.5 |
| 10 | | -4 | -0.0021 | 2.5 |
| 0 | | -17 | -0.0090 | 2.5 |
| -10 | | -16 | -0.0085 | 2.5 |
| -20 | | -6 | -0.0032 | 2.5 |
| -30 | | -15 | -0.0080 | 2.5 |
| 20 | 3.3 | -17 | -0.0090 | 2.5 |
| 20 | 4.2 | -19 | -0.0101 | 2.5 |

| GPRS 1900 Test Frequency:1880.0MHz | | | | |
|------------------------------------|--------------------|----------------------|-----------------------|-------------|
| Temperature (°C) | Power Supply (VDC) | Frequency Error (Hz) | Frequency Error (ppm) | Limit (ppm) |
| 50 | 3.7 | -17 | -0.0090 | 2.5 |
| 40 | | -8 | -0.0043 | 2.5 |
| 30 | | -13 | -0.0069 | 2.5 |
| 20 | | -9 | -0.0048 | 2.5 |
| 10 | | -13 | -0.0069 | 2.5 |
| 0 | | -2 | -0.0011 | 2.5 |
| -10 | | -3 | -0.0016 | 2.5 |
| -20 | | -14 | -0.0074 | 2.5 |
| -30 | | 0 | 0.0000 | 2.5 |
| 20 | 3.3 | -12 | -0.0064 | 2.5 |
| 20 | 4.2 | -17 | -0.0090 | 2.5 |

15 RF Exposure

Remark: refer to SAR test report: WTS17S0374777E.

16 Photographs of test setup and EUT.

Note: Please refer to appendix: WTS17S0374778E_Photo.

===== End of Report =====