



FCC RADIO TEST REPORT

FCC ID: 2AICV-2318

Product: Mobile Phone
Trade Name: SIMTEL
Model No.: 2318
Serial Model: N/A
Report No.: NTEK-2016NT04095093F2
Issue Date: 26 Apr. 2016

Prepared for

PHONEPAC S.A.
Ciudadela Nueva Kennedy Calle 3rd and Av. Olimpo,
Guayaquil, Ecuador.

Prepared by

NTEK TESTING TECHNOLOGY CO., LTD.
1/F, Building E, Fenda Science Park, Sanwei Community,
Xixiang Street Bao'an District, Shenzhen, P.R. China
Tel.: +86-0755-61156588
Fax.: +86-0755-61156599
Website: www.ntek.org.cn

TABLE OF CONTENTS

1	TEST RESULT CERTIFICATION	3
2	SUMMARY OF TEST RESULTS.....	4
3	FACILITIES AND ACCREDITATIONS	5
3.1	FACILITIES.....	5
3.2	LABORATORY ACCREDITATIONS AND LISTINGS	5
3.3	MEASUREMENT UNCERTAINTY	5
4	GENERAL DESCRIPTION OF EUT	6
5	DESCRIPTION OF TEST MODES	8
6	SETUP OF EQUIPMENT UNDER TEST	9
6.1	BLOCK DIAGRAM CONFIGURATION OF TEST SYSTEM.....	9
6.2	SUPPORT EQUIPMENT.....	10
6.3	EQUIPMENTS LIST FOR ALL TEST ITEMS.....	11
7	TEST REQUIREMENTS	12
7.1	CONDUCTED EMISSIONS TEST	12
7.2	FIELD STRENGTH OF SPURIOUS RADIATION	13
7.3	EFFECTIVE RADIATED POWER AND EFFECTIVE ISOTROPIC RADIATED POWER.....	27
7.4	CONDUCTED OUTPUT POWER.....	31
7.5	FREQUENCY STABILITY	34
7.6	PEAK-TO-AVERAGE RATIO	37
7.7	26DB BANDWIDTH AND 99% OCCUPIED BANDWIDTH	42
7.8	CONDUCTED BAND EDGE	50
7.9	CONDUCTED SPURIOUS EMISSION AT ANTENNA TERMINAL	55



1 TEST RESULT CERTIFICATION

Applicant's name	PHONEPAC S.A.
Address	Ciudadela Nueva Kennedy Calle 3rd and Av. Olimpo, Guayaquil, Ecuador.
Manufacturer's Name	SINGLUNGYU INT'S LIMITED
Address	4th floor, FengQi Road, FuChengQo Industrial Park,PingHu, LongGang District,ShenZhen
Product description	
Product name	Mobile Phone
Model and/or type reference	2318
Serial Model	N/A

Measurement Procedure Used:

APPLICABLE STANDARDS	
APPLICABLE STANDARD/ TEST PROCEDURE	TEST RESULT
47 CFR Part 2, Part 22H, Part 24E ANSI/ TIA/ EIA-603-D-2010 FCC KDB 971168 D01 Power Meas. License Digital Systems v02v02	Complied

This device described above has been tested by NTEK Testing Technology Co., Ltd., and the test results show that the equipment under test (EUT) is in compliance with the FCC requirements. And it is applicable only to the tested sample identified in the report.

This report shall not be reproduced except in full, without the written approval of NTEK Testing Technology Co., Ltd., this document may be altered or revised by NTEK Testing Technology Co., Ltd., personnel only, and shall be noted in the revision of the document.

The test results of this report relate only to the tested sample identified in this report.

Date of Test : 09 Apr. 2016 ~ 26 Apr. 2016

Testing Engineer : Susan
(Susan Su)

Technical Manager : Jason chen
(Jason Chen)

Authorized Signatory : Sam. chen
(Sam Chen)

2 SUMMARY OF TEST RESULTS

FCC Part22, Subpart H/ FCC Part24, Subpart E			
FCC Rule	Test Item	Verdict	Remark
2.1046	Conducted Output Power	PASS	
24.232(d)	Peak-to-Average Ratio	PASS	
2.1049 22.917(b) 24.238(b)	Occupied Bandwidth	PASS	
2.1051 22.917(a) 24.238(a)	Band Edge	PASS	
22.913(a)(2)	Effective Radiated Power	PASS	
24.232(c)	Equivalent Isotropic Radiated Power	PASS	
2.1053 22.917(a) 24.238(a)	Field Strength of Spurious Radiation	PASS	
2.1055 22.355 24.235	Frequency Stability for Temperature & Voltage	PASS	
2.1051 22.917(a) 24.238(a)	Conducted Emission	PASS	

Remark:

1. "N/A" denotes test is not applicable in this Test Report.
2. All test items were verified and recorded according to the standards and without any deviation during the test.
3. No modifications are made to the EUT during all test items.
4. This EUT has also been tested and complied with the requirements of FCC Part 15, Subpart B, recorded in a separate test report.

4 GENERAL DESCRIPTION OF EUT

Product Feature and Specification	
Equipment	Mobile Phone
Trade Name	SIMTEL
FCC ID	2AICV-2318
Model No.	2318
Serial Model	N/A
Model Difference	N/A
Operating Frequency	<input checked="" type="checkbox"/> GSM850: TX824.2MHz~848.8MHz /RX869.2MHz~893.8MHz; <input checked="" type="checkbox"/> PCS1900: TX1850.2MHz~1909.8MHz /RX1930.2MHz~1989.8MHz;
Modulation	<input checked="" type="checkbox"/> GMSK for GSM/GPRS;
Number of Channels	<input checked="" type="checkbox"/> 124 Channels for GSM850; <input checked="" type="checkbox"/> 299 Channels for PCS1900;
GPRS Class	<input checked="" type="checkbox"/> Multi-Class12 <input checked="" type="checkbox"/> Only 4 timeslots are used for GPRS
SIM CARD	The Mobile Phone one SIM Card sockets <input checked="" type="checkbox"/> IMEI Code: 35408206250271
Antenna Type	FPCB Antenna
Antenna Gain	1 dBi
Power supply	<input checked="" type="checkbox"/> DC supply: DC 3.7/800mAh from Li-ion Battery or DC 5V from USB Port.
	<input type="checkbox"/> Adapter supply: Adapter1; Model: M330 Input: 100-240V~, 50/60Hz, 0.15A Output: 5.0V---, 500mA Adapter2: Model: 1100 Input: 100-240V~, 50/60Hz, 120mA Output: 5.2V---, 500mA
HW Version	N/A
SW Version	N/A

Note: Based on the application, features, or specification exhibited in User's Manual, the EUT is considered as an ITE/Computing Device. More details of EUT technical specification, please refer to the User's Manual. The High Voltage 4.2V and Low Voltage 3.2V was declared by manufacturer, The EUT couldn't be operate normally with higher or lower voltage.

5 DESCRIPTION OF TEST MODES

During the testing, the EUT was controlled via Rhode & Schwarz Digital Radio Communication Tester(CMU 200) to ensure max power transmission and proper modulation. Three channels (The low channel, the middle channel and the high channel) were chosen for testing on both GPRS850 and GPRS1900 frequency band.

Note: GSM/GPRS 850, GSM/GPRS 1900, HSDPA band II, HSUPA band II, HSDPA band V, HSUPA band V modes have been tested during the test. the worst condition (GSM850, GSM1900 RMC 12.2k) be recorded in the test report if no other modes test data.

Antenna port conducted and radiated test items were performed according to KDB 971168 D01 Power Meas. License Digital Systems v02r02 with maximum output power.

Radiated measurements were performed with rotating EUT in different three orthogonal test planes to find the maximum emission.

Radiated emissions were investigated as following frequency range:

1. 30 MHz to 10th harmonic for GSM850/UMTS FDD Band V.
2. 30 MHz to 10th harmonic for GSM1900/UMTS FDD Band II.

All modes and data rates and positions were investigated.

Test modes are chosen to be reported as the worst case configuration below:

Test Modes		
Band	For Conducted Test Cases	For Radiated Test Cases
GSM 850	GSM Link	GSM Link
GSM 1900	GSM Link	GSM Link

Test Frequency and Channels:

Frequency Band	<input checked="" type="checkbox"/> GSM 850		<input checked="" type="checkbox"/> GSM 1900	
	Channel	Frequency (MHz)	Channel	Frequency (MHz)
CH_H	251	848.8	810	1909.8
CH_M	189	836.4	661	1880.0
CH_L	128	824.2	512	1850.2

6 SETUP OF EQUIPMENT UNDER TEST

6.1 BLOCK DIAGRAM CONFIGURATION OF TEST SYSTEM

For AC Conducted Emission Mode

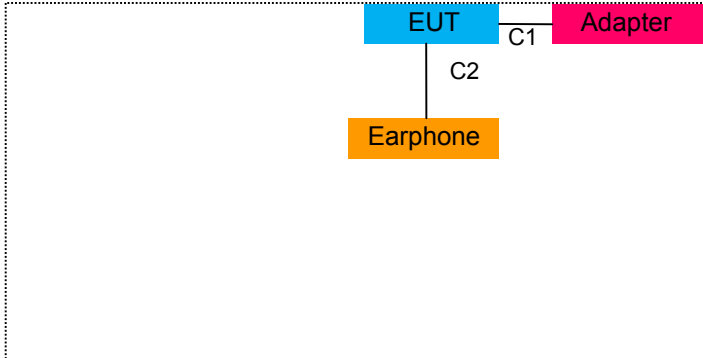

For Radiated Test Cases

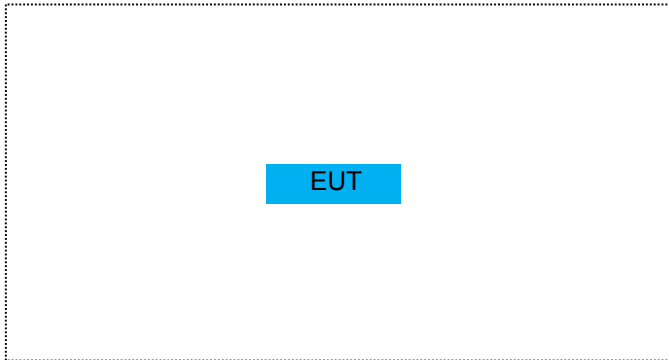

For Conducted Output Power

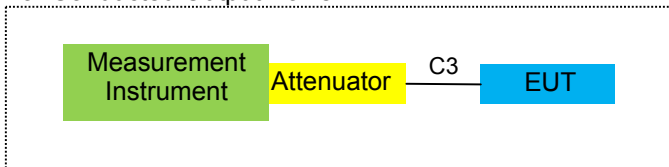

For Peak-to-Average Ratio, Occupied Bandwidth, Conducted Band edge and Conducted Spurious Emission

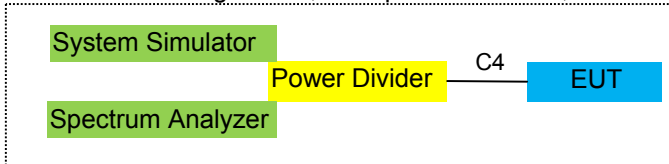

For Frequency Stability

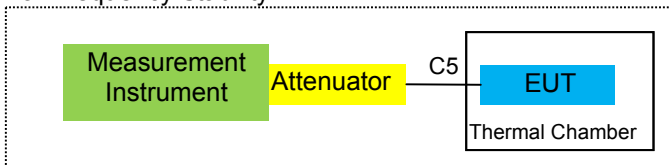

6.2 SUPPORT EQUIPMENT

The EUT has been tested as an independent unit together with other necessary accessories or support units. The following support units or accessories were used to form a representative test configuration during the tests.

Item	Equipment	Mfr/Brand	Model/Type No.	FCC ID	Note
E-1	Mobile Phone	SIMTEL	2318	2AICV-2318	EUT
E-2	Adapter1	N/A	M330	N/A	Peripherals
E-3	Adapter2	N/A	1100	N/A	Peripherals
E-4	Earphone	N/A	L662	N/A	Peripherals

Item	Cable Type	Shielded Type	Ferrite Core	Length
C-1	USB Cable	NO	NO	1.0m
C-2	Earphone	NO	NO	0.8m
C-3	RF Cable	NO	NO	0.5m
C-4	RF Cable	NO	NO	0.5m
C-5	RF Cable	NO	NO	0.5m

Notes:

- (1) The support equipment was authorized by Declaration of Confirmation.
- (2) For detachable type I/O cable should be specified the length in cm in [Length] column.
- (3) "YES" is means "shielded" "with core"; "NO" is means "unshielded" "without core".

6.3 EQUIPMENTS LIST FOR ALL TEST ITEMS

Item	Kind of Equipment	Manufacturer	Type No.	Serial No.	Last calibration	Calibrated until	Calibration period
1	Spectrum Analyzer	Agilent	E4407B	MY45108040	2015.07.06	2016.07.05	1 year
2	Test Receiver	R&S	ESPI	101318	2015.06.07	2016.06.06	1 year
3	Bilog Antenna	TESEQ	CBL6111D	31216	2015.07.06	2016.07.05	1 year
4	50Ω Coaxial Switch	Anritsu	MP59B	6200264416	2015.06.07	2016.06.06	1 year
5	Spectrum Analyzer	ADVANTEST	R3132	150900201	2015.06.07	2016.06.06	1 year
6	Horn Antenna	EM	EM-AH-1018 0	2011071402	2015.07.06	2016.07.05	1 year
7	Horn Ant	Schwarzbeck	BBHA 9170	9170-181	2015.07.06	2016.07.05	1 year
8	Amplifier	EM	EM-30180	060538	2015.07.06	2016.07.05	1 year
9	Loop Antenna	ARA	PLA-1030/B	1029	2015.06.08	2016.06.07	1 year
10	Power Meter	R&S	NRVS	100696	2015.07.06	2016.07.05	1 year
11	Power Sensor	R&S	URV5-Z4	0395.1619.0 5	2015.07.06	2016.07.05	1 year
12	Test Cable	N/A	R-01	N/A	2015.07.06	2016.07.05	1 year
13	Test Cable	N/A	R-02	N/A	2015.07.06	2016.07.05	1 year
14	Test Receiver	R&S	ESCI	101160	2015.06.06	2016.06.05	1 year
15	LISN	R&S	ENV216	101313	2015.08.24	2016.08.23	1 year
16	LISN	EMCO	3816/2	00042990	2015.08.24	2016.08.23	1 year
17	50Ω Coaxial Switch	Anritsu	MP59B	6200264417	2015.06.07	2016.06.06	1 year
18	Passive Voltage Probe	R&S	ESH2-Z3	100196	2015.06.07	2016.06.06	1 year
19	Absorbing clamp	R&S	MOS-21	100423	2015.06.08	2016.06.07	1 year
20	Test Cable	N/A	C01	N/A	2015.06.08	2016.06.07	1 year
21	Test Cable	N/A	C02	N/A	2015.06.08	2016.06.07	1 year
22	Test Cable	N/A	C03	N/A	2015.06.08	2016.06.07	1 year
23	Attenuation	MCE	24-10-34	BN9258	2015.06.08	2016.06.07	1 year
24	Spectrum Analyzer	agilent	e4440a	us44300399	2015.06.08	2016.06.07	1 year
25	test receiver	R&S	esCI	a0304218	2015.06.08	2016.06.07	1 year
26	Communication Tester	R&S	CMU200	A0304247	2015.06.08	2016.06.07	1 year
27	Thermal Chamber	Ten Billion	TTC-B3C	TBN-960502	2015.06.08	2016.06.07	1 year

Note: Each piece of equipment is scheduled for calibration once a year.

7 TEST REQUIREMENTS

7.1 CONDUCTED EMISSIONS TEST

7.1.1 Applicable Standard

According to FCC KDB 971168 D01 v02r02 Section 6.0

7.1.2 Conformance Limit

Frequency(MHz)	Conducted Emission Limit	
	Quasi-peak	Average
0.15-0.5	66-56*	56-46*
0.5-5.0	56	46
5.0-30.0	60	50

Note: 1. *Decreases with the logarithm of the frequency
 2. The lower limit shall apply at the transition frequencies
 3. The limit decreases in line with the logarithm of the frequency in the range of 0.15 to 0.50MHz.

7.1.3 Measuring Instruments

The Measuring equipment is listed in the section 6.3 of this test report.

7.1.4 Test Configuration

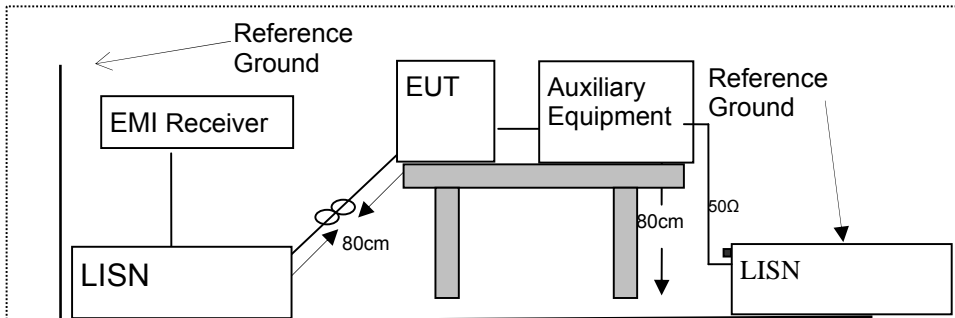

7.1.5 Test Procedure

According to the requirements in Section 13.1.4.1 of ANSI C63.10-2013 Conducted emissions the EUT measured in the frequency range between 0.15 MHz and 30 MHz using CISPR Quasi-Peak and average detector mode.

1. The EUT was placed 0.4 meter from the conducting wall of the shielding room.
2. The EUT was placed on a table which is 0.8m above ground plane.
3. Connect EUT to the power mains through a line impedance stabilization network (LISN). All other support equipments powered from additional LISN(s). The LISN provide 50 Ohm/ 50uH of coupling impedance for the measuring instrument.
4. Interconnecting cables that hang closer than 40 cm to the ground plane shall be folded back and forth in the center forming a bundle 30 to 40cm long.
5. I/O cables that are not connected to a peripheral shall be bundled in the center. The end of the cable may be terminated, if required, using the correct terminating impedance. The overall length shall not exceed 1 m.
6. LISN at least 80 cm from nearest part of EUT chassis.
7. The frequency range from 150KHz to 30MHz was searched.
8. Set the test-receiver system to Peak Detect Function and specified bandwidth(IF bandwidth=9KHz) with Maximum Hold Mode
9. For the actual test configuration, please refer to the related Item –EUT Test Photos.

7.1.6 Test Results

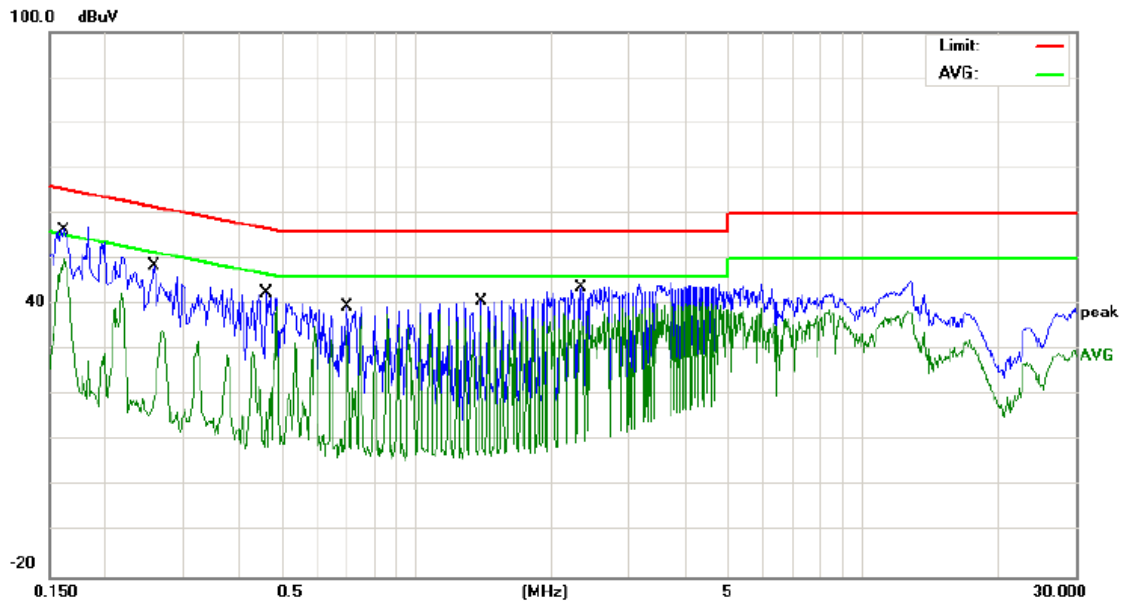

Site: Phase: **L1** Temperature: 22
 Limit: FCC Part 15B_(0.15-30MHz) _Main_QP Power: AC 120V/60Hz Humidity: 51 %
 Mode: Mode1
 Note: Adapter1

No.	Mk.	Freq. MHz	Reading Level dBuV	Correct Factor dB	Measure- ment dBuV	Limit dBuV	Over dB	Detector	Comment
1		0.1620	46.43	10.07	56.50	65.36	-8.86	QP	
2	*	0.1620	39.89	10.07	49.96	55.36	-5.40	AVG	
3		0.2580	38.36	10.08	48.44	61.49	-13.05	QP	
4		0.2580	32.56	10.08	42.64	51.49	-8.85	AVG	
5		0.4586	32.78	9.92	42.70	56.72	-14.02	QP	
6		0.4586	24.20	9.92	34.12	46.72	-12.60	AVG	
7		0.6975	29.64	9.81	39.45	56.00	-16.55	QP	
8		0.6975	24.29	9.81	34.10	46.00	-11.90	AVG	
9		1.3932	30.83	9.82	40.65	56.00	-15.35	QP	
10		1.3932	27.70	9.82	37.52	46.00	-8.48	AVG	
11		2.3420	33.96	9.74	43.70	56.00	-12.30	QP	
12		2.3420	26.63	9.74	36.37	46.00	-9.63	AVG	

*:Maximum data x:Over limit !:over margin

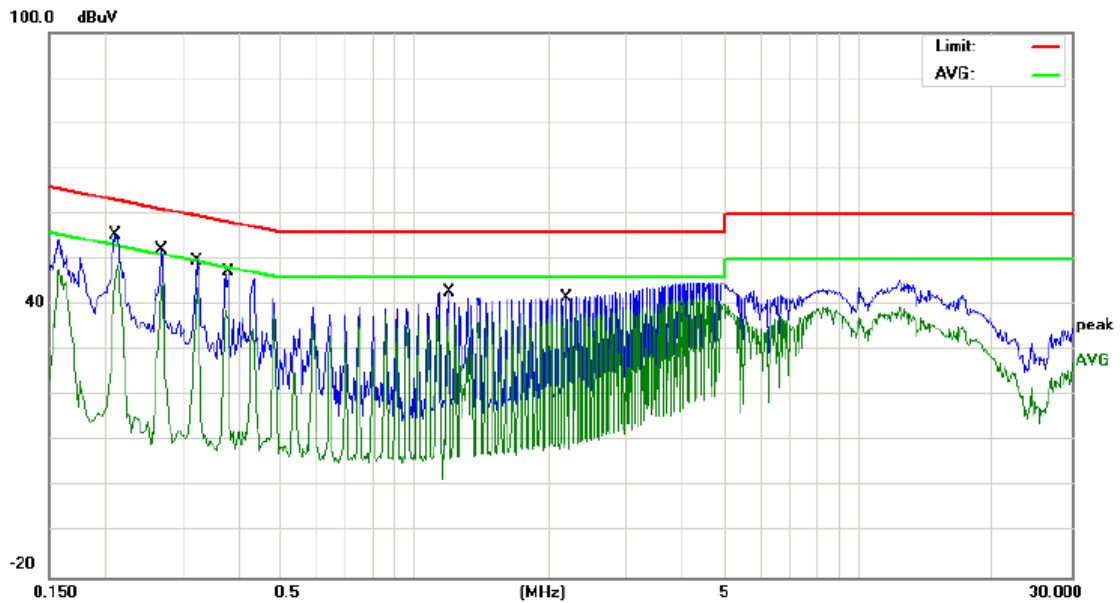

Site: Phase: *N* Temperature: 22
 Limit: FCC Part 15B_(0.15-30MHz) _Main_QP Power: AC 120V/60Hz Humidity: 51 %
 Mode: Mode1
 Note: Adapter1

No.	Mk.	Freq. MHz	Reading Level dBuV	Correct Factor dB	Measure- ment dBuV	Limit dBuV	Over dB	Detector	Comment
1		0.2104	45.47	10.03	55.50	63.19	-7.69	QP	
2	*	0.2104	38.87	10.03	48.90	53.19	-4.29	AVG	
3		0.2700	42.20	10.10	52.30	61.12	-8.82	QP	
4		0.2700	34.26	10.10	44.36	51.12	-6.76	AVG	
5		0.3220	39.59	10.11	49.70	59.65	-9.95	QP	
6		0.3220	31.25	10.11	41.36	49.65	-8.29	AVG	
7		0.3790	37.43	10.07	47.50	58.30	-10.80	QP	
8		0.3790	28.89	10.07	38.96	48.30	-9.34	AVG	
9		1.1935	33.15	9.85	43.00	56.00	-13.00	QP	
10		1.1935	25.56	9.85	35.41	46.00	-10.59	AVG	
11		2.1939	31.93	9.75	41.68	56.00	-14.32	QP	
12		2.1939	27.47	9.75	37.22	46.00	-8.78	AVG	

*:Maximum data x:Over limit !:over margin

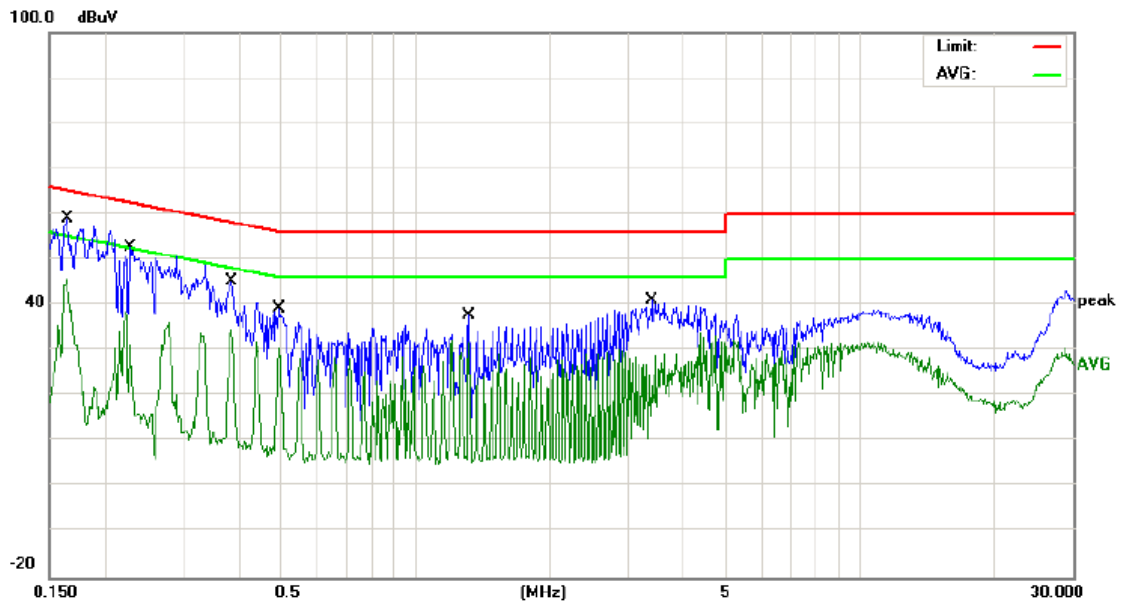

Site: Phase: **L1** Temperature: 22
 Limit: FCC Part 15B_(0.15-30MHz) _Main_QP Power: AC 240V/50Hz Humidity: 51 %
 Mode: Mode1
 Note: Adapter1

No.	Mk.	Freq. MHz	Reading Level dBuV	Correct Factor dB	Measure- ment dBuV	Limit dBuV	Over dB	Detector	Comment
1	*	0.1650	48.94	10.06	59.00	65.20	-6.20	QP	
2		0.1650	35.70	10.06	45.76	55.20	-9.44	AVG	
3		0.2278	42.75	10.05	52.80	62.53	-9.73	QP	
4		0.2278	28.59	10.05	38.64	52.53	-13.89	AVG	
5		0.3860	35.27	10.06	45.33	58.15	-12.82	QP	
6		0.3860	24.53	10.06	34.59	48.15	-13.56	AVG	
7		0.4939	29.37	9.83	39.20	56.10	-16.90	QP	
8		0.4939	20.65	9.83	30.48	46.10	-15.62	AVG	
9		1.3180	27.81	9.83	37.64	56.00	-18.36	QP	
10		1.3180	22.07	9.83	31.90	46.00	-14.10	AVG	
11		3.3980	31.37	9.73	41.10	56.00	-14.90	QP	
12		3.3980	19.47	9.73	29.20	46.00	-16.80	AVG	

*:Maximum data x:Over limit !:over margin

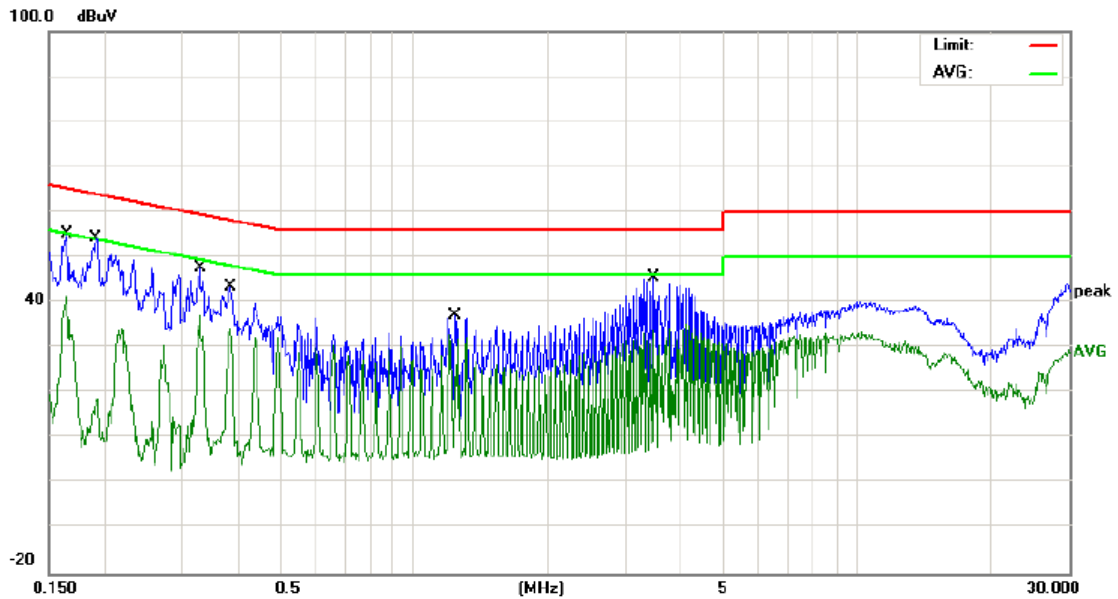

Site: _____ Phase: **N** Temperature: 22
 Limit: FCC Part 15B_(0.15-30MHz) _Main_QP Power: AC 240V/50Hz Humidity: 51 %
 Mode: Mode1
 Note: Adapter1

No.	Mk.	Freq. MHz	Reading Level dBuV	Correct Factor dB	Measure- ment dBuV	Limit dBuV	Over dB	Detector	Comment
1		0.1650	45.04	10.06	55.10	65.20	-10.10	QP	
2		0.1650	31.71	10.06	41.77	55.20	-13.43	AVG	
3	*	0.1912	44.27	10.03	54.30	63.98	-9.68	QP	
4		0.1912	8.65	10.03	18.68	53.98	-35.30	AVG	
5		0.3300	37.63	10.11	47.74	59.45	-11.71	QP	
6		0.3300	23.63	10.11	33.74	49.45	-15.71	AVG	
7		0.3860	33.41	10.06	43.47	58.15	-14.68	QP	
8		0.3860	24.20	10.06	34.26	48.15	-13.89	AVG	
9		1.2379	27.46	9.84	37.30	56.00	-18.70	QP	
10		1.2379	22.22	9.84	32.06	46.00	-13.94	AVG	
11		3.4580	35.72	9.73	45.45	56.00	-10.55	QP	
12		3.4580	24.15	9.73	33.88	46.00	-12.12	AVG	

*:Maximum data x:Over limit !:over margin

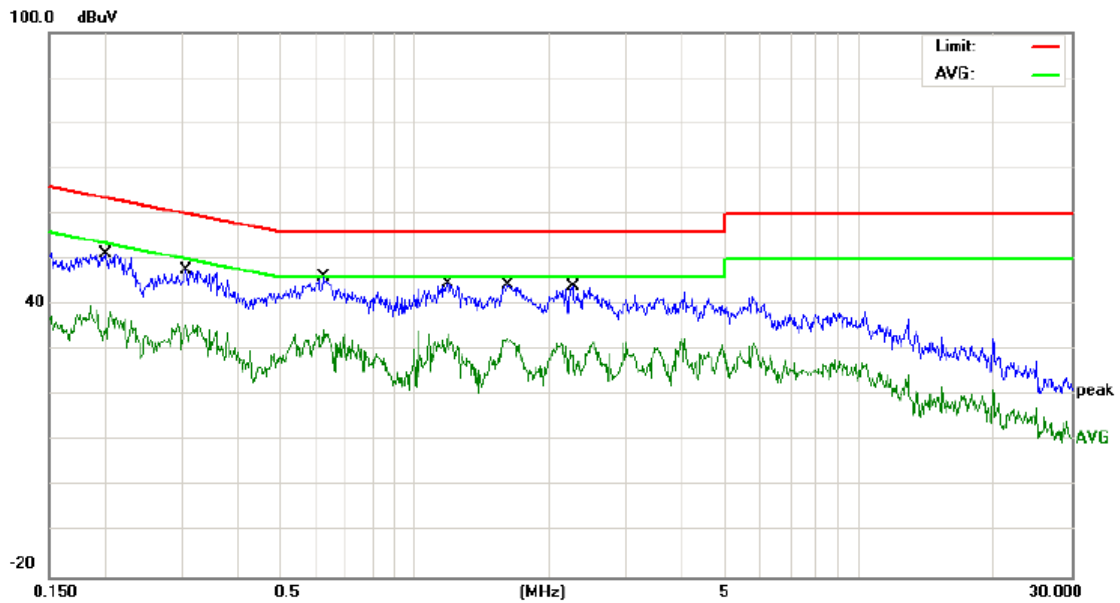

Site: Phase: **L1** Temperature: 23.6
 Limit: FCC Part15 CE-Class B_QP Power: AC 120V/60Hz Humidity: 48.4 %
 Mode: Mode1
 Note: Adapter2

No.	Mk.	Freq. MHz	Reading Level dBuV	Correct Factor dB	Measure- ment dBuV	Limit dBuV	Over dB	Detector	Comment
1		0.2006	41.84	9.46	51.30	63.58	-12.28	QP	
2		0.2006	25.41	9.46	34.87	53.58	-18.71	AVG	
3		0.3059	38.36	9.44	47.80	60.08	-12.28	QP	
4		0.3059	25.12	9.44	34.56	50.08	-15.52	AVG	
5	*	0.6219	36.66	9.44	46.10	56.00	-9.90	QP	
6		0.6219	22.51	9.44	31.95	46.00	-14.05	AVG	
7		1.1854	35.36	9.44	44.80	56.00	-11.20	QP	
8		1.1854	23.96	9.44	33.40	46.00	-12.60	AVG	
9		1.6220	34.93	9.45	44.38	56.00	-11.62	QP	
10		1.6220	22.91	9.45	32.36	46.00	-13.64	AVG	
11		2.2620	34.74	9.46	44.20	56.00	-11.80	QP	
12		2.2620	16.53	9.46	25.99	46.00	-20.01	AVG	

*:Maximum data x:Over limit !:over margin

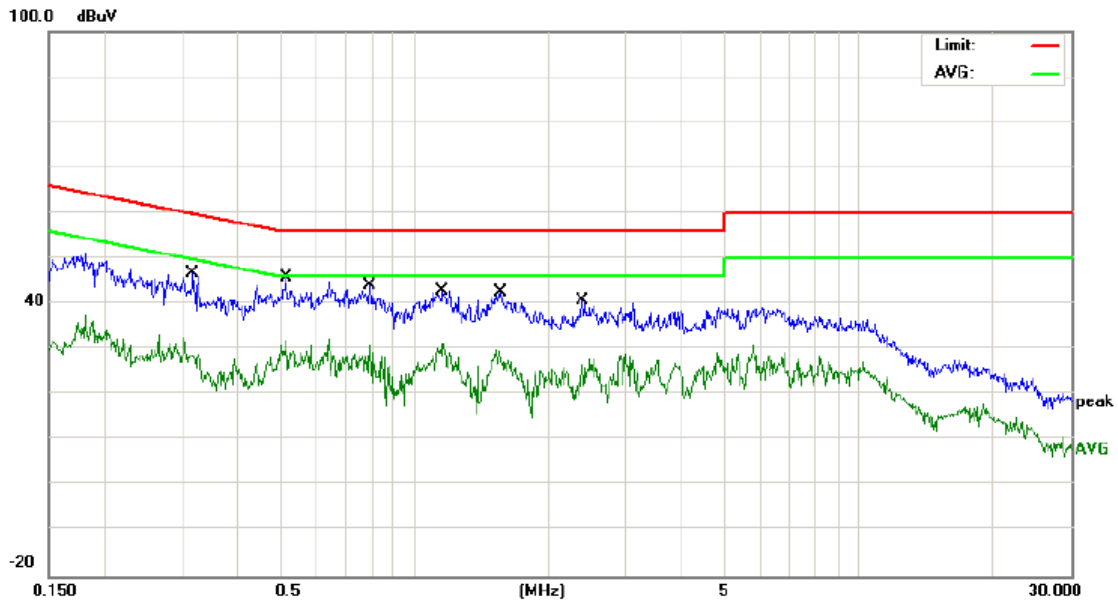

Site: Phase: *N* Temperature: 23.6
 Limit: FCC Part15 CE-Class B_QP Power: AC 120V/60Hz Humidity: 48.4 %
 Mode: Mode1
 Note: Adapter2

No.	Mk.	Freq. MHz	Reading Level dBuV	Correct Factor dB	Measure- ment dBuV	Limit dBuV	Over dB	Detector	Comment
1		0.3180	37.19	9.44	46.63	59.76	-13.13	QP	
2		0.3180	19.30	9.44	28.74	49.76	-21.02	AVG	
3	*	0.5140	36.34	9.46	45.80	56.00	-10.20	QP	
4		0.5140	22.48	9.46	31.94	46.00	-14.06	AVG	
5		0.7940	34.67	9.43	44.10	56.00	-11.90	QP	
6		0.7940	21.51	9.43	30.94	46.00	-15.06	AVG	
7		1.1572	33.56	9.44	43.00	56.00	-13.00	QP	
8		1.1572	21.83	9.44	31.27	46.00	-14.73	AVG	
9		1.5620	33.15	9.45	42.60	56.00	-13.40	QP	
10		1.5620	18.52	9.45	27.97	46.00	-18.03	AVG	
11		2.3940	31.44	9.46	40.90	56.00	-15.10	QP	
12		2.3940	17.14	9.46	26.60	46.00	-19.40	AVG	

*:Maximum data x:Over limit !:over margin

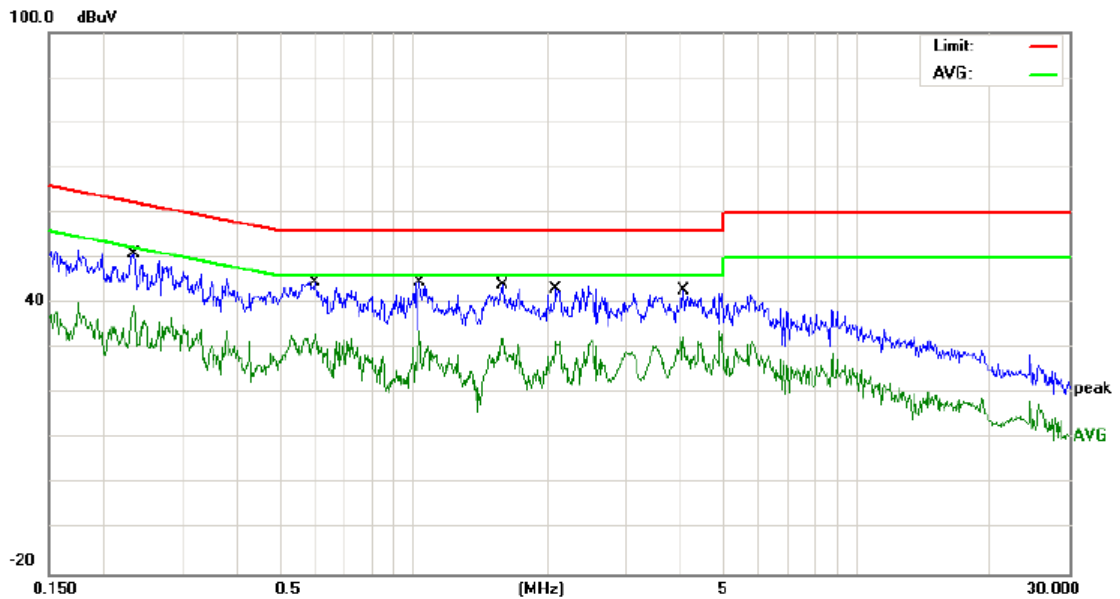

Site: _____ Phase: **L1** Temperature: 23.6
 Limit: FCC Part15 CE-Class B_QP Power: AC 240V/50Hz Humidity: 48.4 %
 Mode: Mode1
 Note: Adapter2

No.	Mk.	Freq.	Reading Level	Correct Factor	Measurement	Limit	Over	Detector	Comment
		MHz	dBuV	dB	dBuV	dBuV	dB		
1		0.2340	41.45	9.45	50.90	62.30	-11.40	QP	
2		0.2340	29.96	9.45	39.41	52.30	-12.89	AVG	
3		0.6018	34.96	9.44	44.40	56.00	-11.60	QP	
4		0.6018	23.89	9.44	33.33	46.00	-12.67	AVG	
5	*	1.0300	35.16	9.44	44.60	56.00	-11.40	QP	
6		1.0300	24.31	9.44	33.75	46.00	-12.25	AVG	
7		1.5900	34.50	9.45	43.95	56.00	-12.05	QP	
8		1.5900	22.89	9.45	32.34	46.00	-13.66	AVG	
9		2.0979	33.57	9.46	43.03	56.00	-12.97	QP	
10		2.0979	21.85	9.46	31.31	46.00	-14.69	AVG	
11		4.0537	33.33	9.47	42.80	56.00	-13.20	QP	
12		4.0537	23.27	9.47	32.74	46.00	-13.26	AVG	

*:Maximum data x:Over limit !:over margin

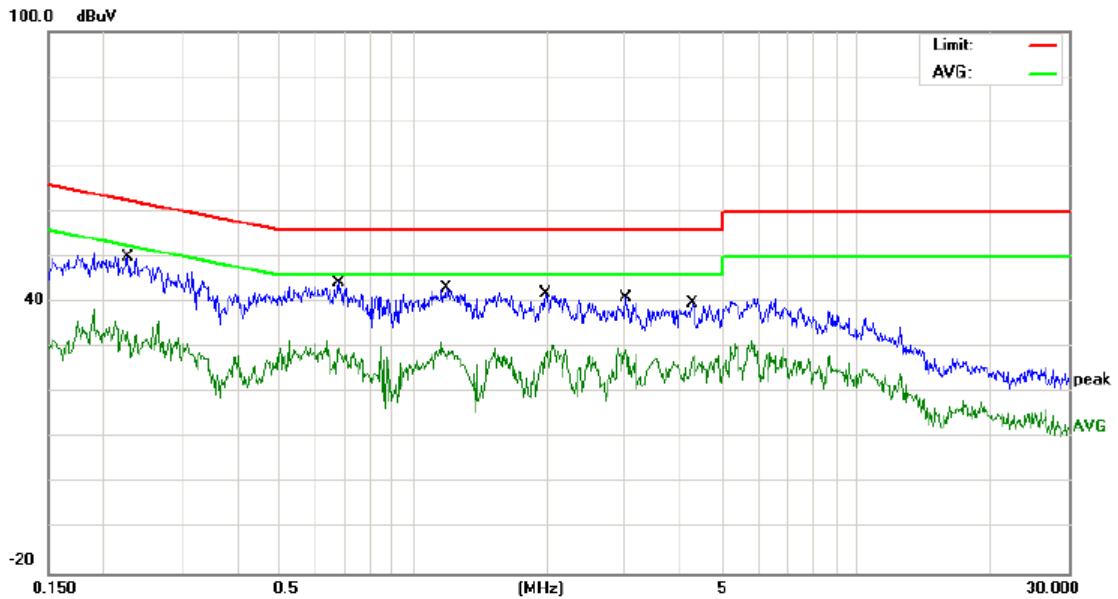

Site: Phase: *N* Temperature: 23.6
 Limit: FCC Part15 CE-Class B_QP Power: AC 240V/50Hz Humidity: 48.4 %
 Mode: Mode1
 Note: Adapter2

No.	Mk.	Freq. MHz	Reading Level dBuV	Correct Factor dB	Measure- ment dBuV	Limit dBuV	Over dB	Detector	Comment
1		0.2267	40.75	9.45	50.20	62.57	-12.37	QP	
2		0.2267	24.17	9.45	33.62	52.57	-18.95	AVG	
3	*	0.6780	34.90	9.43	44.33	56.00	-11.67	QP	
4		0.6780	19.79	9.43	29.22	46.00	-16.78	AVG	
5		1.1895	33.58	9.44	43.02	56.00	-12.98	QP	
6		1.1895	18.58	9.44	28.02	46.00	-17.98	AVG	
7		1.9899	32.64	9.46	42.10	56.00	-13.90	QP	
8		1.9899	17.42	9.46	26.88	46.00	-19.12	AVG	
9		3.0219	31.63	9.47	41.10	56.00	-14.90	QP	
10		3.0219	20.09	9.47	29.56	46.00	-16.44	AVG	
11		4.2618	30.32	9.48	39.80	56.00	-16.20	QP	
12		4.2618	18.19	9.48	27.67	46.00	-18.33	AVG	

*:Maximum data x:Over limit !:over margin

7.2 FIELD STRENGTH OF SPURIOUS RADIATION

7.2.1 Applicable Standard

According to FCC KDB 971168 D01 v02r02 Section 5.8 and ANSI/ TIA-603-D-2010 Section 2.2.12

7.2.2 Conformance Limit

The power of any emission outside of the authorized operating frequency ranges must be attenuated below the transmitter power (P) by a factor of at least $43 + 10 \log (P)$ dB. The spectrum is scanned from 30 MHz up to a frequency including its 10th harmonic.

7.2.3 Measuring Instruments

The Measuring equipment is listed in the section 6.3 of this test report.

7.2.4 Test Configuration

(a) For radiated emissions from 30MHz to 1000MHz

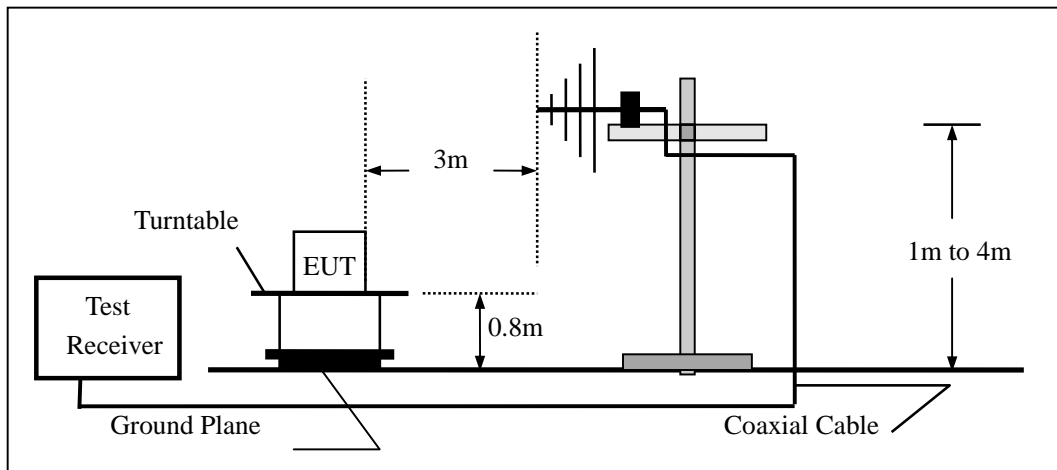

(b) For radiated emissions above 1000MHz

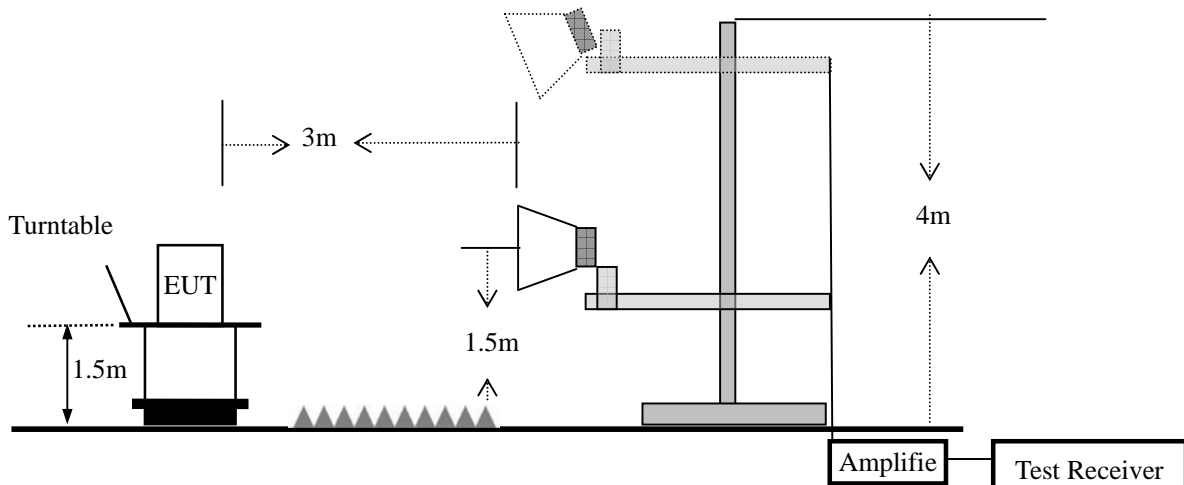

7.2.5 Test Procedure

The measurements procedures specified in TIA-603-D-2010 were used for testing. The spectrum was scanned from 30 MHz to the 10th harmonic of the highest frequency generated within the equipment. The resolution bandwidth is set 1MHz as outlined in Part 24.238. The measurements were performed on all modes(GPRS850, GPRS1900, HSDPA band V) at 3 typical channels(the Top Channel, the Middle Channel and the Bottom Channel) for each band.Only shown the worst data.

The procedure of radiated spurious emissions is as follows:

- a) Pre-calibration With pre-calibration method, the Radiated Spurious Emissions(RSE) is calculated as, $RSE = Rx(dBuV) + CL(dB) + SA(dB) + Gain(dBi) - 107(dBuV \text{ to } dBm)$ The SA is calibrated using following setup.
- b) EUT was placed on a 0.8 meter high non-conductive stand at a 3 meter test distance from the receive antenna. A receiving antenna was placed on the antenna mast 3 meters from the test item for emission measurements. The height of receiving antenna is 0.8m. The test setup refers to figure below. Detected emissions were maximized at each frequency by rotating the test item and adjusting the receiving antenna polarization. The radiated emission measurements of all non-harmonic and harmonics of the transmit frequency through the 10th harmonic were measured with peak detector and 1MHz bandwidth.

Radiated emissions measurements were made only at the upper, middle, and lower carrier frequencies of the PCS 1900 band (1850.2 MHz, 1880 MHz and 1909.8 MHz), GSM850 band (824.2MHz, 836.6MHz, 848.8MHz), UMTS band II(1852.4MHz, 1880MHz, 1907.6MHz), UMTS band V(826.4MHz, 835.0MHz, 846.6MHz) . It was decided that measurements at these three carrier frequencies would be sufficient to demonstrate compliance with emissions limits because it was seen that all the significant spurs occur well outside the band and no radiation was seen from a carrier in one block of any band into any of the other blocks.

The substitution method is used. Substitution values at each frequency are measured before and saved to the test software. A "reference path loss" is established and the ARpl is the attenuation of "reference path loss", and including the gain of receive antenna, the gain of the preamplifier, the cable loss and the air loss. The measurement results are obtained as described below: $Power = P_{Mea} + AR_{pl}$

7.2.6 Test Results

EUT:	Mobile Phone	Model No.:	2318
Temperature:	20 °C	Relative Humidity:	48%
Test Mode:	GSM850/GSM1900	Test By:	Susan su

■ Radiated Spurious Emission

GSM850						
Frequency (MHz)	Power (dBm)	ARpl (dBm)	PMea (dBm)	Limit (dBm)	Over Limit (dBm)	Polarity
Test Results for Channel 128/824.2 MHz						
1648.4	-31.68	7.8	-23.88	-13	-10.88	Vertical
1648.4	-31.44	7.8	-23.64	-13	-10.64	Horizontal
2472.6	-31.24	11	-20.24	-13	-7.24	Vertical
2472.6	-31.43	11	-20.43	-13	-7.43	Horizontal
3296.2	-31.15	12.3	-18.85	-13	-5.85	Vertical
3296.2	-31.26	12.3	-18.96	-13	-5.96	Horizontal
Test Results for Channel 190/836.6 MHz						
1673.2	-32.26	8	-24.26	-13	-11.26	Vertical
1673.2	-32.63	8	-24.63	-13	-11.63	Horizontal
2509.8	-32.24	11.2	-21.04	-13	-8.04	Vertical
2509.8	-31.52	11.2	-20.32	-13	-7.32	Horizontal
3346.4	-31.31	12.6	-18.71	-13	-5.71	Vertical
3346.4	-31.56	12.6	-18.96	-13	-5.96	Horizontal
Test Results for Channel 251/848.8 MHz						
1697.6	-31.76	8.1	-23.66	-13	-10.66	Vertical
1697.6	-31.25	8.1	-23.15	-13	-10.15	Horizontal
2546.4	-31.38	11.69	-19.69	-13	-6.69	Vertical
2546.4	-31.17	11.69	-19.48	-13	-6.48	Horizontal
3395.2	-31.46	12.92	-18.54	-13	-5.54	Vertical
3395.2	-31.62	12.92	-18.7	-13	-5.7	Horizontal

GPRS850						
Frequency (MHz)	Power (dBm)	ARpl (dBm)	PMea (dBm)	Limit (dBm)	Over Limit (dBm)	Polarity
Test Results for Channel 128/824.2 MHz						
1648.4	-30.52	7.80	-22.72	-13.00	-9.72	Vertical
1648.4	-32.60	7.80	-24.80	-13.00	-11.80	Horizontal
2472.6	-31.08	11.00	-20.08	-13.00	-7.08	Vertical
2472.6	-31.37	11.00	-20.37	-13.00	-7.37	Horizontal
3296.8	-30.99	12.30	-18.69	-13.00	-5.69	Vertical
3296.8	-31.10	12.30	-18.80	-13.00	-5.80	Horizontal
Test Results for Channel 190/836.6 MHz						
1673.2	-31.10	8.00	-23.10	-13.00	-10.10	Vertical
1673.2	-33.79	8.00	-25.79	-13.00	-12.79	Horizontal
2509.8	-32.08	11.20	-20.88	-13.00	-7.88	Vertical
2509.8	-31.46	11.20	-20.26	-13.00	-7.26	Horizontal
3346.4	-31.15	12.60	-18.55	-13.00	-5.55	Vertical
3346.4	-31.40	12.60	-18.80	-13.00	-5.80	Horizontal
Test Results for Channel 251/848.8 MHz						
1697.6	-30.60	8.10	-22.50	-13.00	-9.50	Vertical
1697.6	-32.41	8.10	-24.31	-13.00	-11.31	Horizontal
2546.4	-31.22	11.69	-19.53	-13.00	-6.53	Vertical
2546.4	-31.11	11.69	-19.42	-13.00	-6.42	Horizontal
3395.2	-31.30	12.92	-18.38	-13.00	-5.38	Vertical
3395.2	-31.46	12.92	-18.54	-13.00	-5.54	Horizontal

GSM1900						
Frequency (MHz)	Power (dBm)	ARpl (dBm)	PMea (dBm)	Limit (dBm)	Over Limit (dBm)	Polarity
Test Results for Channel 512/1850.2MHz						
3700.4	-36.82	13.42	-23.4	-13	-10.4	Vertical
3700.4	-34.43	13.42	-21.01	-13	-8.01	Horizontal
5550.6	-35.78	17.12	-18.66	-13	-5.66	Vertical
5550.6	-34.81	17.12	-17.69	-13	-4.69	Horizontal
7400.8	-36.47	19.26	-17.21	-13	-4.21	Vertical
7400.8	-35.62	19.26	-16.36	-13	-3.36	Horizontal
Test Results for Channel 661/1880.0MHz						
3760	-38.45	13.76	-24.69	-13	-11.69	Vertical
3760	-33.55	13.76	-19.79	-13	-6.79	Horizontal
5640	-34.24	17.56	-16.68	-13	-3.68	Vertical
5640	-38.43	17.56	-20.87	-13	-7.87	Horizontal
7520	-36.57	19.6	-16.97	-13	-3.97	Vertical
7520	-37.56	19.6	-17.96	-13	-4.96	Horizontal
Test Results for Channel 810/1909.8MHz						
3819.6	-34.75	13.87	-20.88	-13	-7.88	Vertical
3819.6	-32.63	13.87	-18.76	-13	-5.76	Horizontal
5729.4	-34.48	17.66	-16.82	-13	-3.82	Vertical
5729.4	-34.52	17.66	-16.86	-13	-3.86	Horizontal
7639.2	-42.26	19.75	-22.51	-13	-9.51	Vertical
7639.2	-38.59	19.75	-18.84	-13	-5.84	Horizontal

GPRS1900						
Frequency (MHz)	Power (dBm)	ARpl (dBm)	PMea (dBm)	Limit (dBm)	Over Limit (dBm)	Polarity
Test Results for Channel 512/1850.2MHz						
3700.4	-35.66	13.42	-22.24	-13.00	-9.24	Vertical
3700.4	-35.59	13.42	-22.17	-13.00	-9.17	Horizontal
5550.6	-35.62	17.12	-18.50	-13.00	-5.50	Vertical
5550.6	-34.75	17.12	-17.63	-13.00	-4.63	Horizontal
7400.8	-36.31	19.26	-17.05	-13.00	-4.05	Vertical
7400.8	-35.46	19.26	-16.20	-13.00	-3.20	Horizontal
Test Results for Channel 661/1880.0MHz						
3760	-37.29	13.76	-23.53	-13.00	-10.53	Vertical
3760	-34.71	13.76	-20.95	-13.00	-7.95	Horizontal
5640	-34.08	17.56	-16.52	-13.00	-3.52	Vertical
5640	-38.37	17.56	-20.81	-13.00	-7.81	Horizontal
7520	-36.41	19.60	-16.81	-13.00	-3.81	Vertical
7520	-37.40	19.60	-17.80	-13.00	-4.80	Horizontal
Test Results for Channel 810/1909.8MHz						
3819.6	-33.59	13.87	-19.72	-13.00	-6.72	Vertical
3819.6	-33.79	13.87	-19.92	-13.00	-6.92	Horizontal
5729.4	-34.32	17.66	-16.66	-13.00	-3.66	Vertical
5729.4	-34.46	17.66	-16.80	-13.00	-3.80	Horizontal
7639.2	-42.10	19.75	-22.35	-13.00	-9.35	Vertical
7639.2	-38.43	19.75	-18.68	-13.00	-5.68	Horizontal

7.3 EFFECTIVE RADIATED POWER AND EFFECTIVE ISOTROPIC RADIATED POWER

7.3.1 Applicable Standard

According to FCC KDB 971168 D01 v02r02 Section 5.2.1/ Section 5.2.2.2 and ANSI/ TIA-603-D-2010 Section 2.2.17

7.3.2 Conformance Limit

The substitution method, in ANSI / TIA / EIA-603-D-2010, was used for ERP/EIRP measurement, and the spectrum analyzer configuration follows KDB 971168 D01 Power Meas. License Digital Systems v02r02. The ERP of mobile transmitters must not exceed 7 Watts (Cellular Band) and the EIRP of mobile transmitters are limited to 2 Watts (PCS Band).

7.3.3 Measuring Instruments

The Measuring equipment is listed in the section 6.3 of this test report.

7.3.4 Test Configuration

(a) For E.R.P and E.I.R.P Measurements

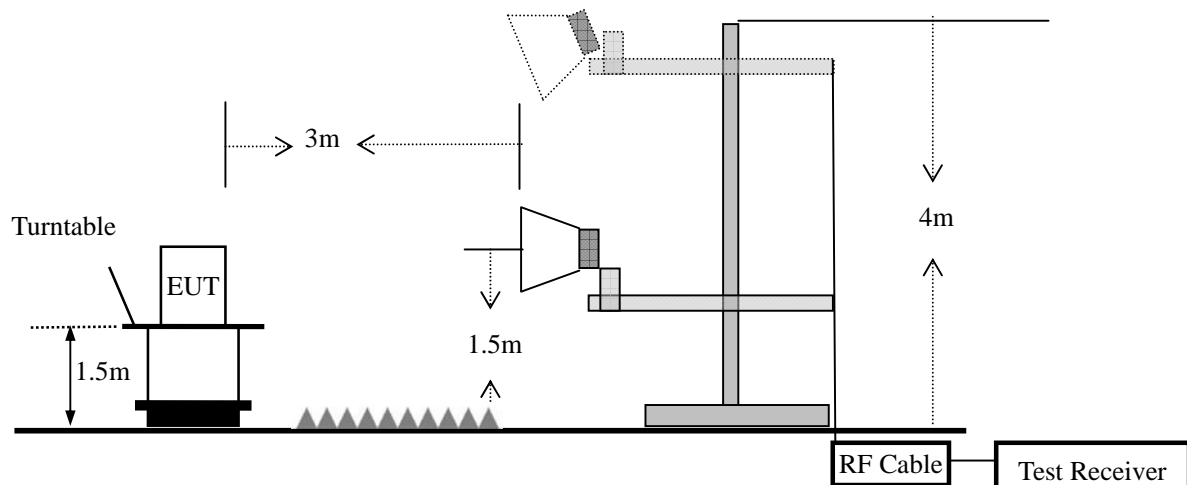

7.3.5 Test Procedure

The measurements procedures specified in TIA-603-D-2010 were applied.

In an anechoic antenna test chamber, a half-wave dipole antenna for the frequency band of interest is placed at the reference centre of the chamber. An RF Signal source for the frequency band of interest is connected to the dipole with a cable that has been constructed to not interfere with the radiation pattern of the antenna. A known (measured) power (P_{in}) is applied to the input of the dipole, and the power received (P_r) at the chamber's probe antenna is recorded.

The substitution method is used. Substitution values at each frequency are measured before and saved to the test software. A "reference path loss" is established as $AR_{pl} = P_{in} + 2.15 - P_r$. The AR_{pl} is the attenuation of "reference path loss", and including the gain of receive antenna, the cable loss and the air loss. The measurement results are obtained as described below: $Power = P_{Mea} + AR_{pl}$

The EUT is substituted for the dipole at the reference centre of the chamber and a scan is performed to obtain the radiation pattern.

From the radiation pattern, the co-ordinates where the maximum antenna gain occurs are identified.

The EUT is then put into continuously transmitting mode at its maximum power level.

Power mode measurements are performed with the receiving antenna placed at the coordinates determined in Step 3 to determine the output power as defined in Rule 24.232 (b) and (c). The "reference path loss" from Step1 is added to this result.

This value is EIRP since the measurement is calibrated using a half-wave dipole antenna of known gain (2.15 dBi) and known input power (Pin).

ERP can be calculated from EIRP by subtracting the gain of the dipole, $ERP = EIRP - 2.15dBi$.

Both horizontal and vertical antenna polarities were tested and performed pretest to three orthogonal axis. The worst case emissions were reported.

Substitution antenna and Receiving Antenna:

Item	Kind of Equipment	Manufacturer	Type No.	Serial No.	Character	Note
1	Bilog Antenna	TESEQ	CBL6111D	31216	30MHz~2GHz	Receiving Antenna
2	Horn Antenna	EM	EM-AH-10180	2011071402	1GHz~18GHz	Receiving Antenna
3	Bilog Antenna	TESEQ	CBL6111D	31216	30MHz~2GHz	Substitution antenna
4	Horn Antenna	EM	EM-AH-10180	2011071402	1GHz~18GHz	Substitution antenna

Use the following spectrum analyzer settings:

	GSM/GPRS/EGPRS	UMTS band
Span	500KHz	10MHz
RBW	10KHz	300KHz
VBW	30KHz	1MHz
Detector	RMS	RMS
Trace	Average	Average
Average Type	Power	Power
Sweep Count	100	100

7.3.6 Test Results

EUT:	Mobile Phone	Model No.:	2318
Temperature:	20 °C	Relative Humidity:	48%
Test Mode:	GSM850/GSM1900	Test By:	Susan su

■ Effective Radiated Power

Radiated Power (ERP) for GSM850							
Horizontal Polarization							
Frequency (MHz)	PMea (dBm)	Pcl (dB)	PAg (dB)	Ga Antenna Gain (dB)	Correction (dB)	ERP (dBm)	ERP (W)
824.2	-17.03	2.11	-52.73	0.87	2.15	30.57	1.1402
836.6	-17.24	2.13	-52.73	0.93	2.15	30.28	1.0666
848.8	-16.94	2.13	-52.73	0.97	2.15	30.54	1.1324
Vertical Polarization							
Frequency (MHz)	PMea (dBm)	Pcl (dB)	PAg (dB)	Ga Antenna Gain (dB)	Correction (dB)	ERP (dBm)	ERP (W)
824.2	-18.55	2.11	-52.73	0.87	2.15	29.05	0.8035
836.6	-18.08	2.13	-52.73	0.93	2.15	29.44	0.8790
848.8	-18.67	2.13	-52.73	0.97	2.15	28.81	0.7603

Radiated Power (ERP) for GPRS850							
Horizontal Polarization							
Frequency (MHz)	PMea (dBm)	Pcl (dB)	PAg (dB)	Ga Antenna Gain (dB)	Correction (dB)	ERP (dBm)	ERP (W)
824.2	-18.79	2.11	-52.73	0.87	2.15	28.81	0.7603
836.6	-19.25	2.13	-52.73	0.93	2.15	28.27	0.6714
848.8	-18.85	2.13	-52.73	0.97	2.15	28.63	0.7295
Vertical Polarization							
Frequency (MHz)	PMea (dBm)	Pcl (dB)	PAg (dB)	Ga Antenna Gain (dB)	Correction (dB)	ERP (dBm)	ERP (W)
824.2	-21.28	2.11	-52.73	0.87	2.15	26.32	0.4285
836.6	-21.54	2.13	-52.73	0.93	2.15	25.98	0.3963
848.8	-21.88	2.13	-52.73	0.97	2.15	25.60	0.3631

■ Effective Isotropic Radiated Power

Radiated Power (E.I.R.P) for GSM 1900 MHZ						
Horizontal Polarization						
Frequency (MHz)	PMea (dBm)	Pcl (dB)	PAg (dB)	Ga Antenna Gain (dB)	EIRP (dBm)	EIRP (W)
1850.2	-20.78	3.76	-48.53	-4.72	28.71	0.7430
1880	-22.62	3.91	-50.53	-4.59	28.59	0.7228
1909.8	-22.73	3.93	-50.53	-4.38	28.25	0.6683
Vertical Polarization						
Frequency (MHz)	PMea (dBm)	Pcl (dB)	PAg (dB)	Ga Antenna Gain (dB)	EIRP (dBm)	EIRP (W)
1850.2	-22.59	3.76	-48.53	-4.72	26.9	0.4898
1880	-24.27	3.91	-50.53	-4.59	26.94	0.4943
1909.8	-24.11	3.93	-50.53	-4.38	26.87	0.4864

Radiated Power (E.I.R.P) for GPRS 1900 MHZ						
Horizontal Polarization						
Frequency (MHz)	PMea (dBm)	Pcl (dB)	PAg (dB)	Ga Antenna Gain (dB)	EIRP (dBm)	EIRP (W)
1850.2	-22.57	3.76	-48.53	-4.72	26.92	0.4920
1880	-24.08	3.91	-50.53	-4.59	27.13	0.5164
1909.8	-24.81	3.93	-50.53	-4.38	26.17	0.4140
Vertical Polarization						
Frequency (MHz)	PMea (dBm)	Pcl (dB)	PAg (dB)	Ga Antenna Gain (dB)	EIRP (dBm)	EIRP (W)
1850.2	-24.16	3.76	-48.53	-4.72	25.33	0.3412
1880	-25.45	3.91	-50.53	-4.59	25.76	0.3767
1909.8	-25.84	3.93	-50.53	-4.38	25.14	0.3266

7.4 CONDUCTED OUTPUT POWER

7.4.1 Applicable Standard

According to FCC Part 2.1046 and FCC Part 22.913(a)(2) and FCC Part 24.232(c) and FCC KDB 971168 D01 v02r02 Section 5.2

7.4.2 Conformance Limit

Extend coverage on a secondary basis into cellular unserved areas, as those areas are defined in §22.949, the ERP of base transmitters and cellular repeaters of such systems must not exceed 1000 Watts. The ERP of mobile transmitters and auxiliary test transmitters must not exceed 7 Watts(38.5dBm).

Mobile and portable stations are limited to 2 watts (33dBm)EIRP and the equipment must employ a means for limiting power to the minimum necessary for successful communications..

7.4.3 Measuring Instruments

The Measuring equipment is listed in the section 6.3 of this test report.

7.4.4 Test Setup

Please refer to Section 6.1 of this test report.

7.4.5 Test Procedure

Connect the EUT to Universal Radio Communication Tester CMU200 or CMU500 via the antenna connector. A call is set up by the SS according to the generic call set up procedure on a channel with ARFCN in the ARFCN range, power control level set to Max power. The frequency band is set as selected frequency, The RF output of the transmitter was connected to base station simulator.

Set EUT at maximum average power by base station simulator.

Set RBW = 1-5% of the OBW, not to exceed 1 MHz.

Set VBW $\geq 3 \times$ RBW.

Number of points in sweep $\geq 2 \times$ span / RBW. (This gives bin-to-bin spacing \leq RBW/2, so that narrowband signals are not lost between frequency bins.)

Sweep time = auto.

Detector = RMS (power averaging).

Set sweep trigger to "free run".

Trace average at least 100 traces in power averaging (i.e., RMS) mode; however, the number of traces to be averaged shall be increased above 100 as needed such that the average accurately represents the true average over the on and off periods of the transmitter.

Compute power by integrating the spectrum across the OBW of the signal using the instrument's band power measurement function with band limits set equal to the OBW band edges. If the instrument does not have a band power function, sum the spectrum levels (in power units) at intervals equal to the RBW extending across the entire OBW of the spectrum.

Add $10 \log(1/x)$, where x is the duty cycle, to the measured power in order to compute the average power during the actual transmission times (because the measurement represents an average over both the on and off times of the transmission). For example, add $10 \log(1/0.25) = 6$ dB if the duty cycle is a constant 25%.

Measure lowest, middle, and highest channels for each bandwidth and different modulation.

Measure and record the results in the test report.

7.4.6 Test Results

EUT:	Mobile Phone	Model No.:	2318
Temperature:	20 °C	Relative Humidity:	48%
Test Mode:	GSM850/GSM1900	Test By:	Susan su

Output Power for GSM850

Mode	Frequency(MHz)	Maximum Burst-Average Output Power
GSM850	824.2	32.42
	836.6	32.13
	848.8	32.27
GPRS850(1 Slot)	824.2	32.36
	836.6	32.32
	848.8	32.21
GPRS850(2 Slot)	824.2	31.76
	836.6	31.63
	848.8	31.59
GPRS850(3 Slot)	824.2	29.36
	836.6	29.24
	848.8	29.12
GPRS850(4 Slot)	824.2	28.38
	836.6	29.25
	848.8	29.47

Output Power for PCS1900

Mode	Frequency(MHz)	Maximum Burst-Average Output Power
GSM1900	1850.2	29.73
	1880	29.65
	1909.8	28.46
GPRS1900(1 Slot)	1850.2	29.37
	1880	29.45
	1909.8	28.63
GPRS1900(2 Slot)	1850.2	28.13
	1880	28.27
	1909.8	28.49
GPRS1900(3 Slot)	1850.2	27.26
	1880	26.45
	1909.8	26.52
GPRS1900(4 Slot)	1850.2	26.34
	1880	26.47
	1909.8	25.59

7.5 FREQUENCY STABILITY

7.5.1 Applicable Standard

According to FCC Part 2.1055 and FCC Part 22.355 and FCC Part 24.235 and FCC KDB 971168 D01 Section 9.0

7.5.2 Conformance Limit

The frequency stability shall be measured by variation of ambient temperature and variation of primary supply voltage to ensure that the fundamental emission stays within the authorized frequency block. The frequency stability of the transmitter shall be maintained within $\pm 0.00025\%$ ($\pm 2.5\text{ppm}$) of the center frequency.

7.5.3 Measuring Instruments

The Measuring equipment is listed in the section 6.3 of this test report.

7.5.4 Test Setup

Please refer to Section 6.1 of this test report.

7.5.5 Test Procedure

Connect the EUT to Universal Radio Communication Tester CMU200 or CMU500 via the antenna connector. A call is set up by the SS according to the generic call set up procedure on a channel with ARFCN in the ARFCN range, power control level set to Max power. MS TXPWR_MAX_CCH is set to the maximum value supported by the Power Class of the Mobile under test.

EUT was placed at temperature chamber and connected to an external power supply. Temperature and voltage condition shall be tested to confirm frequency stability.

For Temperature Variation

1. The testing follows FCC KDB 971168 D01 v02r02 Section 9.0.
2. The EUT was set up in the thermal chamber and connected with the system simulator.
3. With power OFF, the temperature was decreased to -30°C and the EUT was stabilized before testing. Power was applied and the maximum change in frequency was recorded within one minute.
4. With power OFF, the temperature was raised in 10°C steps up to 50°C . The EUT was stabilized at each step for at least half an hour. Power was applied and the maximum frequency change was recorded within one minute.

For Voltage Variation

1. The testing follows FCC KDB 971168 D01 v02r02 Section 9.0.
2. The EUT was placed in a temperature chamber at $25\pm 5^{\circ}\text{C}$ and connected with the system simulator.
3. The power supply voltage to the EUT was varied from 85% to 115% of the nominal value measured at the input to the EUT.
4. The variation in frequency was measured for the worst case.

7.5.6 Test Results

EUT:	Mobile Phone	Model No.:	2318
Temperature:	20 °C	Relative Humidity:	48%
Test Mode:	Mode1/Mode2	Test By:	Susan su
Results: PASS			

Frequency Error Against Voltage for GSM 850 band		
Voltage (V)	Frequency Error (Hz)	Frequency Error (ppm)
3.145	17	0.020
3.7	26	0.031
4.255	12	0.014
20	12	0.014

Frequency Error Against Temperature for GSM 850 band		
Temperature (°C)	Frequency Error (Hz)	Frequency Error (ppm)
-10	34	0.041
0	22	0.026
10	17	0.020
30	25	0.030
40	13	0.016
50	34	0.041

Frequency Error Against Voltage for GPRS850 band		
Voltage (V)	Frequency Error (Hz)	Frequency Error (ppm)
3.5	17	0.0203
3.7	15	0.0179
4.2	12	0.0143

Frequency Error Against Temperature for GPRS850 band		
Temperature (°C)	Frequency Error (Hz)	Frequency Error (ppm)
-10	30	0.0359
0	28	0.0335
10	26	0.0311
20	26	0.0311
30	25	0.0299
40	20	0.0239
50	16	0.0191

Note:

1. Normal Voltage = 3.7V; Battery End Point (BEP) = 3.2V; Maximum Voltage = 4.2V
2. The frequency fundamental emissions stay within the authorized frequency block based on the frequency deviation measured is small.

Frequency Error Against Voltage for PCS 1900 band		
Voltage (V)	Frequency Error (Hz)	Frequency Error (ppm)
3.145	32	0.017
3.7	24	0.013
4.255	19	0.010

Frequency Error Against Temperature for PCS 1900 band		
Temperature (°C)	Frequency Error (Hz)	Frequency Error (ppm)
-10	34	0.018
0	26	0.014
10	18	0.010
20	23	0.012
30	17	0.009
40	16	0.009
50	28	0.015

Frequency Error Against Voltage for GPRS1900 band		
Voltage (V)	Frequency Error (Hz)	Frequency Error (ppm)
3.5	30	0.0160
3.7	32	0.0170
4.2	25	0.0133

Frequency Error Against Temperature for GPRS1900 band		
Temperature (°C)	Frequency Error (Hz)	Frequency Error (ppm)
-10	33	0.0176
0	32	0.0170
10	32	0.0170
20	30	0.0160
30	20	0.0106
40	22	0.0117
50	3	0.0016

Note:

1. Normal Voltage = 3.7V; Battery End Point (BEP) = 3.2V; Maximum Voltage =4.2V
2. The frequency fundamental emissions stay within the authorized frequency block based on the frequency deviation measured is small.

7.6 PEAK-TO-AVERAGE RATIO

7.6.1 Applicable Standard

According to FCC 22.913 and FCC 24.232(d) and FCC KDB 971168 D01 Section 5.7.1

7.6.2 Conformance Limit

The peak-to-average power ratio (PAPR) of the transmitter output power must not exceed 13 dB. The PAPR measurements should be made using either an instrument with complementary cumulative distribution function (CCDF) capabilities to determine that PAPR will not exceed 13 dB for more than 0.1 percent of the time or other Commission approved procedure. The measurement must be performed using a signal corresponding to the highest PAPR expected during periods of continuous transmission.

7.6.3 Measuring Instruments

The Measuring equipment is listed in the section 6.3 of this test report.

7.6.4 Test Setup

Please refer to Section 6.1 of this test report.

7.6.5 Test Procedure

The EUT was connected to Spectrum Analyzer and Base Station via power divider.

The RF output of EUT was connected to the spectrum analyzer by RF cable and attenuator. The path loss was compensated to the results for each measurement.

Set the number of counts to a value that stabilizes the measured CCDF curve.

Set the measurement interval to 1 ms.

Record the maximum PAPR level associated with a probability of 0.1%.

a) Refer to instrument's analyzer instruction manual for details on how to use the power statistics/CCDF function;

b) Set resolution/measurement bandwidth \geq signal's occupied bandwidth;

c) Set the number of counts to a value that stabilizes the measured CCDF curve;

d) Set the measurement interval as follows:

1) for continuous transmissions, set to 1 ms,

2) for burst transmissions, employ an external trigger that is synchronized with the EUT burst timing sequence, or use the internal burst trigger with a trigger level that allows the burst to stabilize and set the measurement interval to a time that is less than or equal to the burst duration.

e) Record the maximum PAPR level associated with a probability of 0.1%.

7.6.6 Test Results

EUT:	Mobile Phone	Model No.:	2318
Temperature:	20 °C	Relative Humidity:	48%
Test Mode:	Mode1/Mode2	Test By:	Susan su
Results: PASS			

Cellular Band						
Modes	GSM850			GSM1900		
Channel	128 (Low)	190 (Mid)	251 (High)	512 (Low)	661 (Mid)	810 (High)
Frequency(MHz)	824.2	836.6	848.8	1850.2	1880	1909.8
Peak-to-Average Ratio (dB)	-0.016	-0.024	-0.003	-0.003	-0.001	0

Cellular Band						
Modes	GPRS850			GPRS1900		
Channel	128 (Low)	190 (Mid)	251 (High)	512 (Low)	661 (Mid)	810 (High)
Frequency(MHz)	824.2	836.6	848.8	1850.2	1880	1909.8
Peak-to-Average Ratio (dB)	0.012	-0.011	-0.006	-0.010	-0.015	0.002

All the modulation modes and Channels have been tested, the data of the worst mode (GSM) are recorded in the following pages.

Peak-to-average power ratio plot on channel 128

GSM850

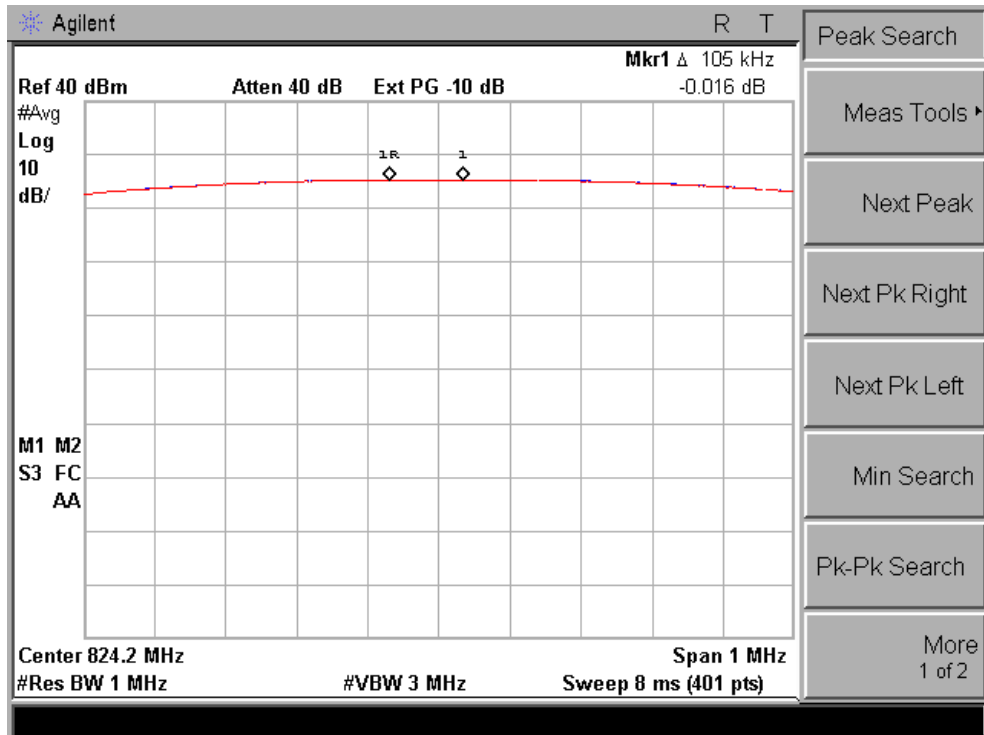

Peak-to-average power ratio plot on channel 190

GSM850

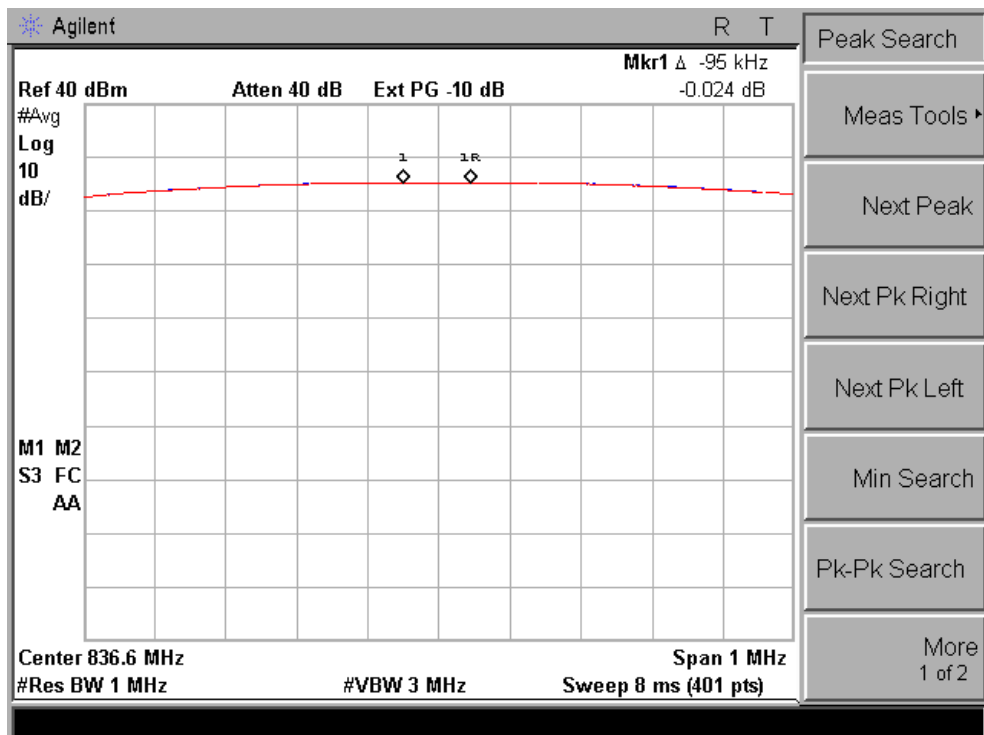

Peak-to-average power ratio plot on channel 251

GSM850

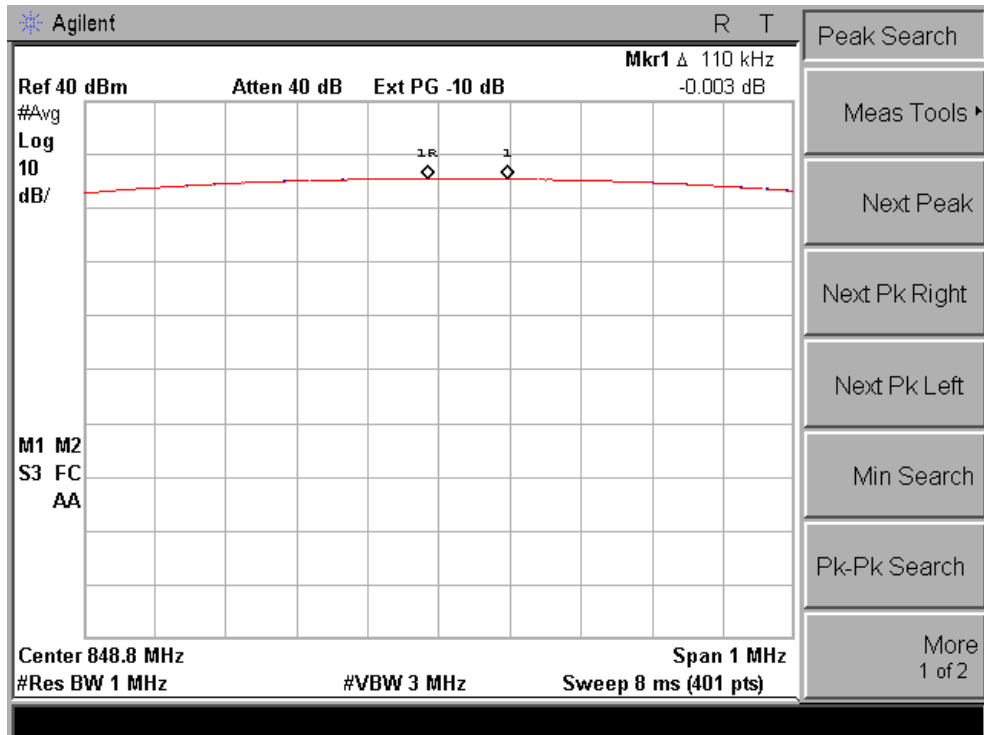

Peak-to-average power ratio plot on channel 512

GSM1900

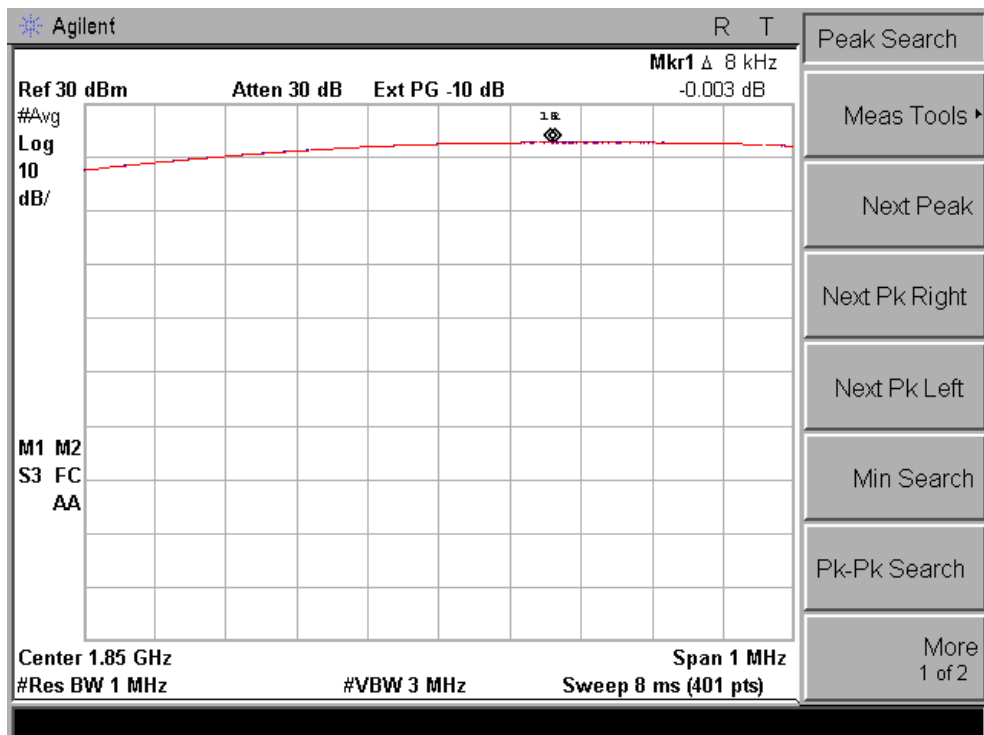

Peak-to-average power ratio plot on channel 661

GSM1900

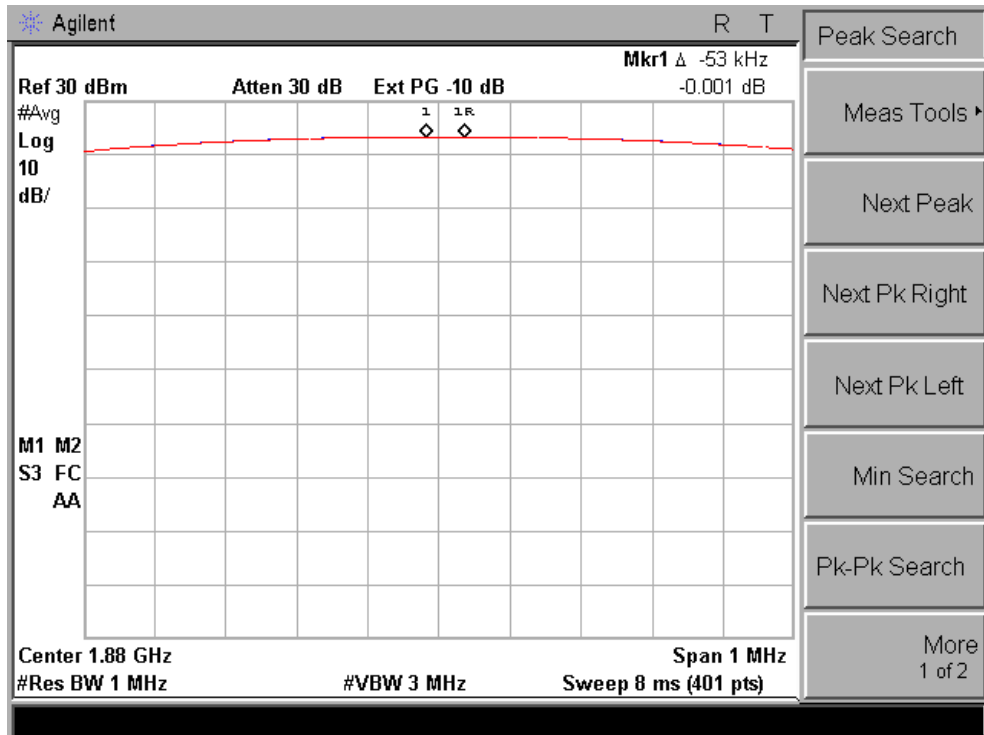

Peak-to-average power ratio plot on channel 810

GSM1900

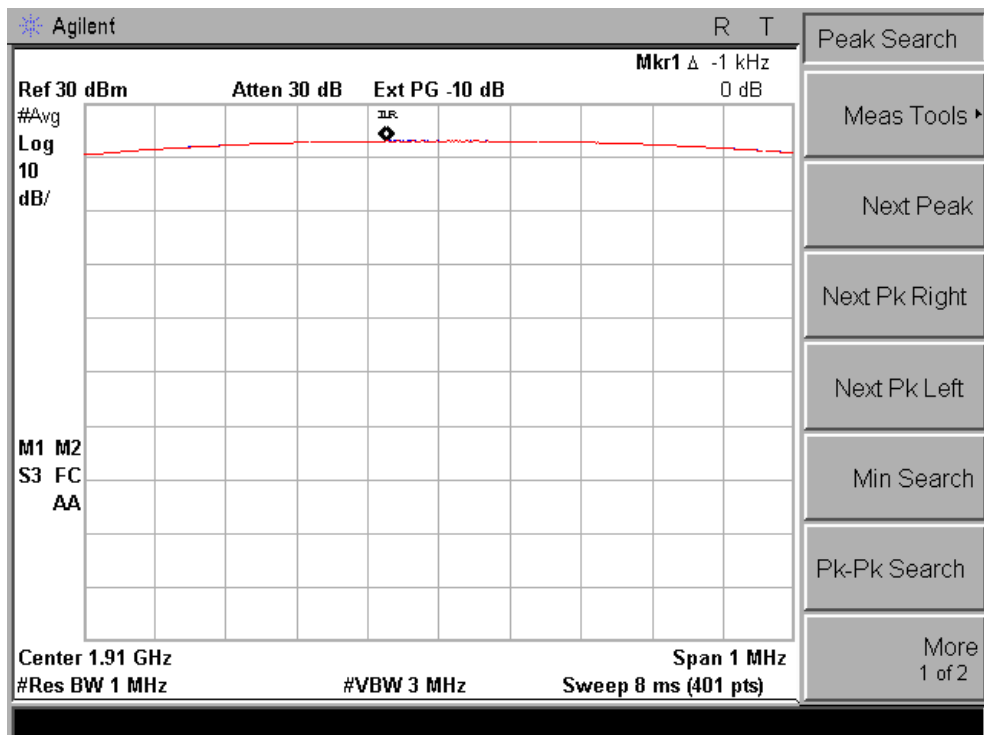

7.7 26DB BANDWIDTH AND 99% OCCUPIED BANDWIDTH

7.7.1 Applicable Standard

According to FCC Part 2.1049 and FCC Part 22H and FCC Part 24E and FCC KDB 971168 D01 Section 4.0

7.7.2 Conformance Limit

The occupied bandwidth is the width of a frequency band such that, below the lower and above the upper frequency limits, the mean powers emitted are each equal to a specified percentage 0.5% of the total mean transmitted power.

The 26 dB emission bandwidth is defined as the frequency range between two points, one above and one below the carrier frequency, at which the spectral density of the emission is attenuated 26 dB below the maximum in-band spectral density of the modulated signal. Spectral density (power per unit bandwidth) is to be measured with a detector of resolution bandwidth equal to approximately 1.0% of the emission bandwidth.

7.7.3 Measuring Instruments

The Measuring equipment is listed in the section 6.3 of this test report.

7.7.4 Test Setup

Please refer to Section 6.1 of this test report.

7.7.5 Test Procedure

The testing follows FCC KDB 971168 v02r02 Section 4.0.

The EUT was connected to Spectrum Analyzer and Base Station via power divider.

The RF output of EUT was connected to the spectrum analyzer by RF cable and attenuator. The path loss was compensated to the results for each measurement.

The spectrum analyzer center frequency is set to the nominal EUT channel center frequency. The span range for the spectrum analyzer shall be between two and five times the anticipated OBW.

The nominal resolution bandwidth (RBW) shall be in the range of 1 to 5 % of the anticipated OBW, and the VBW shall be at least 3 times the RBW.

Set the detection mode to peak, and the trace mode to max hold.

Determine the reference value: Set the EUT to transmit a modulated signal. Allow the trace to stabilize. Set the spectrum analyzer marker to the highest level of the displayed trace.

(this is the reference value)

Determine the “-26 dB down amplitude” as equal to (Reference Value – X).

Place two markers, one at the lowest and the other at the highest frequency of the envelope of the spectral display such that each marker is at or slightly below the “-X dB down amplitude” determined in step 6. If a marker is below this “-X dB down amplitude” value it shall be placed as close as possible to this value. The OBW is the positive frequency difference between the two markers.

Use the 99 % power bandwidth function of the spectrum analyzer and report the measured bandwidth.

7.7.6 Test Results

EUT:	Mobile Phone	Model No.:	2318
Temperature:	20 °C	Relative Humidity:	48%
Test Mode:	Mode1/Mode2	Test By:	Susan su
Results: PASS			

Operation Mode	Channel Number	Channel Frequency (MHz)	26dB Bandwidth (kHz)	99% Occupied Bandwidth (kHz)	Limit (kHz)	Verdict
GSM850	128	824.2	320.175	246.469	N/A	PASS
	189	836.4	321.733	246.706	N/A	PASS
	251	848.8	321.562	245.079	N/A	PASS
GSM1900	512	1850.2	315.032	244.035	N/A	PASS
	661	1880.0	314.429	246.709	N/A	PASS
	810	1909.8	316.952	247.116	N/A	PASS
GPRS850	128	824.2	315.966	243.348	N/A	PASS
	189	836.4	321.172	247.328	N/A	PASS
	251	848.8	319.977	245.627	N/A	PASS
GPRS1900	512	1850.2	317.677	243.145	N/A	PASS
	661	1880.0	320.312	245.666	N/A	PASS
	810	1909.8	321.452	249.594	N/A	PASS

All the modulation modes and Channels have been tested, the data of the worst mode (GSM) are recorded in the following pages.

99% Occupied Bandwidth plot on channel 128

GSM850

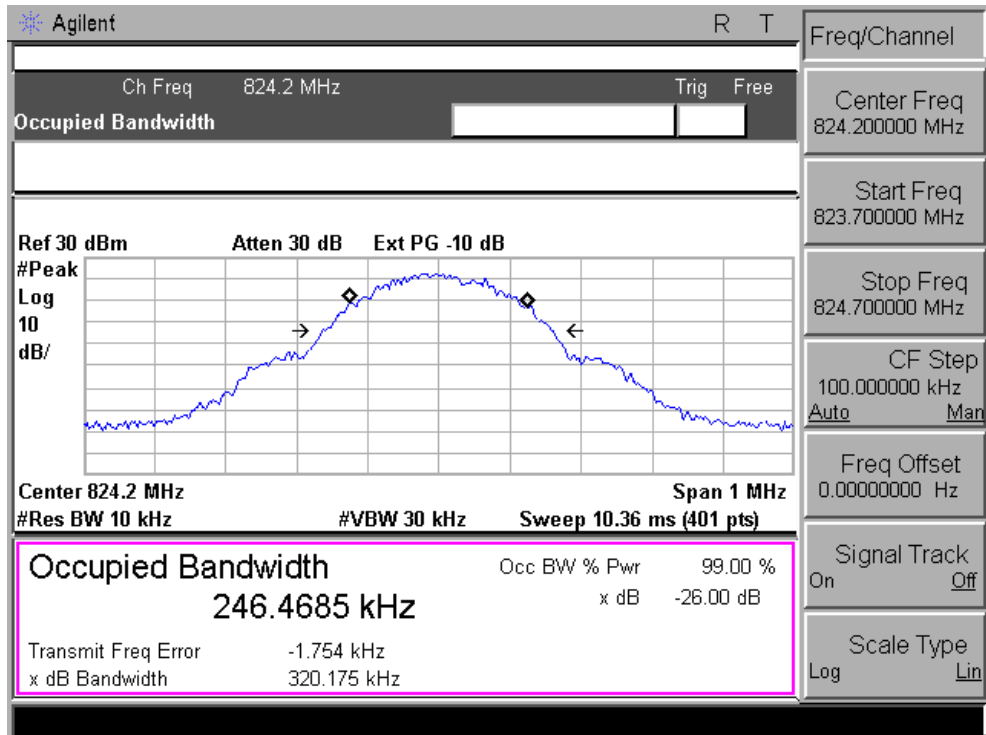

26dB Bandwidth plot on channel 128

GSM850

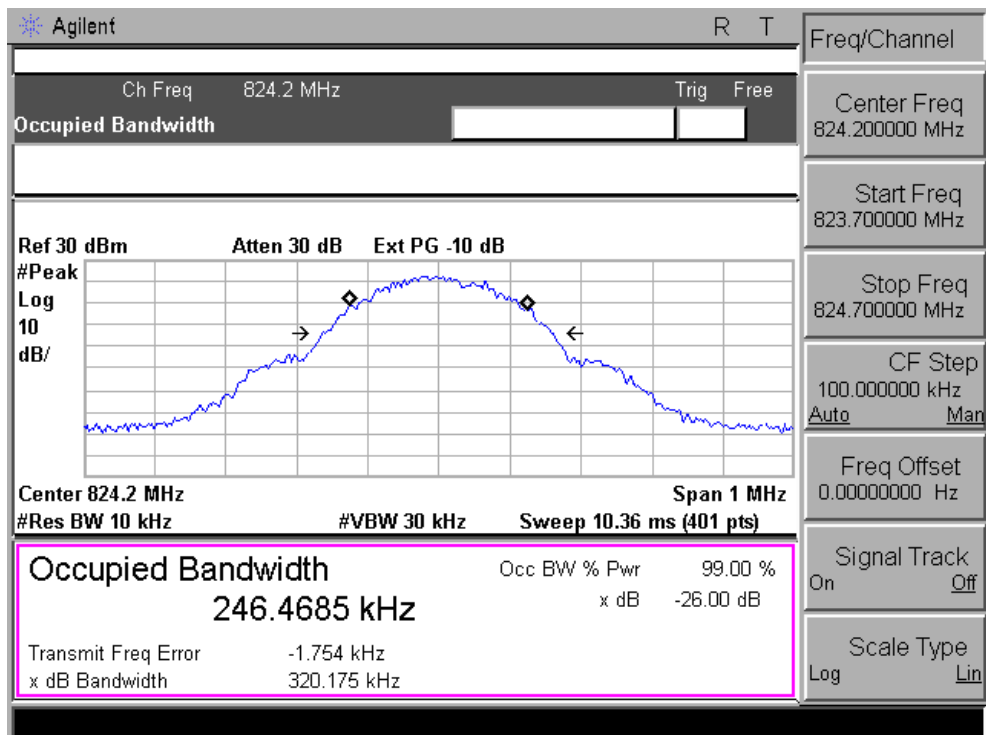

99% Occupied Bandwidth plot on channel 190

GSM850

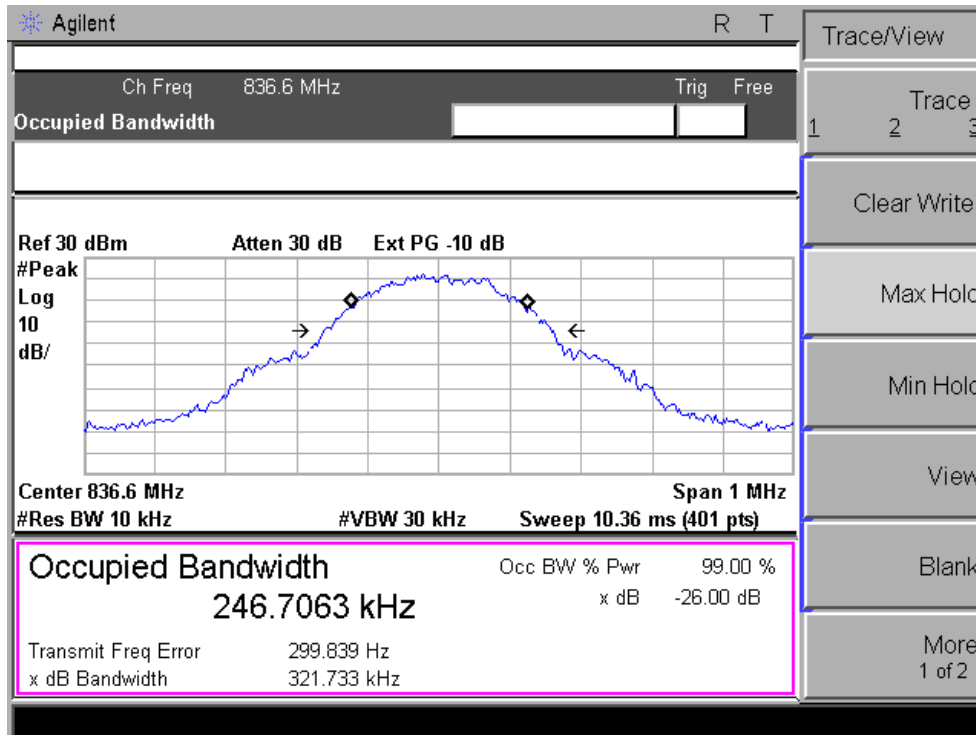

26dB Bandwidth plot on channel 190

GSM850

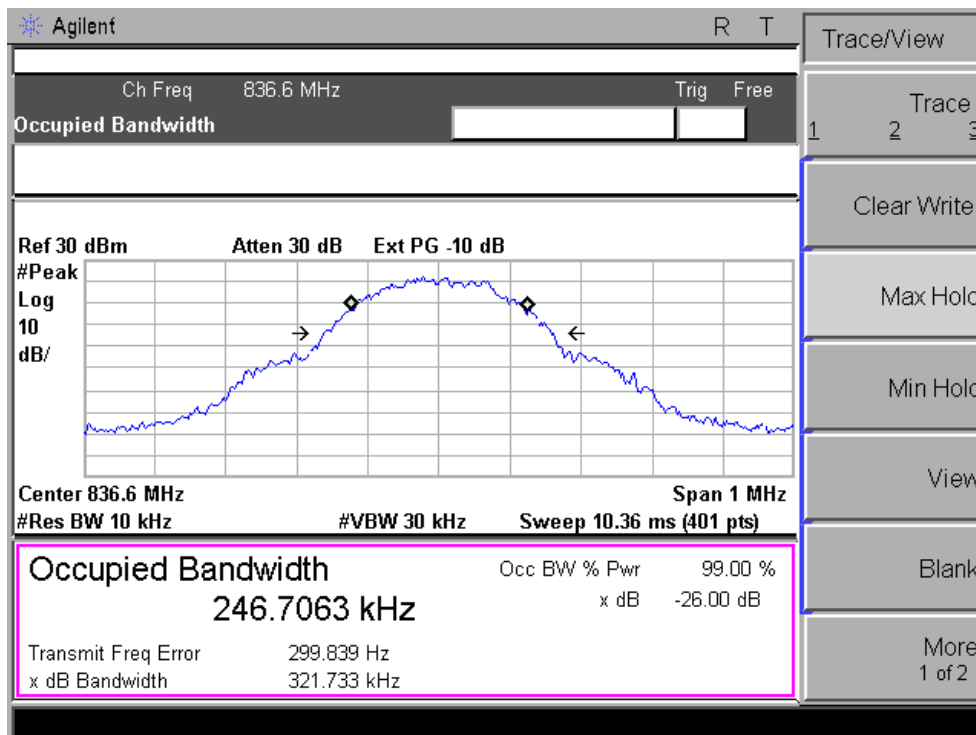

99% Occupied Bandwidth plot on channel 251

GSM850

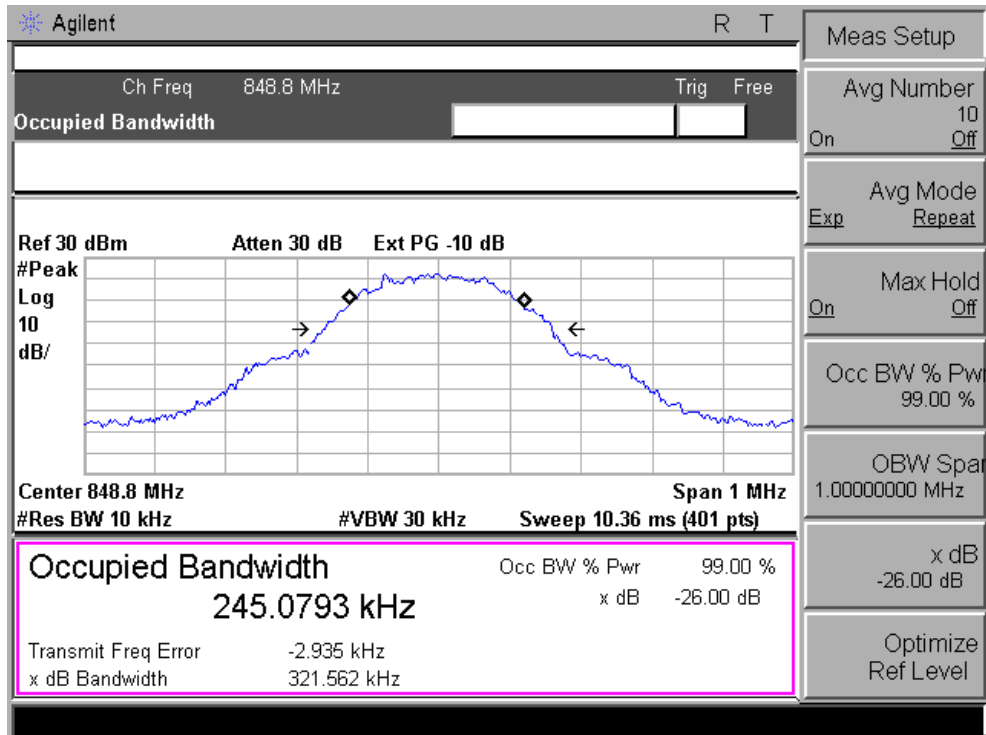

26dB Bandwidth plot on channel 251

GSM850

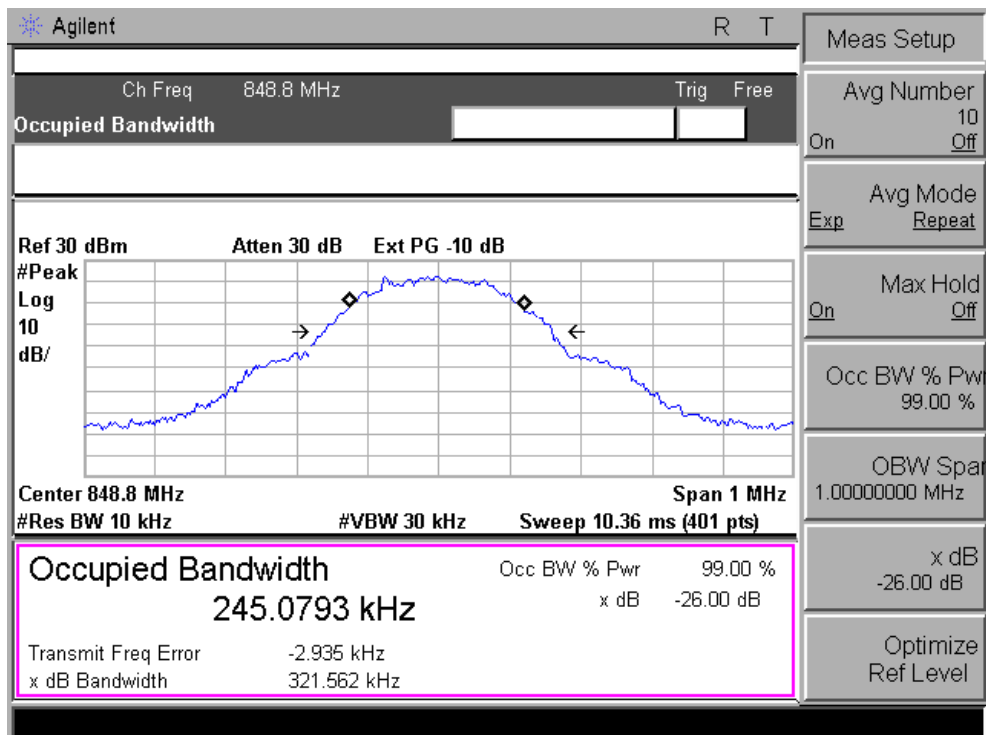

99% Occupied Bandwidth plot on channel 512

GSM1900

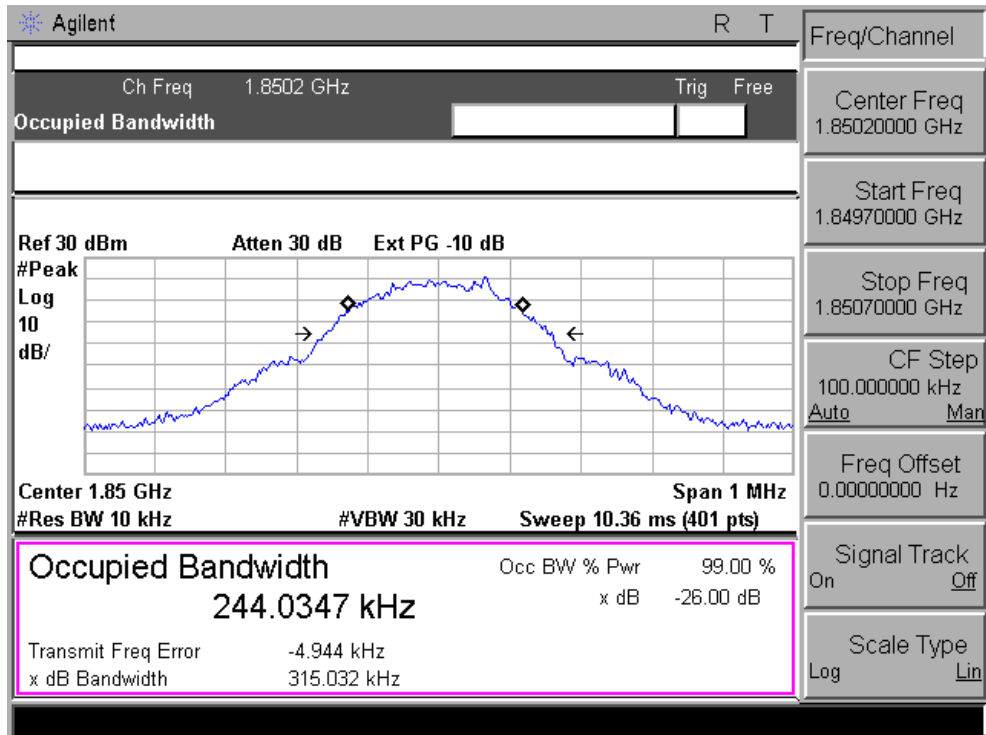

26dB Bandwidth plot on channel 512

GSM1900

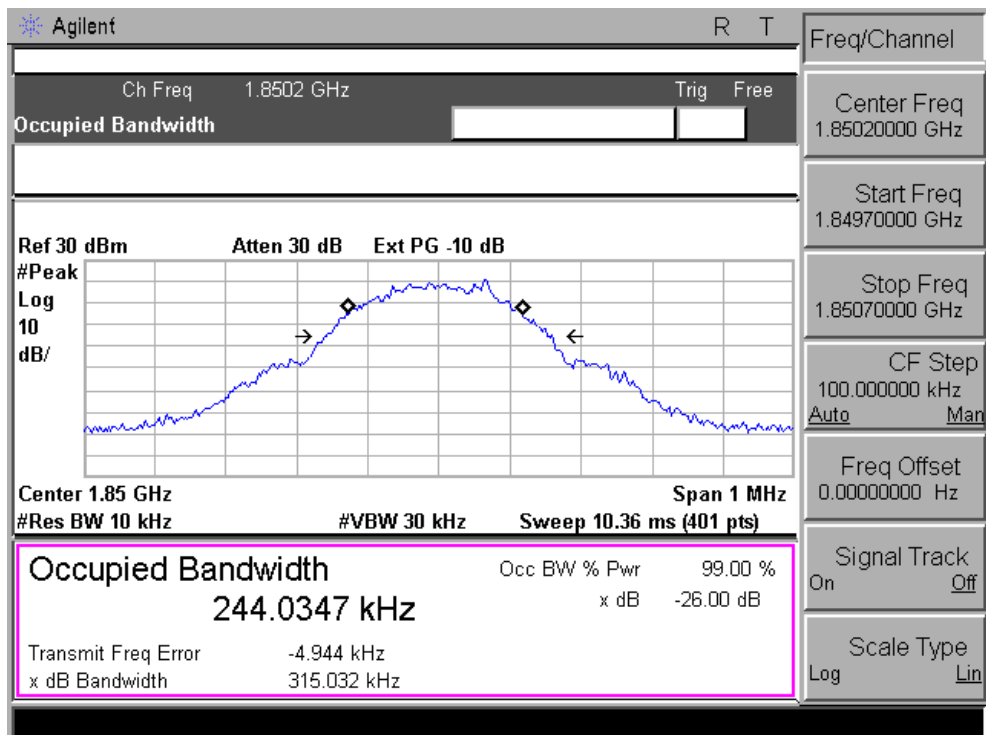

99% Occupied Bandwidth plot on channel 661

GSM1900

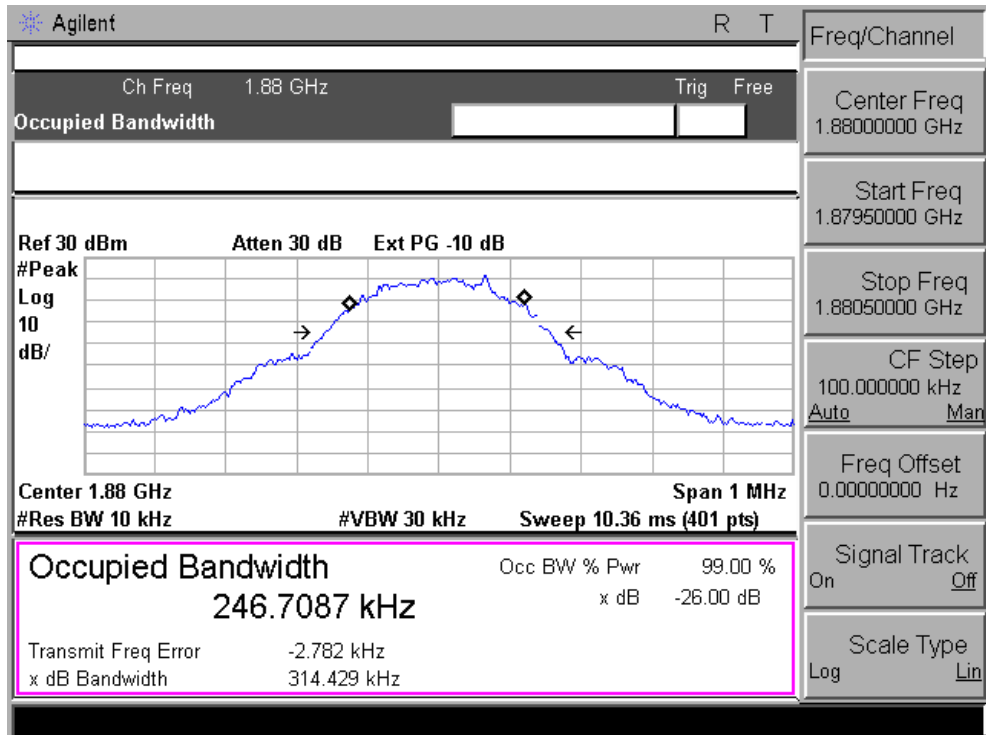

26dB Bandwidth plot on channel 661

GSM1900

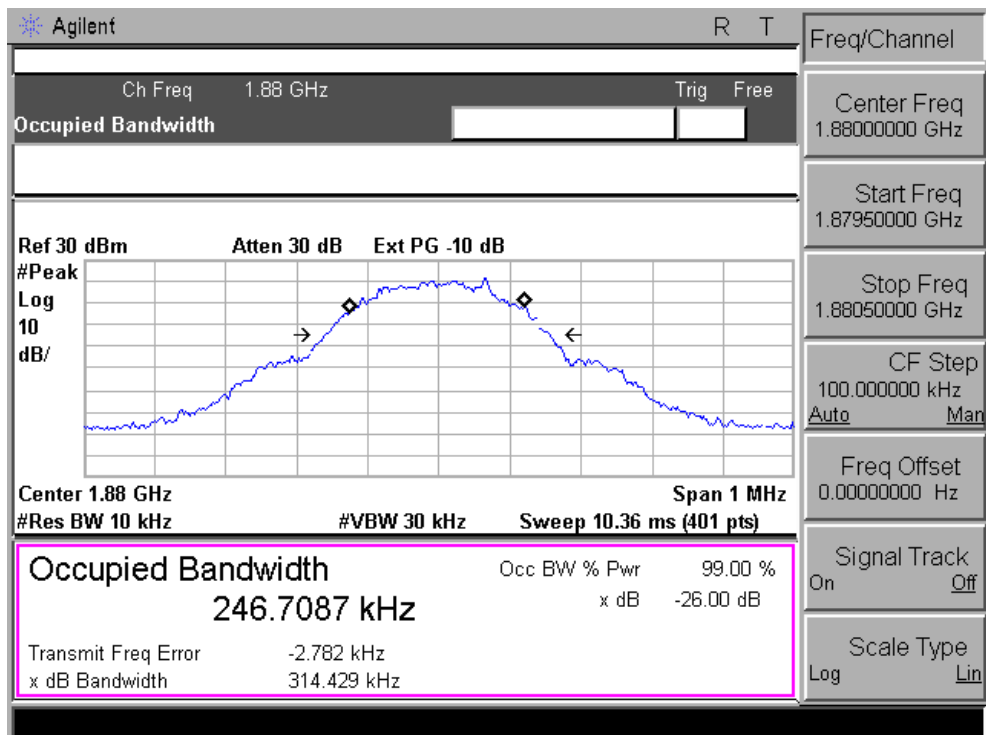

99% Occupied Bandwidth plot on channel 810

GSM1900

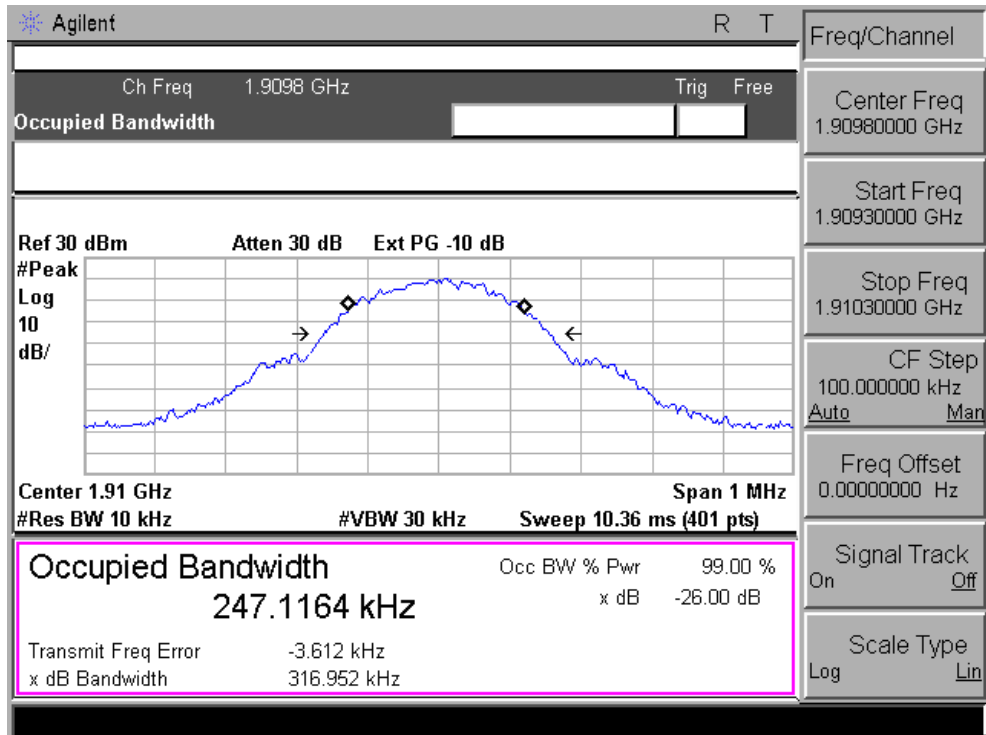

26dB Bandwidth plot on channel 810

GSM1900

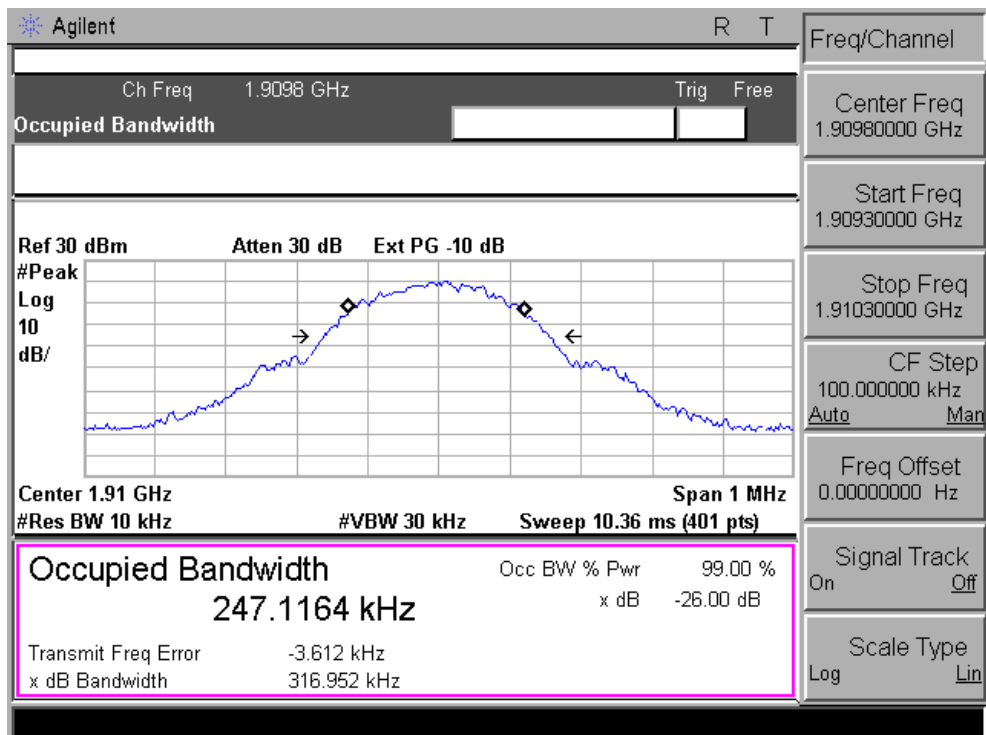

7.8 CONDUCTED BAND EDGE

7.8.1 Applicable Standard

According to FCC Part 2.1051 and FCC Part 22.917(a) and 24.238(a) and FCC KDB 971168 D01 Section6.0

7.8.2 Conformance Limit

The power of any emission outside of the authorized operating frequency ranges must be lower than the transmitter power (P) by a factor of at least $43 + 10 \log (P)$ dB.

7.8.3 Measuring Instruments

The Measuring equipment is listed in the section 6.3 of this test report.

7.8.4 Test Setup

Please refer to Section 6.1 of this test report.

7.8.5 Test Procedure

The testing follows FCC KDB 971168 v02r02 Section 6.0.
 The EUT was connected to Spectrum Analyzer and Base Station via power divider.
 The RF output of EUT was connected to the spectrum analyzer by RF cable and attenuator.
 The path loss was compensated to the results for each measurement.
 The band edges of low and high channels for the highest RF powers were measured.
 The RF fundamental frequency should be excluded against the limit line in the operating frequency band.
 The limit line is derived from $43 + 10\log(P)$ dB below the transmitter power P(Watts)
 $= P(W) - [43 + 10\log(P)]$ (dB)
 $= [30 + 10\log(P)]$ (dBm) - $[43 + 10\log(P)]$ (dB)
 $= -13\text{dBm}$.

7.8.6 Test Results

EUT:	Mobile Phone	Model No.:	2318
Temperature:	20 °C	Relative Humidity:	48%
Test Mode:	Mode1/Mode2	Test By:	Susan su
Results: PASS			

Conducted Band Edge plot on channel 128

GSM850

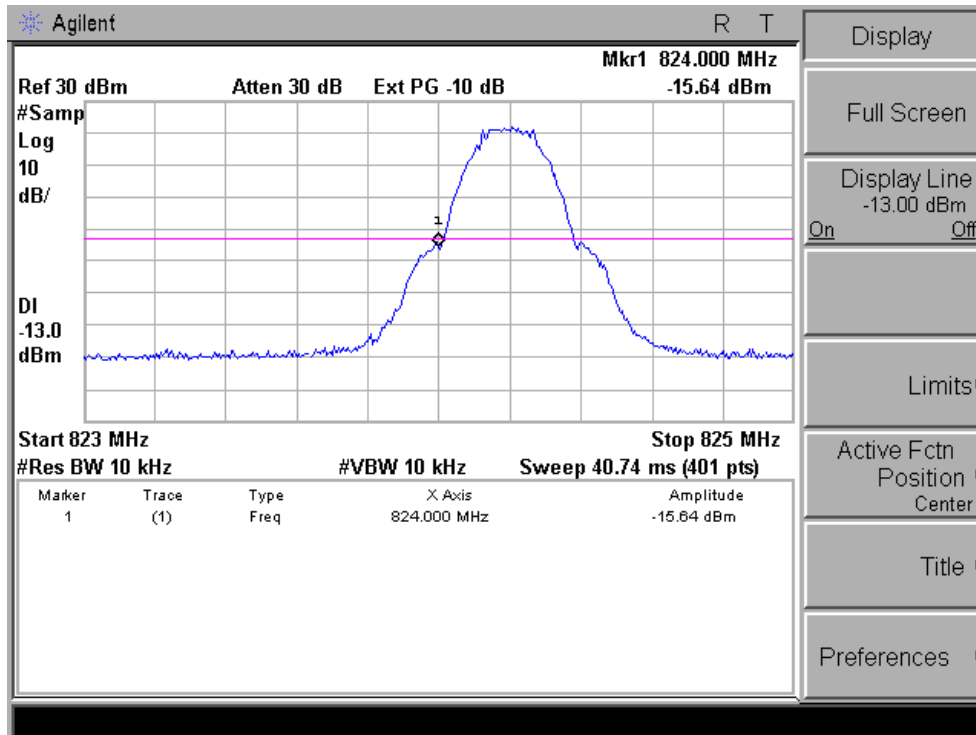

Conducted Band Edge plot on channel 251

GSM850

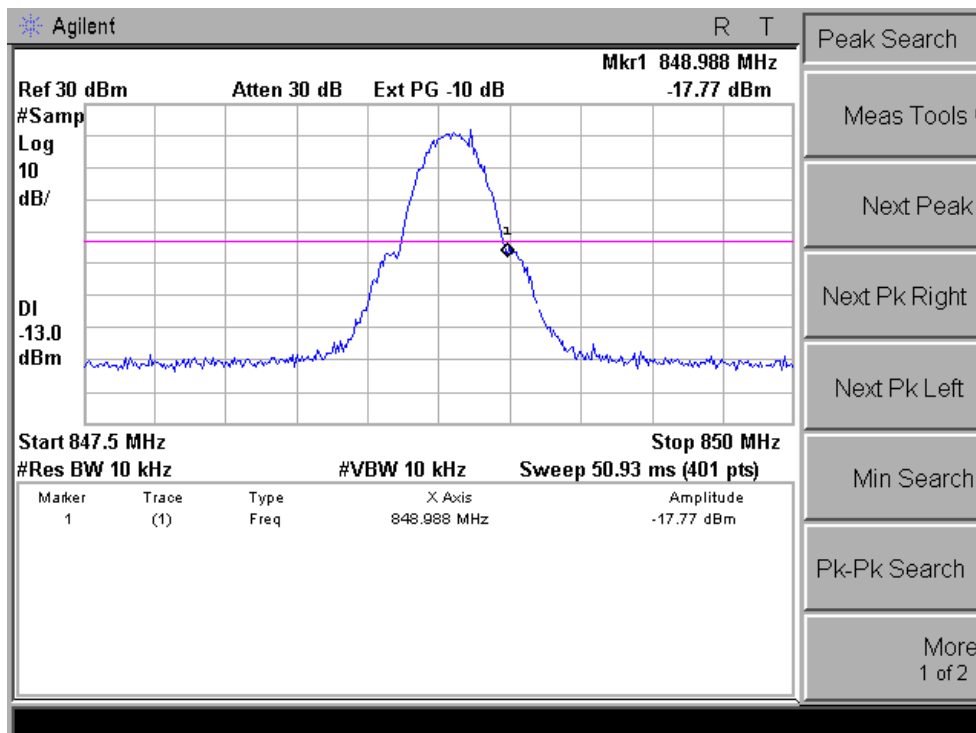

Conducted Band Edge plot on channel 512

GSM512

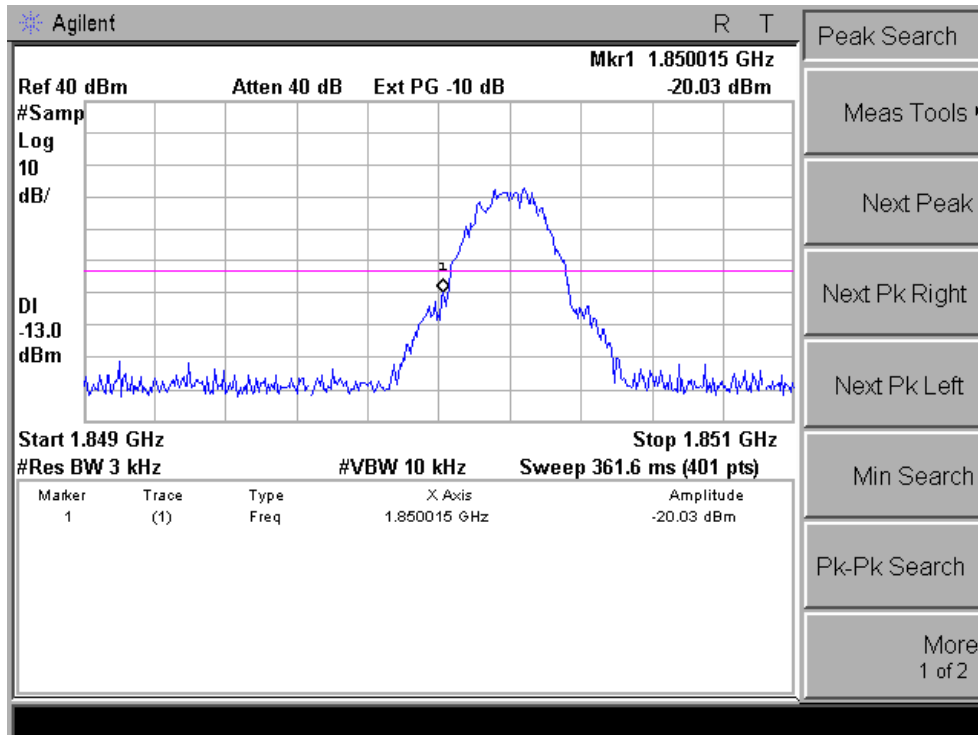

Conducted Band Edge plot on channel 810

GSM1900

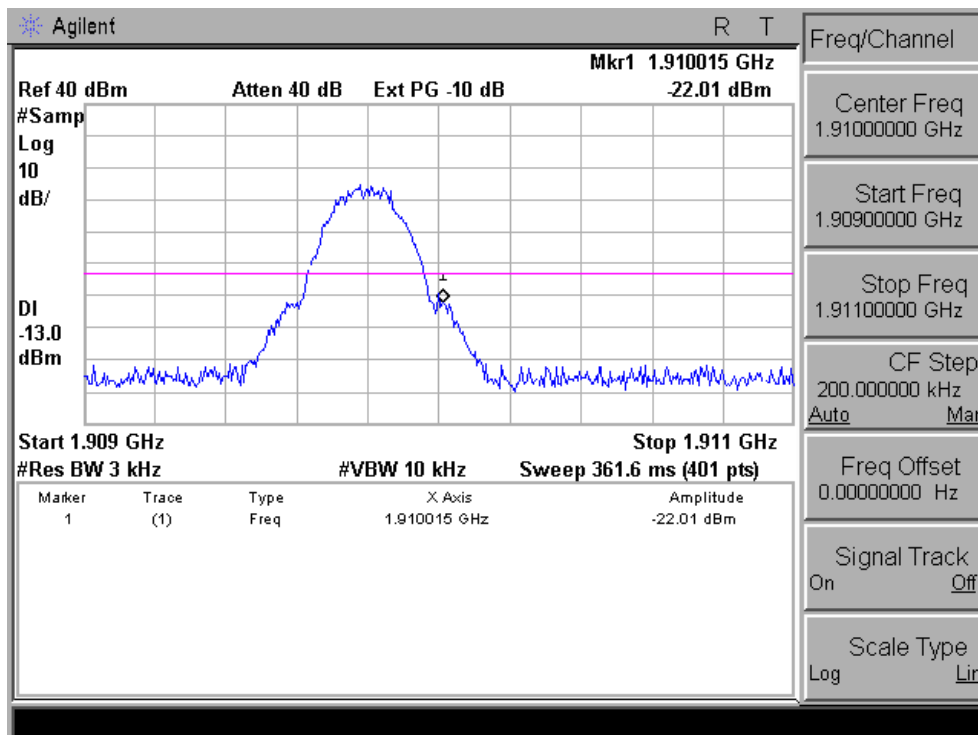

Conducted Band Edge plot on channel 128

GPRS850

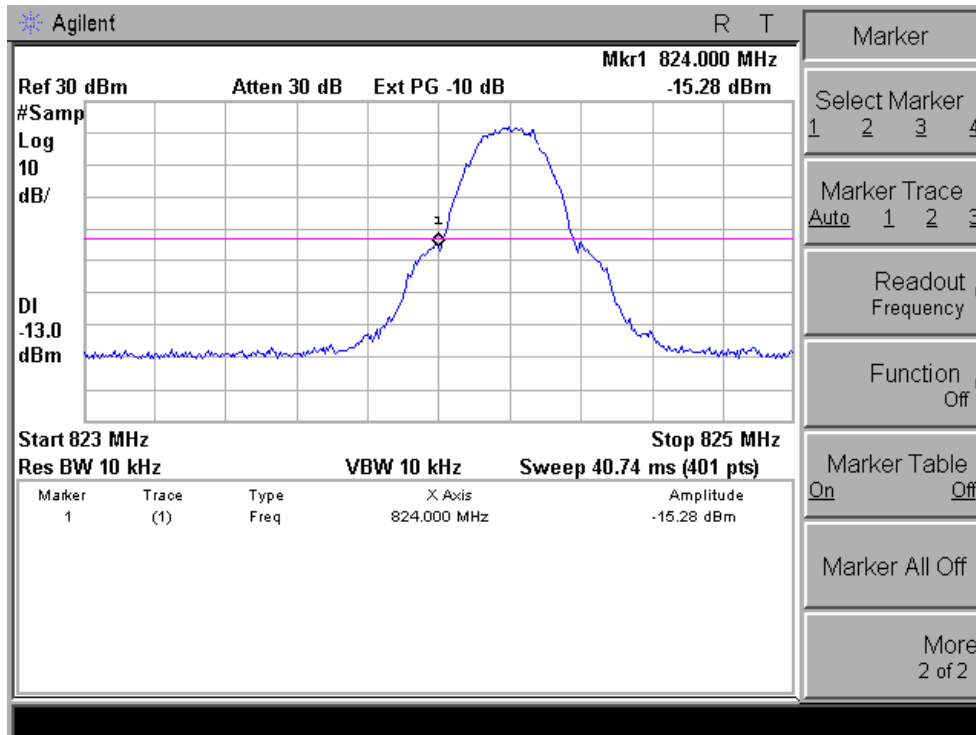

Conducted Band Edge plot on channel 251

GPRS850

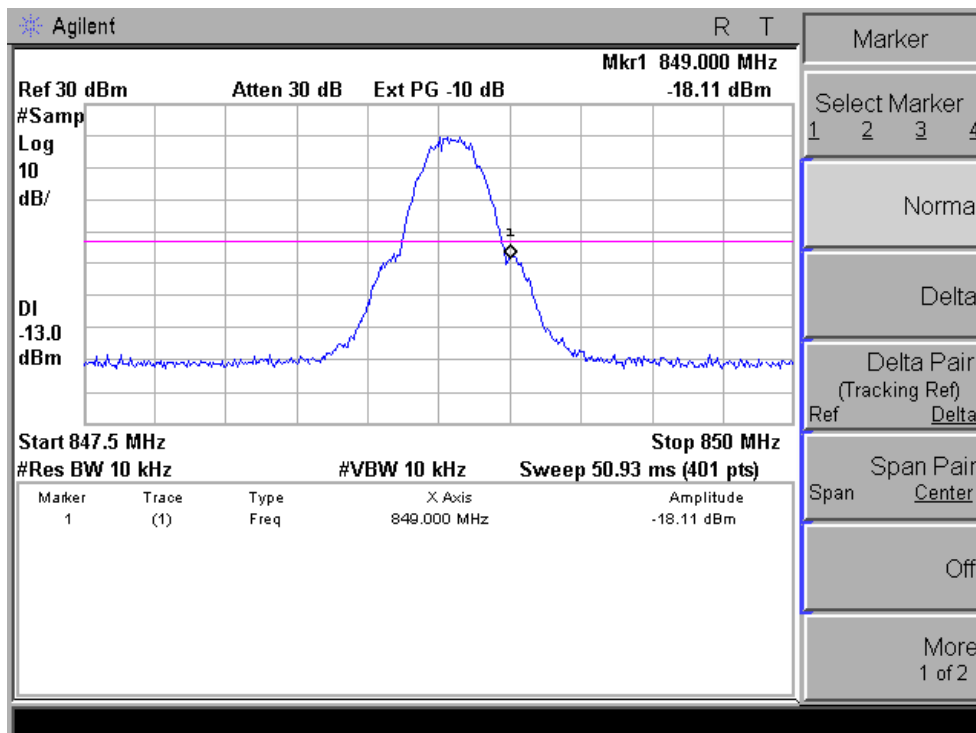

Conducted Band Edge plot on channel 512

GPRS1900

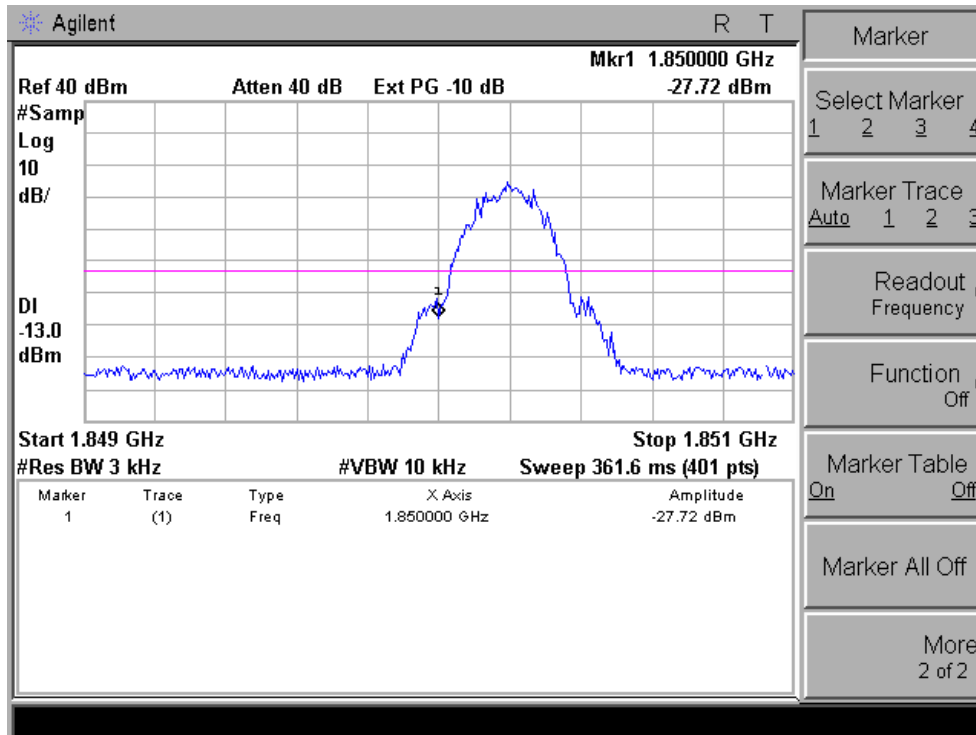

Conducted Band Edge plot on channel 810

GPRS1900

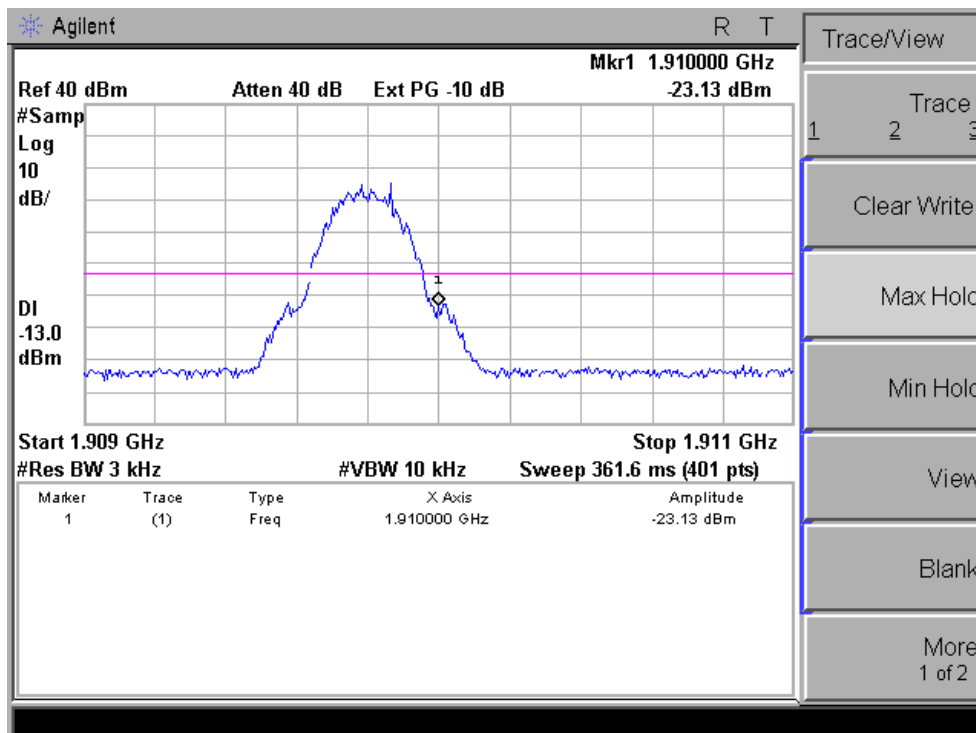

7.9 CONDUCTED SPURIOUS EMISSION AT ANTENNA TERMINAL

7.9.1 Applicable Standard

According to FCC Part 2.1051 and FCC Part 22.917(a) and Part 24.238(a) and FCC KDB 971168 D01 Section6.0

7.9.2 Conformance Limit

The power of any emission outside of the authorized operating frequency ranges must be lower than the transmitter power (P) by a factor of at least $43 + 10 \log (P)$ dB. It is measured by means of a calibrated spectrum analyzer and scanned from 30 MHz up to a frequency including its 10th harmonic.

7.9.3 Measuring Instruments

The Measuring equipment is listed in the section 6.3 of this test report.

7.9.4 Test Setup

Please refer to Section 6.1 of this test report.

7.9.5 Test Procedure

The testing follows FCC KDB 971168 v02r02 Section 6.0.
 The EUT was connected to Spectrum Analyzer and Base Station via power divider.
 The RF output of EUT was connected to the spectrum analyzer by RF cable and attenuator.
 The path loss was compensated to the results for each measurement.
 The middle channel for the highest RF power within the transmitting frequency was measured.
 The conducted spurious emission for the whole frequency range was taken.
 The RF fundamental frequency should be excluded against the limit line in the operating frequency band.
 The limit line is derived from $43 + 10\log(P)$ dB below the transmitter power P(Watts)
 $= P(W) - [43 + 10\log(P)]$ (dB)
 $= [30 + 10\log(P)]$ (dBm) - $[43 + 10\log(P)]$ (dB)
 $= -13\text{dBm}$.

7.9.6 Test Results

EUT:	Mobile Phone	Model No.:	2318
Temperature:	20 °C	Relative Humidity:	48%
Test Mode:	Mode1/Mode2	Test By:	Susan su
Results: PASS			

All the modulation modes and Channels have been tested, the data of the worst mode (GSM) are recorded in the following pages.

Conducted Emission Transmitting Mode CH 128 30MHz – 5GHz

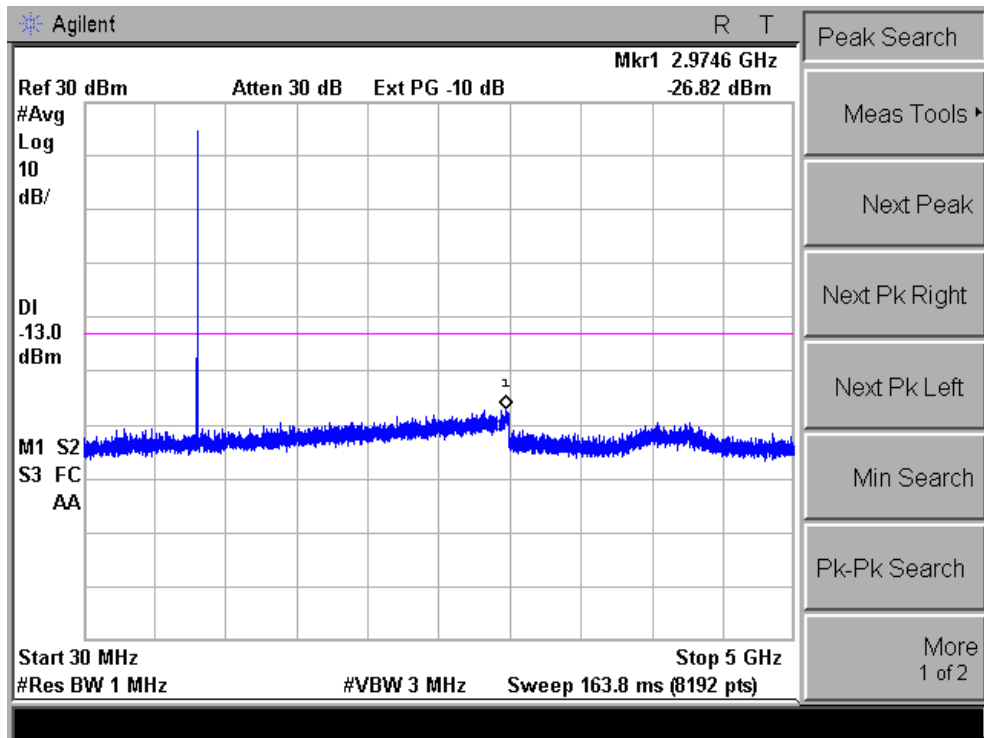

Conducted Emission Transmitting Mode CH 128 5GHz – 10GHz

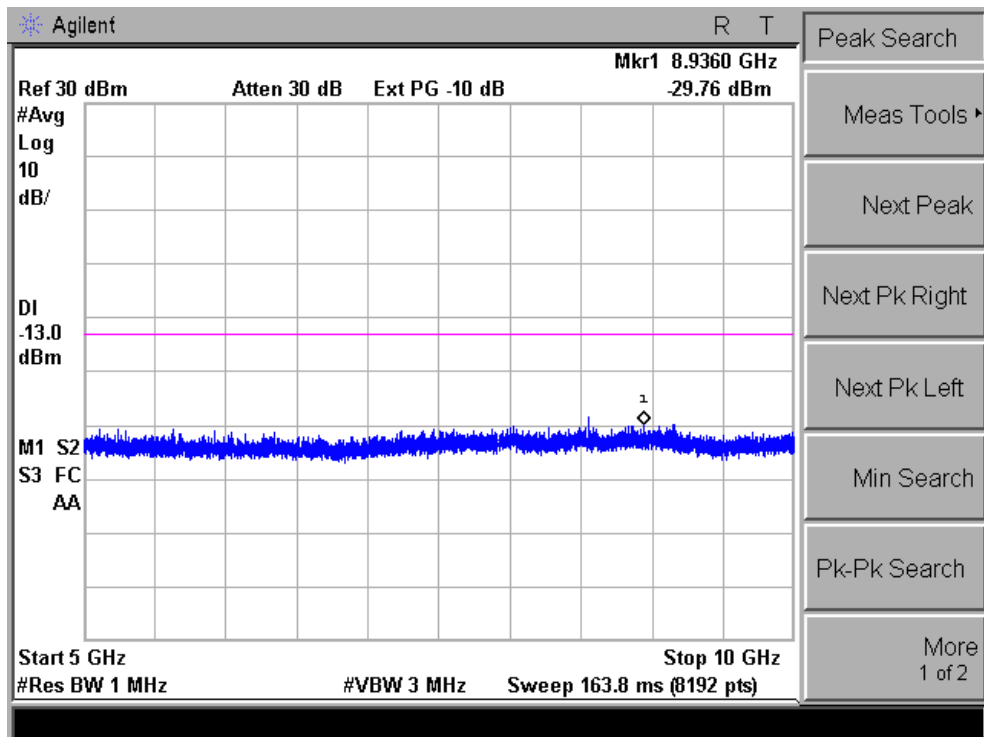

Conducted Emission Transmitting Mode CH 190 30MHz – 5GHz

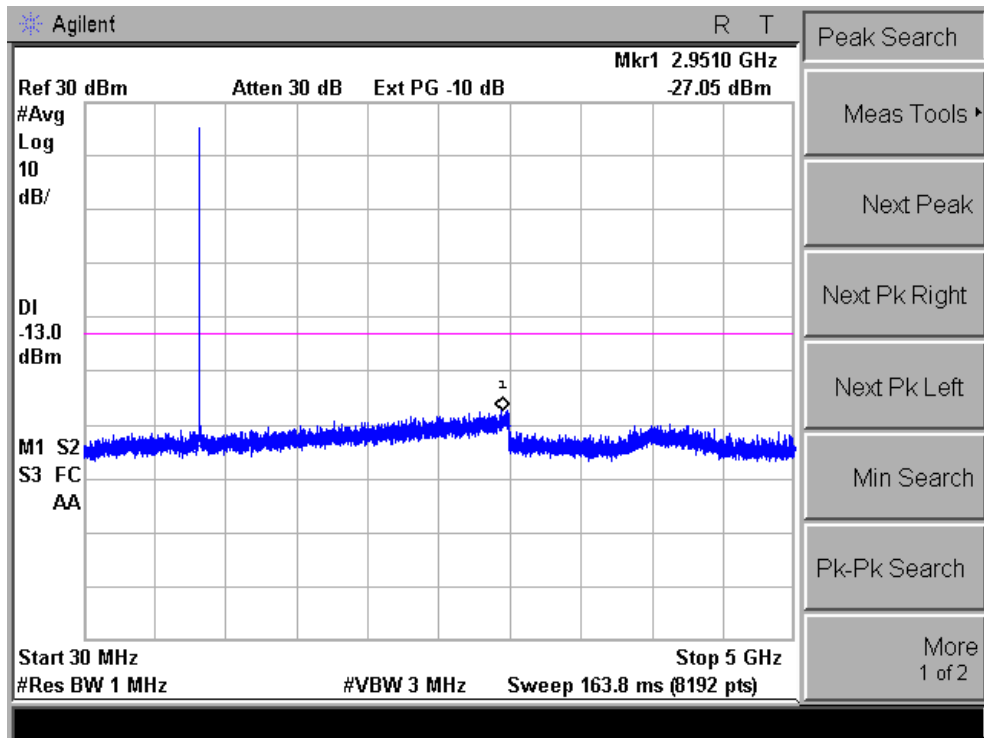

Conducted Emission Transmitting Mode CH 190 5GHz – 10GHz

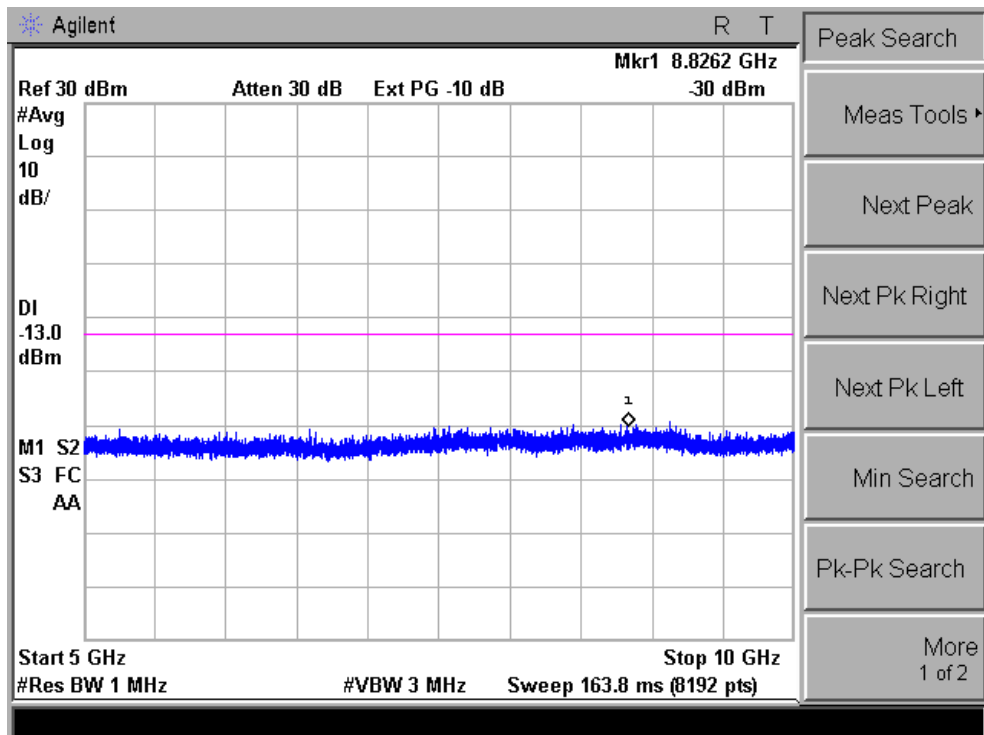

Conducted Emission Transmitting Mode CH 251 30MHz – 5GHz

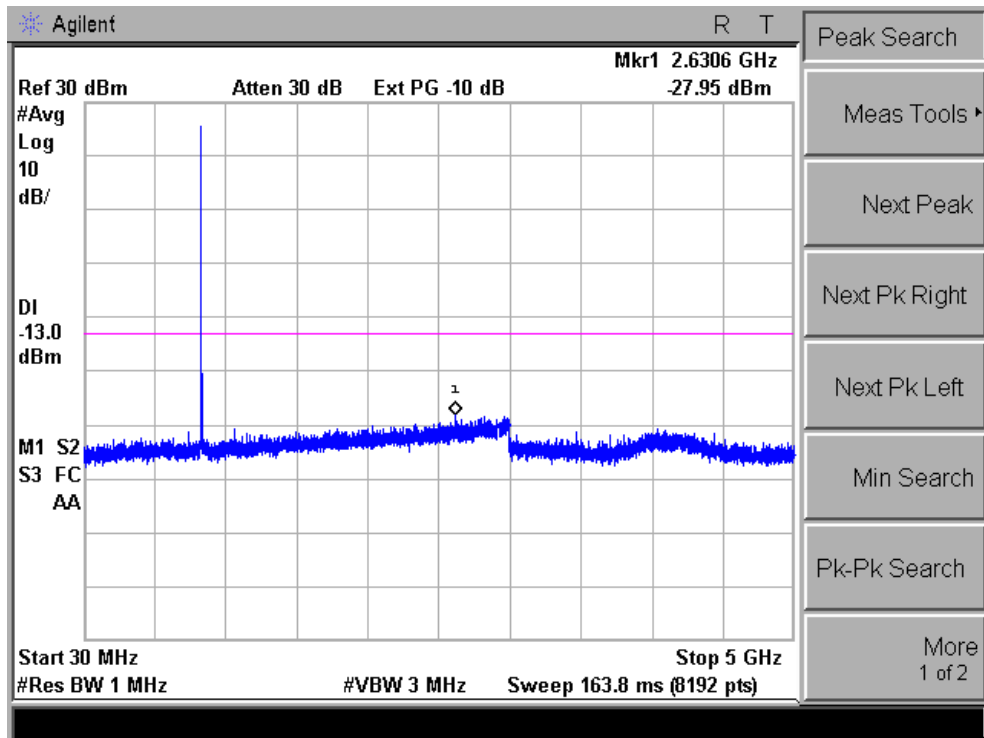

Conducted Emission Transmitting Mode CH 251 5GHz – 10GHz

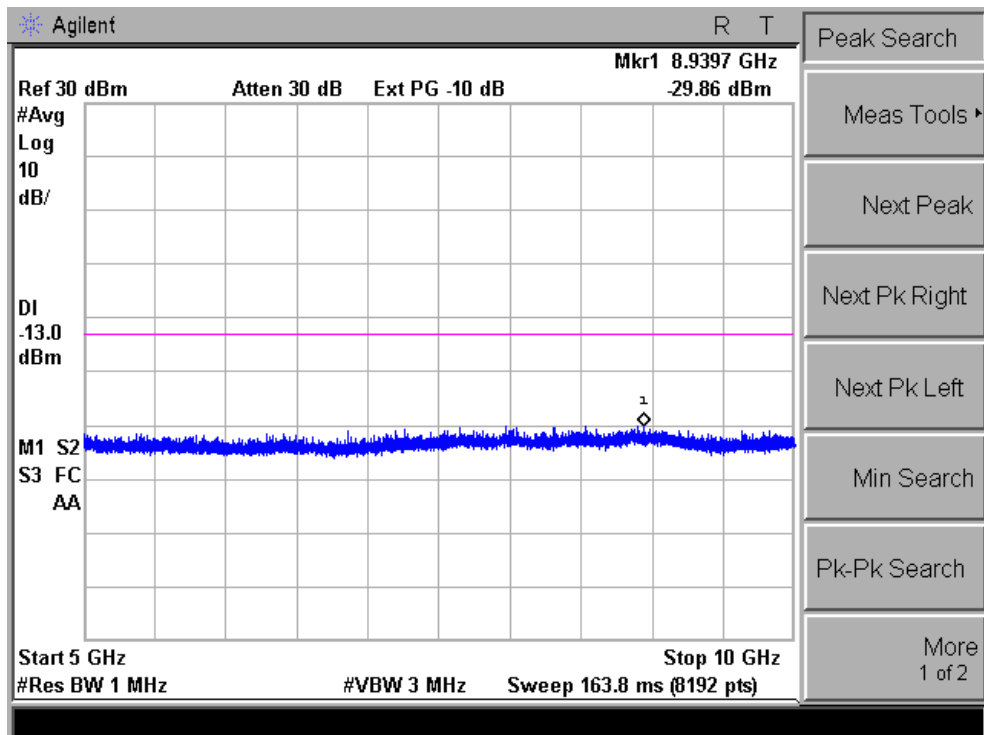

Conducted Emission Transmitting Mode CH 512 30MHz – 10GHz

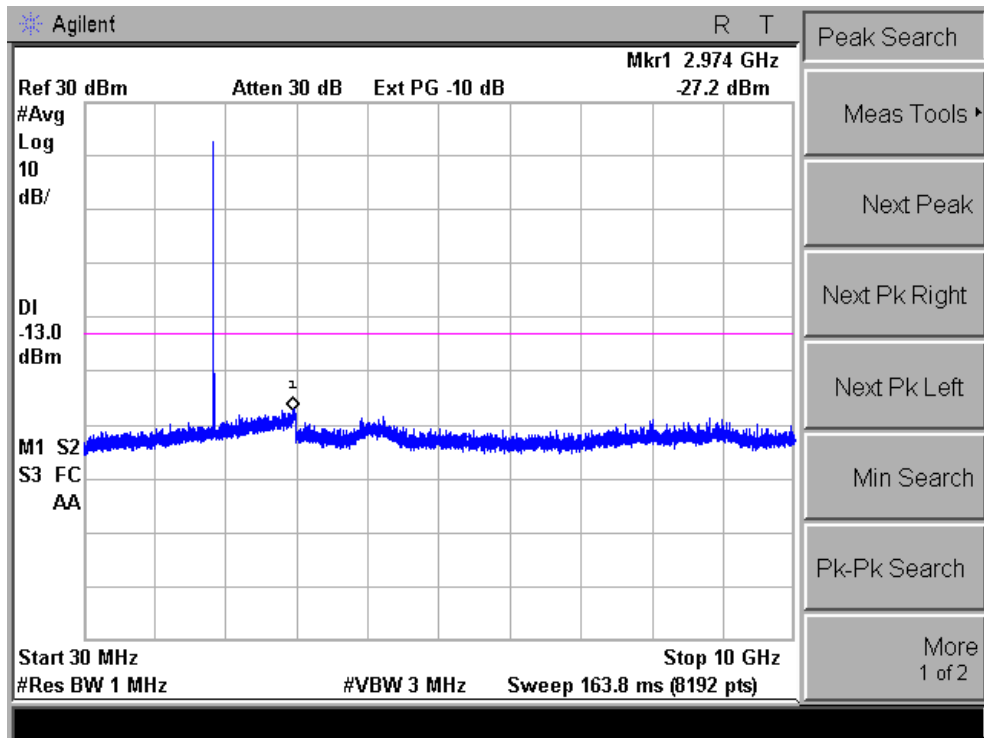

Conducted Emission Transmitting Mode CH 512 10GHz – 20GHz

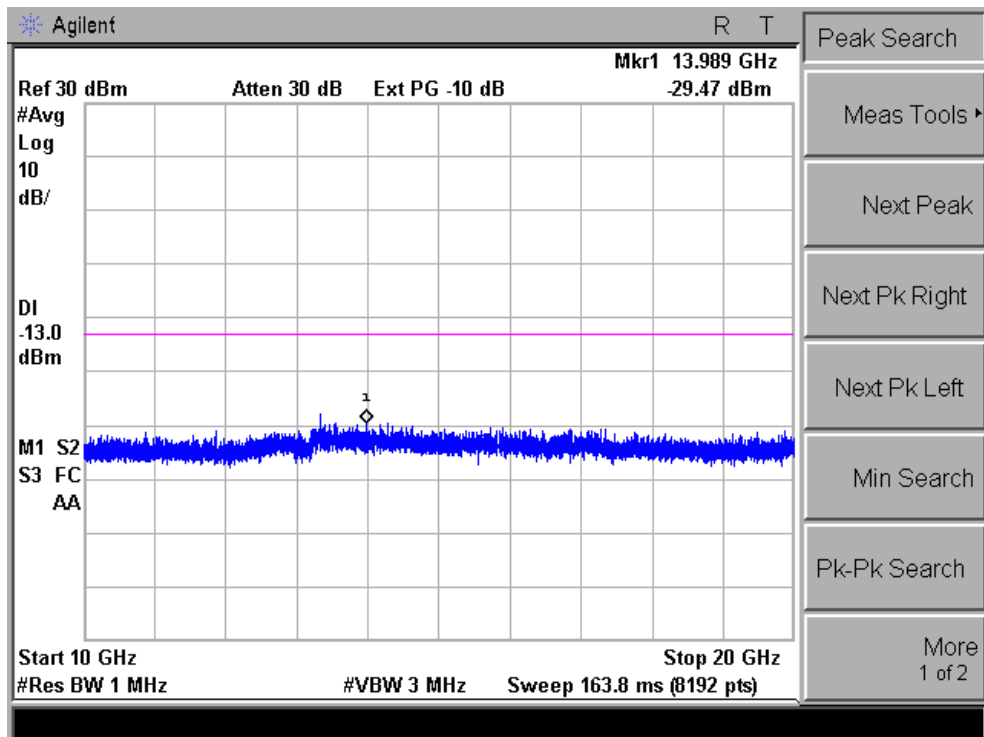

Conducted Emission Transmitting Mode CH 661 30MHz – 10GHz

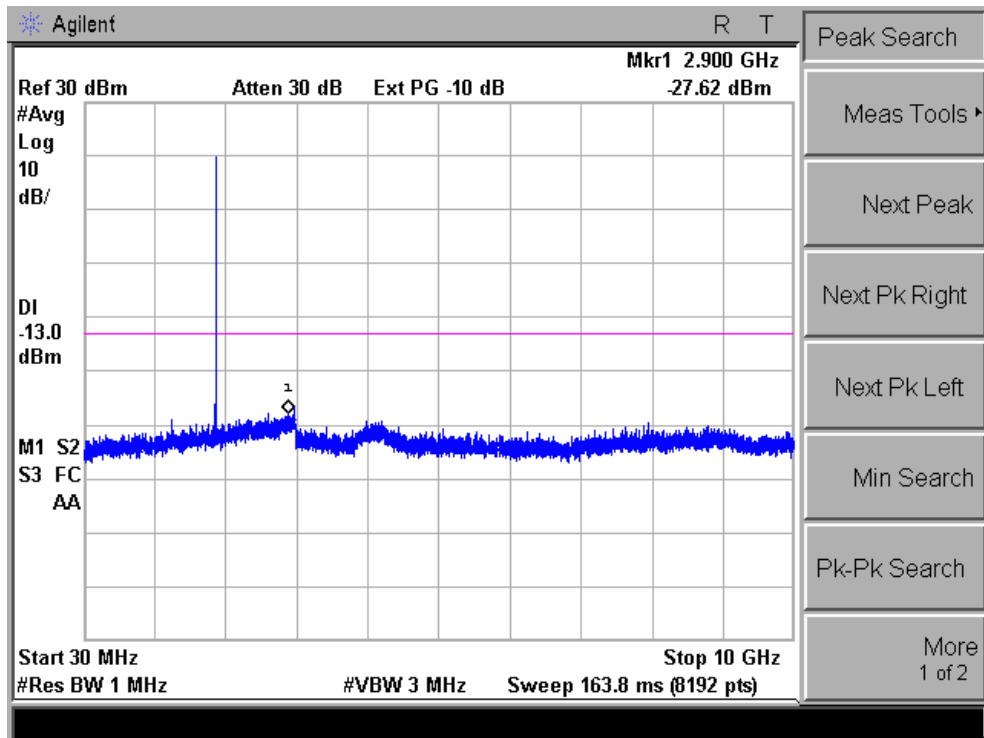

Conducted Emission Transmitting Mode CH 661 10GHz – 20GHz

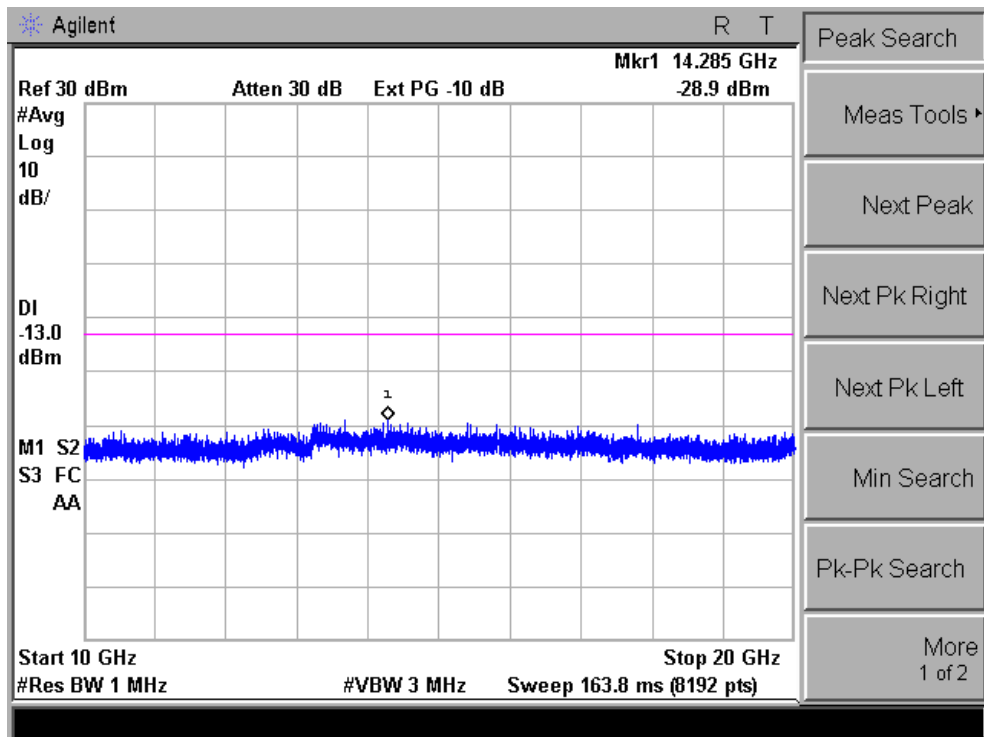

Conducted Emission Transmitting Mode CH 810 30MHz – 10GHz

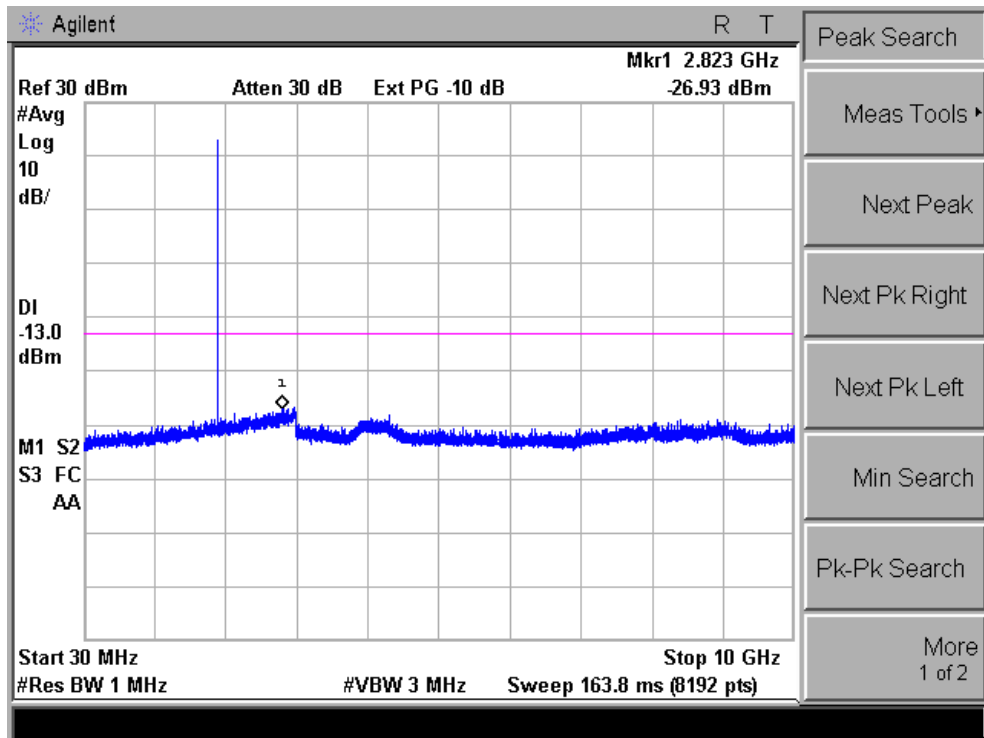

Conducted Emission Transmitting Mode CH 810 10GHz – 20GHz

