

---

# FCC Test Report

---

<b>Report No:</b> WD-RF-R-210294-D0
-------------------------------------

**Product Name** : Furbo dog camera  
**Model Name** : Furbo3  
**FCC ID** : 2AIBVTFFBV4  
**Applicant** : Tomofun Co., Ltd.  
**Received Date** : Mar. 04, 2021  
**Tested Date** : Sep. 09, 2021 ~ Oct. 18, 2021  
**Applicable Standard** : 47 CFR FCC Part 15, Subpart C (Section 15.247)  
KDB 558074 D01 DTS Meas. Guidance v05  
ANSI C63.10 : 2013



**Wendell Industrial Co., Ltd**  
**Wendell EMC & RF Laboratory**

**Caution:**

This report sets forth our findings solely with respect to the test samples identified herein. The results set forth in this report are not indicative or representative of the quality or characteristics of the lot from which a test sample was taken or any similar or identical product unless specifically and expressly noted.

The test results shown in the test report are traceable to the national/international standard through the calibration report of the equipment.

Please note that the measurement uncertainty are provided for informational purpose only and are not used in determining the Pass/Fail results.

This report must not be used to claim product endorsement by TAF or any agency of the government.

The test report shall not be reproduced without the written approval of Wendell Industrial Co., Ltd..

# Test Report

Issued Date: October 18, 2021

Project No.: 21Q030403

<b>Product Name</b>	Furbo dog camera
<b>Trade Name</b>	Furbo
<b>Model Name</b>	Furbo3
<b>FCC ID</b>	2AIBVTFFBV4
<b>Applicant</b>	Tomofun Co., Ltd.
<b>Manufacturer</b>	Tomofun Co., Ltd.
<b>EUT Rated Voltage</b>	AC 100 ~ 240V / 50 or 60Hz
<b>EUT Test Voltage</b>	AC 120V / 60Hz
<b>EUT Supports Radios Application</b>	WLAN 802.11b/g WLAN 802.11n (HT20) Bluetooth LE
<b>Applicable Standard</b>	47 CFR FCC Part 15, Subpart C (Section 15.247) KDB 558074 D01 DTS Meas. Guidance v05 ANSI C63.10 : 2013
<b>Output Power</b>	6.32 dBm
<b>Test Result</b>	Complied

Documented :



( Specialist / Emma Lu )

Technical Engineer :



( Deputy Section Manager / Jack Chang )

Approved :

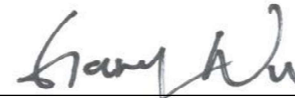

( Project Manager / Gary Wu )

## Table of Contents

<b>Document Revision History</b> .....	<b>5</b>
<b>Summary of Test Result</b> .....	<b>6</b>
<b>1 Generation Information</b> .....	<b>7</b>
<b>1.1 Applicant</b> .....	<b>7</b>
<b>1.2 Manufacturer</b> .....	<b>7</b>
<b>1.3 Description of Equipment under Test</b> .....	<b>7</b>
<b>1.4 Test Mode Applicability And Tested Channel Detail</b> .....	<b>10</b>
<b>1.5 Configuration of Tested System</b> .....	<b>12</b>
<b>1.6 EUT Exercise Software</b> .....	<b>12</b>
<b>1.7 Tested System Details</b> .....	<b>13</b>
<b>1.8 Test Facility</b> .....	<b>14</b>
<b>1.9 Measurement Uncertainty</b> .....	<b>15</b>
<b>1.10 List of Test Equipment</b> .....	<b>16</b>
<b>2 Test Result</b> .....	<b>19</b>
<b>2.1 Antenna Requirement</b> .....	<b>19</b>
2.1.1 Applicable Standard .....	19
2.1.2 Antenna Connected Construction .....	19
2.1.3 Antenna Gain .....	19
<b>2.2 Peak Output Power Measurement</b> .....	<b>20</b>
2.2.1 Limit .....	20
2.2.2 Test Setup .....	20
2.2.3 Test Procedure .....	20
2.2.4 Test Result .....	20
<b>2.3 6dB Bandwidth Measurement</b> .....	<b>21</b>
2.3.1 Limit .....	21
2.3.2 Test Setup .....	21
2.3.3 Test Procedure .....	21
2.3.4 Test Result .....	22
<b>2.4 Power Spectral Density Measurement</b> .....	<b>23</b>
2.4.1 Limit .....	23
2.4.2 Test Setup .....	23
2.4.3 Test Procedure .....	23
2.4.4 Test Result .....	24
<b>2.5 Conducted Band Edges and Spurious Emission Measurement</b> .....	<b>25</b>
2.5.1 Limit .....	25
2.5.2 Test Setup .....	25
2.5.3 Test Procedure .....	25
2.5.4 Test Result .....	26
<b>2.6 Radiated Band Edges and Spurious Emission Measurement</b> .....	<b>29</b>
2.6.1 Limit .....	29
2.6.2 Test Setup .....	30
2.6.3 Test Procedure .....	31
2.6.4 Duty Cycle .....	32
2.6.5 Test Result of Radiated Band Edge Measurement .....	32
2.6.6 Test Result of Radiated Spurious Emission Measurement .....	37
<b>2.7 AC Conducted Emissions Measurement</b> .....	<b>46</b>
2.7.1 Limit .....	46

2.7.2 Test Setup..... 46  
2.7.3 Test Procedure..... 47  
2.7.4 Test Result ..... 48

**Attachment 1: EUT Test Photographs**

**Attachment 2: EUT Detailed Photographs**

## Document Revision History

Report No.	Issue date	Description
WD-RF-R-210294-D0	October 18, 2021	Initial report

## Summary of Test Result

Ref. Std. Clause	Test Items	Result
15.203 15.247(C)	Antenna Requirement	Pass
15.247(b)	Peak Output Power	Pass
15.247(a)(2)	6dB Bandwidth	Pass
15.247(e)	Power Spectral Density	Pass
15.247(d)	Conducted Band Edges and Conducted Spurious Emission	Pass
15.247(d)	Radiated Band Edges and Radiated Spurious Emission	Pass
15.207	AC Conducted Emission	Pass

# 1 Generation Information

## 1.1 Applicant

Tomofun Co., Ltd.  
 4F., No. 178, Sec.3, Minquan E. Rd., Songshan Dist., Taipei City 10542, Taiwan(R.O.C.)

## 1.2 Manufacturer

Tomofun Co., Ltd.  
 4F., No. 178, Sec.3, Minquan E. Rd., Songshan Dist., Taipei City 10542, Taiwan(R.O.C.)

## 1.3 Description of Equipment under Test

<b>Product Name</b>	Furbo dog camera
<b>Model No.</b>	Furbo3
<b>FCC ID</b>	2AIBVTFFBV4
<b>Frequency Range</b>	2402 ~ 2480 MHz
<b>Number of Channels</b>	40CH
<b>Channel separation</b>	2 MHz
<b>Type of Modulation</b>	GFSK(1 Mbps)
<b>Antenna Information</b>	Refer to the table "Antenna List"
<b>EUT Supports Radios Application</b>	WLAN 802.11b/g WLAN 802.11n (HT20) Bluetooth LE
<b>EUT Rated Voltage</b>	AC 100 ~ 240V / 50 or 60Hz
<b>EUT Test Voltage</b>	AC 120V / 60Hz

The EUT uses following adapter.

<b>Trade Name</b>	DEE VAN ENTERPRISE CO., LTD.
<b>Model No.</b>	DSA-10PF06-05 FUS 052200
<b>Input Power</b>	100-240V~50/60Hz 0.3A
<b>Output Power</b>	+5.2V/2.0A, 10.4W
<b>Power Line</b>	Non-shielded, Non-Core, 1.8m

**Antenna List**

No.	Manufacturer	Model No.	Antenna Type	Peak Gain
1	ARiSTOTLE	RFA-02-JP331-70128V2	FPCB Antenna	3.12 dBi for 2.4GHz

Remark: The antenna of EUT is conforming to FCC 15.203

**Channel List**

Channel	Frequency (MHz)	Channel	Frequency (MHz)	Channel	Frequency (MHz)	Channel	Frequency (MHz)
00	2402	10	2422	20	2442	30	2462
01	2404	11	2424	21	2444	31	2464
02	2406	12	2426	22	2446	32	2466
03	2408	13	2428	23	2448	33	2468
04	2410	14	2430	24	2450	34	2470
05	2412	15	2432	25	2452	35	2472
06	2414	16	2434	26	2454	36	2474
07	2416	17	2436	27	2456	37	2476
08	2418	18	2438	28	2458	38	2478
09	2420	19	2440	29	2460	39	2480

**Test Frequencies in each operating band**

Frequency range over which the device operates in each operating band (Note 1)	Number of test frequencies required	Location of test frequencies inside the operating frequency range (Note 1,2)
$\leq 1$ MHz	1	near centre
$> 1$ MHz and $\leq 10$ MHz	2	1 near high end, 1 near low end
$> 10$ MHz	3	1 near high end, 1 near centre, and 1 near low end

**Note 1:** The frequency range over which the device operates in a given operating band is the difference between the highest and lowest frequencies on which the device can be tuned within that given operating band. The frequency range can be smaller than or equal to the operating band, but cannot be greater than the operating band.

**Note 2:** In the third column of table 1, “near” means as close as possible to or at the centre / low end / high end of the frequency range over which the device operates.



**Firmware / Software Version**

1	<b>Product Name</b>	Furbo dog camera
2	<b>Model No.</b>	Furbo3
3	<b>Test SW Version</b>	PUTTY_Ver.0.63.0.0
4	<b>RF power setting in TEST SW</b>	<input checked="" type="checkbox"/> RF power setting was not able to alter during testing. <input type="checkbox"/> RF power setting was able to alter during testing. (See the following table)

**Parameters of test software setting**

Type of Modulation	Channel	Frequency (MHz)	Set Value
GFSK(1Mbps)	00	2402	Default
	19	2440	Default
	39	2480	Default

## 1.4 Test Mode Applicability And Tested Channel Detail

1. This device is a Furbo dog camera with a built-in Wi-Fi and Bluetooth transceiver.
2. These tests were performed on a sample of equipment to demonstrate compliance with 47 CFR FCC Part 15, Subpart C (Section 15.247).
3. Pre-Scan has been conducted to determine the worst-case mode from all possible combinations between available modulations, data rates, XYZ axis and antenna ports.
4. The worst case was found when positioned on X axis for radiated emission. Following test modes were selected for the final test, and the final worst case is recorded in the report:

EUT Configure Mode	RE < 1G	RE ≥ 1G	ACM	ACP	Description
--	<input checked="" type="checkbox"/>	<input checked="" type="checkbox"/>	<input checked="" type="checkbox"/>	<input type="checkbox"/>	Transmit BLE
--	<input type="checkbox"/>	<input type="checkbox"/>	<input type="checkbox"/>	<input checked="" type="checkbox"/>	Normal Link

**Note :** RE<1G: Radiated Emission below 1GHz      RE≥1G: Radiated Emission above 1GHz  
 ACM: Antenna Port Conducted Measurement      ACP: AC Power Line Conducted Emission

Following channel(s) was (were) selected for the final test as listed below:

### Radiated Spurious Emission Measurement(Below 1GHz):

EUT Configure Mode	Mode	Available Channel	Tested Channel	Modulation Type	Data Rate (Mbps)
--	BLE	0 ~ 39	19	GFSK	1

### Radiated Spurious Emission Measurement(Above 1GHz):

EUT Configure Mode	Mode	Available Channel	Tested Channel	Modulation Type	Data Rate (Mbps)
--	BLE	0 ~ 39	0, 19, 39	GFSK	1

### Radiated Band Edge Emission Measurement(Above 1GHz):

EUT Configure Mode	Mode	Available Channel	Tested Channel	Modulation Type	Data Rate (Mbps)
--	BLE	0 ~ 39	0, 39	GFSK	1

### Peak Output Power, 6dB Bandwidth, Power Spectral Density, Conducted Spurious Emission:

EUT Configure Mode	Mode	Available Channel	Tested Channel	Modulation Type	Data Rate (Mbps)
--	BLE	0 ~ 39	0, 19, 39	GFSK	1

**Conducted Band Edges:**

<b>EUT Configure Mode</b>	<b>Mode</b>	<b>Available Channel</b>	<b>Tested Channel</b>	<b>Modulation Type</b>	<b>Data Rate (Mbps)</b>
--	BLE	0 ~ 39	0, 39	GFSK	1

**AC Conducted Emission:**

<b>EUT Configure Mode</b>	<b>Mode</b>	<b>Available Channel</b>	<b>Tested Channel</b>	<b>Modulation Type</b>	<b>Data Rate (Mbps)</b>
--	BLE	0 ~ 39	19	GFSK	1

### 1.5 Configuration of Tested System

Radiation

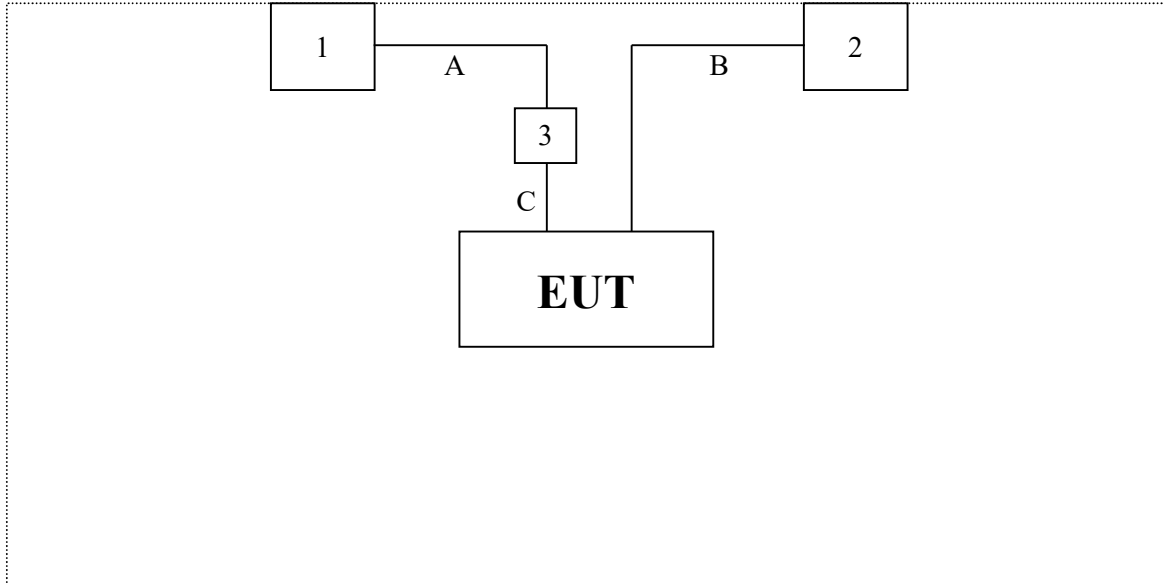

Test Table

AC Conduction

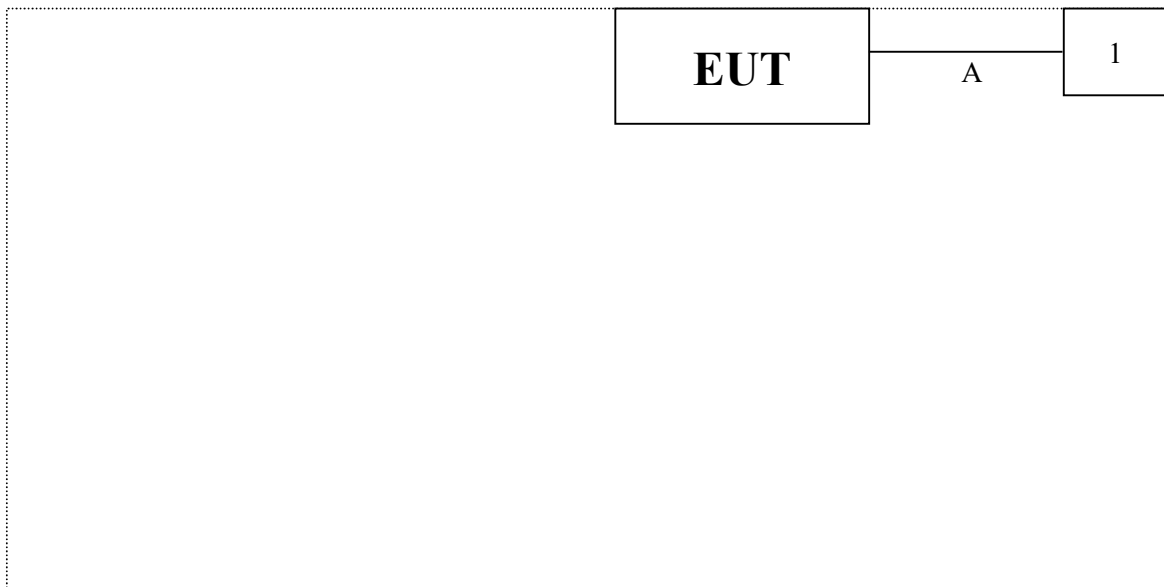

Test Table

### 1.6 EUT Exercise Software

1. Setup the EUT as shown in Section 1.5
2. Execute software “PUTTY\_Ver.0.63.0.0”.
3. Configure the test mode, the test channel, and the data rate.
4. Press “OK” to start the continuous transmit.
5. Verify that the EUT works properly.

## 1.7 Tested System Details

The types for all equipment, plus descriptions of all cables used in the tested system (including inserted cards) are:

No.	Product	Manufacturer	Model No.	Serial No.	Power Cord
1	Notebook PC	acer	N17W3	NXVJ7TA00302301D496600	Non-shielded, 1 Core, 1.6m
2	Adapter	DEE VAN ENTERPRISE CO., LTD.	DSA-10PF06-05 FUS 052200	N/A	N/A
3	Fixture	VIVOTEK INC.	Test Fixture	N/A	N/A
A	USB to RS232	DIGITUS	DA-70166	N/A	Shielded, No Core, 0.8m
B	USB Cable	ACES	60-6388-220-FA	N/A	Non-shielded, No Core, 1.8m
C	Data Cable	JOIN TEK CORPORATION	XD4P220	N/A	Non-shielded, No Core, 0.2m

## 1.8 Test Facility

Items	Required (IEC 60068-1)	Actual
Temperature (°C)	15-35	20~25
Humidity (% RH)	25-75	45~55
Barometric pressure (mbar)	860-1060	990~1020

**Description:** Accredited by TAF  
Accredited Number: 2965

**Issued by:** Wendell Industrial Co., Ltd

**Lab Address:** 6F/6F-1, No.188, Baoqiao Rd., Xindian Dist.,  
New Taipei City 23145, Taiwan R.O.C

**Test Lab:** Wendell EMC & RF Laboratory

**Test Location:** No. 119, Wugong 3rd Rd., Wugu Dist.,  
New Taipei City 248, Taiwan (R.O.C.)

**Designation Number:** TW0025

**Test Firm Registration Number:** 665221

## 1.9 Measurement Uncertainty

ISO/IEC 17025 requires that an estimate of the measurement uncertainties associated with the emissions test results be included in the report. The measurement uncertainties given below are based on a 95% confidence (level based on a coverage factor K=2)

Measurement Project	Condition	Expended Uncertainty
AC Conducted Emission	0.150 ~ 30 MHz	2.64 dB
Radiated Emission	0.009 ~ 30 MHz	± 4.2 dB
	30 ~ 1000 MHz	± 3.9 dB
	1000 ~ 18000 MHz	± 4.1 dB
	18000 ~ 40000 MHz	± 3.9 dB
RF Power, Conducted	Conducted Measuring	± 0.5 dB
Occupied Bandwidth	Conducted Measuring	± 2.4 %
Power Density	Conducted Measuring	± 1.7 dB
Duty Cycle and Dwell Time	Conducted Measuring	± 1.3 %
Conducted Unwanted Emission Strength	Conducted Measuring	± 1.8 dB
DC Power Supply	--	± 3.2 %
Temperature	--	± 1.1 °C
Humidity	--	± 3.4 %

**Note:** Please note that the measurement uncertainty are provided for informational purpose only and are not used in determining the Pass/Fail results.

## 1.10 List of Test Equipment

### For Conducted measurements / W08-Conducted Measurement

Equipment	Manufacturer	Model No.	Serial No.	Cal. Date	Due Date
✓ Spectrum analyzer	Keysight	N9010A	SG50420005	2021/08/09	2022/08/08
✓ Wideband Peak Power Meter	Anritsu	ML2495A	1733007	2021/09/07	2022/09/06
✓ Pulse Power Sensor + Precision Adaptor	Anritsu	MA2411B	1726022	2021/09/07	2022/09/06
Temperature Chamber	TAICHY	MHK-225LK	1061121	2021/4/27	2022/4/26
Wireless Connectivity Tester	R&S	CMW270	101307	2021/5/24	2022/5/23
✓ Attenuator	MVE	MVE2211-10	CT-9-056	2021/08/18	2022/08/17
Attenuator	MVE	MVE2211-20	CT-9-057	2021/08/18	2022/08/17
Attenuator	MVE	MVE2211-30	CT-9-058	2021/08/18	2022/08/17
Power Divider	MVE	MVE8546	170826003	2021/08/18	2022/08/17
Power Splitter	MVE	MVE8547	170302047	2021/08/18	2022/08/17
DC Power Supply	GW INSTEK	GPC-3060D	GER817636	2021/08/19	2022/08/18

Remark:

1. All equipments are calibrated every one year.
2. The test instruments marked with “✓” are used to measure the final test results.



**For AC Conduction measurements / W08-CE**

	Equipment	Manufacturer	Model No.	Serial No.	Cal. Date	Due Date
✓	EMI Test Receiver	R&S	ESR3	102309	2021/6/8	2022/6/7
✓	2-Line V-Network LISN	R&S	ENV216	101185	2021/6/11	2022/6/10
✓	LISN	SCHWARZBECK	NSLK 8127RC	05028	2021/6/11	2022/6/10
✓	Transient Limiter	EM Electronics Corporation	EM-7600	857	2021/6/10	2022/6/9
✓	50ohm Cable	EMCI	EMCCFD300-BM-BM-5000	170612	2021/6/10	2022/6/9
✓	50 ohm terminal impedance	HUBER+SUHNER	50 ohm terminal impedance	CT-1-109-1	2021/6/11	2022/6/10

## Remark:

1. All equipments are calibrated every one year.
2. The test instruments marked with “✓” are used to measure the final test results.
3. Test Software version: FARAD EZ-EMC Ver.EMC-CON 3A1

**For Radiated measurements / W08-996-2**

Equipment	Manufacturer	Model No.	Serial No.	Cal. Date	Due Date
✓ EMI Receiver	Keysight	N9038A	MY51210173	2021/08/20	2022/08/19
✓ Spectrum Analyzer	Keysight	N9010A	MY52220228	2021/08/24	2022/08/23
✓ Loop Antenna	EMCI	LPA600	277	2021/09/02	2022/09/01
✓ TRILOG super broad Antenna	Schwarzbeck	VULB 9168	VULB 9168-700 & 1421	2021/08/11	2022/08/10
✓ Horn Antenna	Schwarzbeck	BBHA 9120D	01767	2021/08/11	2022/08/10
✓ Horn Antenna	Schwarzbeck	BBHA 9170	703	2020/12/03	2021/12/02
✓ Pre-Amplifier	EM	EMC330	060774	2021/08/24	2022/08/23
✓ Pre-Amplifier	EMEC	EM01G18G	060648	2021/08/24	2022/08/23
✓ Pre-Amplifier	JPT	JPA0118-55-303K	1910001800055003	2021/08/25	2022/08/24
✓ Pre-Amplifier	EMCI	EMC184045SE	980515	2021/08/24	2022/08/23
✓ Cable	EMEC	EM-CB400	105060103	2021/08/24	2022/08/23
✓ Cable	EMEC	EM-CB400	105060102	2021/08/24	2022/08/23
✓ Cable	EMEC	EM-CB400	105060101	2021/08/24	2022/08/23
✓ RF Cable	HUBER+SUHNER	SF102	MY2752/2	2021/08/24	2022/08/23
✓ Cable	MVE	280280.LL266.1200	B60028C	2021/08/24	2022/08/23
✓ RF Cable	HUBER+SUHNER	SF102	MY2751/2	2021/08/24	2022/08/23
✓ Cable	EMCI	EMC102-KM-KM-600	190646	2021/08/24	2022/08/23
✓ RF Filter	EMEC	BRF-2400-2500	002	2021/08/26	2022/08/25
RF Filter	EMEC	BRF-5150-5350	104	2021/08/26	2022/08/25
RF Filter	EMEC	BRF-5470-5725	092	2021/08/26	2022/08/25
RF Filter	EMEC	BRF-5725-5875	091	2021/08/26	2022/08/25
✓ RF Filter	EMEC	HPF-2800	002	2021/08/26	2022/08/25
RF Filter	EMEC	HPF-5850	059	2021/08/26	2022/08/25
SMA Notch Filter	MVE	MFN-902.928.S1	190604001	2021/09/02	2022/09/01

**Remark:**

1. All equipments are calibrated every one year.
2. The test instruments marked with "✓" are used to measure the final test results.
3. Test Software version: FARAD EZ-EMC Ver.WD-03A1-1

## 2 Test Result

### 2.1 Antenna Requirement

#### 2.1.1 Applicable Standard

An intentional radiator shall be designed to ensure that no antenna other than that furnished by the responsible party shall be used with the device. The use of a permanently attached antenna or of an antenna that uses a unique coupling to the intentional radiator shall be considered sufficient to comply with the provisions of this section. The manufacturer may design the unit so that a broken antenna can be replaced by the user, but the use of a standard antenna jack or electrical connector is prohibited.

An intentional radiator shall be designed to ensure that no antenna other than as furnished by the responsible party shall be used with the device. If transmitting antennas of directional gain greater than 6dBi are using the power shall be reduced by the amount in dB that the directional gain of the antenna exceeds 6 dBi, for compliance to FCC 47CFR 15.247 (c) requirements.

#### 2.1.2 Antenna Connected Construction

Non-standard antenna connector is used.

#### 2.1.3 Antenna Gain

No.	Manufacturer	Model No.	Antenna Type	Peak Gain
1	ARiSTOTLE	RFA-02-JP331-70128V2	FPCB Antenna	3.12 dBi for 2.4GHz

## 2.2 Peak Output Power Measurement

### 2.2.1 Limit

For systems using digital modulation in the 2400-2483.5MHz, the limit for peak output power is 1W. If transmitting antenna of directional gain greater than 6dBi is used, the peak output power from the intentional radiator shall be reduced below the above stated value by the amount in dB that the directional gain of the antenna exceeds 6 dBi. In case of point-to-point operation, the limit has to be reduced by 1dB for every 3dB that the directional gain of the antenna exceeds 6dBi.

### 2.2.2 Test Setup

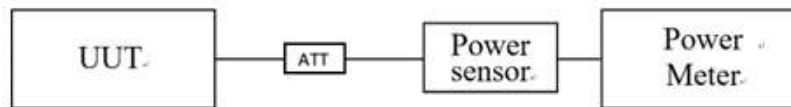

### 2.2.3 Test Procedure

1. Enable the EUT transmit continuously.
2. Let EUT be connected to the power meter, and record the max. reading.
3. Measurement using a gated RF average power meter, since this measurement is made only during the ON time of the transmitter, no duty cycle correction is required.

### 2.2.4 Test Result

Protocol	Channel	Frequency (MHz)	Peak Power (dBm)	Limit (dBm)	Result
BLE	00	2402	6.27	≤ 30	Pass
	19	2440	6.32	≤ 30	Pass
	39	2480	5.49	≤ 30	Pass

Remark:

1. Peak Power = Reading value on power meter + cable loss
2.  $10 \log(X/mW) = \text{dBm}$ ,  $X=1 \text{ watt (Limit)}$   
 $1 \text{ watt} = 30 \text{ dBm}$

## 2.3 6dB Bandwidth Measurement

### 2.3.1 Limit

The minimum 6 dB bandwidth shall be at least 500 kHz.

### 2.3.2 Test Setup

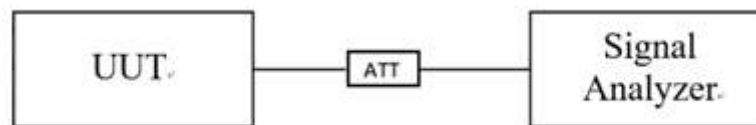

### 2.3.3 Test Procedure

1. Enable the EUT transmit continuously.
2. Spectrum analyzer set:
  - a) RBW = 100 kHz
  - b) VBW  $\geq$  3 RBW
  - c) Detector = peak
  - d) Sweep time = auto couple
  - e) Trace mode = max hold.

### 2.3.4 Test Result

Protocol	Channel	Frequency (MHz)	6dB BW (kHz)	Limit (kHz)	Result
BLE	00	2402	718.600	≥ 500	Pass
	19	2440	706.400		Pass
	39	2480	712.600		Pass

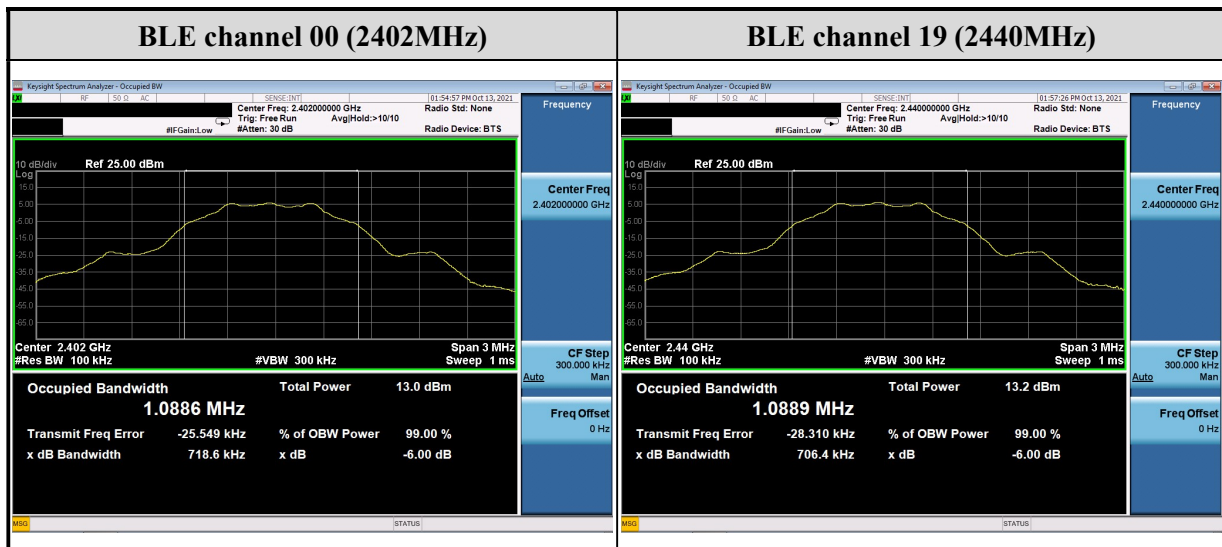

#### BLE channel 39 (2480MHz)



## 2.4 Power Spectral Density Measurement

### 2.4.1 Limit

The peak power spectral density shall not be greater than 8dBm in any 3kHz band at any time interval of continuous transmission.

### 2.4.2 Test Setup

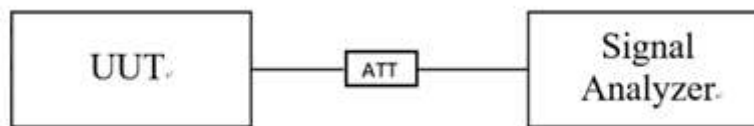

### 2.4.3 Test Procedure

1. Enable the EUT transmit continuously.
2. Spectrum analyzer set:
  - a) RBW = 3 kHz ~ 100 kHz
  - b) VBW  $\geq$  3 RBW
  - c) Span = 1.5 times DTS Channel 6dB Bandwidth
  - d) Detector = peak
  - e) Sweep time = auto couple
  - f) Trace mode = max hold.

### 2.4.4 Test Result

Protocol	Channel	Frequency (MHz)	PSD (dBm)	Limit (dBm)	Result
BLE	00	2402	-7.367	≤ 8	Pass
	19	2440	-7.186		Pass
	39	2480	-7.750		Pass

Remark: PSD = Reading value on spectrum analyzer + cable loss

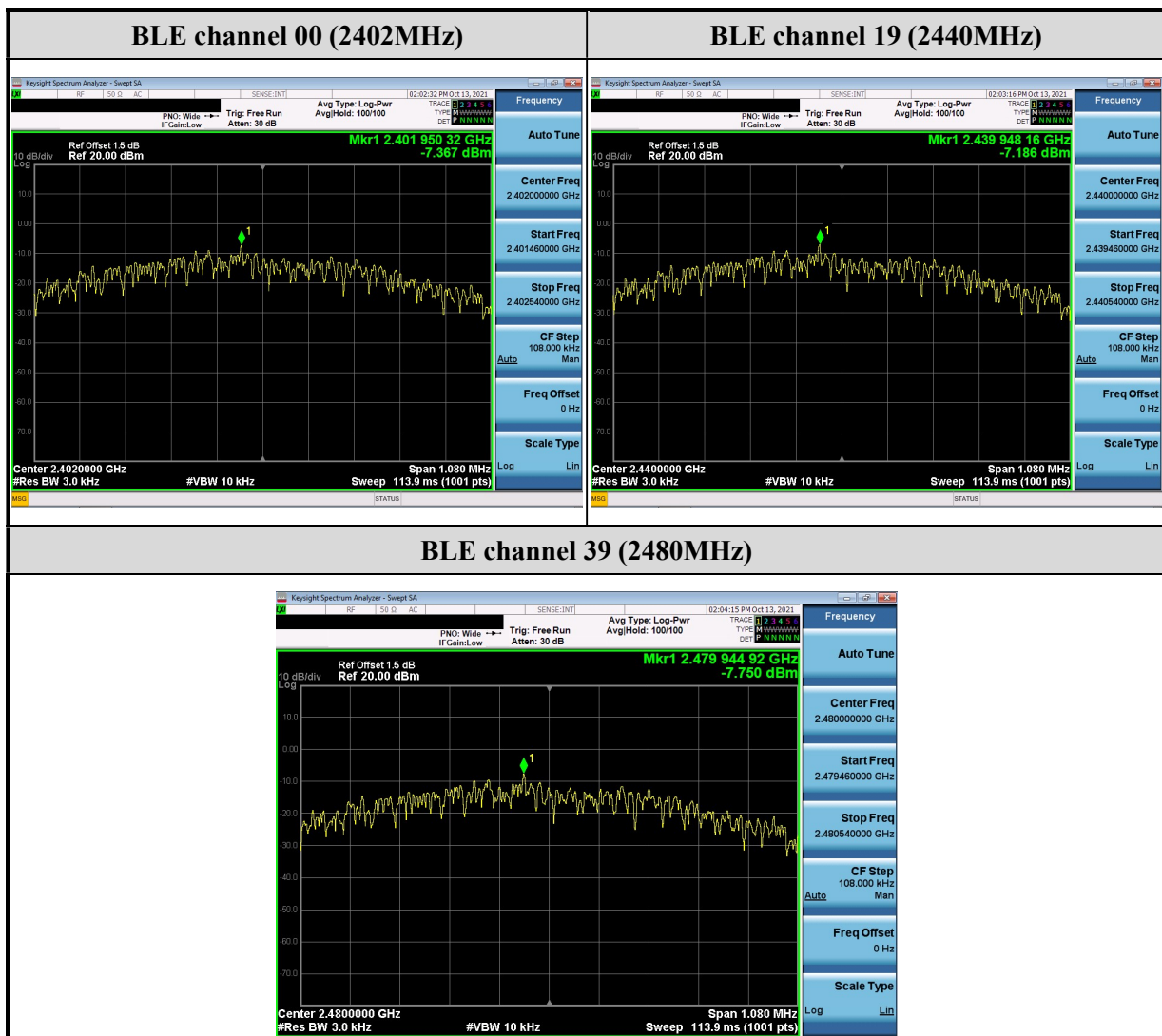



## 2.5 Conducted Band Edges and Spurious Emission Measurement

### 2.5.1 Limit

In any 100 KHz bandwidth outside the frequency bands in which the spread spectrum intentional radiator is operating, the radio frequency power that is produced by the intentional radiator shall be at least 20dB below that in the 100KHz bandwidth within the band that contains the highest level of the desired power, In addition, radiated emissions which fall in the restricted bands, as defined in must also comply with the radiated emission limits. If the transmitter complies with the conducted power limits based on the use of RMS averaging over a time interval, the attenuation required under this paragraph shall be 30 dB instead of 20 dB

### 2.5.2 Test Setup

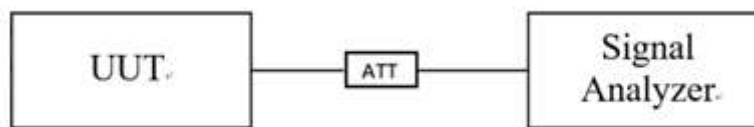

### 2.5.3 Test Procedure

1. Enable the EUT transmit continuously.
2. Spectrum analyzer set :
  - a) RBW = 100 kHz
  - b) VBW  $\geq$  3 RBW
  - c) Detector = peak
  - d) Sweep time = auto couple
  - e) Trace mode = max hold.

### 2.5.4 Test Result

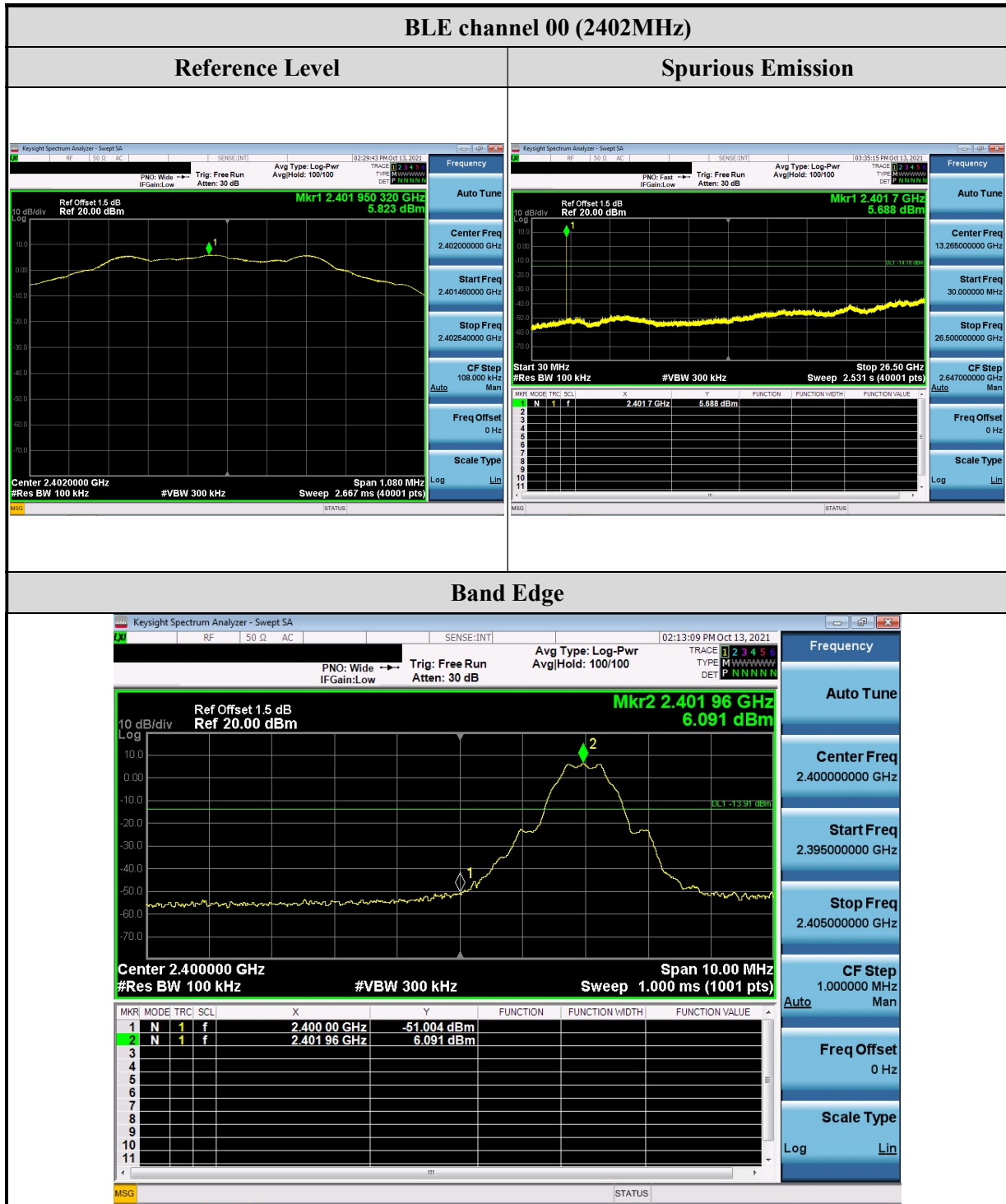

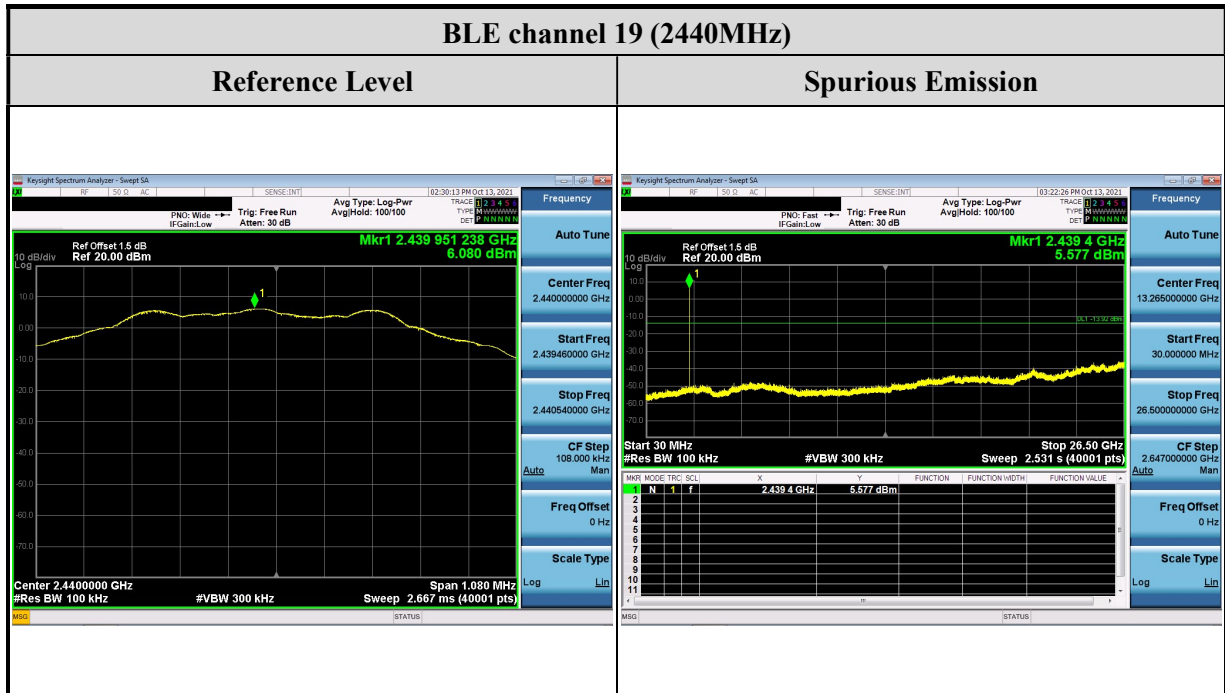

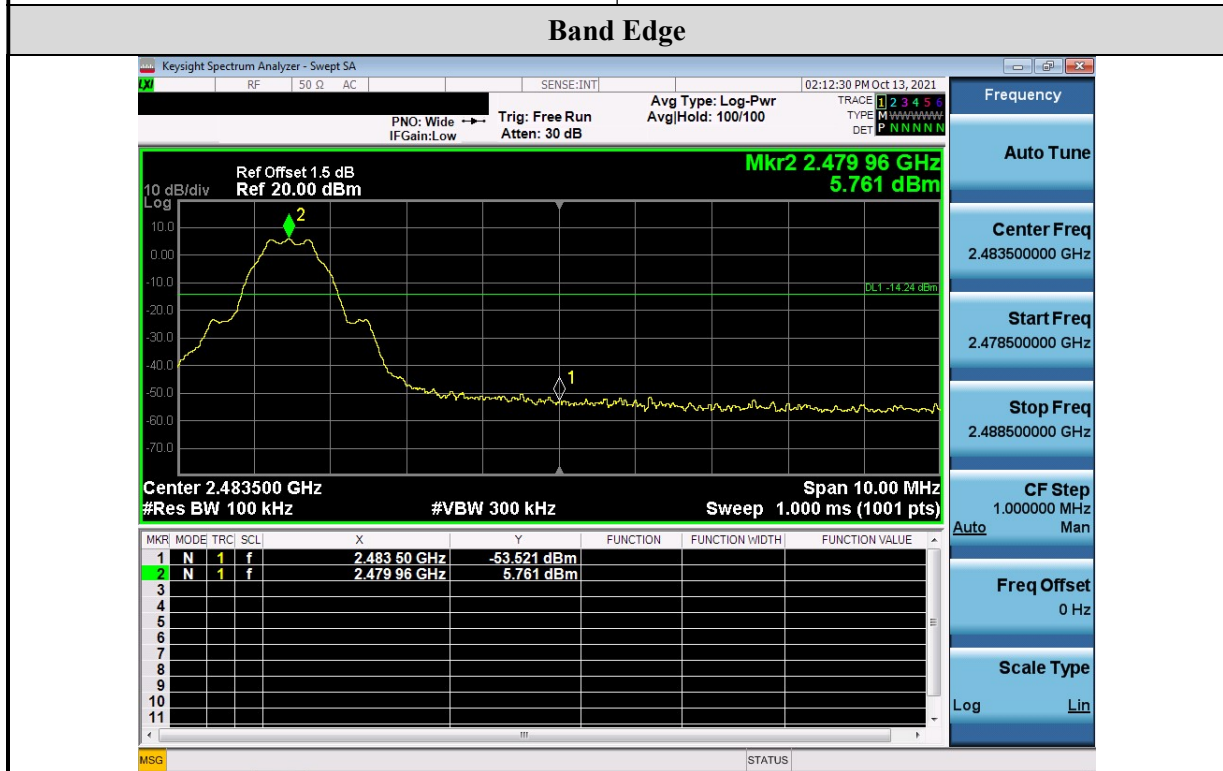
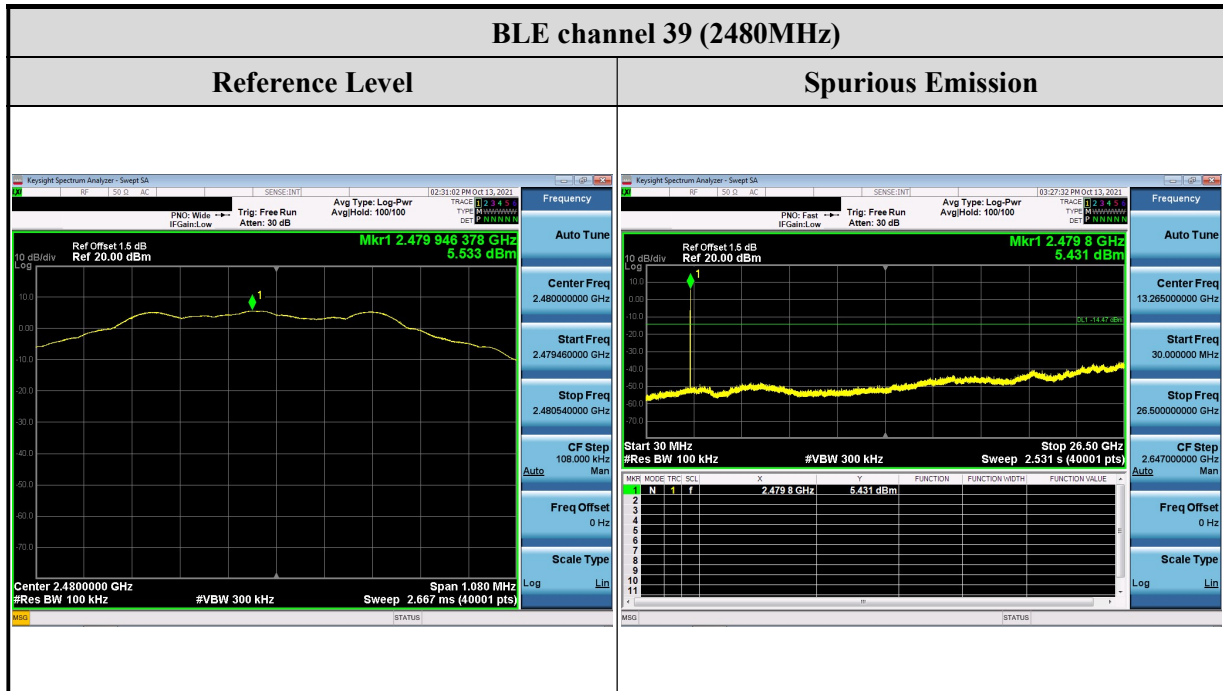

## 2.6 Radiated Band Edges and Spurious Emission Measurement

### 2.6.1 Limit

Frequency (MHz)	Field Strength ( $\mu\text{V/m}$ )	Measurement Distance (m)
0.009 – 0.490	2400/F(kHz)	300
0.490 – 1.705	24000/F(kHz)	30
1.705 – 30.0	30	30
30 – 88	100	3
88 – 216	150	3
216 - 960	200	3
Above 960	500	3

Remarks:

1. RF Voltage (dBuV) =  $20 \log \text{RF Voltage}(\mu\text{V})$
2. In the Above Table, the tighter limit applies at the band edges.
3. Distance refers to the distance in meters between the measuring instrument antenna and the closed point of any part of the device or system

## 2.6.2 Test Setup

### Below 30MHz

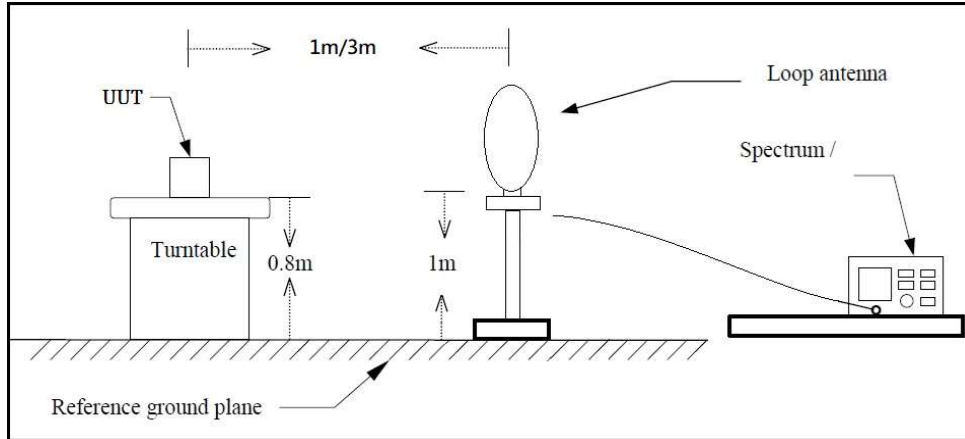

### 30MHz~1GHz

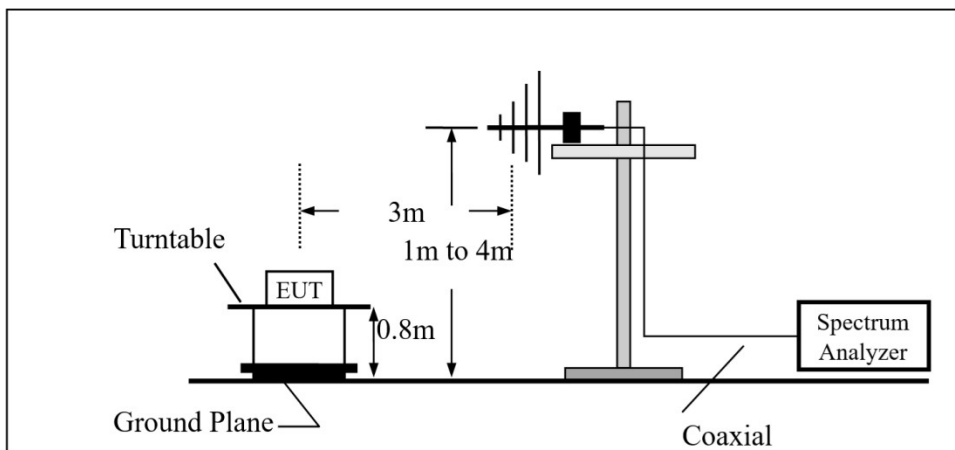

### Above 1GHz

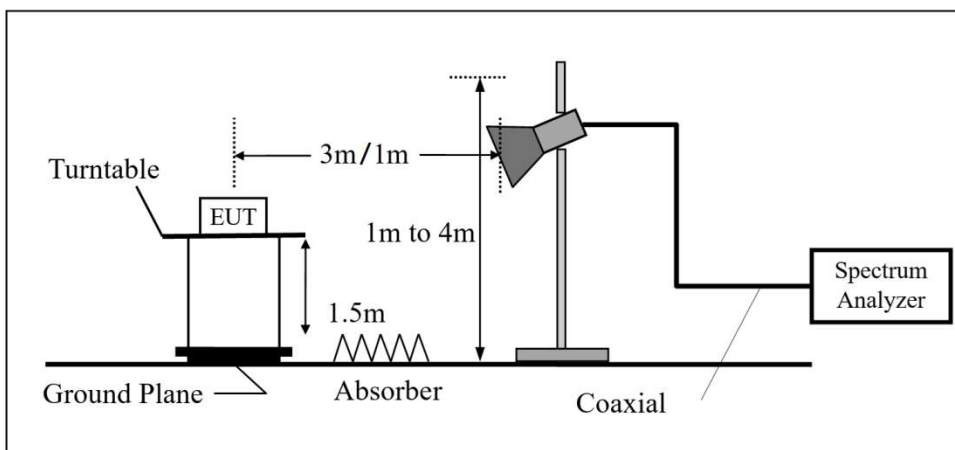

### 2.6.3 Test Procedure

The EUT was setup according to ANSI C63.10, 2013 and tested according test procedure of KDB 558074 for compliance to FCC 47CFR 15.247 requirements.

#### **For Radiated emission below 30MHz**

- (1) The EUT was placed on the top of a rotating table 0.8 meters above the ground in a 3 meter chamber room. The table was rotated 360 degrees to determine the position of the highest radiation.
- (2) The EUT was set 3 meters away from the interference-receiving antenna, which was mounted on the top of a variable-height antenna tower.
- (3) Parallel, perpendicular, and ground-parallel orientations of the antenna are set to make the measurement.
- (4) For each suspected emission, the EUT was arranged to its worst case and the rotatable table was turned from 0 degrees to 360 degrees to find the maximum reading.
- (5) The test-receiver system was set to Quasi-Peak Detect Function and Specified Bandwidth with Maximum Hold Mode.

#### **For Radiated emission Above 30MHz**

- (1) The EUT was placed on the top of a rotating table 0.8 meters (for below 1GHz) / 1.5 meters (for above 1GHz) above the ground at 3 meter chamber room for the test. The table was rotated 360 degrees to determine the position of the highest radiation.
- (2) The EUT was set 3 meters away from the interference-receiving antenna, the height of the antenna is varied from 1 meter to 4 meters above the ground to determine the maximum value of the field strength.
- (3) Parallel, perpendicular, and ground-parallel orientations of the antenna are set to make the measurement.
- (4) For each suspected emission, the EUT was arranged to its worst case and the rotatable table was turned from 0 degrees to 360 degrees to find the maximum reading.
- (5) The test-receiver system was set to quasi-peak detect function and specified bandwidth with maximum hold mode when the test frequency is below 1 GHz.
- (6) The test-receiver system was set to peak and average detect function and specified bandwidth with maximum hold mode when the test frequency is above 1 GHz. If the peak reading value also meets the average limit, measurement with the average detector is unnecessary.

### 2.6.4 Duty Cycle

Protocol	Frequency (MHz)	on time (ms)	on+off time (ms)	Duty cycle	Duty Factor (dB)	1/T Minimum VBW (kHz)
BLE	2402	0.435	0.620	0.702	1.539	2.299

### 2.6.5 Test Result of Radiated Band Edge Measurement

The following tables for radiated measurement, pre-scanned in three orthogonal panels, X, Y, Z. The worst cases (X axis) were recorded in this report.

Test Frequency	
RF	BLE
Tx	CH00 (2402MHz)
	CH39 (2480MHz)



<b>Test Mode :</b>	Transmit BLE	<b>Test Date :</b>	2021/10/11
<b>Test Channel :</b>	CH00(2402MHz)	<b>Temperature :</b>	24 °C
<b>Polarization :</b>	Horizontal	<b>Relative Humidity :</b>	49 %

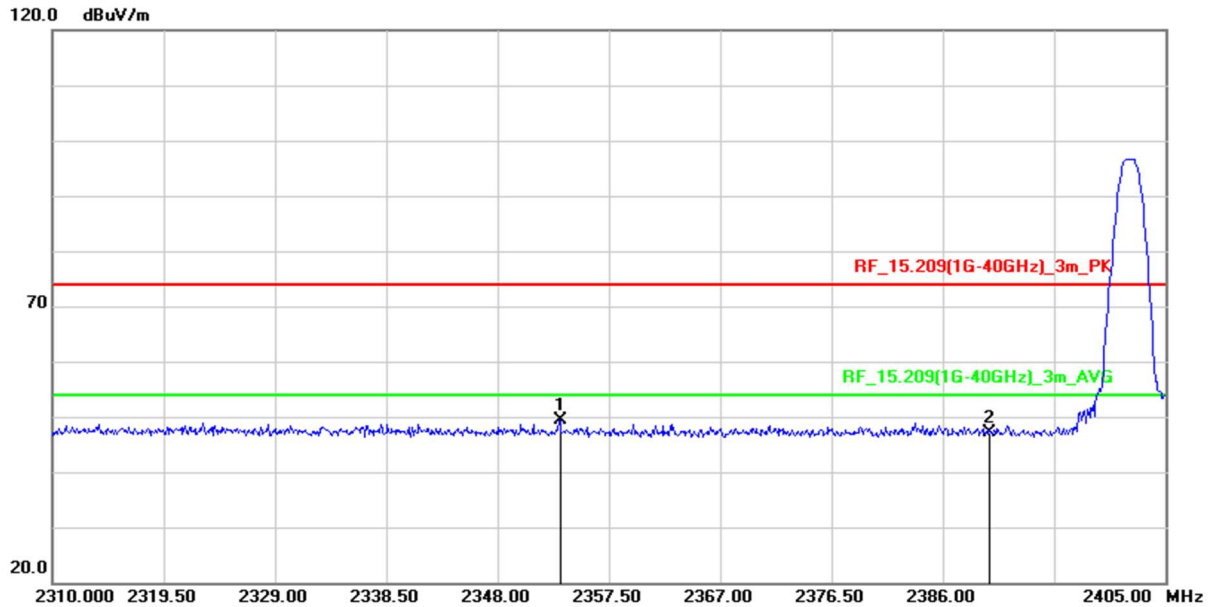

No.	Frequency (MHz)	Reading (dBuV/m)	Correct Factor (dB/m)	Result (dBuV/m)	Limit (dBuV/m)	Margin (dB)	Remark
1	2353.320	56.27	-6.77	49.50	74.00	-24.50	peak
2	2390.000	53.76	-6.69	47.07	74.00	-26.93	peak

**Remark :**

1. Correction Factor = Antenna factor + Cable loss – Amplifier gain
2. Result Value = Reading Level + Correct Factor
3. Margin Level = Result Value – Limit Value
4. The other emission levels were very low against the limit

<b>Test Mode :</b>	Transmit BLE	<b>Test Date :</b>	2021/10/11
<b>Test Channel :</b>	CH00(2402MHz)	<b>Temperature :</b>	24 °C
<b>Polarization :</b>	Vertical	<b>Relative Humidity :</b>	49 %

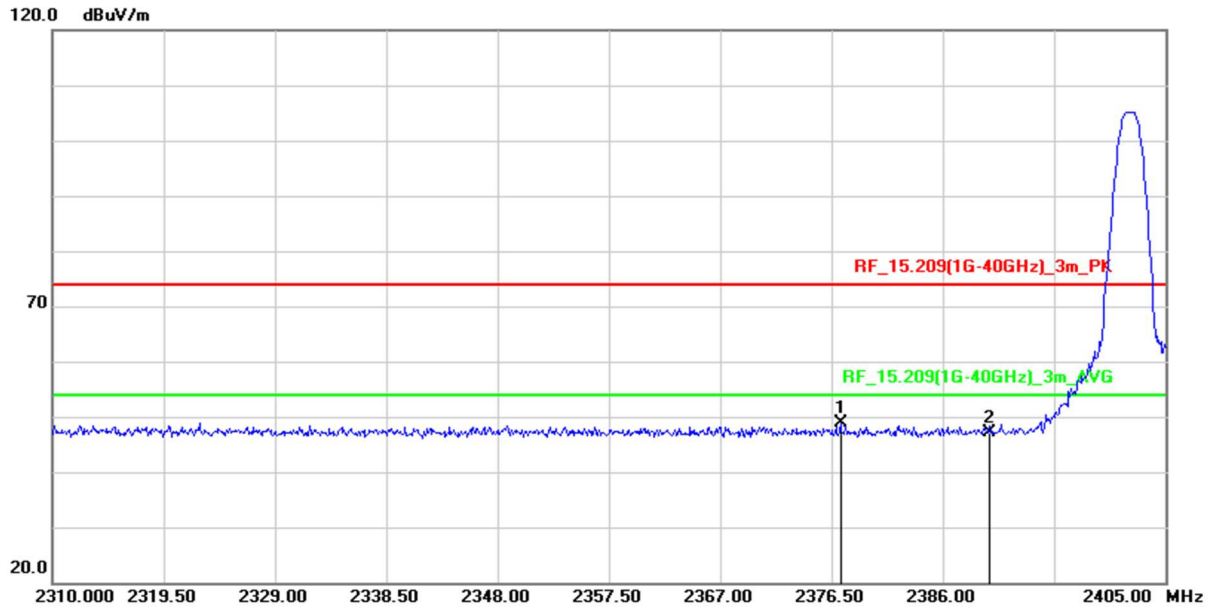

No.	Frequency (MHz)	Reading (dBuV/m)	Correct Factor (dB/m)	Result (dBuV/m)	Limit (dBuV/m)	Margin (dB)	Remark
1	2377.260	55.64	-6.72	48.92	74.00	-25.08	peak
2	2390.000	53.82	-6.69	47.13	74.00	-26.87	peak

**Remark :**

1. Correction Factor = Antenna factor + Cable loss – Amplifier gain
2. Result Value = Reading Level + Correct Factor
3. Margin Level = Result Value – Limit Value
4. The other emission levels were very low against the limit

<b>Test Mode :</b>	Transmit BLE	<b>Test Date :</b>	2021/10/11
<b>Test Channel :</b>	CH39(2480MHz)	<b>Temperature :</b>	24 °C
<b>Polarization :</b>	Horizontal	<b>Relative Humidity :</b>	49 %

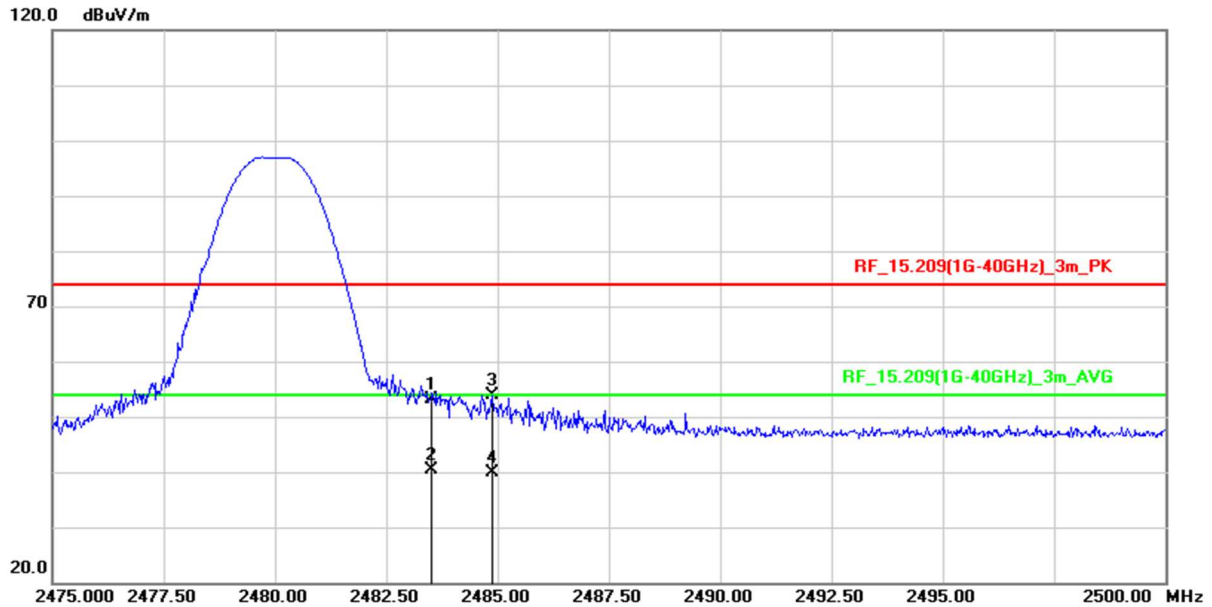

No.	Frequency (MHz)	Reading (dBuV/m)	Correct Factor (dB/m)	Result (dBuV/m)	Limit (dBuV/m)	Margin (dB)	Remark
1	2483.500	59.79	-6.61	53.18	74.00	-20.82	peak
2	2483.500	47.05	-6.61	40.44	54.00	-13.56	AVG
3	2484.875	60.49	-6.61	53.88	74.00	-20.12	peak
4	2484.875	46.52	-6.61	39.91	54.00	-14.09	AVG

**Remark :**

1. Correction Factor = Antenna factor + Cable loss – Amplifier gain
2. Result Value = Reading Level + Correct Factor
3. Margin Level = Result Value – Limit Value
4. The other emission levels were very low against the limit

<b>Test Mode :</b>	Transmit BLE	<b>Test Date :</b>	2021/10/11
<b>Test Channel :</b>	CH39(2480MHz)	<b>Temperature :</b>	24 °C
<b>Polarization :</b>	Vertical	<b>Relative Humidity :</b>	49 %

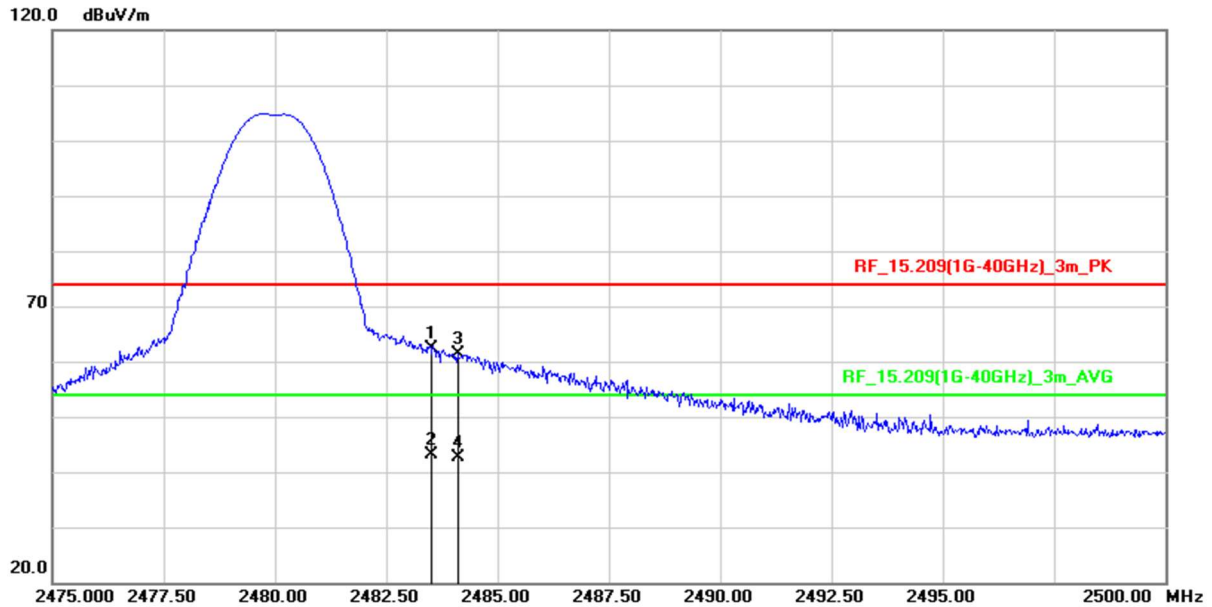

No.	Frequency (MHz)	Reading (dBuV/m)	Correct Factor (dB/m)	Result (dBuV/m)	Limit (dBuV/m)	Margin (dB)	Remark
1	2483.500	68.99	-6.61	62.38	74.00	-11.62	peak
2	2483.500	49.65	-6.61	43.04	54.00	-10.96	AVG
3	2484.100	67.92	-6.61	61.31	74.00	-12.69	peak
4	2484.100	49.34	-6.61	42.73	54.00	-11.27	AVG

**Remark :**

1. Correction Factor = Antenna factor + Cable loss – Amplifier gain
2. Result Value = Reading Level + Correct Factor
3. Margin Level = Result Value – Limit Value
4. The other emission levels were very low against the limit

### 2.6.6 Test Result of Radiated Spurious Emission Measurement

- (1) The radiation measurement frequency is 9kHz ~ 30MHz. The interference value of this frequency range is less than the limit value of 20 dB. It is considered that the background noise value is not recorded.
- (2) The following table shows the radiation measurement frequency from 30MHz to 26.5GHz, pre-scanning in the X, Y and Z axes. The worst case (X-axis) is documented in this report.

Test Frequency	
RF	BLE
Tx	CH00 (2402MHz)
	CH19 (2440MHz)
	CH39 (2480MHz)

### Above 1GHz Data

<b>Test Mode :</b>	Transmit BLE	<b>Test Date :</b>	2021/10/11
<b>Test Channel :</b>	CH00(2402MHz)	<b>Temperature :</b>	24 °C
<b>Polarization :</b>	Horizontal	<b>Relative Humidity :</b>	49 %

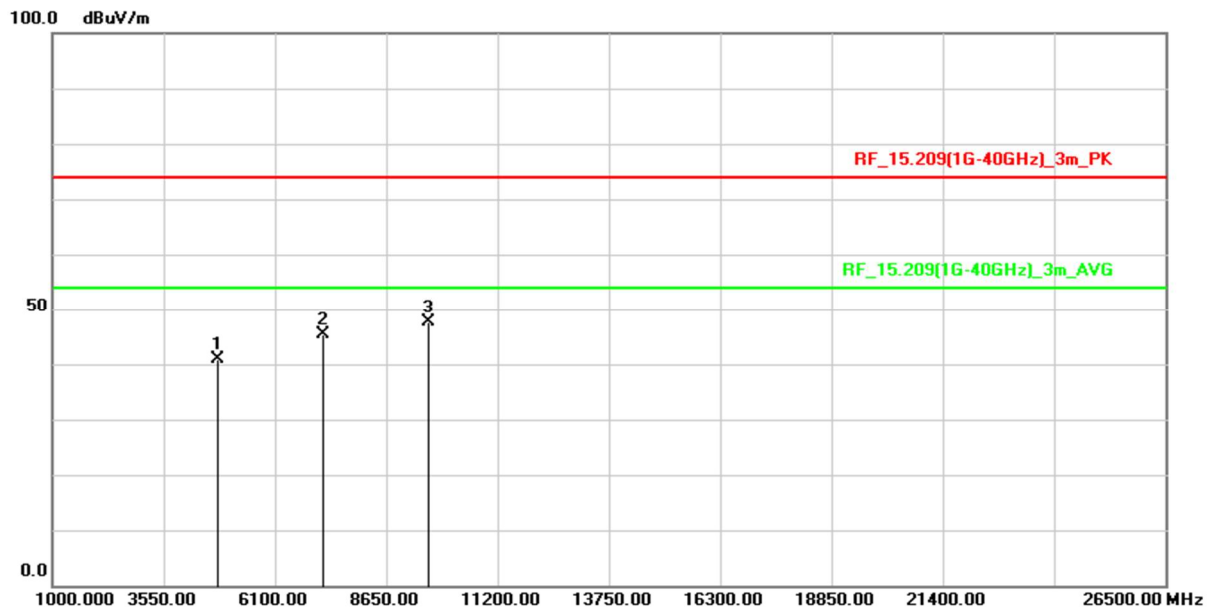

No.	Frequency (MHz)	Reading (dBuV/m)	Correct Factor (dB/m)	Result (dBuV/m)	Limit (dBuV/m)	Margin (dB)	Remark
1	4804.000	61.39	-20.63	40.76	74.00	-33.24	peak
2	7206.000	60.19	-14.88	45.31	74.00	-28.69	peak
3	9608.000	58.65	-10.94	47.71	74.00	-26.29	peak

#### Remark :

1. Correction Factor = Antenna factor + Cable loss – Amplifier gain
2. Result Value = Reading Level + Correct Factor
3. Margin Level = Result Value – Limit Value
4. The other emission levels were very low against the limit

<b>Test Mode :</b>	Transmit BLE	<b>Test Date :</b>	2021/10/11
<b>Test Channel :</b>	CH00(2402MHz)	<b>Temperature :</b>	24 °C
<b>Polarization :</b>	Vertical	<b>Relative Humidity :</b>	49 %

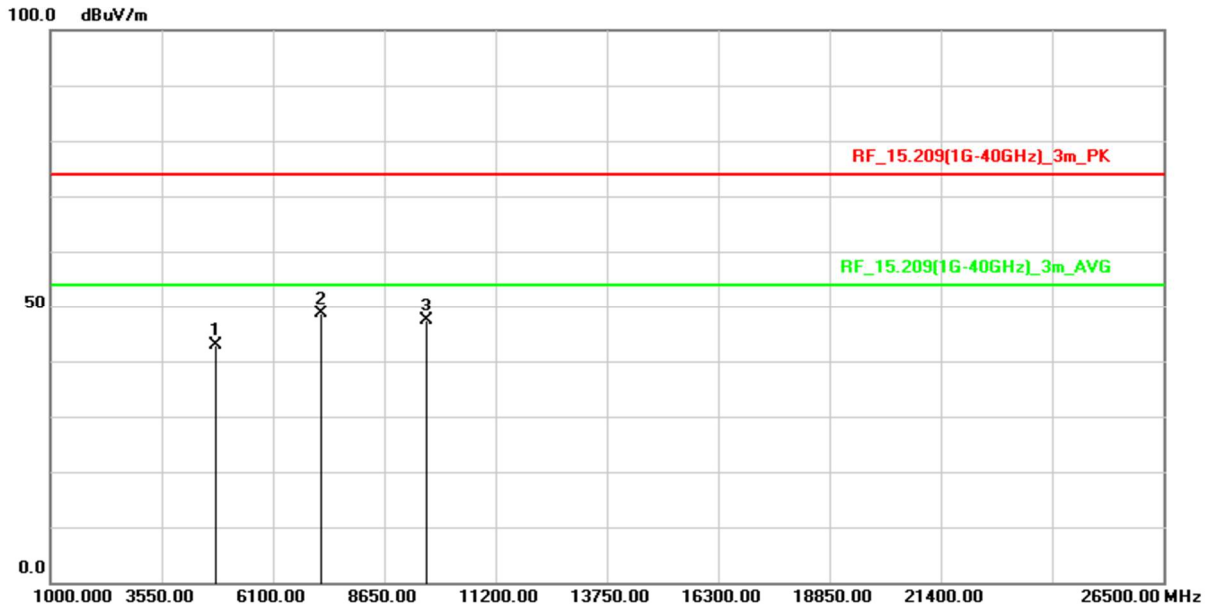

No.	Frequency (MHz)	Reading (dBuV/m)	Correct Factor (dB/m)	Result (dBuV/m)	Limit (dBuV/m)	Margin (dB)	Remark
1	4804.000	63.56	-20.63	42.93	74.00	-31.07	peak
2	7206.000	63.61	-14.88	48.73	74.00	-25.27	peak
3	9608.000	58.26	-10.94	47.32	74.00	-26.68	peak

**Remark :**

1. Correction Factor = Antenna factor + Cable loss – Amplifier gain
2. Result Value = Reading Level + Correct Factor
3. Margin Level = Result Value – Limit Value
4. The other emission levels were very low against the limit

<b>Test Mode :</b>	Transmit BLE	<b>Test Date :</b>	2021/10/11
<b>Test Channel :</b>	CH19(2440MHz)	<b>Temperature :</b>	24 °C
<b>Polarization :</b>	Horizontal	<b>Relative Humidity :</b>	49 %

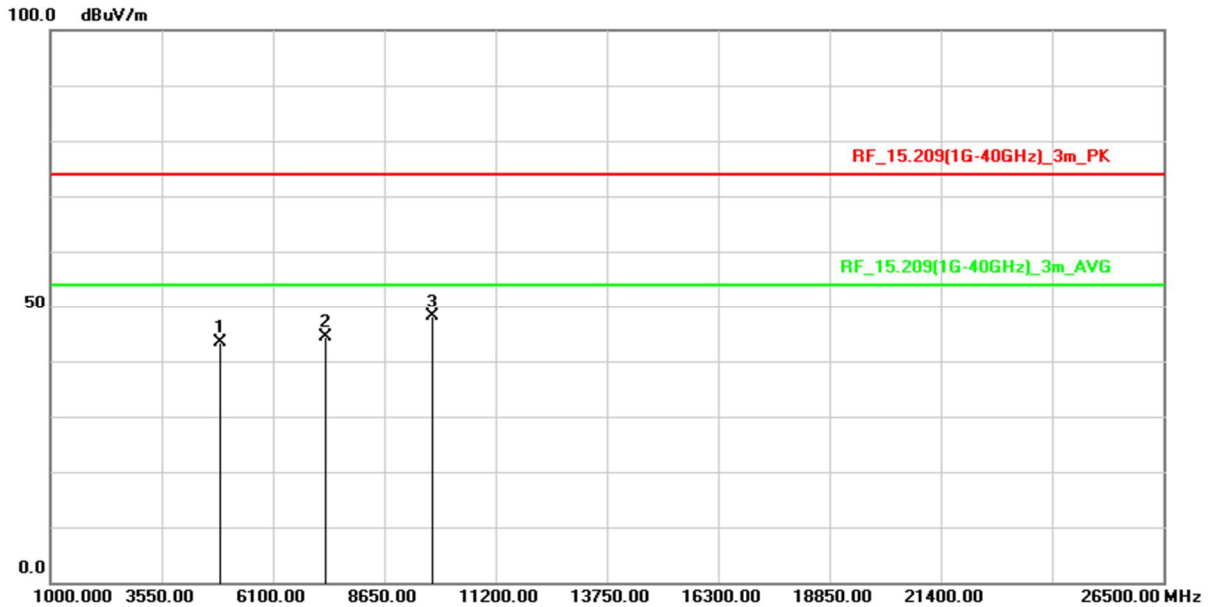

No.	Frequency (MHz)	Reading (dBuV/m)	Correct Factor (dB/m)	Result (dBuV/m)	Limit (dBuV/m)	Margin (dB)	Remark
1	4880.000	64.16	-20.73	43.43	74.00	-30.57	peak
2	7320.000	59.29	-14.95	44.34	74.00	-29.66	peak
3	9760.000	58.78	-10.69	48.09	74.00	-25.91	peak

**Remark :**

1. Correction Factor = Antenna factor + Cable loss – Amplifier gain
2. Result Value = Reading Level + Correct Factor
3. Margin Level = Result Value – Limit Value
4. The other emission levels were very low against the limit



<b>Test Mode :</b>	Transmit BLE	<b>Test Date :</b>	2021/10/11
<b>Test Channel :</b>	CH19(2440MHz)	<b>Temperature :</b>	24 °C
<b>Polarization :</b>	Vertical	<b>Relative Humidity :</b>	49 %

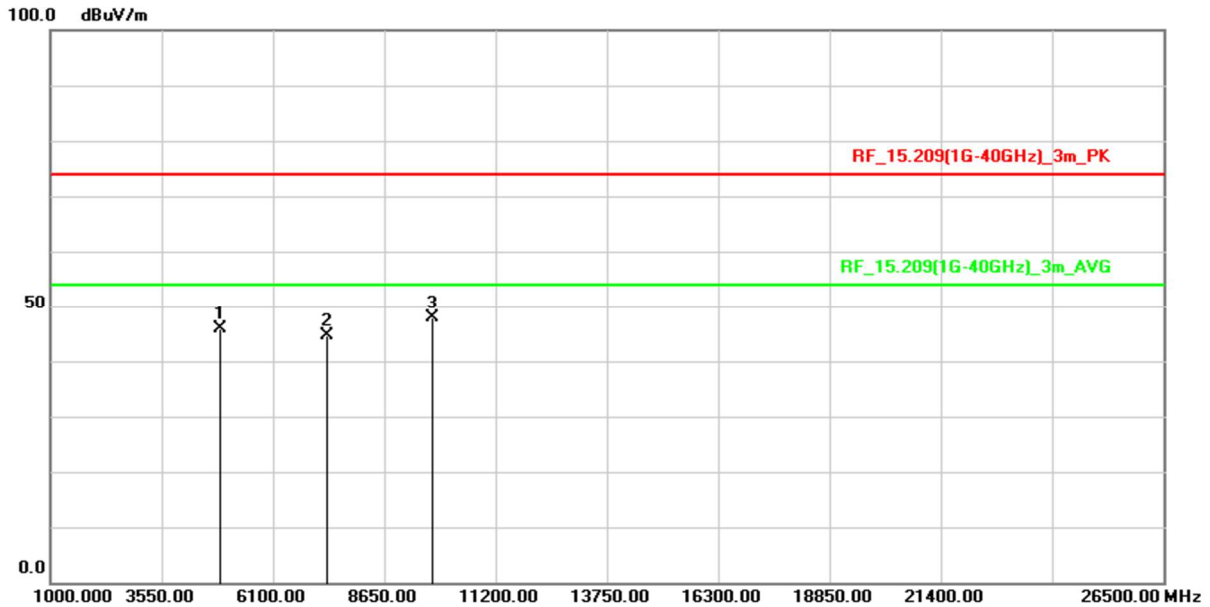

No.	Frequency (MHz)	Reading (dBuV/m)	Correct Factor (dB/m)	Result (dBuV/m)	Limit (dBuV/m)	Margin (dB)	Remark
1	4880.000	66.71	-20.73	45.98	74.00	-28.02	peak
2	7320.000	59.50	-14.95	44.55	74.00	-29.45	peak
3	9760.000	58.61	-10.69	47.92	74.00	-26.08	peak

**Remark :**

1. Correction Factor = Antenna factor + Cable loss – Amplifier gain
2. Result Value = Reading Level + Correct Factor
3. Margin Level = Result Value – Limit Value
4. The other emission levels were very low against the limit

<b>Test Mode :</b>	Transmit BLE	<b>Test Date :</b>	2021/10/11
<b>Test Channel :</b>	CH39(2480MHz)	<b>Temperature :</b>	24 °C
<b>Polarization :</b>	Horizontal	<b>Relative Humidity :</b>	49 %

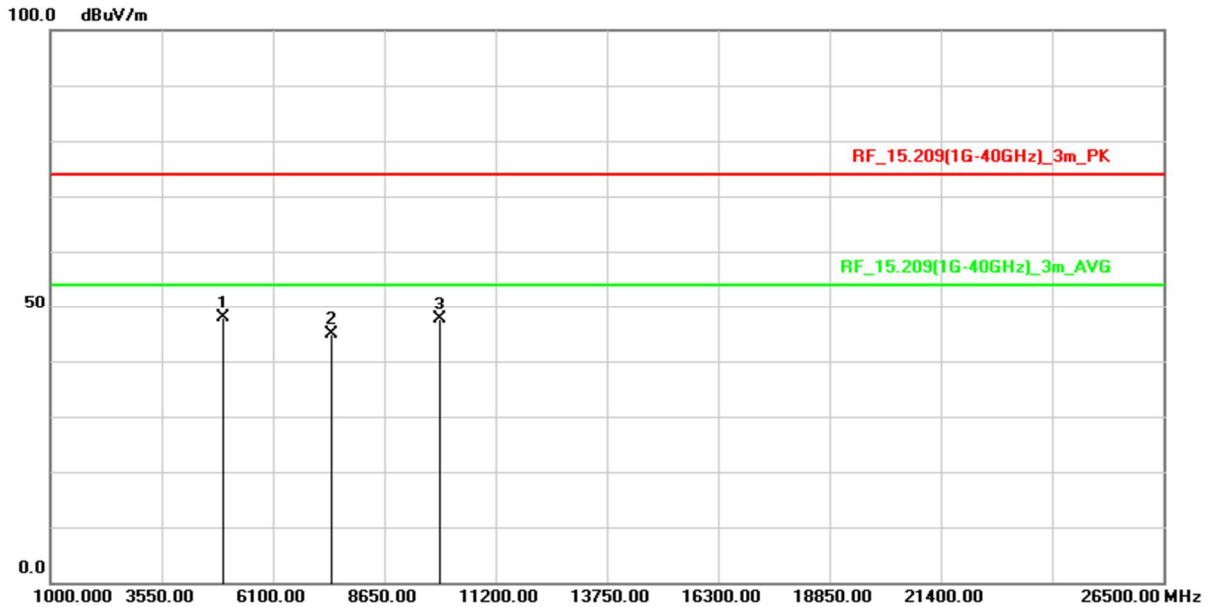

No.	Frequency (MHz)	Reading (dBuV/m)	Correct Factor (dB/m)	Result (dBuV/m)	Limit (dBuV/m)	Margin (dB)	Remark
1	4960.000	68.45	-20.68	47.77	74.00	-26.23	peak
2	7440.000	59.44	-14.50	44.94	74.00	-29.06	peak
3	9920.000	58.61	-10.88	47.73	74.00	-26.27	peak

**Remark :**

1. Correction Factor = Antenna factor + Cable loss – Amplifier gain
2. Result Value = Reading Level + Correct Factor
3. Margin Level = Result Value – Limit Value
4. The other emission levels were very low against the limit

<b>Test Mode :</b>	Transmit BLE	<b>Test Date :</b>	2021/10/11
<b>Test Channel :</b>	CH39(2480MHz)	<b>Temperature :</b>	24 °C
<b>Polarization :</b>	Vertical	<b>Relative Humidity :</b>	49 %

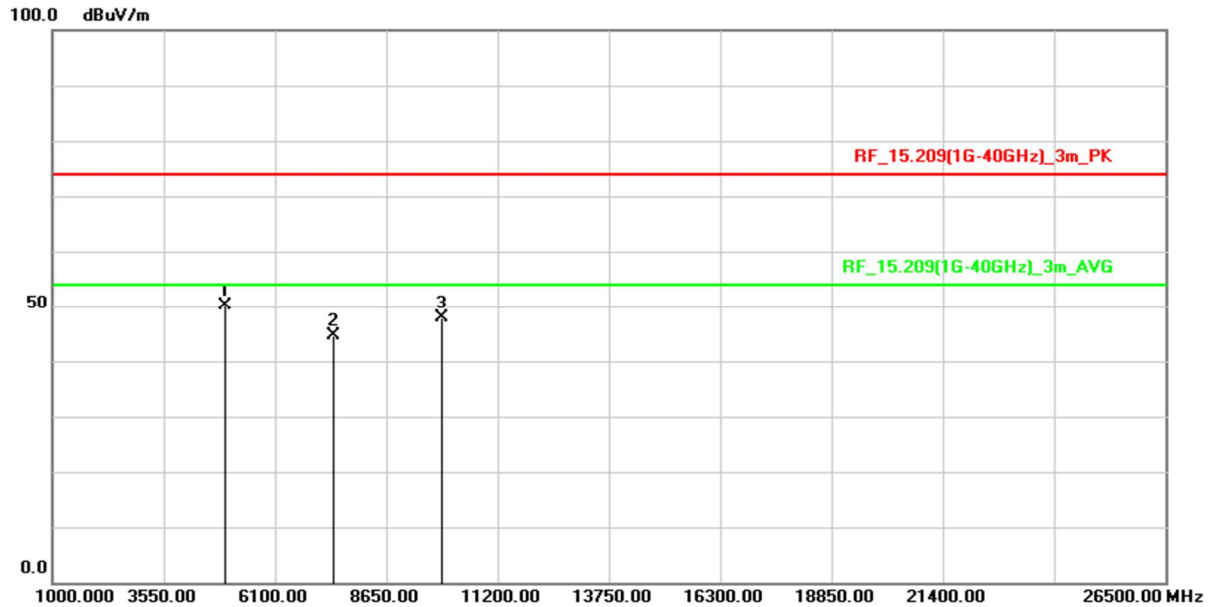

No.	Frequency (MHz)	Reading (dBuV/m)	Correct Factor (dB/m)	Result (dBuV/m)	Limit (dBuV/m)	Margin (dB)	Remark
1	4960.000	70.91	-20.68	50.23	74.00	-23.77	peak
2	7440.000	59.18	-14.50	44.68	74.00	-29.32	peak
3	9920.000	58.88	-10.88	48.00	74.00	-26.00	peak

**Remark :**

1. Correction Factor = Antenna factor + Cable loss – Amplifier gain
2. Result Value = Reading Level + Correct Factor
3. Margin Level = Result Value – Limit Value
4. The other emission levels were very low against the limit

### Below 1GHz Data

<b>Test Mode :</b>	Transmit BLE	<b>Test Date :</b>	2021/10/11
<b>Test Channel :</b>	CH19(2440MHz)	<b>Temperature :</b>	24 °C
<b>Polarization :</b>	Horizontal	<b>Relative Humidity :</b>	49 %

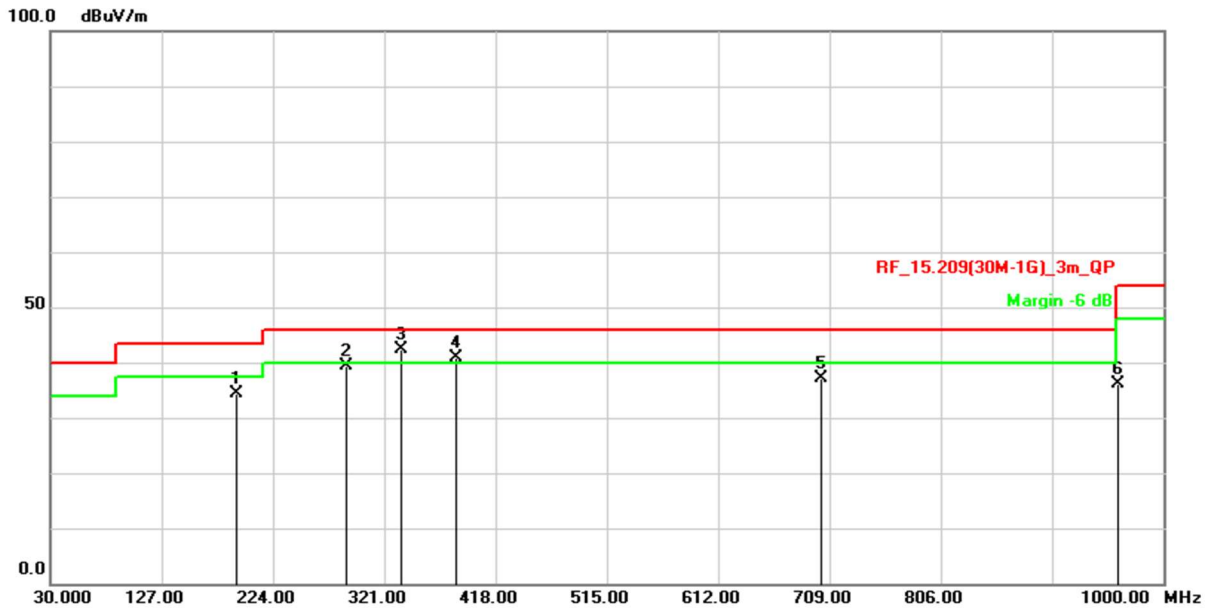

No.	Frequency (MHz)	Reading (dBuV/m)	Correct Factor (dB/m)	Result (dBuV/m)	Limit (dBuV/m)	Margin (dB)	Remark
1	191.9900	48.61	-14.22	34.39	43.50	-9.11	QP
2	288.0200	50.17	-10.80	39.37	46.00	-6.63	QP
3	335.5500	51.74	-9.33	42.41	46.00	-3.59	QP
4	384.0500	49.17	-8.23	40.94	46.00	-5.06	QP
5	702.2100	38.27	-1.03	37.24	46.00	-8.76	QP
6	960.2300	32.76	3.25	36.01	53.90	-17.89	QP

**Remark :**

1. Correction Factor = Antenna factor + Cable loss – Amplifier gain
2. Result Value = Reading Level + Correct Factor
3. Margin Level = Result Value – Limit Value
4. The other emission levels were very low against the limit

<b>Test Mode :</b>	Transmit BLE	<b>Test Date :</b>	2021/10/11
<b>Test Channel :</b>	CH19(2440MHz)	<b>Temperature :</b>	24 °C
<b>Polarization :</b>	Vertical	<b>Relative Humidity :</b>	49 %

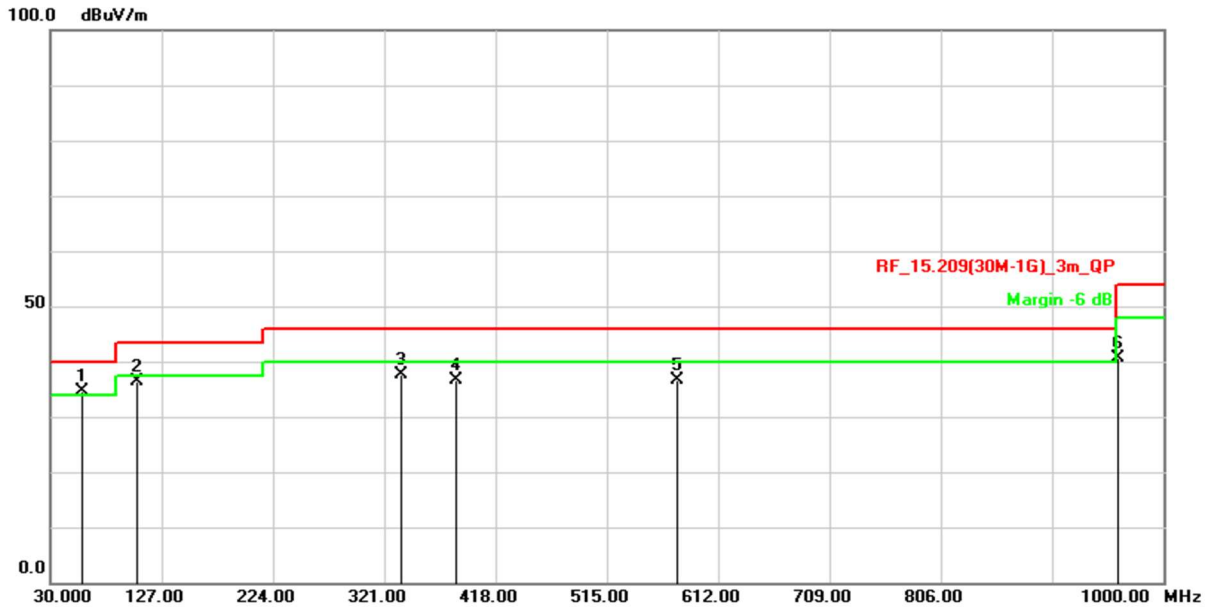

No.	Frequency (MHz)	Reading (dBuV/m)	Correct Factor (dB/m)	Result (dBuV/m)	Limit (dBuV/m)	Margin (dB)	Remark
1	57.1600	46.50	-11.75	34.75	40.00	-5.25	QP
2	105.6600	51.60	-15.16	36.44	43.50	-7.06	QP
3	335.5500	46.90	-9.33	37.57	46.00	-8.43	QP
4	384.0500	44.76	-8.23	36.53	46.00	-9.47	QP
5	576.1100	40.12	-3.51	36.61	46.00	-9.39	QP
6	960.2300	37.48	3.25	40.73	53.90	-13.17	QP

**Remark :**

1. Correction Factor = Antenna factor + Cable loss – Amplifier gain
2. Result Value = Reading Level + Correct Factor
3. Margin Level = Result Value – Limit Value
4. The other emission levels were very low against the limit

## 2.7 AC Conducted Emissions Measurement

### 2.7.1 Limit

Frequency (MHz)	FCC Part 15 Subpart C Paragraph 15.207 (dB $\mu$ V) Limit	
	Quasi-peak	Average
0.15 to 0.5	66 to 56*	56 to 46*
0.50 to 5.0	56	46
5.0 to 30.0	60	50

\*Decreases with the logarithm of the frequency

### 2.7.2 Test Setup

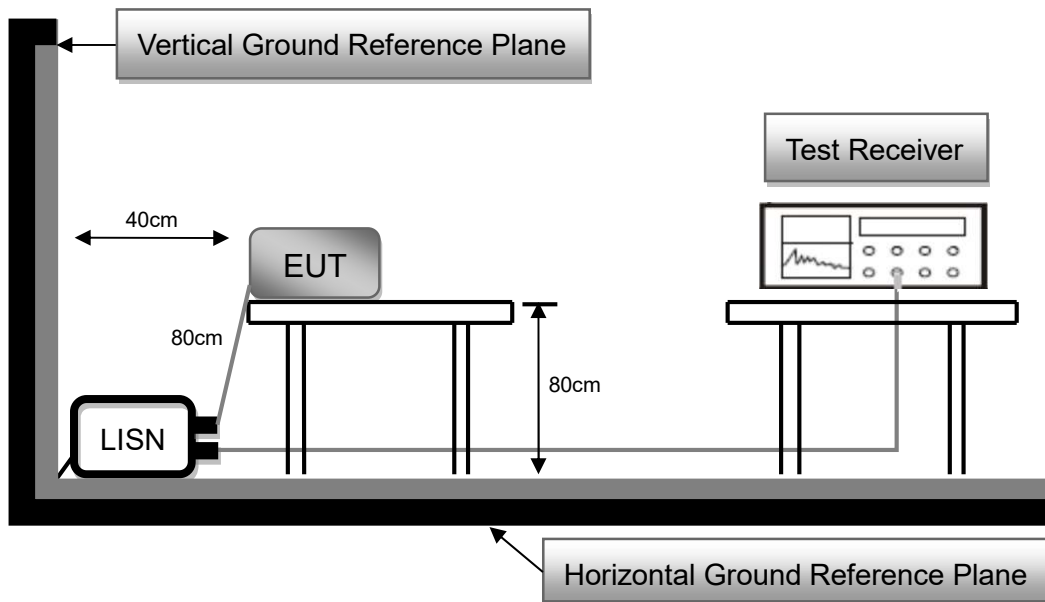

### 2.7.3 Test Procedure

1. The EUT was placed 0.8 meter height wooden table from the horizontal ground plane with EUT being connected to power source through a line impedance stabilization network (LISN). The LISN at least be 80 cm from nearest chassis of EUT.
2. The line impedance stabilization network (LISN) provides 50 ohm/50uH of coupling impedance for the measuring instrument. All other support equipments powered from additional LISN(s).
3. Interrelating cables that hang closer than 40 cm to the ground plane shall be folded back and forth in the center forming a bundle. All I/O cables were positioned to simulate typical usage.
4. All I/O cables that are not connected to a peripheral shall be bundle in the center. The end of the cable may be terminated, if required, using the correct terminating impedance. The overall length shall not exceed 1 m.
5. The EMI test receiver connected to LISN powering the EUT. The actual test configuration, please refer to EUT test photos.
6. The receiver scanned from 150kHz to 30MHz for emissions in each of test modes. A scan was taken on both power lines, Line and Neutral, recording at least six highest emissions.
7. The EUT and cable configuration of the above highest emission levels were recorded. The Test Data of the worst case was recorded.

### 2.7.4 Test Result

Test Voltage :	120Vac, 60Hz	Frequency Range:	0.15-30 MHz
Test Mode :	Normal Link	6dB Bandwidth :	9 kHz
Test Date :	2021/09/24	Phase :	L
Temperature :	26°C	Humidity :	38 %

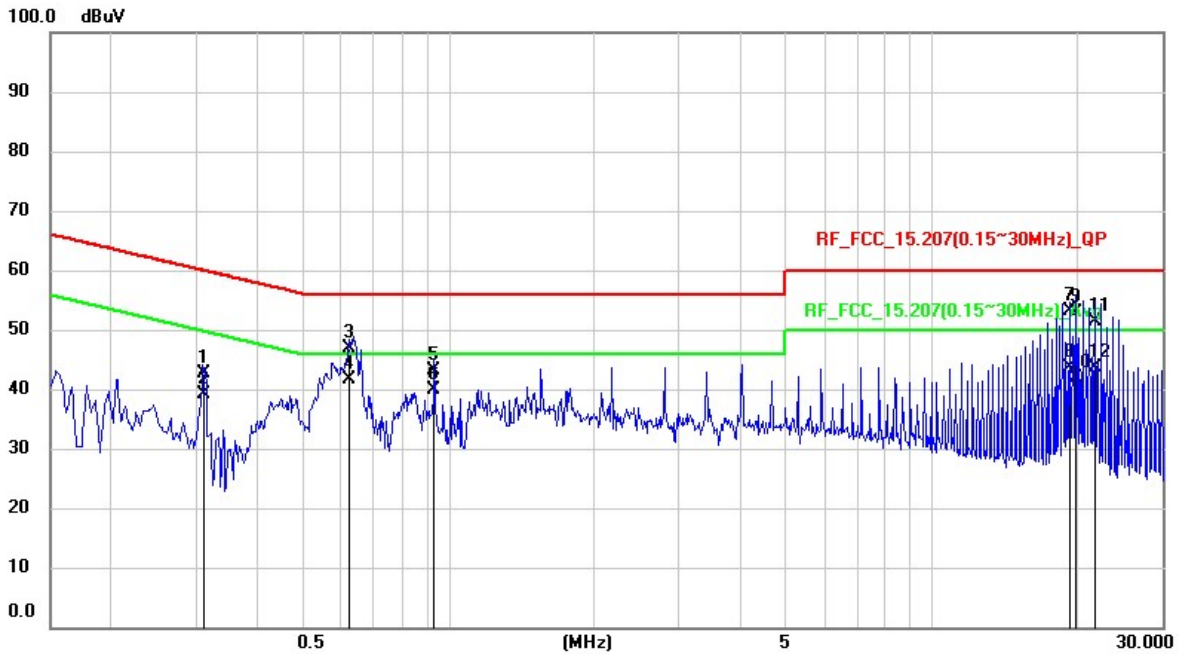

No.	Frequency (MHz)	Reading Level (dBuV)	Correct Factor (dB)	Measurement (dBuV)	Limit (dBuV)	Margin (dB)	Detector
1	0.312	32.82	9.81	42.63	59.92	-17.29	QP
2	0.312	29.33	9.81	39.14	49.92	-10.78	AVG
3	0.6268	37.17	9.81	46.98	56	-9.02	QP
4	0.6268	31.73	9.81	41.54	46	-4.46	AVG
5	0.9347	33.38	9.82	43.2	56	-12.8	QP
6	0.9347	30.06	9.82	39.88	46	-6.12	AVG
7	19.3176	42.83	10.25	53.08	60	-6.92	QP
8	19.3176	33.49	10.25	43.74	50	-6.26	AVG
9	19.9429	42.7	10.26	52.96	60	-7.04	QP
10	19.9429	31.66	10.26	41.92	50	-8.08	AVG
11	21.8104	41.09	10.3	51.39	60	-8.61	QP
12	21.8104	33.27	10.3	43.57	50	-6.43	AVG

Remark:

1. QP = Quasi Peak, AVG = Average
2. Correction Factor = Insertion loss of LISN + Cable loss
3. Measurement Value = Reading Level + Correct Factor
4. Margin Level = Result Value – Limit Value



<b>Test Voltage :</b>	120Vac, 60Hz	<b>Frequency Range:</b>	0.15-30 MHz
<b>Test Mode :</b>	Normal Link	<b>6dB Bandwidth :</b>	9 kHz
<b>Test Date :</b>	2021/09/24	<b>Phase :</b>	N
<b>Temperature :</b>	26°C	<b>Humidity :</b>	38 %

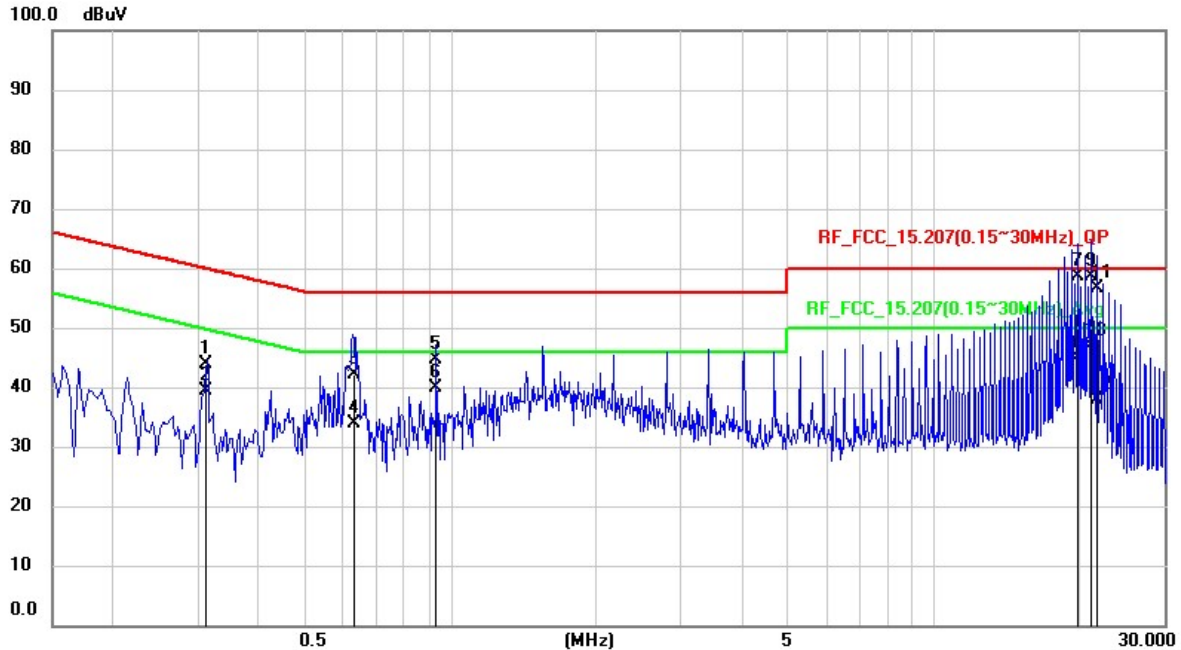

No.	Frequency (MHz)	Reading Level (dBuV)	Correct Factor (dB)	Measurement (dBuV)	Limit (dBuV)	Margin (dB)	Detector
1	0.3113	33.99	9.82	43.81	59.94	-16.13	QP
2	0.3113	29.62	9.82	39.44	49.94	-10.5	AVG
3	0.6332	32.25	9.82	42.07	56	-13.93	QP
4	0.6332	24.07	9.82	33.89	46	-12.11	AVG
5	0.9345	34.84	9.82	44.66	56	-11.34	QP
6	0.9345	30.18	9.82	40	46	-6	AVG
7	19.943	48.49	10.26	58.75	60	-1.25	QP
8	19.943	34.67	10.26	44.93	50	-5.07	AVG
9	21.1851	48.36	10.29	58.65	60	-1.35	QP
10	21.1851	36.49	10.29	46.78	50	-3.22	AVG
11	21.8019	46.28	10.3	56.58	60	-3.42	QP
12	21.8019	27.46	10.3	37.76	50	-12.24	AVG

Remark:

1. QP = Quasi Peak, AVG = Average
2. Correction Factor = Insertion loss of LISN + Cable loss
3. Measurement Value = Reading Level + Correct Factor
4. Margin Level = Result Value – Limit Value

--- END ---