

החברה



FCC ID:2AIB7X2

User Manual V1.0

Contents

- 01 Download the Hohem Pro App
- 02 iSteady X2 Overview
- 03 iSteady X2 Remote Control
- 05 Mounting and Balancing
- 06 Activation & Bluetooth Connection
- 07 Button Function
- 08 Working Mode & Follow Speed
- 10 How to fold the gimbal?
- 10 How to do if the gimbal is not level after powering on?
- 11 Use as emergency power bank
- 11 Power indicator and Bluetooth indicator function
- 12 Specifications
- 13 Warranty Card
- 14 Contact us



Disclaimer and Warning

Thank you for purchasing the Hohem product. By using this product, you hereby signify that you have read this disclaimer and warning carefully and that you understand and agree to abide by the terms and conditions herein. You agree that you are solely responsible for your own conduct while using this product, and for any consequences thereof. You agree to use this product only for purposes that are proper and in accordance with all applicable laws, rules, and regulations, and all terms, precautions, practices, policies and guidelines Hohem has made and may make available.

Hohem accepts no liability for damage, injury or any legal responsibility incurred directly or indirectly from the use of this product. The user shall observe safe and lawful practices including, but not limited to, those set forth in this document.



**Important
Notes:**

- When powering on iSteady X2 at first use, activation is required through Hohem Pro app.
- iSteady X2 works after the activation.
- Mount your mobile phone before powering on iSteady X2.
- If no mobile phone is detected or the motor is overloaded due to phone is not level, the gimbal will shut down after a warning beeping.

Download the Hohem Pro App Register and Login



Scan the QR code to enter the download page
Search " Hohem Pro " in the App Store or Google Play

- *Hohem Pro app requires iOS 10.0 or above, Android 6.0 or above
- *More product tutorials can be found on the app homepage

iSteady X2 Overview

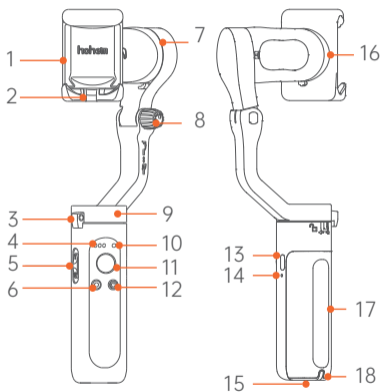

1. Phone Clamp
2. Folding Lock A
3. Folding Lock B
4. Battery Indicator
5. Zoom Slider
6. Shutter Button
7. Tilt Motor
8. Knob
9. Pan Motor
10. Bluetooth Light
11. Joystick
12. Power (ON/OFF) / Function Button
13. Bidirectional charging port (Type C)
14. Reset
15. 1/4 inch Screw Port
16. Roll Motor
17. Handle (Battery built-in)
18. Lanyard Hole

iSteady X2 Remote Control

① Power Button

ON: Power On OFF: Power Off

② Shutter Button

(Make sure the app connect to the gimbal successful)

Single Press: Take photo, Start/End video

Double Press: Switch the photo and video modes

Triple Press: Switch the front and rear cameras

(Only available in the app)

③ Function Button

Single Press: Switch the landscape and portrait modes

Double Press: Recenter the gimbal

Triple Press: Inception (Auto rotation)

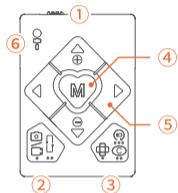

④ M Button (Gimbal Working Mode)

Single Press: Pan&Tilt Follow

Double Press: Pan Follow

Triple Press: All Lock

Quartic Press: POV (All Follow)

Long Press: Switch the zoom in/out mode and gimbal tilt control mode (Zoom in/out mode only available in the app)

⑤ Navigation Buttons: Up/Down/Left/Right

In the gimbal direction control mode:

Up/Down: Tilt Control

Left/Right: Pan Control

In the zoom in/out mode:

Up/Down: Control the image zoom in/out (Only available in the app)

⑥ Indicator Light

The indicator light shows green or blue in button operation. If no light shows, it means the remote control is not turned on or no battery.

Green light: Gimbal controlling

Blue light: Phone camera controlling

How to mount and balance mobile phone on the gimbal?



①

Unfold the gimbal



②

Screw up the knob



③

Turn the "hohem" logo upward

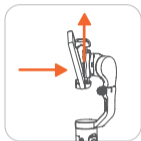

④

Put your phone stuck in the bottom of phone clamp and pull the head of phone clamp to mount your phone

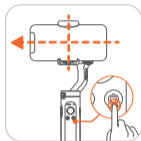

⑤

Slide the phone and make sure it is clamped in the middle, power on the gimbal after balancing the phone clamp



The gimbal would work improperly if not screw the knob up.



Clench the phone clamp, ensuring that your phone is cling to the rubber mat, otherwise the gimbal would vibrate or turn off automatically.

Booting up iSteady X2 at first use Activation & Bluetooth Connection

For the first time, please turn on the gimbal. Log into the Hohem Pro app to activate the gimbal. Gimbal will work improperly if not been activated.

① Startup

Long press the function button. At the first start, it will enter a to-be-activated state and the Bluetooth indicator will flash alternately in red and green.

② Bluetooth connection through the App

Turn on the bluetooth of phone. Log into the app Hohem Pro. Following the notice at the top for connection.

③ Activate iSteady X2

After the Bluetooth is connected, an activation prompt box will pop up. Click "Confirm" to complete the activation. Three beeps for noticing you the activation has done, and you can use the gimbal now.

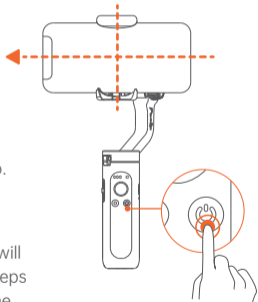

Button Function

① Power (ON/OFF) / Function Button

Long Press: Power On/Off

Single Press: Switch the landscape and portrait modes

Double Press: Recenter the gimbal

Triple Press: Inception (Auto rotation)

Press Five Times: Auto calibration

Press Seven Times: Remote control pairing

The bluetooth light will flash alternatly in yellow and green.

a. If the remote control is not paired within 30 seconds, the pairing will be cancelled;

b. Click the function button to cancel pairing;

c. Double-click the function button to clear the paired remote control and cancel pairing;

(And the paired remote control will be unavailable and need to be re-paired)

② Joystick

Up/Down: Tilt Control

Left/Right: Pan Control

(It is able to control the roll motor through Left/Right Joystick Settings in Hohem Pro app)

④ Shutter Button (Ensure the Bluetooth is connected)

Single Press: Take photo, Start/End video

Double Press: Switch photo/video modes

Triple Press: Switch front/rear cameras (Only available in the app)

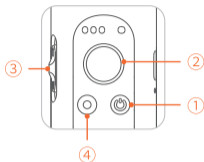

③ Zoom Slider

(Only available in the app)

Push Up: Zoom in

Push Down: Zoom out

How to switch working modes by button?

Combination operation: Press and hold shutter button and tap power button

Single Tap: Pan&Tilt Follow (Default)

Double Tap: Pan Follow

Triple Tap: All Lock

Quartic Tap: POV (All Follow)

*Tips: To ensure proper operation, please release the shutter button after the power button.

Working Mode & Follow Speed

*For changing working mode or follow speed, please open Hohem Pro app - Start Recording - Gimbal Parameter Settings

*Ensure the Bluetooth is connected and change the settings

Working Mode

Pan&Tilt Follow

This is the default working mode. When you rotate the handle left/right/tilt up/tilt down, the camera will follow the handle movements, and the roll motor is locked without follow the movement.

Pan Follow

When you rotate the handle left/right, the camera will follow the handle movements. The tilt motor does not follow within the angle range of $-30^{\circ}\sim+30$ movement, if exceed this range, the gimbal will follow the tilt movement, and the roll motor is locked without follow the movement.

All Lock

The roll and pan motors are locked without follow the movement. The tilt motor does not follow within the angle range of $-30^{\circ}\sim+30$ movement, if exceed this range, the gimbal will follow the tilt movement.

POV (All Follow)

First person point of view

Gives you 360° complete movement, you can pan, tilt and roll with it.

Follow Speed

General Shooting with general follow speed

Slow Shooting with slow follow speed

Medium Shooting to follow the fast movement

Fast Fast follow speed for video transition

How to fold Gimbal?

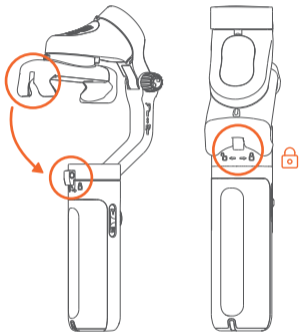

How to do if the gimbal is not level after powering on?

If the gimbal is not level after turned on, or pan axis is slight drift when the gimbal is still, please calibrate the gimbal on a stationary and horizontal surface.

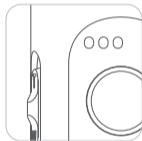

- ① Turn on the gimbal, press function button 5 times
- ② Start calibration after a beep sound
- ③ The battery indicator light keep flashing
- ④ The calibration is done after two beeps sound (the calibration takes about 40 seconds)

Use as emergency power bank

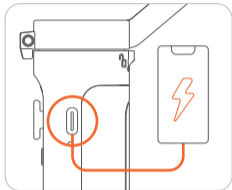

The gimbal can be used as emergency power bank for your mobile phone and other electronic devices.

Power indicator and Bluetooth indicator function



Power Indicator Lights

Stay on: Fully charged or charging complete

Single flashing: Charging

Continuous Flashing: Calibrating



Bluetooth Indicator Light

1.

A.Blinks red and green alternatively:

To be activated (at first use)

B.Blinks yellow and green alternatively :

The remote control is pairing

2. Color indicates the status of gimbal

Green: Bluetooth is connected

Yellow: Bluetooth is not connected

Red: Warning of abnormal loads on the stabilizer or failed firmware upgrade

3.Blinking indicators of working modes

Solid Light: Pan& Tilt Follow

Flash twice: Pan Follow

Flash triple: All Lock

Flash four times: POV (All Follow)

Pulse: Standby mode

Specifications

Model iSteady X2 **Weight** 259g

Folded Dimensions 179 X 79 X 39 mm

Battery 18650li-ion 2800mAh

Operating Time 10 hours

Bidirectional charging port (Type C) supports gimbal works while charging.

Mechanical Range * Pan: 320° * Roll: 320°
* Tilt: 320°

Controllable Range * Pan: 320°
* Tilt: -30°~+30°

Compatible Phones Weight : ≤280g
Thickness: ≤11 mm
Width: 55mm~90mm

The motor would be shown in the screen due to some of mobile cameras are designed at the middle of phone, such as Xiaomi10, Xiaomi10 Pro, Xiaomi CC9 PRO.

Warranty Card

User Name:

Contact No.:

Address:

Purchase Date:

Prod. Serial No.:

Failure Issue:

Service Record:

1. Within 15 days upon the purchase date. Any functional disorder or quality problem enjoys free replacement service. But ensure the commodity and package with no damage, and we will offer a brand new replacement after confirming the product problem.
2. Warranty valid only under normal use.
3. Used in the normal circumstances, 1 year warranty, maintenance of life (not include the All accidents or artificial damage, improper disassembly or misuse damage is NOT covered by the warranty).
4. Please keep and offer the warranty card for claiming the warranty service.

CALL CENTER -Toll Free

UNITED STATES:+1(888)9658512

Mon-Fri: 9:00AM-5:00PM(EST)

UNITED KINGDOM:+44(0)808 2737578

Mon-Fri: 2:00PM-10:00PM(GMT +0)

GERMANY:+49(0)800 0010109

Mon-Fri: 9:00AM-5:00PM(GMT +1)

CANADA:+1(855)758-8939

Mon-Fri: 9:00AM-5:00PM(EST)

BRAZIL:+55 (0)800 5911897

Mon-Fri: 10:00AM-6:00PM(GMT -3)

Contact us

Email: service@hohem.com

Website: www.hohem.com

Manufacturer: Hohem technology co., ltd

Contact us at Facebook

-@Hohem-tech-

Federal Communication Commission (FCC) Radiation Exposure Statement

The device has been evaluated to meet general RF exposure requirement, The device can be used in portable exposure condition without restriction

This device complies with part 15 of the FCC rules. Operation is subject to the following two conditions:

- (1) this device may not cause harmful interference, and
- (2) this device must accept any interference received, including interference that may cause undesired operation.

NOTE: The manufacturer is not responsible for any radio or TV interference caused by unauthorized modifications or changes to this equipment. Such modifications or changes could void the user's authority to operate the equipment.

NOTE: This equipment has been tested and found to comply with the limits for a Class B digital device, pursuant to part 15 of the FCC Rules. These limits are designed to provide reasonable protection against harmful interference in a residential installation. This equipment generates uses and can radiate radio frequency energy and, if not installed and used in accordance with the instructions, may cause harmful interference to radio communications. However, there is no guarantee that interference will not occur in a particular installation. If this equipment does cause harmful interference to radio or television reception, which can be determined by turning the equipment off and on, the user is encouraged to try to correct the interference by one or more of the following measures:

- Reorient or relocate the receiving antenna.
- Increase the separation between the equipment and receiver.
- Connect the equipment into an outlet on a circuit different from that to which the receiver is connected.
- Consult the dealer or an experienced radio/TV technician for help.

This device is operated the frequency bands and the maximum output power (E.I.R.P) :
2402MHz – 2480MHz : 6.51dBm

CAUTION RISK OF EXPLOSION IF BATTERY IS REPLACED BY AN INCORRECT TYPE. DISPOSE OF USED BATTERIES ACCORDING TO THE INSTRUCTIONS.

The adapter shall be installed near the equipment and shall be easily accessible.
the recommended output voltage/current of the adaptor is 5Vdc/1A.,and the adapter shall be CE approval type.

The suitable temperature for the product and accessories is -10°C~40°C.