

# Hohem

## iSteady*Mobile*<sup>+</sup>

3-Axis Stabilizing Gimbal for Smartphone

### User Manual

V1.0

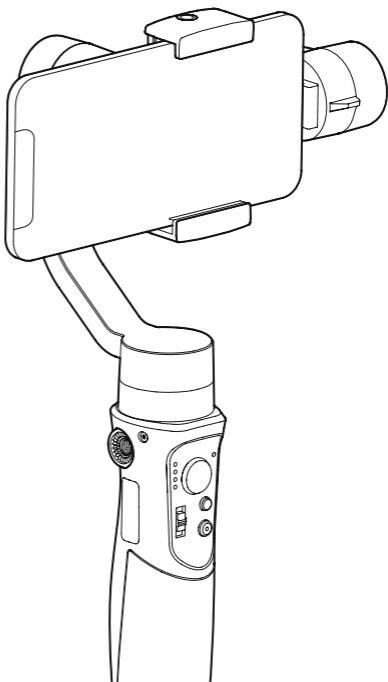

For more tutorial  
videos please scan  
YouTube QR code

# DISCLAIMER

Thank you for purchasing the Hohem product. By using this product, you hereby signify that you have read this disclaimer and warning carefully and that you understand and agree to abide by the terms and conditions herein. You agree that you are solely responsible for your own conduct while using this product, and for any consequences thereof. You agree to use this product only for purposes that are proper and in accordance with all applicable laws, rules, and regulations, and all terms, precautions, practices, policies and guidelines Hohem has made and may make available. Hohem accepts no liability for damage, injury or any legal responsibility incurred directly or indirectly from the use of this product. The user shall observe safe and lawful practices including, but not limited to, those set forth in this document.

This document and all other collateral documents are subject to change at the sole discretion of Hohem. For up-to-date product information, visit [www.hohem.com](http://www.hohem.com) and click on the product page for this product.

## Hohem

Hohem Technology Co., Ltd

**Email:** [service@hohem.com](mailto:service@hohem.com)

**Website:** [www.hohem.com](http://www.hohem.com)

**Manufacturer:** Hohem Technology Co., Ltd



Connect us at  
**Facebook**

# Download APP—Hohem Joy For More Interesting Functions



\*Some features are disabled until Hohem Joy app is activated. Download the APP to register for free membership and one-year extended warranty.

\* Hohem Joy supports iOS 10.0 and Android 6.0 or later.

\* Search for 'Hohem Joy' in the App Store or Google Play and follow the instructions to install the app.

---

## Accessories List

Tripod\*1

Carry Case\*1

Type C Charging Cable\*1

User Manual\*1

Quick Start Guide\*1

# Product Overview

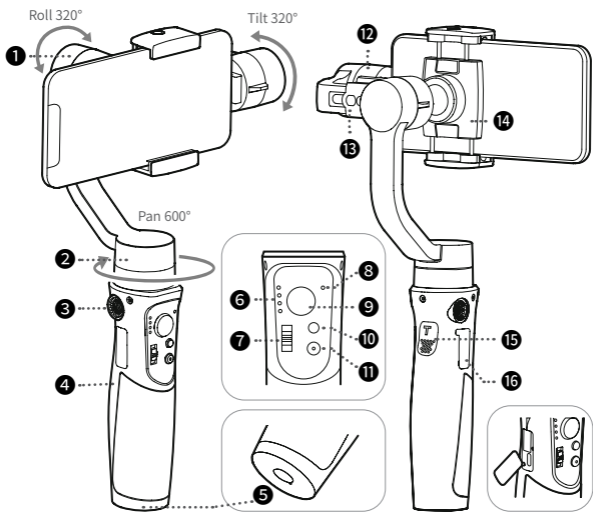

- 1 Roll Motor
- 2 Pan Motor
- 3 1/4 Inch Extension Screw Hole
- 4 Handle (Battery inside)
- 5 1/4 Inch Extension Screw Hole
- 6 Mode Indicator
- 7 Zoom/Focus Slider
- 8 Bluetooth Indicator
- 9 Joystick
- 10 Mode Button
- 11 ON/OFF (Shutter button)
- 12 Tilt Motor
- 13 Balancing Knob
- 14 Rotatable Phone Holder
- 15 Trigger
- 16 USB DC Out/ DC In

# Gimbal Charging



Charge the gimbal fully before using it for the first time.  
The battery takes approximately 2 hours to fully charge.

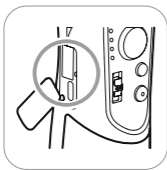

- \* **USB Port:** Power bank output
- \* **Type C Port:** Gimbal charging port

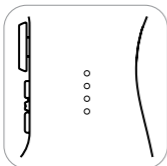

- \* **Tap the power button to check the battery status**

- Flickering:** Charging
- 4 LED lights on:** 100%, fully charged
- 3 LED lights on:** 75%
- 2 LED lights on:** 50%
- 1 LED light on:** 25%

## App "Hohem Joy" Bluetooth Connection

1. Enable the Bluetooth on the smartphone.
2. Launch the app 'Hohem Joy', click 'START' to enter the interface for photo taking and recording.  
(Please only enable the phone Bluetooth and connect Bluetooth in the app)

# Landscape Mode: Mounting and Balancing



\*Do not turn on the gimbal without roughly balanced and smartphone mounted on!

\*Highly recommended to remove the phone case before mounting your phone.

\*For increasing motor efficiency and stabilization, and saving gimbal battery life, you could roughly balance the gimbal before turning it on.

\*For smartphone with screen size bigger than 6.7 inches (e.g. iPhone 13 Pro Max), iSteady Mobile Plus can work well even without a perfect balancing before powering on.

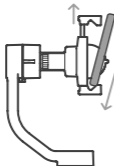

- 1** Pull the phone clamp and mount the phone.

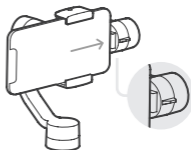

- 2** Push the phone to the rightmost to close to the motor.

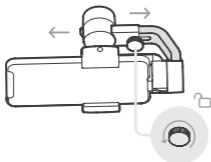

← Left

Small phone  
e.g. iPhone 13 mini

→ Right

Big phone  
e.g. iPhone 13 Pro Max

- 3** Loosen the knob, and slide the arm to balance the gimbal.

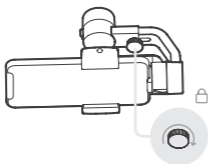

④ Tighten the knob.

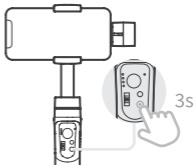

⑤ Long press the power button to power on.

\* **Max Payload:** 280g

\* **The width of phone clamp:** 58mm~89mm

## Portrait Mode: Mounting and Balancing



\*Please turn off the gimbal first, then rotate the phone clamp and mount the phone.

\*Do not turn on the gimbal without roughly balanced and smartphone mounted on!

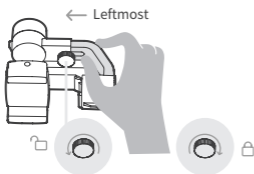

① Loosen the knob, slide the arm to the leftmost and tighten the knob.

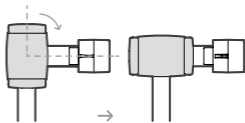

② Rotate the phone clamp 90 degrees

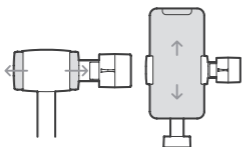

③ Pull the phone clamp and mount the phone. Adjust the phone up or down to roughly balance the gimbal.

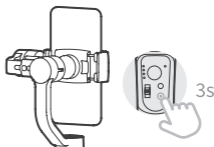

④ Make the phone roughly balance, and long press the power button to power on.

### Quick Switch to Portrait Mode

Rotate the handle to automatically switch to portrait mode

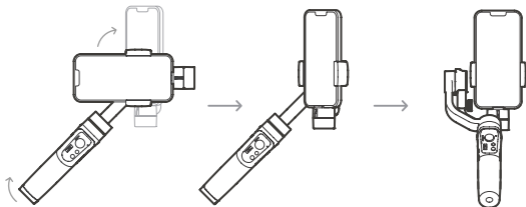

\*After you switch to the portrait mode, the joystick only control the phone to rotate left and right.



The following do not support quick switch:

1. In POV mode
2. When the handle is perpendicular
3. When the app setting of left/right joystick is roll



# Operation Instruction

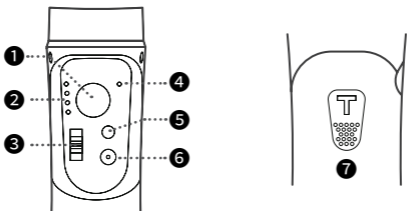

## 1 Joystick

**Push Up/Down**

Tilt Control

**Push Left/Right**

Pan Control

## 2 Mode Indicator

**PF:** Pan Follow

**PTF:** Pan & Tilt Follow

**L:** All Locked

**POV:** All Follow & Inception

## 3 Slider

Focus/Zoom in & out (Only available in the app)

## 4 Bluetooth Indicator

**Soild green:** Gimbal is connected with phone Bluetooth

**Soild red:** Gimbal abnormality

**Flashing red:** 1.Low battery (auto shutdown) 2.Overload (beep warning)

**Yellow light:** Remote control\* operation

**Light off:** Gimbal is disconnected with phone Bluetooth

\*Remote control is non standard purchase. For remote control pairing and instructions please see the user manual of remote control.

## 5 Mode Button

**Single press:** Switch mode

**Triple press:** 600° Auto inception

(press mode button to stop the rotation)

**Press five times:** Auto calibration

## 6 Power On/Off (Long press for 3 seconds)

**Single press:** Take photo, Start/End video

**Double press:** Switch photo/video modes (Only available in the app)

**Triple press:** Switch front/rear cameras (Only available in the app)

## 7 Trigger Button

**Press on:** Sport mode

**Press once, and then press and hold:** L (All locked)

**Double press:** Recenter the gimbal

# Gimbal Mode Button

Tap the button to switch different working modes with light on.

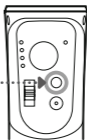

## PF (Pan Follow)

Default mode, tilt & roll axis both locked, camera is able to move to left or right smoothly.

---



## PTF (Pan & Tilt Follow)

Roll axis locked, camera is able to move to left/right, and tilt up/down.

---



## L (All Locked)

The camera stays in its current orientation.

---



## POV (All Follow & Inception)

**All Follow** - Tilt axis, roll axis and pan axis all follow the movement of the gimbal.

**Inception** - Hold the gimbal horizontally and push joystick to left or right.

---

# Auto Calibration

\*Auto calibration could reduce drift caused by nearby magnetic interference or human error.

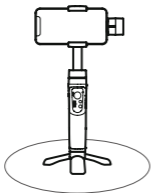

- 1 Place gimbal on a **flat** surface using a tripod.

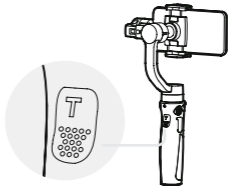

- 2 **Double** press the trigger button to recenter the gimbal.



- 3 Press mode button **five times** to start the auto calibration. Please do not touch the gimbal during calibration.

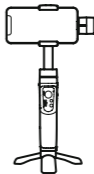

- 4 **Two beeps** indicate that the calibration is completed, the gimbal will recenter and automatically return to normal operation.



\*If the gimbal is not placed on a flat surface for calibration (e.g. hand-held calibration in the car), it may cause calibration failure.

\*When the calibration fails, the gimbal will make a beep sound, all 4 mode lights flash and enter the sleep mode. Single press any button (except the joystick) to wake up the gimbal and follow the above steps to try again.

# FAQ

## **Q: Why does the gimbal vibrate after powering on?**

A:

1. Make sure to mount the mobile phone before powering on the gimbal.
2. When mounting the phone, please keep the bottom of the phone close to the motor.
3. Highly recommended to remove the phone case before mounting your phone, especially for big phones such as iPhone 13 Pro Max.
4. If the mobile phone is too heavy or too light, adjust the motor power through the app (Hohem Joy-Settings-Motor response).
5. Please refer to 'Auto calibration' to calibrate the gimbal.

## **Q: Why does the gimbal not work properly, and all 4 mode lights are flashing?**

A:

When you hold the upper part of the gimbal (e.g. motor or arm), it may cause gimbal enter the sleep mode due to the protection of the motor. Single press any button (except the joystick) to wake up the gimbal, and only hold the handle during use.

## Q: Why the phone app cannot be connected with the gimbal via Bluetooth?

1. Enable phone Bluetooth (Enable ONLY)
2. Turn on the gimbal
3. Launch Hohem Joy app
4. Connect Bluetooth in the app through pop-up prompt or Bluetooth search interface  
(Device name is "iM5-xxxxxx")
5. Click the device to connect

### **(Important! The Bluetooth has to connect in the app!)**

\*If the connection fails, please exit the app, restart the Bluetooth, follow the above steps and try again.

### **Delete all paired Bluetooth devices**

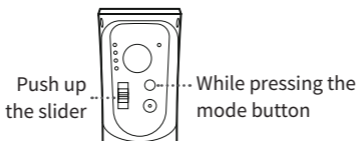

\*Or delete all paired Bluetooth devices: Push up the slider while pressing the mode button, Bluetooth light flashes green for 5 times, and then try again.

\*For some Android phones Bluetooth connection:

1. Android needs to turn on the location service;
2. Allow location permissions for the app;

# Specifications

---

<b>Weight</b>	474g include battery
<b>Main Material</b>	High performance composite
<b>Payload</b>	280g
<b>Mobile Width Supported</b>	58mm~89mm
<b>Battery Capacity</b>	1800mAh 7.4V 13.32Wh
<b>Battery Life</b>	Up to 13 hours (Under ideal conditions with the gimbal fully balanced)
<b>Charging Time</b>	2 hours (5V 2A)
<b>Mechanical Range</b>	Panning: 600° Rolling: 320° Tilting: 320°
<b>Working Temperature</b>	-10~45° C
<b>Motors Protection</b>	Gimbal will be powered off automatically due to improper operation of motors
<b>Standard Accessories</b>	Tripod, Carry case, Type C Charging Cable User Manual, Quick Start Guide

---

# 01 Install Magnetic Fill Light

It is not only used on the stabilizer, but also can be magnetically mounted on any iron surface and works independently.

a. Install on Gimbal (For the gimble with metal plate, eg, hohem XE)

Keep the logo "**hohem**" upwards, attach the fill light to the magnetic alignment

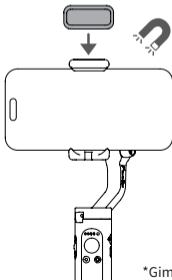

\*Gimbal Not Included

## b. Install Metal Plate

Stick the metal plate on a clean surface after removing the protected film, and put magnetic fill light on the metal plate.



## 02 How the Magnetic Fill Light Works

Cold Light / Warm Light / Natural White Light (10-Level Adjustable Brightness)

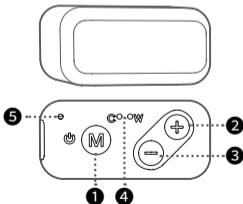



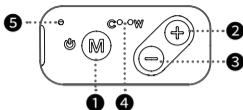

### ❶ M Button (Turn on/off fill light)

**Press and hold for 3s:** Turn on/off fill light

**Press once:** Cold/warm/natural white light switch

### ❷ Plus "+" Button

Single press to increase brightness in ten levels

### ❸ Minus "-" Button

Single press to decrease brightness in ten levels

### ❹ Fill Light Indicator

("C" is short for cold; "W" is short for warm.)

**C indicator lighting alone:** Cold light in use

**W indicator lighting alone:** Warm light in use

**C&W indicators both lighting:** Natural white light in use

### ⑤ Power Indicator

**Flashing red:** Charging

**Solid red:** Fully Charged

## 03 Specifications

---

Model	ML-01
-------	-------

---

Weight	16g
--------	-----

---

Battery Capacity	3.7V / 300mAh
------------------	---------------

---

Power	1W
-------	----

---

Battery Life	1 Hour
--------------	--------

---

Lights	Cold Light (6500k) Warm Light (3000k) Natural White Light (5500k)
--------	---

---

# Warranty Terms

1. Within 15 days upon the purchase date. Any functional disorder or quality problem enjoys free replacement service. But ensure the commodity and package with no damage, and we will offer a brand new replacement after confirming the product problem.
2. Warranty valid only under normal use.
3. Used in the normal circumstances, 1 year warranty, maintenance of life (not include the All accidents or artificial damage, improper disassembly or misuse damage is NOT covered by the warranty).
4. Please keep and offer the warranty card for claiming the warranty service.

## CALL CENTER -Toll Free

### UNITED STATES:

+1(888)9658512

Mon-Fri: 9:00AM-5:00PM(EST)

---

### UNITED KINGDOM:

+44(0)808 2737578

Mon-Fri: 2:00PM-10:00PM(GMT +0)

---

### CANADA:

+1(855)758-8939

Mon-Fri: 9:00AM-5:00PM(EST)

---

### BRAZIL:

+55 (0)800 5911897

Mon-Fri: 10:00AM-6:00PM(GMT -3)

# Warranty Card

User Name:

---

Contact No.:

---

Address:

---

Purchase Date:

---

Prod. Serial No.:

---

Failure Cause:

---

Service Record:

---

## Federal Communication Commission (FCC) Radiation Exposure Statement

The device has been evaluated to meet general RF exposure requirement, The device can be used in portable exposure condition without restriction Federal Communication Commission (FCC) Radiation.

This device complies with part 15 of the FCC rules. Operation is subject to the following two conditions: (1) this device may not cause harmful interference, and (2) this device must accept any interference received, including interference that may cause undesired operation.

NOTE: The manufacturer is not responsible for any radio or TV interference caused by unauthorized modifications or changes to this equipment. Such modifications or changes could void the user's authority to operate the equipment.

NOTE: This equipment has been tested and found to comply with the limits for a Class B digital device, pursuant to part 15 of the FCC Rules. These limits are designed to provide reasonable protection against harmful interference in a residential installation. This equipment generates uses and can radiate radio frequency energy and, if not installed and used in accordance with the instructions, may cause harmful interference to radio communications. However, there is no guarantee that interference will not occur in a particular installation. If this equipment does cause harmful interference to radio or television reception, which can be determined by turning the equipment off and on, the user is encouraged to try to correct the interference by one or more of the following measures:

- Reorient or relocate the receiving antenna.
- Increase the separation between the equipment and receiver.
- Connect the equipment into an outlet on a circuit different from that to which the receiver is connected.
- Consult the dealer or an experienced radio/TV technician for help.

FCC Caution: Any changes or modifications not expressly approved by the party responsible for compliance could void the user's authority to operate this equipment.

### IC Statement:

This device complies with Industry Canada license-exempt RSS standard(s). Operation is subject to the following two conditions:

- (1) this device may not cause interference, and
- (2) this device must accept any interference, including interference that may cause undesired operation of the device .

Le pr é sent appareil est conforme aux CNR d'Industrie Canada applicables aux appareils radio exempts de licence. L'exploitation est autoris é e aux deux conditions suivantes :

- (1) l'appareil ne doit pas produire de brouillage, et
- (2) l'utilisateur de l'appareil doit accepter tout brouillage radio é lectrique subi, m ê me si le brouillage est susceptible d'en compromettre le fonctionnement.

The product comply with the Canada portable RF exposure limit set forth for an uncontrolled environment and are safe for intended operation as described in this manual. The further RF exposure reduction can be achieved if the product can be kept as far as possible from the user body or set the device to lower output power if such function is available.

### D é claracion d'exposition aux radiations:

Le produit est conforme aux limites d'exposition pour les appareils portables RF pour les Etats-Unis et le Canada é tablies pour un environnement non contr ô l é .

Le produit est sûr pour un fonctionnement tel que d é crit dans ce manuel. La r é duction aux expositions RF peut é tre augment é e si l'appareil peut é tre conserv é aussi loin que possible du corps de l'utilisateur ou que le dispositif est r é gl é sur la puissance de sortie la plus faible si une telle fonction est disponible.

Bluetooth: 2404-2480MHz

EIRP.(MAX):-8.15dBm

Model Name: iSM5K, iSM5, iSteady Mobile+ Kit, iSteady Mobile+