



femometer

User manual



TABLE OF CONTENTS

- 1 Who Should Use Femometer
- 2 How to Use Femometer
- 3 Alerts & Sounds
- 4 Troubleshooting
- 5 Product Maintenance & Care
- 6 Technical Specifications
- 7 Product Functions & Features

- 8 Safety Statement
- 9 Disclaimer
- 10 Copyright Statement
- 11 Warranty
- 12 Symbol Key
- 13 FCC Statement
- 14 Record of Purchase

1. WHO SHOULD USE FEMOMETER

This product should be used by women to measure basal body temperature.

2. HOW TO USE FEMOMETER

1 Download App

Scan the QR code to download. Or search "femometer" on Apple Store and Google play to download.



2 Pair Femometer with your smartphone

Step 1: Turn on your phone's Bluetooth.

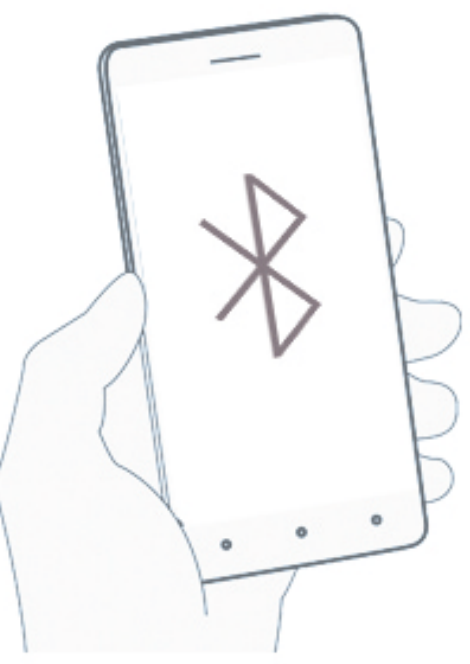

Step 2: Open the femometer application, sign up an account.



Step 3: Remove the cap from Femometer.

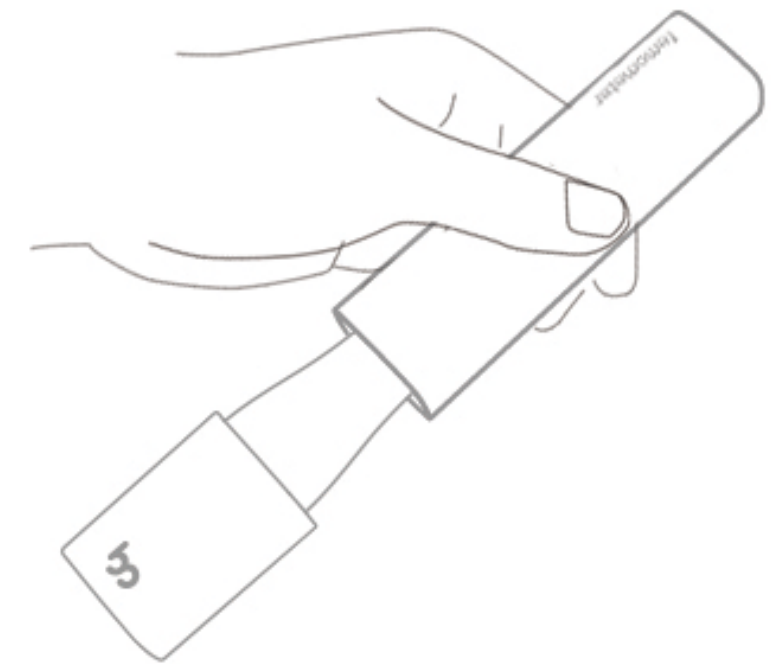

Step 4: Tap the button "Pair My Femometer" in the application



Step 5: Take the femometer close to the phone, build the connection.

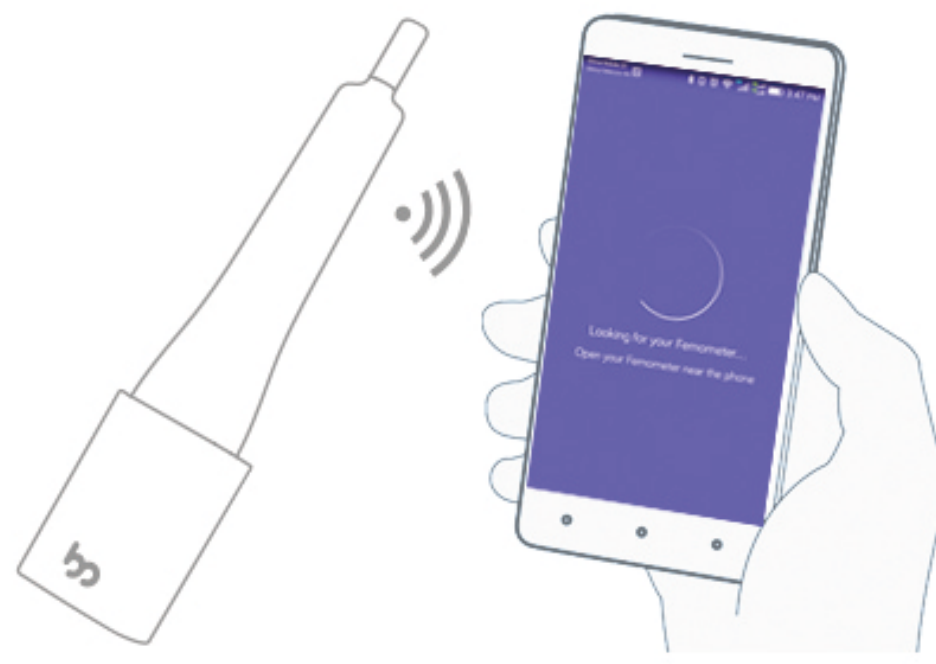

Step 6: Take the femometer close to the phone, build the connection.

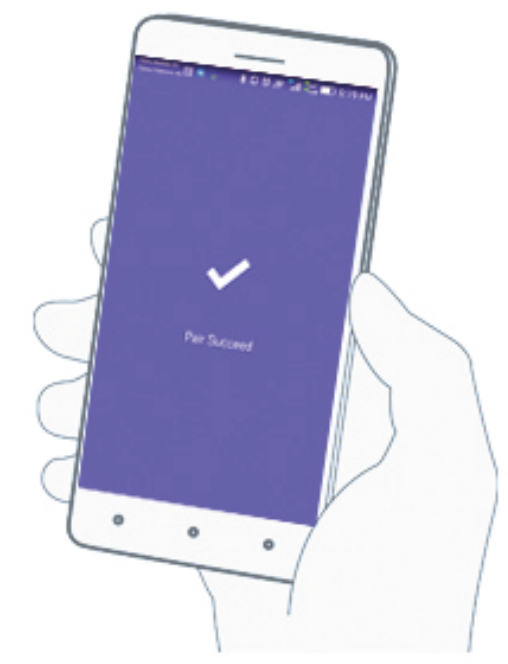

3 Take Your Temperature

Step 1: Set a reminder on your phone to wake up and take your temperature each morning.



Step 2: Upon waking, remove Femometer from its case, place it under your tongue and hold it there for at least 3 minutes, until you hear 3 beeps, indicating temperature has been taken.



Step 3: Open the application, the data will be transmitted automatically.



4 Replace the Battery

Step 1: Insert the stainless steel tool into the crevice at the base of Femometer, gently pry open the battery tray.

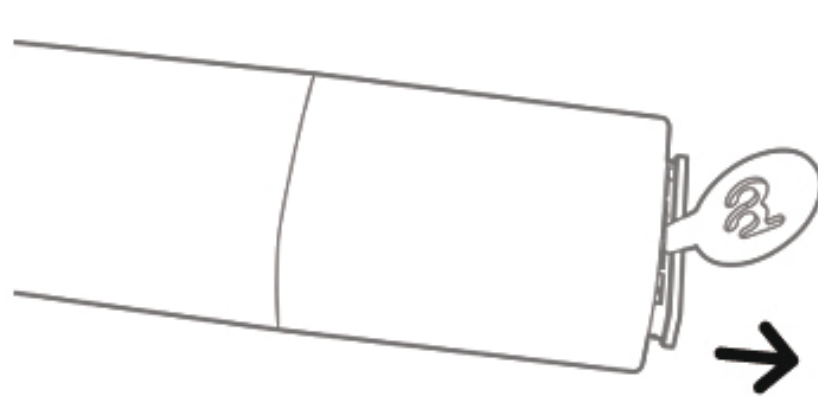

Step 2: Place the CR1632 battery into the battery tray.

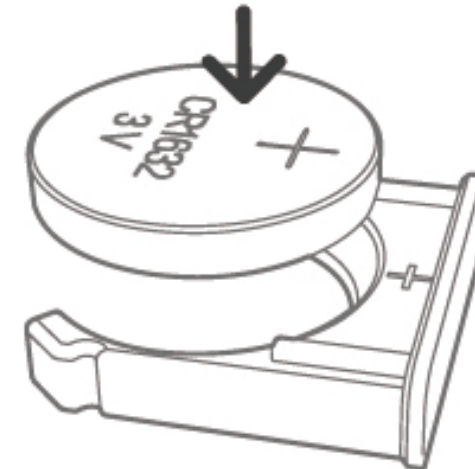

Step 3: Close the tray from the base of the Femometer.



5 Upload Data to the App

Step 1: Once your temperature has been taken, keep Bluetooth on your phone turned on so the data can be transmitted from Femometer to your phone.

Step 2: The data from Femometer should sync automatically to the Femometer app. If the data does not sync, remove the cap from Femometer and tap the "sync" button in the Femometer app to transmit the data.

3. ALERTS & SOUNDS

- When you remove Femometer from the case, a single beep indicates that it is on.
- When you close the case, a single beep indicates that Femometer is off.
- When taking your temperature, 3 consecutive beeps indicate that the measurement is complete.
- A beep lasting longer than 2 seconds indicates an error. please close the case and reopen Femometer until measurement is complete.

4. TROUBLESHOOTING

| Symptoms | Possible reasons | Solutions |
|---|---|---|
| Do not hear the end tone when the Femometer is under the tongue | Femometer is off | Close the cover and reopen it to restart the Femometer |
| | Measurement time is too short | Keep measuring for 3-5 minutes |
| | Button battery has run out | Replace the button battery |
| The data has not been synced to the app after the measurement | The Bluetooth is not open | Open the Bluetooth on the phone |
| | The phone is too far to sync | Put the phone close to the Femometer |
| There is no sound when the Femometer is open | Button battery has run out or the Femometer is broken | Replace the button battery and if the Femometer still makes no sound, the Femometer is broken |

5. PRODUCT MAINTENANCE & CARE

1. Battery care

- Replace the battery when instructed via notification in the Femometer app.
- Always dispose of used batteries according to local laws and regulations.

2. Cleaning & Disinfection

- Clean the tip of Femometer with a solution of 75% rubbing alcohol and 25% water before and after every use.
- Do not use cleaning agents other than alcohol and water to clean the device as it may damage or decrease the lifetime of the product and/or present safety risks.

- Never submerge the device in water – this can damage the device and result in erroneous data.

6. TECHNICAL SPECIFICATIONS

| | | |
|--|---|--|
| Product name Femometer | Transmission distance Up to 16 feet | Receiver Apple devices: iPhone 5+, iOS 8.0+ |
| Model FM-101BT | Measurement 89.6°F–107.6°F | Android devices: with 4.3+ system and Bluetooth 4.0 |
| Size 108.7mmx22.2mmx16.2mm | Accuracy ±0.09°F (From 95.0°F to 100.4°F) ±0.18°F (From 89.6°F to 95°F) & (From 100.4°F to 107.6°F) | Battery endurance 3–6 months |
| Weight 17g (without battery) | Battery CR1632 | Operating conditions Temperature: 41°F–104°F |

7. PRODUCT FUNCTIONS & FEATURES

1. Basal body temperature measurement & Bluetooth

- Femometer measures basal body temperature to .09 degrees Fahrenheit accuracy. Your basal body temperature is automatically uploaded to your phone via Bluetooth, which is fast and energy-efficient, and represented via temperature charts and graphs to track and make predictions about your menstrual cycle.

2. Data stored in the cloud

- All your data is stored in the cloud, so you don't have to worry about manually uploading or losing your information. You can also sync Femometer to different devices.

3. Share data with friends

- Share your data easily with your partner or doctor directly from the Femometer app via Twitter or Facebook.

8. SAFETY STATEMENT

1. The EMC of the product is up to standard of IEC60601-1-2.
2. The material that contacts skin is nontoxic, nonirritating and up to standard of ISO10993-1,-5,-10.

9. DISCLAIMER

- This manual is written in accordance with available information and contents are subject to change without notice. Bongmi has made the best effort to guarantee the manual's accuracy and reliability. However, the company does not assume liability for loss or damage caused by omissions, inaccuracies or typographical errors in this manual.

- If there are discrepancies in this manual due to software upgrades, instructions and function dictated by the software should prevail. If improvements are made to the product or the product technology changes, please visit Bongmi's technical support website for further information.

- All symbols and logos associated with Bluetooth, including the Bluetooth word mark, figure mark, combination mark and Bluetooth Smart and Bluetooth ready marks, are all trademarks owned by the Bluetooth SIG. Any use of such marks by Bongmi is under license. Other trademarks and trade names used belong to their respective owners.

10 COPYRIGHT STATEMENT







- BONGMI INC. reserves all rights, and retains the final right to interpret and revise this handbook and the statements contained therein. Copyright of this manual belongs to BONGMI INC. Without prior written permission, no company or individual is allowed to reproduce, copy or translate this many or any information contained therein.

- BONGMI INC.
767 6th Ave Apt 5, San Francisco, CA 94118

11 WARRANTY

- This product is warranted from manufacturing defects for one year from the date of retail purchase. It does not cover damages or wear resulting from accident, misuse, abuse, commercial use or unauthorized adjustment and repair of product. Please direct all returns to the place of original purchase and retain your original receipt, as you may be asked to provide a copy for proof of purchase. To find the customer service menu, please visit our company website at www.bongmi.com.

12 SYMBOL KEY

-  Device type is BF
-  Serial number
-  Read user manual before use
-  Manufacturer
-  No littering
-  Recyclables

13 FCC STATEMENT

- This device complies with Part 15 of the FCC Rules. Operation is subject to the following two conditions:
(1) This device may not cause harmful interference, and
(2) This device must accept any interference received, including interference that may cause undesired operation.

- Please take attention that changes or modification not expressly approved by the party responsible for compliance could void the user's authority to operate the equipment. Note: This product has been tested and found to comply with the limits for a Class B digital device, pursuant to Part 15 of the FCC Rules. These limits are designed to provide reasonable protection against harmful interference in a residential installation.

10 COPYRIGHT STATEMENT

- This product generates, uses, and can radiate radio frequency energy and, if not installed and used in accordance with the instructions, may cause harmful interference to radio communications. However, there is no guarantee that interference will not occur in a particular installation. If this product does cause harmful interference to radio or television reception, which can be determined by turning the equipment off and on, the user is encouraged to try to

- to correct the interference by one or more of the following measures:
—Reorient or relocate the receiving antenna.
—Increase the separation between the equipment and receiver.
—Connect the equipment into an outlet on a circuit different from that to which the receiver is connected.
—Consult the dealer or an experienced radio/TV technician for help.

14 PURCHASING RECORD

Model Purchased: FM-101-BT

Name: _____

Serial Number: _____

Phone number: _____

Data of Purchase: _____

Email Address: _____