

FCC RF Test Report

APPLICANT : Texas Instruments Incorporated
EQUIPMENT : WiFi and Bluetooth Module
BRAND NAME : Texas Instruments
MODEL NAME : WL18MODGB
FCC ID : Z64-WL18SBMOD
STANDARD : FCC Part 15 Subpart C §15.247
CLASSIFICATION : (DSS) Spread Spectrum Transmitter

The product was received on Nov. 27, 2013 and testing was completed on Dec. 12, 2013. We, SPORTON INTERNATIONAL INC., would like to declare that the tested sample has been evaluated in accordance with the procedures and shown to be compliant with the applicable technical standards.

The test results in this report apply exclusively to the tested model / sample. Without written approval of SPORTON INTERNATIONAL INC., the test report shall not be reproduced except in full.



Reviewed by: Joseph Lin / Supervisor

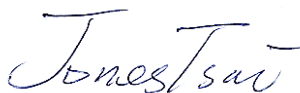

Approved by: Jones Tsai / Manager



SPORTON INTERNATIONAL INC.

No. 52, Hwa Ya 1st Rd., Hwa Ya Technology Park, Kwei-Shan Hsiang, Tao Yuan Hsien, Taiwan, R.O.C.



TABLE OF CONTENTS

REVISION HISTORY.....3

SUMMARY OF TEST RESULT4

1 GENERAL DESCRIPTION.....5

 1.1 Applicant5

 1.2 Manufacturer.....5

 1.3 Feature of Equipment Under Test5

 1.4 Product Specification of Equipment Under Test.....5

 1.5 Modification of EUT6

 1.6 Testing Site.....6

 1.7 Applied Standards6

2 TEST CONFIGURATION OF EQUIPMENT UNDER TEST.....7

 2.1 Descriptions of Test Mode7

 2.2 Test Mode.....8

 2.3 Connection Diagram of Test System.....9

 2.4 Support Unit used in test configuration and system10

 2.5 EUT Operation Test Setup10

 2.6 Measurement Results Explanation Example.....10

3 TEST RESULT11

 3.1 Number of Channel Measurement11

 3.2 Hopping Channel Separation Measurement13

 3.3 Dwell Time Measurement.....20

 3.4 20dB and 99% Bandwidth Measurement23

 3.5 Peak Output Power Measurement36

 3.6 Conducted Band Edges Measurement.....38

 3.7 Conducted Spurious Emission Measurement45

 3.8 Radiated Band Edges and Spurious Emission Measurement55

 3.9 AC Conducted Emission Measurement.....66

 3.10 Antenna Requirements.....70

4 LIST OF MEASURING EQUIPMENT.....71

5 UNCERTAINTY OF EVALUATION.....72

APPENDIX A. SETUP PHOTOGRAPHS



REVISION HISTORY

REPORT NO.	VERSION	DESCRIPTION	ISSUED DATE
FR3N2752-01A	Rev. 01	Initial issue of report	Jan. 27, 2014



SUMMARY OF TEST RESULT

Report Section	FCC Rule	IC Rule	Description	Limit	Result	Remark
3.1	15.247(a)(1)	RSS-210 A8.4(2)	Number of Channels	≥ 15Chs	Pass	-
3.2	15.247(a)(1)	RSS-210 A8.1(b)	Hopping Channel Separation	≥ 2/3 of 20dB BW	Pass	-
3.3	15.247(a)(1)	RSS-210 A8.1(d)	Dwell Time of Each Channel	≤ 0.4sec in 31.6sec period	Pass	-
3.4	15.247(a)(1)	RSS-210 A8.1(a)	20dB Bandwidth	NA	Pass	-
3.4	-	RSS-Gen 4.6.1	99% Bandwidth	-	Pass	-
3.5	15.247(b)(1)	RSS-210 A8.1(b)	Peak Output Power	≤ 125 mW	Pass	-
3.6	15.247(d)	RSS-210 A8.5	Conducted Band Edges	≤ 20dBc	Pass	-
3.7	15.247(d)	RSS-210 A8.5	Conducted Spurious Emission	≤ 20dBc	Pass	-
3.8	15.247(d)	RSS-210 A8.5	Radiated Band Edges and Radiated Spurious Emission	15.209(a) & 15.247(d)	Pass	Under limit 1.46 dB at 42.960 MHz
3.9	15.207	RSS-Gen 7.2.4	AC Conducted Emission	15.207(a)	Pass	Under limit 8.50 dB at 0.350 MHz
3.10	15.203 & 15.247(b)	RSS-210 A8.4	Antenna Requirement	N/A	Pass	-

1 General Description

1.1 Applicant

Texas Instruments Incorporated
 12500 TI Boulevard, M/S 8751, Dallas, TX 75243, USA

1.2 Manufacturer

Jorjin Technologies Inc.
 17F., No. 239, Sec. 1, Datong Rd., Xizhi Dist. New Taipei City 221, Taiwan. R.O.C.

1.3 Feature of Equipment Under Test

Product Feature	
Equipment	WiFi and Bluetooth Module
Brand Name	Texas Instruments
Model Name	WL18MODGB
FCC ID	Z64-WL18SBMOD
EUT supports Radios application	WLAN 11b/g/n HT20/HT40 Bluetooth v3.0 + EDR Bluetooth v4.0 + LE
EUT Stage	Production Unit

Remark: The above EUT's information was declared by manufacturer. Please refer to the specifications or user's manual for more detailed description.

1.4 Product Specification of Equipment Under Test

Product Specification subjective to this standard	
Tx/Rx Frequency Range	2402 MHz ~ 2480 MHz
Number of Channels	79
Carrier Frequency of Each Channel	2402+n*1 MHz; n=0~78
Maximum Output Power to Antenna	Bluetooth BR(1Mbps) : 12.39 dBm (0.0173 W) Bluetooth EDR (2Mbps) : 9.75 dBm (0.0094 W) Bluetooth EDR (3Mbps) : 10.17 dBm (0.0104 W)
99% Occupied Bandwidth	Bluetooth BR(1Mbps) : 0.840MHz Bluetooth EDR (2Mbps) : 1.180MHz Bluetooth EDR (3Mbps) : 1.188MHz
Antenna Type	Chip Antenna type with gain -0.36 dBi
Type of Modulation	Bluetooth BR (1Mbps) : GFSK Bluetooth EDR (2Mbps) : $\pi/4$ -DQPSK Bluetooth EDR (3Mbps) : 8-DPSK



1.5 Modification of EUT

No modifications are made to the EUT during all test items.

1.6 Testing Site

Test Site	SPORTON INTERNATIONAL INC.			
Test Site Location	No. 52, Hwa Ya 1 st Rd., Hwa Ya Technology Park, Kwei-Shan Hsiang, Tao Yuan Hsien, Taiwan, R.O.C. TEL: +886-3-3273456 / FAX: +886-3-3284978			
Test Site No.	Sporton Site No.			FCC/IC Registration No.
	TH02-HY	CO05-HY	03CH07-HY	722060/4086B-1

Note: The test site complies with ANSI C63.4 2003 requirement.

1.7 Applied Standards

According to the specifications of the manufacturer, the EUT must comply with the requirements of the following standards:

- FCC Part 15 Subpart C §15.247
- FCC Public Notice DA 00-705
- ANSI C63.4-2003

Remark:

1. All test items were verified and recorded according to the standards and without any deviation during the test.
2. This EUT has also been tested and complied with the requirements of FCC Part 15, Subpart B, recorded in a separate test report.

2 Test Configuration of Equipment Under Test

2.1 Descriptions of Test Mode

Preliminary tests were performed in different data rates and recorded the RF output power in the following table:

Channel	Frequency	Bluetooth RF Output Power		
		Data Rate / Modulation		
		GFSK	$\pi/4$ -DQPSK	8-DPSK
		1Mbps	2Mbps	3Mbps
Ch00	2402MHz	12.39 dBm	9.75 dBm	10.17 dBm
Ch39	2441MHz	12.39 dBm	9.29 dBm	9.84 dBm
Ch78	2480MHz	12.39 dBm	8.96 dBm	9.54 dBm

Remark:

1. All the test data for each data rate were verified, but only the worst case was reported.
 2. The data rate was set in 1Mbps for all the test items due to the highest RF output power.
- a. The EUT has been associated with peripherals and configuration operated in a manner tended to maximize its emission characteristics in a typical application. Frequency range investigated: conduction (150 kHz to 30 MHz), radiation (9 kHz to the 10th harmonic of the highest fundamental frequency or to 40 GHz, whichever is lower).
 - b. AC power line Conducted Emission was tested under maximum output power.

2.2 Test Mode

The following summary table is showing all test modes to demonstrate in compliance with the standard.

Summary table of Test Cases			
Test Item	Data Rate / Modulation		
	Bluetooth BR 1Mbps GFSK	Bluetooth EDR 2Mbps $\pi/4$ -DQPSK	Bluetooth EDR 3Mbps 8-DPSK
Conducted Test Cases	Mode 1: CH00_2402 MHz	Mode 4: CH00_2402 MHz	Mode 7: CH00_2402 MHz
	Mode 2: CH39_2441 MHz	Mode 5: CH39_2441 MHz	Mode 8: CH39_2441 MHz
	Mode 3: CH78_2480 MHz	Mode 6: CH78_2480 MHz	Mode 9: CH78_2480 MHz
Radiated Test Cases	Bluetooth BR 1Mbps GFSK		
	Mode 1: CH00_2402 MHz		
	Mode 2: CH39_2441 MHz		
	Mode 3: CH78_2480 MHz		
AC Conducted Emission	Mode 1 :WLAN Link + Bluetooth Link + Adapter		
<p>Remark: For radiated test cases, the worst mode data rate 1Mbps was reported only, because this data rate has the highest RF output power at preliminary tests, and the conducted spurious emissions and conducted band edge measurement for each data rate are no worse than 1Mbps, and no other significantly frequencies found in conducted spurious emission.</p>			

2.3 Connection Diagram of Test System

<Bluetooth Tx Mode>

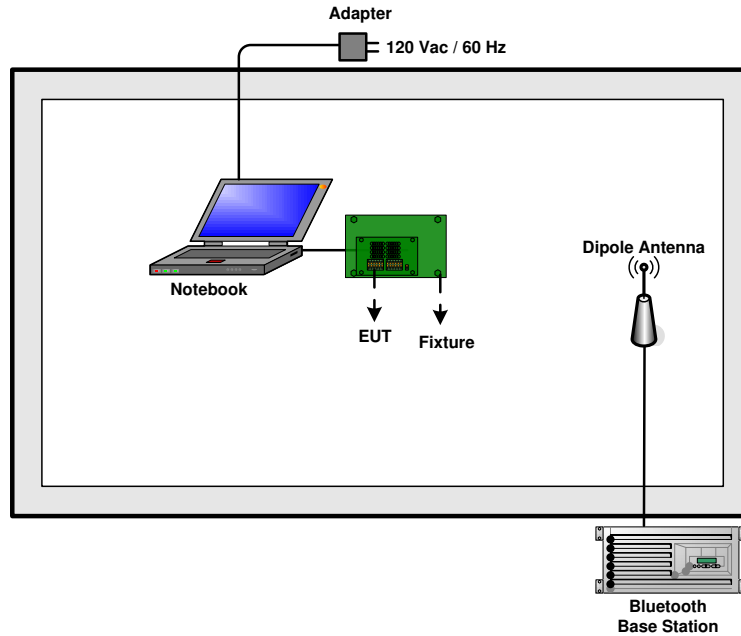

<AC Conducted Emission Mode>

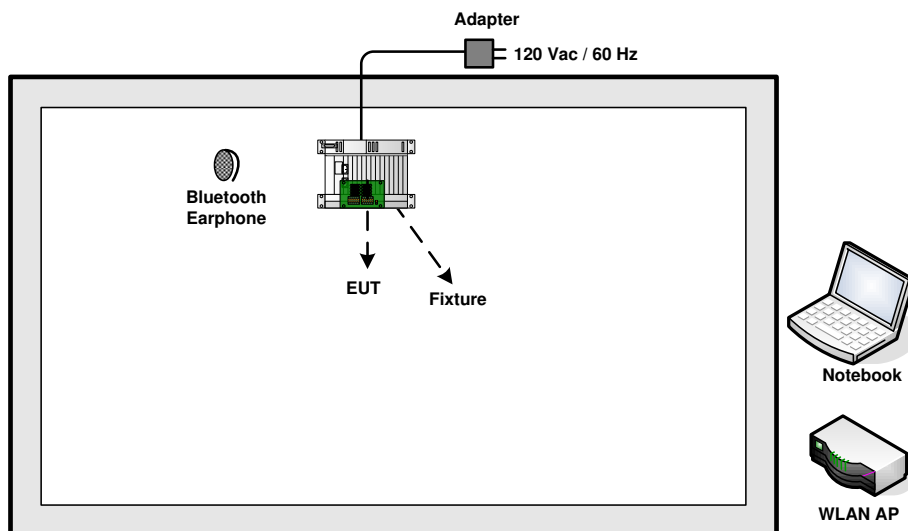

2.4 Support Unit used in test configuration and system

Item	Equipment	Trade Name	Model Name	FCC ID	Data Cable	Power Cord
1.	Bluetooth Base Station	R&S	CBT32	N/A	N/A	Unshielded, 1.8 m
2.	Bluetooth Earphone	SonyEricsson	MW600	PY700A2029	N/A	N/A
3.	WLAN AP	D-Link	DIR-628	KA2DIR628A2	N/A	Unshielded, 1.8 m
4.	Notebook	DELL	Vostro 1320	FCC DoC	N/A	AC I/P: Unshielded, 1.2 m DC O/P: Shielded, 1.8 m
5.	Notebook	DELL	Latitude E6320	FCC DoC	N/A	AC I/P: Unshielded, 1.2 m DC O/P: Shielded, 1.8 m
6.	Fixture	N/A	WG7XXX01	N/A	N/A	N/A
7.	Adapter	Aviv Energy	HK-IP15-A05	N/A	N/A	Unshielded, 1.8 m

2.5 EUT Operation Test Setup

For Bluetooth function, the RF utility, "HCT Tester" was installed in notebook which was programmed in order to make the EUT get into the engineering modes to contact with Bluetooth base station for continuous transmitting and receiving signals.

2.6 Measurement Results Explanation Example

For all conducted test items:

The offset level is set in the spectrum analyzer to compensate the RF cable loss and attenuator factor between EUT conducted output port and spectrum analyzer. With the offset compensation, the spectrum analyzer reading level is exactly the EUT RF output level.

Example:

The spectrum analyzer offset is derived from RF cable loss and attenuator factor.

Offset = RF cable loss + attenuator factor.

Following shows an offset computation example with cable loss 4.2 dB and 10dB attenuator.

Offset(dB) = RF cable loss(dB) + attenuator factor(dB).

$$= 4.2 + 10 = 14.2 \text{ (dB)}$$

3 Test Result

3.1 Number of Channel Measurement

3.1.1 Limits of Number of Hopping Frequency

Frequency hopping systems in the 2400-2483.5 MHz band shall use at least 15 channels.

3.1.2 Measuring Instruments

The measuring equipment is listed in the section 4 of this test report.

3.1.3 Test Procedure

1. The testing follows FCC Public Notice DA 00-705 Measurement Guidelines.
2. The RF output of EUT was connected to the spectrum analyzer by RF cable and attenuator. The path loss was compensated to the results for each measurement.
3. Set to the maximum power setting and enable the EUT transmit continuously.
4. Enable the EUT hopping function.
5. Use the following spectrum analyzer settings: Span = the frequency band of operation; RBW \geq 1% of the span; VBW \geq RBW; Sweep = auto; Detector function = peak; Trace = max hold.
6. The number of hopping frequency used is defined as the number of total channel.
7. Record the measurement data derived from spectrum analyzer.

3.1.4 Test Setup

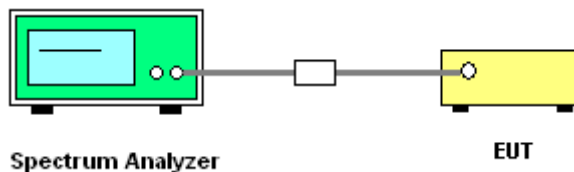

3.1.5 Test Result of Number of Hopping Frequency

Test Mode :	1Mbps	Temperature :	24-26°C
Test Engineer :	Alex Lee	Relative Humidity :	48-51%

Number of Hopping (Channel)	Adaptive Frequency Hopping (Channel)	Limits (Channel)	Pass/Fail
79	20	> 15	Pass



Number of Hopping Channel Plot on Channel 00 - 78

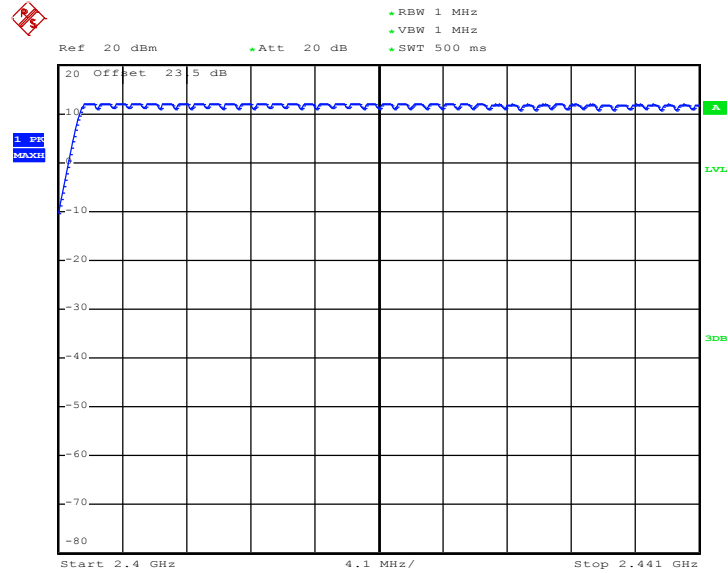

Date: 9.DEC.2013 23:48:29

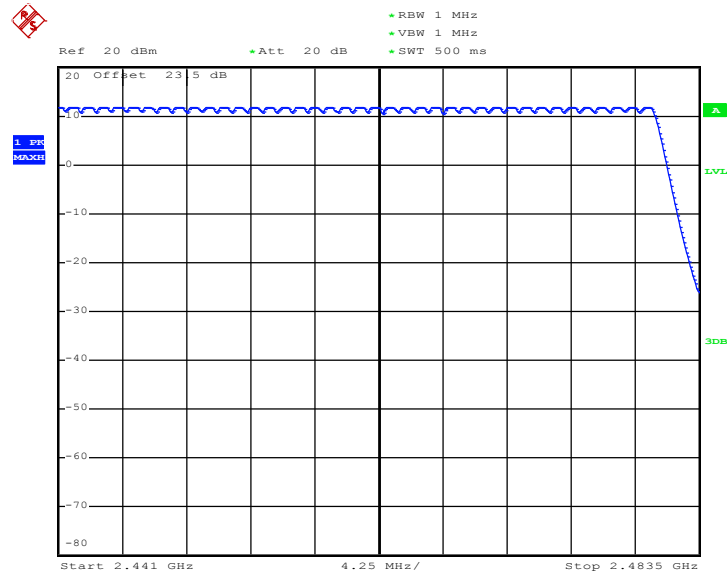

Date: 9.DEC.2013 23:50:40

3.2 Hopping Channel Separation Measurement

3.2.1 Limit of Hopping Channel Separation

Frequency hopping systems operating in the 2400-2483.5 MHz band may have hopping channel carrier frequencies that are separated by 25 kHz or two-thirds of the 20 dB bandwidth of the hopping channel, whichever is greater.

3.2.2 Measuring Instruments

The measuring equipment is listed in the section 4 of this test report.

3.2.3 Test Procedures

1. The testing follows FCC Public Notice DA 00-705 Measurement Guidelines.
2. The RF output of EUT was connected to the spectrum analyzer by RF cable and attenuator. The path loss was compensated to the results for each measurement.
3. Set to the maximum power setting and enable the EUT transmit continuously.
4. Enable the EUT hopping function.
5. Use the following spectrum analyzer settings:
Span = wide enough to capture the peaks of two adjacent channels; $RBW \geq 1\%$ of the span;
 $VBW \geq RBW$; Sweep = auto; Detector function = peak; Trace = max hold.
6. Measure and record the results in the test report.

3.2.4 Test Setup

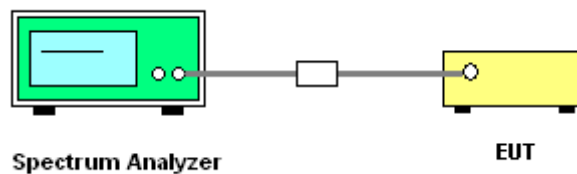



3.2.5 Test Result of Hopping Channel Separation

Test Mode :	1Mbps	Temperature :	24-26°C
Test Engineer :	Alex Lee	Relative Humidity :	48-51%

Channel	Frequency (MHz)	Frequency Separation (MHz)	(2/3 of 20dB BW) Limits (MHz)	Pass/Fail
00	2402	1.002	0.5467	Pass
39	2441	1.002	0.5440	Pass
78	2480	1.002	0.5440	Pass

Channel Separation Plot on Channel 00 - 01

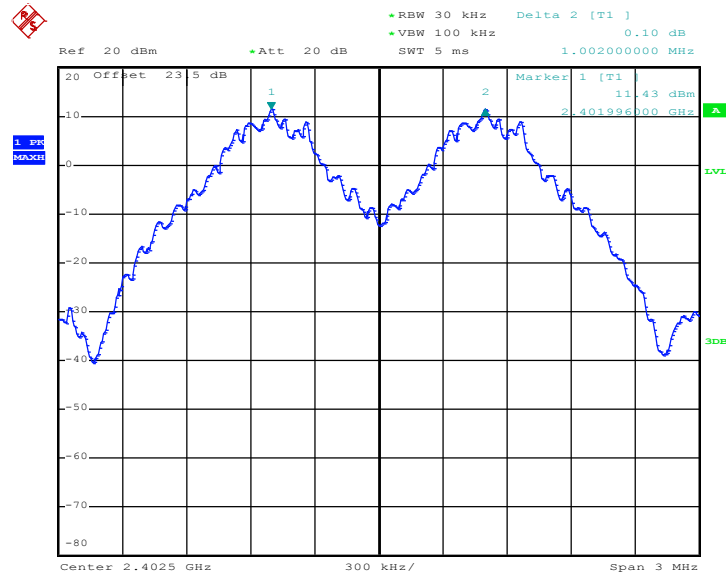

Date: 9.DEC.2013 23:40:17



Channel Separation Plot on Channel 39 - 40

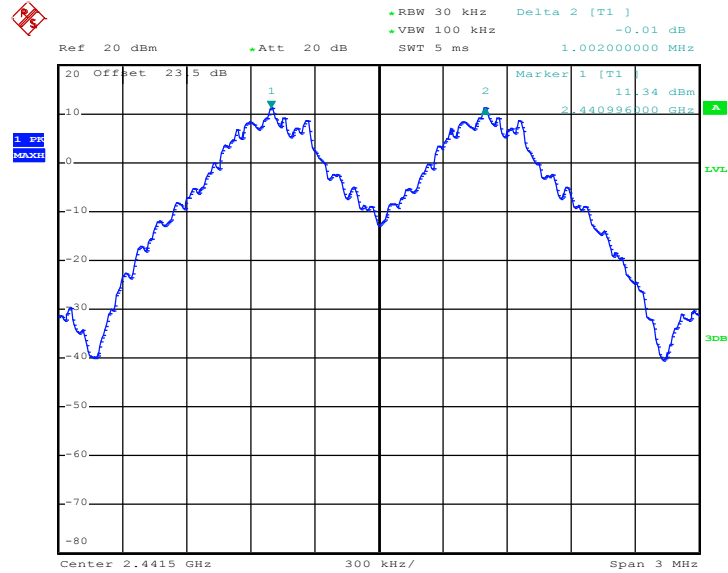

Date: 9.DEC.2013 23:58:12

Channel Separation Plot on Channel 77 - 78

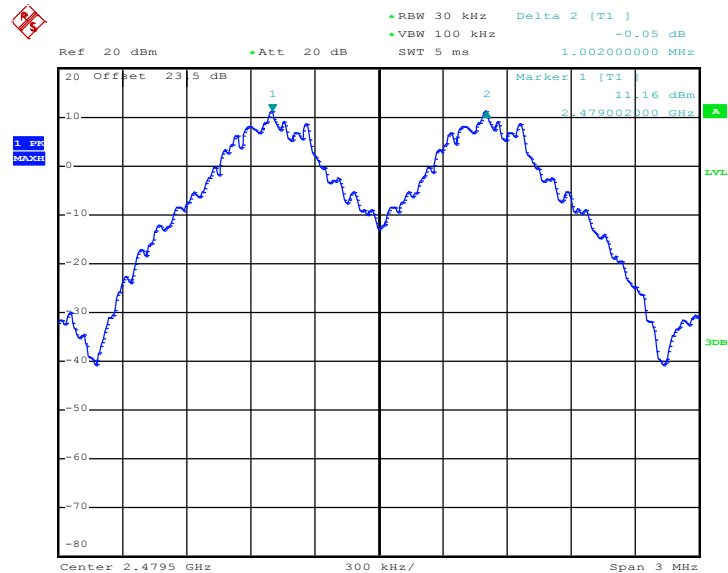

Date: 10.DEC.2013 00:08:17



Test Mode :	2Mbps	Temperature :	24-26°C
Test Engineer :	Alex Lee	Relative Humidity :	48-51%

Channel	Frequency (MHz)	Frequency Separation (MHz)	(2/3 of 20dB BW) Limits (MHz)	Pass/Fail
00	2402	1.002	0.8520	Pass
39	2441	1.002	0.8520	Pass
78	2480	1.002	0.8520	Pass

Channel Separation Plot on Channel 00 - 01

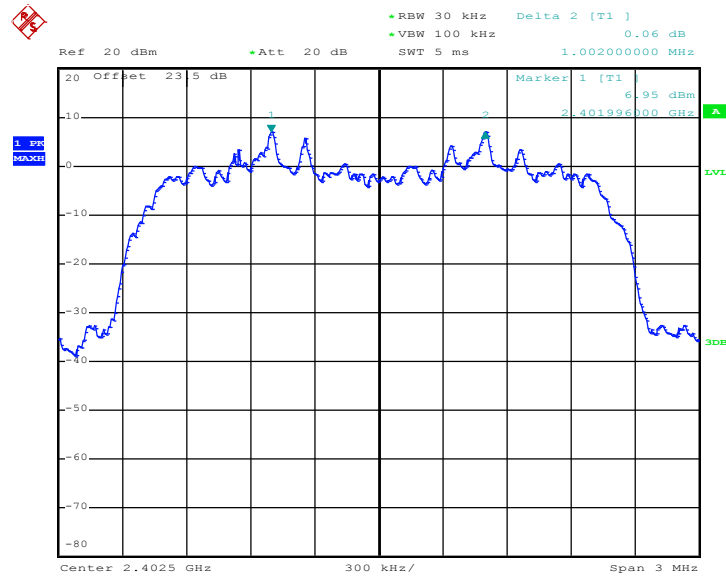

Date: 10.DEC.2013 00:18:05



Channel Separation Plot on Channel 39 - 40

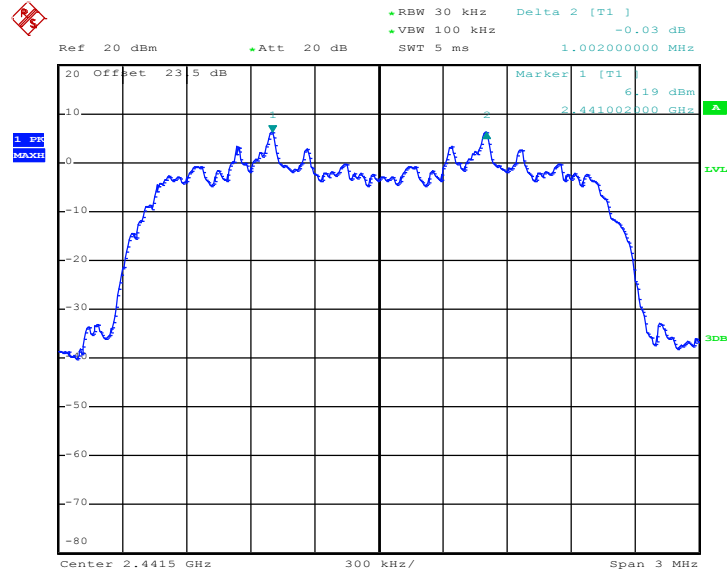

Date: 10.DEC.2013 00:28:49

Channel Separation Plot on Channel 77 - 78

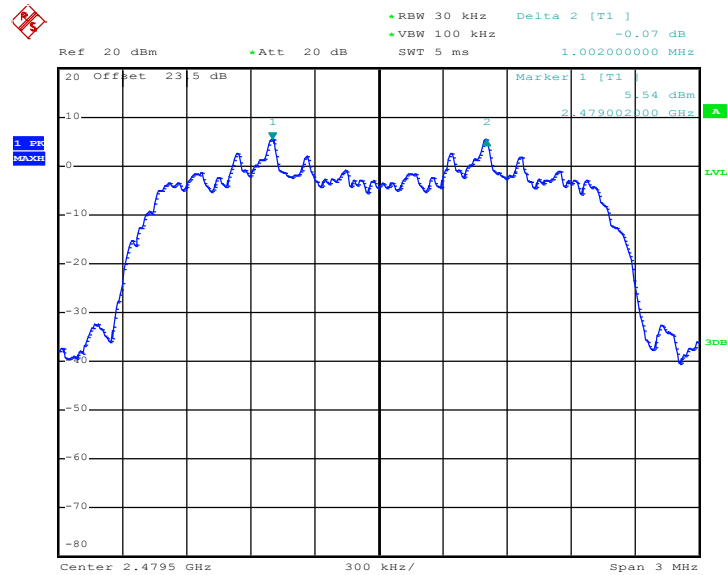

Date: 10.DEC.2013 00:50:56



Test Mode :	3Mbps	Temperature :	24-26°C
Test Engineer :	Alex Lee	Relative Humidity :	48-51%

Channel	Frequency (MHz)	Frequency Separation (MHz)	(2/3 of 20dB BW) Limits (MHz)	Pass/Fail
00	2402	1.002	0.8640	Pass
39	2441	1.002	0.8640	Pass
78	2480	1.002	0.8640	Pass

Channel Separation Plot on Channel 00 - 01

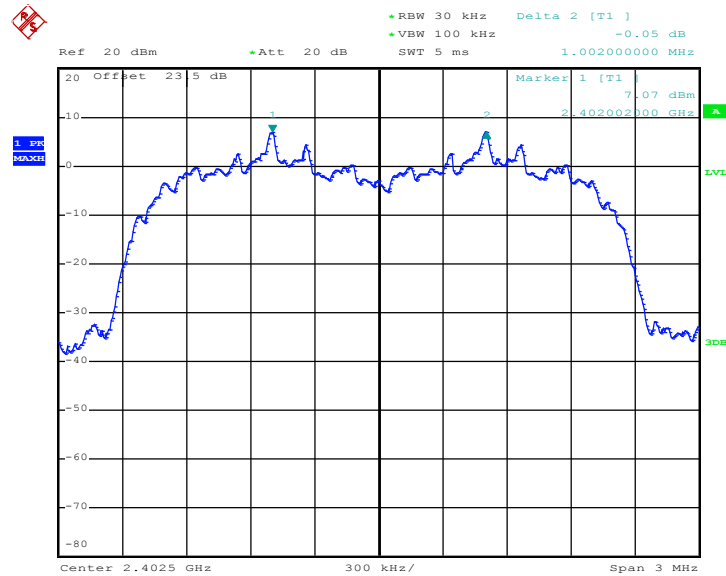

Date: 10.DEC.2013 01:06:24



Channel Separation Plot on Channel 39 - 40

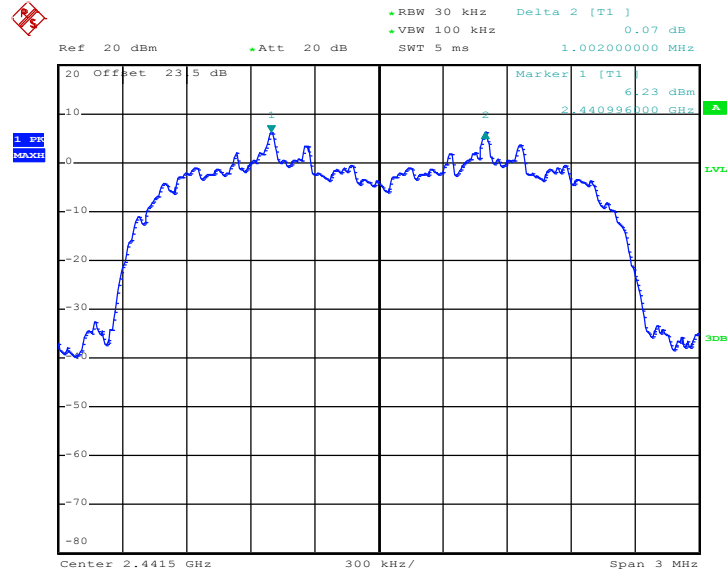

Date: 10.DEC.2013 01:03:27

Channel Separation Plot on Channel 77 - 78

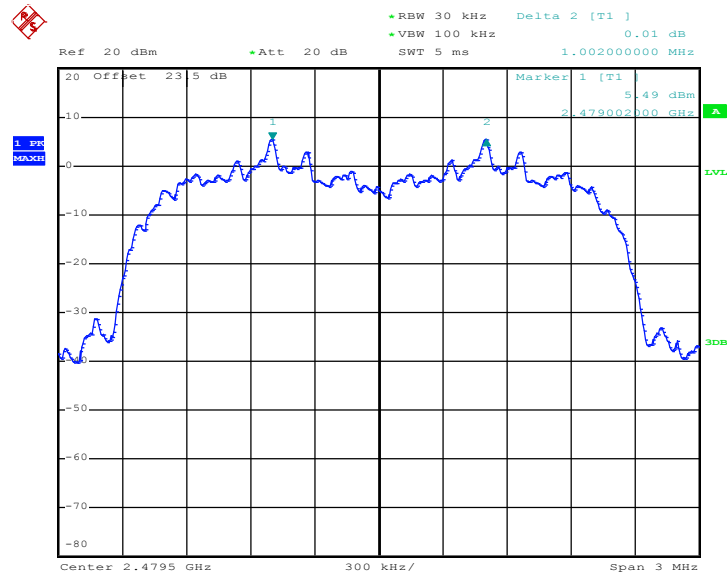

Date: 10.DEC.2013 00:53:28

3.3 Dwell Time Measurement

3.3.1 Limit of Dwell Time

The average time of occupancy on any channel shall not be greater than 0.4 seconds within a period of 0.4 seconds multiplied by the number of hopping channels employed.

3.3.2 Measuring Instruments

The measuring equipment is listed in the section 4 of this test report.

3.3.3 Test Procedures

1. The testing follows FCC Public Notice DA 00-705 Measurement Guidelines.
2. The RF output of EUT was connected to the spectrum analyzer by RF cable and attenuator. The path loss was compensated to the results for each measurement.
3. Set to the maximum power setting and enable the EUT transmit continuously.
4. Enable the EUT hopping function.
5. Use the following spectrum analyzer settings: Span = zero span, centered on a hopping channel; RBW = 1 MHz; VBW \geq RBW; Sweep = as necessary to capture the entire dwell time per hopping channel; Detector function = peak; Trace = max hold.
6. Measure and record the results in the test report.

3.3.4 Test Setup

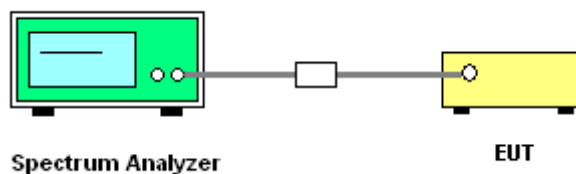



3.3.5 Test Result of Dwell Time

Test Mode :	DH5	Temperature :	24-26°C
Test Engineer :	Alex Lee	Relative Humidity :	48-51%

Mode	Hopping Channel Number	Hops Over Occupancy Time(hops)	Package Transfer Time (msec)	Dwell Time (sec)	Limits (sec)	Pass/Fail
Normal	79	106.67	2.92	0.31	0.4	Pass
AFH	20	53.33	2.92	0.16	0.4	Pass

Remark:

1. In normal mode, hopping rate is 1600 hops/s with 6 slots in 79 hopping channels.
With channel hopping rate $(1600 / 6 / 79)$ in Occupancy Time Limit (0.4×79) (s),
Hops Over Occupancy Time comes to $(1600 / 6 / 79) \times (0.4 \times 79) = 106.67$ hops.
2. In AFH mode, hopping rate is 800 hops/s with 6 slots in 20 hopping channels.
With channel hopping rate $(800 / 6 / 20)$ in Occupancy Time Limit (0.4×20) (s),
Hops Over Occupancy Time comes to $(800 / 6 / 20) \times (0.4 \times 20) = 53.33$ hops.
3. $Dwell\ Time(s) = Hops\ Over\ Occupancy\ Time\ (hops) \times Package\ Transfer\ Time$



Package Transfer Time Plot

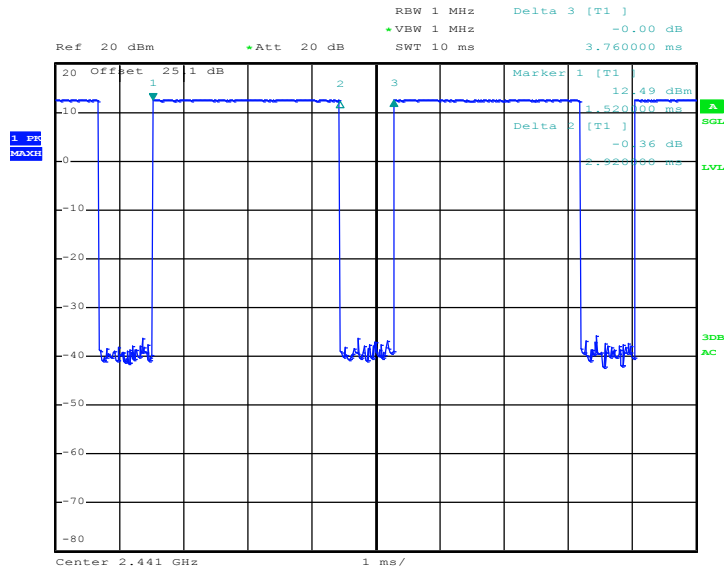

Date: 4.DEC.2013 14:46:32

3.4 20dB and 99% Bandwidth Measurement

3.4.1 Limit of 20dB and 99% Bandwidth

Reporting only

3.4.2 Measuring Instruments

The measuring equipment is listed in the section 4 of this test report.

3.4.3 Test Procedures

1. The testing follows FCC Public Notice DA 00-705 Measurement Guidelines.
2. The RF output of EUT was connected to the spectrum analyzer by RF cable and attenuator. The path loss was compensated to the results for each measurement.
3. Set to the maximum power setting and enable the EUT transmit continuously.
4. Use the following spectrum analyzer settings for 20dB Bandwidth measurement.
Span = approximately 2 to 3 times the 20 dB bandwidth, centered on a hopping channel;
RBW \geq 1% of the 20 dB bandwidth; VBW \geq RBW; Sweep = auto; Detector function = peak;
Trace = max hold.
5. Use the following spectrum analyzer settings for 99 % Bandwidth measurement.
For 99% Bandwidth measurement, the RBW=30kHz, and VBW = 100kHz. Sweep = auto ;
Detector function = sample. Trace = max hold.
6. Measure and record the results in the test report.

3.4.4 Test Setup

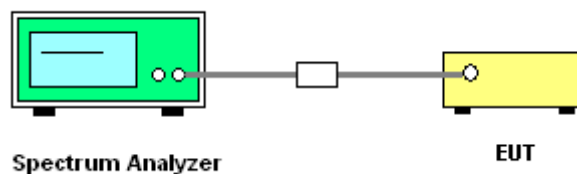



3.4.5 Test Result of 20dB Bandwidth

Test Mode :	1Mbps	Temperature :	24-26°C
Test Engineer :	Alex Lee	Relative Humidity :	48-51%

Channel	Frequency (MHz)	20dB Bandwidth (MHz)
00	2402	0.820
39	2441	0.816
78	2480	0.816

20 dB Bandwidth Plot on Channel 00

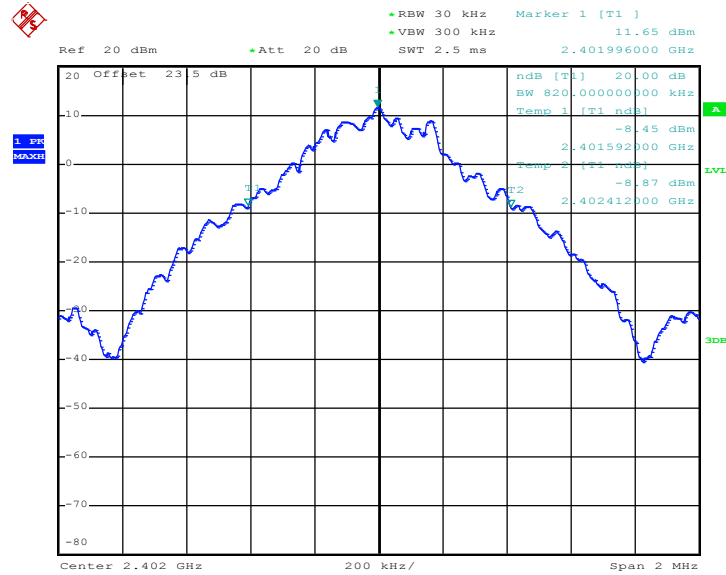

Date: 9.DEC.2013 23:51:58



20 dB Bandwidth Plot on Channel 39

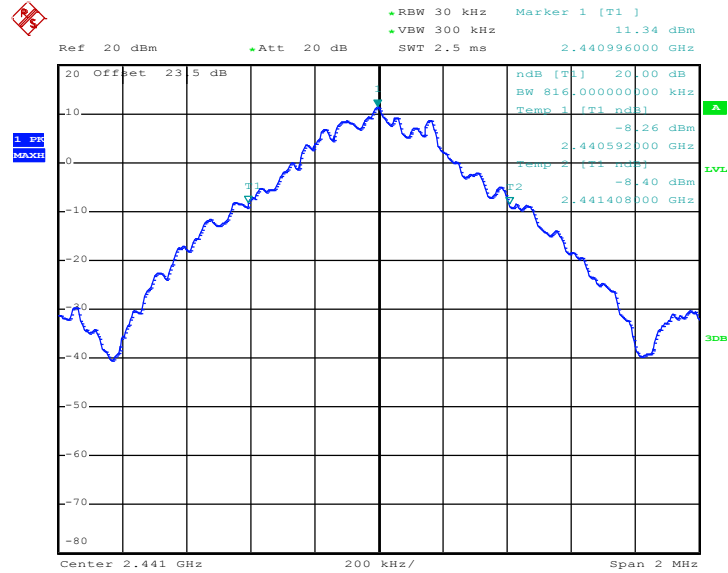

Date: 9.DEC.2013 23:58:36

20 dB Bandwidth Plot on Channel 78

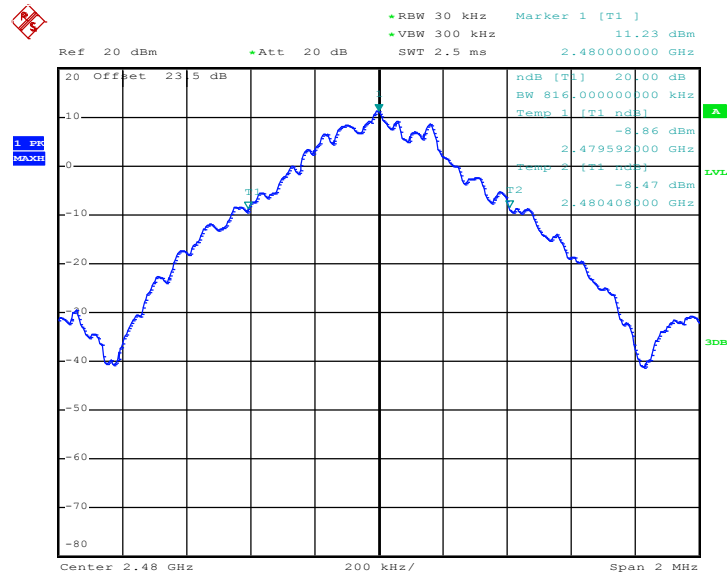

Date: 10.DEC.2013 00:08:50



Test Mode :	2Mbps	Temperature :	24-26°C
Test Engineer :	Alex Lee	Relative Humidity :	48-51%

Channel	Frequency (MHz)	20dB Bandwidth (MHz)
00	2402	1.278
39	2441	1.278
78	2480	1.278

20 dB Bandwidth Plot on Channel 00

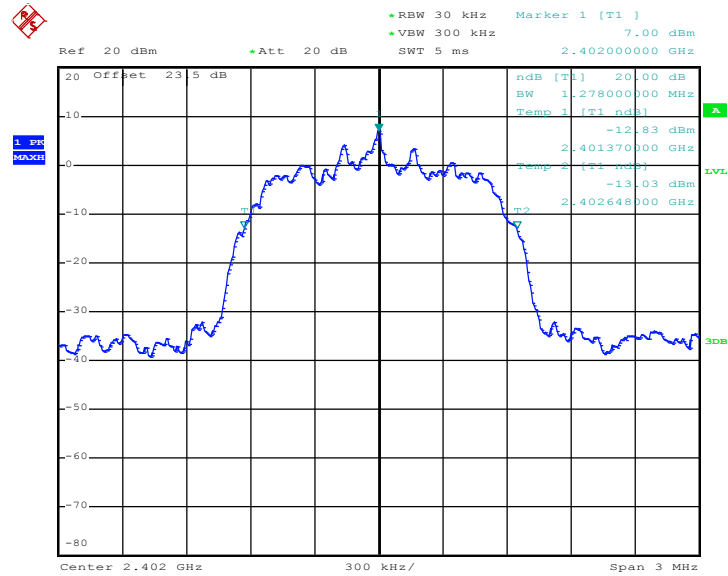

Date: 10.DEC.2013 00:18:42



20 dB Bandwidth Plot on Channel 39

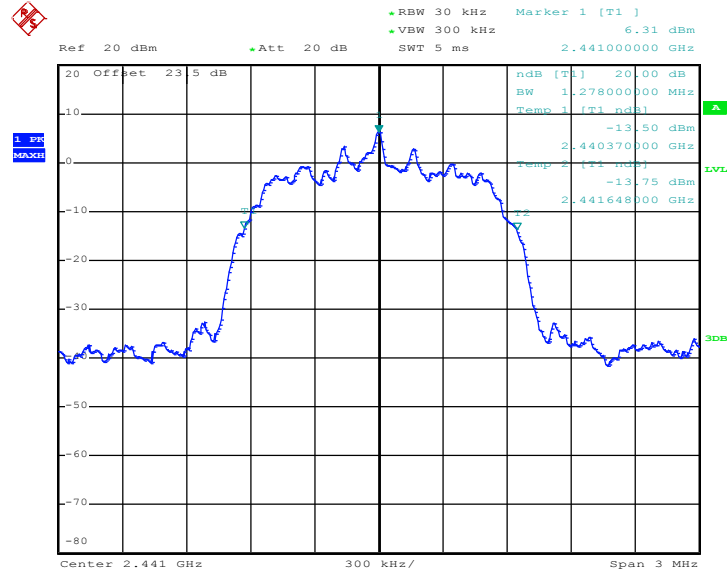

Date: 10.DEC.2013 00:29:14

20 dB Bandwidth Plot on Channel 78

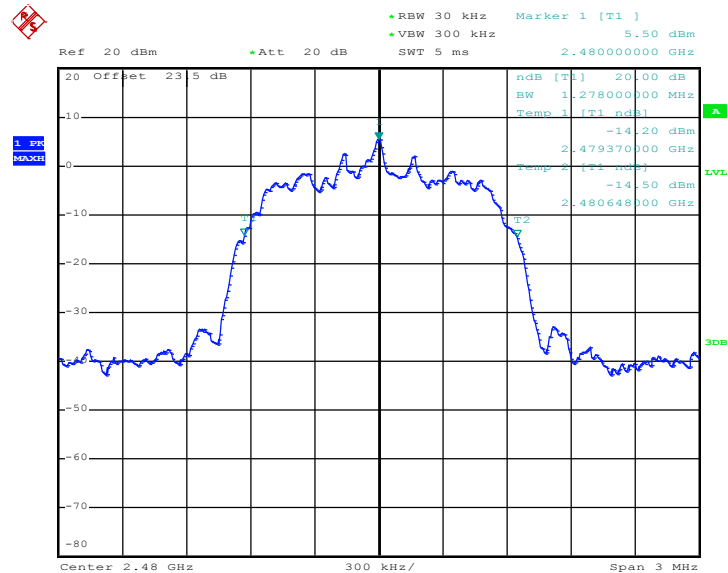

Date: 10.DEC.2013 00:31:48



Test Mode :	3Mbps	Temperature :	24-26°C
Test Engineer :	Alex Lee	Relative Humidity :	48-51%

Channel	Frequency (MHz)	20dB Bandwidth (MHz)
00	2402	1.296
39	2441	1.296
78	2480	1.296

20 dB Bandwidth Plot on Channel 00

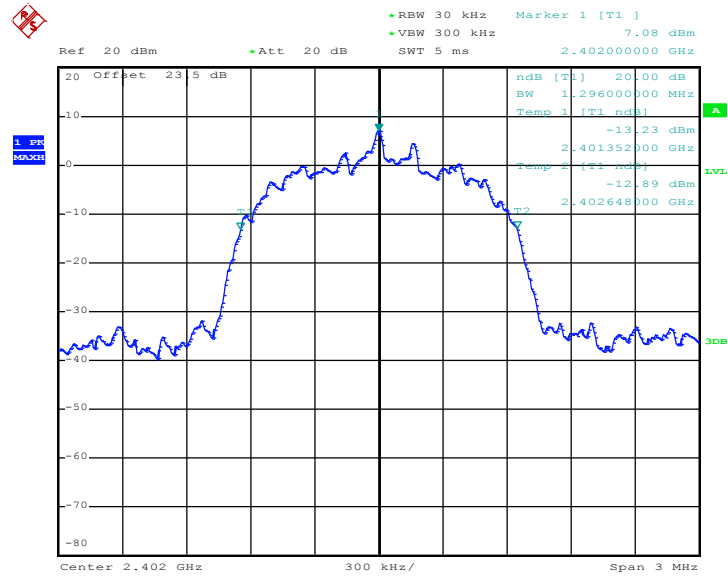

Date: 10.DEC.2013 01:06:53



20 dB Bandwidth Plot on Channel 39

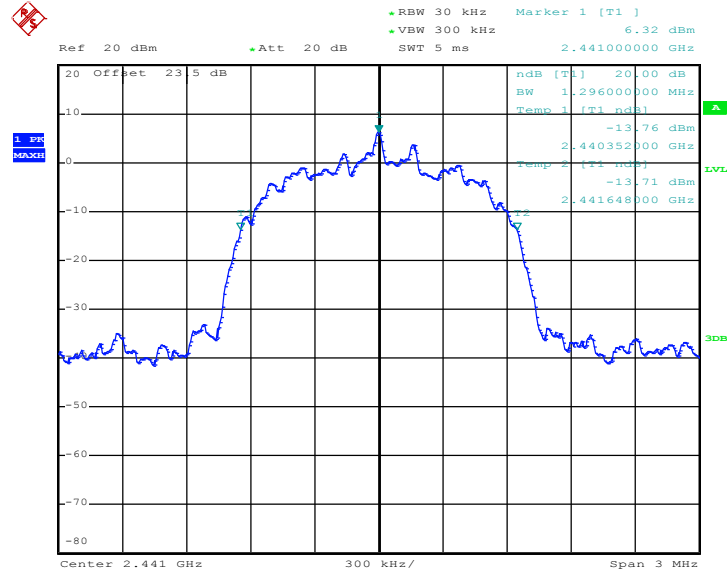

Date: 10.DEC.2013 01:03:51

20 dB Bandwidth Plot on Channel 78

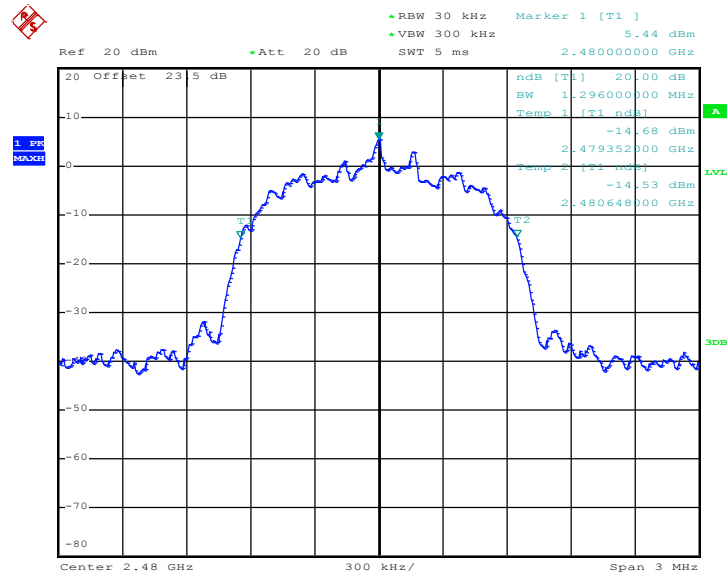

Date: 10.DEC.2013 00:54:04



3.4.6 Test Result of 99% Occupied Bandwidth

Test Mode :	1Mbps	Temperature :	24-26°C
Test Engineer :	Alex Lee	Relative Humidity :	48-51%

Channel	Frequency (MHz)	99% Occupied Bandwidth (MHz)
00	2402	0.840
39	2441	0.840
78	2480	0.840

99% Occupied Bandwidth Plot on Channel 00

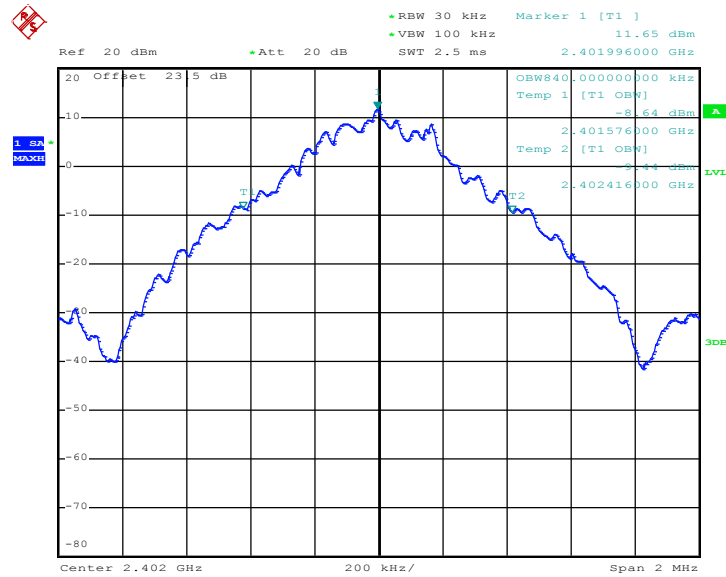

Date: 9.DEC.2013 23:54:52



99% Occupied Bandwidth Plot on Channel 39

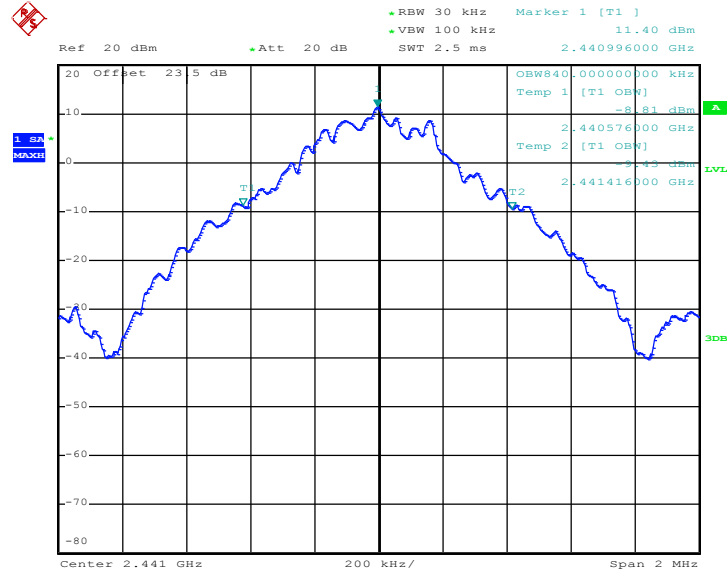

Date: 10.DEC.2013 00:00:20

99% Occupied Bandwidth Plot on Channel 78

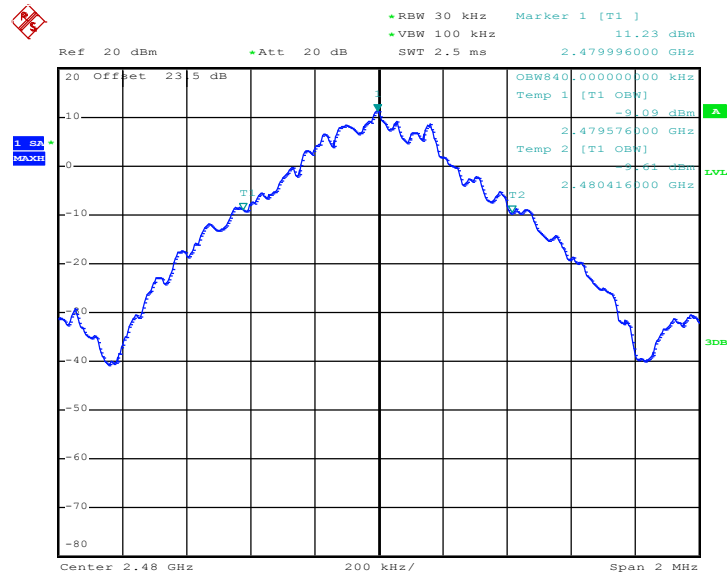

Date: 10.DEC.2013 00:13:15



Test Mode :	2Mbps	Temperature :	24-26°C
Test Engineer :	Alex Lee	Relative Humidity :	48-51%

Channel	Frequency (MHz)	99% Occupied Bandwidth (MHz)
00	2402	1.180
39	2441	1.180
78	2480	1.176

99% Occupied Bandwidth Plot on Channel 00

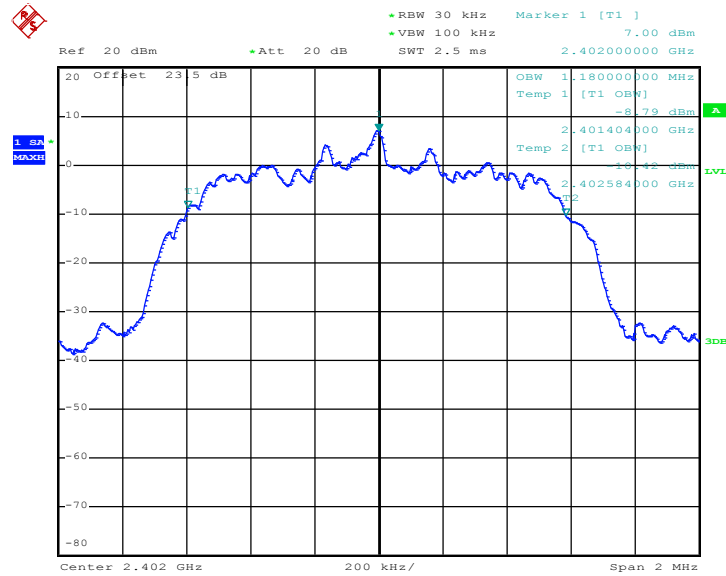

Date: 10.DEC.2013 00:20:52



99% Occupied Bandwidth Plot on Channel 39

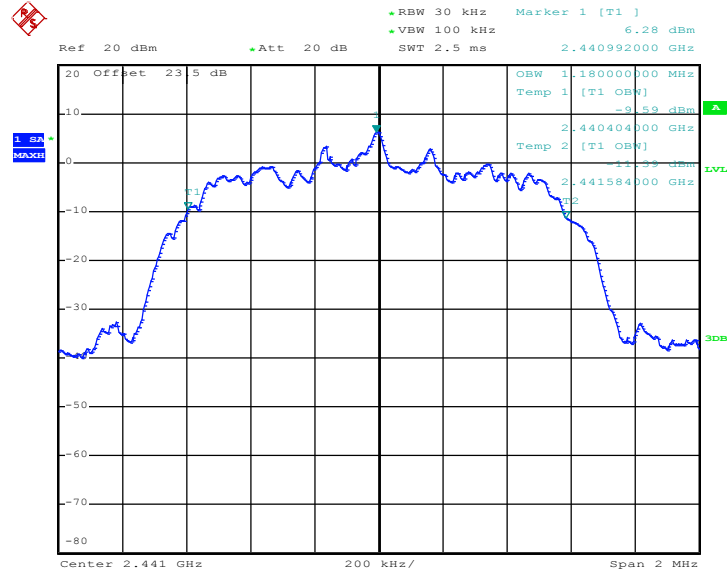

Date: 10.DEC.2013 00:30:07

99% Occupied Bandwidth Plot on Channel 78

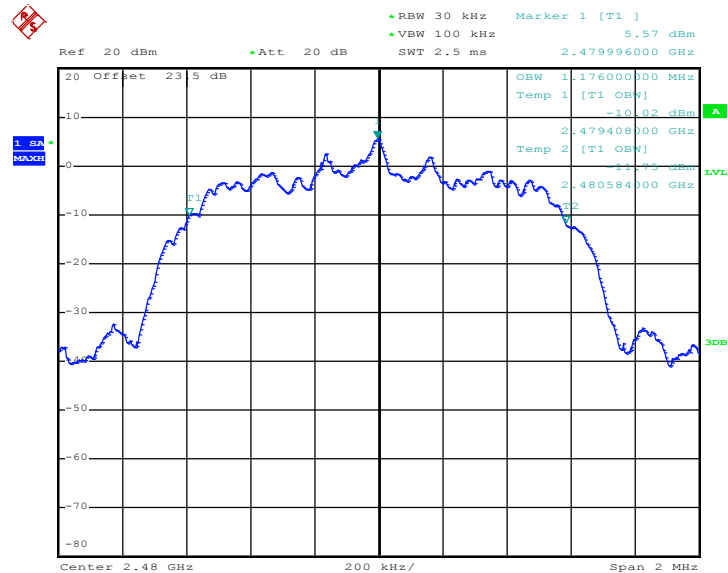

Date: 10.DEC.2013 00:40:34



Test Mode :	3Mbps	Temperature :	24-26°C
Test Engineer :	Alex Lee	Relative Humidity :	48-51%

Channel	Frequency (MHz)	99% Occupied Bandwidth (MHz)
00	2402	1.188
39	2441	1.184
78	2480	1.180

99% Occupied Bandwidth Plot on Channel 00

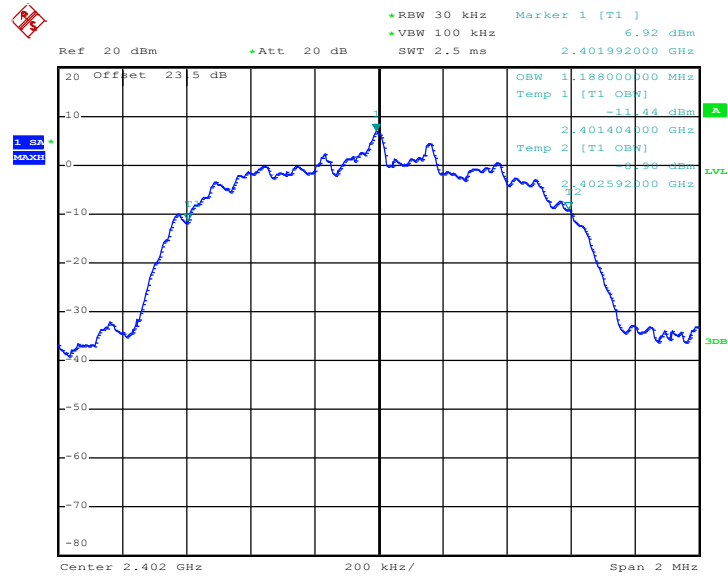

Date: 10.DEC.2013 01:07:35



99% Occupied Bandwidth Plot on Channel 39

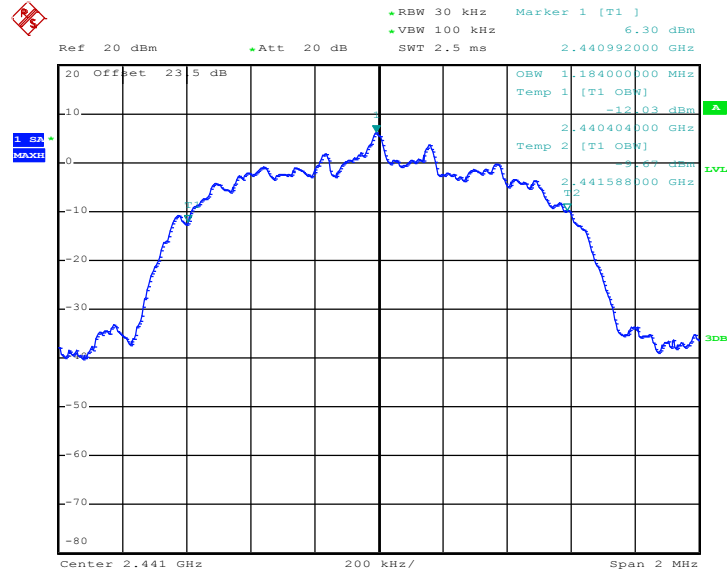

Date: 10.DEC.2013 01:04:29

99% Occupied Bandwidth Plot on Channel 78

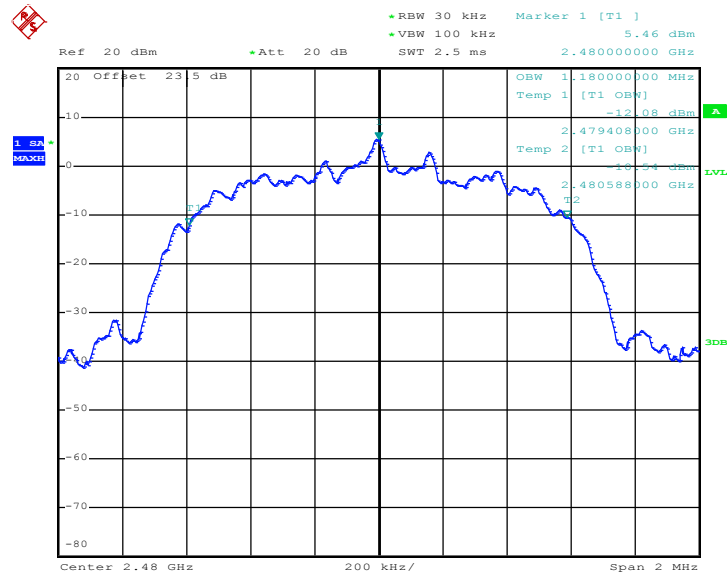

Date: 10.DEC.2013 01:00:08

3.5 Peak Output Power Measurement

3.5.1 Limit of Peak Output Power

Section 15.247 (b) The maximum peak conducted output power of the intentional radiator shall not exceed the following: (1) For frequency hopping systems operating in the 2400-2483.5 MHz band employing at least 75 non-overlapping hopping channels, and all frequency hopping systems in the 5725-5850 MHz band: 1 watt. For all other frequency hopping systems in the 2400-2483.5 MHz band 0.125 watts. The power limit for 1Mbps is 1watt, and for 2Mbps, 3Mbps and AFH are 0.125 watts.

3.5.2 Measuring Instruments

The measuring equipment is listed in the section 4 of this test report.

3.5.3 Test Procedures

1. The testing follows FCC Public Notice DA 00-705 Measurement Guidelines.
2. The RF output of EUT was connected to the power meter by RF cable and attenuator. The path loss was compensated to the results for each measurement.
3. Set to the maximum power setting and enable the EUT transmit continuously.
4. Measure the conducted output power with cable loss and record the results in the test report.
5. Measure and record the results in the test report.

3.5.4 Test Setup

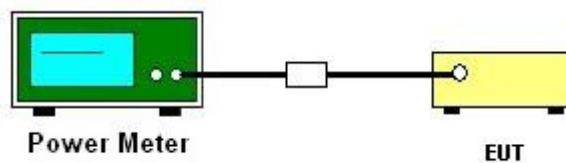



3.5.5 Test Result of Peak Output Power

Test Mode :	1Mbps	Temperature :	24-26°C
Test Engineer :	Alex Lee	Relative Humidity :	48-51%

Channel	Frequency (MHz)	RF Power (dBm)		
		GFSK	Max. Limits (dBm)	Pass/Fail
		1 Mbps		
00	2402	12.39	20.97	Pass
39	2441	12.39	20.97	Pass
78	2480	12.39	20.97	Pass

Note: For AFH mode using 20 hopping channels, the maximum output power limit is 20.97dBm.

Test Mode :	2Mbps	Temperature :	24-26°C
Test Engineer :	Alex Lee	Relative Humidity :	48-51%

Channel	Frequency (MHz)	RF Power (dBm)		
		$\pi/4$ -DQPSK	Max. Limits (dBm)	Pass/Fail
		2 Mbps		
00	2402	9.75	20.97	Pass
39	2441	9.29	20.97	Pass
78	2480	8.96	20.97	Pass

Test Mode :	3Mbps	Temperature :	24-26°C
Test Engineer :	Alex Lee	Relative Humidity :	48-51%

Channel	Frequency (MHz)	RF Power (dBm)		
		8-DPSK	Max. Limits (dBm)	Pass/Fail
		3 Mbps		
00	2402	10.17	20.97	Pass
39	2441	9.84	20.97	Pass
78	2480	9.54	20.97	Pass

3.6 Conducted Band Edges Measurement

3.6.1 Limit of Band Edges

In any 100 kHz bandwidth outside the intentional radiation frequency band, the radio frequency power shall be at least 20 dB below the highest level of the radiated power. In addition, radiated emissions which fall in the restricted bands must also comply with the radiated emission limits.

3.6.2 Measuring Instruments

The measuring equipment is listed in the section 4 of this test report.

3.6.3 Test Procedures

1. The testing follows the guidelines in Band-edge Compliance of RF Conducted Emissions of FCC Public Notice DA 00-705 Measurement Guidelines.
2. Set to the maximum power setting and enable the EUT transmit continuously.
3. Set RBW = 100kHz ($\geq 1\%$ span=10MHz), VBW = 300kHz (\geq RBW). Band edge emissions must be at least 20 dB down from the highest emission level within the authorized band as measured with a 100kHz RBW. The attenuation shall be 30 dB instead of 20 dB when RMS conducted output power procedure is used.
4. Enable hopping function of the EUT and then repeat step 2. and 3.
5. Measure and record the results in the test report.

3.6.4 Test Setup

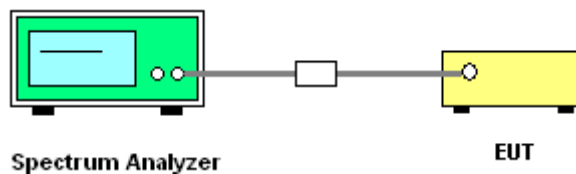



3.6.6 Test Result of Conducted Band Edges

Test Mode :	1Mbps	Temperature :	24-26°C
Test Channel :	00 and 78	Relative Humidity :	48-51%
		Test Engineer :	Alex Lee

Low Band Edge Plot on Channel 00

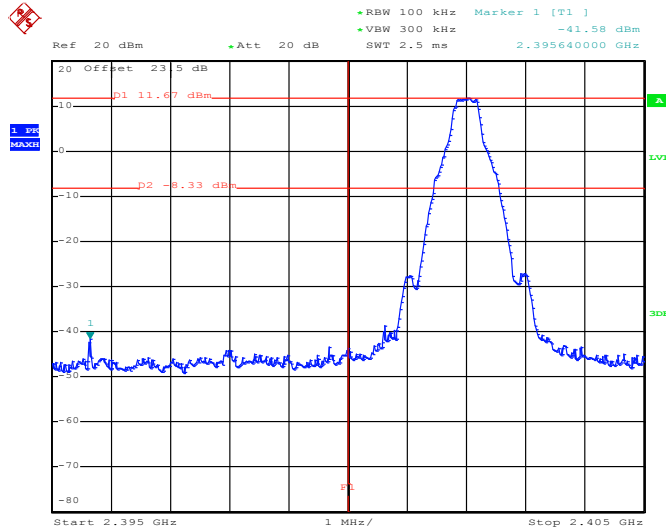

Date: 9.DEC.2013 23:54:08

High Band Edge Plot on Channel 78

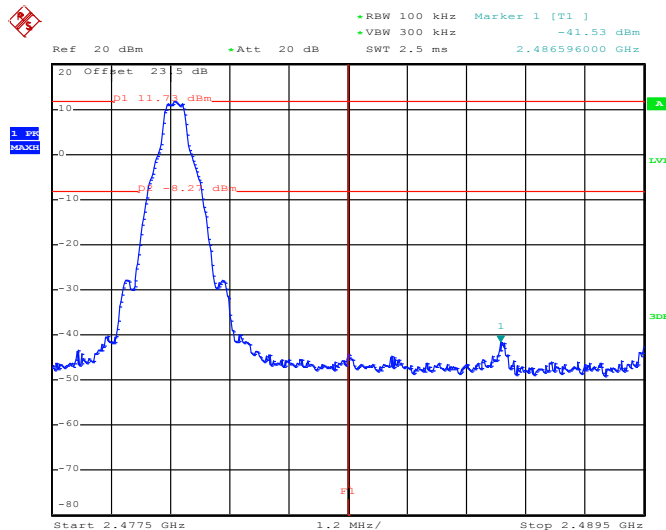

Date: 10.DEC.2013 00:12:12



Test Mode :	2Mbps	Temperature :	24-26°C
Test Channel :	00 and 78	Relative Humidity :	48-51%
		Test Engineer :	Alex Lee

Low Band Edge Plot on Channel 00

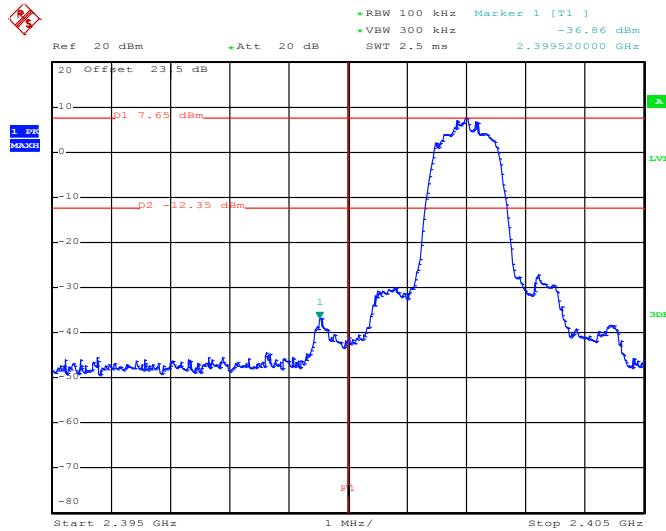

Date: 10.DEC.2013 00:25:33

High Band Edge Plot on Channel 78

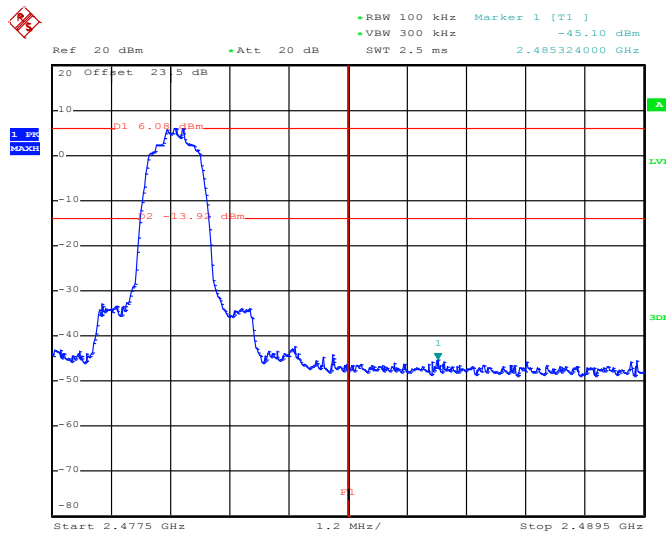

Date: 10.DEC.2013 00:39:33



Test Mode :	3Mbps	Temperature :	24-26°C
Test Channel :	00 and 78	Relative Humidity :	48-51%
		Test Engineer :	Alex Lee

Low Band Edge Plot on Channel 00

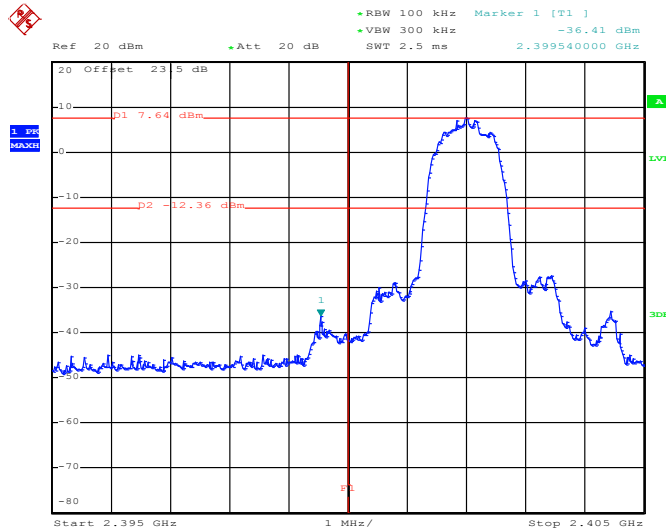

Date: 10.DEC.2013 01:14:41

High Band Edge Plot on Channel 78

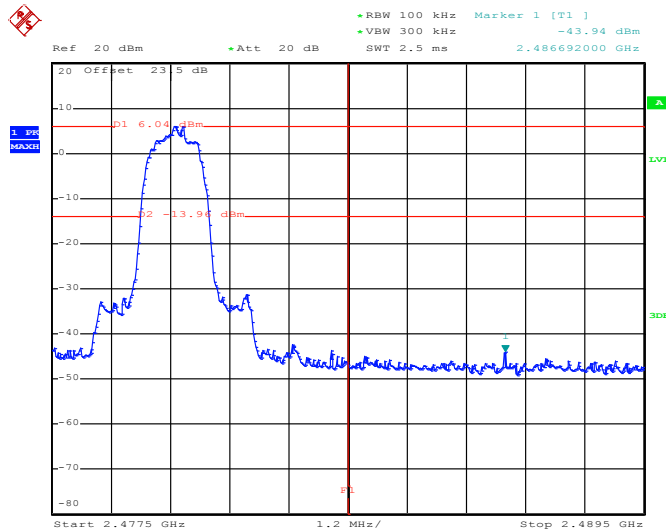

Date: 10.DEC.2013 00:59:19



3.6.7 Test Result of Conducted Hopping Mode Band Edges

Test Mode :	1Mbps	Temperature :	24-26°C
Test Engineer :	Alex Lee	Relative Humidity :	48-51%

1Mbps Hopping Mode Low Band Edge Plot

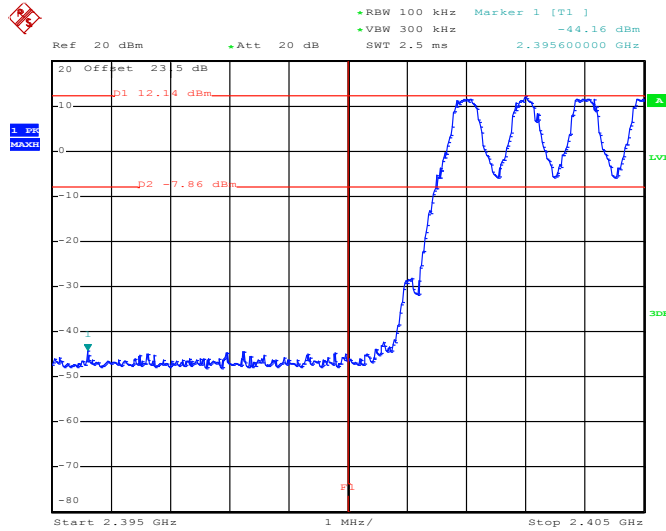

Date: 9.DEC.2013 23:53:45

1Mbps Hopping Mode High Band Edge Plot

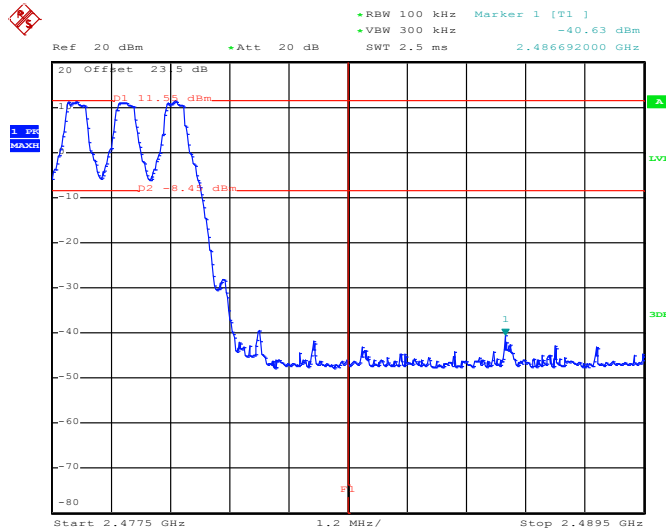

Date: 10.DEC.2013 00:10:33



Test Mode :	2Mbps	Temperature :	24-26°C
Test Engineer :	Alex Lee	Relative Humidity :	48-51%

2Mbps Hopping Mode Low Band Edge Plot

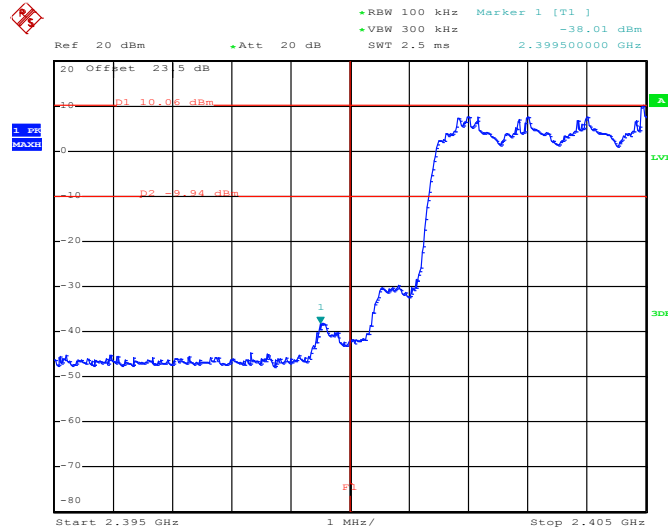

Date: 10.DEC.2013 00:25:11

2Mbps Hopping Mode High Band Edge Plot

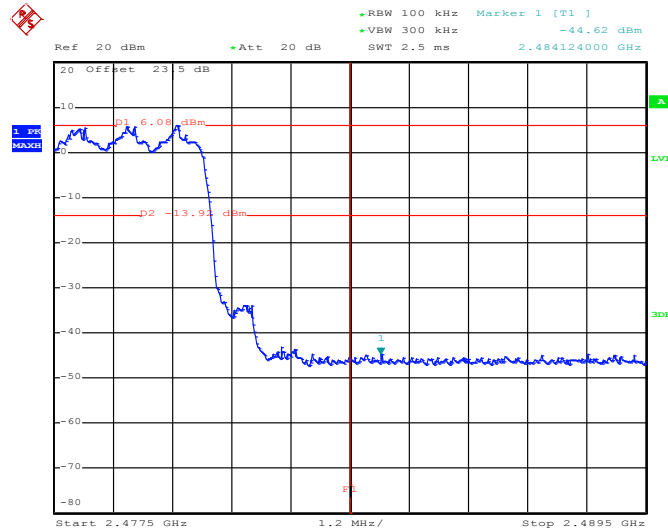

Date: 10.DEC.2013 00:39:13



Test Mode :	3Mbps	Temperature :	24-26°C
Test Engineer :	Alex Lee	Relative Humidity :	48-51%

3Mbps Hopping Mode Low Band Edge Plot

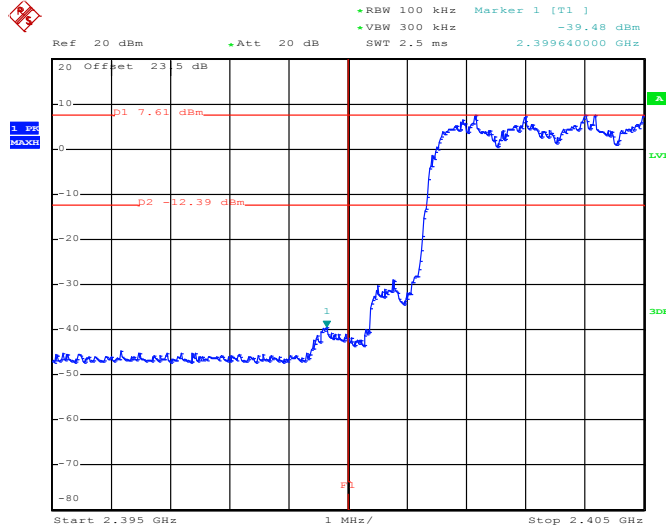

Date: 10.DEC.2013 01:14:20

3Mbps Hopping Mode High Band Edge Plot

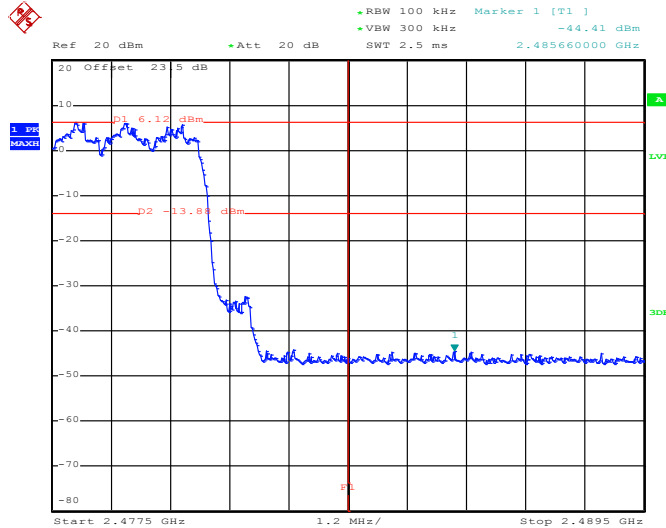

Date: 10.DEC.2013 00:58:13

3.7 Conducted Spurious Emission Measurement

3.7.1 Limit of Spurious Emission Measurement

In any 100 kHz bandwidth outside the intentional radiation frequency band, the radio frequency power shall be at least 20 dB below the highest level of the radiated power. In addition, radiated emissions which fall in the restricted bands must also comply with the radiated emission limits.

3.7.2 Measuring Instruments

The measuring equipment is listed in the section 4 of this test report.

3.7.3 Test Procedure

1. The testing follows the guidelines in Spurious RF Conducted Emissions of FCC Public Notice DA 00-705 Measurement Guidelines
2. The RF output of EUT was connected to the spectrum analyzer by RF cable and attenuator. The path loss was compensated to the results for each measurement.
3. Set to the maximum power setting and enable the EUT transmit continuously.
4. Set RBW = 100 kHz, VBW = 300kHz, scan up through 10th harmonic. All harmonics / spurs must be at least 20 dB down from the highest emission level within the authorized band as measured with a 100 kHz RBW.
5. Measure and record the results in the test report.
6. The RF fundamental frequency should be excluded against the limit line in the operating frequency band.

3.7.4 Test Setup

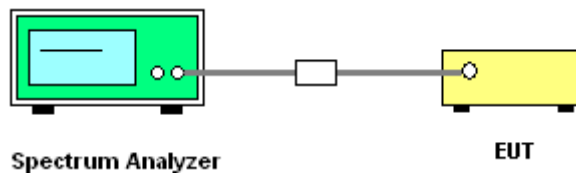



3.7.5 Test Result of Conducted Spurious Emission

Test Mode :	1Mbps	Temperature :	24-26°C
Test Channel :	00	Relative Humidity :	48-51%
		Test Engineer :	Alex Lee

1Mbps CSE Plot on Ch 00 between 30MHz ~ 3 GHz

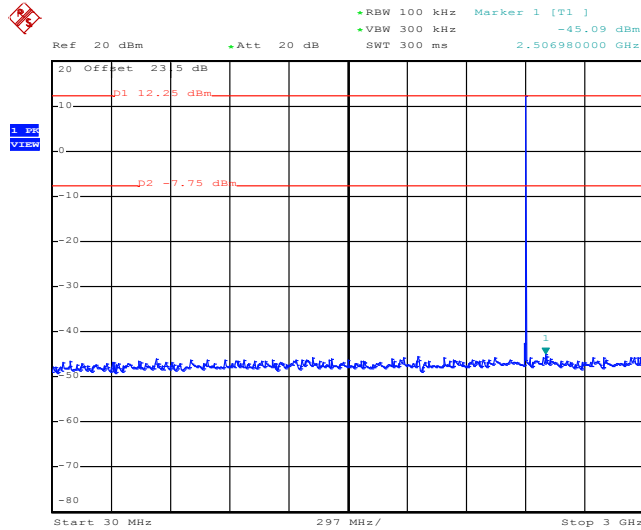

Date: 9.DEC.2013 23:55:20

1Mbps CSE Plot on Ch 00 between 2 GHz ~ 25 GHz

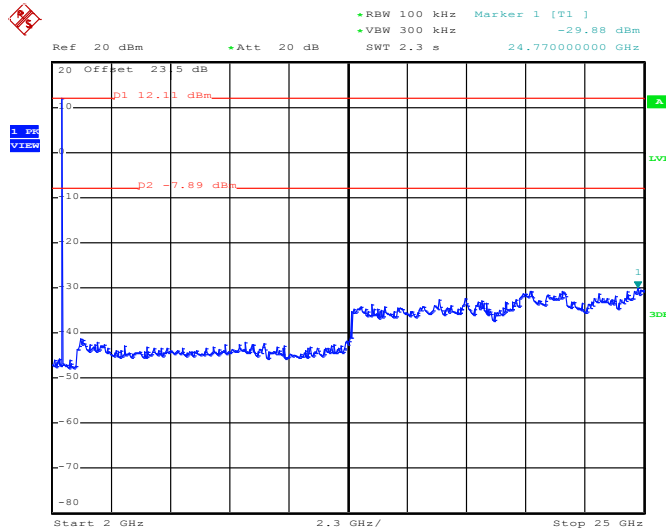

Date: 9.DEC.2013 23:55:43



Test Mode :	1Mbps	Temperature :	24-26°C
Test Channel :	39	Relative Humidity :	48-51%
		Test Engineer :	Alex Lee

1Mbps CSE Plot on Ch 39 between 30MHz ~ 3 GHz

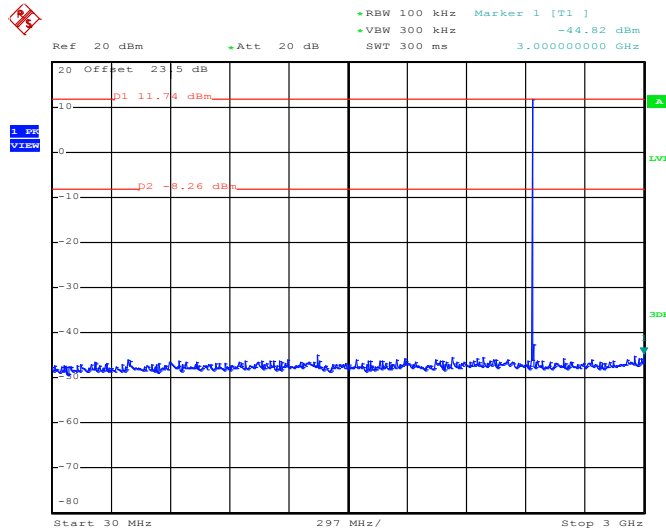

Date: 10.DEC.2013 00:00:52

1Mbps CSE Plot on Ch 39 between 2 GHz ~ 25 GHz

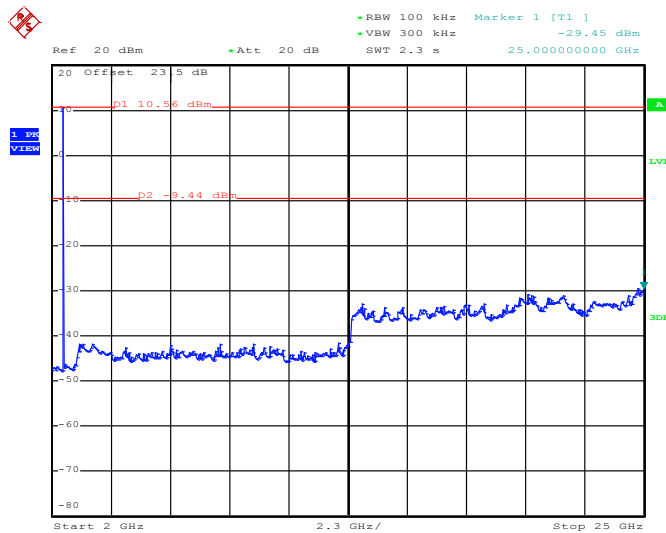

Date: 10.DEC.2013 00:01:14



Test Mode :	1Mbps	Temperature :	24-26°C
Test Channel :	78	Relative Humidity :	48-51%
		Test Engineer :	Alex Lee

1Mbps CSE Plot on Ch 78 between 30MHz ~ 3 GHz

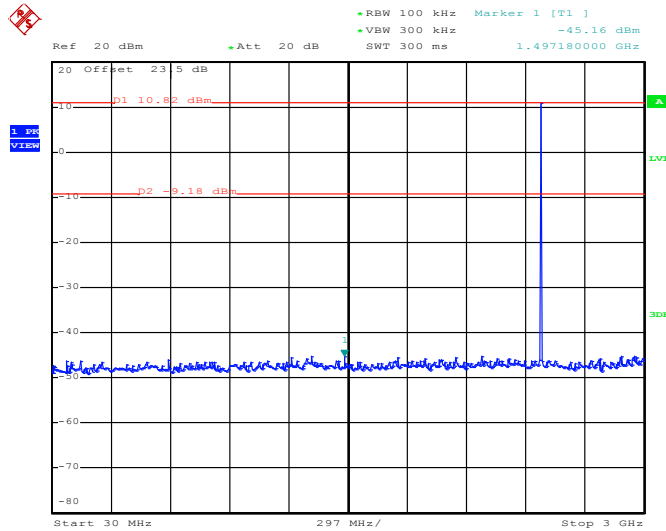

Date: 10.DEC.2013 00:15:11

1Mbps CSE Plot on Ch 78 between 2 GHz ~ 25 GHz

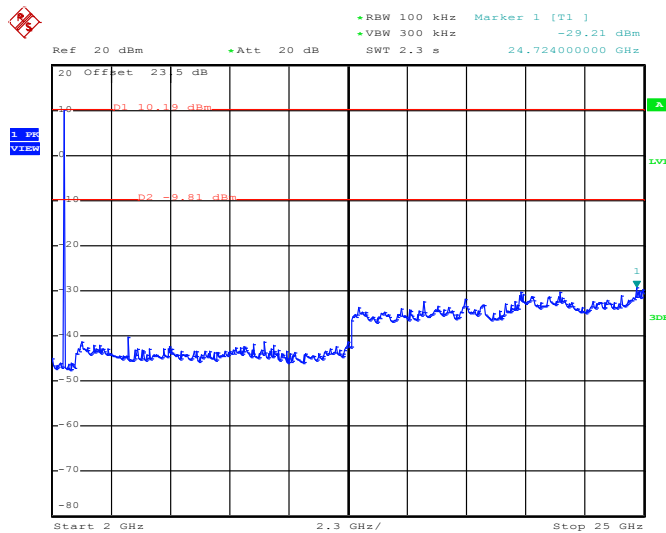

Date: 10.DEC.2013 00:15:34



Test Mode :	2Mbps	Temperature :	24-26°C
Test Channel :	00	Relative Humidity :	48-51%
		Test Engineer :	Alex Lee

2Mbps CSE Plot on Ch 00 between 30MHz ~ 3 GHz

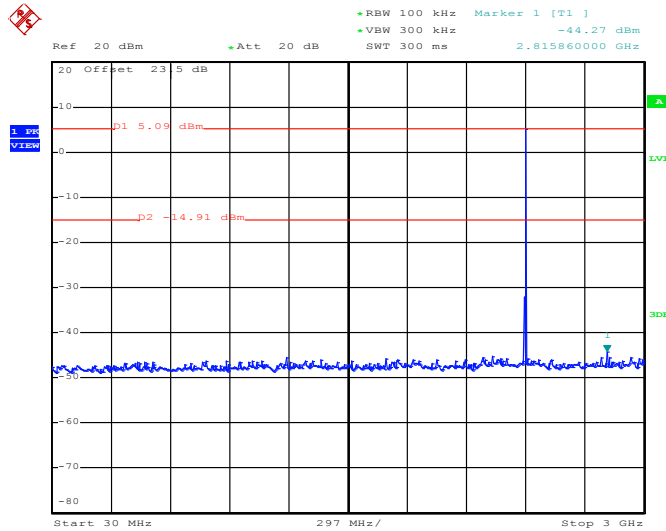

Date: 10.DEC.2013 00:21:29

2Mbps CSE Plot on Ch 00 between 2 GHz ~ 25 GHz

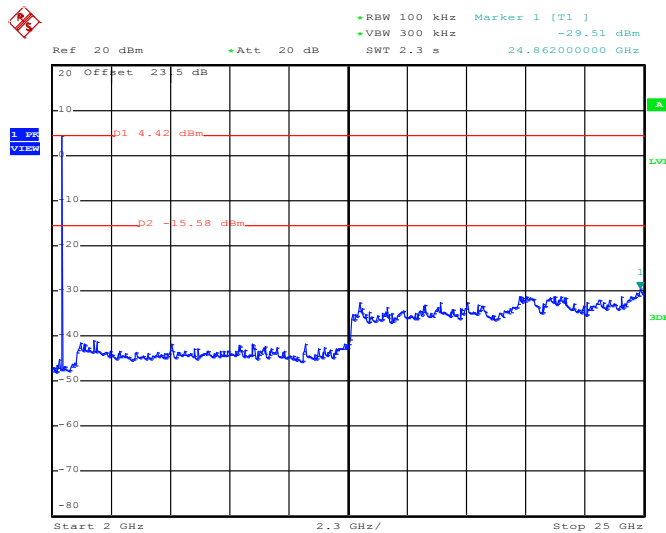

Date: 10.DEC.2013 00:21:51



Test Mode :	2Mbps	Temperature :	24-26°C
Test Channel :	39	Relative Humidity :	48-51%
		Test Engineer :	Alex Lee

2Mbps CSE Plot on Ch 39 between 30MHz ~ 3 GHz

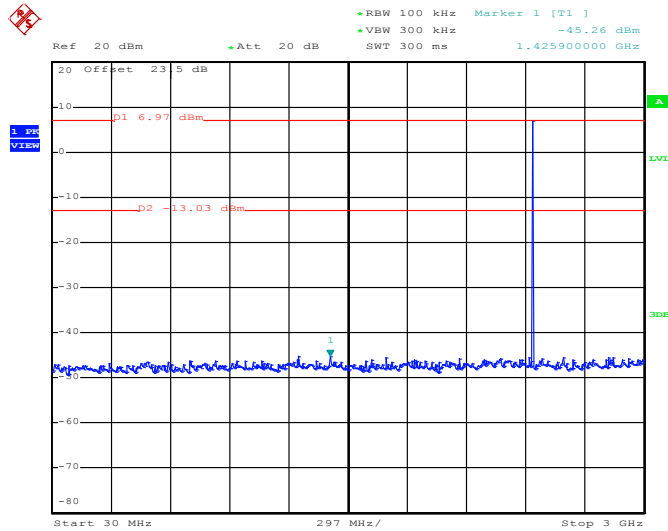

Date: 10.DEC.2013 00:30:55

2Mbps CSE Plot on Ch 39 between 2 GHz ~ 25 GHz

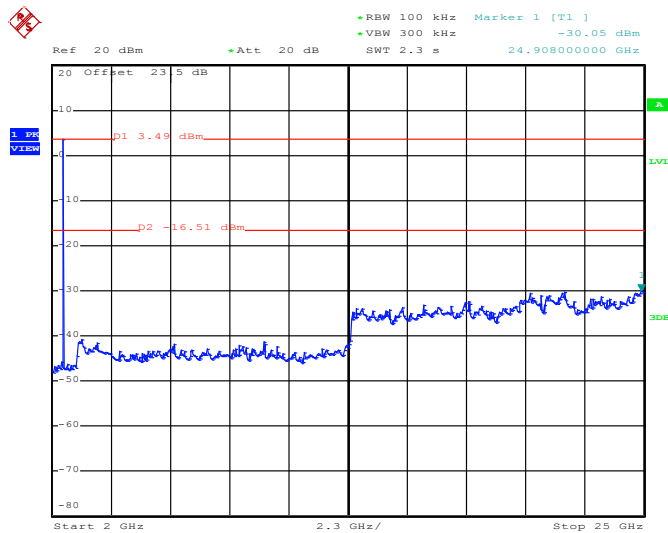

Date: 10.DEC.2013 00:31:17



Test Mode :	2Mbps	Temperature :	24-26°C
Test Channel :	78	Relative Humidity :	48-51%
		Test Engineer :	Alex Lee

2Mbps CSE Plot on Ch 78 between 30MHz ~ 3 GHz

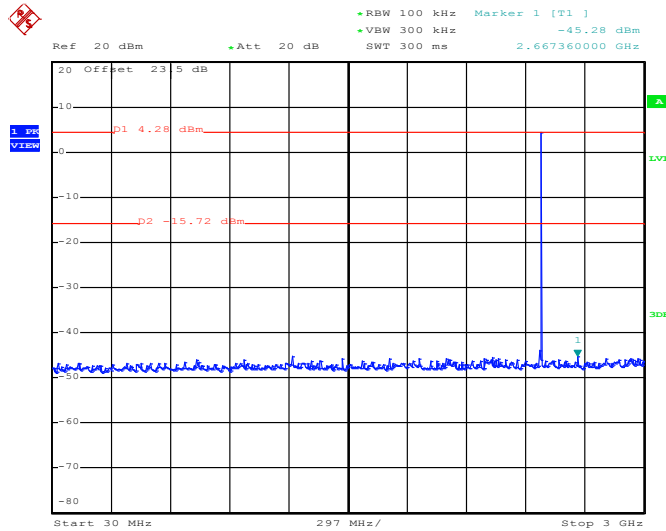

Date: 10.DEC.2013 00:41:01

2Mbps CSE Plot on Ch 78 between 2 GHz ~ 25 GHz

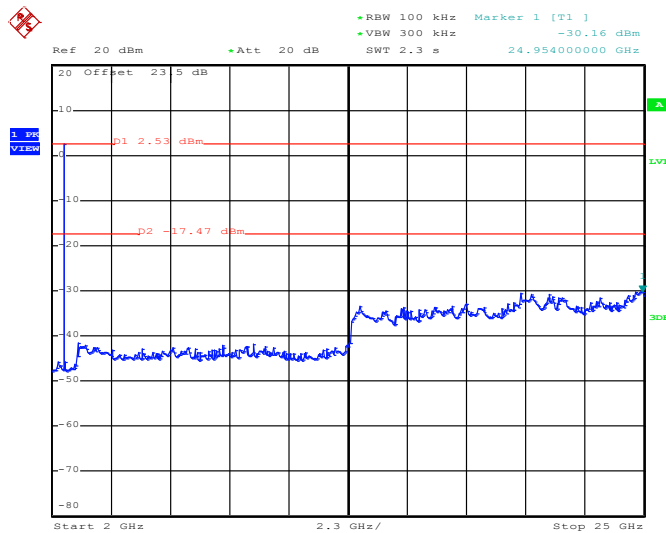

Date: 10.DEC.2013 00:41:24



Test Mode :	3Mbps	Temperature :	24-26°C
Test Channel :	00	Relative Humidity :	48-51%
		Test Engineer :	Alex Lee

3Mbps CSE Plot on Ch 00 between 30MHz ~ 3 GHz

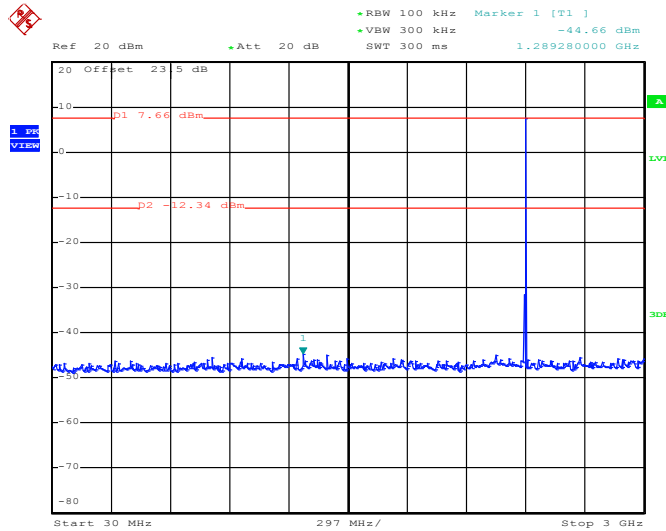

Date: 10.DEC.2013 01:21:42

3Mbps CSE Plot on Ch 00 between 2 GHz ~ 25 GHz

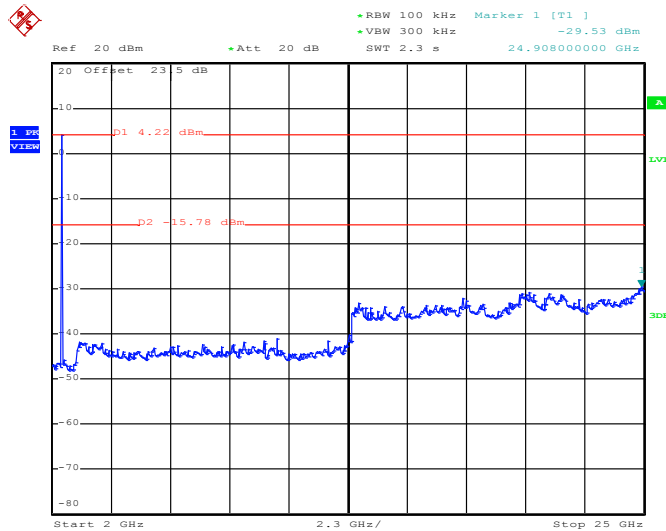

Date: 10.DEC.2013 01:22:04



Test Mode :	3Mbps	Temperature :	24-26°C
Test Channel :	39	Relative Humidity :	48-51%
		Test Engineer :	Alex Lee

3Mbps CSE Plot on Ch 39 between 30MHz ~ 3 GHz

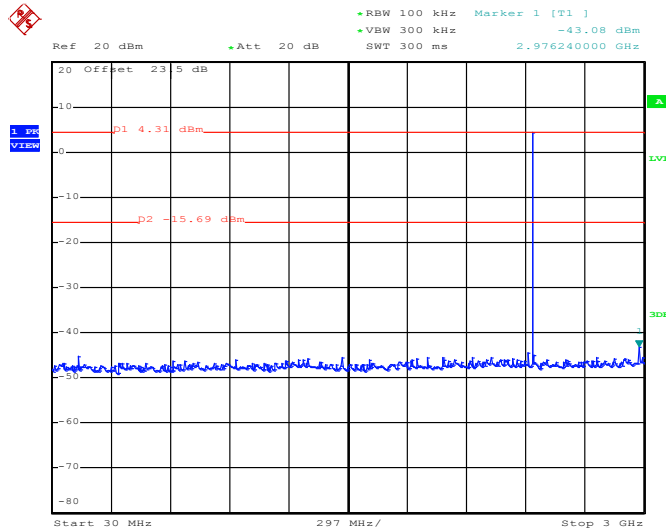

Date: 10.DEC.2013 01:04:55

3Mbps CSE Plot on Ch 39 between 2 GHz ~ 25 GHz

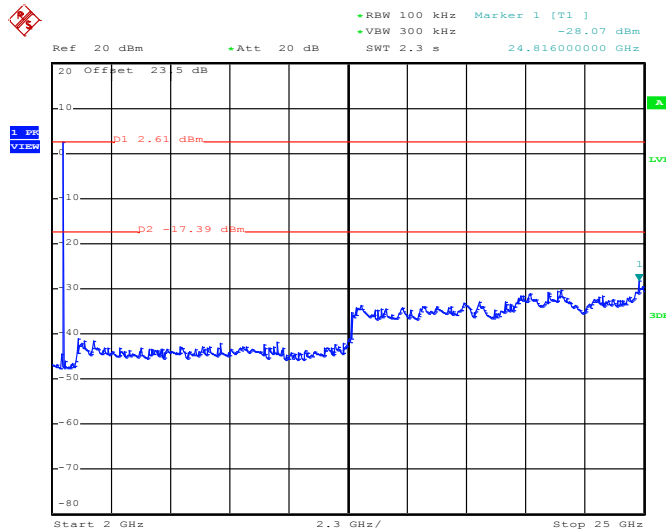

Date: 10.DEC.2013 01:05:18



Test Mode :	3Mbps	Temperature :	24-26°C
Test Channel :	78	Relative Humidity :	48-51%
		Test Engineer :	Alex Lee

3Mbps CSE Plot on Ch 78 between 30MHz ~ 3 GHz

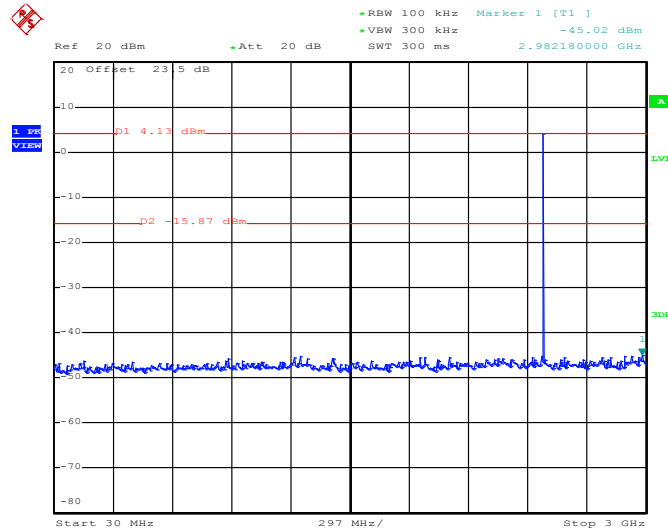

Date: 10.DEC.2013 01:01:38

3Mbps CSE Plot on Ch 78 between 2 GHz ~ 25 GHz

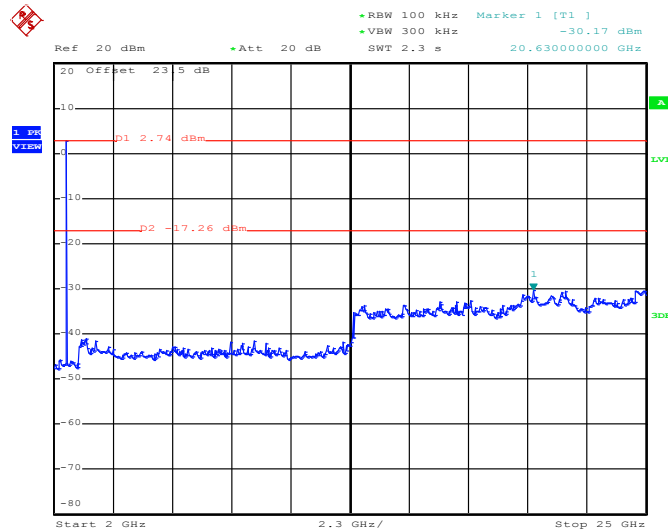

Date: 10.DEC.2013 01:02:00

3.8 Radiated Band Edges and Spurious Emission Measurement

3.8.1 Limit of Radiated Band Edges and Spurious Emission

In any 100 kHz bandwidth outside the intentional radiator frequency band, all harmonics/spurious must be at least 20 dB below the highest emission level within the authorized band. In addition, radiated emissions which fall in the restricted bands must also comply with the FCC section 15.209 limits as below.

Frequency (MHz)	Field Strength (microvolts/meter)	Measurement Distance (meters)
0.009 – 0.490	2400/F(kHz)	300
0.490 – 1.705	24000/F(kHz)	30
1.705 – 30.0	30	30
30 – 88	100	3
88 – 216	150	3
216 - 960	200	3
Above 960	500	3

3.8.2 Measuring Instruments

The measuring equipment is listed in the section 4 of this test report.



3.8.3 Test Procedures

1. The testing follows the guidelines in Spurious Radiated Emissions of FCC Public Notice DA 00-705 Measurement Guidelines.
2. The EUT was placed on a turntable with 0.8 meter above ground.
3. The EUT was set 3 meters from the interference receiving antenna, which was mounted on the top of a variable height antenna tower.
4. For each suspected emission, the EUT was arranged to its worst case and then tune the Antenna tower (from 1 m to 4 m) and turntable (from 0 degree to 360 degrees) to find the maximum reading. A pre-amp and a high pass filter are used for the test in order to get better signal level to comply with the guidelines.
5. Set to the maximum power setting and enable the EUT transmit continuously.
6. Use the following spectrum analyzer settings:
 - (1) Span shall wide enough to fully capture the emission being measured;
 - (2) Set RBW=100 kHz for $f < 1$ GHz, RBW=1MHz for $f > 1$ GHz ; VBW \geq RBW; Sweep = auto; Detector function = peak; Trace = max hold for peak
 - (3) For average measurement: use duty cycle correction factor method per 15.35(c).
Duty cycle = On time/100 milliseconds
On time = $N_1 * L_1 + N_2 * L_2 + \dots + N_{n-1} * L_{n-1} + N_n * L_n$
Where N_1 is number of type 1 pulses, L_1 is length of type 1 pulses, etc.
Average Emission Level = Peak Emission Level + $20 * \log(\text{Duty cycle})$
7. Corrected Reading: Antenna Factor + Cable Loss + Read Level - Preamp Factor = Level

Note: The average levels were calculated from the peak level corrected with duty cycle correction factor (-24.79dB) derived from $20 \log(\text{dwell time}/100\text{ms})$. This correction is only for signals that hop with the fundamental signal, such as band-edge and harmonic. Other spurious signals that are independent of the hopping signal would not use this correction.

3.8.4 Test Setup

For radiated emissions below 30MHz

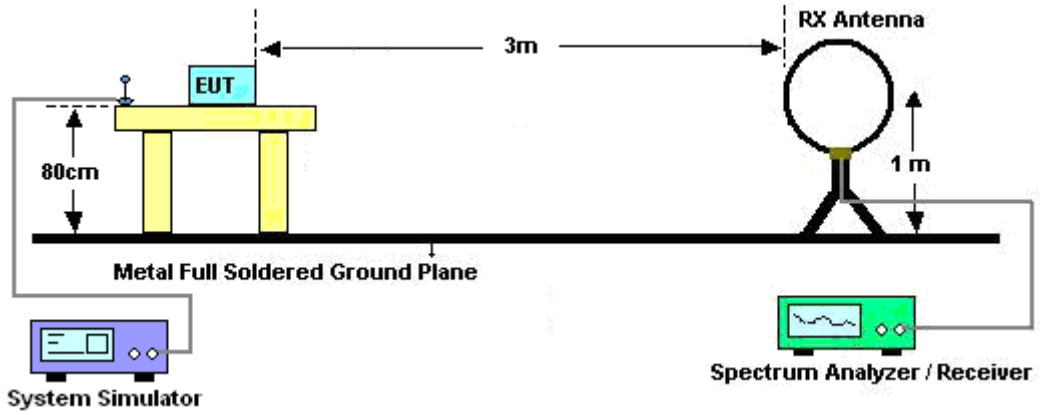

For radiated emissions from 30MHz to 1GHz

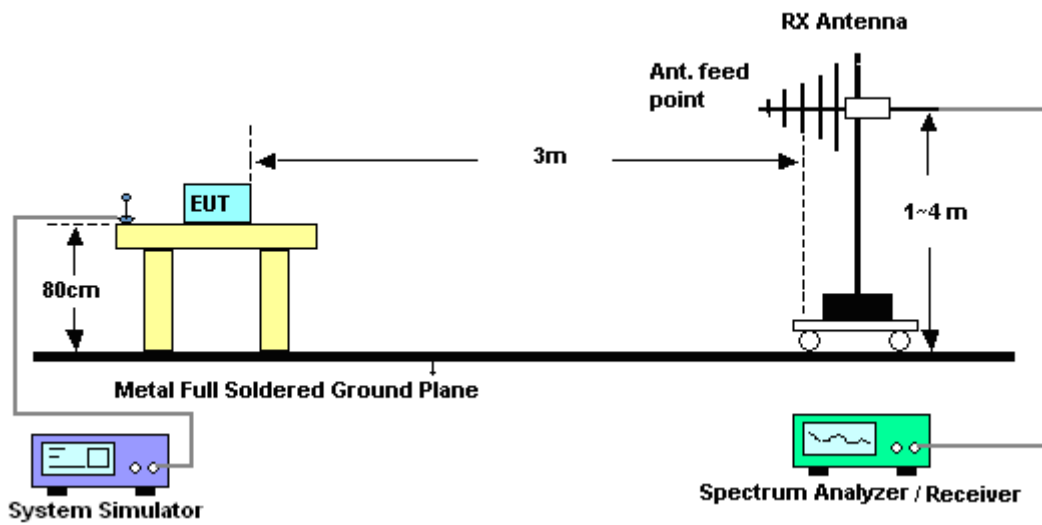

For radiated emissions above 1GHz

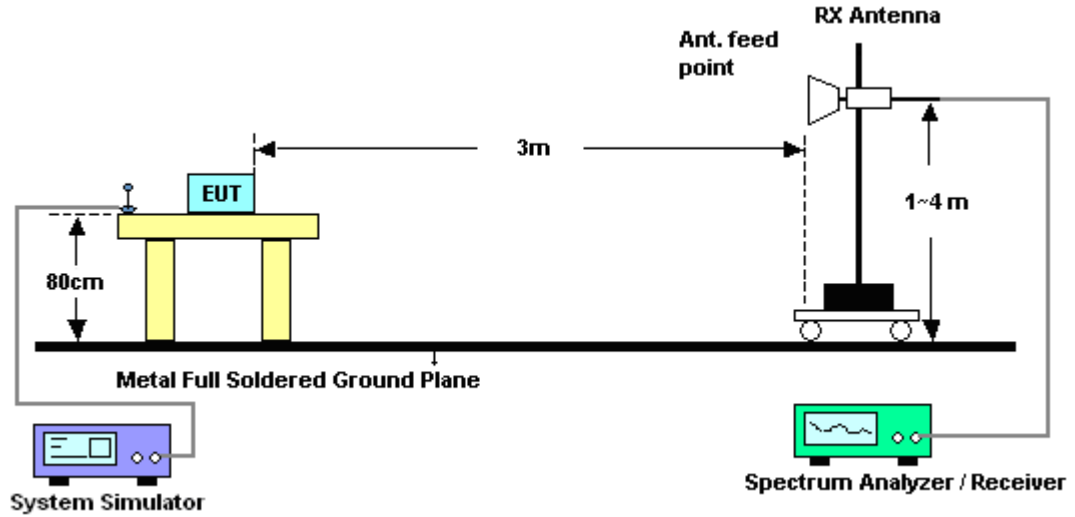

3.8.5 Test Results of Radiated Spurious Emissions (9 kHz ~ 30 MHz)

The low frequency, which started from 9 kHz to 30MHz, was pre-scanned and the result which was 20dB lower than the limit line per 15.31(o) was not reported.

3.8.6 Duty cycle correction factor for average measurement

DH5 on time (One Pulse) Plot on Channel 39

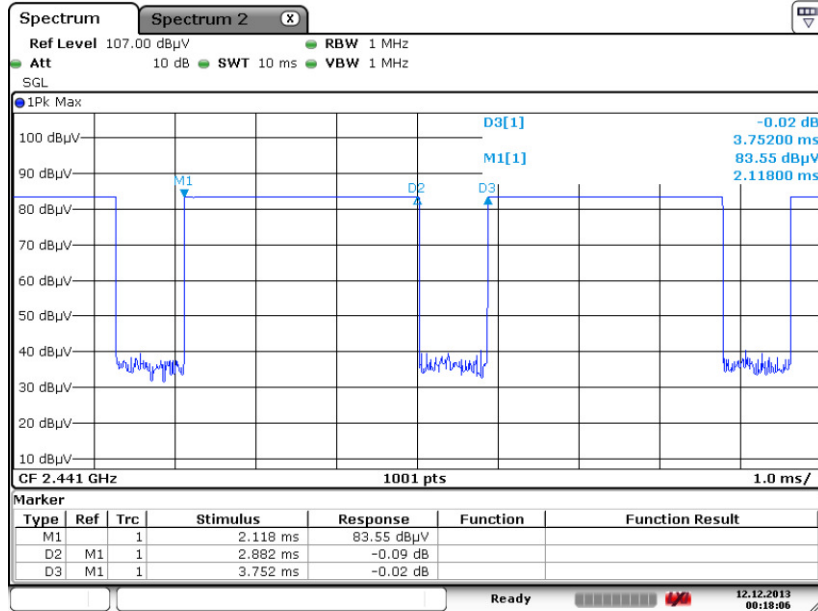

Date: 12.DEC.2013 00:18:07

DH5 on time (Count Pulses) Plot on Channel 39

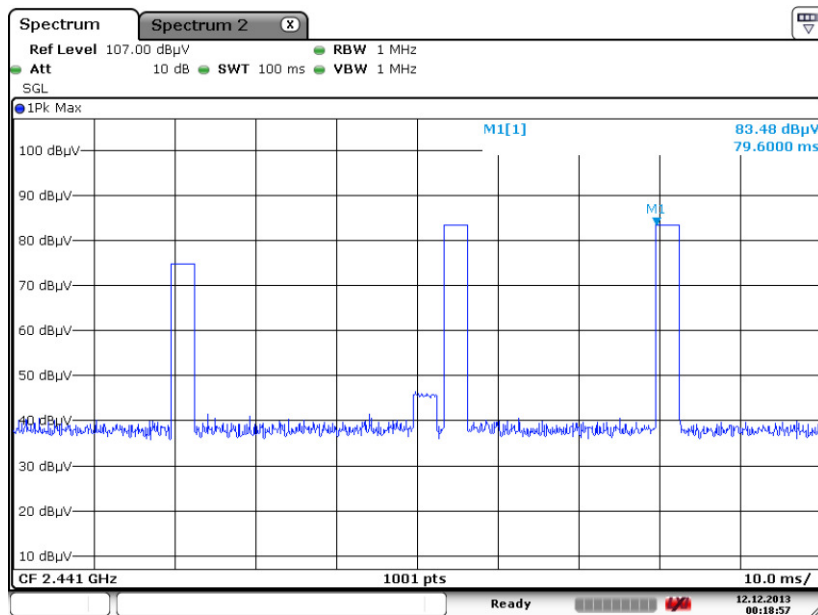

Date: 12.DEC.2013 00:18:57

Note:

1. Worst case Duty cycle = on time/100 milliseconds = $2 * 2.88 / 100 = 5.76 \%$
2. Worst case Duty cycle correction factor = $20 * \log(\text{Duty cycle}) = -24.79 \text{ dB}$
3. DH5 has the highest duty cycle worst case and is reported.



Duty Cycle Correction Factor Consideration for AFH mode:

Bluetooth normal hopping rate is 1600Hz and reduced to 800Hz in AFH mode; due to the reduced number of hopping frequencies, with the same packet configuration the dwell time in each channel frequency within 100msec period is longer in AFH mode than normal mode.

In AFH mode, the minimum hopping frequencies are 20, to get the longest dwell time DH5 packet is observed; the period to have DH5 packet completing one hopping sequence is

$$2.88 \text{ ms} \times 20 \text{ channels} = 57.6 \text{ ms}$$

There cannot be 2 complete hopping sequences within 100ms period, considering the random hopping behavior, maximum 2 hops can be possibly observed within the period. $[100\text{ms} / 57.6\text{ms}] = 2 \text{ hops}$

Thus, the maximum possible ON time:

$$2.88 \text{ ms} \times 2 = 5.76 \text{ ms}$$

Worst case Duty Cycle Correction factor, which is derived from the maximum possible ON time,

$$20 \times \log(5.76 \text{ ms}/100\text{ms}) = -24.79 \text{ dB}$$



3.8.7 Test Result of Radiated Spurious at Band Edges

Test Mode :	1Mbps	Temperature :	20~22°C
Test Channel :	00	Relative Humidity :	51~56%
		Test Engineer :	Stan Hsieh

ANTENNA POLARITY : HORIZONTAL										
Frequency (MHz)	Level (dBμV/m)	Over Limit (dB)	Limit Line (dBμV/m)	Read Level (dBμV)	Antenna Factor (dB)	Cable Loss (dB)	Preamp Factor (dB)	Ant Pos (cm)	Table Pos (deg)	Remark
2333.22	46.07	-27.93	74	41.22	32.23	6.84	34.22	120	280	Peak
2333.22	21.28	-32.72	54	-	-	-	-	-	-	Average

ANTENNA POLARITY : VERTICAL										
Frequency (MHz)	Level (dBμV/m)	Over Limit (dB)	Limit Line (dBμV/m)	Read Level (dBμV)	Antenna Factor (dB)	Cable Loss (dB)	Preamp Factor (dB)	Ant Pos (cm)	Table Pos (deg)	Remark
2372.01	45.39	-28.61	74	40.5	32.28	6.88	34.27	163	100	Peak
2372.01	20.6	-33.4	54	-	-	-	-	-	-	Average

Test Mode :	1Mbps	Temperature :	20~22°C
Test Channel :	78	Relative Humidity :	51~56%
		Test Engineer :	Stan Hsieh

ANTENNA POLARITY : HORIZONTAL										
Frequency (MHz)	Level (dBμV/m)	Over Limit (dB)	Limit Line (dBμV/m)	Read Level (dBμV)	Antenna Factor (dB)	Cable Loss (dB)	Preamp Factor (dB)	Ant Pos (cm)	Table Pos (deg)	Remark
2489.53	48.76	-25.24	74	43.73	32.4	7.06	34.43	136	148	Peak
2489.53	23.97	-30.03	54	-	-	-	-	-	-	Average

ANTENNA POLARITY : VERTICAL										
Frequency (MHz)	Level (dBμV/m)	Over Limit (dB)	Limit Line (dBμV/m)	Read Level (dBμV)	Antenna Factor (dB)	Cable Loss (dB)	Preamp Factor (dB)	Ant Pos (cm)	Table Pos (deg)	Remark
2485.06	46.67	-27.33	74	41.66	32.38	7.06	34.43	100	96	Peak
2485.06	21.88	-32.12	54	-	-	-	-	-	-	Average

Note: Average Emission Level = Peak Emission Level + duty cycle correction factor(-24.79dB)



3.8.8 Test Result of Radiated Spurious Emission (30MHz ~ 10th Harmonic)

Note: Pre-scanned all test modes and only choose the worst case mode recorded in the test report for radiated spurious emission below 1GHz.

Test Mode :	1Mbps	Temperature :	20~22°C
Test Channel :	00	Relative Humidity :	51~56%
Test Engineer :	Stan Hsieh	Polarization :	Horizontal
Remark :	2402 MHz is fundamental signal which can be ignored.		

Frequency (MHz)	Level (dBμV/m)	Over Limit (dB)	Limit Line (dBμV/m)	Read Level (dBμV)	Antenna Factor (dB)	Cable Loss (dB)	Preamp Factor (dB)	Ant Pos (cm)	Table Pos (deg)	Remark
44.04	22.04	-17.96	40	41.4	11.2	0.64	31.2	-	-	Peak
113.43	28.44	-15.06	43.5	47.51	11.02	1.07	31.16	-	-	Peak
183.09	35.21	-8.29	43.5	56.07	8.84	1.26	30.96	-	-	Peak
399.4	35.09	-10.91	46	47.95	15.9	2.14	30.9	-	-	Peak
748.7	39.85	-6.15	46	45.08	22.11	3.06	30.4	-	-	Peak
797	40.8	-5.2	46	46	21.97	3.14	30.31	124	245	Peak
2402	83.49	-	-	78.58	32.3	6.91	34.3	120	280	Peak
2402	58.7	-	-	-	-	-	-	-	-	Average
4806	58.09	-15.91	74	74.3	33.98	8.77	58.96	100	0	Peak
4806	33.3	-20.7	54	-	-	-	-	-	-	Average

Note: 1. Other harmonics are lower than background noise.

2. Average Emission Level = Peak Emission Level + duty cycle correction factor(-24.79)



Test Mode :	1Mbps	Temperature :	20~22°C
Test Channel :	00	Relative Humidity :	51~56%
Test Engineer :	Stan Hsieh	Polarization :	Vertical
Remark :	2402 MHz is fundamental signal which can be ignored.		

Frequency (MHz)	Level (dBμV/m)	Over Limit (dB)	Limit Line (dBμV/m)	Read Level (dBμV)	Antenna Factor (dB)	Cable Loss (dB)	Preamp Factor (dB)	Ant Pos (cm)	Table Pos (deg)	Remark
42.96	38.54	-1.46	40	57.2	11.9	0.64	31.2	100	187	Peak
143.4	36.69	-6.81	43.5	55.09	11.5	1.2	31.1	-	-	Peak
215.22	35.89	-7.61	43.5	56.3	9.25	1.39	31.05	-	-	Peak
398	38.11	-7.89	46	51.06	15.82	2.14	30.91	-	-	Peak
748.7	39.64	-6.36	46	44.87	22.11	3.06	30.4	-	-	Peak
799.1	42.53	-3.47	46	47.7	21.99	3.14	30.3	-	-	Peak
2402	87.36	-	-	82.45	32.3	6.91	34.3	163	100	Peak
2402	62.57	-	-	-	-	-	-	-	-	Average
4803	62.67	-11.33	74	78.9	33.98	8.75	58.96	100	0	Peak
4803	37.88	-16.12	54	-	-	-	-	-	-	Average

Note: 1. Other harmonics are lower than background noise.

2. Average Emission Level = Peak Emission Level + duty cycle correction factor(-24.79)



Test Mode :	1Mbps	Temperature :	20~22°C
Test Channel :	39	Relative Humidity :	51~56%
Test Engineer :	Stan Hsieh	Polarization :	Horizontal
Remark :	2442 MHz is fundamental signal which can be ignored.		

Frequency (MHz)	Level (dBμV/m)	Over Limit (dB)	Limit Line (dBμV/m)	Read Level (dBμV)	Antenna Factor (dB)	Cable Loss (dB)	Preamp Factor (dB)	Ant Pos (cm)	Table Pos (deg)	Remark
2442	88.56	-	-	83.61	32.35	6.99	34.39	198	242	Peak
2442	63.77	-	-	-	-	-	-	-	-	Average
4884	56.62	-17.38	74	72.65	33.95	8.85	58.83	100	0	Peak
4884	31.83	-22.17	54	-	-	-	-	-	-	Average
7326	47.61	-26.39	74	58.88	35.53	10.94	57.74	100	0	Peak
7326	22.82	-31.18	54	-	-	-	-	-	-	Average

- Note:** 1. Other harmonics are lower than background noise.
 2. Average Emission Level = Peak Emission Level + duty cycle correction factor(-24.79)

Test Mode :	1Mbps	Temperature :	20~22°C
Test Channel :	39	Relative Humidity :	51~56%
Test Engineer :	Stan Hsieh	Polarization :	Vertical
Remark :	2442 MHz is fundamental signal which can be ignored.		

Frequency (MHz)	Level (dBμV/m)	Over Limit (dB)	Limit Line (dBμV/m)	Read Level (dBμV)	Antenna Factor (dB)	Cable Loss (dB)	Preamp Factor (dB)	Ant Pos (cm)	Table Pos (deg)	Remark
2442	90	-	-	85.05	32.35	6.99	34.39	126	97	Peak
2442	65.21	-	-	-	-	-	-	-	-	Average
4884	57.84	-16.16	74	73.87	33.95	8.85	58.83	100	0	Peak
4884	33.05	-20.95	54	-	-	-	-	-	-	Average
7323	53.42	-20.58	74	64.72	35.53	10.91	57.74	100	0	Peak
7323	28.63	-25.37	54	-	-	-	-	-	-	Average

- Note:** 1. Other harmonics are lower than background noise.
 2. Average Emission Level = Peak Emission Level + duty cycle correction factor(-24.79)



Test Mode :	1Mbps	Temperature :	20~22°C
Test Channel :	78	Relative Humidity :	51~56%
Test Engineer :	Stan Hsieh	Polarization :	Horizontal
Remark :	2480 MHz is fundamental signal which can be ignored.		

Frequency (MHz)	Level (dBµV/m)	Over Limit (dB)	Limit Line (dBµV/m)	Read Level (dBµV)	Antenna Factor (dB)	Cable Loss (dB)	Preamp Factor (dB)	Ant Pos (cm)	Table Pos (deg)	Remark
2480	97.22	-	-	92.21	32.38	7.06	34.43	136	148	Peak
2480	72.43	-	-	-	-	-	-	-	-	Average
4962	56.24	-17.76	74	72.07	33.91	8.92	58.66	100	0	Peak
4962	31.45	-22.55	54	-	-	-	-	-	-	Average
7440	48.26	-25.74	74	59.56	35.51	11.04	57.85	100	0	Peak
7440	23.47	-30.53	54	-	-	-	-	-	-	Average

- Note:** 1. Other harmonics are lower than background noise.
 2. Average Emission Level = Peak Emission Level + duty cycle correction factor(-24.79)

Test Mode :	1Mbps	Temperature :	20~22°C
Test Channel :	78	Relative Humidity :	51~56%
Test Engineer :	Stan Hsieh	Polarization :	Vertical
Remark :	2480 MHz is fundamental signal which can be ignored.		

Frequency (MHz)	Level (dBµV/m)	Over Limit (dB)	Limit Line (dBµV/m)	Read Level (dBµV)	Antenna Factor (dB)	Cable Loss (dB)	Preamp Factor (dB)	Ant Pos (cm)	Table Pos (deg)	Remark
2480	93.22	-	-	88.21	32.38	7.06	34.43	100	96	Peak
2480	68.43	-	-	-	-	-	-	-	-	Average
4962	57.78	-16.22	74	73.61	33.91	8.92	58.66	100	0	Peak
4962	32.99	-21.01	54	-	-	-	-	-	-	Average
7440	53.66	-20.34	74	64.96	35.51	11.04	57.85	100	0	Peak
7440	28.87	-25.13	54	-	-	-	-	-	-	Average

- Note:** 1. Other harmonics are lower than background noise.
 2. Average Emission Level = Peak Emission Level + duty cycle correction factor(-24.79)

3.9 AC Conducted Emission Measurement

3.9.1 Limit of AC Conducted Emission

For equipment that is designed to be connected to the public utility (AC) power line, the radio frequency voltage that is conducted back onto the AC power line on any frequency or frequencies within the band 150 kHz to 30 MHz shall not exceed the limits in the following table.

Frequency of emission (MHz)	Conducted limit (dB μ V)	
	Quasi-peak	Average
0.15-0.5	66 to 56*	56 to 46*
0.5-5	56	46
5-30	60	50

*Decreases with the logarithm of the frequency.

3.9.2 Measuring Instruments

The measuring equipment is listed in the section 4 of this test report.

3.9.3 Test Procedures

1. The EUT was placed 0.4 meter from the conducting wall of the shielding room was kept at least 80 centimeters from any other grounded conducting surface.
2. Connect EUT to the power mains through a line impedance stabilization network (LISN).
3. All the support units are connecting to the other LISN.
4. The LISN provides 50 ohm coupling impedance for the measuring instrument.
5. The FCC states that a 50 ohm, 50 microhenry LISN should be used.
6. Both sides of AC line were checked for maximum conducted interference.
7. The frequency range from 150 kHz to 30 MHz was searched.
8. Set the test-receiver system to Peak Detect Function and specified bandwidth with Maximum Hold Mode.

3.9.4 Test Setup

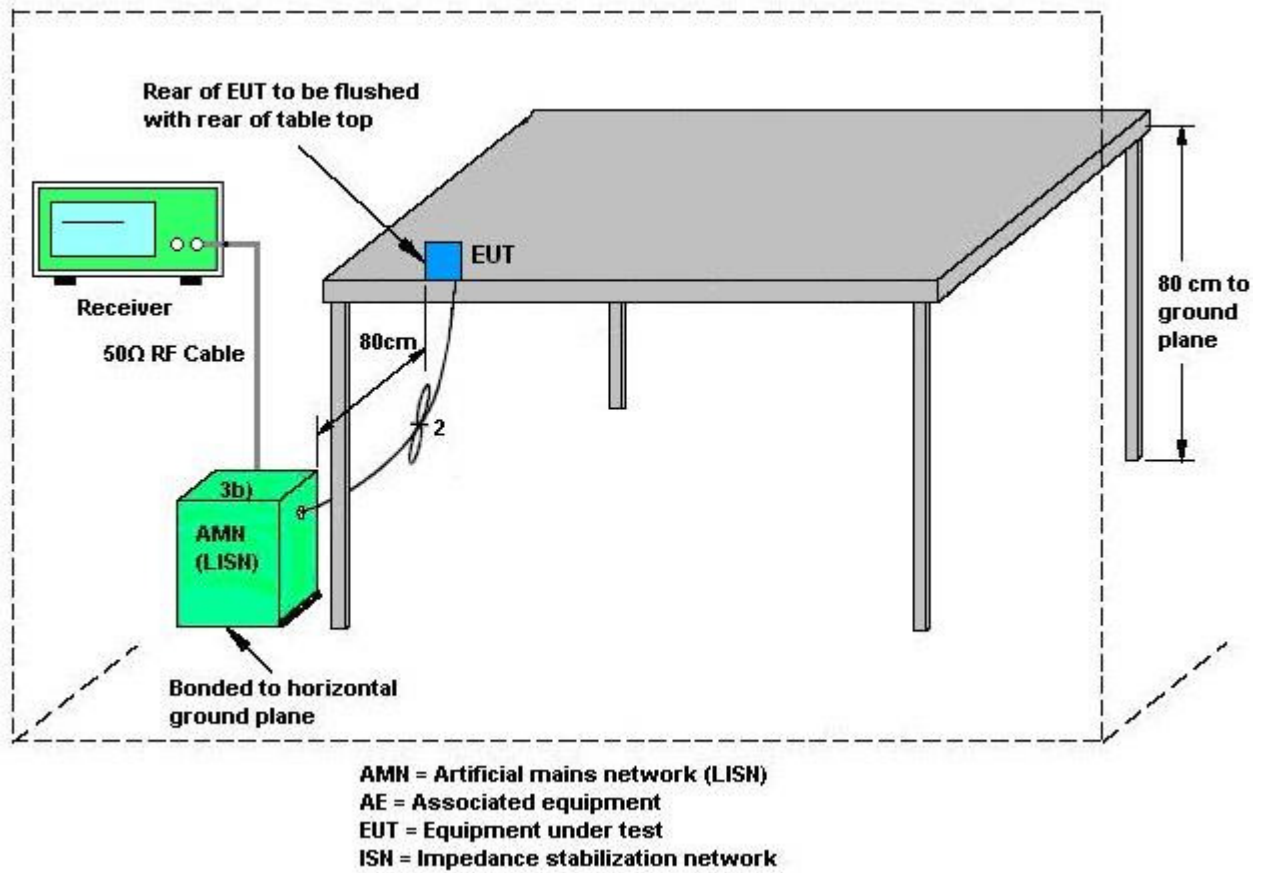

3.9.5 Test Result of AC Conducted Emission

Test Mode :	Mode 1	Temperature :	20~22°C
Test Engineer :	Cosmo Xu	Relative Humidity :	45~47%
Test Voltage :	120Vac / 60Hz	Phase :	Line
Function Type :	WLAN Link + Bluetooth Link + Adapter		

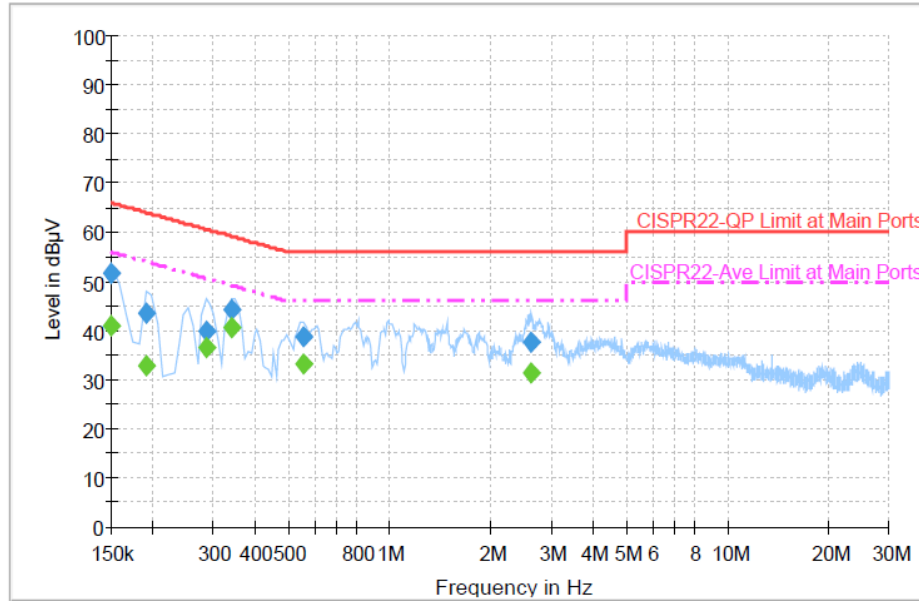

Final Result : Quasi-Peak

Frequency (MHz)	Quasi-Peak (dBµV)	Filter	Line	Corr. (dB)	Margin (dB)	Limit (dBµV)
0.150000	51.8	Off	L1	19.4	14.2	66.0
0.190000	43.4	Off	L1	19.4	20.6	64.0
0.286000	40.0	Off	L1	19.4	20.6	60.6
0.342000	44.2	Off	L1	19.4	15.0	59.2
0.558000	38.7	Off	L1	19.4	17.3	56.0
2.630000	37.5	Off	L1	19.6	18.5	56.0

Final Result : Average

Frequency (MHz)	Average (dBµV)	Filter	Line	Corr. (dB)	Margin (dB)	Limit (dBµV)
0.150000	41.1	Off	L1	19.4	14.9	56.0
0.190000	32.8	Off	L1	19.4	21.2	54.0
0.286000	36.5	Off	L1	19.4	14.1	50.6
0.342000	40.5	Off	L1	19.4	8.7	49.2
0.558000	33.2	Off	L1	19.4	12.8	46.0
2.630000	31.4	Off	L1	19.6	14.6	46.0



Test Mode :	Mode 1	Temperature :	20~22°C
Test Engineer :	Cosmo Xu	Relative Humidity :	45~47%
Test Voltage :	120Vac / 60Hz	Phase :	Neutral
Function Type :	WLAN Link + Bluetooth Link + Adapter		

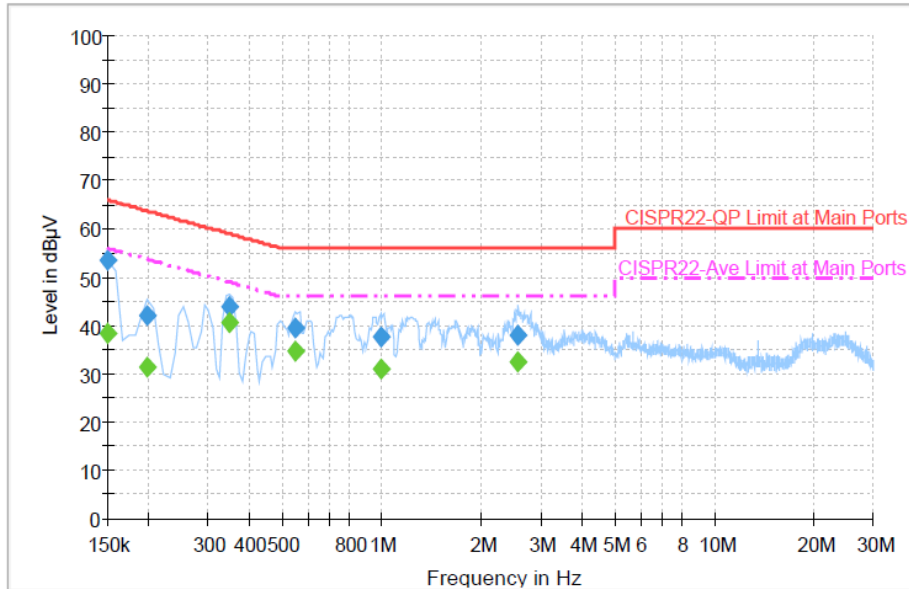

Final Result : Quasi-Peak

Frequency (MHz)	Quasi-Peak (dBµV)	Filter	Line	Corr. (dB)	Margin (dB)	Limit (dBµV)
0.150000	53.5	Off	N	19.4	12.5	66.0
0.198000	42.2	Off	N	19.3	21.5	63.7
0.350000	43.8	Off	N	19.4	15.2	59.0
0.550000	39.7	Off	N	19.4	16.3	56.0
0.990000	37.8	Off	N	19.4	18.2	56.0
2.574000	38.2	Off	N	19.6	17.8	56.0

Final Result : Average

Frequency (MHz)	Average (dBµV)	Filter	Line	Corr. (dB)	Margin (dB)	Limit (dBµV)
0.150000	38.4	Off	N	19.4	17.6	56.0
0.198000	31.5	Off	N	19.3	22.2	53.7
0.350000	40.5	Off	N	19.4	8.5	49.0
0.550000	34.9	Off	N	19.4	11.1	46.0
0.990000	30.9	Off	N	19.4	15.1	46.0
2.574000	32.6	Off	N	19.6	13.4	46.0



3.10 Antenna Requirements

3.10.1 Standard Applicable

If directional gain of transmitting antennas is greater than 6dBi, the power shall be reduced by the same level in dB comparing to gain minus 6dBi. The use of a permanently attached antenna or of an antenna that uses a unique coupling to the intentional radiator shall be considered sufficient to comply with the FCC rule.

3.10.2 Antenna Anti-Replacement Construction

Non-standard antenna connector is used.

3.10.3 Antenna Gain

The antenna peak gain of EUT is less than 6 dBi. Therefore, it is not necessary to reduce maximum peak output power limit.



4 List of Measuring Equipment

Instrument	Manufacturer	Model No.	Serial No.	Characteristics	Calibration Date	Test Date	Due Date	Remark
Spectrum Analyzer	Rohde & Schwarz	FSP40	100055	9kHz~40GHz	Jun. 07, 2013	Dec. 04, 2013~ Dec. 10, 2013	Jun. 06, 2014	Conducted (TH02-HY)
Power Meter	Agilent	E4416A	GB4129234 4	300MHz~40GHz	Feb. 05, 2013	Dec. 04, 2013~ Dec. 10, 2013	Feb. 04, 2014	Conducted (TH02-HY)
Power Sensor	Agilent	E9327A	US40441548	300MHz~40GHz	Feb. 05, 2013	Dec. 04, 2013~ Dec. 10, 2013	Feb. 04, 2014	Conducted (TH02-HY)
EMI Test Receiver	Rohde & Schwarz	ESCI 7	100724	9 kHz~7 GHz	Sep. 06, 2013	Dec. 11, 2013~ Dec. 12, 2013	Sep. 05, 2014	Radiation (03CH07-HY)
Spectrum Analyzer	Rohde & Schwarz	FSP30	101067	9 kHz ~ 30 GHz	Nov. 20, 2013	Dec. 11, 2013~ Dec. 12, 2013	Nov. 19, 2014	Radiation (03CH07-HY)
Loop Antenna	Rohde & Schwarz	HFH2-Z2	860004/0001	9 kHz~30 Mhz	Jul. 03, 2012	Dec. 11, 2013~ Dec. 12, 2013	Jul. 03, 2014	Radiation (03CH07-HY)
Bilog Antenna	Schaffner	CBL6111C	2726	30 MHz ~ 1 GHz	Oct. 10, 2013	Dec. 11, 2013~ Dec. 12, 2013	Oct. 09, 2014	Radiation (03CH07-HY)
Double Ridge Horn Antenna	ESCO	3117	75962	1 GHz~18 GHz	Aug. 22, 2013	Dec. 11, 2013~ Dec. 12, 2013	Aug. 21, 2014	Radiation (03CH07-HY)
SHF-EHF Horn Antenna	SCHWARZBECK	BBHA 9170	BBHA91702 51	15 GHz- 40 GHz	Oct. 03, 2013	Dec. 11, 2013~ Dec. 12, 2013	Oct. 02, 2014	Radiation (03CH07-HY)
Preamplifier	COM-POWER	PA-103A	161241	30 MHz~1 GHz	Feb. 26, 2013	Dec. 11, 2013~ Dec. 12, 2013	Feb. 25, 2014	Radiation (03CH07-HY)
Preamplifier	Agilent	8449B	3008A01917	1 GHz~26.5 GHz	Aug. 12, 2013	Dec. 11, 2013~ Dec. 12, 2013	Aug. 11, 2014	Radiation (03CH07-HY)
Preamplifier	MITEQ	AMF-7D-00 101800-30- 10P	159088	DC~18 G High Gain	Feb. 27, 2013	Dec. 11, 2013~ Dec. 12, 2013	Feb. 26, 2014	Radiation (03CH07-HY)
Turn Table	ChainTek	ChainTek 3000	N/A	0 ~ 360 degree	N/A	Dec. 11, 2013~ Dec. 12, 2013	N/A	Radiation (03CH07-HY)
Antenna Mast	ChainTek	ChainTek 3000	N/A	N/A	N/A	Dec. 11, 2013~ Dec. 12, 2013	N/A	Radiation (03CH07-HY)
EMI Test Receiver	Rohde & Schwarz	ESCS 30	100356	9kHz ~ 2.75GHz	Nov. 15, 2013	Dec. 10, 2013	Nov. 14, 2014	Conduction (CO05-HY)
Two-LISN (for auxiliary equipment)	Rohde & Schwarz	ENV216	100081	9kHz ~ 30MHz	Dec. 12, 2013	Dec. 10, 2013	Dec. 11, 2014	Conduction (CO05-HY)
Two-LISN	Rohde & Schwarz	ENV216	100080	9kHz ~ 30MHz	Dec. 04, 2013	Dec. 10, 2013	Dec. 03, 2014	Conduction (CO05-HY)
AC Power Source	APC	APC-1000 W	N/A	N/A	N/A	Dec. 10, 2013	N/A	Conduction (CO05-HY)



5 Uncertainty of Evaluation

Uncertainty of Conducted Emission Measurement (150 kHz ~ 30 MHz)

Measuring Uncertainty for a Level of Confidence of 95% ($U = 2Uc(y)$)	2.26
---	------

Uncertainty of Radiated Emission Measurement (30 MHz ~ 1000 MHz)

Measuring Uncertainty for a Level of Confidence of 95% ($U = 2Uc(y)$)	4.50
---	------