

802.11a Power Spectral Density - Ant 2 / Ant 0 + 1 + 2 + 3

Channel 36 (5180MHz)

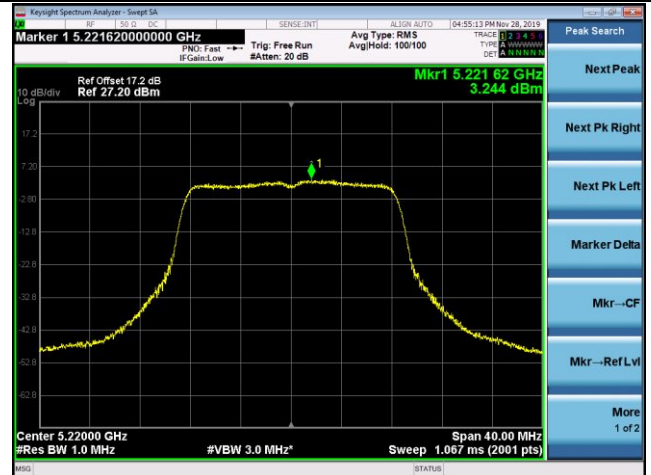

Channel 44 (5220MHz)



Channel 48 (5240MHz)

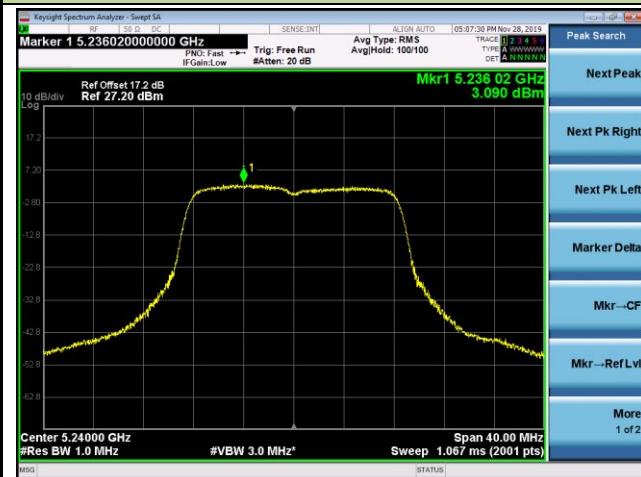

Channel 149 (5745MHz)

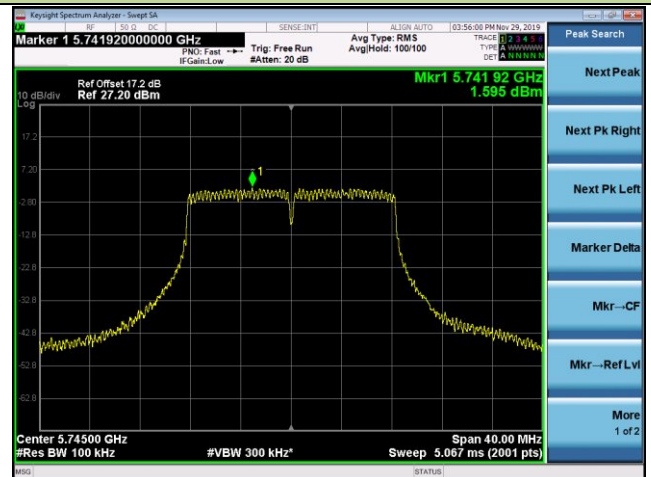

Channel 157 (5785MHz)

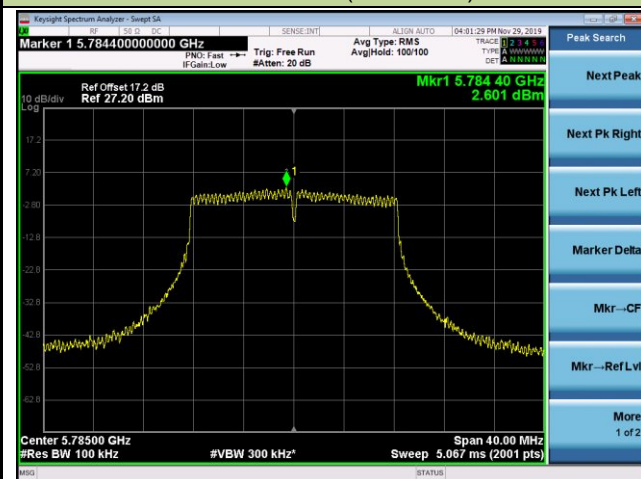

Channel 165 (5825MHz)



802.11n-HT20 Power Spectral Density - Ant 2 / Ant 0 + 1 + 2 + 3

Channel 36 (5180MHz)

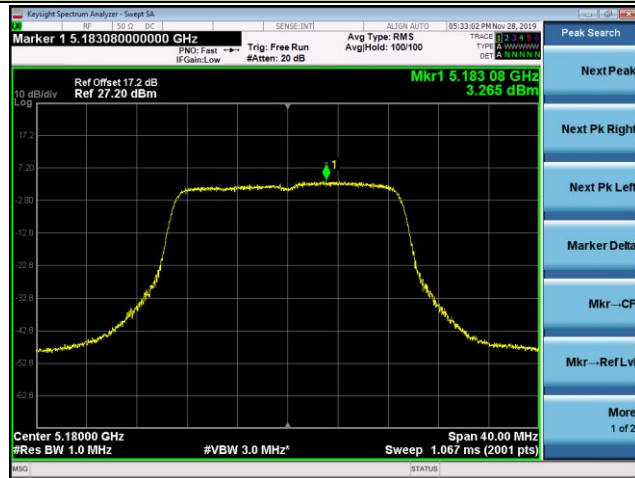

Channel 44 (5220MHz)

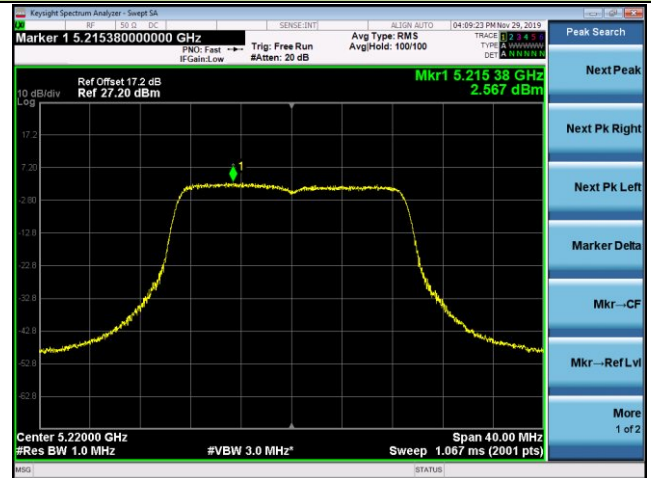

Channel 48 (5240MHz)

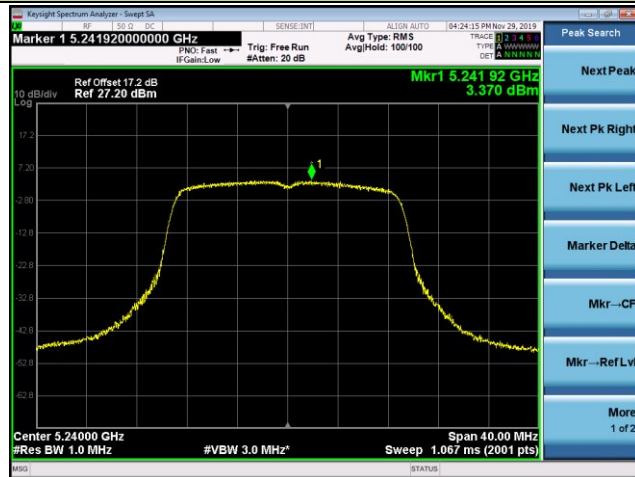

Channel 149 (5745MHz)



Channel 157 (5785MHz)

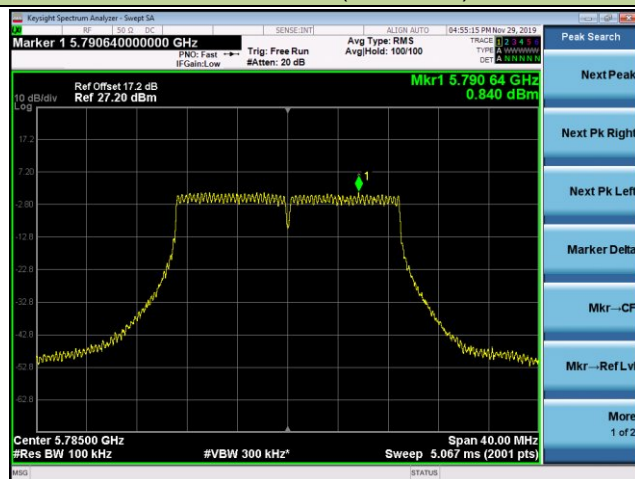

Channel 165 (5825MHz)



802.11n-HT40 Power Spectral Density - Ant 2 / Ant 0 + 1 + 2 + 3

Channel 38 (5190MHz)



Channel 46 (5230MHz)

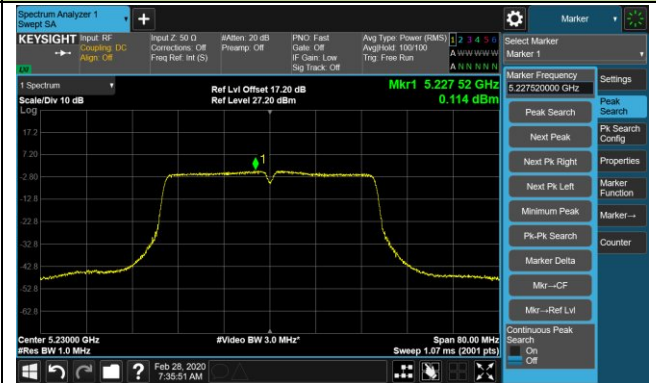

Channel 151 (5755MHz)



Channel 159 (5795MHz)



802.11ax-HE20 Power Spectral Density - Ant 2 / Ant 0 + 1 + 2 + 3

Channel 36 (5180MHz)

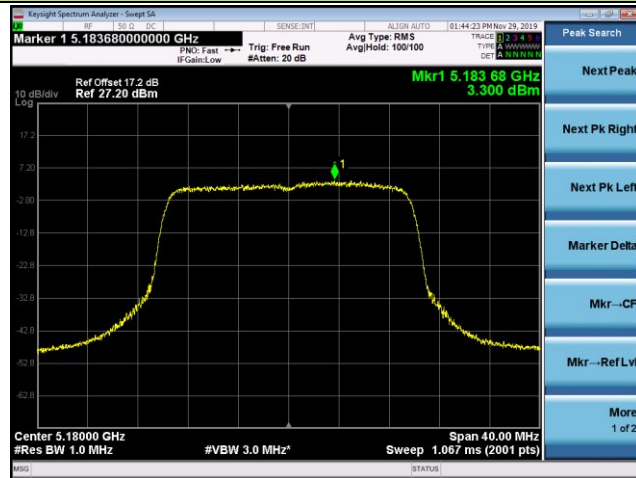

Channel 44 (5220MHz)



Channel 48 (5240MHz)

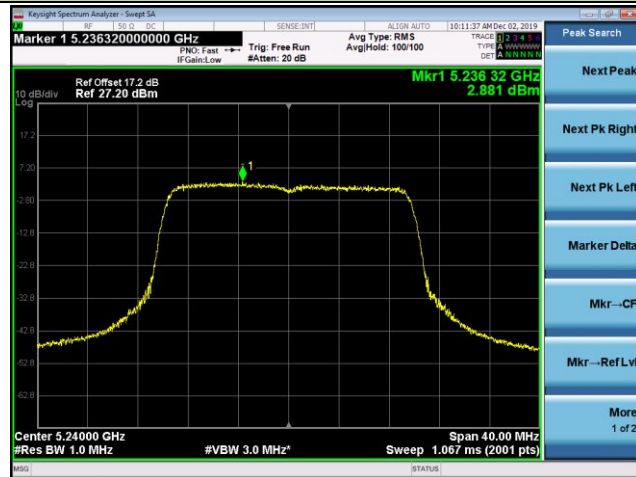

Channel 149 (5745MHz)



Channel 157 (5785MHz)



Channel 165 (5825MHz)



802.11ax-HE40 Power Spectral Density - Ant 2 / Ant 0 + 1 + 2 + 3

Channel 38 (5190MHz)



Channel 46 (5230MHz)

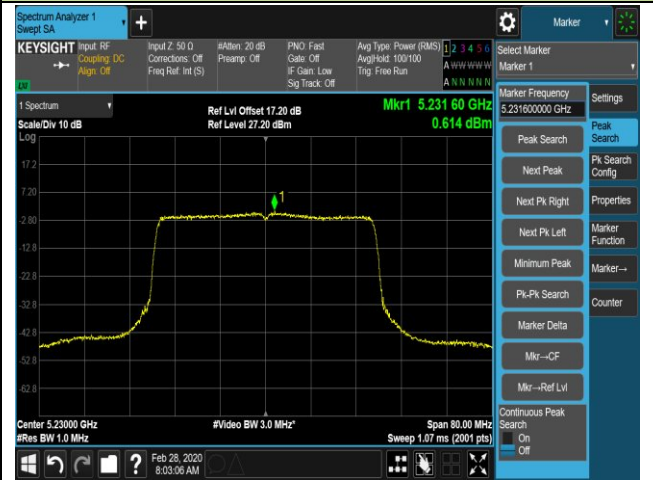

Channel 151 (5755MHz)

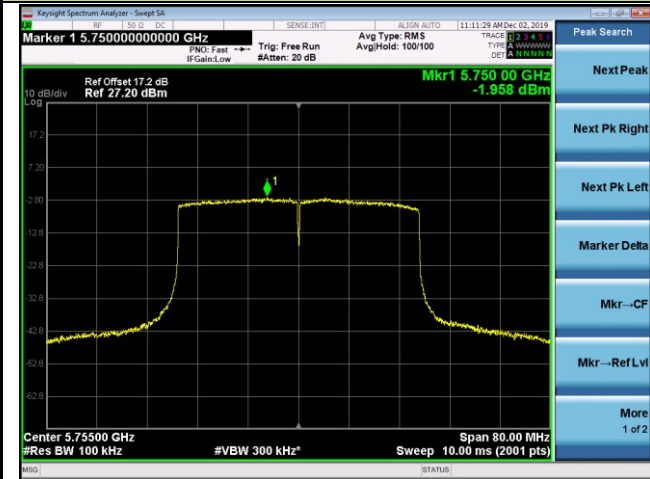

Channel 159 (5795MHz)



802.11ax-HE80 Power Spectral Density - Ant 2 / Ant 0 + 1 + 2 + 3

Channel 42 (5210MHz)



Channel 155 (5775MHz)



802.11a Power Spectral Density - Ant 3 / Ant 0 + 1 + 2 + 3

Channel 36 (5180MHz)



Channel 44 (5220MHz)

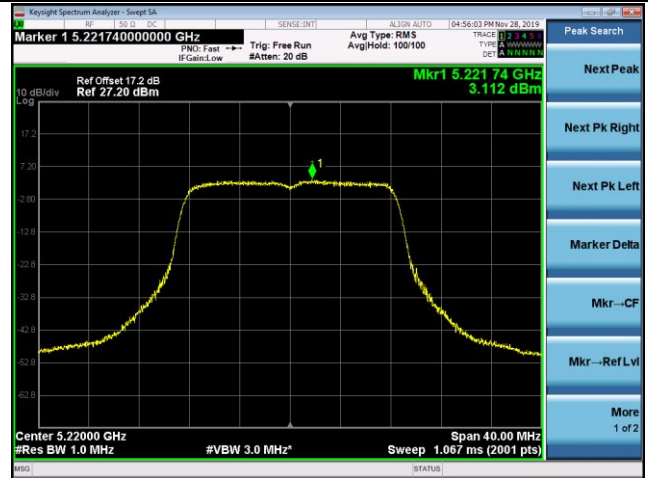

Channel 48 (5240MHz)

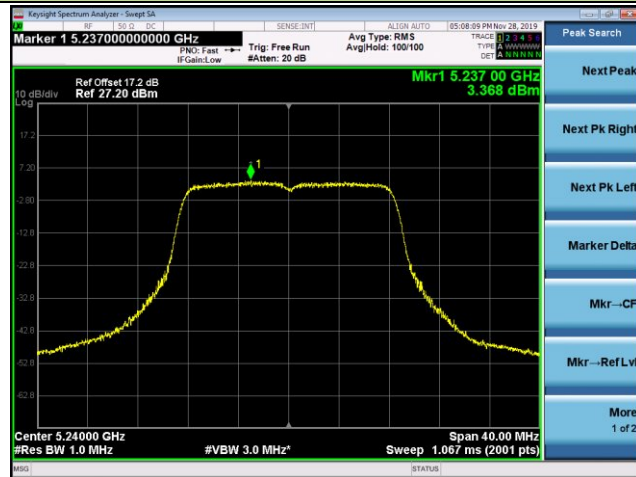

Channel 149 (5745MHz)

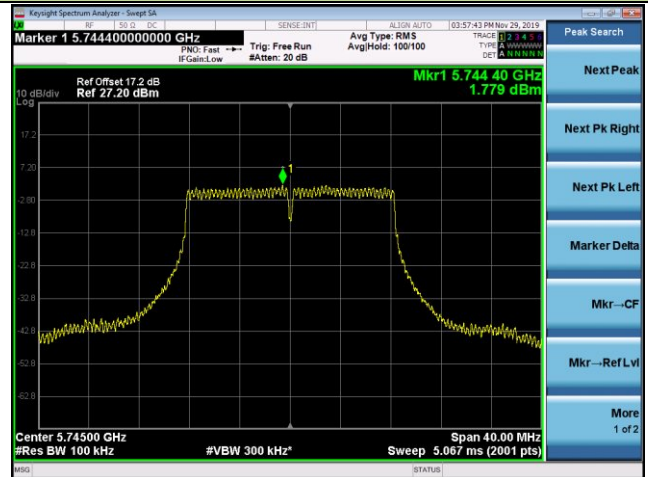

Channel 157 (5785MHz)

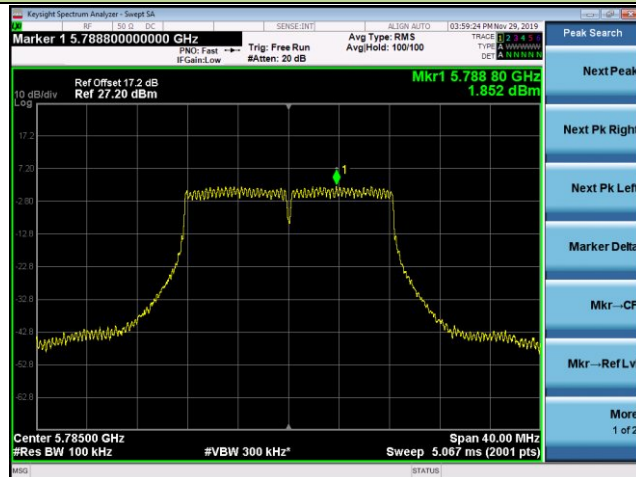

Channel 165 (5825MHz)



802.11n-HT20 Power Spectral Density - Ant 3 / Ant 0 + 1 + 2 + 3

Channel 36 (5180MHz)

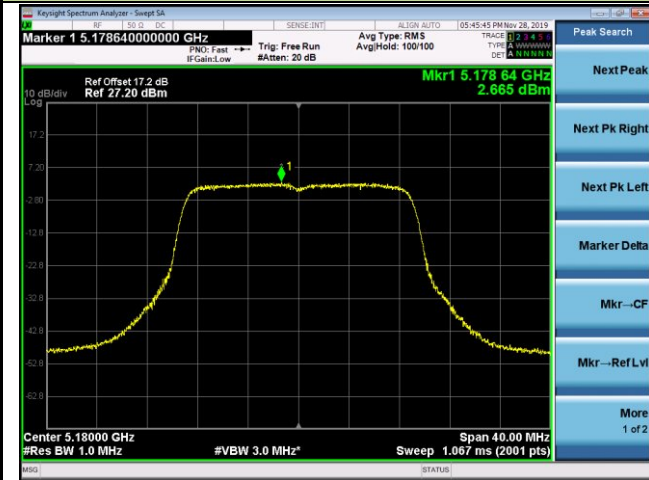

Channel 44 (5220MHz)

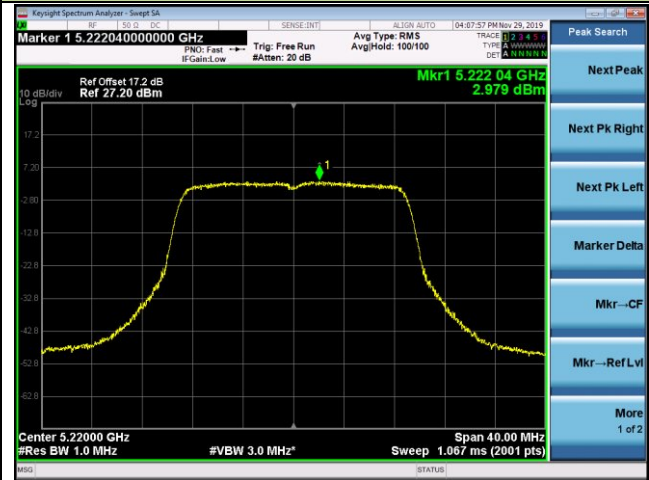

Channel 48 (5240MHz)

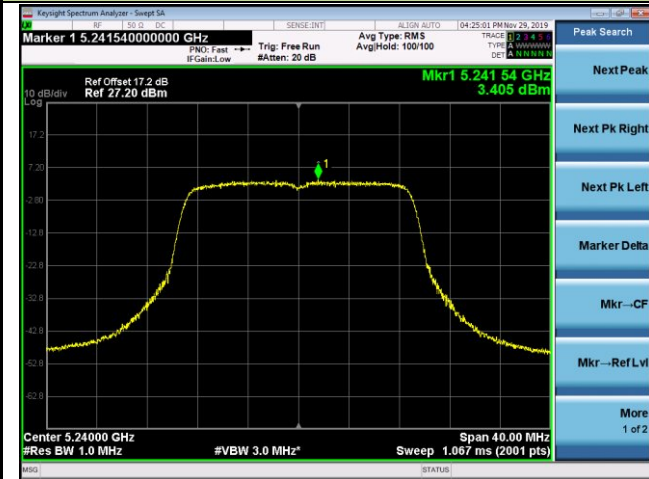

Channel 149 (5745MHz)

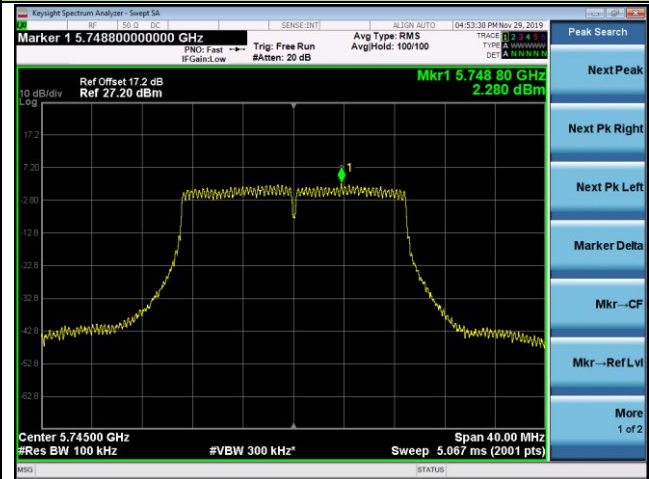

Channel 157 (5785MHz)

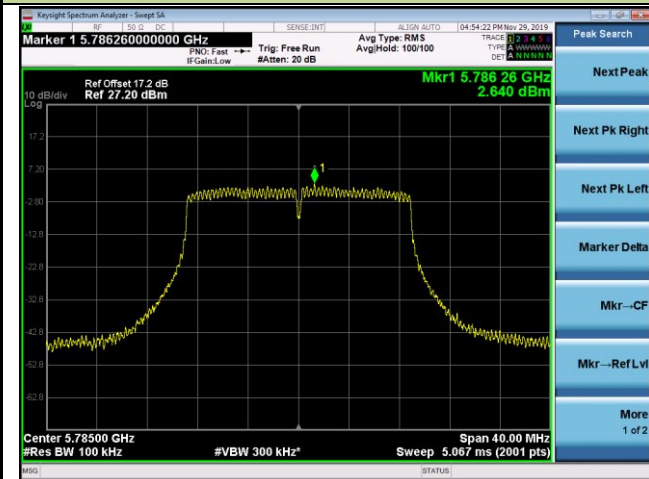

Channel 165 (5825MHz)



802.11n-HT40 Power Spectral Density - Ant 3 / Ant 0 + 1 + 2 + 3

Channel 38 (5190MHz)

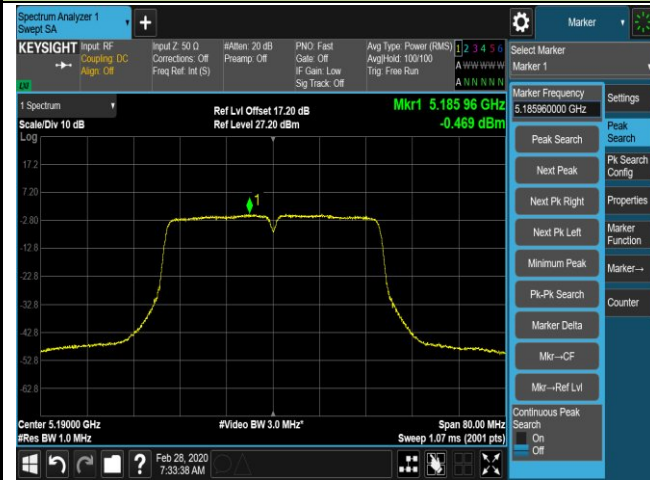

Channel 46 (5230MHz)

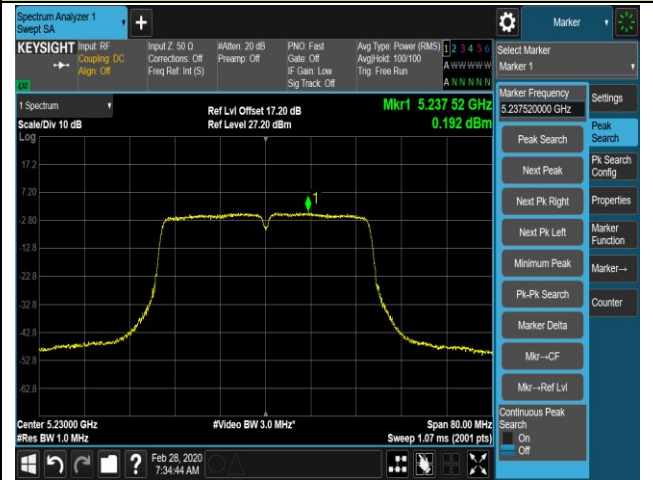

Channel 151 (5755MHz)



Channel 159 (5795MHz)



802.11ax-HE20 Power Spectral Density - Ant 3 / Ant 0 + 1 + 2 + 3

Channel 36 (5180MHz)

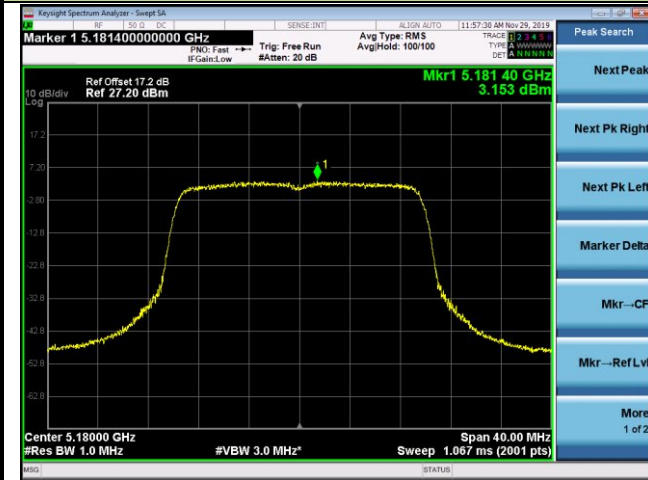

Channel 44 (5220MHz)

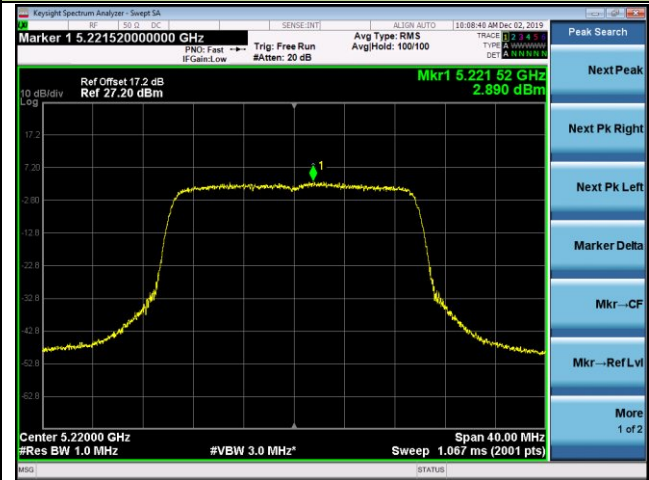

Channel 48 (5240MHz)



Channel 149 (5745MHz)



Channel 157 (5785MHz)



Channel 165 (5825MHz)



802.11ax-HE40 Power Spectral Density - Ant 3 / Ant 0 + 1 + 2 + 3

Channel 38 (5190MHz)



Channel 46 (5230MHz)



Channel 151 (5755MHz)



Channel 159 (5795MHz)



802.11ax-HE80 Power Spectral Density - Ant 3 / Ant 0 + 1 + 2 + 3

Channel 42 (5210MHz)

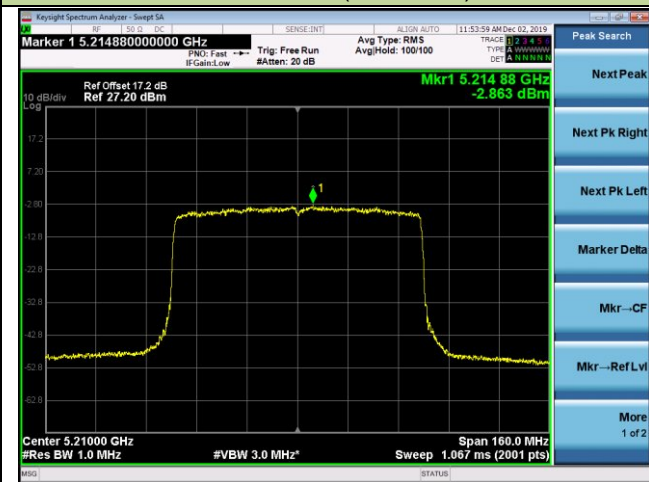

Channel 155 (5775MHz)



7.7. Frequency Stability Measurement

7.7.1. Test Limit

Manufactures of U-NII devices are responsible for ensuring frequency stability such that an emission is maintained within the band of operation under all conditions of normal operation as specified in the user's manual.

The transmitter center frequency tolerance shall be ± 20 ppm maximum for the 5GHz band (IEEE 802.11 specification).

7.7.2. Test Procedure Used

Frequency Stability Under Temperature Variations:

The equipment under test was connected to an external AC or DC power supply and input rated voltage. RF output was connected to a frequency counter or spectrum analyzer via feed through attenuators. The EUT was placed inside the temperature chamber. Set the spectrum analyzer RBW low enough to obtain the desired frequency resolution and measure EUT 20°C operating frequency as reference frequency. Turn EUT off and set the chamber temperature to highest. After the temperature stabilized for approximately 30 minutes recorded the frequency. Repeat step measure with 10°C decreased per stage until the lowest temperature reached.

Frequency Stability Under Voltage Variations:

Set chamber temperature to 20°C. Use a variable AC power supply / DC power source to power the EUT and set the voltage to rated voltage. Set the spectrum analyzer RBW low enough to obtain the desired frequency resolution and recorded the frequency.

Reduce the input voltage to specify extreme voltage variation ($\pm 15\%$) and endpoint, record the maximum frequency change.

7.7.3. Test Setup

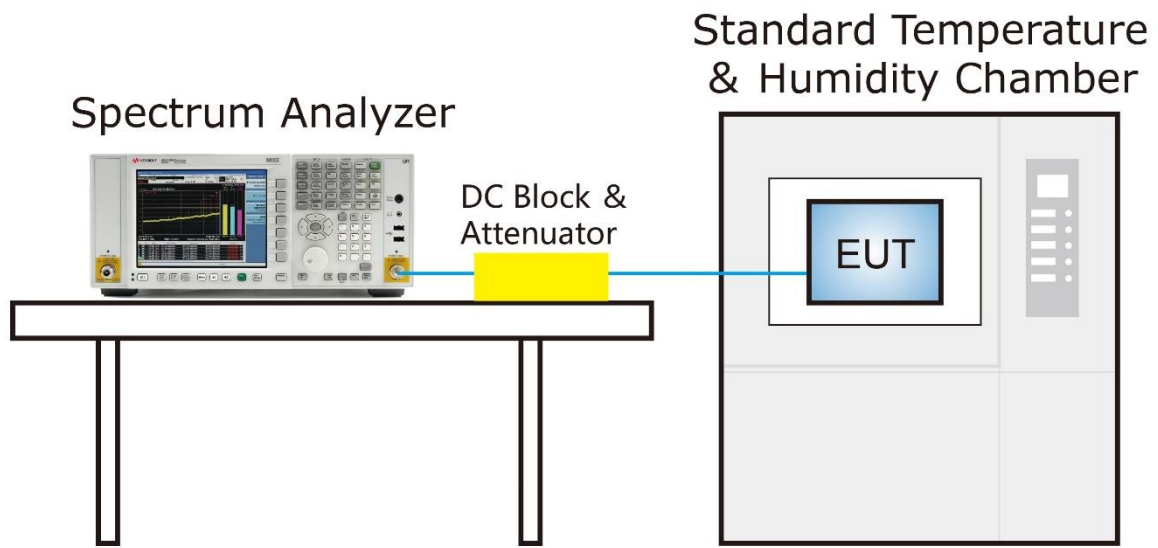

7.7.4. Test Result

| | | | |
|---------------|------------------------|-------------------|---------------------|
| Test Engineer | Eric Xu | Temperature | -40 ~ 50°C |
| Test Time | 2019/12/20 | Relative Humidity | 48 ~ 55%RH |
| Test Mode | 5180MHz (Carrier Mode) | Test Site | TR3 |
| Configuration | OAW-AP1361 | Test Item | Frequency Stability |

| Voltage (%) | Power (VAC) | Temp (°C) | Frequency Tolerance (ppm) | | | |
|-------------|-------------|------------|---------------------------|-----------|-----------|------------|
| | | | 0 minutes | 2 minutes | 5 minutes | 10 minutes |
| 100% | 120 | -40 | 2.71 | 2.85 | 2.81 | 2.67 |
| | | -30 | 2.71 | 2.84 | 2.81 | 2.97 |
| | | -20 | 2.72 | 2.87 | 2.85 | 2.73 |
| | | -10 | 2.74 | 2.79 | 2.85 | 2.90 |
| | | 0 | 2.76 | 2.60 | 2.71 | 2.55 |
| | | + 10 | 2.78 | 2.93 | 2.91 | 3.05 |
| | | + 20 (Ref) | 2.91 | 3.00 | 2.96 | 2.98 |
| | | + 30 | 2.87 | 2.98 | 3.03 | 2.95 |
| | | + 40 | 2.85 | 2.68 | 2.59 | 2.63 |
| | | + 50 | 2.83 | 2.83 | 2.77 | 2.90 |
| 115% | 138 | + 20 | 2.81 | 2.83 | 2.82 | 2.73 |
| 85% | 102 | + 20 | 2.79 | 2.66 | 2.73 | 2.83 |

Note: Frequency Tolerance (ppm) = $\{[\text{Measured Frequency (Hz)} - \text{Declared Frequency (Hz)}] / \text{Declared Frequency (Hz)}\} * 10^6$.

7.8. Radiated Spurious Emission Measurement

7.8.1. Test Limit

All out of band emissions appearing in a restricted band as specified in Section 15.205 of the Title 47 CFR must not exceed the limits shown in Table per Section 15.209.

| FCC Part 15 Subpart C Paragraph 15.209 | | |
|--|-----------------------|----------------------------|
| Frequency (MHz) | Field Strength (uV/m) | Measured Distance (Meters) |
| 0.009 - 0.490 | 2400/F (kHz) | 300 |
| 0.490 - 1.705 | 24000/F (kHz) | 30 |
| 1.705 - 30 | 30 | 30 |
| 30 - 88 | 100 | 3 |
| 88 - 216 | 150 | 3 |
| 216 - 960 | 200 | 3 |
| Above 960 | 500 | 3 |

7.8.2. Test Procedure Used

KDB 789033 D02v02r01 – Section G

7.8.3. Test Setting

Quasi-Peak & Average Measurements below 30MHz

1. Analyzer center frequency was set to the frequency of the radiated spurious emission of interest
2. Span was set greater than 1MHz
3. RBW = 200Hz for 9kHz to 150kHz frequency; RBW = 9kHz for 0.15MHz to 30MHz frequency
4. Detector = CISPR quasi-peak or power average (Average)
5. Sweep time = auto couple
6. Trace was allowed to stabilize

Quasi-Peak Measurements below 1GHz

1. Analyzer center frequency was set to the frequency of the radiated spurious emission of interest
2. Span was set greater than 1MHz
3. RBW = 120 kHz
4. Detector = CISPR quasi-peak
5. Sweep time = auto couple
6. Trace was allowed to stabilize

Peak Measurements above 1GHz

1. Analyzer center frequency was set to the frequency of the radiated spurious emission of interest
2. RBW = 1MHz
3. VBW = 3MHz
4. Detector = peak
5. Sweep time = auto couple
6. Trace mode = max hold
7. Trace was allowed to stabilize

Average Measurements above 1GHz (Method AD)

1. Analyzer center frequency was set to the frequency of the radiated spurious emission of interest
2. RBW = 1MHz
3. If duty cycle $\geq 98\%$, $VBW \leq RBW/100$ but not less than 10Hz; If duty cycle $< 98\%$, set $VBW \geq 1/T$.
4. Detector = Peak
5. Sweep time = auto
6. Trace mode = max hold
7. Allow max hold to run for at least 50 traces if the transmitted signal is continuous or has at least 98% duty cycle. For lower duty cycles, increase the minimum number of traces by a factor of $1/x$, where x is the duty cycle.

7.8.4. Test Setup

Below 1GHz Test Setup:

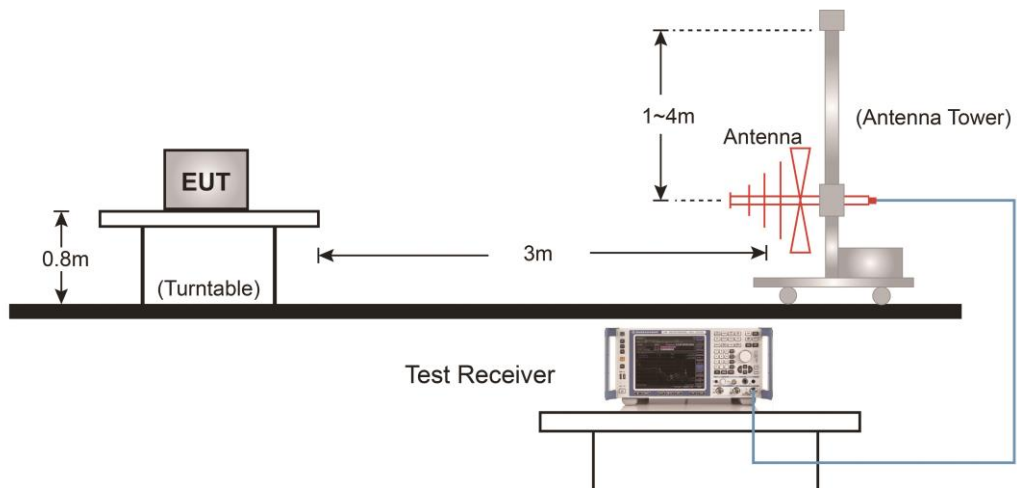

Above 1GHz Test Setup:

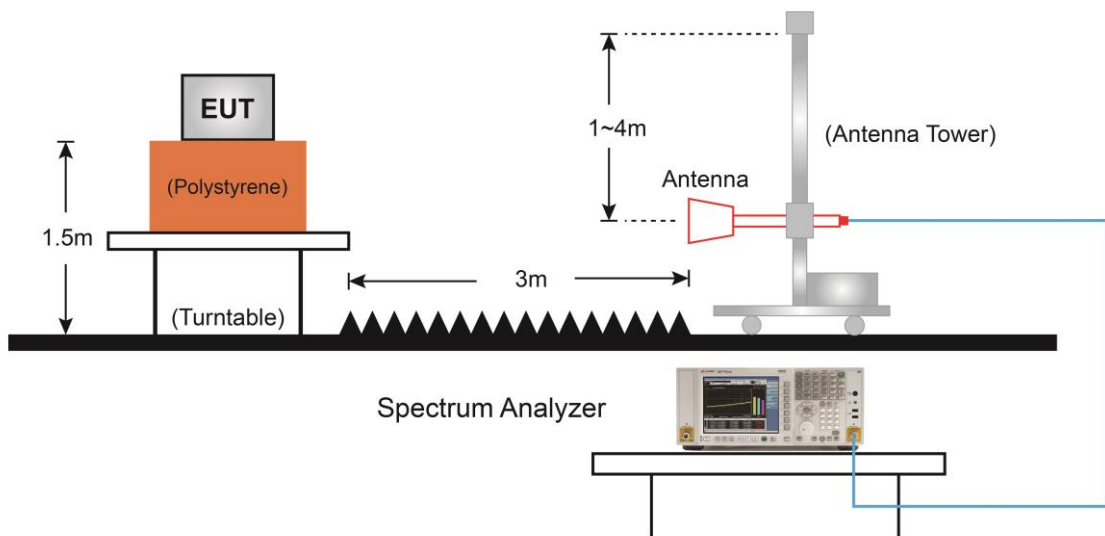

7.8.5. Test Result

| | | | |
|---------------|---|-------------------|-------------------------|
| Product | OmniAccess Stellar | Temperature | 22 ~ 26°C |
| Test Engineer | David Lv | Relative Humidity | 44 ~ 57 % |
| Test Site | AC1 | Test Date | 2019/11/26 ~ 2020/02/24 |
| Test Mode: | 802.11a - Ant 0 + 1 + 2 + 3 (CDD Mode) | Test Channel | 36 |
| Model No. | OAW-AP1361 | | |
| Remark: | 1. Average measurement was not performed if peak level lower than average limit. 2. Other frequency was 20dB below limit line within 1-18GHz, there is not show in the report. | | |

| Mark | Frequency (MHz) | Reading Level (dBμV) | Factor (dB) | Measure Level (dBμV/m) | Limit (dBμV/m) | Margin (dB) | Detector | Polarization |
|------|-----------------|----------------------|-------------|------------------------|----------------|-------------|----------|--------------|
| | 7426.0 | 31.5 | 11.9 | 43.4 | 74.0 | -30.6 | Peak | Horizontal |
| * | 7851.0 | 32.7 | 11.5 | 44.2 | 68.2 | -24.0 | Peak | Horizontal |
| * | 8760.5 | 31.5 | 12.7 | 44.2 | 68.2 | -24.0 | Peak | Horizontal |
| | 12075.5 | 30.3 | 19.7 | 50.0 | 74.0 | -24.0 | Peak | Horizontal |
| | 7519.5 | 32.7 | 11.6 | 44.3 | 74.0 | -29.7 | Peak | Vertical |
| * | 8692.5 | 31.5 | 12.4 | 43.9 | 68.2 | -24.3 | Peak | Vertical |
| * | 9865.5 | 31.9 | 14.1 | 46.0 | 68.2 | -22.2 | Peak | Vertical |
| | 11667.5 | 30.6 | 19.6 | 50.2 | 74.0 | -23.8 | Peak | Vertical |

Note 1: "*" is not in restricted band, its limit is -27dBm/MHz. At a distance of 3 meters, the field strength limit in dBμV/m can be determined by adding a "conversion" factor of 95.2dB to the EIRP limit of -27dBm/MHz to obtain the limit for out of band spurious emissions.

Note 2: Measure Level (dBμV/m) = Reading Level (dBμV) + Factor (dB)

Factor (dB) = Cable Loss (dB) + Antenna Factor (dB/m) - Pre_Amplifier Gain (dB)

| | | | |
|---------------|---|-------------------|-------------------------|
| Product | OmniAccess Stellar | Temperature | 22 ~ 26°C |
| Test Engineer | David Lv | Relative Humidity | 44 ~ 57 % |
| Test Site | AC1 | Test Date | 2019/11/26 ~ 2020/02/24 |
| Test Mode | 802.11a - Ant 0 + 1 + 2 + 3 (CDD Mode) | Test Channel | 44 |
| Model No. | OAW-AP1361 | | |
| Remark: | 1. Average measurement was not performed if peak level lower than average limit. 2. Other frequency was 20dB below limit line within 1-18GHz, there is not show in the report. | | |

| Mark | Frequency (MHz) | Reading Level (dBμV) | Factor (dB) | Measure Level (dBμV/m) | Limit (dBμV/m) | Margin (dB) | Detector | Polarization |
|------|-----------------|----------------------|-------------|------------------------|----------------|-------------|----------|--------------|
| | 7315.5 | 31.9 | 11.9 | 43.8 | 74.0 | -30.2 | Peak | Horizontal |
| * | 8726.5 | 30.2 | 12.8 | 43.0 | 68.2 | -25.2 | Peak | Horizontal |
| * | 10290.5 | 31.4 | 15.6 | 47.0 | 68.2 | -21.2 | Peak | Horizontal |
| | 11582.5 | 30.0 | 19.5 | 49.5 | 74.0 | -24.5 | Peak | Horizontal |
| | 7519.5 | 32.2 | 11.6 | 43.8 | 74.0 | -30.2 | Peak | Vertical |
| * | 8913.5 | 31.5 | 12.5 | 44.0 | 68.2 | -24.2 | Peak | Vertical |
| * | 10248.0 | 31.4 | 15.5 | 46.9 | 68.2 | -21.3 | Peak | Vertical |
| | 11446.5 | 30.2 | 19.3 | 49.5 | 74.0 | -24.5 | Peak | Vertical |

Note 1: "*" is not in restricted band, its limit is -27dBm/MHz. At a distance of 3 meters, the field strength limit in dBμV/m can be determined by adding a "conversion" factor of 95.2dB to the EIRP limit of -27dBm/MHz to obtain the limit for out of band spurious emissions.

Note 2: Measure Level (dBμV/m) = Reading Level (dBμV) + Factor (dB)

Factor (dB) = Cable Loss (dB) + Antenna Factor (dB/m) - Pre_Amplifier Gain (dB)

| | | | |
|---------------|---|-------------------|-------------------------|
| Product | OmniAccess Stellar | Temperature | 22 ~ 26°C |
| Test Engineer | David Lv | Relative Humidity | 44 ~ 57 % |
| Test Site | AC1 | Test Date | 2019/11/26 ~ 2020/02/24 |
| Test Mode | 802.11a - Ant 0 + 1 + 2 + 3 (CDD Mode) | Test Channel | 48 |
| Model No. | OAW-AP1361 | | |
| Remark: | 1. Average measurement was not performed if peak level lower than average limit. 2. Other frequency was 20dB below limit line within 1-18GHz, there is not show in the report. | | |

| Mark | Frequency (MHz) | Reading Level (dBμV) | Factor (dB) | Measure Level (dBμV/m) | Limit (dBμV/m) | Margin (dB) | Detector | Polarization |
|------|-----------------|----------------------|-------------|------------------------|----------------|-------------|----------|--------------|
| | 7638.5 | 32.4 | 11.3 | 43.7 | 74.0 | -30.4 | Peak | Horizontal |
| * | 9797.5 | 32.1 | 14.1 | 46.2 | 68.2 | -22.0 | Peak | Horizontal |
| * | 10248.0 | 31.7 | 15.5 | 47.2 | 68.2 | -21.0 | Peak | Horizontal |
| | 12016.0 | 29.9 | 19.6 | 49.5 | 74.0 | -24.5 | Peak | Horizontal |
| | 7536.5 | 30.3 | 11.7 | 42.0 | 74.0 | -32.0 | Peak | Vertical |
| * | 8811.5 | 30.1 | 12.8 | 42.9 | 68.2 | -25.3 | Peak | Vertical |
| * | 10214.0 | 30.2 | 15.0 | 45.2 | 68.2 | -23.0 | Peak | Vertical |
| | 11710.0 | 31.1 | 19.7 | 50.8 | 74.0 | -23.2 | Peak | Vertical |

Note 1: "*" is not in restricted band, its limit is -27dBm/MHz. At a distance of 3 meters, the field strength limit in dBμV/m can be determined by adding a "conversion" factor of 95.2dB to the EIRP limit of -27dBm/MHz to obtain the limit for out of band spurious emissions.

Note 2: Measure Level (dBμV/m) = Reading Level (dBμV) + Factor (dB)

Factor (dB) = Cable Loss (dB) + Antenna Factor (dB/m) - Pre_Amplifier Gain (dB)

| | | | |
|---------------|---|-------------------|-------------------------|
| Product | OmniAccess Stellar | Temperature | 22 ~ 26°C |
| Test Engineer | David Lv | Relative Humidity | 44 ~ 57 % |
| Test Site | AC1 | Test Date | 2019/11/26 ~ 2020/02/24 |
| Test Mode | 802.11a - Ant 0 + 1 + 2 + 3 (CDD Mode) | Test Channel | 149 |
| Model No. | OAW-AP1361 | | |
| Remark: | 1. Average measurement was not performed if peak level lower than average limit. 2. Other frequency was 20dB below limit line within 1-18GHz, there is not show in the report. | | |

| Mark | Frequency (MHz) | Reading Level (dBμV) | Factor (dB) | Measure Level (dBμV/m) | Limit (dBμV/m) | Margin (dB) | Detector | Polarization |
|------|-----------------|----------------------|-------------|------------------------|----------------|-------------|----------|--------------|
| | 7664.0 | 32.4 | 11.4 | 43.8 | 74.0 | -30.2 | Peak | Horizontal |
| * | 7893.5 | 31.9 | 11.6 | 43.5 | 68.2 | -24.7 | Peak | Horizontal |
| * | 9746.5 | 33.6 | 13.9 | 47.5 | 68.2 | -20.7 | Peak | Horizontal |
| | 10928.0 | 31.1 | 18.3 | 49.4 | 74.0 | -24.6 | Peak | Horizontal |
| | 8199.5 | 32.5 | 11.5 | 44.0 | 74.0 | -30.0 | Peak | Vertical |
| * | 8692.5 | 30.6 | 12.4 | 43.0 | 68.2 | -25.2 | Peak | Vertical |
| * | 9942.0 | 30.8 | 14.1 | 44.9 | 68.2 | -23.3 | Peak | Vertical |
| | 10681.5 | 29.6 | 17.2 | 46.8 | 74.0 | -27.2 | Peak | Vertical |

Note 1: "*" is not in restricted band, its limit is -27dBm/MHz. At a distance of 3 meters, the field strength limit in dBμV/m can be determined by adding a "conversion" factor of 95.2dB to the EIRP limit of -27dBm/MHz to obtain the limit for out of band spurious emissions.

Note 2: Measure Level (dBμV/m) = Reading Level (dBμV) + Factor (dB)

Factor (dB) = Cable Loss (dB) + Antenna Factor (dB/m) - Pre_Amplifier Gain (dB)

| | | | |
|---------------|---|-------------------|-------------------------|
| Product | OmniAccess Stellar | Temperature | 22 ~ 26°C |
| Test Engineer | David Lv | Relative Humidity | 44 ~ 57 % |
| Test Site | AC1 | Test Date | 2019/11/26 ~ 2020/02/24 |
| Test Mode | 802.11a - Ant 0 + 1 + 2 + 3 (CDD Mode) | Test Channel | 157 |
| Model No. | OAW-AP1361 | | |
| Remark: | 1. Average measurement was not performed if peak level lower than average limit. 2. Other frequency was 20dB below limit line within 1-18GHz, there is not show in the report. | | |

| Mark | Frequency (MHz) | Reading Level (dBμV) | Factor (dB) | Measure Level (dBμV/m) | Limit (dBμV/m) | Margin (dB) | Detector | Polarization |
|------|-----------------|----------------------|-------------|------------------------|----------------|-------------|----------|--------------|
| | 7672.5 | 32.9 | 11.4 | 44.3 | 74.0 | -29.7 | Peak | Horizontal |
| * | 7961.5 | 32.4 | 11.6 | 44.0 | 68.2 | -24.2 | Peak | Horizontal |
| * | 10375.5 | 31.8 | 16.1 | 47.9 | 68.2 | -20.3 | Peak | Horizontal |
| | 11650.5 | 30.2 | 19.7 | 49.9 | 74.0 | -24.1 | Peak | Horizontal |
| | 7434.5 | 31.8 | 11.8 | 43.6 | 74.0 | -30.4 | Peak | Vertical |
| * | 8811.5 | 29.6 | 12.8 | 42.4 | 68.2 | -25.8 | Peak | Vertical |
| * | 10307.5 | 31.4 | 15.7 | 47.1 | 68.2 | -21.1 | Peak | Vertical |
| | 12016.0 | 30.0 | 19.6 | 49.6 | 74.0 | -24.4 | Peak | Vertical |

Note 1: "*" is not in restricted band, its limit is -27dBm/MHz. At a distance of 3 meters, the field strength limit in dBμV/m can be determined by adding a "conversion" factor of 95.2dB to the EIRP limit of -27dBm/MHz to obtain the limit for out of band spurious emissions.

Note 2: Measure Level (dBμV/m) = Reading Level (dBμV) + Factor (dB)

Factor (dB) = Cable Loss (dB) + Antenna Factor (dB/m) - Pre_Amplifier Gain (dB)

| | | | |
|---------------|---|-------------------|-------------------------|
| Product | OmniAccess Stellar | Temperature | 22 ~ 26°C |
| Test Engineer | David Lv | Relative Humidity | 44 ~ 57 % |
| Test Site | AC1 | Test Date | 2019/11/26 ~ 2020/02/24 |
| Test Mode | 802.11a - Ant 0 + 1 + 2 + 3 (CDD Mode) | Test Channel | 165 |
| Model No. | OAW-AP1361 | | |
| Remark: | 1. Average measurement was not performed if peak level lower than average limit. 2. Other frequency was 20dB below limit line within 1-18GHz, there is not show in the report. | | |

| Mark | Frequency (MHz) | Reading Level (dBμV) | Factor (dB) | Measure Level (dBμV/m) | Limit (dBμV/m) | Margin (dB) | Detector | Polarization |
|------|-----------------|----------------------|-------------|------------------------|----------------|-------------|----------|--------------|
| | 7536.5 | 30.9 | 11.7 | 42.6 | 74.0 | -31.4 | Peak | Horizontal |
| * | 8658.5 | 31.4 | 12.3 | 43.7 | 68.2 | -24.5 | Peak | Horizontal |
| * | 9262.0 | 30.0 | 13.8 | 43.8 | 68.2 | -24.4 | Peak | Horizontal |
| | 10851.5 | 31.7 | 17.9 | 49.6 | 74.0 | -24.4 | Peak | Horizontal |
| | 7511.0 | 32.1 | 11.6 | 43.7 | 74.0 | -30.3 | Peak | Vertical |
| * | 8582.0 | 33.8 | 12.0 | 45.8 | 68.2 | -22.4 | Peak | Vertical |
| * | 9993.0 | 30.1 | 14.3 | 44.4 | 68.2 | -23.8 | Peak | Vertical |
| | 11540.0 | 30.4 | 19.9 | 50.3 | 74.0 | -23.7 | Peak | Vertical |

Note 1: "*" is not in restricted band, its limit is -27dBm/MHz. At a distance of 3 meters, the field strength limit in dBμV/m can be determined by adding a "conversion" factor of 95.2dB to the EIRP limit of -27dBm/MHz to obtain the limit for out of band spurious emissions.

Note 2: Measure Level (dBμV/m) = Reading Level (dBμV) + Factor (dB)

Factor (dB) = Cable Loss (dB) + Antenna Factor (dB/m) - Pre_Amplifier Gain (dB)

| | | | |
|---------------|---|-------------------|-------------------------|
| Product | OmniAccess Stellar | Temperature | 22 ~ 26°C |
| Test Engineer | David Lv | Relative Humidity | 44 ~ 57 % |
| Test Site | AC1 | Test Date | 2019/11/26 ~ 2020/02/24 |
| Test Mode | 802.11n-HT20 - Ant 0 + 1 + 2 + 3 (CDD Mode) | Test Channel | 36 |
| Model No. | OAW-AP1361 | | |
| Remark: | 1. Average measurement was not performed if peak level lower than average limit. 2. Other frequency was 20dB below limit line within 1-18GHz, there is not show in the report. | | |

| Mark | Frequency (MHz) | Reading Level (dBμV) | Factor (dB) | Measure Level (dBμV/m) | Limit (dBμV/m) | Margin (dB) | Detector | Polarization |
|------|-----------------|----------------------|-------------|------------------------|----------------|-------------|----------|--------------|
| | 7366.5 | 32.5 | 11.9 | 44.4 | 74.0 | -29.6 | Peak | Horizontal |
| * | 8769.0 | 30.0 | 12.7 | 42.7 | 68.2 | -25.5 | Peak | Horizontal |
| * | 10469.0 | 33.0 | 16.3 | 49.3 | 68.2 | -18.9 | Peak | Horizontal |
| | 10911.0 | 32.0 | 18.3 | 50.3 | 74.0 | -23.7 | Peak | Horizontal |
| | 7545.0 | 31.8 | 11.9 | 43.7 | 74.0 | -30.3 | Peak | Vertical |
| * | 8701.0 | 31.1 | 12.5 | 43.6 | 68.2 | -24.6 | Peak | Vertical |
| * | 10086.5 | 31.4 | 14.7 | 46.1 | 68.2 | -22.1 | Peak | Vertical |
| | 10894.0 | 30.7 | 18.3 | 49.0 | 74.0 | -25.0 | Peak | Vertical |

Note 1: "*" is not in restricted band, its limit is -27dBm/MHz. At a distance of 3 meters, the field strength limit in dBμV/m can be determined by adding a "conversion" factor of 95.2dB to the EIRP limit of -27dBm/MHz to obtain the limit for out of band spurious emissions.

Note 2: Measure Level (dBμV/m) = Reading Level (dBμV) + Factor (dB)

Factor (dB) = Cable Loss (dB) + Antenna Factor (dB/m) - Pre_Amplifier Gain (dB)

| | | | |
|---------------|---|-------------------|-------------------------|
| Product | OmniAccess Stellar | Temperature | 22 ~ 26°C |
| Test Engineer | David Lv | Relative Humidity | 44 ~ 57 % |
| Test Site | AC1 | Test Date | 2019/11/26 ~ 2020/02/24 |
| Test Mode | 802.11n-HT20 - Ant 0 + 1 + 2 + 3 (CDD Mode) | Test Channel | 44 |
| Model No. | OAW-AP1361 | | |
| Remark: | 1. Average measurement was not performed if peak level lower than average limit. 2. Other frequency was 20dB below limit line within 1-18GHz, there is not show in the report. | | |

| Mark | Frequency (MHz) | Reading Level (dBμV) | Factor (dB) | Measure Level (dBμV/m) | Limit (dBμV/m) | Margin (dB) | Detector | Polarization |
|------|-----------------|----------------------|-------------|------------------------|----------------|-------------|----------|--------------|
| | 7502.5 | 32.2 | 11.8 | 44.0 | 74.0 | -30.0 | Peak | Horizontal |
| * | 8760.5 | 31.5 | 12.7 | 44.2 | 68.2 | -24.0 | Peak | Horizontal |
| * | 9712.5 | 32.5 | 13.7 | 46.2 | 68.2 | -22.0 | Peak | Horizontal |
| | 10902.5 | 31.2 | 18.3 | 49.5 | 74.0 | -24.5 | Peak | Horizontal |
| | 7366.5 | 30.9 | 11.9 | 42.8 | 74.0 | -31.2 | Peak | Vertical |
| * | 8769.0 | 29.1 | 12.7 | 41.8 | 68.2 | -26.4 | Peak | Vertical |
| * | 9755.0 | 32.8 | 14.0 | 46.8 | 68.2 | -21.4 | Peak | Vertical |
| | 10834.5 | 31.0 | 17.7 | 48.7 | 74.0 | -25.3 | Peak | Vertical |

Note 1: "*" is not in restricted band, its limit is -27dBm/MHz. At a distance of 3 meters, the field strength limit in dBμV/m can be determined by adding a "conversion" factor of 95.2dB to the EIRP limit of -27dBm/MHz to obtain the limit for out of band spurious emissions.

Note 2: Measure Level (dBμV/m) = Reading Level (dBμV) + Factor (dB)

Factor (dB) = Cable Loss (dB) + Antenna Factor (dB/m) - Pre_Amplifier Gain (dB)

| | | | |
|---------------|---|-------------------|-------------------------|
| Product | OmniAccess Stellar | Temperature | 22 ~ 26°C |
| Test Engineer | David Lv | Relative Humidity | 44 ~ 57 % |
| Test Site | AC1 | Test Date | 2019/11/26 ~ 2020/02/24 |
| Test Mode | 802.11n-HT20 - Ant 0 + 1 + 2 + 3 (CDD Mode) | Test Channel | 48 |
| Model No. | OAW-AP1361 | | |
| Remark: | 1. Average measurement was not performed if peak level lower than average limit. 2. Other frequency was 20dB below limit line within 1-18GHz, there is not show in the report. | | |

| Mark | Frequency (MHz) | Reading Level (dBμV) | Factor (dB) | Measure Level (dBμV/m) | Limit (dBμV/m) | Margin (dB) | Detector | Polarization |
|------|-----------------|----------------------|-------------|------------------------|----------------|-------------|----------|--------------|
| | 7502.5 | 32.2 | 11.8 | 44.0 | 74.0 | -30.0 | Peak | Horizontal |
| * | 7893.5 | 32.0 | 11.6 | 43.6 | 68.2 | -24.6 | Peak | Horizontal |
| * | 8633.0 | 32.5 | 12.2 | 44.7 | 68.2 | -23.5 | Peak | Horizontal |
| | 9083.5 | 31.5 | 13.1 | 44.6 | 74.0 | -29.4 | Peak | Horizontal |
| | 7485.5 | 32.6 | 12.0 | 44.6 | 74.0 | -29.4 | Peak | Vertical |
| * | 7987.0 | 30.6 | 11.6 | 42.2 | 68.2 | -26.0 | Peak | Vertical |
| * | 8735.0 | 30.3 | 12.8 | 43.1 | 68.2 | -25.1 | Peak | Vertical |
| | 10885.5 | 31.4 | 18.3 | 49.7 | 74.0 | -24.3 | Peak | Vertical |

Note 1: "*" is not in restricted band, its limit is -27dBm/MHz. At a distance of 3 meters, the field strength limit in dBμV/m can be determined by adding a "conversion" factor of 95.2dB to the EIRP limit of -27dBm/MHz to obtain the limit for out of band spurious emissions.

Note 2: Measure Level (dBμV/m) = Reading Level (dBμV) + Factor (dB)

Factor (dB) = Cable Loss (dB) + Antenna Factor (dB/m) - Pre_Amplifier Gain (dB)

| | | | |
|---------------|---|-------------------|-------------------------|
| Product | OmniAccess Stellar | Temperature | 22 ~ 26°C |
| Test Engineer | David Lv | Relative Humidity | 44 ~ 57 % |
| Test Site | AC1 | Test Date | 2019/11/26 ~ 2020/02/24 |
| Test Mode | 802.11n-HT20 - Ant 0 + 1 + 2 + 3 (CDD Mode) | Test Channel | 149 |
| Model No. | OAW-AP1361 | | |
| Remark: | 1. Average measurement was not performed if peak level lower than average limit. 2. Other frequency was 20dB below limit line within 1-18GHz, there is not show in the report. | | |

| Mark | Frequency (MHz) | Reading Level (dBμV) | Factor (dB) | Measure Level (dBμV/m) | Limit (dBμV/m) | Margin (dB) | Detector | Polarization |
|------|-----------------|----------------------|-------------|------------------------|----------------|-------------|----------|--------------|
| | 7494.0 | 32.4 | 12.0 | 44.4 | 74.0 | -29.6 | Peak | Horizontal |
| * | 8004.0 | 32.7 | 11.7 | 44.4 | 68.2 | -23.8 | Peak | Horizontal |
| * | 9780.5 | 32.1 | 14.0 | 46.1 | 68.2 | -22.1 | Peak | Horizontal |
| | 10860.0 | 31.6 | 17.9 | 49.5 | 74.0 | -24.5 | Peak | Horizontal |
| | 8174.0 | 33.4 | 11.6 | 45.0 | 74.0 | -29.0 | Peak | Vertical |
| * | 8599.0 | 31.7 | 12.1 | 43.8 | 68.2 | -24.4 | Peak | Vertical |
| * | 9661.5 | 33.5 | 13.6 | 47.1 | 68.2 | -21.1 | Peak | Vertical |
| | 10962.0 | 32.0 | 18.5 | 50.5 | 74.0 | -23.5 | Peak | Vertical |

Note 1: "*" is not in restricted band, its limit is -27dBm/MHz. At a distance of 3 meters, the field strength limit in dBμV/m can be determined by adding a "conversion" factor of 95.2dB to the EIRP limit of -27dBm/MHz to obtain the limit for out of band spurious emissions.

Note 2: Measure Level (dBμV/m) = Reading Level (dBμV) + Factor (dB)

Factor (dB) = Cable Loss (dB) + Antenna Factor (dB/m) - Pre_Amplifier Gain (dB)

| | | | |
|---------------|---|-------------------|-------------------------|
| Product | OmniAccess Stellar | Temperature | 22 ~ 26°C |
| Test Engineer | David Lv | Relative Humidity | 44 ~ 57 % |
| Test Site | AC1 | Test Date | 2019/11/26 ~ 2020/02/24 |
| Test Mode | 802.11n-HT20 - Ant 0 + 1 + 2 + 3 (CDD Mode) | Test Channel | 157 |
| Model No. | OAW-AP1361 | | |
| Remark: | 1. Average measurement was not performed if peak level lower than average limit. 2. Other frequency was 20dB below limit line within 1-18GHz, there is not show in the report. | | |

| Mark | Frequency (MHz) | Reading Level (dBμV) | Factor (dB) | Measure Level (dBμV/m) | Limit (dBμV/m) | Margin (dB) | Detector | Polarization |
|------|-----------------|----------------------|-------------|------------------------|----------------|-------------|----------|--------------|
| | 7468.5 | 30.3 | 11.8 | 42.1 | 74.0 | -31.9 | Peak | Horizontal |
| * | 8582.0 | 32.4 | 12.0 | 44.4 | 68.2 | -23.8 | Peak | Horizontal |
| * | 9576.5 | 32.3 | 13.5 | 45.8 | 68.2 | -22.4 | Peak | Horizontal |
| | 10945.0 | 31.9 | 18.4 | 50.3 | 74.0 | -23.7 | Peak | Horizontal |
| | 7315.5 | 32.8 | 11.9 | 44.7 | 74.0 | -29.3 | Peak | Vertical |
| * | 8675.5 | 32.1 | 12.3 | 44.4 | 68.2 | -23.8 | Peak | Vertical |
| * | 9772.0 | 33.1 | 14.0 | 47.1 | 68.2 | -21.1 | Peak | Vertical |
| | 11514.5 | 30.5 | 19.5 | 50.0 | 74.0 | -24.0 | Peak | Vertical |

Note 1: "*" is not in restricted band, its limit is -27dBm/MHz. At a distance of 3 meters, the field strength limit in dBμV/m can be determined by adding a "conversion" factor of 95.2dB to the EIRP limit of -27dBm/MHz to obtain the limit for out of band spurious emissions.

Note 2: Measure Level (dBμV/m) = Reading Level (dBμV) + Factor (dB)

Factor (dB) = Cable Loss (dB) + Antenna Factor (dB/m) - Pre_Amplifier Gain (dB)

| | | | |
|---------------|---|-------------------|-------------------------|
| Product | OmniAccess Stellar | Temperature | 22 ~ 26°C |
| Test Engineer | David Lv | Relative Humidity | 44 ~ 57 % |
| Test Site | AC1 | Test Date | 2019/11/26 ~ 2020/02/24 |
| Test Mode | 802.11n-HT20 - Ant 0 + 1 + 2 + 3 (CDD Mode) | Test Channel | 165 |
| Model No. | OAW-AP1361 | | |
| Remark: | 1. Average measurement was not performed if peak level lower than average limit. 2. Other frequency was 20dB below limit line within 1-18GHz, there is not show in the report. | | |

| Mark | Frequency (MHz) | Reading Level (dBμV) | Factor (dB) | Measure Level (dBμV/m) | Limit (dBμV/m) | Margin (dB) | Detector | Polarization |
|------|-----------------|----------------------|-------------|------------------------|----------------|-------------|----------|--------------|
| | 7485.5 | 32.1 | 12.0 | 44.1 | 74.0 | -29.9 | Peak | Horizontal |
| * | 8726.5 | 31.5 | 12.8 | 44.3 | 68.2 | -23.9 | Peak | Horizontal |
| * | 9678.5 | 31.5 | 13.6 | 45.1 | 68.2 | -23.1 | Peak | Horizontal |
| | 10681.5 | 32.6 | 17.2 | 49.8 | 74.0 | -24.2 | Peak | Horizontal |
| | 7443.0 | 32.1 | 11.8 | 43.9 | 74.0 | -30.1 | Peak | Vertical |
| * | 8616.0 | 30.8 | 12.1 | 42.9 | 68.2 | -25.3 | Peak | Vertical |
| * | 10392.5 | 31.5 | 16.3 | 47.8 | 68.2 | -20.4 | Peak | Vertical |
| | 11523.0 | 30.1 | 19.5 | 49.6 | 74.0 | -24.4 | Peak | Vertical |

Note 1: "*" is not in restricted band, its limit is -27dBm/MHz. At a distance of 3 meters, the field strength limit in dBμV/m can be determined by adding a "conversion" factor of 95.2dB to the EIRP limit of -27dBm/MHz to obtain the limit for out of band spurious emissions.

Note 2: Measure Level (dBμV/m) = Reading Level (dBμV) + Factor (dB)

Factor (dB) = Cable Loss (dB) + Antenna Factor (dB/m) - Pre_Amplifier Gain (dB)

| | | | |
|---------------|---|-------------------|-------------------------|
| Product | OmniAccess Stellar | Temperature | 22 ~ 26°C |
| Test Engineer | David Lv | Relative Humidity | 44 ~ 57 % |
| Test Site | AC1 | Test Date | 2019/11/26 ~ 2020/02/24 |
| Test Mode | 802.11n-HT40 - Ant 0 + 1 + 2 + 3 (CDD Mode) | Test Channel | 38 |
| Model No. | OAW-AP1361 | | |
| Remark: | 1. Average measurement was not performed if peak level lower than average limit. 2. Other frequency was 20dB below limit line within 1-18GHz, there is not show in the report. | | |

| Mark | Frequency (MHz) | Reading Level (dBμV) | Factor (dB) | Measure Level (dBμV/m) | Limit (dBμV/m) | Margin (dB) | Detector | Polarization |
|------|-----------------|----------------------|-------------|------------------------|----------------|-------------|----------|--------------|
| | 7366.5 | 32.0 | 11.9 | 43.9 | 74.0 | -30.1 | Peak | Horizontal |
| * | 7953.0 | 33.7 | 11.6 | 45.3 | 68.2 | -22.9 | Peak | Horizontal |
| * | 8718.0 | 32.0 | 12.8 | 44.8 | 68.2 | -23.4 | Peak | Horizontal |
| | 9185.5 | 31.3 | 13.6 | 44.9 | 74.0 | -29.1 | Peak | Horizontal |
| | 7324.0 | 32.0 | 12.0 | 44.0 | 74.0 | -30.0 | Peak | Vertical |
| * | 7825.5 | 32.2 | 11.5 | 43.7 | 68.2 | -24.5 | Peak | Vertical |
| * | 9993.0 | 30.1 | 14.3 | 44.4 | 68.2 | -23.8 | Peak | Vertical |
| | 10936.5 | 32.1 | 18.3 | 50.4 | 74.0 | -23.6 | Peak | Vertical |

Note 1: "*" is not in restricted band, its limit is -27dBm/MHz. At a distance of 3 meters, the field strength limit in dBμV/m can be determined by adding a "conversion" factor of 95.2dB to the EIRP limit of -27dBm/MHz to obtain the limit for out of band spurious emissions.

Note 2: Measure Level (dBμV/m) = Reading Level (dBμV) + Factor (dB)

Factor (dB) = Cable Loss (dB) + Antenna Factor (dB/m) - Pre_Amplifier Gain (dB)

| | | | |
|---------------|---|-------------------|-------------------------|
| Product | OmniAccess Stellar | Temperature | 22 ~ 26°C |
| Test Engineer | David Lv | Relative Humidity | 44 ~ 57 % |
| Test Site | AC1 | Test Date | 2019/11/26 ~ 2020/02/24 |
| Test Mode | 802.11n-HT40 - Ant 0 + 1 + 2 + 3 (CDD Mode) | Test Channel | 46 |
| Model No. | OAW-AP1361 | | |
| Remark: | 1. Average measurement was not performed if peak level lower than average limit. 2. Other frequency was 20dB below limit line within 1-18GHz, there is not show in the report. | | |

| Mark | Frequency (MHz) | Reading Level (dBμV) | Factor (dB) | Measure Level (dBμV/m) | Limit (dBμV/m) | Margin (dB) | Detector | Polarization |
|------|-----------------|----------------------|-------------|------------------------|----------------|-------------|----------|--------------|
| | 7307.0 | 31.6 | 11.9 | 43.5 | 74.0 | -30.5 | Peak | Horizontal |
| * | 8616.0 | 30.6 | 12.1 | 42.7 | 68.2 | -25.5 | Peak | Horizontal |
| * | 10265.0 | 32.0 | 15.4 | 47.4 | 68.2 | -20.8 | Peak | Horizontal |
| | 12143.5 | 30.3 | 19.7 | 50.0 | 74.0 | -24.0 | Peak | Horizontal |
| | 7273.0 | 31.5 | 11.8 | 43.3 | 74.0 | -30.7 | Peak | Vertical |
| * | 7944.5 | 33.0 | 11.6 | 44.6 | 68.2 | -23.6 | Peak | Vertical |
| * | 8718.0 | 31.4 | 12.8 | 44.2 | 68.2 | -24.0 | Peak | Vertical |
| | 9423.5 | 30.5 | 13.3 | 43.8 | 74.0 | -30.2 | Peak | Vertical |

Note 1: "*" is not in restricted band, its limit is -27dBm/MHz. At a distance of 3 meters, the field strength limit in dBμV/m can be determined by adding a "conversion" factor of 95.2dB to the EIRP limit of -27dBm/MHz to obtain the limit for out of band spurious emissions.

Note 2: Measure Level (dBμV/m) = Reading Level (dBμV) + Factor (dB)

Factor (dB) = Cable Loss (dB) + Antenna Factor (dB/m) - Pre_Amplifier Gain (dB)

| | | | |
|---------------|---|-------------------|-------------------------|
| Product | OmniAccess Stellar | Temperature | 22 ~ 26°C |
| Test Engineer | David Lv | Relative Humidity | 44 ~ 57 % |
| Test Site | AC1 | Test Date | 2019/11/26 ~ 2020/02/24 |
| Test Mode | 802.11n-HT40 - Ant 0 + 1 + 2 + 3 (CDD Mode) | Test Channel | 151 |
| Model No. | OAW-AP1361 | | |
| Remark: | 1. Average measurement was not performed if peak level lower than average limit. 2. Other frequency was 20dB below limit line within 1-18GHz, there is not show in the report. | | |

| Mark | Frequency (MHz) | Reading Level (dBμV) | Factor (dB) | Measure Level (dBμV/m) | Limit (dBμV/m) | Margin (dB) | Detector | Polarization |
|------|-----------------|----------------------|-------------|------------------------|----------------|-------------|----------|--------------|
| | 7519.5 | 32.1 | 11.6 | 43.7 | 74.0 | -30.3 | Peak | Horizontal |
| * | 8879.5 | 32.8 | 12.7 | 45.5 | 68.2 | -22.7 | Peak | Horizontal |
| * | 9857.0 | 31.0 | 14.1 | 45.1 | 68.2 | -23.1 | Peak | Horizontal |
| | 10928.0 | 32.1 | 18.3 | 50.4 | 74.0 | -23.6 | Peak | Horizontal |
| | 7511.0 | 32.1 | 11.6 | 43.7 | 74.0 | -30.3 | Peak | Vertical |
| * | 7893.5 | 31.6 | 11.6 | 43.2 | 68.2 | -25.0 | Peak | Vertical |
| * | 8922.0 | 31.0 | 12.5 | 43.5 | 68.2 | -24.7 | Peak | Vertical |
| | 11106.5 | 30.7 | 18.4 | 49.1 | 74.0 | -24.9 | Peak | Vertical |

Note 1: "*" is not in restricted band, its limit is -27dBm/MHz. At a distance of 3 meters, the field strength limit in dBμV/m can be determined by adding a "conversion" factor of 95.2dB to the EIRP limit of -27dBm/MHz to obtain the limit for out of band spurious emissions.

Note 2: Measure Level (dBμV/m) = Reading Level (dBμV) + Factor (dB)

Factor (dB) = Cable Loss (dB) + Antenna Factor (dB/m) - Pre_Amplifier Gain (dB)

| | | | |
|---------------|---|-------------------|-------------------------|
| Product | OmniAccess Stellar | Temperature | 22 ~ 26°C |
| Test Engineer | David Lv | Relative Humidity | 44 ~ 57 % |
| Test Site | AC1 | Test Date | 2019/11/26 ~ 2020/02/24 |
| Test Mode | 802.11n-HT40 - Ant 0 + 1 + 2 + 3 (CDD Mode) | Test Channel | 159 |
| Model No. | OAW-AP1361 | | |
| Remark: | 1. Average measurement was not performed if peak level lower than average limit. 2. Other frequency was 20dB below limit line within 1-18GHz, there is not show in the report. | | |

| Mark | Frequency (MHz) | Reading Level (dBμV) | Factor (dB) | Measure Level (dBμV/m) | Limit (dBμV/m) | Margin (dB) | Detector | Polarization |
|------|-----------------|----------------------|-------------|------------------------|----------------|-------------|----------|--------------|
| | 7536.5 | 32.1 | 11.7 | 43.8 | 74.0 | -30.2 | Peak | Horizontal |
| * | 8616.0 | 31.6 | 12.1 | 43.7 | 68.2 | -24.5 | Peak | Horizontal |
| * | 10579.5 | 32.1 | 16.8 | 48.9 | 68.2 | -19.3 | Peak | Horizontal |
| | 11497.5 | 29.5 | 19.9 | 49.4 | 74.0 | -24.6 | Peak | Horizontal |
| | 7468.5 | 30.7 | 11.8 | 42.5 | 74.0 | -31.5 | Peak | Vertical |
| * | 8692.5 | 31.0 | 12.4 | 43.4 | 68.2 | -24.8 | Peak | Vertical |
| * | 9636.0 | 31.7 | 13.7 | 45.4 | 68.2 | -22.8 | Peak | Vertical |
| | 10902.5 | 32.2 | 18.3 | 50.5 | 74.0 | -23.5 | Peak | Vertical |

Note 1: "*" is not in restricted band, its limit is -27dBm/MHz. At a distance of 3 meters, the field strength limit in dBμV/m can be determined by adding a "conversion" factor of 95.2dB to the EIRP limit of -27dBm/MHz to obtain the limit for out of band spurious emissions.

Note 2: Measure Level (dBμV/m) = Reading Level (dBμV) + Factor (dB)

Factor (dB) = Cable Loss (dB) + Antenna Factor (dB/m) - Pre_Amplifier Gain (dB)

| | | | |
|---------------|---|-------------------|-------------------------|
| Product | OmniAccess Stellar | Temperature | 22 ~ 26°C |
| Test Engineer | David Lv | Relative Humidity | 44 ~ 57 % |
| Test Site | AC1 | Test Date | 2019/11/26 ~ 2020/02/24 |
| Test Mode | 802.11ax-HE20 - Ant 0 + 1 + 2 + 3 (CDD Mode) | Test Channel | 36 |
| Model No. | OAW-AP1361 | | |
| Remark: | 1. Average measurement was not performed if peak level lower than average limit. 2. Other frequency was 20dB below limit line within 1-18GHz, there is not show in the report. | | |

| Mark | Frequency (MHz) | Reading Level (dBμV) | Factor (dB) | Measure Level (dBμV/m) | Limit (dBμV/m) | Margin (dB) | Detector | Polarization |
|------|-----------------|----------------------|-------------|------------------------|----------------|-------------|----------|--------------|
| | 7553.5 | 32.6 | 11.8 | 44.4 | 74.0 | -29.6 | Peak | Horizontal |
| * | 7859.5 | 32.6 | 11.6 | 44.2 | 68.2 | -24.0 | Peak | Horizontal |
| * | 8701.0 | 31.9 | 12.5 | 44.4 | 68.2 | -23.8 | Peak | Horizontal |
| | 9092.0 | 32.6 | 13.3 | 45.9 | 74.0 | -28.1 | Peak | Horizontal |
| | 7494.0 | 31.9 | 12.0 | 43.9 | 74.0 | -30.1 | Peak | Vertical |
| * | 8692.5 | 30.9 | 12.4 | 43.3 | 68.2 | -24.9 | Peak | Vertical |
| * | 9636.0 | 31.4 | 13.7 | 45.1 | 68.2 | -23.1 | Peak | Vertical |
| | 10894.0 | 30.6 | 18.3 | 48.9 | 74.0 | -25.1 | Peak | Vertical |

Note 1: "*" is not in restricted band, its limit is -27dBm/MHz. At a distance of 3 meters, the field strength limit in dBμV/m can be determined by adding a "conversion" factor of 95.2dB to the EIRP limit of -27dBm/MHz to obtain the limit for out of band spurious emissions.

Note 2: Measure Level (dBμV/m) = Reading Level (dBμV) + Factor (dB)

Factor (dB) = Cable Loss (dB) + Antenna Factor (dB/m) - Pre_Amplifier Gain (dB)

| | | | |
|---------------|---|-------------------|-------------------------|
| Product | OmniAccess Stellar | Temperature | 22 ~ 26°C |
| Test Engineer | David Lv | Relative Humidity | 44 ~ 57 % |
| Test Site | AC1 | Test Date | 2019/11/26 ~ 2020/02/24 |
| Test Mode | 802.11ax-HE20 - Ant 0 + 1 + 2 + 3 (CDD Mode) | Test Channel | 44 |
| Model No. | OAW-AP1361 | | |
| Remark: | 1. Average measurement was not performed if peak level lower than average limit. 2. Other frequency was 20dB below limit line within 1-18GHz, there is not show in the report. | | |

| Mark | Frequency (MHz) | Reading Level (dBμV) | Factor (dB) | Measure Level (dBμV/m) | Limit (dBμV/m) | Margin (dB) | Detector | Polarization |
|------|-----------------|----------------------|-------------|------------------------|----------------|-------------|----------|--------------|
| | 7477.0 | 32.1 | 11.9 | 44.0 | 74.0 | -30.0 | Peak | Horizontal |
| * | 7808.5 | 33.6 | 11.5 | 45.1 | 68.2 | -23.1 | Peak | Horizontal |
| * | 8896.5 | 32.0 | 12.6 | 44.6 | 68.2 | -23.6 | Peak | Horizontal |
| | 9168.5 | 32.0 | 13.8 | 45.8 | 74.0 | -28.2 | Peak | Horizontal |
| | 7324.0 | 32.0 | 12.0 | 44.0 | 74.0 | -30.0 | Peak | Vertical |
| * | 8718.0 | 32.2 | 12.8 | 45.0 | 68.2 | -23.2 | Peak | Vertical |
| * | 9814.5 | 30.2 | 14.1 | 44.3 | 68.2 | -23.9 | Peak | Vertical |
| | 10894.0 | 31.3 | 18.3 | 49.6 | 74.0 | -24.4 | Peak | Vertical |

Note 1: "*" is not in restricted band, its limit is -27dBm/MHz. At a distance of 3 meters, the field strength limit in dBμV/m can be determined by adding a "conversion" factor of 95.2dB to the EIRP limit of -27dBm/MHz to obtain the limit for out of band spurious emissions.

Note 2: Measure Level (dBμV/m) = Reading Level (dBμV) + Factor (dB)

Factor (dB) = Cable Loss (dB) + Antenna Factor (dB/m) - Pre_Amplifier Gain (dB)

| | | | |
|---------------|---|-------------------|-------------------------|
| Product | OmniAccess Stellar | Temperature | 22 ~ 26°C |
| Test Engineer | David Lv | Relative Humidity | 44 ~ 57 % |
| Test Site | AC1 | Test Date | 2019/11/26 ~ 2020/02/24 |
| Test Mode | 802.11ax-HE20 - Ant 0 + 1 + 2 + 3 (CDD Mode) | Test Channel | 48 |
| Model No. | OAW-AP1361 | | |
| Remark: | 1. Average measurement was not performed if peak level lower than average limit. 2. Other frequency was 20dB below limit line within 1-18GHz, there is not show in the report. | | |

| Mark | Frequency (MHz) | Reading Level (dBμV) | Factor (dB) | Measure Level (dBμV/m) | Limit (dBμV/m) | Margin (dB) | Detector | Polarization |
|------|-----------------|----------------------|-------------|------------------------|----------------|-------------|----------|--------------|
| | 7502.5 | 32.2 | 11.8 | 44.0 | 74.0 | -30.0 | Peak | Horizontal |
| * | 8658.5 | 31.6 | 12.3 | 43.9 | 68.2 | -24.3 | Peak | Horizontal |
| * | 10520.0 | 31.9 | 16.7 | 48.6 | 68.2 | -19.6 | Peak | Horizontal |
| | 11565.5 | 31.4 | 19.5 | 50.9 | 74.0 | -23.1 | Peak | Horizontal |
| | 7596.0 | 32.2 | 11.5 | 43.7 | 74.0 | -30.3 | Peak | Vertical |
| * | 8743.5 | 32.0 | 12.7 | 44.7 | 68.2 | -23.5 | Peak | Vertical |
| * | 10146.0 | 31.8 | 14.9 | 46.7 | 68.2 | -21.5 | Peak | Vertical |
| | 10834.5 | 31.5 | 17.7 | 49.2 | 74.0 | -24.8 | Peak | Vertical |

Note 1: "*" is not in restricted band, its limit is -27dBm/MHz. At a distance of 3 meters, the field strength limit in dBμV/m can be determined by adding a "conversion" factor of 95.2dB to the EIRP limit of -27dBm/MHz to obtain the limit for out of band spurious emissions.

Note 2: Measure Level (dBμV/m) = Reading Level (dBμV) + Factor (dB)

Factor (dB) = Cable Loss (dB) + Antenna Factor (dB/m) - Pre_Amplifier Gain (dB)

| | | | |
|---------------|---|-------------------|-------------------------|
| Product | OmniAccess Stellar | Temperature | 22 ~ 26°C |
| Test Engineer | David Lv | Relative Humidity | 44 ~ 57 % |
| Test Site | AC1 | Test Date | 2019/11/26 ~ 2020/02/24 |
| Test Mode | 802.11ax-HE20 - Ant 0 + 1 + 2 + 3 (CDD Mode) | Test Channel | 149 |
| Model No. | OAW-AP1361 | | |
| Remark: | 1. Average measurement was not performed if peak level lower than average limit. 2. Other frequency was 20dB below limit line within 1-18GHz, there is not show in the report. | | |

| Mark | Frequency (MHz) | Reading Level (dBμV) | Factor (dB) | Measure Level (dBμV/m) | Limit (dBμV/m) | Margin (dB) | Detector | Polarization |
|------|-----------------|----------------------|-------------|------------------------|----------------|-------------|----------|--------------|
| | 7383.5 | 33.5 | 11.8 | 45.3 | 74.0 | -28.7 | Peak | Horizontal |
| * | 7953.0 | 34.5 | 11.6 | 46.1 | 68.2 | -22.1 | Peak | Horizontal |
| * | 9704.0 | 34.6 | 13.7 | 48.3 | 68.2 | -19.9 | Peak | Horizontal |
| | 11429.5 | 31.4 | 19.3 | 50.7 | 74.0 | -23.3 | Peak | Horizontal |
| | 7468.5 | 33.7 | 11.8 | 45.5 | 74.0 | -28.5 | Peak | Vertical |
| * | 8667.0 | 33.8 | 12.3 | 46.1 | 68.2 | -22.1 | Peak | Vertical |
| * | 9704.0 | 34.9 | 13.7 | 48.6 | 68.2 | -19.6 | Peak | Vertical |
| | 11353.0 | 28.6 | 18.7 | 47.3 | 74.0 | -26.7 | Peak | Vertical |

Note 1: "*" is not in restricted band, its limit is -27dBm/MHz. At a distance of 3 meters, the field strength limit in dBμV/m can be determined by adding a "conversion" factor of 95.2dB to the EIRP limit of -27dBm/MHz to obtain the limit for out of band spurious emissions.

Note 2: Measure Level (dBμV/m) = Reading Level (dBμV) + Factor (dB)

Factor (dB) = Cable Loss (dB) + Antenna Factor (dB/m) - Pre_Amplifier Gain (dB)

| | | | |
|---------------|---|-------------------|-------------------------|
| Product | OmniAccess Stellar | Temperature | 22 ~ 26°C |
| Test Engineer | David Lv | Relative Humidity | 44 ~ 57 % |
| Test Site | AC1 | Test Date | 2019/11/26 ~ 2020/02/24 |
| Test Mode | 802.11ax-HE20 - Ant 0 + 1 + 2 + 3 (CDD Mode) | Test Channel | 157 |
| Model No. | OAW-AP1361 | | |
| Remark: | 1. Average measurement was not performed if peak level lower than average limit. 2. Other frequency was 20dB below limit line within 1-18GHz, there is not show in the report. | | |

| Mark | Frequency (MHz) | Reading Level (dBμV) | Factor (dB) | Measure Level (dBμV/m) | Limit (dBμV/m) | Margin (dB) | Detector | Polarization |
|------|-----------------|----------------------|-------------|------------------------|----------------|-------------|----------|--------------|
| | 8097.5 | 34.4 | 11.6 | 46.0 | 74.0 | -28.0 | Peak | Horizontal |
| * | 8624.5 | 33.0 | 12.1 | 45.1 | 68.2 | -23.1 | Peak | Horizontal |
| * | 9687.0 | 34.4 | 13.6 | 48.0 | 68.2 | -20.2 | Peak | Horizontal |
| | 11489.0 | 31.2 | 20.2 | 51.4 | 74.0 | -22.6 | Peak | Horizontal |
| | 7256.0 | 34.1 | 11.9 | 46.0 | 74.0 | -28.0 | Peak | Vertical |
| * | 8667.0 | 34.1 | 12.3 | 46.4 | 68.2 | -21.8 | Peak | Vertical |
| * | 9746.5 | 34.2 | 13.9 | 48.1 | 68.2 | -20.1 | Peak | Vertical |
| | 11132.0 | 32.9 | 18.3 | 51.2 | 74.0 | -22.8 | Peak | Vertical |

Note 1: "*" is not in restricted band, its limit is -27dBm/MHz. At a distance of 3 meters, the field strength limit in dBμV/m can be determined by adding a "conversion" factor of 95.2dB to the EIRP limit of -27dBm/MHz to obtain the limit for out of band spurious emissions.

Note 2: Measure Level (dBμV/m) = Reading Level (dBμV) + Factor (dB)

Factor (dB) = Cable Loss (dB) + Antenna Factor (dB/m) - Pre_Amplifier Gain (dB)

| | | | |
|---------------|---|-------------------|-------------------------|
| Product | OmniAccess Stellar | Temperature | 22 ~ 26°C |
| Test Engineer | David Lv | Relative Humidity | 44 ~ 57 % |
| Test Site | AC1 | Test Date | 2019/11/26 ~ 2020/02/24 |
| Test Mode | 802.11ax-HE20 - Ant 0 + 1 + 2 + 3 (CDD Mode) | Test Channel | 165 |
| Model No. | OAW-AP1361 | | |
| Remark: | 1. Average measurement was not performed if peak level lower than average limit. 2. Other frequency was 20dB below limit line within 1-18GHz, there is not show in the report. | | |

| Mark | Frequency (MHz) | Reading Level (dBμV) | Factor (dB) | Measure Level (dBμV/m) | Limit (dBμV/m) | Margin (dB) | Detector | Polarization |
|------|-----------------|----------------------|-------------|------------------------|----------------|-------------|----------|--------------|
| | 7536.5 | 34.0 | 11.7 | 45.7 | 74.0 | -28.3 | Peak | Horizontal |
| * | 8735.0 | 32.7 | 12.8 | 45.5 | 68.2 | -22.7 | Peak | Horizontal |
| * | 10154.5 | 33.2 | 14.9 | 48.1 | 68.2 | -20.1 | Peak | Horizontal |
| | 11540.0 | 31.8 | 19.9 | 51.7 | 74.0 | -22.3 | Peak | Horizontal |
| | 7477.0 | 33.8 | 11.9 | 45.7 | 74.0 | -28.3 | Peak | Vertical |
| * | 8624.5 | 33.7 | 12.1 | 45.8 | 68.2 | -22.4 | Peak | Vertical |
| * | 9772.0 | 35.9 | 14.0 | 49.9 | 68.2 | -18.3 | Peak | Vertical |
| | 11591.0 | 31.5 | 19.8 | 51.3 | 74.0 | -22.7 | Peak | Vertical |

Note 1: "*" is not in restricted band, its limit is -27dBm/MHz. At a distance of 3 meters, the field strength limit in dBμV/m can be determined by adding a "conversion" factor of 95.2dB to the EIRP limit of -27dBm/MHz to obtain the limit for out of band spurious emissions.

Note 2: Measure Level (dBμV/m) = Reading Level (dBμV) + Factor (dB)

Factor (dB) = Cable Loss (dB) + Antenna Factor (dB/m) - Pre_Amplifier Gain (dB)

| | | | |
|---------------|---|-------------------|-------------------------|
| Product | OmniAccess Stellar | Temperature | 22 ~ 26°C |
| Test Engineer | David Lv | Relative Humidity | 44 ~ 57 % |
| Test Site | AC1 | Test Date | 2019/11/26 ~ 2020/02/24 |
| Test Mode | 802.11ax-HE40 - Ant 0 + 1 + 2 + 3 (CDD Mode) | Test Channel | 38 |
| Model No. | OAW-AP1361 | | |
| Remark: | 1. Average measurement was not performed if peak level lower than average limit. 2. Other frequency was 20dB below limit line within 1-18GHz, there is not show in the report. | | |

| Mark | Frequency (MHz) | Reading Level (dBμV) | Factor (dB) | Measure Level (dBμV/m) | Limit (dBμV/m) | Margin (dB) | Detector | Polarization |
|------|-----------------|----------------------|-------------|------------------------|----------------|-------------|----------|--------------|
| | 7706.5 | 32.6 | 11.4 | 44.0 | 74.0 | -30.0 | Peak | Horizontal |
| * | 8658.5 | 31.2 | 12.3 | 43.5 | 68.2 | -24.7 | Peak | Horizontal |
| * | 9916.5 | 33.0 | 14.1 | 47.1 | 68.2 | -21.1 | Peak | Horizontal |
| | 10885.5 | 31.0 | 18.3 | 49.3 | 74.0 | -24.7 | Peak | Horizontal |
| | 7332.5 | 32.5 | 11.8 | 44.3 | 74.0 | -29.7 | Peak | Vertical |
| * | 8556.5 | 32.8 | 11.8 | 44.6 | 68.2 | -23.6 | Peak | Vertical |
| * | 10137.5 | 31.7 | 15.1 | 46.8 | 68.2 | -21.4 | Peak | Vertical |
| | 11540.0 | 30.9 | 19.9 | 50.8 | 74.0 | -23.2 | Peak | Vertical |

Note 1: "*" is not in restricted band, its limit is -27dBm/MHz. At a distance of 3 meters, the field strength limit in dBμV/m can be determined by adding a "conversion" factor of 95.2dB to the EIRP limit of -27dBm/MHz to obtain the limit for out of band spurious emissions.

Note 2: Measure Level (dBμV/m) = Reading Level (dBμV) + Factor (dB)

Factor (dB) = Cable Loss (dB) + Antenna Factor (dB/m) - Pre_Amplifier Gain (dB)

| | | | |
|---------------|---|-------------------|-------------------------|
| Product | OmniAccess Stellar | Temperature | 22 ~ 26°C |
| Test Engineer | David Lv | Relative Humidity | 44 ~ 57 % |
| Test Site | AC1 | Test Date | 2019/11/26 ~ 2020/02/24 |
| Test Mode | 802.11ax-HE40 - Ant 0 + 1 + 2 + 3 (CDD Mode) | Test Channel | 46 |
| Model No. | OAW-AP1361 | | |
| Remark: | 1. Average measurement was not performed if peak level lower than average limit. 2. Other frequency was 20dB below limit line within 1-18GHz, there is not show in the report. | | |

| Mark | Frequency (MHz) | Reading Level (dBμV) | Factor (dB) | Measure Level (dBμV/m) | Limit (dBμV/m) | Margin (dB) | Detector | Polarization |
|------|-----------------|----------------------|-------------|------------------------|----------------|-------------|----------|--------------|
| | 7485.5 | 32.1 | 12.0 | 44.1 | 74.0 | -29.9 | Peak | Horizontal |
| * | 7936.0 | 33.5 | 11.6 | 45.1 | 68.2 | -23.1 | Peak | Horizontal |
| * | 8658.5 | 31.4 | 12.3 | 43.7 | 68.2 | -24.5 | Peak | Horizontal |
| | 11489.0 | 29.6 | 20.2 | 49.8 | 74.0 | -24.2 | Peak | Horizontal |
| | 7553.5 | 32.5 | 11.8 | 44.3 | 74.0 | -29.7 | Peak | Vertical |
| * | 8803.0 | 31.6 | 12.9 | 44.5 | 68.2 | -23.7 | Peak | Vertical |
| * | 9627.5 | 33.0 | 13.6 | 46.6 | 68.2 | -21.6 | Peak | Vertical |
| | 10902.5 | 32.0 | 18.3 | 50.3 | 74.0 | -23.7 | Peak | Vertical |

Note 1: "*" is not in restricted band, its limit is -27dBm/MHz. At a distance of 3 meters, the field strength limit in dBμV/m can be determined by adding a "conversion" factor of 95.2dB to the EIRP limit of -27dBm/MHz to obtain the limit for out of band spurious emissions.

Note 2: Measure Level (dBμV/m) = Reading Level (dBμV) + Factor (dB)

Factor (dB) = Cable Loss (dB) + Antenna Factor (dB/m) - Pre_Amplifier Gain (dB)

| | | | |
|---------------|---|-------------------|-------------------------|
| Product | OmniAccess Stellar | Temperature | 22 ~ 26°C |
| Test Engineer | David Lv | Relative Humidity | 44 ~ 57 % |
| Test Site | AC1 | Test Date | 2019/11/26 ~ 2020/02/24 |
| Test Mode | 802.11ax-HE40 - Ant 0 + 1 + 2 + 3 (CDD Mode) | Test Channel | 151 |
| Model No. | OAW-AP1361 | | |
| Remark: | 1. Average measurement was not performed if peak level lower than average limit. 2. Other frequency was 20dB below limit line within 1-18GHz, there is not show in the report. | | |

| Mark | Frequency (MHz) | Reading Level (dBμV) | Factor (dB) | Measure Level (dBμV/m) | Limit (dBμV/m) | Margin (dB) | Detector | Polarization |
|------|-----------------|----------------------|-------------|------------------------|----------------|-------------|----------|--------------|
| | 7468.5 | 31.8 | 11.8 | 43.6 | 74.0 | -30.4 | Peak | Horizontal |
| * | 8675.5 | 32.5 | 12.3 | 44.8 | 68.2 | -23.4 | Peak | Horizontal |
| * | 10171.5 | 31.7 | 15.1 | 46.8 | 68.2 | -21.4 | Peak | Horizontal |
| | 11965.0 | 27.5 | 19.4 | 46.9 | 74.0 | -27.1 | Peak | Horizontal |
| | 7562.0 | 33.1 | 11.6 | 44.7 | 74.0 | -29.3 | Peak | Vertical |
| * | 8709.5 | 33.1 | 12.6 | 45.7 | 68.2 | -22.5 | Peak | Vertical |
| * | 9636.0 | 31.8 | 13.7 | 45.5 | 68.2 | -22.7 | Peak | Vertical |
| | 10877.0 | 31.6 | 18.3 | 49.9 | 74.0 | -24.1 | Peak | Vertical |

Note 1: "*" is not in restricted band, its limit is -27dBm/MHz. At a distance of 3 meters, the field strength limit in dBμV/m can be determined by adding a "conversion" factor of 95.2dB to the EIRP limit of -27dBm/MHz to obtain the limit for out of band spurious emissions.

Note 2: Measure Level (dBμV/m) = Reading Level (dBμV) + Factor (dB)

Factor (dB) = Cable Loss (dB) + Antenna Factor (dB/m) - Pre_Amplifier Gain (dB)

| | | | |
|---------------|---|-------------------|-------------------------|
| Product | OmniAccess Stellar | Temperature | 22 ~ 26°C |
| Test Engineer | David Lv | Relative Humidity | 44 ~ 57 % |
| Test Site | AC1 | Test Date | 2019/11/26 ~ 2020/02/24 |
| Test Mode | 802.11ax-HE40 - Ant 0 + 1 + 2 + 3 (CDD Mode) | Test Channel | 159 |
| Model No. | OAW-AP1361 | | |
| Remark: | 1. Average measurement was not performed if peak level lower than average limit. 2. Other frequency was 20dB below limit line within 1-18GHz, there is not show in the report. | | |

| Mark | Frequency (MHz) | Reading Level (dBμV) | Factor (dB) | Measure Level (dBμV/m) | Limit (dBμV/m) | Margin (dB) | Detector | Polarization |
|------|-----------------|----------------------|-------------|------------------------|----------------|-------------|----------|--------------|
| | 7604.5 | 32.4 | 11.4 | 43.8 | 74.0 | -30.2 | Peak | Horizontal |
| * | 8692.5 | 30.6 | 12.4 | 43.0 | 68.2 | -25.2 | Peak | Horizontal |
| * | 9678.5 | 31.3 | 13.6 | 44.9 | 68.2 | -23.3 | Peak | Horizontal |
| | 10749.5 | 32.5 | 17.2 | 49.7 | 74.0 | -24.3 | Peak | Horizontal |
| | 7664.0 | 32.7 | 11.4 | 44.1 | 74.0 | -29.9 | Peak | Vertical |
| * | 8667.0 | 31.9 | 12.3 | 44.2 | 68.2 | -24.0 | Peak | Vertical |
| * | 10426.5 | 32.2 | 16.0 | 48.2 | 68.2 | -20.0 | Peak | Vertical |
| | 10860.0 | 32.1 | 17.9 | 50.0 | 74.0 | -24.0 | Peak | Vertical |

Note 1: "*" is not in restricted band, its limit is -27dBm/MHz. At a distance of 3 meters, the field strength limit in dBμV/m can be determined by adding a "conversion" factor of 95.2dB to the EIRP limit of -27dBm/MHz to obtain the limit for out of band spurious emissions.

Note 2: Measure Level (dBμV/m) = Reading Level (dBμV) + Factor (dB)

Factor (dB) = Cable Loss (dB) + Antenna Factor (dB/m) - Pre_Amplifier Gain (dB)

| | | | |
|---------------|---|-------------------|-------------------------|
| Product | OmniAccess Stellar | Temperature | 22 ~ 26°C |
| Test Engineer | David Lv | Relative Humidity | 44 ~ 57 % |
| Test Site | AC1 | Test Date | 2019/11/26 ~ 2020/02/24 |
| Test Mode | 802.11ax-HE80 - Ant 0 + 1 + 2 + 3 (CDD Mode) | Test Channel | 42 |
| Model No. | OAW-AP1361 | | |
| Remark: | 1. Average measurement was not performed if peak level lower than average limit. 2. Other frequency was 20dB below limit line within 1-18GHz, there is not show in the report. | | |

| Mark | Frequency (MHz) | Reading Level (dBμV) | Factor (dB) | Measure Level (dBμV/m) | Limit (dBμV/m) | Margin (dB) | Detector | Polarization |
|------|-----------------|----------------------|-------------|------------------------|----------------|-------------|----------|--------------|
| | 7451.5 | 33.2 | 11.7 | 44.9 | 74.0 | -29.1 | Peak | Horizontal |
| * | 9602.0 | 33.9 | 13.6 | 47.5 | 68.2 | -20.7 | Peak | Horizontal |
| * | 10503.0 | 33.2 | 16.7 | 49.9 | 68.2 | -18.3 | Peak | Horizontal |
| | 11489.0 | 31.3 | 20.2 | 51.5 | 74.0 | -22.5 | Peak | Horizontal |
| | 7477.0 | 33.7 | 11.9 | 45.6 | 74.0 | -28.4 | Peak | Vertical |
| * | 9245.0 | 33.4 | 13.6 | 47.0 | 68.2 | -21.2 | Peak | Vertical |
| * | 10528.5 | 33.0 | 16.6 | 49.6 | 68.2 | -18.6 | Peak | Vertical |
| | 11344.5 | 30.1 | 18.8 | 48.9 | 74.0 | -25.1 | Peak | Vertical |

Note 1: "*" is not in restricted band, its limit is -27dBm/MHz. At a distance of 3 meters, the field strength limit in dBμV/m can be determined by adding a "conversion" factor of 95.2dB to the EIRP limit of -27dBm/MHz to obtain the limit for out of band spurious emissions.

Note 2: Measure Level (dBμV/m) = Reading Level (dBμV) + Factor (dB)

Factor (dB) = Cable Loss (dB) + Antenna Factor (dB/m) - Pre_Amplifier Gain (dB)

| | | | |
|---------------|---|-------------------|-------------------------|
| Product | OmniAccess Stellar | Temperature | 22 ~ 26°C |
| Test Engineer | David Lv | Relative Humidity | 44 ~ 57 % |
| Test Site | AC1 | Test Date | 2019/11/26 ~ 2020/02/24 |
| Test Mode | 802.11ax-HE80 - Ant 0 + 1 + 2 + 3 (CDD Mode) | Test Channel | 155 |
| Model No. | OAW-AP1361 | | |
| Remark: | 1. Average measurement was not performed if peak level lower than average limit. 2. Other frequency was 20dB below limit line within 1-18GHz, there is not show in the report. | | |

| Mark | Frequency (MHz) | Reading Level (dBμV) | Factor (dB) | Measure Level (dBμV/m) | Limit (dBμV/m) | Margin (dB) | Detector | Polarization |
|------|-----------------|----------------------|-------------|------------------------|----------------|-------------|----------|--------------|
| | 8123.0 | 34.1 | 11.7 | 45.8 | 74.0 | -28.2 | Peak | Horizontal |
| * | 8888.0 | 30.9 | 12.7 | 43.6 | 68.2 | -24.6 | Peak | Horizontal |
| * | 9551.0 | 35.2 | 13.5 | 48.7 | 68.2 | -19.5 | Peak | Horizontal |
| | 12084.0 | 32.2 | 19.9 | 52.1 | 74.0 | -21.9 | Peak | Horizontal |
| | 7545.0 | 33.5 | 11.9 | 45.4 | 74.0 | -28.6 | Peak | Vertical |
| * | 7902.0 | 34.4 | 11.6 | 46.0 | 68.2 | -22.2 | Peak | Vertical |
| * | 9763.5 | 34.6 | 14.0 | 48.6 | 68.2 | -19.6 | Peak | Vertical |
| | 10877.0 | 33.3 | 18.3 | 51.6 | 74.0 | -22.4 | Peak | Vertical |

Note 1: "*" is not in restricted band, its limit is -27dBm/MHz. At a distance of 3 meters, the field strength limit in dBμV/m can be determined by adding a "conversion" factor of 95.2dB to the EIRP limit of -27dBm/MHz to obtain the limit for out of band spurious emissions.

Note 2: Measure Level (dBμV/m) = Reading Level (dBμV) + Factor (dB)

Factor (dB) = Cable Loss (dB) + Antenna Factor (dB/m) - Pre_Amplifier Gain (dB)

| | | | |
|---------------|---|-------------------|-------------------------|
| Product | OmniAccess Stellar | Temperature | 22 ~ 26°C |
| Test Engineer | David Lv | Relative Humidity | 44 ~ 57 % |
| Test Site | AC1 | Test Date | 2019/11/26 ~ 2020/02/24 |
| Test Mode | 802.11a | Test Channel | 36 |
| Model No. | OAW-AP1361 – Scan Antenna | | |
| Remark: | 1. Average measurement was not performed if peak level lower than average limit. 2. Other frequency was 20dB below limit line within 1-18GHz, there is not show in the report. | | |

| Mark | Frequency (MHz) | Reading Level (dBμV) | Factor (dB) | Measure Level (dBμV/m) | Limit (dBμV/m) | Margin (dB) | Detector | Polarization |
|------|-----------------|----------------------|-------------|------------------------|----------------|-------------|----------|--------------|
| * | 7086.0 | 31.9 | 11.9 | 43.8 | 68.2 | -24.4 | Peak | Horizontal |
| * | 7885.0 | 33.3 | 11.8 | 45.1 | 68.2 | -23.1 | Peak | Horizontal |
| | 8276.0 | 30.2 | 12.3 | 42.5 | 74.0 | -31.5 | Peak | Horizontal |
| | 9100.5 | 28.9 | 14.5 | 43.4 | 74.0 | -30.6 | Peak | Horizontal |
| * | 7069.0 | 32.6 | 11.5 | 44.1 | 68.2 | -24.1 | Peak | Vertical |
| * | 7808.5 | 33.4 | 11.8 | 45.2 | 68.2 | -23.0 | Peak | Vertical |
| | 8395.0 | 32.6 | 12.4 | 45.0 | 74.0 | -29.0 | Peak | Vertical |
| | 9049.5 | 30.4 | 14.2 | 44.6 | 74.0 | -29.4 | Peak | Vertical |

Note 1: "*" is not in restricted band, its limit is -27dBm/MHz. At a distance of 3 meters, the field strength limit in dBμV/m can be determined by adding a "conversion" factor of 95.2dB to the EIRP limit of -27dBm/MHz to obtain the limit for out of band spurious emissions.

Note 2: Measure Level (dBμV/m) = Reading Level (dBμV) + Factor (dB)

Factor (dB) = Cable Loss (dB) + Antenna Factor (dB/m) - Pre_Amplifier Gain (dB)

| | | | |
|---------------|---|-------------------|-------------------------|
| Product | OmniAccess Stellar | Temperature | 22 ~ 26°C |
| Test Engineer | David Lv | Relative Humidity | 44 ~ 57 % |
| Test Site | AC1 | Test Date | 2019/11/26 ~ 2020/02/24 |
| Test Mode | 802.11a | Test Channel | 44 |
| Model No. | OAW-AP1361 – Scan Antenna | | |
| Remark: | 1. Average measurement was not performed if peak level lower than average limit. 2. Other frequency was 20dB below limit line within 1-18GHz, there is not show in the report. | | |

| Mark | Frequency (MHz) | Reading Level (dBμV) | Factor (dB) | Measure Level (dBμV/m) | Limit (dBμV/m) | Margin (dB) | Detector | Polarization |
|------|-----------------|----------------------|-------------|------------------------|----------------|-------------|----------|--------------|
| * | 7086.0 | 32.8 | 11.9 | 44.7 | 68.2 | -23.5 | Peak | Horizontal |
| * | 7842.5 | 30.9 | 11.9 | 42.8 | 68.2 | -25.4 | Peak | Horizontal |
| | 8276.0 | 31.2 | 12.3 | 43.5 | 74.0 | -30.5 | Peak | Horizontal |
| | 9049.5 | 30.3 | 14.2 | 44.5 | 74.0 | -29.5 | Peak | Horizontal |
| * | 7086.0 | 32.3 | 11.9 | 44.2 | 68.2 | -24.0 | Peak | Vertical |
| * | 7851.0 | 33.1 | 12.0 | 45.1 | 68.2 | -23.1 | Peak | Vertical |
| | 8242.0 | 30.1 | 12.5 | 42.6 | 74.0 | -31.4 | Peak | Vertical |
| | 9134.5 | 30.2 | 14.7 | 44.9 | 74.0 | -29.1 | Peak | Vertical |

Note 1: "*" is not in restricted band, its limit is -27dBm/MHz. At a distance of 3 meters, the field strength limit in dBμV/m can be determined by adding a "conversion" factor of 95.2dB to the EIRP limit of -27dBm/MHz to obtain the limit for out of band spurious emissions.

Note 2: Measure Level (dBμV/m) = Reading Level (dBμV) + Factor (dB)

Factor (dB) = Cable Loss (dB) + Antenna Factor (dB/m) - Pre_Amplifier Gain (dB)

| | | | |
|---------------|---|-------------------|-------------------------|
| Product | OmniAccess Stellar | Temperature | 22 ~ 26°C |
| Test Engineer | David Lv | Relative Humidity | 44 ~ 57 % |
| Test Site | AC1 | Test Date | 2019/11/26 ~ 2020/02/24 |
| Test Mode | 802.11a | Test Channel | 48 |
| Model No. | OAW-AP1361 – Scan Antenna | | |
| Remark: | 1. Average measurement was not performed if peak level lower than average limit. 2. Other frequency was 20dB below limit line within 1-18GHz, there is not show in the report. | | |

| Mark | Frequency (MHz) | Reading Level (dBμV) | Factor (dB) | Measure Level (dBμV/m) | Limit (dBμV/m) | Margin (dB) | Detector | Polarization |
|------|-----------------|----------------------|-------------|------------------------|----------------|-------------|----------|--------------|
| * | 6848.0 | 34.3 | 9.8 | 44.1 | 68.2 | -24.1 | Peak | Horizontal |
| * | 7834.0 | 34.7 | 11.9 | 46.6 | 68.2 | -21.6 | Peak | Horizontal |
| | 8369.5 | 33.2 | 12.3 | 45.5 | 74.0 | -28.5 | Peak | Horizontal |
| | 9109.0 | 29.2 | 14.6 | 43.8 | 74.0 | -30.2 | Peak | Horizontal |
| * | 7171.0 | 32.8 | 11.8 | 44.6 | 68.2 | -23.6 | Peak | Vertical |
| * | 7910.5 | 31.6 | 12.2 | 43.8 | 68.2 | -24.4 | Peak | Vertical |
| | 8395.0 | 32.2 | 12.4 | 44.6 | 74.0 | -29.4 | Peak | Vertical |
| | 9151.5 | 30.3 | 14.7 | 45.0 | 74.0 | -29.0 | Peak | Vertical |

Note 1: "*" is not in restricted band, its limit is -27dBm/MHz. At a distance of 3 meters, the field strength limit in dBμV/m can be determined by adding a "conversion" factor of 95.2dB to the EIRP limit of -27dBm/MHz to obtain the limit for out of band spurious emissions.

Note 2: Measure Level (dBμV/m) = Reading Level (dBμV) + Factor (dB)

Factor (dB) = Cable Loss (dB) + Antenna Factor (dB/m) - Pre_Amplifier Gain (dB)

| | | | |
|---------------|---|-------------------|-------------------------|
| Product | OmniAccess Stellar | Temperature | 22 ~ 26°C |
| Test Engineer | David Lv | Relative Humidity | 44 ~ 57 % |
| Test Site | AC1 | Test Date | 2019/11/26 ~ 2020/02/24 |
| Test Mode | 802.11a | Test Channel | 149 |
| Model No. | OAW-AP1361 – Scan Antenna | | |
| Remark: | 1. Average measurement was not performed if peak level lower than average limit. 2. Other frequency was 20dB below limit line within 1-18GHz, there is not show in the report. | | |

| Mark | Frequency (MHz) | Reading Level (dBμV) | Factor (dB) | Measure Level (dBμV/m) | Limit (dBμV/m) | Margin (dB) | Detector | Polarization |
|------|-----------------|----------------------|-------------|------------------------|----------------|-------------|----------|--------------|
| * | 7026.5 | 34.3 | 10.8 | 45.1 | 68.2 | -23.1 | Peak | Horizontal |
| * | 7808.5 | 32.6 | 11.8 | 44.4 | 68.2 | -23.8 | Peak | Horizontal |
| | 8225.0 | 31.5 | 12.3 | 43.8 | 74.0 | -30.2 | Peak | Horizontal |
| | 9092.0 | 31.5 | 14.5 | 46.0 | 74.0 | -28.0 | Peak | Horizontal |
| * | 7086.0 | 33.5 | 11.9 | 45.4 | 68.2 | -22.8 | Peak | Vertical |
| * | 7961.5 | 32.8 | 12.4 | 45.2 | 68.2 | -23.0 | Peak | Vertical |
| | 8352.5 | 30.2 | 12.4 | 42.6 | 74.0 | -31.4 | Peak | Vertical |
| | 9092.0 | 29.8 | 14.5 | 44.3 | 74.0 | -29.7 | Peak | Vertical |

Note 1: "*" is not in restricted band, its limit is -27dBm/MHz. At a distance of 3 meters, the field strength limit in dBμV/m can be determined by adding a "conversion" factor of 95.2dB to the EIRP limit of -27dBm/MHz to obtain the limit for out of band spurious emissions.

Note 2: Measure Level (dBμV/m) = Reading Level (dBμV) + Factor (dB)

Factor (dB) = Cable Loss (dB) + Antenna Factor (dB/m) - Pre_Amplifier Gain (dB)

| | | | |
|---------------|---|-------------------|-------------------------|
| Product | OmniAccess Stellar | Temperature | 22 ~ 26°C |
| Test Engineer | David Lv | Relative Humidity | 44 ~ 57 % |
| Test Site | AC1 | Test Date | 2019/11/26 ~ 2020/02/24 |
| Test Mode | 802.11a | Test Channel | 157 |
| Model No. | OAW-AP1361 – Scan Antenna | | |
| Remark: | 1. Average measurement was not performed if peak level lower than average limit. 2. Other frequency was 20dB below limit line within 1-18GHz, there is not show in the report. | | |

| Mark | Frequency (MHz) | Reading Level (dBμV) | Factor (dB) | Measure Level (dBμV/m) | Limit (dBμV/m) | Margin (dB) | Detector | Polarization |
|------|-----------------|----------------------|-------------|------------------------|----------------|-------------|----------|--------------|
| * | 7094.5 | 32.9 | 11.8 | 44.7 | 68.2 | -23.5 | Peak | Horizontal |
| * | 7842.5 | 32.8 | 11.9 | 44.7 | 68.2 | -23.5 | Peak | Horizontal |
| | 8276.0 | 30.9 | 12.3 | 43.2 | 74.0 | -30.8 | Peak | Horizontal |
| | 9168.5 | 30.4 | 14.5 | 44.9 | 74.0 | -29.1 | Peak | Horizontal |
| * | 6465.5 | 33.7 | 8.4 | 42.1 | 68.2 | -26.1 | Peak | Vertical |
| * | 7086.0 | 32.5 | 11.9 | 44.4 | 68.2 | -23.8 | Peak | Vertical |
| | 7528.0 | 33.5 | 11.8 | 45.3 | 74.0 | -28.7 | Peak | Vertical |
| | 8344.0 | 32.0 | 12.5 | 44.5 | 74.0 | -29.5 | Peak | Vertical |

Note 1: "*" is not in restricted band, its limit is -27dBm/MHz. At a distance of 3 meters, the field strength limit in dBμV/m can be determined by adding a "conversion" factor of 95.2dB to the EIRP limit of -27dBm/MHz to obtain the limit for out of band spurious emissions.

Note 2: Measure Level (dBμV/m) = Reading Level (dBμV) + Factor (dB)

Factor (dB) = Cable Loss (dB) + Antenna Factor (dB/m) - Pre_Amplifier Gain (dB)

| | | | |
|---------------|---|-------------------|-------------------------|
| Product | OmniAccess Stellar | Temperature | 22 ~ 26°C |
| Test Engineer | David Lv | Relative Humidity | 44 ~ 57 % |
| Test Site | AC1 | Test Date | 2019/11/26 ~ 2020/02/24 |
| Test Mode | 802.11a | Test Channel | 165 |
| Model No. | OAW-AP1361 – Scan Antenna | | |
| Remark: | 1. Average measurement was not performed if peak level lower than average limit. 2. Other frequency was 20dB below limit line within 1-18GHz, there is not show in the report. | | |

| Mark | Frequency (MHz) | Reading Level (dBμV) | Factor (dB) | Measure Level (dBμV/m) | Limit (dBμV/m) | Margin (dB) | Detector | Polarization |
|------|-----------------|----------------------|-------------|------------------------|----------------|-------------|----------|--------------|
| * | 6508.0 | 33.7 | 8.6 | 42.3 | 68.2 | -25.9 | Peak | Horizontal |
| * | 7188.0 | 32.8 | 11.9 | 44.7 | 68.2 | -23.5 | Peak | Horizontal |
| | 7740.5 | 33.1 | 11.9 | 45.0 | 74.0 | -29.0 | Peak | Horizontal |
| | 8386.5 | 31.8 | 12.3 | 44.1 | 74.0 | -29.9 | Peak | Horizontal |
| * | 7188.0 | 32.8 | 11.9 | 44.7 | 68.2 | -23.5 | Peak | Vertical |
| * | 7987.0 | 32.2 | 12.4 | 44.6 | 68.2 | -23.6 | Peak | Vertical |
| | 8352.5 | 30.9 | 12.4 | 43.3 | 74.0 | -30.7 | Peak | Vertical |
| | 9134.5 | 28.8 | 14.7 | 43.5 | 74.0 | -30.5 | Peak | Vertical |

Note 1: "*" is not in restricted band, its limit is -27dBm/MHz. At a distance of 3 meters, the field strength limit in dBμV/m can be determined by adding a "conversion" factor of 95.2dB to the EIRP limit of -27dBm/MHz to obtain the limit for out of band spurious emissions.

Note 2: Measure Level (dBμV/m) = Reading Level (dBμV) + Factor (dB)

Factor (dB) = Cable Loss (dB) + Antenna Factor (dB/m) - Pre_Amplifier Gain (dB)

| | | | |
|---------------|---|-------------------|-------------------------|
| Product | OmniAccess Stellar | Temperature | 22 ~ 26°C |
| Test Engineer | David Lv | Relative Humidity | 44 ~ 57 % |
| Test Site | AC1 | Test Date | 2019/11/26 ~ 2020/02/24 |
| Test Mode: | 802.11a - Ant 0 + 1 + 2 + 3 (CDD Mode) | Test Channel: | 36 |
| Model No. | OAW-AP1361D | | |
| Remark: | 1. Average measurement was not performed if peak level lower than average limit. 2. Other frequency was 20dB below limit line within 1-18GHz, there is not show in the report. | | |

| Mark | Frequency (MHz) | Reading Level (dBμV) | Factor (dB) | Measure Level (dBμV/m) | Limit (dBμV/m) | Margin (dB) | Detector | Polarization |
|------|-----------------|----------------------|-------------|------------------------|----------------|-------------|----------|--------------|
| | 7596.0 | 38.3 | 11.8 | 50.1 | 74.0 | -23.9 | Peak | Horizontal |
| * | 7961.5 | 38.1 | 12.4 | 50.5 | 68.2 | -17.7 | Peak | Horizontal |
| | 8259.0 | 39.1 | 12.3 | 51.4 | 74.0 | -22.6 | Peak | Horizontal |
| * | 8769.0 | 37.5 | 14.2 | 51.7 | 68.2 | -16.5 | Peak | Horizontal |
| | 7621.5 | 38.8 | 11.6 | 50.4 | 74.0 | -23.6 | Peak | Vertical |
| * | 7953.0 | 38.4 | 12.5 | 50.9 | 68.2 | -17.3 | Peak | Vertical |
| | 8140.0 | 38.7 | 12.4 | 51.1 | 74.0 | -22.9 | Peak | Vertical |
| * | 8845.5 | 38.1 | 14.3 | 52.4 | 68.2 | -15.8 | Peak | Vertical |

Note 1: "*" is not in restricted band, its limit is -27dBm/MHz. At a distance of 3 meters, the field strength limit in dBμV/m can be determined by adding a "conversion" factor of 95.2dB to the EIRP limit of -27dBm/MHz to obtain the limit for out of band spurious emissions.

Note 2: Measure Level (dBμV/m) = Reading Level (dBμV) + Factor (dB)

Factor (dB) = Cable Loss (dB) + Antenna Factor (dB/m) - Pre_Amplifier Gain (dB)

| | | | |
|---------------|---|-------------------|-------------------------|
| Product | OmniAccess Stellar | Temperature | 22 ~ 26°C |
| Test Engineer | David Lv | Relative Humidity | 44 ~ 57 % |
| Test Site | AC1 | Test Date | 2019/11/26 ~ 2020/02/24 |
| Test Mode | 802.11a - Ant 0 + 1 + 2 + 3 (CDD Mode) | Test Channel | 44 |
| Model No. | OAW-AP1361D | | |
| Remark: | 1. Average measurement was not performed if peak level lower than average limit. 2. Other frequency was 20dB below limit line within 1-18GHz, there is not show in the report. | | |

| Mark | Frequency (MHz) | Reading Level (dBμV) | Factor (dB) | Measure Level (dBμV/m) | Limit (dBμV/m) | Margin (dB) | Detector | Polarization |
|------|-----------------|----------------------|-------------|------------------------|----------------|-------------|----------|--------------|
| | 7536.5 | 37.2 | 11.8 | 49.0 | 74.0 | -25.0 | Peak | Horizontal |
| * | 7919.0 | 37.7 | 12.3 | 50.0 | 68.2 | -18.2 | Peak | Horizontal |
| | 8250.5 | 37.9 | 12.2 | 50.1 | 74.0 | -23.9 | Peak | Horizontal |
| * | 8599.0 | 37.7 | 13.4 | 51.1 | 68.2 | -17.1 | Peak | Horizontal |
| | 7502.5 | 36.7 | 11.9 | 48.6 | 74.0 | -25.4 | Peak | Vertical |
| * | 7876.5 | 38.2 | 12.1 | 50.3 | 68.2 | -17.9 | Peak | Vertical |
| | 8148.5 | 38.8 | 12.5 | 51.3 | 74.0 | -22.7 | Peak | Vertical |
| * | 8777.5 | 37.5 | 14.1 | 51.6 | 68.2 | -16.6 | Peak | Vertical |

Note 1: "*" is not in restricted band, its limit is -27dBm/MHz. At a distance of 3 meters, the field strength limit in dBμV/m can be determined by adding a "conversion" factor of 95.2dB to the EIRP limit of -27dBm/MHz to obtain the limit for out of band spurious emissions.

Note 2: Measure Level (dBμV/m) = Reading Level (dBμV) + Factor (dB)

Factor (dB) = Cable Loss (dB) + Antenna Factor (dB/m) - Pre_Amplifier Gain (dB)

| | | | |
|---------------|---|-------------------|-------------------------|
| Product | OmniAccess Stellar | Temperature | 22 ~ 26°C |
| Test Engineer | David Lv | Relative Humidity | 44 ~ 57 % |
| Test Site | AC1 | Test Date | 2019/11/26 ~ 2020/02/24 |
| Test Mode | 802.11a - Ant 0 + 1 + 2 + 3 (CDD Mode) | Test Channel | 48 |
| Model No. | OAW-AP1361D | | |
| Remark: | 1. Average measurement was not performed if peak level lower than average limit. 2. Other frequency was 20dB below limit line within 1-18GHz, there is not show in the report. | | |

| Mark | Frequency (MHz) | Reading Level (dBμV) | Factor (dB) | Measure Level (dBμV/m) | Limit (dBμV/m) | Margin (dB) | Detector | Polarization |
|------|-----------------|----------------------|-------------|------------------------|----------------|-------------|----------|--------------|
| | 7579.0 | 37.7 | 11.6 | 49.3 | 74.0 | -24.7 | Peak | Horizontal |
| * | 7953.0 | 38.2 | 12.5 | 50.7 | 68.2 | -17.5 | Peak | Horizontal |
| | 8114.5 | 38.8 | 12.6 | 51.4 | 74.0 | -22.6 | Peak | Horizontal |
| * | 8828.5 | 37.2 | 14.3 | 51.5 | 68.2 | -16.7 | Peak | Horizontal |
| | 7562.0 | 37.7 | 11.7 | 49.4 | 74.0 | -24.6 | Peak | Vertical |
| * | 7834.0 | 37.3 | 11.9 | 49.2 | 68.2 | -19.0 | Peak | Vertical |
| | 8182.5 | 38.9 | 12.4 | 51.3 | 74.0 | -22.7 | Peak | Vertical |
| * | 8692.5 | 36.9 | 14.0 | 50.9 | 68.2 | -17.3 | Peak | Vertical |

Note 1: "*" is not in restricted band, its limit is -27dBm/MHz. At a distance of 3 meters, the field strength limit in dBμV/m can be determined by adding a "conversion" factor of 95.2dB to the EIRP limit of -27dBm/MHz to obtain the limit for out of band spurious emissions.

Note 2: Measure Level (dBμV/m) = Reading Level (dBμV) + Factor (dB)

Factor (dB) = Cable Loss (dB) + Antenna Factor (dB/m) - Pre_Amplifier Gain (dB)

| | | | |
|---------------|---|-------------------|-------------------------|
| Product | OmniAccess Stellar | Temperature | 22 ~ 26°C |
| Test Engineer | David Lv | Relative Humidity | 44 ~ 57 % |
| Test Site | AC1 | Test Date | 2019/11/26 ~ 2020/02/24 |
| Test Mode | 802.11a - Ant 0 + 1 + 2 + 3 (CDD Mode) | Test Channel | 149 |
| Model No. | OAW-AP1361D | | |
| Remark: | 1. Average measurement was not performed if peak level lower than average limit. 2. Other frequency was 20dB below limit line within 1-18GHz, there is not show in the report. | | |

| Mark | Frequency (MHz) | Reading Level (dBμV) | Factor (dB) | Measure Level (dBμV/m) | Limit (dBμV/m) | Margin (dB) | Detector | Polarization |
|------|-----------------|----------------------|-------------|------------------------|----------------|-------------|----------|--------------|
| | 7494.0 | 36.8 | 11.8 | 48.6 | 74.0 | -25.4 | Peak | Horizontal |
| * | 7961.5 | 37.1 | 12.4 | 49.5 | 68.2 | -18.7 | Peak | Horizontal |
| | 8437.5 | 37.5 | 12.7 | 50.2 | 74.0 | -23.8 | Peak | Horizontal |
| * | 8947.5 | 37.1 | 14.3 | 51.4 | 68.2 | -16.8 | Peak | Horizontal |
| | 7604.5 | 36.9 | 11.8 | 48.7 | 74.0 | -25.3 | Peak | Vertical |
| * | 7876.5 | 37.2 | 12.1 | 49.3 | 68.2 | -18.9 | Peak | Vertical |
| | 8301.5 | 37.7 | 12.2 | 49.9 | 74.0 | -24.1 | Peak | Vertical |
| * | 8743.5 | 36.7 | 14.1 | 50.8 | 68.2 | -17.4 | Peak | Vertical |

Note 1: "*" is not in restricted band, its limit is -27dBm/MHz. At a distance of 3 meters, the field strength limit in dBμV/m can be determined by adding a "conversion" factor of 95.2dB to the EIRP limit of -27dBm/MHz to obtain the limit for out of band spurious emissions.

Note 2: Measure Level (dBμV/m) = Reading Level (dBμV) + Factor (dB)

Factor (dB) = Cable Loss (dB) + Antenna Factor (dB/m) - Pre_Amplifier Gain (dB)

| | | | |
|---------------|---|-------------------|-------------------------|
| Product | OmniAccess Stellar | Temperature | 22 ~ 26°C |
| Test Engineer | David Lv | Relative Humidity | 44 ~ 57 % |
| Test Site | AC1 | Test Date | 2019/11/26 ~ 2020/02/24 |
| Test Mode | 802.11a - Ant 0 + 1 + 2 + 3 (CDD Mode) | Test Channel | 157 |
| Model No. | OAW-AP1361D | | |
| Remark: | 1. Average measurement was not performed if peak level lower than average limit. 2. Other frequency was 20dB below limit line within 1-18GHz, there is not show in the report. | | |

| Mark | Frequency (MHz) | Reading Level (dBμV) | Factor (dB) | Measure Level (dBμV/m) | Limit (dBμV/m) | Margin (dB) | Detector | Polarization |
|------|-----------------|----------------------|-------------|------------------------|----------------|-------------|----------|--------------|
| | 7621.5 | 38.0 | 11.6 | 49.6 | 74.0 | -24.4 | Peak | Horizontal |
| * | 8004.0 | 37.0 | 12.5 | 49.5 | 68.2 | -18.7 | Peak | Horizontal |
| | 8174.0 | 37.2 | 12.4 | 49.6 | 74.0 | -24.4 | Peak | Horizontal |
| * | 8616.0 | 36.8 | 13.5 | 50.3 | 68.2 | -17.9 | Peak | Horizontal |
| | 7528.0 | 38.3 | 11.8 | 50.1 | 74.0 | -23.9 | Peak | Vertical |
| * | 7808.5 | 35.4 | 11.7 | 47.1 | 68.2 | -21.1 | Peak | Vertical |
| | 8165.5 | 36.3 | 12.4 | 48.7 | 74.0 | -25.3 | Peak | Vertical |
| * | 8726.5 | 37.2 | 13.9 | 51.1 | 68.2 | -17.1 | Peak | Vertical |

Note 1: "*" is not in restricted band, its limit is -27dBm/MHz. At a distance of 3 meters, the field strength limit in dBμV/m can be determined by adding a "conversion" factor of 95.2dB to the EIRP limit of -27dBm/MHz to obtain the limit for out of band spurious emissions.

Note 2: Measure Level (dBμV/m) = Reading Level (dBμV) + Factor (dB)

Factor (dB) = Cable Loss (dB) + Antenna Factor (dB/m) - Pre_Amplifier Gain (dB)

| | | | |
|---------------|---|-------------------|-------------------------|
| Product | OmniAccess Stellar | Temperature | 22 ~ 26°C |
| Test Engineer | David Lv | Relative Humidity | 44 ~ 57 % |
| Test Site | AC1 | Test Date | 2019/11/26 ~ 2020/02/24 |
| Test Mode | 802.11a - Ant 0 + 1 + 2 + 3 (CDD Mode) | Test Channel | 165 |
| Model No. | OAW-AP1361D | | |
| Remark: | 1. Average measurement was not performed if peak level lower than average limit. 2. Other frequency was 20dB below limit line within 1-18GHz, there is not show in the report. | | |

| Mark | Frequency (MHz) | Reading Level (dBμV) | Factor (dB) | Measure Level (dBμV/m) | Limit (dBμV/m) | Margin (dB) | Detector | Polarization |
|------|-----------------|----------------------|-------------|------------------------|----------------|-------------|----------|--------------|
| | 7630.0 | 37.5 | 11.5 | 49.0 | 74.0 | -25.0 | Peak | Horizontal |
| * | 7927.5 | 37.9 | 12.4 | 50.3 | 68.2 | -17.9 | Peak | Horizontal |
| | 8208.0 | 37.2 | 12.3 | 49.5 | 74.0 | -24.5 | Peak | Horizontal |
| * | 8769.0 | 35.8 | 14.2 | 50.0 | 68.2 | -18.2 | Peak | Horizontal |
| | 7477.0 | 37.9 | 11.7 | 49.6 | 74.0 | -24.4 | Peak | Vertical |
| * | 7927.5 | 37.0 | 12.4 | 49.4 | 68.2 | -18.8 | Peak | Vertical |
| | 8412.0 | 37.6 | 12.3 | 49.9 | 74.0 | -24.1 | Peak | Vertical |
| * | 8820.0 | 35.5 | 14.3 | 49.8 | 68.2 | -18.4 | Peak | Vertical |

Note 1: "*" is not in restricted band, its limit is -27dBm/MHz. At a distance of 3 meters, the field strength limit in dBμV/m can be determined by adding a "conversion" factor of 95.2dB to the EIRP limit of -27dBm/MHz to obtain the limit for out of band spurious emissions.

Note 2: Measure Level (dBμV/m) = Reading Level (dBμV) + Factor (dB)

Factor (dB) = Cable Loss (dB) + Antenna Factor (dB/m) - Pre_Amplifier Gain (dB)

| | | | |
|---------------|---|-------------------|-------------------------|
| Product | OmniAccess Stellar | Temperature | 22 ~ 26°C |
| Test Engineer | David Lv | Relative Humidity | 44 ~ 57 % |
| Test Site | AC1 | Test Date | 2019/11/26 ~ 2020/02/24 |
| Test Mode | 802.11n-HT20 - Ant 0 + 1 + 2 + 3 (CDD Mode) | Test Channel | 36 |
| Model No. | OAW-AP1361D | | |
| Remark: | 1. Average measurement was not performed if peak level lower than average limit. 2. Other frequency was 20dB below limit line within 1-18GHz, there is not show in the report. | | |

| Mark | Frequency (MHz) | Reading Level (dBμV) | Factor (dB) | Measure Level (dBμV/m) | Limit (dBμV/m) | Margin (dB) | Detector | Polarization |
|------|-----------------|----------------------|-------------|------------------------|----------------|-------------|----------|--------------|
| | 7519.5 | 36.9 | 11.8 | 48.7 | 74.0 | -25.3 | Peak | Horizontal |
| * | 7953.0 | 36.2 | 12.5 | 48.7 | 68.2 | -19.5 | Peak | Horizontal |
| | 8301.5 | 38.0 | 12.2 | 50.2 | 74.0 | -23.8 | Peak | Horizontal |
| * | 8701.0 | 36.6 | 14.0 | 50.6 | 68.2 | -17.6 | Peak | Horizontal |
| | 7672.5 | 37.1 | 11.5 | 48.6 | 74.0 | -25.4 | Peak | Vertical |
| * | 7876.5 | 36.8 | 12.1 | 48.9 | 68.2 | -19.3 | Peak | Vertical |
| | 8191.0 | 38.1 | 12.4 | 50.5 | 74.0 | -23.5 | Peak | Vertical |
| * | 8667.0 | 36.8 | 13.8 | 50.6 | 68.2 | -17.6 | Peak | Vertical |

Note 1: "*" is not in restricted band, its limit is -27dBm/MHz. At a distance of 3 meters, the field strength limit in dBμV/m can be determined by adding a "conversion" factor of 95.2dB to the EIRP limit of -27dBm/MHz to obtain the limit for out of band spurious emissions.

Note 2: Measure Level (dBμV/m) = Reading Level (dBμV) + Factor (dB)

Factor (dB) = Cable Loss (dB) + Antenna Factor (dB/m) - Pre_Amplifier Gain (dB)

| | | | |
|---------------|---|-------------------|-------------------------|
| Product | OmniAccess Stellar | Temperature | 22 ~ 26°C |
| Test Engineer | David Lv | Relative Humidity | 44 ~ 57 % |
| Test Site | AC1 | Test Date | 2019/11/26 ~ 2020/02/24 |
| Test Mode | 802.11n-HT20 - Ant 0 + 1 + 2 + 3 (CDD Mode) | Test Channel | 44 |
| Model No. | OAW-AP1361D | | |
| Remark: | 1. Average measurement was not performed if peak level lower than average limit. 2. Other frequency was 20dB below limit line within 1-18GHz, there is not show in the report. | | |

| Mark | Frequency (MHz) | Reading Level (dBμV) | Factor (dB) | Measure Level (dBμV/m) | Limit (dBμV/m) | Margin (dB) | Detector | Polarization |
|------|-----------------|----------------------|-------------|------------------------|----------------|-------------|----------|--------------|
| | 7502.5 | 36.9 | 11.9 | 48.8 | 74.0 | -25.2 | Peak | Horizontal |
| * | 8012.5 | 39.0 | 12.6 | 51.6 | 68.2 | -16.6 | Peak | Horizontal |
| | 8352.5 | 37.7 | 12.3 | 50.0 | 74.0 | -24.0 | Peak | Horizontal |
| * | 8845.5 | 36.1 | 14.3 | 50.4 | 68.2 | -17.8 | Peak | Horizontal |
| | 7400.5 | 35.7 | 11.8 | 47.5 | 74.0 | -26.5 | Peak | Vertical |
| * | 7927.5 | 37.2 | 12.4 | 49.6 | 68.2 | -18.6 | Peak | Vertical |
| | 8369.5 | 38.0 | 12.3 | 50.3 | 74.0 | -23.7 | Peak | Vertical |
| * | 8752.0 | 37.7 | 14.2 | 51.9 | 68.2 | -16.3 | Peak | Vertical |

Note 1: "*" is not in restricted band, its limit is -27dBm/MHz. At a distance of 3 meters, the field strength limit in dBμV/m can be determined by adding a "conversion" factor of 95.2dB to the EIRP limit of -27dBm/MHz to obtain the limit for out of band spurious emissions.

Note 2: Measure Level (dBμV/m) = Reading Level (dBμV) + Factor (dB)

Factor (dB) = Cable Loss (dB) + Antenna Factor (dB/m) - Pre_Amplifier Gain (dB)

| | | | |
|---------------|---|-------------------|-------------------------|
| Product | OmniAccess Stellar | Temperature | 22 ~ 26°C |
| Test Engineer | David Lv | Relative Humidity | 44 ~ 57 % |
| Test Site | AC1 | Test Date | 2019/11/26 ~ 2020/02/24 |
| Test Mode | 802.11n-HT20 - Ant 0 + 1 + 2 + 3 (CDD Mode) | Test Channel | 48 |
| Model No. | OAW-AP1361D | | |
| Remark: | 1. Average measurement was not performed if peak level lower than average limit. 2. Other frequency was 20dB below limit line within 1-18GHz, there is not show in the report. | | |

| Mark | Frequency (MHz) | Reading Level (dBμV) | Factor (dB) | Measure Level (dBμV/m) | Limit (dBμV/m) | Margin (dB) | Detector | Polarization |
|------|-----------------|----------------------|-------------|------------------------|----------------|-------------|----------|--------------|
| | 7528.0 | 37.6 | 11.8 | 49.4 | 74.0 | -24.6 | Peak | Horizontal |
| * | 7902.0 | 38.2 | 12.1 | 50.3 | 68.2 | -17.9 | Peak | Horizontal |
| | 8182.5 | 38.2 | 12.4 | 50.6 | 74.0 | -23.4 | Peak | Horizontal |
| * | 8752.0 | 37.0 | 14.2 | 51.2 | 68.2 | -17.0 | Peak | Horizontal |
| | 7536.5 | 37.3 | 11.8 | 49.1 | 74.0 | -24.9 | Peak | Vertical |
| * | 7893.5 | 37.5 | 12.1 | 49.6 | 68.2 | -18.6 | Peak | Vertical |
| | 8165.5 | 37.5 | 12.4 | 49.9 | 74.0 | -24.1 | Peak | Vertical |
| * | 8650.0 | 36.9 | 13.7 | 50.6 | 68.2 | -17.6 | Peak | Vertical |

Note 1: "*" is not in restricted band, its limit is -27dBm/MHz. At a distance of 3 meters, the field strength limit in dBμV/m can be determined by adding a "conversion" factor of 95.2dB to the EIRP limit of -27dBm/MHz to obtain the limit for out of band spurious emissions.

Note 2: Measure Level (dBμV/m) = Reading Level (dBμV) + Factor (dB)

Factor (dB) = Cable Loss (dB) + Antenna Factor (dB/m) - Pre_Amplifier Gain (dB)

| | | | |
|---------------|---|-------------------|-------------------------|
| Product | OmniAccess Stellar | Temperature | 22 ~ 26°C |
| Test Engineer | David Lv | Relative Humidity | 44 ~ 57 % |
| Test Site | AC1 | Test Date | 2019/11/26 ~ 2020/02/24 |
| Test Mode | 802.11n-HT20 - Ant 0 + 1 + 2 + 3 (CDD Mode) | Test Channel | 149 |
| Model No. | OAW-AP1361D | | |
| Remark: | 1. Average measurement was not performed if peak level lower than average limit. 2. Other frequency was 20dB below limit line within 1-18GHz, there is not show in the report. | | |

| Mark | Frequency (MHz) | Reading Level (dBμV) | Factor (dB) | Measure Level (dBμV/m) | Limit (dBμV/m) | Margin (dB) | Detector | Polarization |
|------|-----------------|----------------------|-------------|------------------------|----------------|-------------|----------|--------------|
| | 7426.0 | 38.4 | 11.8 | 50.2 | 74.0 | -23.8 | Peak | Horizontal |
| * | 7919.0 | 37.9 | 12.3 | 50.2 | 68.2 | -18.0 | Peak | Horizontal |
| | 8191.0 | 38.3 | 12.4 | 50.7 | 74.0 | -23.3 | Peak | Horizontal |
| * | 8633.0 | 36.0 | 13.5 | 49.5 | 68.2 | -18.7 | Peak | Horizontal |
| | 7341.0 | 37.7 | 11.8 | 49.5 | 74.0 | -24.5 | Peak | Vertical |
| * | 7876.5 | 36.3 | 12.1 | 48.4 | 68.2 | -19.8 | Peak | Vertical |
| | 8038.0 | 37.6 | 12.6 | 50.2 | 74.0 | -23.8 | Peak | Vertical |
| * | 8879.5 | 36.1 | 14.2 | 50.3 | 68.2 | -17.9 | Peak | Vertical |

Note 1: "*" is not in restricted band, its limit is -27dBm/MHz. At a distance of 3 meters, the field strength limit in dBμV/m can be determined by adding a "conversion" factor of 95.2dB to the EIRP limit of -27dBm/MHz to obtain the limit for out of band spurious emissions.

Note 2: Measure Level (dBμV/m) = Reading Level (dBμV) + Factor (dB)

Factor (dB) = Cable Loss (dB) + Antenna Factor (dB/m) - Pre_Amplifier Gain (dB)

| | | | |
|---------------|---|-------------------|-------------------------|
| Product | OmniAccess Stellar | Temperature | 22 ~ 26°C |
| Test Engineer | David Lv | Relative Humidity | 44 ~ 57 % |
| Test Site | AC1 | Test Date | 2019/11/26 ~ 2020/02/24 |
| Test Mode | 802.11n-HT20 - Ant 0 + 1 + 2 + 3 (CDD Mode) | Test Channel | 157 |
| Model No. | OAW-AP1361D | | |
| Remark: | 1. Average measurement was not performed if peak level lower than average limit. 2. Other frequency was 20dB below limit line within 1-18GHz, there is not show in the report. | | |

| Mark | Frequency (MHz) | Reading Level (dBμV) | Factor (dB) | Measure Level (dBμV/m) | Limit (dBμV/m) | Margin (dB) | Detector | Polarization |
|------|-----------------|----------------------|-------------|------------------------|----------------|-------------|----------|--------------|
| | 7545.0 | 37.4 | 11.7 | 49.1 | 74.0 | -24.9 | Peak | Horizontal |
| * | 7808.5 | 38.5 | 11.7 | 50.2 | 68.2 | -18.0 | Peak | Horizontal |
| | 8301.5 | 37.7 | 12.2 | 49.9 | 74.0 | -24.1 | Peak | Horizontal |
| * | 8616.0 | 36.4 | 13.5 | 49.9 | 68.2 | -18.3 | Peak | Horizontal |
| | 7596.0 | 37.3 | 11.8 | 49.1 | 74.0 | -24.9 | Peak | Vertical |
| * | 7910.5 | 38.2 | 12.2 | 50.4 | 68.2 | -17.8 | Peak | Vertical |
| | 8361.0 | 37.2 | 12.4 | 49.6 | 74.0 | -24.4 | Peak | Vertical |
| * | 8777.5 | 36.0 | 14.1 | 50.1 | 68.2 | -18.1 | Peak | Vertical |

Note 1: "*" is not in restricted band, its limit is -27dBm/MHz. At a distance of 3 meters, the field strength limit in dBμV/m can be determined by adding a "conversion" factor of 95.2dB to the EIRP limit of -27dBm/MHz to obtain the limit for out of band spurious emissions.

Note 2: Measure Level (dBμV/m) = Reading Level (dBμV) + Factor (dB)

Factor (dB) = Cable Loss (dB) + Antenna Factor (dB/m) - Pre_Amplifier Gain (dB)

| | | | |
|---------------|---|-------------------|-------------------------|
| Product | OmniAccess Stellar | Temperature | 22 ~ 26°C |
| Test Engineer | David Lv | Relative Humidity | 44 ~ 57 % |
| Test Site | AC1 | Test Date | 2019/11/26 ~ 2020/02/24 |
| Test Mode | 802.11n-HT20 - Ant 0 + 1 + 2 + 3 (CDD Mode) | Test Channel | 165 |
| Model No. | OAW-AP1361D | | |
| Remark: | 1. Average measurement was not performed if peak level lower than average limit. 2. Other frequency was 20dB below limit line within 1-18GHz, there is not show in the report. | | |

| Mark | Frequency (MHz) | Reading Level (dBμV) | Factor (dB) | Measure Level (dBμV/m) | Limit (dBμV/m) | Margin (dB) | Detector | Polarization |
|------|-----------------|----------------------|-------------|------------------------|----------------|-------------|----------|--------------|
| | 7375.0 | 37.0 | 11.9 | 48.9 | 74.0 | -25.1 | Peak | Horizontal |
| * | 7961.5 | 37.3 | 12.4 | 49.7 | 68.2 | -18.5 | Peak | Horizontal |
| | 8276.0 | 37.7 | 12.3 | 50.0 | 74.0 | -24.0 | Peak | Horizontal |
| * | 8701.0 | 36.3 | 14.0 | 50.3 | 68.2 | -17.9 | Peak | Horizontal |
| | 7613.0 | 37.6 | 11.8 | 49.4 | 74.0 | -24.6 | Peak | Vertical |
| * | 7885.0 | 36.5 | 12.1 | 48.6 | 68.2 | -19.6 | Peak | Vertical |
| | 8242.0 | 36.8 | 12.2 | 49.0 | 74.0 | -25.0 | Peak | Vertical |
| * | 8658.5 | 35.2 | 13.7 | 48.9 | 68.2 | -19.3 | Peak | Vertical |

Note 1: "*" is not in restricted band, its limit is -27dBm/MHz. At a distance of 3 meters, the field strength limit in dBμV/m can be determined by adding a "conversion" factor of 95.2dB to the EIRP limit of -27dBm/MHz to obtain the limit for out of band spurious emissions.

Note 2: Measure Level (dBμV/m) = Reading Level (dBμV) + Factor (dB)

Factor (dB) = Cable Loss (dB) + Antenna Factor (dB/m) - Pre_Amplifier Gain (dB)

| | | | |
|---------------|---|-------------------|-------------------------|
| Product | OmniAccess Stellar | Temperature | 22 ~ 26°C |
| Test Engineer | David Lv | Relative Humidity | 44 ~ 57 % |
| Test Site | AC1 | Test Date | 2019/11/26 ~ 2020/02/24 |
| Test Mode | 802.11n-HT40 - Ant 0 + 1 + 2 + 3 (CDD Mode) | Test Channel | 38 |
| Model No. | OAW-AP1361D | | |
| Remark: | 1. Average measurement was not performed if peak level lower than average limit. 2. Other frequency was 20dB below limit line within 1-18GHz, there is not show in the report. | | |

| Mark | Frequency (MHz) | Reading Level (dBμV) | Factor (dB) | Measure Level (dBμV/m) | Limit (dBμV/m) | Margin (dB) | Detector | Polarization |
|------|-----------------|----------------------|-------------|------------------------|----------------|-------------|----------|--------------|
| | 7417.5 | 37.1 | 11.8 | 48.9 | 74.0 | -25.1 | Peak | Horizontal |
| * | 7936.0 | 37.2 | 12.5 | 49.7 | 68.2 | -18.5 | Peak | Horizontal |
| | 8276.0 | 37.4 | 12.3 | 49.7 | 74.0 | -24.3 | Peak | Horizontal |
| * | 8692.5 | 35.6 | 14.0 | 49.6 | 68.2 | -18.6 | Peak | Horizontal |
| | 7409.0 | 37.8 | 11.8 | 49.6 | 74.0 | -24.4 | Peak | Vertical |
| * | 7876.5 | 36.7 | 12.1 | 48.8 | 68.2 | -19.4 | Peak | Vertical |
| | 8361.0 | 37.7 | 12.4 | 50.1 | 74.0 | -23.9 | Peak | Vertical |
| * | 8599.0 | 36.5 | 13.4 | 49.9 | 68.2 | -18.3 | Peak | Vertical |

Note 1: "*" is not in restricted band, its limit is -27dBm/MHz. At a distance of 3 meters, the field strength limit in dBμV/m can be determined by adding a "conversion" factor of 95.2dB to the EIRP limit of -27dBm/MHz to obtain the limit for out of band spurious emissions.

Note 2: Measure Level (dBμV/m) = Reading Level (dBμV) + Factor (dB)

Factor (dB) = Cable Loss (dB) + Antenna Factor (dB/m) - Pre_Amplifier Gain (dB)

| | | | |
|---------------|---|-------------------|-------------------------|
| Product | OmniAccess Stellar | Temperature | 22 ~ 26°C |
| Test Engineer | David Lv | Relative Humidity | 44 ~ 57 % |
| Test Site | AC1 | Test Date | 2019/11/26 ~ 2020/02/24 |
| Test Mode | 802.11n-HT40 - Ant 0 + 1 + 2 + 3 (CDD Mode) | Test Channel | 46 |
| Model No. | OAW-AP1361D | | |
| Remark: | 1. Average measurement was not performed if peak level lower than average limit. 2. Other frequency was 20dB below limit line within 1-18GHz, there is not show in the report. | | |

| Mark | Frequency (MHz) | Reading Level (dBμV) | Factor (dB) | Measure Level (dBμV/m) | Limit (dBμV/m) | Margin (dB) | Detector | Polarization |
|------|-----------------|----------------------|-------------|------------------------|----------------|-------------|----------|--------------|
| | 7587.5 | 37.5 | 11.7 | 49.2 | 74.0 | -24.8 | Peak | Horizontal |
| * | 7910.5 | 37.3 | 12.2 | 49.5 | 68.2 | -18.7 | Peak | Horizontal |
| | 8386.5 | 37.2 | 12.4 | 49.6 | 74.0 | -24.4 | Peak | Horizontal |
| * | 8811.5 | 36.6 | 14.3 | 50.9 | 68.2 | -17.3 | Peak | Horizontal |
| | 7664.0 | 37.4 | 11.4 | 48.8 | 74.0 | -25.2 | Peak | Vertical |
| * | 7868.0 | 37.1 | 12.1 | 49.2 | 68.2 | -19.0 | Peak | Vertical |
| | 8242.0 | 36.1 | 12.2 | 48.3 | 74.0 | -25.7 | Peak | Vertical |
| * | 8735.0 | 34.9 | 14.0 | 48.9 | 68.2 | -19.3 | Peak | Vertical |

Note 1: "*" is not in restricted band, its limit is -27dBm/MHz. At a distance of 3 meters, the field strength limit in dBμV/m can be determined by adding a "conversion" factor of 95.2dB to the EIRP limit of -27dBm/MHz to obtain the limit for out of band spurious emissions.

Note 2: Measure Level (dBμV/m) = Reading Level (dBμV) + Factor (dB)

Factor (dB) = Cable Loss (dB) + Antenna Factor (dB/m) - Pre_Amplifier Gain (dB)

| | | | |
|---------------|---|-------------------|-------------------------|
| Product | OmniAccess Stellar | Temperature | 22 ~ 26°C |
| Test Engineer | David Lv | Relative Humidity | 44 ~ 57 % |
| Test Site | AC1 | Test Date | 2019/11/26 ~ 2020/02/24 |
| Test Mode | 802.11n-HT40 - Ant 0 + 1 + 2 + 3 (CDD Mode) | Test Channel | 151 |
| Model No. | OAW-AP1361D | | |
| Remark: | 1. Average measurement was not performed if peak level lower than average limit. 2. Other frequency was 20dB below limit line within 1-18GHz, there is not show in the report. | | |

| Mark | Frequency (MHz) | Reading Level (dBμV) | Factor (dB) | Measure Level (dBμV/m) | Limit (dBμV/m) | Margin (dB) | Detector | Polarization |
|------|-----------------|----------------------|-------------|------------------------|----------------|-------------|----------|--------------|
| | 7468.5 | 36.5 | 11.8 | 48.3 | 74.0 | -25.7 | Peak | Horizontal |
| * | 7851.0 | 36.5 | 11.9 | 48.4 | 68.2 | -19.8 | Peak | Horizontal |
| | 8276.0 | 36.9 | 12.3 | 49.2 | 74.0 | -24.8 | Peak | Horizontal |
| * | 8667.0 | 36.1 | 13.8 | 49.9 | 68.2 | -18.3 | Peak | Horizontal |
| | 7604.5 | 37.5 | 11.8 | 49.3 | 74.0 | -24.7 | Peak | Vertical |
| * | 7842.5 | 37.1 | 11.9 | 49.0 | 68.2 | -19.2 | Peak | Vertical |
| | 8174.0 | 37.2 | 12.4 | 49.6 | 74.0 | -24.4 | Peak | Vertical |
| * | 8735.0 | 36.0 | 14.0 | 50.0 | 68.2 | -18.2 | Peak | Vertical |

Note 1: "*" is not in restricted band, its limit is -27dBm/MHz. At a distance of 3 meters, the field strength limit in dBμV/m can be determined by adding a "conversion" factor of 95.2dB to the EIRP limit of -27dBm/MHz to obtain the limit for out of band spurious emissions.

Note 2: Measure Level (dBμV/m) = Reading Level (dBμV) + Factor (dB)

Factor (dB) = Cable Loss (dB) + Antenna Factor (dB/m) - Pre_Amplifier Gain (dB)

| | | | |
|---------------|---|-------------------|-------------------------|
| Product | OmniAccess Stellar | Temperature | 22 ~ 26°C |
| Test Engineer | David Lv | Relative Humidity | 44 ~ 57 % |
| Test Site | AC1 | Test Date | 2019/11/26 ~ 2020/02/24 |
| Test Mode | 802.11n-HT40 - Ant 0 + 1 + 2 + 3 (CDD Mode) | Test Channel | 159 |
| Model No. | OAW-AP1361D | | |
| Remark: | 1. Average measurement was not performed if peak level lower than average limit. 2. Other frequency was 20dB below limit line within 1-18GHz, there is not show in the report. | | |

| Mark | Frequency (MHz) | Reading Level (dBμV) | Factor (dB) | Measure Level (dBμV/m) | Limit (dBμV/m) | Margin (dB) | Detector | Polarization |
|------|-----------------|----------------------|-------------|------------------------|----------------|-------------|----------|--------------|
| | 7664.0 | 37.8 | 11.4 | 49.2 | 74.0 | -24.8 | Peak | Horizontal |
| * | 7851.0 | 36.5 | 11.9 | 48.4 | 68.2 | -19.8 | Peak | Horizontal |
| | 8208.0 | 37.0 | 12.3 | 49.3 | 74.0 | -24.7 | Peak | Horizontal |
| * | 8743.5 | 37.1 | 14.1 | 51.2 | 68.2 | -17.0 | Peak | Horizontal |
| | 7511.0 | 38.3 | 11.9 | 50.2 | 74.0 | -23.8 | Peak | Vertical |
| * | 7953.0 | 37.6 | 12.5 | 50.1 | 68.2 | -18.1 | Peak | Vertical |
| | 8165.5 | 36.7 | 12.4 | 49.1 | 74.0 | -24.9 | Peak | Vertical |
| * | 8590.5 | 37.4 | 13.3 | 50.7 | 68.2 | -17.5 | Peak | Vertical |

Note 1: "*" is not in restricted band, its limit is -27dBm/MHz. At a distance of 3 meters, the field strength limit in dBμV/m can be determined by adding a "conversion" factor of 95.2dB to the EIRP limit of -27dBm/MHz to obtain the limit for out of band spurious emissions.

Note 2: Measure Level (dBμV/m) = Reading Level (dBμV) + Factor (dB)

Factor (dB) = Cable Loss (dB) + Antenna Factor (dB/m) - Pre_Amplifier Gain (dB)

| | | | |
|---------------|---|-------------------|-------------------------|
| Product | OmniAccess Stellar | Temperature | 22 ~ 26°C |
| Test Engineer | David Lv | Relative Humidity | 44 ~ 57 % |
| Test Site | AC1 | Test Date | 2019/11/26 ~ 2020/02/24 |
| Test Mode | 802.11ax-HE20 - Ant 0 + 1 + 2 + 3 (CDD Mode) | Test Channel | 36 |
| Model No. | OAW-AP1361D | | |
| Remark: | 1. Average measurement was not performed if peak level lower than average limit. 2. Other frequency was 20dB below limit line within 1-18GHz, there is not show in the report. | | |

| Mark | Frequency (MHz) | Reading Level (dBμV) | Factor (dB) | Measure Level (dBμV/m) | Limit (dBμV/m) | Margin (dB) | Detector | Polarization |
|------|-----------------|----------------------|-------------|------------------------|----------------|-------------|----------|--------------|
| | 7570.5 | 38.0 | 11.7 | 49.7 | 74.0 | -24.3 | Peak | Horizontal |
| * | 7842.5 | 36.0 | 11.9 | 47.9 | 68.2 | -20.3 | Peak | Horizontal |
| | 8437.5 | 38.3 | 12.7 | 51.0 | 74.0 | -23.0 | Peak | Horizontal |
| * | 8777.5 | 37.6 | 14.1 | 51.7 | 68.2 | -16.5 | Peak | Horizontal |
| | 7630.0 | 38.3 | 11.5 | 49.8 | 74.0 | -24.2 | Peak | Vertical |
| * | 7936.0 | 37.8 | 12.5 | 50.3 | 68.2 | -17.9 | Peak | Vertical |
| | 8403.5 | 37.9 | 12.4 | 50.3 | 74.0 | -23.7 | Peak | Vertical |
| * | 8930.5 | 38.3 | 14.3 | 52.6 | 68.2 | -15.6 | Peak | Vertical |

Note 1: "*" is not in restricted band, its limit is -27dBm/MHz. At a distance of 3 meters, the field strength limit in dBμV/m can be determined by adding a "conversion" factor of 95.2dB to the EIRP limit of -27dBm/MHz to obtain the limit for out of band spurious emissions.

Note 2: Measure Level (dBμV/m) = Reading Level (dBμV) + Factor (dB)

Factor (dB) = Cable Loss (dB) + Antenna Factor (dB/m) - Pre_Amplifier Gain (dB)

| | | | |
|---------------|---|-------------------|-------------------------|
| Product | OmniAccess Stellar | Temperature | 22 ~ 26°C |
| Test Engineer | David Lv | Relative Humidity | 44 ~ 57 % |
| Test Site | AC1 | Test Date | 2019/11/26 ~ 2020/02/24 |
| Test Mode | 802.11ax-HE20 - Ant 0 + 1 + 2 + 3 (CDD Mode) | Test Channel | 44 |
| Model No. | OAW-AP1361D | | |
| Remark: | 1. Average measurement was not performed if peak level lower than average limit. 2. Other frequency was 20dB below limit line within 1-18GHz, there is not show in the report. | | |

| Mark | Frequency (MHz) | Reading Level (dBμV) | Factor (dB) | Measure Level (dBμV/m) | Limit (dBμV/m) | Margin (dB) | Detector | Polarization |
|------|-----------------|----------------------|-------------|------------------------|----------------|-------------|----------|--------------|
| | 7460.0 | 38.1 | 11.9 | 50.0 | 74.0 | -24.0 | Peak | Horizontal |
| * | 7978.5 | 38.1 | 12.4 | 50.5 | 68.2 | -17.7 | Peak | Horizontal |
| | 8335.5 | 38.3 | 12.2 | 50.5 | 74.0 | -23.5 | Peak | Horizontal |
| * | 8777.5 | 37.4 | 14.1 | 51.5 | 68.2 | -16.7 | Peak | Horizontal |
| | 7664.0 | 38.2 | 11.4 | 49.6 | 74.0 | -24.4 | Peak | Vertical |
| * | 7936.0 | 37.5 | 12.5 | 50.0 | 68.2 | -18.2 | Peak | Vertical |
| | 8361.0 | 37.5 | 12.4 | 49.9 | 74.0 | -24.1 | Peak | Vertical |
| * | 8854.0 | 36.5 | 14.4 | 50.9 | 68.2 | -17.3 | Peak | Vertical |

Note 1: "*" is not in restricted band, its limit is -27dBm/MHz. At a distance of 3 meters, the field strength limit in dBμV/m can be determined by adding a "conversion" factor of 95.2dB to the EIRP limit of -27dBm/MHz to obtain the limit for out of band spurious emissions.

Note 2: Measure Level (dBμV/m) = Reading Level (dBμV) + Factor (dB)

Factor (dB) = Cable Loss (dB) + Antenna Factor (dB/m) - Pre_Amplifier Gain (dB)

| | | | |
|---------------|---|-------------------|-------------------------|
| Product | OmniAccess Stellar | Temperature | 22 ~ 26°C |
| Test Engineer | David Lv | Relative Humidity | 44 ~ 57 % |
| Test Site | AC1 | Test Date | 2019/11/26 ~ 2020/02/24 |
| Test Mode | 802.11ax-HE20 - Ant 0 + 1 + 2 + 3 (CDD Mode) | Test Channel | 48 |
| Model No. | OAW-AP1361D | | |
| Remark: | 1. Average measurement was not performed if peak level lower than average limit. 2. Other frequency was 20dB below limit line within 1-18GHz, there is not show in the report. | | |

| Mark | Frequency (MHz) | Reading Level (dBμV) | Factor (dB) | Measure Level (dBμV/m) | Limit (dBμV/m) | Margin (dB) | Detector | Polarization |
|------|-----------------|----------------------|-------------|------------------------|----------------|-------------|----------|--------------|
| | 7621.5 | 38.5 | 11.6 | 50.1 | 74.0 | -23.9 | Peak | Horizontal |
| * | 7885.0 | 37.1 | 12.1 | 49.2 | 68.2 | -19.0 | Peak | Horizontal |
| | 8420.5 | 38.5 | 12.5 | 51.0 | 74.0 | -23.0 | Peak | Horizontal |
| * | 8854.0 | 38.0 | 14.4 | 52.4 | 68.2 | -15.8 | Peak | Horizontal |
| | 7443.0 | 38.4 | 12.1 | 50.5 | 74.0 | -23.5 | Peak | Vertical |
| * | 7953.0 | 37.0 | 12.5 | 49.5 | 68.2 | -18.7 | Peak | Vertical |
| | 8140.0 | 38.4 | 12.4 | 50.8 | 74.0 | -23.2 | Peak | Vertical |
| * | 8837.0 | 38.1 | 14.3 | 52.4 | 68.2 | -15.8 | Peak | Vertical |

Note 1: "*" is not in restricted band, its limit is -27dBm/MHz. At a distance of 3 meters, the field strength limit in dBμV/m can be determined by adding a "conversion" factor of 95.2dB to the EIRP limit of -27dBm/MHz to obtain the limit for out of band spurious emissions.

Note 2: Measure Level (dBμV/m) = Reading Level (dBμV) + Factor (dB)

Factor (dB) = Cable Loss (dB) + Antenna Factor (dB/m) - Pre_Amplifier Gain (dB)

| | | | |
|---------------|---|-------------------|-------------------------|
| Product | OmniAccess Stellar | Temperature | 22 ~ 26°C |
| Test Engineer | David Lv | Relative Humidity | 44 ~ 57 % |
| Test Site | AC1 | Test Date | 2019/11/26 ~ 2020/02/24 |
| Test Mode | 802.11ax-HE20 - Ant 0 + 1 + 2 + 3 (CDD Mode) | Test Channel | 149 |
| Model No. | OAW-AP1361D | | |
| Remark: | 1. Average measurement was not performed if peak level lower than average limit. 2. Other frequency was 20dB below limit line within 1-18GHz, there is not show in the report. | | |

| Mark | Frequency (MHz) | Reading Level (dBμV) | Factor (dB) | Measure Level (dBμV/m) | Limit (dBμV/m) | Margin (dB) | Detector | Polarization |
|------|-----------------|----------------------|-------------|------------------------|----------------|-------------|----------|--------------|
| | 7443.0 | 37.9 | 12.1 | 50.0 | 74.0 | -24.0 | Peak | Horizontal |
| * | 7936.0 | 38.5 | 12.5 | 51.0 | 68.2 | -17.2 | Peak | Horizontal |
| | 9058.0 | 37.4 | 14.5 | 51.9 | 74.0 | -22.1 | Peak | Horizontal |
| * | 9508.5 | 37.1 | 16.1 | 53.2 | 68.2 | -15.0 | Peak | Horizontal |
| | 7392.0 | 37.5 | 11.8 | 49.3 | 74.0 | -24.7 | Peak | Vertical |
| * | 7808.5 | 38.5 | 11.7 | 50.2 | 68.2 | -18.0 | Peak | Vertical |
| | 8488.5 | 37.9 | 12.8 | 50.7 | 74.0 | -23.3 | Peak | Vertical |
| * | 8845.5 | 38.0 | 14.3 | 52.3 | 68.2 | -15.9 | Peak | Vertical |

Note 1: "*" is not in restricted band, its limit is -27dBm/MHz. At a distance of 3 meters, the field strength limit in dBμV/m can be determined by adding a "conversion" factor of 95.2dB to the EIRP limit of -27dBm/MHz to obtain the limit for out of band spurious emissions.

Note 2: Measure Level (dBμV/m) = Reading Level (dBμV) + Factor (dB)

Factor (dB) = Cable Loss (dB) + Antenna Factor (dB/m) - Pre_Amplifier Gain (dB)

| | | | |
|---------------|---|-------------------|-------------------------|
| Product | OmniAccess Stellar | Temperature | 22 ~ 26°C |
| Test Engineer | David Lv | Relative Humidity | 44 ~ 57 % |
| Test Site | AC1 | Test Date | 2019/11/26 ~ 2020/02/24 |
| Test Mode | 802.11ax-HE20 - Ant 0 + 1 + 2 + 3 (CDD Mode) | Test Channel | 157 |
| Model No. | OAW-AP1361D | | |
| Remark: | 1. Average measurement was not performed if peak level lower than average limit. 2. Other frequency was 20dB below limit line within 1-18GHz, there is not show in the report. | | |

| Mark | Frequency (MHz) | Reading Level (dBμV) | Factor (dB) | Measure Level (dBμV/m) | Limit (dBμV/m) | Margin (dB) | Detector | Polarization |
|------|-----------------|----------------------|-------------|------------------------|----------------|-------------|----------|--------------|
| | 7706.5 | 38.7 | 11.6 | 50.3 | 74.0 | -23.7 | Peak | Horizontal |
| * | 8012.5 | 38.2 | 12.6 | 50.8 | 68.2 | -17.4 | Peak | Horizontal |
| | 8429.0 | 38.2 | 12.7 | 50.9 | 74.0 | -23.1 | Peak | Horizontal |
| * | 8786.0 | 39.1 | 13.3 | 52.4 | 68.2 | -15.8 | Peak | Horizontal |
| | 7366.5 | 37.9 | 11.9 | 49.8 | 74.0 | -24.2 | Peak | Vertical |
| * | 7936.0 | 38.2 | 12.5 | 50.7 | 68.2 | -17.5 | Peak | Vertical |
| | 8412.0 | 38.3 | 12.3 | 50.6 | 74.0 | -23.4 | Peak | Vertical |
| * | 8760.5 | 37.4 | 14.2 | 51.6 | 68.2 | -16.6 | Peak | Vertical |

Note 1: "*" is not in restricted band, its limit is -27dBm/MHz. At a distance of 3 meters, the field strength limit in dBμV/m can be determined by adding a "conversion" factor of 95.2dB to the EIRP limit of -27dBm/MHz to obtain the limit for out of band spurious emissions.

Note 2: Measure Level (dBμV/m) = Reading Level (dBμV) + Factor (dB)

Factor (dB) = Cable Loss (dB) + Antenna Factor (dB/m) - Pre_Amplifier Gain (dB)

| | | | |
|---------------|---|-------------------|-------------------------|
| Product | OmniAccess Stellar | Temperature | 22 ~ 26°C |
| Test Engineer | David Lv | Relative Humidity | 44 ~ 57 % |
| Test Site | AC1 | Test Date | 2019/11/26 ~ 2020/02/24 |
| Test Mode | 802.11ax-HE20 - Ant 0 + 1 + 2 + 3 (CDD Mode) | Test Channel | 165 |
| Model No. | OAW-AP1361D | | |
| Remark: | 1. Average measurement was not performed if peak level lower than average limit. 2. Other frequency was 20dB below limit line within 1-18GHz, there is not show in the report. | | |

| Mark | Frequency (MHz) | Reading Level (dBμV) | Factor (dB) | Measure Level (dBμV/m) | Limit (dBμV/m) | Margin (dB) | Detector | Polarization |
|------|-----------------|----------------------|-------------|------------------------|----------------|-------------|----------|--------------|
| | 7613.0 | 38.1 | 11.8 | 49.9 | 74.0 | -24.1 | Peak | Horizontal |
| * | 7902.0 | 36.9 | 12.1 | 49.0 | 68.2 | -19.2 | Peak | Horizontal |
| | 8250.5 | 38.5 | 12.2 | 50.7 | 74.0 | -23.3 | Peak | Horizontal |
| * | 8854.0 | 37.6 | 14.4 | 52.0 | 68.2 | -16.2 | Peak | Horizontal |
| | 7349.5 | 37.8 | 11.9 | 49.7 | 74.0 | -24.3 | Peak | Vertical |
| * | 7961.5 | 37.2 | 12.4 | 49.6 | 68.2 | -18.6 | Peak | Vertical |
| | 8361.0 | 37.8 | 12.4 | 50.2 | 74.0 | -23.8 | Peak | Vertical |
| * | 8735.0 | 38.2 | 14.0 | 52.2 | 68.2 | -16.0 | Peak | Vertical |

Note 1: "*" is not in restricted band, its limit is -27dBm/MHz. At a distance of 3 meters, the field strength limit in dBμV/m can be determined by adding a "conversion" factor of 95.2dB to the EIRP limit of -27dBm/MHz to obtain the limit for out of band spurious emissions.

Note 2: Measure Level (dBμV/m) = Reading Level (dBμV) + Factor (dB)

Factor (dB) = Cable Loss (dB) + Antenna Factor (dB/m) - Pre_Amplifier Gain (dB)

| | | | |
|---------------|---|-------------------|-------------------------|
| Product | OmniAccess Stellar | Temperature | 22 ~ 26°C |
| Test Engineer | David Lv | Relative Humidity | 44 ~ 57 % |
| Test Site | AC1 | Test Date | 2019/11/26 ~ 2020/02/24 |
| Test Mode | 802.11ax-HE40 - Ant 0 + 1 + 2 + 3 (CDD Mode) | Test Channel | 38 |
| Model No. | OAW-AP1361D | | |
| Remark: | 1. Average measurement was not performed if peak level lower than average limit. 2. Other frequency was 20dB below limit line within 1-18GHz, there is not show in the report. | | |

| Mark | Frequency (MHz) | Reading Level (dBμV) | Factor (dB) | Measure Level (dBμV/m) | Limit (dBμV/m) | Margin (dB) | Detector | Polarization |
|------|-----------------|----------------------|-------------|------------------------|----------------|-------------|----------|--------------|
| | 7426.0 | 38.0 | 11.8 | 49.8 | 74.0 | -24.2 | Peak | Horizontal |
| * | 7936.0 | 38.6 | 12.5 | 51.1 | 68.2 | -17.1 | Peak | Horizontal |
| | 8165.5 | 38.7 | 12.4 | 51.1 | 74.0 | -22.9 | Peak | Horizontal |
| * | 8701.0 | 37.7 | 14.0 | 51.7 | 68.2 | -16.5 | Peak | Horizontal |
| | 7358.0 | 37.8 | 11.9 | 49.7 | 74.0 | -24.3 | Peak | Vertical |
| * | 8012.5 | 37.9 | 12.6 | 50.5 | 68.2 | -17.7 | Peak | Vertical |
| | 8395.0 | 38.3 | 12.4 | 50.7 | 74.0 | -23.3 | Peak | Vertical |
| * | 8964.5 | 38.1 | 14.3 | 52.4 | 68.2 | -15.8 | Peak | Vertical |

Note 1: "*" is not in restricted band, its limit is -27dBm/MHz. At a distance of 3 meters, the field strength limit in dBμV/m can be determined by adding a "conversion" factor of 95.2dB to the EIRP limit of -27dBm/MHz to obtain the limit for out of band spurious emissions.

Note 2: Measure Level (dBμV/m) = Reading Level (dBμV) + Factor (dB)

Factor (dB) = Cable Loss (dB) + Antenna Factor (dB/m) - Pre_Amplifier Gain (dB)

| | | | |
|---------------|---|-------------------|-------------------------|
| Product | OmniAccess Stellar | Temperature | 22 ~ 26°C |
| Test Engineer | David Lv | Relative Humidity | 44 ~ 57 % |
| Test Site | AC1 | Test Date | 2019/11/26 ~ 2020/02/24 |
| Test Mode | 802.11ax-HE40 - Ant 0 + 1 + 2 + 3 (CDD Mode) | Test Channel | 46 |
| Model No. | OAW-AP1361D | | |
| Remark: | 1. Average measurement was not performed if peak level lower than average limit. 2. Other frequency was 20dB below limit line within 1-18GHz, there is not show in the report. | | |

| Mark | Frequency (MHz) | Reading Level (dBμV) | Factor (dB) | Measure Level (dBμV/m) | Limit (dBμV/m) | Margin (dB) | Detector | Polarization |
|------|-----------------|----------------------|-------------|------------------------|----------------|-------------|----------|--------------|
| | 7443.0 | 38.0 | 12.1 | 50.1 | 74.0 | -23.9 | Peak | Horizontal |
| * | 7987.0 | 37.8 | 12.4 | 50.2 | 68.2 | -18.0 | Peak | Horizontal |
| | 8352.5 | 38.4 | 12.3 | 50.7 | 74.0 | -23.3 | Peak | Horizontal |
| * | 8692.5 | 36.5 | 14.0 | 50.5 | 68.2 | -17.7 | Peak | Horizontal |
| | 7307.0 | 37.8 | 11.7 | 49.5 | 74.0 | -24.5 | Peak | Vertical |
| * | 7842.5 | 37.2 | 11.9 | 49.1 | 68.2 | -19.1 | Peak | Vertical |
| | 8420.5 | 38.3 | 12.5 | 50.8 | 74.0 | -23.2 | Peak | Vertical |
| * | 8752.0 | 37.8 | 14.2 | 52.0 | 68.2 | -16.2 | Peak | Vertical |

Note 1: "*" is not in restricted band, its limit is -27dBm/MHz. At a distance of 3 meters, the field strength limit in dBμV/m can be determined by adding a "conversion" factor of 95.2dB to the EIRP limit of -27dBm/MHz to obtain the limit for out of band spurious emissions.

Note 2: Measure Level (dBμV/m) = Reading Level (dBμV) + Factor (dB)

Factor (dB) = Cable Loss (dB) + Antenna Factor (dB/m) - Pre_Amplifier Gain (dB)

| | | | |
|---------------|---|-------------------|-------------------------|
| Product | OmniAccess Stellar | Temperature | 22 ~ 26°C |
| Test Engineer | David Lv | Relative Humidity | 44 ~ 57 % |
| Test Site | AC1 | Test Date | 2019/11/26 ~ 2020/02/24 |
| Test Mode | 802.11ax-HE40 - Ant 0 + 1 + 2 + 3 (CDD Mode) | Test Channel | 151 |
| Model No. | OAW-AP1361D | | |
| Remark: | 1. Average measurement was not performed if peak level lower than average limit. 2. Other frequency was 20dB below limit line within 1-18GHz, there is not show in the report. | | |

| Mark | Frequency (MHz) | Reading Level (dBμV) | Factor (dB) | Measure Level (dBμV/m) | Limit (dBμV/m) | Margin (dB) | Detector | Polarization |
|------|-----------------|----------------------|-------------|------------------------|----------------|-------------|----------|--------------|
| | 7485.5 | 38.9 | 11.8 | 50.7 | 74.0 | -23.3 | Peak | Horizontal |
| * | 7953.0 | 37.5 | 12.5 | 50.0 | 68.2 | -18.2 | Peak | Horizontal |
| | 8276.0 | 37.3 | 12.3 | 49.6 | 74.0 | -24.4 | Peak | Horizontal |
| * | 8735.0 | 36.5 | 14.0 | 50.5 | 68.2 | -17.7 | Peak | Horizontal |
| | 7596.0 | 38.0 | 11.8 | 49.8 | 74.0 | -24.2 | Peak | Vertical |
| * | 7936.0 | 38.1 | 12.5 | 50.6 | 68.2 | -17.6 | Peak | Vertical |
| | 8301.5 | 38.4 | 12.2 | 50.6 | 74.0 | -23.4 | Peak | Vertical |
| * | 8709.5 | 36.7 | 13.9 | 50.6 | 68.2 | -17.6 | Peak | Vertical |

Note 1: "*" is not in restricted band, its limit is -27dBm/MHz. At a distance of 3 meters, the field strength limit in dBμV/m can be determined by adding a "conversion" factor of 95.2dB to the EIRP limit of -27dBm/MHz to obtain the limit for out of band spurious emissions.

Note 2: Measure Level (dBμV/m) = Reading Level (dBμV) + Factor (dB)

Factor (dB) = Cable Loss (dB) + Antenna Factor (dB/m) - Pre_Amplifier Gain (dB)

| | | | |
|---------------|---|-------------------|-------------------------|
| Product | OmniAccess Stellar | Temperature | 22 ~ 26°C |
| Test Engineer | David Lv | Relative Humidity | 44 ~ 57 % |
| Test Site | AC1 | Test Date | 2019/11/26 ~ 2020/02/24 |
| Test Mode | 802.11ax-HE40 - Ant 0 + 1 + 2 + 3 (CDD Mode) | Test Channel | 159 |
| Model No. | OAW-AP1361D | | |
| Remark: | 1. Average measurement was not performed if peak level lower than average limit. 2. Other frequency was 20dB below limit line within 1-18GHz, there is not show in the report. | | |

| Mark | Frequency (MHz) | Reading Level (dBμV) | Factor (dB) | Measure Level (dBμV/m) | Limit (dBμV/m) | Margin (dB) | Detector | Polarization |
|------|-----------------|----------------------|-------------|------------------------|----------------|-------------|----------|--------------|
| | 7630.0 | 38.1 | 11.5 | 49.6 | 74.0 | -24.4 | Peak | Horizontal |
| * | 7893.5 | 37.7 | 12.1 | 49.8 | 68.2 | -18.4 | Peak | Horizontal |
| | 8412.0 | 38.1 | 12.3 | 50.4 | 74.0 | -23.6 | Peak | Horizontal |
| * | 8735.0 | 36.6 | 14.0 | 50.6 | 68.2 | -17.6 | Peak | Horizontal |
| | 7698.0 | 38.3 | 11.7 | 50.0 | 74.0 | -24.0 | Peak | Vertical |
| * | 8658.5 | 38.4 | 13.0 | 51.4 | 68.2 | -16.8 | Peak | Vertical |
| | 9168.5 | 38.7 | 14.3 | 53.0 | 74.0 | -21.0 | Peak | Vertical |
| * | 9942.0 | 36.6 | 16.1 | 52.7 | 68.2 | -15.5 | Peak | Vertical |

Note 1: "*" is not in restricted band, its limit is -27dBm/MHz. At a distance of 3 meters, the field strength limit in dBμV/m can be determined by adding a "conversion" factor of 95.2dB to the EIRP limit of -27dBm/MHz to obtain the limit for out of band spurious emissions.

Note 2: Measure Level (dBμV/m) = Reading Level (dBμV) + Factor (dB)

Factor (dB) = Cable Loss (dB) + Antenna Factor (dB/m) - Pre_Amplifier Gain (dB)

| | | | |
|---------------|---|-------------------|-------------------------|
| Product | OmniAccess Stellar | Temperature | 22 ~ 26°C |
| Test Engineer | David Lv | Relative Humidity | 44 ~ 57 % |
| Test Site | AC1 | Test Date | 2019/11/26 ~ 2020/02/24 |
| Test Mode | 802.11ax-HE80 - Ant 0 + 1 + 2 + 3 (CDD Mode) | Test Channel | 42 |
| Model No. | OAW-AP1361D | | |
| Remark: | 1. Average measurement was not performed if peak level lower than average limit. 2. Other frequency was 20dB below limit line within 1-18GHz, there is not show in the report. | | |

| Mark | Frequency (MHz) | Reading Level (dBμV) | Factor (dB) | Measure Level (dBμV/m) | Limit (dBμV/m) | Margin (dB) | Detector | Polarization |
|------|-----------------|----------------------|-------------|------------------------|----------------|-------------|----------|--------------|
| | 7689.5 | 37.9 | 11.6 | 49.5 | 74.0 | -24.5 | Peak | Horizontal |
| * | 8012.5 | 37.7 | 12.6 | 50.3 | 68.2 | -17.9 | Peak | Horizontal |
| | 8318.5 | 37.1 | 12.2 | 49.3 | 74.0 | -24.7 | Peak | Horizontal |
| * | 8845.5 | 37.9 | 14.3 | 52.2 | 68.2 | -16.0 | Peak | Horizontal |
| | 7579.0 | 38.4 | 11.6 | 50.0 | 74.0 | -24.0 | Peak | Vertical |
| * | 7842.5 | 36.5 | 12.1 | 48.6 | 68.2 | -19.6 | Peak | Vertical |
| | 8446.0 | 37.7 | 12.7 | 50.4 | 74.0 | -23.6 | Peak | Vertical |
| * | 8692.5 | 36.4 | 14.0 | 50.4 | 68.2 | -17.8 | Peak | Vertical |

Note 1: "*" is not in restricted band, its limit is -27dBm/MHz. At a distance of 3 meters, the field strength limit in dBμV/m can be determined by adding a "conversion" factor of 95.2dB to the EIRP limit of -27dBm/MHz to obtain the limit for out of band spurious emissions.

Note 2: Measure Level (dBμV/m) = Reading Level (dBμV) + Factor (dB)

Factor (dB) = Cable Loss (dB) + Antenna Factor (dB/m) - Pre_Amplifier Gain (dB)

| | | | |
|---------------|---|-------------------|-------------------------|
| Product | OmniAccess Stellar | Temperature | 22 ~ 26°C |
| Test Engineer | David Lv | Relative Humidity | 44 ~ 57 % |
| Test Site | AC1 | Test Date | 2019/11/26 ~ 2020/02/24 |
| Test Mode | 802.11ax-HE80 - Ant 0 + 1 + 2 + 3 (CDD Mode) | Test Channel | 155 |
| Model No. | OAW-AP1361D | | |
| Remark: | 1. Average measurement was not performed if peak level lower than average limit. 2. Other frequency was 20dB below limit line within 1-18GHz, there is not show in the report. | | |

| Mark | Frequency (MHz) | Reading Level (dBμV) | Factor (dB) | Measure Level (dBμV/m) | Limit (dBμV/m) | Margin (dB) | Detector | Polarization |
|------|-----------------|----------------------|-------------|------------------------|----------------|-------------|----------|--------------|
| | 7366.5 | 38.4 | 11.9 | 50.3 | 74.0 | -23.7 | Peak | Horizontal |
| * | 7936.0 | 37.3 | 12.5 | 49.8 | 68.2 | -18.4 | Peak | Horizontal |
| | 8361.0 | 37.4 | 12.4 | 49.8 | 74.0 | -24.2 | Peak | Horizontal |
| * | 8828.5 | 38.0 | 14.3 | 52.3 | 68.2 | -15.9 | Peak | Horizontal |
| | 7332.5 | 38.0 | 11.7 | 49.7 | 74.0 | -24.3 | Peak | Vertical |
| * | 8012.5 | 37.0 | 12.6 | 49.6 | 68.2 | -18.6 | Peak | Vertical |
| | 9049.5 | 36.8 | 14.5 | 51.3 | 74.0 | -22.7 | Peak | Vertical |
| * | 9678.5 | 36.5 | 16.5 | 53.0 | 68.2 | -15.2 | Peak | Vertical |

Note 1: "*" is not in restricted band, its limit is -27dBm/MHz. At a distance of 3 meters, the field strength limit in dBμV/m can be determined by adding a "conversion" factor of 95.2dB to the EIRP limit of -27dBm/MHz to obtain the limit for out of band spurious emissions.

Note 2: Measure Level (dBμV/m) = Reading Level (dBμV) + Factor (dB)

Factor (dB) = Cable Loss (dB) + Antenna Factor (dB/m) - Pre_Amplifier Gain (dB)

| | | | |
|---------------|---|-------------------|-------------------------|
| Product | OmniAccess Stellar | Temperature | 22 ~ 26°C |
| Test Engineer | David Lv | Relative Humidity | 44 ~ 57 % |
| Test Site | AC1 | Test Date | 2019/11/26 ~ 2020/02/24 |
| Test Mode | 802.11n-HT20 - Ant 0 + 1 + 2 + 3 (Beamforming Mode) | Test Channel | 36 |
| Model No. | OAW-AP1361D | | |
| Remark: | 1. Average measurement was not performed if peak level lower than average limit. 2. Other frequency was 20dB below limit line within 1-18GHz, there is not show in the report. | | |

| Mark | Frequency (MHz) | Reading Level (dBμV) | Factor (dB) | Measure Level (dBμV/m) | Limit (dBμV/m) | Margin (dB) | Detector | Polarization |
|------|-----------------|----------------------|-------------|------------------------|----------------|-------------|----------|--------------|
| * | 9857.0 | 32.4 | 15.1 | 47.5 | 68.2 | -20.7 | Peak | Horizontal |
| * | 10248.0 | 32.5 | 16.2 | 48.7 | 68.2 | -19.5 | Peak | Horizontal |
| | 11166.0 | 31.7 | 18.6 | 50.3 | 74.0 | -23.7 | Peak | Horizontal |
| | 11582.5 | 30.3 | 19.8 | 50.1 | 74.0 | -23.9 | Peak | Horizontal |
| * | 9729.5 | 33.8 | 14.6 | 48.4 | 68.2 | -19.8 | Peak | Vertical |
| * | 10035.5 | 31.8 | 14.8 | 46.6 | 68.2 | -21.6 | Peak | Vertical |
| | 11004.5 | 31.9 | 18.2 | 50.1 | 74.0 | -23.9 | Peak | Vertical |
| | 12126.5 | 31.4 | 20.0 | 51.4 | 74.0 | -22.6 | Peak | Vertical |

Note 1: "*" is not in restricted band, its limit is -27dBm/MHz. At a distance of 3 meters, the field strength limit in dBμV/m can be determined by adding a "conversion" factor of 95.2dB to the EIRP limit of -27dBm/MHz to obtain the limit for out of band spurious emissions.

Note 2: Measure Level (dBμV/m) = Reading Level (dBμV) + Factor (dB)

Factor (dB) = Cable Loss (dB) + Antenna Factor (dB/m) - Pre_Amplifier Gain (dB)

| | | | |
|---------------|---|-------------------|-------------------------|
| Product | OmniAccess Stellar | Temperature | 22 ~ 26°C |
| Test Engineer | David Lv | Relative Humidity | 44 ~ 57 % |
| Test Site | AC1 | Test Date | 2019/11/26 ~ 2020/02/24 |
| Test Mode | 802.11n-HT20 - Ant 0 + 1 + 2 + 3 (Beamforming Mode) | Test Channel | 44 |
| Model No. | OAW-AP1361D | | |
| Remark: | 1. Average measurement was not performed if peak level lower than average limit. 2. Other frequency was 20dB below limit line within 1-18GHz, there is not show in the report. | | |

| Mark | Frequency (MHz) | Reading Level (dBμV) | Factor (dB) | Measure Level (dBμV/m) | Limit (dBμV/m) | Margin (dB) | Detector | Polarization |
|------|-----------------|----------------------|-------------|------------------------|----------------|-------------|----------|--------------|
| * | 9746.5 | 33.2 | 14.9 | 48.1 | 68.2 | -20.1 | Peak | Horizontal |
| * | 10222.5 | 32.3 | 15.8 | 48.1 | 68.2 | -20.1 | Peak | Horizontal |
| | 10936.5 | 32.3 | 17.9 | 50.2 | 74.0 | -23.8 | Peak | Horizontal |
| | 12084.0 | 31.6 | 20.1 | 51.7 | 74.0 | -22.3 | Peak | Horizontal |
| * | 9865.5 | 33.1 | 15.2 | 48.3 | 68.2 | -19.9 | Peak | Vertical |
| * | 10316.0 | 31.8 | 16.6 | 48.4 | 68.2 | -19.8 | Peak | Vertical |
| | 11591.0 | 30.7 | 20.1 | 50.8 | 74.0 | -23.2 | Peak | Vertical |
| | 12024.5 | 32.1 | 19.7 | 51.8 | 74.0 | -22.2 | Peak | Vertical |

Note 1: "*" is not in restricted band, its limit is -27dBm/MHz. At a distance of 3 meters, the field strength limit in dBμV/m can be determined by adding a "conversion" factor of 95.2dB to the EIRP limit of -27dBm/MHz to obtain the limit for out of band spurious emissions.

Note 2: Measure Level (dBμV/m) = Reading Level (dBμV) + Factor (dB)

Factor (dB) = Cable Loss (dB) + Antenna Factor (dB/m) - Pre_Amplifier Gain (dB)

| | | | |
|---------------|---|-------------------|-------------------------|
| Product | OmniAccess Stellar | Temperature | 22 ~ 26°C |
| Test Engineer | David Lv | Relative Humidity | 44 ~ 57 % |
| Test Site | AC1 | Test Date | 2019/11/26 ~ 2020/02/24 |
| Test Mode | 802.11n-HT20 - Ant 0 + 1 + 2 + 3 (Beamforming Mode) | Test Channel | 48 |
| Model No. | OAW-AP1361D | | |
| Remark: | 1. Average measurement was not performed if peak level lower than average limit. 2. Other frequency was 20dB below limit line within 1-18GHz, there is not show in the report. | | |

| Mark | Frequency (MHz) | Reading Level (dBμV) | Factor (dB) | Measure Level (dBμV/m) | Limit (dBμV/m) | Margin (dB) | Detector | Polarization |
|------|-----------------|----------------------|-------------|------------------------|----------------|-------------|----------|--------------|
| * | 9678.5 | 33.5 | 14.4 | 47.9 | 68.2 | -20.3 | Peak | Horizontal |
| * | 10129.0 | 33.5 | 15.0 | 48.5 | 68.2 | -19.7 | Peak | Horizontal |
| | 11047.0 | 31.7 | 18.7 | 50.4 | 74.0 | -23.6 | Peak | Horizontal |
| | 11582.5 | 32.0 | 19.8 | 51.8 | 74.0 | -22.2 | Peak | Horizontal |
| * | 10052.5 | 33.2 | 14.9 | 48.1 | 68.2 | -20.1 | Peak | Vertical |
| * | 10392.5 | 33.6 | 16.4 | 50.0 | 68.2 | -18.2 | Peak | Vertical |
| | 11599.5 | 30.9 | 19.9 | 50.8 | 74.0 | -23.2 | Peak | Vertical |
| | 12228.5 | 30.3 | 20.8 | 51.1 | 74.0 | -22.9 | Peak | Vertical |

Note 1: "*" is not in restricted band, its limit is -27dBm/MHz. At a distance of 3 meters, the field strength limit in dBμV/m can be determined by adding a "conversion" factor of 95.2dB to the EIRP limit of -27dBm/MHz to obtain the limit for out of band spurious emissions.

Note 2: Measure Level (dBμV/m) = Reading Level (dBμV) + Factor (dB)

Factor (dB) = Cable Loss (dB) + Antenna Factor (dB/m) - Pre_Amplifier Gain (dB)

| | | | |
|---------------|---|-------------------|-------------------------|
| Product | OmniAccess Stellar | Temperature | 22 ~ 26°C |
| Test Engineer | David Lv | Relative Humidity | 44 ~ 57 % |
| Test Site | AC1 | Test Date | 2019/11/26 ~ 2020/02/24 |
| Test Mode | 802.11n-HT20 - Ant 0 + 1 + 2 + 3 (Beamforming Mode) | Test Channel | 149 |
| Model No. | OAW-AP1361D | | |
| Remark: | 1. Average measurement was not performed if peak level lower than average limit. 2. Other frequency was 20dB below limit line within 1-18GHz, there is not show in the report. | | |

| Mark | Frequency (MHz) | Reading Level (dBμV) | Factor (dB) | Measure Level (dBμV/m) | Limit (dBμV/m) | Margin (dB) | Detector | Polarization |
|------|-----------------|----------------------|-------------|------------------------|----------------|-------------|----------|--------------|
| * | 9840.0 | 32.8 | 15.1 | 47.9 | 68.2 | -20.3 | Peak | Horizontal |
| * | 10256.5 | 32.4 | 16.2 | 48.6 | 68.2 | -19.6 | Peak | Horizontal |
| | 11540.0 | 31.1 | 20.3 | 51.4 | 74.0 | -22.6 | Peak | Horizontal |
| | 12135.0 | 31.4 | 20.2 | 51.6 | 74.0 | -22.4 | Peak | Horizontal |
| * | 9755.0 | 33.3 | 15.0 | 48.3 | 68.2 | -19.9 | Peak | Vertical |
| * | 10214.0 | 33.5 | 15.9 | 49.4 | 68.2 | -18.8 | Peak | Vertical |
| | 11293.5 | 31.5 | 18.9 | 50.4 | 74.0 | -23.6 | Peak | Vertical |
| | 12245.5 | 30.9 | 20.5 | 51.4 | 74.0 | -22.6 | Peak | Vertical |

Note 1: "*" is not in restricted band, its limit is -27dBm/MHz. At a distance of 3 meters, the field strength limit in dBμV/m can be determined by adding a "conversion" factor of 95.2dB to the EIRP limit of -27dBm/MHz to obtain the limit for out of band spurious emissions.

Note 2: Measure Level (dBμV/m) = Reading Level (dBμV) + Factor (dB)

Factor (dB) = Cable Loss (dB) + Antenna Factor (dB/m) - Pre_Amplifier Gain (dB)

| | | | |
|---------------|---|-------------------|-------------------------|
| Product | OmniAccess Stellar | Temperature | 22 ~ 26°C |
| Test Engineer | David Lv | Relative Humidity | 44 ~ 57 % |
| Test Site | AC1 | Test Date | 2019/11/26 ~ 2020/02/24 |
| Test Mode | 802.11n-HT20 - Ant 0 + 1 + 2 + 3 (Beamforming Mode) | Test Channel | 157 |
| Model No. | OAW-AP1361D | | |
| Remark: | 1. Average measurement was not performed if peak level lower than average limit. 2. Other frequency was 20dB below limit line within 1-18GHz, there is not show in the report. | | |

| Mark | Frequency (MHz) | Reading Level (dBμV) | Factor (dB) | Measure Level (dBμV/m) | Limit (dBμV/m) | Margin (dB) | Detector | Polarization |
|------|-----------------|----------------------|-------------|------------------------|----------------|-------------|----------|--------------|
| * | 9865.5 | 33.1 | 15.2 | 48.3 | 68.2 | -19.9 | Peak | Horizontal |
| * | 10256.5 | 32.9 | 16.2 | 49.1 | 68.2 | -19.1 | Peak | Horizontal |
| | 11047.0 | 31.7 | 18.7 | 50.4 | 74.0 | -23.6 | Peak | Horizontal |
| | 12279.5 | 31.3 | 20.8 | 52.1 | 74.0 | -21.9 | Peak | Horizontal |
| * | 9882.5 | 32.6 | 15.3 | 47.9 | 68.2 | -20.3 | Peak | Vertical |
| * | 10256.5 | 32.9 | 16.2 | 49.1 | 68.2 | -19.1 | Peak | Vertical |
| | 11480.5 | 30.3 | 19.9 | 50.2 | 74.0 | -23.8 | Peak | Vertical |
| | 12143.5 | 31.7 | 20.3 | 52.0 | 74.0 | -22.0 | Peak | Vertical |

Note 1: "*" is not in restricted band, its limit is -27dBm/MHz. At a distance of 3 meters, the field strength limit in dBμV/m can be determined by adding a "conversion" factor of 95.2dB to the EIRP limit of -27dBm/MHz to obtain the limit for out of band spurious emissions.

Note 2: Measure Level (dBμV/m) = Reading Level (dBμV) + Factor (dB)

Factor (dB) = Cable Loss (dB) + Antenna Factor (dB/m) - Pre_Amplifier Gain (dB)

| | | | |
|---------------|---|-------------------|-------------------------|
| Product | OmniAccess Stellar | Temperature | 22 ~ 26°C |
| Test Engineer | David Lv | Relative Humidity | 44 ~ 57 % |
| Test Site | AC1 | Test Date | 2019/11/26 ~ 2020/02/24 |
| Test Mode | 802.11n-HT20 - Ant 0 + 1 + 2 + 3 (Beamforming Mode) | Test Channel | 165 |
| Model No. | OAW-AP1361D | | |
| Remark: | 1. Average measurement was not performed if peak level lower than average limit. 2. Other frequency was 20dB below limit line within 1-18GHz, there is not show in the report. | | |

| Mark | Frequency (MHz) | Reading Level (dBμV) | Factor (dB) | Measure Level (dBμV/m) | Limit (dBμV/m) | Margin (dB) | Detector | Polarization |
|------|-----------------|----------------------|-------------|------------------------|----------------|-------------|----------|--------------|
| * | 9602.0 | 33.9 | 14.2 | 48.1 | 68.2 | -20.1 | Peak | Horizontal |
| * | 10265.0 | 33.2 | 16.2 | 49.4 | 68.2 | -18.8 | Peak | Horizontal |
| | 11472.0 | 31.1 | 20.0 | 51.1 | 74.0 | -22.9 | Peak | Horizontal |
| | 12228.5 | 31.0 | 20.8 | 51.8 | 74.0 | -22.2 | Peak | Horizontal |
| * | 9925.0 | 33.1 | 15.0 | 48.1 | 68.2 | -20.1 | Peak | Vertical |
| * | 10265.0 | 32.2 | 16.2 | 48.4 | 68.2 | -19.8 | Peak | Vertical |
| | 11684.5 | 32.0 | 19.8 | 51.8 | 74.0 | -22.2 | Peak | Vertical |
| | 12118.0 | 31.5 | 19.8 | 51.3 | 74.0 | -22.7 | Peak | Vertical |

Note 1: "*" is not in restricted band, its limit is -27dBm/MHz. At a distance of 3 meters, the field strength limit in dBμV/m can be determined by adding a "conversion" factor of 95.2dB to the EIRP limit of -27dBm/MHz to obtain the limit for out of band spurious emissions.

Note 2: Measure Level (dBμV/m) = Reading Level (dBμV) + Factor (dB)

Factor (dB) = Cable Loss (dB) + Antenna Factor (dB/m) - Pre_Amplifier Gain (dB)

| | | | |
|---------------|---|-------------------|-------------------------|
| Product | OmniAccess Stellar | Temperature | 22 ~ 26°C |
| Test Engineer | David Lv | Relative Humidity | 44 ~ 57 % |
| Test Site | AC1 | Test Date | 2019/11/26 ~ 2020/02/24 |
| Test Mode | 802.11n-HT40 - Ant 0 + 1 + 2 + 3 (Beamforming Mode) | Test Channel | 38 |
| Model No. | OAW-AP1361D | | |
| Remark: | 1. Average measurement was not performed if peak level lower than average limit. 2. Other frequency was 20dB below limit line within 1-18GHz, there is not show in the report. | | |

| Mark | Frequency (MHz) | Reading Level (dBμV) | Factor (dB) | Measure Level (dBμV/m) | Limit (dBμV/m) | Margin (dB) | Detector | Polarization |
|------|-----------------|----------------------|-------------|------------------------|----------------|-------------|----------|--------------|
| * | 9712.5 | 33.3 | 14.7 | 48.0 | 68.2 | -20.2 | Peak | Horizontal |
| * | 10180.0 | 33.8 | 15.4 | 49.2 | 68.2 | -19.0 | Peak | Horizontal |
| | 11472.0 | 31.4 | 20.0 | 51.4 | 74.0 | -22.6 | Peak | Horizontal |
| | 12084.0 | 31.0 | 20.1 | 51.1 | 74.0 | -22.9 | Peak | Horizontal |
| * | 9806.0 | 33.7 | 14.9 | 48.6 | 68.2 | -19.6 | Peak | Vertical |
| * | 10180.0 | 34.0 | 15.4 | 49.4 | 68.2 | -18.8 | Peak | Vertical |
| | 11599.5 | 31.4 | 19.9 | 51.3 | 74.0 | -22.7 | Peak | Vertical |
| | 12364.5 | 31.6 | 19.8 | 51.4 | 74.0 | -22.6 | Peak | Vertical |

Note 1: "*" is not in restricted band, its limit is -27dBm/MHz. At a distance of 3 meters, the field strength limit in dBμV/m can be determined by adding a "conversion" factor of 95.2dB to the EIRP limit of -27dBm/MHz to obtain the limit for out of band spurious emissions.

Note 2: Measure Level (dBμV/m) = Reading Level (dBμV) + Factor (dB)

Factor (dB) = Cable Loss (dB) + Antenna Factor (dB/m) - Pre_Amplifier Gain (dB)

| | | | |
|---------------|---|-------------------|-------------------------|
| Product | OmniAccess Stellar | Temperature | 22 ~ 26°C |
| Test Engineer | David Lv | Relative Humidity | 44 ~ 57 % |
| Test Site | AC1 | Test Date | 2019/11/26 ~ 2020/02/24 |
| Test Mode | 802.11n-HT40 - Ant 0 + 1 + 2 + 3 (Beamforming Mode) | Test Channel | 46 |
| Model No. | OAW-AP1361D | | |
| Remark: | 1. Average measurement was not performed if peak level lower than average limit. 2. Other frequency was 20dB below limit line within 1-18GHz, there is not show in the report. | | |

| Mark | Frequency (MHz) | Reading Level (dBμV) | Factor (dB) | Measure Level (dBμV/m) | Limit (dBμV/m) | Margin (dB) | Detector | Polarization |
|------|-----------------|----------------------|-------------|------------------------|----------------|-------------|----------|--------------|
| * | 9789.0 | 33.9 | 14.8 | 48.7 | 68.2 | -19.5 | Peak | Horizontal |
| * | 10273.5 | 33.0 | 16.1 | 49.1 | 68.2 | -19.1 | Peak | Horizontal |
| | 11285.0 | 31.4 | 19.0 | 50.4 | 74.0 | -23.6 | Peak | Horizontal |
| | 12024.5 | 31.5 | 19.7 | 51.2 | 74.0 | -22.8 | Peak | Horizontal |
| * | 9772.0 | 32.7 | 14.9 | 47.6 | 68.2 | -20.6 | Peak | Vertical |
| * | 10214.0 | 32.3 | 15.9 | 48.2 | 68.2 | -20.0 | Peak | Vertical |
| | 11591.0 | 31.0 | 20.1 | 51.1 | 74.0 | -22.9 | Peak | Vertical |
| | 12160.5 | 31.2 | 20.2 | 51.4 | 74.0 | -22.6 | Peak | Vertical |

Note 1: "*" is not in restricted band, its limit is -27dBm/MHz. At a distance of 3 meters, the field strength limit in dBμV/m can be determined by adding a "conversion" factor of 95.2dB to the EIRP limit of -27dBm/MHz to obtain the limit for out of band spurious emissions.

Note 2: Measure Level (dBμV/m) = Reading Level (dBμV) + Factor (dB)

Factor (dB) = Cable Loss (dB) + Antenna Factor (dB/m) - Pre_Amplifier Gain (dB)

| | | | |
|---------------|---|-------------------|-------------------------|
| Product | OmniAccess Stellar | Temperature | 22 ~ 26°C |
| Test Engineer | David Lv | Relative Humidity | 44 ~ 57 % |
| Test Site | AC1 | Test Date | 2019/11/26 ~ 2020/02/24 |
| Test Mode | 802.11n-HT40 - Ant 0 + 1 + 2 + 3 (Beamforming Mode) | Test Channel | 151 |
| Model No. | OAW-AP1361D | | |
| Remark: | 1. Average measurement was not performed if peak level lower than average limit. 2. Other frequency was 20dB below limit line within 1-18GHz, there is not show in the report. | | |

| Mark | Frequency (MHz) | Reading Level (dBμV) | Factor (dB) | Measure Level (dBμV/m) | Limit (dBμV/m) | Margin (dB) | Detector | Polarization |
|------|-----------------|----------------------|-------------|------------------------|----------------|-------------|----------|--------------|
| * | 9772.0 | 32.9 | 14.9 | 47.8 | 68.2 | -20.4 | Peak | Horizontal |
| * | 10248.0 | 33.3 | 16.2 | 49.5 | 68.2 | -18.7 | Peak | Horizontal |
| | 11047.0 | 31.3 | 18.7 | 50.0 | 74.0 | -24.0 | Peak | Horizontal |
| | 11846.0 | 30.3 | 20.6 | 50.9 | 74.0 | -23.1 | Peak | Horizontal |
| * | 9797.5 | 33.7 | 14.9 | 48.6 | 68.2 | -19.6 | Peak | Vertical |
| * | 10316.0 | 32.5 | 16.6 | 49.1 | 68.2 | -19.1 | Peak | Vertical |
| | 11429.5 | 29.8 | 19.4 | 49.2 | 74.0 | -24.8 | Peak | Vertical |
| | 12211.5 | 30.1 | 20.6 | 50.7 | 74.0 | -23.3 | Peak | Vertical |

Note 1: "*" is not in restricted band, its limit is -27dBm/MHz. At a distance of 3 meters, the field strength limit in dBμV/m can be determined by adding a "conversion" factor of 95.2dB to the EIRP limit of -27dBm/MHz to obtain the limit for out of band spurious emissions.

Note 2: Measure Level (dBμV/m) = Reading Level (dBμV) + Factor (dB)

Factor (dB) = Cable Loss (dB) + Antenna Factor (dB/m) - Pre_Amplifier Gain (dB)

| | | | |
|---------------|---|-------------------|-------------------------|
| Product | OmniAccess Stellar | Temperature | 22 ~ 26°C |
| Test Engineer | David Lv | Relative Humidity | 44 ~ 57 % |
| Test Site | AC1 | Test Date | 2019/11/26 ~ 2020/02/24 |
| Test Mode | 802.11n-HT40 - Ant 0 + 1 + 2 + 3 (Beamforming Mode) | Test Channel | 159 |
| Model No. | OAW-AP1361D | | |
| Remark: | 1. Average measurement was not performed if peak level lower than average limit. 2. Other frequency was 20dB below limit line within 1-18GHz, there is not show in the report. | | |

| Mark | Frequency (MHz) | Reading Level (dBμV) | Factor (dB) | Measure Level (dBμV/m) | Limit (dBμV/m) | Margin (dB) | Detector | Polarization |
|------|-----------------|----------------------|-------------|------------------------|----------------|-------------|----------|--------------|
| * | 9704.0 | 33.2 | 14.8 | 48.0 | 68.2 | -20.2 | Peak | Horizontal |
| * | 10341.5 | 33.6 | 16.4 | 50.0 | 68.2 | -18.2 | Peak | Horizontal |
| | 11480.5 | 31.3 | 19.9 | 51.2 | 74.0 | -22.8 | Peak | Horizontal |
| | 12237.0 | 30.9 | 20.8 | 51.7 | 74.0 | -22.3 | Peak | Horizontal |
| * | 9593.5 | 32.1 | 14.2 | 46.3 | 68.2 | -21.9 | Peak | Vertical |
| * | 10265.0 | 33.0 | 16.2 | 49.2 | 68.2 | -19.0 | Peak | Vertical |
| | 10996.0 | 31.4 | 18.4 | 49.8 | 74.0 | -24.2 | Peak | Vertical |
| | 11676.0 | 31.5 | 19.6 | 51.1 | 74.0 | -22.9 | Peak | Vertical |

Note 1: "*" is not in restricted band, its limit is -27dBm/MHz. At a distance of 3 meters, the field strength limit in dBμV/m can be determined by adding a "conversion" factor of 95.2dB to the EIRP limit of -27dBm/MHz to obtain the limit for out of band spurious emissions.

Note 2: Measure Level (dBμV/m) = Reading Level (dBμV) + Factor (dB)

Factor (dB) = Cable Loss (dB) + Antenna Factor (dB/m) - Pre_Amplifier Gain (dB)

| | | | |
|---------------|---|-------------------|-------------------------|
| Product | OmniAccess Stellar | Temperature | 22 ~ 26°C |
| Test Engineer | David Lv | Relative Humidity | 44 ~ 57 % |
| Test Site | AC1 | Test Date | 2019/11/26 ~ 2020/02/24 |
| Test Mode | 802.11ax-HE20 - Ant 0 + 1 + 2 + 3 (Beamforming Mode) | Test Channel | 36 |
| Model No. | OAW-AP1361D | | |
| Remark: | 1. Average measurement was not performed if peak level lower than average limit. 2. Other frequency was 20dB below limit line within 1-18GHz, there is not show in the report. | | |

| Mark | Frequency (MHz) | Reading Level (dBμV) | Factor (dB) | Measure Level (dBμV/m) | Limit (dBμV/m) | Margin (dB) | Detector | Polarization |
|------|-----------------|----------------------|-------------|------------------------|----------------|-------------|----------|--------------|
| * | 9797.5 | 33.3 | 14.9 | 48.2 | 68.2 | -20.0 | Peak | Horizontal |
| * | 10367.0 | 33.2 | 16.5 | 49.7 | 68.2 | -18.5 | Peak | Horizontal |
| | 11489.0 | 30.9 | 19.7 | 50.6 | 74.0 | -23.4 | Peak | Horizontal |
| | 12007.5 | 31.5 | 19.6 | 51.1 | 74.0 | -22.9 | Peak | Horizontal |
| * | 9857.0 | 33.8 | 15.1 | 48.9 | 68.2 | -19.3 | Peak | Vertical |
| * | 10256.5 | 32.8 | 16.2 | 49.0 | 68.2 | -19.2 | Peak | Vertical |
| | 11421.0 | 32.0 | 19.5 | 51.5 | 74.0 | -22.5 | Peak | Vertical |
| | 12058.5 | 31.9 | 19.6 | 51.5 | 74.0 | -22.5 | Peak | Vertical |

Note 1: "*" is not in restricted band, its limit is -27dBm/MHz. At a distance of 3 meters, the field strength limit in dBμV/m can be determined by adding a "conversion" factor of 95.2dB to the EIRP limit of -27dBm/MHz to obtain the limit for out of band spurious emissions.

Note 2: Measure Level (dBμV/m) = Reading Level (dBμV) + Factor (dB)

Factor (dB) = Cable Loss (dB) + Antenna Factor (dB/m) - Pre_Amplifier Gain (dB)

| | | | |
|---------------|---|-------------------|-------------------------|
| Product | OmniAccess Stellar | Temperature | 22 ~ 26°C |
| Test Engineer | David Lv | Relative Humidity | 44 ~ 57 % |
| Test Site | AC1 | Test Date | 2019/11/26 ~ 2020/02/24 |
| Test Mode | 802.11ax-HE20 - Ant 0 + 1 + 2 + 3 (Beamforming Mode) | Test Channel | 44 |
| Model No. | OAW-AP1361D | | |
| Remark: | 1. Average measurement was not performed if peak level lower than average limit. 2. Other frequency was 20dB below limit line within 1-18GHz, there is not show in the report. | | |

| Mark | Frequency (MHz) | Reading Level (dBμV) | Factor (dB) | Measure Level (dBμV/m) | Limit (dBμV/m) | Margin (dB) | Detector | Polarization |
|------|-----------------|----------------------|-------------|------------------------|----------------|-------------|----------|--------------|
| * | 9738.0 | 33.6 | 14.7 | 48.3 | 68.2 | -19.9 | Peak | Horizontal |
| * | 10171.5 | 32.2 | 15.3 | 47.5 | 68.2 | -20.7 | Peak | Horizontal |
| | 11098.0 | 32.6 | 18.3 | 50.9 | 74.0 | -23.1 | Peak | Horizontal |
| | 11540.0 | 31.4 | 20.3 | 51.7 | 74.0 | -22.3 | Peak | Horizontal |
| * | 9738.0 | 33.6 | 14.7 | 48.3 | 68.2 | -19.9 | Peak | Vertical |
| * | 10103.5 | 33.8 | 14.8 | 48.6 | 68.2 | -19.6 | Peak | Vertical |
| | 11030.0 | 32.4 | 18.1 | 50.5 | 74.0 | -23.5 | Peak | Vertical |
| | 12092.5 | 31.4 | 20.1 | 51.5 | 74.0 | -22.5 | Peak | Vertical |

Note 1: "*" is not in restricted band, its limit is -27dBm/MHz. At a distance of 3 meters, the field strength limit in dBμV/m can be determined by adding a "conversion" factor of 95.2dB to the EIRP limit of -27dBm/MHz to obtain the limit for out of band spurious emissions.

Note 2: Measure Level (dBμV/m) = Reading Level (dBμV) + Factor (dB)

Factor (dB) = Cable Loss (dB) + Antenna Factor (dB/m) - Pre_Amplifier Gain (dB)

| | | | |
|---------------|---|-------------------|-------------------------|
| Product | OmniAccess Stellar | Temperature | 22 ~ 26°C |
| Test Engineer | David Lv | Relative Humidity | 44 ~ 57 % |
| Test Site | AC1 | Test Date | 2019/11/26 ~ 2020/02/24 |
| Test Mode | 802.11ax-HE20 - Ant 0 + 1 + 2 + 3 (Beamforming Mode) | Test Channel | 48 |
| Model No. | OAW-AP1361D | | |
| Remark: | 1. Average measurement was not performed if peak level lower than average limit. 2. Other frequency was 20dB below limit line within 1-18GHz, there is not show in the report. | | |

| Mark | Frequency (MHz) | Reading Level (dBμV) | Factor (dB) | Measure Level (dBμV/m) | Limit (dBμV/m) | Margin (dB) | Detector | Polarization |
|------|-----------------|----------------------|-------------|------------------------|----------------|-------------|----------|--------------|
| * | 9755.0 | 33.0 | 15.0 | 48.0 | 68.2 | -20.2 | Peak | Horizontal |
| * | 10469.0 | 32.7 | 16.3 | 49.0 | 68.2 | -19.2 | Peak | Horizontal |
| | 11344.5 | 32.2 | 19.1 | 51.3 | 74.0 | -22.7 | Peak | Horizontal |
| | 12296.5 | 31.5 | 20.5 | 52.0 | 74.0 | -22.0 | Peak | Horizontal |
| * | 9704.0 | 33.5 | 14.8 | 48.3 | 68.2 | -19.9 | Peak | Vertical |
| * | 9967.5 | 34.1 | 15.0 | 49.1 | 68.2 | -19.1 | Peak | Vertical |
| | 11480.5 | 30.6 | 19.9 | 50.5 | 74.0 | -23.5 | Peak | Vertical |
| | 12084.0 | 31.6 | 20.1 | 51.7 | 74.0 | -22.3 | Peak | Vertical |

Note 1: "*" is not in restricted band, its limit is -27dBm/MHz. At a distance of 3 meters, the field strength limit in dBμV/m can be determined by adding a "conversion" factor of 95.2dB to the EIRP limit of -27dBm/MHz to obtain the limit for out of band spurious emissions.

Note 2: Measure Level (dBμV/m) = Reading Level (dBμV) + Factor (dB)

Factor (dB) = Cable Loss (dB) + Antenna Factor (dB/m) - Pre_Amplifier Gain (dB)

| | | | |
|---------------|---|-------------------|-------------------------|
| Product | OmniAccess Stellar | Temperature | 22 ~ 26°C |
| Test Engineer | David Lv | Relative Humidity | 44 ~ 57 % |
| Test Site | AC1 | Test Date | 2019/11/26 ~ 2020/02/24 |
| Test Mode | 802.11ax-HE20 - Ant 0 + 1 + 2 + 3 (Beamforming Mode) | Test Channel | 149 |
| Model No. | OAW-AP1361D | | |
| Remark: | 1. Average measurement was not performed if peak level lower than average limit. 2. Other frequency was 20dB below limit line within 1-18GHz, there is not show in the report. | | |

| Mark | Frequency (MHz) | Reading Level (dBμV) | Factor (dB) | Measure Level (dBμV/m) | Limit (dBμV/m) | Margin (dB) | Detector | Polarization |
|------|-----------------|----------------------|-------------|------------------------|----------------|-------------|----------|--------------|
| * | 9704.0 | 33.5 | 14.8 | 48.3 | 68.2 | -19.9 | Peak | Horizontal |
| * | 10273.5 | 33.3 | 16.1 | 49.4 | 68.2 | -18.8 | Peak | Horizontal |
| | 11489.0 | 31.4 | 19.7 | 51.1 | 74.0 | -22.9 | Peak | Horizontal |
| | 11956.5 | 30.8 | 20.0 | 50.8 | 74.0 | -23.2 | Peak | Horizontal |
| * | 9687.0 | 33.6 | 14.4 | 48.0 | 68.2 | -20.2 | Peak | Vertical |
| * | 10426.5 | 33.3 | 16.5 | 49.8 | 68.2 | -18.4 | Peak | Vertical |
| | 11548.5 | 31.6 | 19.9 | 51.5 | 74.0 | -22.5 | Peak | Vertical |
| | 12075.5 | 32.2 | 19.9 | 52.1 | 74.0 | -21.9 | Peak | Vertical |

Note 1: "*" is not in restricted band, its limit is -27dBm/MHz. At a distance of 3 meters, the field strength limit in dBμV/m can be determined by adding a "conversion" factor of 95.2dB to the EIRP limit of -27dBm/MHz to obtain the limit for out of band spurious emissions.

Note 2: Measure Level (dBμV/m) = Reading Level (dBμV) + Factor (dB)

Factor (dB) = Cable Loss (dB) + Antenna Factor (dB/m) - Pre_Amplifier Gain (dB)

| | | | |
|---------------|---|-------------------|-------------------------|
| Product | OmniAccess Stellar | Temperature | 22 ~ 26°C |
| Test Engineer | David Lv | Relative Humidity | 44 ~ 57 % |
| Test Site | AC1 | Test Date | 2019/11/26 ~ 2020/02/24 |
| Test Mode | 802.11ax-HE20 - Ant 0 + 1 + 2 + 3 (Beamforming Mode) | Test Channel | 157 |
| Model No. | OAW-AP1361D | | |
| Remark: | 1. Average measurement was not performed if peak level lower than average limit. 2. Other frequency was 20dB below limit line within 1-18GHz, there is not show in the report. | | |

| Mark | Frequency (MHz) | Reading Level (dBμV) | Factor (dB) | Measure Level (dBμV/m) | Limit (dBμV/m) | Margin (dB) | Detector | Polarization |
|------|-----------------|----------------------|-------------|------------------------|----------------|-------------|----------|--------------|
| * | 9729.5 | 34.9 | 14.6 | 49.5 | 68.2 | -18.7 | Peak | Horizontal |
| * | 10282.0 | 32.8 | 16.1 | 48.9 | 68.2 | -19.3 | Peak | Horizontal |
| | 11242.5 | 32.5 | 18.5 | 51.0 | 74.0 | -23.0 | Peak | Horizontal |
| | 12092.5 | 31.5 | 20.1 | 51.6 | 74.0 | -22.4 | Peak | Horizontal |
| * | 9627.5 | 33.9 | 14.4 | 48.3 | 68.2 | -19.9 | Peak | Vertical |
| * | 9967.5 | 33.3 | 15.0 | 48.3 | 68.2 | -19.9 | Peak | Vertical |
| | 10622.0 | 33.5 | 17.3 | 50.8 | 74.0 | -23.2 | Peak | Vertical |
| | 11540.0 | 31.3 | 20.3 | 51.6 | 74.0 | -22.4 | Peak | Vertical |

Note 1: "*" is not in restricted band, its limit is -27dBm/MHz. At a distance of 3 meters, the field strength limit in dBμV/m can be determined by adding a "conversion" factor of 95.2dB to the EIRP limit of -27dBm/MHz to obtain the limit for out of band spurious emissions.

Note 2: Measure Level (dBμV/m) = Reading Level (dBμV) + Factor (dB)

Factor (dB) = Cable Loss (dB) + Antenna Factor (dB/m) - Pre_Amplifier Gain (dB)

| | | | |
|---------------|---|-------------------|-------------------------|
| Product | OmniAccess Stellar | Temperature | 22 ~ 26°C |
| Test Engineer | David Lv | Relative Humidity | 44 ~ 57 % |
| Test Site | AC1 | Test Date | 2019/11/26 ~ 2020/02/24 |
| Test Mode | 802.11ax-HE20 - Ant 0 + 1 + 2 + 3 (Beamforming Mode) | Test Channel | 165 |
| Model No. | OAW-AP1361D | | |
| Remark: | 1. Average measurement was not performed if peak level lower than average limit. 2. Other frequency was 20dB below limit line within 1-18GHz, there is not show in the report. | | |

| Mark | Frequency (MHz) | Reading Level (dBμV) | Factor (dB) | Measure Level (dBμV/m) | Limit (dBμV/m) | Margin (dB) | Detector | Polarization |
|------|-----------------|----------------------|-------------|------------------------|----------------|-------------|----------|--------------|
| * | 9738.0 | 32.9 | 14.7 | 47.6 | 68.2 | -20.6 | Peak | Horizontal |
| * | 10129.0 | 33.3 | 15.0 | 48.3 | 68.2 | -19.9 | Peak | Horizontal |
| | 10928.0 | 33.4 | 17.7 | 51.1 | 74.0 | -22.9 | Peak | Horizontal |
| | 11684.5 | 30.8 | 19.8 | 50.6 | 74.0 | -23.4 | Peak | Horizontal |
| * | 9738.0 | 32.9 | 14.7 | 47.6 | 68.2 | -20.6 | Peak | Vertical |
| * | 9942.0 | 31.8 | 15.0 | 46.8 | 68.2 | -21.4 | Peak | Vertical |
| | 10945.0 | 32.5 | 18.0 | 50.5 | 74.0 | -23.5 | Peak | Vertical |
| | 11591.0 | 30.7 | 20.1 | 50.8 | 74.0 | -23.2 | Peak | Vertical |

Note 1: "*" is not in restricted band, its limit is -27dBm/MHz. At a distance of 3 meters, the field strength limit in dBμV/m can be determined by adding a "conversion" factor of 95.2dB to the EIRP limit of -27dBm/MHz to obtain the limit for out of band spurious emissions.

Note 2: Measure Level (dBμV/m) = Reading Level (dBμV) + Factor (dB)

Factor (dB) = Cable Loss (dB) + Antenna Factor (dB/m) - Pre_Amplifier Gain (dB)

| | | | |
|---------------|---|-------------------|-------------------------|
| Product | OmniAccess Stellar | Temperature | 22 ~ 26°C |
| Test Engineer | David Lv | Relative Humidity | 44 ~ 57 % |
| Test Site | AC1 | Test Date | 2019/11/26 ~ 2020/02/24 |
| Test Mode | 802.11ax-HE40 - Ant 0 + 1 + 2 + 3 (Beamforming Mode) | Test Channel | 38 |
| Model No. | OAW-AP1361D | | |
| Remark: | 1. Average measurement was not performed if peak level lower than average limit. 2. Other frequency was 20dB below limit line within 1-18GHz, there is not show in the report. | | |

| Mark | Frequency (MHz) | Reading Level (dBμV) | Factor (dB) | Measure Level (dBμV/m) | Limit (dBμV/m) | Margin (dB) | Detector | Polarization |
|------|-----------------|----------------------|-------------|------------------------|----------------|-------------|----------|--------------|
| * | 9636.0 | 32.4 | 14.4 | 46.8 | 68.2 | -21.4 | Peak | Horizontal |
| * | 10248.0 | 31.7 | 16.2 | 47.9 | 68.2 | -20.3 | Peak | Horizontal |
| | 11276.5 | 31.7 | 18.9 | 50.6 | 74.0 | -23.4 | Peak | Horizontal |
| | 11591.0 | 32.0 | 20.1 | 52.1 | 74.0 | -21.9 | Peak | Horizontal |
| * | 9704.0 | 33.2 | 14.8 | 48.0 | 68.2 | -20.2 | Peak | Vertical |
| * | 10248.0 | 33.1 | 16.2 | 49.3 | 68.2 | -18.9 | Peak | Vertical |
| | 11438.0 | 31.5 | 19.4 | 50.9 | 74.0 | -23.1 | Peak | Vertical |
| | 12152.0 | 31.0 | 20.4 | 51.4 | 74.0 | -22.6 | Peak | Vertical |

Note 1: "*" is not in restricted band, its limit is -27dBm/MHz. At a distance of 3 meters, the field strength limit in dBμV/m can be determined by adding a "conversion" factor of 95.2dB to the EIRP limit of -27dBm/MHz to obtain the limit for out of band spurious emissions.

Note 2: Measure Level (dBμV/m) = Reading Level (dBμV) + Factor (dB)

Factor (dB) = Cable Loss (dB) + Antenna Factor (dB/m) - Pre_Amplifier Gain (dB)

| | | | |
|---------------|---|-------------------|-------------------------|
| Product | OmniAccess Stellar | Temperature | 22 ~ 26°C |
| Test Engineer | David Lv | Relative Humidity | 44 ~ 57 % |
| Test Site | AC1 | Test Date | 2019/11/26 ~ 2020/02/24 |
| Test Mode | 802.11ax-HE40 - Ant 0 + 1 + 2 + 3 (Beamforming Mode) | Test Channel | 46 |
| Model No. | OAW-AP1361D | | |
| Remark: | 1. Average measurement was not performed if peak level lower than average limit. 2. Other frequency was 20dB below limit line within 1-18GHz, there is not show in the report. | | |

| Mark | Frequency (MHz) | Reading Level (dBμV) | Factor (dB) | Measure Level (dBμV/m) | Limit (dBμV/m) | Margin (dB) | Detector | Polarization |
|------|-----------------|----------------------|-------------|------------------------|----------------|-------------|----------|--------------|
| * | 9738.0 | 33.9 | 14.7 | 48.6 | 68.2 | -19.6 | Peak | Horizontal |
| * | 10324.5 | 33.3 | 16.5 | 49.8 | 68.2 | -18.4 | Peak | Horizontal |
| | 10928.0 | 32.1 | 17.7 | 49.8 | 74.0 | -24.2 | Peak | Horizontal |
| | 11769.5 | 31.3 | 20.1 | 51.4 | 74.0 | -22.6 | Peak | Horizontal |
| * | 9712.5 | 33.3 | 14.7 | 48.0 | 68.2 | -20.2 | Peak | Vertical |
| * | 10401.0 | 32.9 | 16.5 | 49.4 | 68.2 | -18.8 | Peak | Vertical |
| | 10987.5 | 32.2 | 18.3 | 50.5 | 74.0 | -23.5 | Peak | Vertical |
| | 12092.5 | 31.5 | 20.1 | 51.6 | 74.0 | -22.4 | Peak | Vertical |

Note 1: "*" is not in restricted band, its limit is -27dBm/MHz. At a distance of 3 meters, the field strength limit in dBμV/m can be determined by adding a "conversion" factor of 95.2dB to the EIRP limit of -27dBm/MHz to obtain the limit for out of band spurious emissions.

Note 2: Measure Level (dBμV/m) = Reading Level (dBμV) + Factor (dB)

Factor (dB) = Cable Loss (dB) + Antenna Factor (dB/m) - Pre_Amplifier Gain (dB)

| | | | |
|---------------|---|-------------------|-------------------------|
| Product | OmniAccess Stellar | Temperature | 22 ~ 26°C |
| Test Engineer | David Lv | Relative Humidity | 44 ~ 57 % |
| Test Site | AC1 | Test Date | 2019/11/26 ~ 2020/02/24 |
| Test Mode | 802.11ax-HE40 - Ant 0 + 1 + 2 + 3 (Beamforming Mode) | Test Channel | 151 |
| Model No. | OAW-AP1361D | | |
| Remark: | 1. Average measurement was not performed if peak level lower than average limit. 2. Other frequency was 20dB below limit line within 1-18GHz, there is not show in the report. | | |

| Mark | Frequency (MHz) | Reading Level (dBμV) | Factor (dB) | Measure Level (dBμV/m) | Limit (dBμV/m) | Margin (dB) | Detector | Polarization |
|------|-----------------|----------------------|-------------|------------------------|----------------|-------------|----------|--------------|
| * | 9976.0 | 33.8 | 15.1 | 48.9 | 68.2 | -19.3 | Peak | Horizontal |
| * | 10265.0 | 31.8 | 16.2 | 48.0 | 68.2 | -20.2 | Peak | Horizontal |
| | 10996.0 | 31.4 | 18.4 | 49.8 | 74.0 | -24.2 | Peak | Horizontal |
| | 11922.5 | 31.1 | 20.0 | 51.1 | 74.0 | -22.9 | Peak | Horizontal |
| * | 9891.0 | 33.6 | 15.4 | 49.0 | 68.2 | -19.2 | Peak | Vertical |
| * | 10214.0 | 32.6 | 15.9 | 48.5 | 68.2 | -19.7 | Peak | Vertical |
| | 11489.0 | 31.1 | 19.7 | 50.8 | 74.0 | -23.2 | Peak | Vertical |
| | 12271.0 | 30.8 | 20.6 | 51.4 | 74.0 | -22.6 | Peak | Vertical |

Note 1: "*" is not in restricted band, its limit is -27dBm/MHz. At a distance of 3 meters, the field strength limit in dBμV/m can be determined by adding a "conversion" factor of 95.2dB to the EIRP limit of -27dBm/MHz to obtain the limit for out of band spurious emissions.

Note 2: Measure Level (dBμV/m) = Reading Level (dBμV) + Factor (dB)

Factor (dB) = Cable Loss (dB) + Antenna Factor (dB/m) - Pre_Amplifier Gain (dB)

| | | | |
|---------------|---|-------------------|-------------------------|
| Product | OmniAccess Stellar | Temperature | 22 ~ 26°C |
| Test Engineer | David Lv | Relative Humidity | 44 ~ 57 % |
| Test Site | AC1 | Test Date | 2019/11/26 ~ 2020/02/24 |
| Test Mode | 802.11ax-HE40 - Ant 0 + 1 + 2 + 3 (Beamforming Mode) | Test Channel | 159 |
| Model No. | OAW-AP1361D | | |
| Remark: | 1. Average measurement was not performed if peak level lower than average limit. 2. Other frequency was 20dB below limit line within 1-18GHz, there is not show in the report. | | |

| Mark | Frequency (MHz) | Reading Level (dBμV) | Factor (dB) | Measure Level (dBμV/m) | Limit (dBμV/m) | Margin (dB) | Detector | Polarization |
|------|-----------------|----------------------|-------------|------------------------|----------------|-------------|----------|--------------|
| * | 9678.5 | 32.1 | 14.4 | 46.5 | 68.2 | -21.7 | Peak | Horizontal |
| * | 10350.0 | 32.8 | 16.4 | 49.2 | 68.2 | -19.0 | Peak | Horizontal |
| | 11582.5 | 32.0 | 19.8 | 51.8 | 74.0 | -22.2 | Peak | Horizontal |
| | 11914.0 | 31.8 | 20.3 | 52.1 | 74.0 | -21.9 | Peak | Horizontal |
| * | 9636.0 | 33.2 | 14.4 | 47.6 | 68.2 | -20.6 | Peak | Vertical |
| * | 10154.5 | 33.8 | 15.1 | 48.9 | 68.2 | -19.3 | Peak | Vertical |
| | 11650.5 | 32.0 | 19.6 | 51.6 | 74.0 | -22.4 | Peak | Vertical |
| | 12220.0 | 29.9 | 20.8 | 50.7 | 74.0 | -23.3 | Peak | Vertical |

Note 1: "*" is not in restricted band, its limit is -27dBm/MHz. At a distance of 3 meters, the field strength limit in dBμV/m can be determined by adding a "conversion" factor of 95.2dB to the EIRP limit of -27dBm/MHz to obtain the limit for out of band spurious emissions.

Note 2: Measure Level (dBμV/m) = Reading Level (dBμV) + Factor (dB)

Factor (dB) = Cable Loss (dB) + Antenna Factor (dB/m) - Pre_Amplifier Gain (dB)

| | | | |
|---------------|---|-------------------|-------------------------|
| Product | OmniAccess Stellar | Temperature | 22 ~ 26°C |
| Test Engineer | David Lv | Relative Humidity | 44 ~ 57 % |
| Test Site | AC1 | Test Date | 2019/11/26 ~ 2020/02/24 |
| Test Mode | 802.11ax-HE80 - Ant 0 + 1 + 2 + 3 (Beamforming Mode) | Test Channel | 42 |
| Model No. | OAW-AP1361D | | |
| Remark: | 1. Average measurement was not performed if peak level lower than average limit. 2. Other frequency was 20dB below limit line within 1-18GHz, there is not show in the report. | | |

| Mark | Frequency (MHz) | Reading Level (dBμV) | Factor (dB) | Measure Level (dBμV/m) | Limit (dBμV/m) | Margin (dB) | Detector | Polarization |
|------|-----------------|----------------------|-------------|------------------------|----------------|-------------|----------|--------------|
| * | 9712.5 | 33.0 | 14.7 | 47.7 | 68.2 | -20.5 | Peak | Horizontal |
| * | 10358.5 | 32.7 | 16.5 | 49.2 | 68.2 | -19.0 | Peak | Horizontal |
| | 11225.5 | 31.6 | 18.8 | 50.4 | 74.0 | -23.6 | Peak | Horizontal |
| | 11650.5 | 31.9 | 19.6 | 51.5 | 74.0 | -22.5 | Peak | Horizontal |
| * | 9729.5 | 34.0 | 14.6 | 48.6 | 68.2 | -19.6 | Peak | Vertical |
| * | 10256.5 | 33.0 | 16.2 | 49.2 | 68.2 | -19.0 | Peak | Vertical |
| | 11174.5 | 32.0 | 18.7 | 50.7 | 74.0 | -23.3 | Peak | Vertical |
| | 11718.5 | 31.1 | 20.0 | 51.1 | 74.0 | -22.9 | Peak | Vertical |

Note 1: "*" is not in restricted band, its limit is -27dBm/MHz. At a distance of 3 meters, the field strength limit in dBμV/m can be determined by adding a "conversion" factor of 95.2dB to the EIRP limit of -27dBm/MHz to obtain the limit for out of band spurious emissions.

Note 2: Measure Level (dBμV/m) = Reading Level (dBμV) + Factor (dB)

Factor (dB) = Cable Loss (dB) + Antenna Factor (dB/m) - Pre_Amplifier Gain (dB)

| | | | |
|---------------|---|-------------------|-------------------------|
| Product | OmniAccess Stellar | Temperature | 22 ~ 26°C |
| Test Engineer | David Lv | Relative Humidity | 44 ~ 57 % |
| Test Site | AC1 | Test Date | 2019/11/26 ~ 2020/02/24 |
| Test Mode | 802.11ax-HE80 - Ant 0 + 1 + 2 + 3 (Beamforming Mode) | Test Channel | 155 |
| Model No. | OAW-AP1361D | | |
| Remark: | 1. Average measurement was not performed if peak level lower than average limit. 2. Other frequency was 20dB below limit line within 1-18GHz, there is not show in the report. | | |

| Mark | Frequency (MHz) | Reading Level (dBμV) | Factor (dB) | Measure Level (dBμV/m) | Limit (dBμV/m) | Margin (dB) | Detector | Polarization |
|------|-----------------|----------------------|-------------|------------------------|----------------|-------------|----------|--------------|
| * | 9976.0 | 32.9 | 15.1 | 48.0 | 68.2 | -20.2 | Peak | Horizontal |
| * | 10248.0 | 33.5 | 16.2 | 49.7 | 68.2 | -18.5 | Peak | Horizontal |
| | 11038.5 | 31.9 | 18.4 | 50.3 | 74.0 | -23.7 | Peak | Horizontal |
| | 11684.5 | 31.8 | 19.8 | 51.6 | 74.0 | -22.4 | Peak | Horizontal |
| * | 9636.0 | 32.1 | 14.4 | 46.5 | 68.2 | -21.7 | Peak | Vertical |
| * | 10316.0 | 32.1 | 16.6 | 48.7 | 68.2 | -19.5 | Peak | Vertical |
| | 10979.0 | 32.2 | 18.1 | 50.3 | 74.0 | -23.7 | Peak | Vertical |
| | 11480.5 | 31.2 | 19.9 | 51.1 | 74.0 | -22.9 | Peak | Vertical |

Note 1: "*" is not in restricted band, its limit is -27dBm/MHz. At a distance of 3 meters, the field strength limit in dBμV/m can be determined by adding a "conversion" factor of 95.2dB to the EIRP limit of -27dBm/MHz to obtain the limit for out of band spurious emissions.

Note 2: Measure Level (dBμV/m) = Reading Level (dBμV) + Factor (dB)

Factor (dB) = Cable Loss (dB) + Antenna Factor (dB/m) - Pre_Amplifier Gain (dB)

| | | | |
|---------------|---|-------------------|-------------------------|
| Product | OmniAccess Stellar | Temperature | 22 ~ 26°C |
| Test Engineer | David Lv | Relative Humidity | 44 ~ 57 % |
| Test Site | AC1 | Test Date | 2019/11/26 ~ 2020/02/24 |
| Test Mode | 802.11a | Test Channel | 36 |
| Model No. | OAW-AP1361D – Scan Antenna | | |
| Remark: | 1. Average measurement was not performed if peak level lower than average limit. 2. Other frequency was 20dB below limit line within 1-18GHz, there is not show in the report. | | |

| Mark | Frequency (MHz) | Reading Level (dBμV) | Factor (dB) | Measure Level (dBμV/m) | Limit (dBμV/m) | Margin (dB) | Detector | Polarization |
|------|-----------------|----------------------|-------------|------------------------|----------------|-------------|----------|--------------|
| * | 7188.0 | 32.6 | 11.9 | 44.5 | 68.2 | -23.7 | Peak | Horizontal |
| * | 7927.5 | 33.2 | 12.2 | 45.4 | 68.2 | -22.8 | Peak | Horizontal |
| | 8199.5 | 30.4 | 12.3 | 42.7 | 74.0 | -31.3 | Peak | Horizontal |
| | 9109.0 | 29.9 | 14.6 | 44.5 | 74.0 | -29.5 | Peak | Horizontal |
| * | 7171.0 | 34.0 | 11.8 | 45.8 | 68.2 | -22.4 | Peak | Vertical |
| * | 7842.5 | 32.1 | 11.9 | 44.0 | 68.2 | -24.2 | Peak | Vertical |
| | 8046.5 | 31.9 | 12.6 | 44.5 | 74.0 | -29.5 | Peak | Vertical |
| | 9134.5 | 30.8 | 14.7 | 45.5 | 74.0 | -28.5 | Peak | Vertical |

Note 1: "*" is not in restricted band, its limit is -27dBm/MHz. At a distance of 3 meters, the field strength limit in dBμV/m can be determined by adding a "conversion" factor of 95.2dB to the EIRP limit of -27dBm/MHz to obtain the limit for out of band spurious emissions.

Note 2: Measure Level (dBμV/m) = Reading Level (dBμV) + Factor (dB)

Factor (dB) = Cable Loss (dB) + Antenna Factor (dB/m) - Pre_Amplifier Gain (dB)

| | | | |
|---------------|---|-------------------|-------------------------|
| Product | OmniAccess Stellar | Temperature | 22 ~ 26°C |
| Test Engineer | David Lv | Relative Humidity | 44 ~ 57 % |
| Test Site | AC1 | Test Date | 2019/11/26 ~ 2020/02/24 |
| Test Mode | 802.11a | Test Channel | 44 |
| Model No. | OAW-AP1361D – Scan Antenna | | |
| Remark: | 1. Average measurement was not performed if peak level lower than average limit. 2. Other frequency was 20dB below limit line within 1-18GHz, there is not show in the report. | | |

| Mark | Frequency (MHz) | Reading Level (dBμV) | Factor (dB) | Measure Level (dBμV/m) | Limit (dBμV/m) | Margin (dB) | Detector | Polarization |
|------|-----------------|----------------------|-------------|------------------------|----------------|-------------|----------|--------------|
| * | 7026.5 | 32.8 | 10.8 | 43.6 | 68.2 | -24.6 | Peak | Horizontal |
| * | 7817.0 | 33.6 | 11.9 | 45.5 | 68.2 | -22.7 | Peak | Horizontal |
| | 8420.5 | 30.6 | 12.4 | 43.0 | 74.0 | -31.0 | Peak | Horizontal |
| | 9330.0 | 29.0 | 14.7 | 43.7 | 74.0 | -30.3 | Peak | Horizontal |
| * | 7188.0 | 33.0 | 11.9 | 44.9 | 68.2 | -23.3 | Peak | Vertical |
| * | 7842.5 | 33.9 | 11.9 | 45.8 | 68.2 | -22.4 | Peak | Vertical |
| | 8437.5 | 32.8 | 12.4 | 45.2 | 74.0 | -28.8 | Peak | Vertical |
| | 9134.5 | 30.7 | 14.7 | 45.4 | 74.0 | -28.6 | Peak | Vertical |

Note 1: "*" is not in restricted band, its limit is -27dBm/MHz. At a distance of 3 meters, the field strength limit in dBμV/m can be determined by adding a "conversion" factor of 95.2dB to the EIRP limit of -27dBm/MHz to obtain the limit for out of band spurious emissions.

Note 2: Measure Level (dBμV/m) = Reading Level (dBμV) + Factor (dB)

Factor (dB) = Cable Loss (dB) + Antenna Factor (dB/m) - Pre_Amplifier Gain (dB)

| | | | |
|---------------|---|-------------------|-------------------------|
| Product | OmniAccess Stellar | Temperature | 22 ~ 26°C |
| Test Engineer | David Lv | Relative Humidity | 44 ~ 57 % |
| Test Site | AC1 | Test Date | 2019/11/26 ~ 2020/02/24 |
| Test Mode | 802.11a | Test Channel | 48 |
| Model No. | OAW-AP1361D – Scan Antenna | | |
| Remark: | 1. Average measurement was not performed if peak level lower than average limit. 2. Other frequency was 20dB below limit line within 1-18GHz, there is not show in the report. | | |

| Mark | Frequency (MHz) | Reading Level (dBμV) | Factor (dB) | Measure Level (dBμV/m) | Limit (dBμV/m) | Margin (dB) | Detector | Polarization |
|------|-----------------|----------------------|-------------|------------------------|----------------|-------------|----------|--------------|
| * | 7205.0 | 32.2 | 12.2 | 44.4 | 68.2 | -23.8 | Peak | Horizontal |
| * | 7927.5 | 32.1 | 12.2 | 44.3 | 68.2 | -23.9 | Peak | Horizontal |
| | 8284.5 | 31.3 | 12.2 | 43.5 | 74.0 | -30.5 | Peak | Horizontal |
| | 9440.5 | 32.4 | 14.9 | 47.3 | 74.0 | -26.7 | Peak | Horizontal |
| * | 7171.0 | 33.1 | 11.8 | 44.9 | 68.2 | -23.3 | Peak | Vertical |
| * | 7978.5 | 31.9 | 12.4 | 44.3 | 68.2 | -23.9 | Peak | Vertical |
| | 8386.5 | 31.8 | 12.3 | 44.1 | 74.0 | -29.9 | Peak | Vertical |
| | 9143.0 | 29.4 | 14.7 | 44.1 | 74.0 | -29.9 | Peak | Vertical |

Note 1: "*" is not in restricted band, its limit is -27dBm/MHz. At a distance of 3 meters, the field strength limit in dBμV/m can be determined by adding a "conversion" factor of 95.2dB to the EIRP limit of -27dBm/MHz to obtain the limit for out of band spurious emissions.

Note 2: Measure Level (dBμV/m) = Reading Level (dBμV) + Factor (dB)

Factor (dB) = Cable Loss (dB) + Antenna Factor (dB/m) - Pre_Amplifier Gain (dB)

| | | | |
|---------------|---|-------------------|-------------------------|
| Product | OmniAccess Stellar | Temperature | 22 ~ 26°C |
| Test Engineer | David Lv | Relative Humidity | 44 ~ 57 % |
| Test Site | AC1 | Test Date | 2019/11/26 ~ 2020/02/24 |
| Test Mode | 802.11a | Test Channel | 149 |
| Model No. | OAW-AP1361D – Scan Antenna | | |
| Remark: | 1. Average measurement was not performed if peak level lower than average limit. 2. Other frequency was 20dB below limit line within 1-18GHz, there is not show in the report. | | |

| Mark | Frequency (MHz) | Reading Level (dBμV) | Factor (dB) | Measure Level (dBμV/m) | Limit (dBμV/m) | Margin (dB) | Detector | Polarization |
|------|-----------------|----------------------|-------------|------------------------|----------------|-------------|----------|--------------|
| * | 7094.5 | 32.1 | 11.8 | 43.9 | 68.2 | -24.3 | Peak | Horizontal |
| * | 7842.5 | 32.0 | 11.9 | 43.9 | 68.2 | -24.3 | Peak | Horizontal |
| | 8242.0 | 29.2 | 12.5 | 41.7 | 74.0 | -32.3 | Peak | Horizontal |
| | 9160.0 | 28.3 | 14.6 | 42.9 | 74.0 | -31.1 | Peak | Horizontal |
| * | 7179.5 | 32.5 | 11.9 | 44.4 | 68.2 | -23.8 | Peak | Vertical |
| * | 7944.5 | 33.4 | 12.2 | 45.6 | 68.2 | -22.6 | Peak | Vertical |
| | 8276.0 | 31.0 | 12.3 | 43.3 | 74.0 | -30.7 | Peak | Vertical |
| | 9092.0 | 29.7 | 14.5 | 44.2 | 74.0 | -29.8 | Peak | Vertical |

Note 1: "*" is not in restricted band, its limit is -27dBm/MHz. At a distance of 3 meters, the field strength limit in dBμV/m can be determined by adding a "conversion" factor of 95.2dB to the EIRP limit of -27dBm/MHz to obtain the limit for out of band spurious emissions.

Note 2: Measure Level (dBμV/m) = Reading Level (dBμV) + Factor (dB)

Factor (dB) = Cable Loss (dB) + Antenna Factor (dB/m) - Pre_Amplifier Gain (dB)

| | | | |
|---------------|---|-------------------|-------------------------|
| Product | OmniAccess Stellar | Temperature | 22 ~ 26°C |
| Test Engineer | David Lv | Relative Humidity | 44 ~ 57 % |
| Test Site | AC1 | Test Date | 2019/11/26 ~ 2020/02/24 |
| Test Mode | 802.11a | Test Channel | 157 |
| Model No. | OAW-AP1361D – Scan Antenna | | |
| Remark: | 1. Average measurement was not performed if peak level lower than average limit. 2. Other frequency was 20dB below limit line within 1-18GHz, there is not show in the report. | | |

| Mark | Frequency (MHz) | Reading Level (dBμV) | Factor (dB) | Measure Level (dBμV/m) | Limit (dBμV/m) | Margin (dB) | Detector | Polarization |
|------|-----------------|----------------------|-------------|------------------------|----------------|-------------|----------|--------------|
| * | 7171.0 | 32.9 | 11.8 | 44.7 | 68.2 | -23.5 | Peak | Horizontal |
| * | 7842.5 | 32.4 | 11.9 | 44.3 | 68.2 | -23.9 | Peak | Horizontal |
| | 8233.5 | 31.7 | 12.4 | 44.1 | 74.0 | -29.9 | Peak | Horizontal |
| | 9092.0 | 30.5 | 14.5 | 45.0 | 74.0 | -29.0 | Peak | Horizontal |
| * | 7171.0 | 32.4 | 11.8 | 44.2 | 68.2 | -24.0 | Peak | Vertical |
| * | 7842.5 | 33.6 | 11.9 | 45.5 | 68.2 | -22.7 | Peak | Vertical |
| | 8420.5 | 32.1 | 12.4 | 44.5 | 74.0 | -29.5 | Peak | Vertical |
| | 9015.5 | 29.5 | 14.5 | 44.0 | 74.0 | -30.0 | Peak | Vertical |

Note 1: "*" is not in restricted band, its limit is -27dBm/MHz. At a distance of 3 meters, the field strength limit in dBμV/m can be determined by adding a "conversion" factor of 95.2dB to the EIRP limit of -27dBm/MHz to obtain the limit for out of band spurious emissions.

Note 2: Measure Level (dBμV/m) = Reading Level (dBμV) + Factor (dB)

Factor (dB) = Cable Loss (dB) + Antenna Factor (dB/m) - Pre_Amplifier Gain (dB)

| | | | |
|---------------|---|-------------------|-------------------------|
| Product | OmniAccess Stellar | Temperature | 22 ~ 26°C |
| Test Engineer | David Lv | Relative Humidity | 44 ~ 57 % |
| Test Site | AC1 | Test Date | 2019/11/26 ~ 2020/02/24 |
| Test Mode | 802.11a | Test Channel | 165 |
| Model No. | OAW-AP1361D – Scan Antenna | | |
| Remark: | 1. Average measurement was not performed if peak level lower than average limit. 2. Other frequency was 20dB below limit line within 1-18GHz, there is not show in the report. | | |

| Mark | Frequency (MHz) | Reading Level (dBμV) | Factor (dB) | Measure Level (dBμV/m) | Limit (dBμV/m) | Margin (dB) | Detector | Polarization |
|------|-----------------|----------------------|-------------|------------------------|----------------|-------------|----------|--------------|
| * | 7145.5 | 32.6 | 11.6 | 44.2 | 68.2 | -24.0 | Peak | Horizontal |
| * | 7842.5 | 32.9 | 11.9 | 44.8 | 68.2 | -23.4 | Peak | Horizontal |
| | 8403.5 | 32.6 | 12.4 | 45.0 | 74.0 | -29.0 | Peak | Horizontal |
| | 9049.5 | 30.6 | 14.2 | 44.8 | 74.0 | -29.2 | Peak | Horizontal |
| * | 6958.5 | 32.4 | 10.6 | 43.0 | 68.2 | -25.2 | Peak | Vertical |
| * | 7936.0 | 32.7 | 12.2 | 44.9 | 68.2 | -23.3 | Peak | Vertical |
| | 8386.5 | 31.9 | 12.3 | 44.2 | 74.0 | -29.8 | Peak | Vertical |
| | 9109.0 | 29.2 | 14.6 | 43.8 | 74.0 | -30.2 | Peak | Vertical |

Note 1: "*" is not in restricted band, its limit is -27dBm/MHz. At a distance of 3 meters, the field strength limit in dBμV/m can be determined by adding a "conversion" factor of 95.2dB to the EIRP limit of -27dBm/MHz to obtain the limit for out of band spurious emissions.

Note 2: Measure Level (dBμV/m) = Reading Level (dBμV) + Factor (dB)

Factor (dB) = Cable Loss (dB) + Antenna Factor (dB/m) - Pre_Amplifier Gain (dB)

| | | | |
|---------------|---|-------------------|-------------------------|
| Product | OmniAccess Stellar | Temperature | 22 ~ 26°C |
| Test Engineer | David Lv | Relative Humidity | 44 ~ 57 % |
| Test Site | AC1 | Test Date | 2019/11/26 ~ 2020/02/24 |
| Test Mode | 802.11a - Ant 0 + 1 + 2 + 3 (CDD Mode) | Test Channel | 36 |
| Model No. | OAW-AP1362 | | |
| Remark: | 1. Average measurement was not performed if peak level lower than average limit. 2. Other frequency was 20dB below limit line within 1-18GHz, there is not show in the report. | | |

| Mark | Frequency (MHz) | Reading Level (dBμV) | Factor (dB) | Measure Level (dBμV/m) | Limit (dBμV/m) | Margin (dB) | Detector | Polarization |
|------|-----------------|----------------------|-------------|------------------------|----------------|-------------|----------|--------------|
| * | 9610.5 | 32.4 | 14.3 | 46.7 | 68.2 | -21.5 | Peak | Horizontal |
| * | 10282.0 | 31.3 | 16.1 | 47.4 | 68.2 | -20.8 | Peak | Horizontal |
| | 11004.5 | 30.9 | 18.2 | 49.1 | 74.0 | -24.9 | Peak | Horizontal |
| | 11540.0 | 29.5 | 20.3 | 49.8 | 74.0 | -24.2 | Peak | Horizontal |
| * | 9602.0 | 31.9 | 14.2 | 46.1 | 68.2 | -22.1 | Peak | Vertical |
| * | 10239.5 | 31.3 | 15.9 | 47.2 | 68.2 | -21.0 | Peak | Vertical |
| | 10987.5 | 30.6 | 18.3 | 48.9 | 74.0 | -25.1 | Peak | Vertical |
| | 11684.5 | 30.8 | 19.8 | 50.6 | 74.0 | -23.4 | Peak | Vertical |

Note 1: "*" is not in restricted band, its limit is -27dBm/MHz. At a distance of 3 meters, the field strength limit in dBμV/m can be determined by adding a "conversion" factor of 95.2dB to the EIRP limit of -27dBm/MHz to obtain the limit for out of band spurious emissions.

Note 2: Measure Level (dBμV/m) = Reading Level (dBμV) + Factor (dB)

Factor (dB) = Cable Loss (dB) + Antenna Factor (dB/m) - Pre_Amplifier Gain (dB)

| | | | |
|---------------|---|-------------------|-------------------------|
| Product | OmniAccess Stellar | Temperature | 22 ~ 26°C |
| Test Engineer | David Lv | Relative Humidity | 44 ~ 57 % |
| Test Site | AC1 | Test Date | 2019/11/26 ~ 2020/02/24 |
| Test Mode | 802.11a - Ant 0 + 1 + 2 + 3 (CDD Mode) | Test Channel | 44 |
| Model No. | OAW-AP1362 | | |
| Remark: | 1. Average measurement was not performed if peak level lower than average limit. 2. Other frequency was 20dB below limit line within 1-18GHz, there is not show in the report. | | |

| Mark | Frequency (MHz) | Reading Level (dBμV) | Factor (dB) | Measure Level (dBμV/m) | Limit (dBμV/m) | Margin (dB) | Detector | Polarization |
|------|-----------------|----------------------|-------------|------------------------|----------------|-------------|----------|--------------|
| * | 9729.5 | 31.4 | 14.6 | 46.0 | 68.2 | -22.2 | Peak | Horizontal |
| * | 10324.5 | 31.3 | 16.5 | 47.8 | 68.2 | -20.4 | Peak | Horizontal |
| | 11472.0 | 31.1 | 20.0 | 51.1 | 74.0 | -22.9 | Peak | Horizontal |
| | 12211.5 | 31.1 | 20.6 | 51.7 | 74.0 | -22.3 | Peak | Horizontal |
| * | 9772.0 | 31.3 | 14.9 | 46.2 | 68.2 | -22.0 | Peak | Vertical |
| * | 10265.0 | 31.3 | 16.2 | 47.5 | 68.2 | -20.7 | Peak | Vertical |
| | 11591.0 | 29.8 | 20.1 | 49.9 | 74.0 | -24.1 | Peak | Vertical |
| | 11965.0 | 30.3 | 20.3 | 50.6 | 74.0 | -23.4 | Peak | Vertical |

Note 1: "*" is not in restricted band, its limit is -27dBm/MHz. At a distance of 3 meters, the field strength limit in dBμV/m can be determined by adding a "conversion" factor of 95.2dB to the EIRP limit of -27dBm/MHz to obtain the limit for out of band spurious emissions.

Note 2: Measure Level (dBμV/m) = Reading Level (dBμV) + Factor (dB)

Factor (dB) = Cable Loss (dB) + Antenna Factor (dB/m) - Pre_Amplifier Gain (dB)

| | | | |
|---------------|---|-------------------|-------------------------|
| Product | OmniAccess Stellar | Temperature | 22 ~ 26°C |
| Test Engineer | David Lv | Relative Humidity | 44 ~ 57 % |
| Test Site | AC1 | Test Date | 2019/11/26 ~ 2020/02/24 |
| Test Mode | 802.11a - Ant 0 + 1 + 2 + 3 (CDD Mode) | Test Channel | 48 |
| Model No. | OAW-AP1362 | | |
| Remark: | 1. Average measurement was not performed if peak level lower than average limit. 2. Other frequency was 20dB below limit line within 1-18GHz, there is not show in the report. | | |

| Mark | Frequency (MHz) | Reading Level (dBμV) | Factor (dB) | Measure Level (dBμV/m) | Limit (dBμV/m) | Margin (dB) | Detector | Polarization |
|------|-----------------|----------------------|-------------|------------------------|----------------|-------------|----------|--------------|
| * | 9772.0 | 31.5 | 14.9 | 46.4 | 68.2 | -21.8 | Peak | Horizontal |
| * | 10273.5 | 31.6 | 16.1 | 47.7 | 68.2 | -20.5 | Peak | Horizontal |
| | 11489.0 | 30.4 | 19.7 | 50.1 | 74.0 | -23.9 | Peak | Horizontal |
| | 12262.5 | 30.1 | 20.4 | 50.5 | 74.0 | -23.5 | Peak | Horizontal |
| * | 9857.0 | 31.1 | 15.1 | 46.2 | 68.2 | -22.0 | Peak | Vertical |
| * | 10214.0 | 30.1 | 15.9 | 46.0 | 68.2 | -22.2 | Peak | Vertical |
| | 11038.5 | 30.5 | 18.4 | 48.9 | 74.0 | -25.1 | Peak | Vertical |
| | 11616.5 | 31.3 | 19.6 | 50.9 | 74.0 | -23.1 | Peak | Vertical |

Note 1: "*" is not in restricted band, its limit is -27dBm/MHz. At a distance of 3 meters, the field strength limit in dBμV/m can be determined by adding a "conversion" factor of 95.2dB to the EIRP limit of -27dBm/MHz to obtain the limit for out of band spurious emissions.

Note 2: Measure Level (dBμV/m) = Reading Level (dBμV) + Factor (dB)

Factor (dB) = Cable Loss (dB) + Antenna Factor (dB/m) - Pre_Amplifier Gain (dB)

| | | | |
|---------------|---|-------------------|-------------------------|
| Product | OmniAccess Stellar | Temperature | 22 ~ 26°C |
| Test Engineer | David Lv | Relative Humidity | 44 ~ 57 % |
| Test Site | AC1 | Test Date | 2019/11/26 ~ 2020/02/24 |
| Test Mode | 802.11a - Ant 0 + 1 + 2 + 3 (CDD Mode) | Test Channel | 149 |
| Model No. | OAW-AP1362 | | |
| Remark: | 1. Average measurement was not performed if peak level lower than average limit. 2. Other frequency was 20dB below limit line within 1-18GHz, there is not show in the report. | | |

| Mark | Frequency (MHz) | Reading Level (dBμV) | Factor (dB) | Measure Level (dBμV/m) | Limit (dBμV/m) | Margin (dB) | Detector | Polarization |
|------|-----------------|----------------------|-------------|------------------------|----------------|-------------|----------|--------------|
| * | 9746.5 | 32.6 | 14.9 | 47.5 | 68.2 | -20.7 | Peak | Horizontal |
| * | 10333.0 | 32.1 | 16.4 | 48.5 | 68.2 | -19.7 | Peak | Horizontal |
| | 11217.0 | 30.5 | 18.9 | 49.4 | 74.0 | -24.6 | Peak | Horizontal |
| | 12152.0 | 30.3 | 20.4 | 50.7 | 74.0 | -23.3 | Peak | Horizontal |
| * | 9746.5 | 31.9 | 14.9 | 46.8 | 68.2 | -21.4 | Peak | Vertical |
| * | 10316.0 | 30.8 | 16.6 | 47.4 | 68.2 | -20.8 | Peak | Vertical |
| | 11072.5 | 30.6 | 18.3 | 48.9 | 74.0 | -25.2 | Peak | Vertical |
| | 11684.5 | 30.4 | 19.8 | 50.2 | 74.0 | -23.8 | Peak | Vertical |

Note 1: "*" is not in restricted band, its limit is -27dBm/MHz. At a distance of 3 meters, the field strength limit in dBμV/m can be determined by adding a "conversion" factor of 95.2dB to the EIRP limit of -27dBm/MHz to obtain the limit for out of band spurious emissions.

Note 2: Measure Level (dBμV/m) = Reading Level (dBμV) + Factor (dB)

Factor (dB) = Cable Loss (dB) + Antenna Factor (dB/m) - Pre_Amplifier Gain (dB)

| | | | |
|---------------|---|-------------------|-------------------------|
| Product | OmniAccess Stellar | Temperature | 22 ~ 26°C |
| Test Engineer | David Lv | Relative Humidity | 44 ~ 57 % |
| Test Site | AC1 | Test Date | 2019/11/26 ~ 2020/02/24 |
| Test Mode | 802.11a - Ant 0 + 1 + 2 + 3 (CDD Mode) | Test Channel | 157 |
| Model No. | OAW-AP1362 | | |
| Remark: | 1. Average measurement was not performed if peak level lower than average limit. 2. Other frequency was 20dB below limit line within 1-18GHz, there is not show in the report. | | |

| Mark | Frequency (MHz) | Reading Level (dBμV) | Factor (dB) | Measure Level (dBμV/m) | Limit (dBμV/m) | Margin (dB) | Detector | Polarization |
|------|-----------------|----------------------|-------------|------------------------|----------------|-------------|----------|--------------|
| * | 9746.5 | 32.1 | 14.9 | 47.0 | 68.2 | -21.2 | Peak | Horizontal |
| * | 10528.5 | 32.6 | 16.4 | 49.0 | 68.2 | -19.2 | Peak | Horizontal |
| | 10996.0 | 30.9 | 18.4 | 49.3 | 74.0 | -24.7 | Peak | Horizontal |
| | 11599.5 | 30.3 | 19.9 | 50.2 | 74.0 | -23.8 | Peak | Horizontal |
| * | 9568.0 | 32.5 | 14.5 | 47.0 | 68.2 | -21.2 | Peak | Vertical |
| * | 10401.0 | 30.8 | 16.5 | 47.3 | 68.2 | -20.9 | Peak | Vertical |
| | 11217.0 | 31.1 | 18.9 | 50.0 | 74.0 | -24.0 | Peak | Vertical |
| | 11480.5 | 31.1 | 19.9 | 51.0 | 74.0 | -23.0 | Peak | Vertical |

Note 1: "*" is not in restricted band, its limit is -27dBm/MHz. At a distance of 3 meters, the field strength limit in dBμV/m can be determined by adding a "conversion" factor of 95.2dB to the EIRP limit of -27dBm/MHz to obtain the limit for out of band spurious emissions.

Note 2: Measure Level (dBμV/m) = Reading Level (dBμV) + Factor (dB)

Factor (dB) = Cable Loss (dB) + Antenna Factor (dB/m) - Pre_Amplifier Gain (dB)

| | | | |
|---------------|---|-------------------|-------------------------|
| Product | OmniAccess Stellar | Temperature | 22 ~ 26°C |
| Test Engineer | David Lv | Relative Humidity | 44 ~ 57 % |
| Test Site | AC1 | Test Date | 2019/11/26 ~ 2020/02/24 |
| Test Mode | 802.11a - Ant 0 + 1 + 2 + 3 (CDD Mode) | Test Channel | 165 |
| Model No. | OAW-AP1362 | | |
| Remark: | 1. Average measurement was not performed if peak level lower than average limit. 2. Other frequency was 20dB below limit line within 1-18GHz, there is not show in the report. | | |

| Mark | Frequency (MHz) | Reading Level (dBμV) | Factor (dB) | Measure Level (dBμV/m) | Limit (dBμV/m) | Margin (dB) | Detector | Polarization |
|------|-----------------|----------------------|-------------|------------------------|----------------|-------------|----------|--------------|
| * | 9746.5 | 32.2 | 14.9 | 47.1 | 68.2 | -21.1 | Peak | Horizontal |
| * | 10248.0 | 31.5 | 16.2 | 47.7 | 68.2 | -20.5 | Peak | Horizontal |
| | 11540.0 | 30.2 | 20.3 | 50.5 | 74.0 | -23.5 | Peak | Horizontal |
| | 12347.5 | 30.4 | 20.4 | 50.8 | 74.0 | -23.2 | Peak | Horizontal |
| * | 9653.0 | 32.2 | 14.3 | 46.5 | 68.2 | -21.7 | Peak | Vertical |
| * | 10265.0 | 29.9 | 16.2 | 46.1 | 68.2 | -22.1 | Peak | Vertical |
| | 11540.0 | 29.6 | 20.3 | 49.9 | 74.0 | -24.1 | Peak | Vertical |
| | 12203.0 | 29.8 | 20.4 | 50.2 | 74.0 | -23.8 | Peak | Vertical |

Note 1: "*" is not in restricted band, its limit is -27dBm/MHz. At a distance of 3 meters, the field strength limit in dBμV/m can be determined by adding a "conversion" factor of 95.2dB to the EIRP limit of -27dBm/MHz to obtain the limit for out of band spurious emissions.

Note 2: Measure Level (dBμV/m) = Reading Level (dBμV) + Factor (dB)

Factor (dB) = Cable Loss (dB) + Antenna Factor (dB/m) - Pre_Amplifier Gain (dB)

| | | | |
|---------------|---|-------------------|-------------------------|
| Product | OmniAccess Stellar | Temperature | 22 ~ 26°C |
| Test Engineer | David Lv | Relative Humidity | 44 ~ 57 % |
| Test Site | AC1 | Test Date | 2019/11/26 ~ 2020/02/24 |
| Test Mode | 802.11n-HT20 - Ant 0 + 1 + 2 + 3 (CDD Mode) | Test Channel | 36 |
| Model No. | OAW-AP1362 | | |
| Remark: | 1. Average measurement was not performed if peak level lower than average limit. 2. Other frequency was 20dB below limit line within 1-18GHz, there is not show in the report. | | |

| Mark | Frequency (MHz) | Reading Level (dBμV) | Factor (dB) | Measure Level (dBμV/m) | Limit (dBμV/m) | Margin (dB) | Detector | Polarization |
|------|-----------------|----------------------|-------------|------------------------|----------------|-------------|----------|--------------|
| * | 9772.0 | 30.7 | 14.9 | 45.6 | 68.2 | -22.6 | Peak | Horizontal |
| * | 10137.5 | 32.2 | 15.0 | 47.2 | 68.2 | -21.0 | Peak | Horizontal |
| | 11412.5 | 29.3 | 19.5 | 48.8 | 74.0 | -25.2 | Peak | Horizontal |
| | 12109.5 | 30.7 | 19.9 | 50.6 | 74.0 | -23.4 | Peak | Horizontal |
| * | 9738.0 | 31.4 | 14.7 | 46.1 | 68.2 | -22.1 | Peak | Vertical |
| * | 10333.0 | 31.1 | 16.4 | 47.5 | 68.2 | -20.7 | Peak | Vertical |
| | 11106.5 | 30.1 | 18.4 | 48.5 | 74.0 | -25.5 | Peak | Vertical |
| | 11778.0 | 29.6 | 20.3 | 49.9 | 74.0 | -24.1 | Peak | Vertical |

Note 1: "*" is not in restricted band, its limit is -27dBm/MHz. At a distance of 3 meters, the field strength limit in dBμV/m can be determined by adding a "conversion" factor of 95.2dB to the EIRP limit of -27dBm/MHz to obtain the limit for out of band spurious emissions.

Note 2: Measure Level (dBμV/m) = Reading Level (dBμV) + Factor (dB)

Factor (dB) = Cable Loss (dB) + Antenna Factor (dB/m) - Pre_Amplifier Gain (dB)

| | | | |
|---------------|---|-------------------|-------------------------|
| Product | OmniAccess Stellar | Temperature | 22 ~ 26°C |
| Test Engineer | David Lv | Relative Humidity | 44 ~ 57 % |
| Test Site | AC1 | Test Date | 2019/11/26 ~ 2020/02/24 |
| Test Mode | 802.11n-HT20 - Ant 0 + 1 + 2 + 3 (CDD Mode) | Test Channel | 44 |
| Model No. | OAW-AP1362 | | |
| Remark: | 1. Average measurement was not performed if peak level lower than average limit. 2. Other frequency was 20dB below limit line within 1-18GHz, there is not show in the report. | | |

| Mark | Frequency (MHz) | Reading Level (dBμV) | Factor (dB) | Measure Level (dBμV/m) | Limit (dBμV/m) | Margin (dB) | Detector | Polarization |
|------|-----------------|----------------------|-------------|------------------------|----------------|-------------|----------|--------------|
| * | 9687.0 | 31.4 | 14.4 | 45.8 | 68.2 | -22.4 | Peak | Horizontal |
| * | 10086.5 | 31.6 | 14.8 | 46.4 | 68.2 | -21.8 | Peak | Horizontal |
| | 11021.5 | 29.3 | 18.0 | 47.3 | 74.0 | -26.7 | Peak | Horizontal |
| | 11582.5 | 30.4 | 19.8 | 50.2 | 74.0 | -23.8 | Peak | Horizontal |
| * | 8675.5 | 31.0 | 13.4 | 44.4 | 68.2 | -23.8 | Peak | Vertical |
| * | 10239.5 | 31.1 | 15.9 | 47.0 | 68.2 | -21.2 | Peak | Vertical |
| | 11540.0 | 29.9 | 20.3 | 50.2 | 74.0 | -23.8 | Peak | Vertical |
| | 12220.0 | 29.4 | 20.8 | 50.2 | 74.0 | -23.8 | Peak | Vertical |

Note 1: "*" is not in restricted band, its limit is -27dBm/MHz. At a distance of 3 meters, the field strength limit in dBμV/m can be determined by adding a "conversion" factor of 95.2dB to the EIRP limit of -27dBm/MHz to obtain the limit for out of band spurious emissions.

Note 2: Measure Level (dBμV/m) = Reading Level (dBμV) + Factor (dB)

Factor (dB) = Cable Loss (dB) + Antenna Factor (dB/m) - Pre_Amplifier Gain (dB)

| | | | |
|---------------|---|-------------------|-------------------------|
| Product | OmniAccess Stellar | Temperature | 22 ~ 26°C |
| Test Engineer | David Lv | Relative Humidity | 44 ~ 57 % |
| Test Site | AC1 | Test Date | 2019/11/26 ~ 2020/02/24 |
| Test Mode | 802.11n-HT20 - Ant 0 + 1 + 2 + 3 (CDD Mode) | Test Channel | 48 |
| Model No. | OAW-AP1362 | | |
| Remark: | 1. Average measurement was not performed if peak level lower than average limit. 2. Other frequency was 20dB below limit line within 1-18GHz, there is not show in the report. | | |

| Mark | Frequency (MHz) | Reading Level (dBμV) | Factor (dB) | Measure Level (dBμV/m) | Limit (dBμV/m) | Margin (dB) | Detector | Polarization |
|------|-----------------|----------------------|-------------|------------------------|----------------|-------------|----------|--------------|
| * | 9729.5 | 31.1 | 14.6 | 45.7 | 68.2 | -22.5 | Peak | Horizontal |
| * | 10214.0 | 30.8 | 15.9 | 46.7 | 68.2 | -21.5 | Peak | Horizontal |
| | 10826.0 | 31.0 | 17.4 | 48.4 | 74.0 | -25.6 | Peak | Horizontal |
| | 11472.0 | 29.9 | 20.0 | 49.9 | 74.0 | -24.1 | Peak | Horizontal |
| * | 9738.0 | 32.1 | 14.7 | 46.8 | 68.2 | -21.4 | Peak | Vertical |
| * | 10248.0 | 31.1 | 16.2 | 47.3 | 68.2 | -20.9 | Peak | Vertical |
| | 11276.5 | 29.4 | 18.9 | 48.3 | 74.0 | -25.7 | Peak | Vertical |
| | 12152.0 | 30.4 | 20.4 | 50.8 | 74.0 | -23.2 | Peak | Vertical |

Note 1: "*" is not in restricted band, its limit is -27dBm/MHz. At a distance of 3 meters, the field strength limit in dBμV/m can be determined by adding a "conversion" factor of 95.2dB to the EIRP limit of -27dBm/MHz to obtain the limit for out of band spurious emissions.

Note 2: Measure Level (dBμV/m) = Reading Level (dBμV) + Factor (dB)

Factor (dB) = Cable Loss (dB) + Antenna Factor (dB/m) - Pre_Amplifier Gain (dB)

| | | | |
|---------------|---|-------------------|-------------------------|
| Product | OmniAccess Stellar | Temperature | 22 ~ 26°C |
| Test Engineer | David Lv | Relative Humidity | 44 ~ 57 % |
| Test Site | AC1 | Test Date | 2019/11/26 ~ 2020/02/24 |
| Test Mode | 802.11n-HT20 - Ant 0 + 1 + 2 + 3 (CDD Mode) | Test Channel | 149 |
| Model No. | OAW-AP1362 | | |
| Remark: | 1. Average measurement was not performed if peak level lower than average limit. 2. Other frequency was 20dB below limit line within 1-18GHz, there is not show in the report. | | |

| Mark | Frequency (MHz) | Reading Level (dBμV) | Factor (dB) | Measure Level (dBμV/m) | Limit (dBμV/m) | Margin (dB) | Detector | Polarization |
|------|-----------------|----------------------|-------------|------------------------|----------------|-------------|----------|--------------|
| * | 9806.0 | 32.7 | 14.9 | 47.6 | 68.2 | -20.6 | Peak | Horizontal |
| * | 10265.0 | 31.4 | 16.2 | 47.6 | 68.2 | -20.6 | Peak | Horizontal |
| | 11115.0 | 30.9 | 18.5 | 49.4 | 74.0 | -24.6 | Peak | Horizontal |
| | 11608.0 | 30.8 | 19.7 | 50.5 | 74.0 | -23.5 | Peak | Horizontal |
| * | 9891.0 | 31.6 | 15.4 | 47.0 | 68.2 | -21.2 | Peak | Vertical |
| * | 10248.0 | 31.5 | 16.2 | 47.7 | 68.2 | -20.5 | Peak | Vertical |
| | 10817.5 | 31.4 | 17.4 | 48.8 | 74.0 | -25.2 | Peak | Vertical |
| | 11480.5 | 30.1 | 19.9 | 50.0 | 74.0 | -24.0 | Peak | Vertical |

Note 1: "*" is not in restricted band, its limit is -27dBm/MHz. At a distance of 3 meters, the field strength limit in dBμV/m can be determined by adding a "conversion" factor of 95.2dB to the EIRP limit of -27dBm/MHz to obtain the limit for out of band spurious emissions.

Note 2: Measure Level (dBμV/m) = Reading Level (dBμV) + Factor (dB)

Factor (dB) = Cable Loss (dB) + Antenna Factor (dB/m) - Pre_Amplifier Gain (dB)

| | | | |
|---------------|---|-------------------|-------------------------|
| Product | OmniAccess Stellar | Temperature | 22 ~ 26°C |
| Test Engineer | David Lv | Relative Humidity | 44 ~ 57 % |
| Test Site | AC1 | Test Date | 2019/11/26 ~ 2020/02/24 |
| Test Mode | 802.11n-HT20 - Ant 0 + 1 + 2 + 3 (CDD Mode) | Test Channel | 157 |
| Model No. | OAW-AP1362 | | |
| Remark: | 1. Average measurement was not performed if peak level lower than average limit. 2. Other frequency was 20dB below limit line within 1-18GHz, there is not show in the report. | | |

| Mark | Frequency (MHz) | Reading Level (dBμV) | Factor (dB) | Measure Level (dBμV/m) | Limit (dBμV/m) | Margin (dB) | Detector | Polarization |
|------|-----------------|----------------------|-------------|------------------------|----------------|-------------|----------|--------------|
| * | 9738.0 | 32.3 | 14.7 | 47.0 | 68.2 | -21.2 | Peak | Horizontal |
| * | 10367.0 | 31.4 | 16.5 | 47.9 | 68.2 | -20.3 | Peak | Horizontal |
| | 11472.0 | 29.5 | 20.0 | 49.5 | 74.0 | -24.5 | Peak | Horizontal |
| | 12220.0 | 29.6 | 20.8 | 50.4 | 74.0 | -23.6 | Peak | Horizontal |
| * | 9899.5 | 29.3 | 15.2 | 44.5 | 68.2 | -23.7 | Peak | Vertical |
| * | 10350.0 | 30.3 | 16.4 | 46.7 | 68.2 | -21.5 | Peak | Vertical |
| | 11115.0 | 29.9 | 18.5 | 48.4 | 74.0 | -25.6 | Peak | Vertical |
| | 11982.0 | 29.6 | 19.9 | 49.5 | 74.0 | -24.5 | Peak | Vertical |

Note 1: "*" is not in restricted band, its limit is -27dBm/MHz. At a distance of 3 meters, the field strength limit in dBμV/m can be determined by adding a "conversion" factor of 95.2dB to the EIRP limit of -27dBm/MHz to obtain the limit for out of band spurious emissions.

Note 2: Measure Level (dBμV/m) = Reading Level (dBμV) + Factor (dB)

Factor (dB) = Cable Loss (dB) + Antenna Factor (dB/m) - Pre_Amplifier Gain (dB)

| | | | |
|---------------|---|-------------------|-------------------------|
| Product | OmniAccess Stellar | Temperature | 22 ~ 26°C |
| Test Engineer | David Lv | Relative Humidity | 44 ~ 57 % |
| Test Site | AC1 | Test Date | 2019/11/26 ~ 2020/02/24 |
| Test Mode | 802.11n-HT20 - Ant 0 + 1 + 2 + 3 (CDD Mode) | Test Channel | 165 |
| Model No. | OAW-AP1362 | | |
| Remark: | 1. Average measurement was not performed if peak level lower than average limit. 2. Other frequency was 20dB below limit line within 1-18GHz, there is not show in the report. | | |

| Mark | Frequency (MHz) | Reading Level (dBμV) | Factor (dB) | Measure Level (dBμV/m) | Limit (dBμV/m) | Margin (dB) | Detector | Polarization |
|------|-----------------|----------------------|-------------|------------------------|----------------|-------------|----------|--------------|
| * | 9746.5 | 31.6 | 14.9 | 46.5 | 68.2 | -21.7 | Peak | Horizontal |
| * | 10273.5 | 31.6 | 16.1 | 47.7 | 68.2 | -20.5 | Peak | Horizontal |
| | 10996.0 | 30.8 | 18.4 | 49.2 | 74.0 | -24.8 | Peak | Horizontal |
| | 11591.0 | 29.7 | 20.1 | 49.8 | 74.0 | -24.2 | Peak | Horizontal |
| * | 9721.0 | 31.3 | 14.6 | 45.9 | 68.2 | -22.3 | Peak | Vertical |
| * | 10418.0 | 31.1 | 16.4 | 47.5 | 68.2 | -20.7 | Peak | Vertical |
| | 11336.0 | 29.3 | 19.0 | 48.3 | 74.0 | -25.7 | Peak | Vertical |
| | 12237.0 | 29.6 | 20.8 | 50.4 | 74.0 | -23.6 | Peak | Vertical |

Note 1: "*" is not in restricted band, its limit is -27dBm/MHz. At a distance of 3 meters, the field strength limit in dBμV/m can be determined by adding a "conversion" factor of 95.2dB to the EIRP limit of -27dBm/MHz to obtain the limit for out of band spurious emissions.

Note 2: Measure Level (dBμV/m) = Reading Level (dBμV) + Factor (dB)

Factor (dB) = Cable Loss (dB) + Antenna Factor (dB/m) - Pre_Amplifier Gain (dB)

| | | | |
|---------------|---|-------------------|-------------------------|
| Product | OmniAccess Stellar | Temperature | 22 ~ 26°C |
| Test Engineer | David Lv | Relative Humidity | 44 ~ 57 % |
| Test Site | AC1 | Test Date | 2019/11/26 ~ 2020/02/24 |
| Test Mode | 802.11n-HT40 - Ant 0 + 1 + 2 + 3 (CDD Mode) | Test Channel | 38 |
| Model No. | OAW-AP1362 | | |
| Remark: | 1. Average measurement was not performed if peak level lower than average limit. 2. Other frequency was 20dB below limit line within 1-18GHz, there is not show in the report. | | |

| Mark | Frequency (MHz) | Reading Level (dBμV) | Factor (dB) | Measure Level (dBμV/m) | Limit (dBμV/m) | Margin (dB) | Detector | Polarization |
|------|-----------------|----------------------|-------------|------------------------|----------------|-------------|----------|--------------|
| | 9670.0 | 32.6 | 14.3 | 46.9 | 68.2 | -21.3 | Peak | Horizontal |
| * | 10273.5 | 31.7 | 16.1 | 47.8 | 68.2 | -20.4 | Peak | Horizontal |
| | 10834.5 | 31.8 | 17.4 | 49.2 | 74.0 | -24.8 | Peak | Horizontal |
| | 11591.0 | 29.7 | 20.1 | 49.8 | 74.0 | -24.2 | Peak | Horizontal |
| | 9636.0 | 32.2 | 14.4 | 46.6 | 68.2 | -21.6 | Peak | Vertical |
| * | 10239.5 | 31.4 | 15.9 | 47.3 | 68.2 | -20.9 | Peak | Vertical |
| | 10953.5 | 31.1 | 17.9 | 49.0 | 74.0 | -25.0 | Peak | Vertical |
| | 11463.5 | 30.5 | 19.7 | 50.2 | 74.0 | -23.8 | Peak | Vertical |

Note 1: "*" is not in restricted band, its limit is -27dBm/MHz. At a distance of 3 meters, the field strength limit in dBμV/m can be determined by adding a "conversion" factor of 95.2dB to the EIRP limit of -27dBm/MHz to obtain the limit for out of band spurious emissions.

Note 2: Measure Level (dBμV/m) = Reading Level (dBμV) + Factor (dB)

Factor (dB) = Cable Loss (dB) + Antenna Factor (dB/m) - Pre_Amplifier Gain (dB)

| | | | |
|---------------|---|-------------------|-------------------------|
| Product | OmniAccess Stellar | Temperature | 22 ~ 26°C |
| Test Engineer | David Lv | Relative Humidity | 44 ~ 57 % |
| Test Site | AC1 | Test Date | 2019/11/26 ~ 2020/02/24 |
| Test Mode | 802.11n-HT40 - Ant 0 + 1 + 2 + 3 (CDD Mode) | Test Channel | 46 |
| Model No. | OAW-AP1362 | | |
| Remark: | 1. Average measurement was not performed if peak level lower than average limit. 2. Other frequency was 20dB below limit line within 1-18GHz, there is not show in the report. | | |

| Mark | Frequency (MHz) | Reading Level (dBμV) | Factor (dB) | Measure Level (dBμV/m) | Limit (dBμV/m) | Margin (dB) | Detector | Polarization |
|------|-----------------|----------------------|-------------|------------------------|----------------|-------------|----------|--------------|
| * | 9993.0 | 29.6 | 15.1 | 44.7 | 68.2 | -23.5 | Peak | Horizontal |
| * | 10418.0 | 30.9 | 16.4 | 47.3 | 68.2 | -20.9 | Peak | Horizontal |
| | 11472.0 | 29.8 | 20.0 | 49.8 | 74.0 | -24.2 | Peak | Horizontal |
| | 11965.0 | 30.1 | 20.3 | 50.4 | 74.0 | -23.6 | Peak | Horizontal |
| * | 9797.5 | 31.8 | 14.9 | 46.7 | 68.2 | -21.5 | Peak | Vertical |
| * | 9993.0 | 29.6 | 15.1 | 44.7 | 68.2 | -23.5 | Peak | Vertical |
| | 10681.5 | 30.9 | 17.7 | 48.6 | 74.0 | -25.4 | Peak | Vertical |
| | 11599.5 | 30.4 | 19.9 | 50.3 | 74.0 | -23.7 | Peak | Vertical |

Note 1: "*" is not in restricted band, its limit is -27dBm/MHz. At a distance of 3 meters, the field strength limit in dBμV/m can be determined by adding a "conversion" factor of 95.2dB to the EIRP limit of -27dBm/MHz to obtain the limit for out of band spurious emissions.

Note 2: Measure Level (dBμV/m) = Reading Level (dBμV) + Factor (dB)

Factor (dB) = Cable Loss (dB) + Antenna Factor (dB/m) - Pre_Amplifier Gain (dB)

| | | | |
|---------------|---|-------------------|-------------------------|
| Product | OmniAccess Stellar | Temperature | 22 ~ 26°C |
| Test Engineer | David Lv | Relative Humidity | 44 ~ 57 % |
| Test Site | AC1 | Test Date | 2019/11/26 ~ 2020/02/24 |
| Test Mode | 802.11n-HT40 - Ant 0 + 1 + 2 + 3 (CDD Mode) | Test Channel | 151 |
| Model No. | OAW-AP1362 | | |
| Remark: | 1. Average measurement was not performed if peak level lower than average limit. 2. Other frequency was 20dB below limit line within 1-18GHz, there is not show in the report. | | |

| Mark | Frequency (MHz) | Reading Level (dBμV) | Factor (dB) | Measure Level (dBμV/m) | Limit (dBμV/m) | Margin (dB) | Detector | Polarization |
|------|-----------------|----------------------|-------------|------------------------|----------------|-------------|----------|--------------|
| * | 9738.0 | 32.9 | 14.7 | 47.6 | 68.2 | -20.6 | Peak | Horizontal |
| * | 10171.5 | 30.3 | 15.3 | 45.6 | 68.2 | -22.6 | Peak | Horizontal |
| | 11106.5 | 30.2 | 18.4 | 48.6 | 74.0 | -25.4 | Peak | Horizontal |
| | 11591.0 | 30.2 | 20.1 | 50.3 | 74.0 | -23.7 | Peak | Horizontal |
| * | 10103.5 | 31.8 | 14.8 | 46.6 | 68.2 | -21.6 | Peak | Vertical |
| * | 10435.0 | 31.1 | 16.5 | 47.6 | 68.2 | -20.6 | Peak | Vertical |
| | 10970.5 | 30.8 | 18.0 | 48.8 | 74.0 | -25.2 | Peak | Vertical |
| | 11795.0 | 30.6 | 20.3 | 50.9 | 74.0 | -23.1 | Peak | Vertical |

Note 1: "*" is not in restricted band, its limit is -27dBm/MHz. At a distance of 3 meters, the field strength limit in dBμV/m can be determined by adding a "conversion" factor of 95.2dB to the EIRP limit of -27dBm/MHz to obtain the limit for out of band spurious emissions.

Note 2: Measure Level (dBμV/m) = Reading Level (dBμV) + Factor (dB)

Factor (dB) = Cable Loss (dB) + Antenna Factor (dB/m) - Pre_Amplifier Gain (dB)

| | | | |
|---------------|---|-------------------|-------------------------|
| Product | OmniAccess Stellar | Temperature | 22 ~ 26°C |
| Test Engineer | David Lv | Relative Humidity | 44 ~ 57 % |
| Test Site | AC1 | Test Date | 2019/11/26 ~ 2020/02/24 |
| Test Mode | 802.11n-HT40 - Ant 0 + 1 + 2 + 3 (CDD Mode) | Test Channel | 159 |
| Model No. | OAW-AP1362 | | |
| Remark: | 1. Average measurement was not performed if peak level lower than average limit. 2. Other frequency was 20dB below limit line within 1-18GHz, there is not show in the report. | | |

| Mark | Frequency (MHz) | Reading Level (dBμV) | Factor (dB) | Measure Level (dBμV/m) | Limit (dBμV/m) | Margin (dB) | Detector | Polarization |
|------|-----------------|----------------------|-------------|------------------------|----------------|-------------|----------|--------------|
| * | 9636.0 | 31.8 | 14.4 | 46.2 | 68.2 | -22.0 | Peak | Horizontal |
| * | 10307.5 | 31.0 | 16.5 | 47.5 | 68.2 | -20.7 | Peak | Horizontal |
| | 11217.0 | 30.1 | 18.9 | 49.0 | 74.0 | -25.0 | Peak | Horizontal |
| | 11591.0 | 30.1 | 20.1 | 50.2 | 74.0 | -23.8 | Peak | Horizontal |
| * | 9721.0 | 32.3 | 14.6 | 46.9 | 68.2 | -21.3 | Peak | Vertical |
| * | 10069.5 | 31.7 | 14.9 | 46.6 | 68.2 | -21.6 | Peak | Vertical |
| | 10996.0 | 30.2 | 18.4 | 48.6 | 74.0 | -25.4 | Peak | Vertical |
| | 11582.5 | 30.6 | 19.8 | 50.4 | 74.0 | -23.6 | Peak | Vertical |

Note 1: "*" is not in restricted band, its limit is -27dBm/MHz. At a distance of 3 meters, the field strength limit in dBμV/m can be determined by adding a "conversion" factor of 95.2dB to the EIRP limit of -27dBm/MHz to obtain the limit for out of band spurious emissions.

Note 2: Measure Level (dBμV/m) = Reading Level (dBμV) + Factor (dB)

Factor (dB) = Cable Loss (dB) + Antenna Factor (dB/m) - Pre_Amplifier Gain (dB)

| | | | |
|---------------|---|-------------------|-------------------------|
| Product | OmniAccess Stellar | Temperature | 22 ~ 26°C |
| Test Engineer | David Lv | Relative Humidity | 44 ~ 57 % |
| Test Site | AC1 | Test Date | 2019/11/26 ~ 2020/02/24 |
| Test Mode | 802.11ax-HE20 - Ant 0 + 1 + 2 + 3 (CDD Mode) | Test Channel | 36 |
| Model No. | OAW-AP1362 | | |
| Remark: | 1. Average measurement was not performed if peak level lower than average limit. 2. Other frequency was 20dB below limit line within 1-18GHz, there is not show in the report. | | |

| Mark | Frequency (MHz) | Reading Level (dBμV) | Factor (dB) | Measure Level (dBμV/m) | Limit (dBμV/m) | Margin (dB) | Detector | Polarization |
|------|-----------------|----------------------|-------------|------------------------|----------------|-------------|----------|--------------|
| * | 9670.0 | 32.3 | 14.3 | 46.6 | 68.2 | -21.6 | Peak | Horizontal |
| * | 10112.0 | 32.7 | 14.9 | 47.6 | 68.2 | -20.6 | Peak | Horizontal |
| | 11293.5 | 30.9 | 18.9 | 49.8 | 74.0 | -24.2 | Peak | Horizontal |
| | 11905.5 | 30.3 | 20.2 | 50.5 | 74.0 | -23.5 | Peak | Horizontal |
| * | 9602.0 | 32.7 | 14.2 | 46.9 | 68.2 | -21.3 | Peak | Vertical |
| * | 10256.5 | 31.8 | 16.2 | 48.0 | 68.2 | -20.2 | Peak | Vertical |
| | 11412.5 | 29.9 | 19.5 | 49.4 | 74.0 | -24.6 | Peak | Vertical |
| | 12228.5 | 29.9 | 20.8 | 50.7 | 74.0 | -23.3 | Peak | Vertical |

Note 1: "*" is not in restricted band, its limit is -27dBm/MHz. At a distance of 3 meters, the field strength limit in dBμV/m can be determined by adding a "conversion" factor of 95.2dB to the EIRP limit of -27dBm/MHz to obtain the limit for out of band spurious emissions.

Note 2: Measure Level (dBμV/m) = Reading Level (dBμV) + Factor (dB)

Factor (dB) = Cable Loss (dB) + Antenna Factor (dB/m) - Pre_Amplifier Gain (dB)

| | | | |
|---------------|---|-------------------|-------------------------|
| Product | OmniAccess Stellar | Temperature | 22 ~ 26°C |
| Test Engineer | David Lv | Relative Humidity | 44 ~ 57 % |
| Test Site | AC1 | Test Date | 2019/11/26 ~ 2020/02/24 |
| Test Mode | 802.11ax-HE20 - Ant 0 + 1 + 2 + 3 (CDD Mode) | Test Channel | 44 |
| Model No. | OAW-AP1362 | | |
| Remark: | 1. Average measurement was not performed if peak level lower than average limit. 2. Other frequency was 20dB below limit line within 1-18GHz, there is not show in the report. | | |

| Mark | Frequency (MHz) | Reading Level (dBμV) | Factor (dB) | Measure Level (dBμV/m) | Limit (dBμV/m) | Margin (dB) | Detector | Polarization |
|------|-----------------|----------------------|-------------|------------------------|----------------|-------------|----------|--------------|
| * | 9755.0 | 32.3 | 15.0 | 47.3 | 68.2 | -20.9 | Peak | Horizontal |
| * | 10129.0 | 31.9 | 15.0 | 46.9 | 68.2 | -21.3 | Peak | Horizontal |
| | 11038.5 | 31.5 | 18.4 | 49.9 | 74.0 | -24.1 | Peak | Horizontal |
| | 11582.5 | 30.7 | 19.8 | 50.5 | 74.0 | -23.5 | Peak | Horizontal |
| * | 9942.0 | 30.8 | 15.0 | 45.8 | 68.2 | -22.4 | Peak | Vertical |
| * | 10316.0 | 31.5 | 16.6 | 48.1 | 68.2 | -20.1 | Peak | Vertical |
| | 11446.5 | 31.6 | 19.4 | 51.0 | 74.0 | -23.0 | Peak | Vertical |
| | 11786.5 | 30.3 | 20.3 | 50.6 | 74.0 | -23.4 | Peak | Vertical |

Note 1: "*" is not in restricted band, its limit is -27dBm/MHz. At a distance of 3 meters, the field strength limit in dBμV/m can be determined by adding a "conversion" factor of 95.2dB to the EIRP limit of -27dBm/MHz to obtain the limit for out of band spurious emissions.

Note 2: Measure Level (dBμV/m) = Reading Level (dBμV) + Factor (dB)

Factor (dB) = Cable Loss (dB) + Antenna Factor (dB/m) - Pre_Amplifier Gain (dB)

| | | | |
|---------------|---|-------------------|-------------------------|
| Product | OmniAccess Stellar | Temperature | 22 ~ 26°C |
| Test Engineer | David Lv | Relative Humidity | 44 ~ 57 % |
| Test Site | AC1 | Test Date | 2019/11/26 ~ 2020/02/24 |
| Test Mode | 802.11ax-HE20 - Ant 0 + 1 + 2 + 3 (CDD Mode) | Test Channel | 48 |
| Model No. | OAW-AP1362 | | |
| Remark: | 1. Average measurement was not performed if peak level lower than average limit. 2. Other frequency was 20dB below limit line within 1-18GHz, there is not show in the report. | | |

| Mark | Frequency (MHz) | Reading Level (dBμV) | Factor (dB) | Measure Level (dBμV/m) | Limit (dBμV/m) | Margin (dB) | Detector | Polarization |
|------|-----------------|----------------------|-------------|------------------------|----------------|-------------|----------|--------------|
| * | 9942.0 | 30.8 | 15.0 | 45.8 | 68.2 | -22.4 | Peak | Horizontal |
| * | 10265.0 | 31.1 | 16.2 | 47.3 | 68.2 | -20.9 | Peak | Horizontal |
| | 11055.5 | 30.6 | 18.5 | 49.1 | 74.0 | -24.9 | Peak | Horizontal |
| | 11591.0 | 30.4 | 20.1 | 50.5 | 74.0 | -23.5 | Peak | Horizontal |
| * | 9772.0 | 32.5 | 14.9 | 47.4 | 68.2 | -20.8 | Peak | Vertical |
| * | 10503.0 | 31.6 | 16.5 | 48.1 | 68.2 | -20.1 | Peak | Vertical |
| | 11591.0 | 30.5 | 20.1 | 50.6 | 74.0 | -23.4 | Peak | Vertical |
| | 12152.0 | 29.8 | 20.4 | 50.2 | 74.0 | -23.8 | Peak | Vertical |

Note 1: "*" is not in restricted band, its limit is -27dBm/MHz. At a distance of 3 meters, the field strength limit in dBμV/m can be determined by adding a "conversion" factor of 95.2dB to the EIRP limit of -27dBm/MHz to obtain the limit for out of band spurious emissions.

Note 2: Measure Level (dBμV/m) = Reading Level (dBμV) + Factor (dB)

Factor (dB) = Cable Loss (dB) + Antenna Factor (dB/m) - Pre_Amplifier Gain (dB)

| | | | |
|---------------|---|-------------------|-------------------------|
| Product | OmniAccess Stellar | Temperature | 22 ~ 26°C |
| Test Engineer | David Lv | Relative Humidity | 44 ~ 57 % |
| Test Site | AC1 | Test Date | 2019/11/26 ~ 2020/02/24 |
| Test Mode | 802.11ax-HE20 - Ant 0 + 1 + 2 + 3 (CDD Mode) | Test Channel | 149 |
| Model No. | OAW-AP1362 | | |
| Remark: | 1. Average measurement was not performed if peak level lower than average limit. 2. Other frequency was 20dB below limit line within 1-18GHz, there is not show in the report. | | |

| Mark | Frequency (MHz) | Reading Level (dBμV) | Factor (dB) | Measure Level (dBμV/m) | Limit (dBμV/m) | Margin (dB) | Detector | Polarization |
|------|-----------------|----------------------|-------------|------------------------|----------------|-------------|----------|--------------|
| * | 9738.0 | 32.0 | 14.7 | 46.7 | 68.2 | -21.5 | Peak | Horizontal |
| * | 10214.0 | 31.1 | 15.9 | 47.0 | 68.2 | -21.2 | Peak | Horizontal |
| | 11081.0 | 30.7 | 18.3 | 49.0 | 74.0 | -25.0 | Peak | Horizontal |
| | 12160.5 | 30.6 | 20.2 | 50.8 | 74.0 | -23.2 | Peak | Horizontal |
| * | 9593.5 | 33.1 | 14.2 | 47.3 | 68.2 | -20.9 | Peak | Vertical |
| * | 10333.0 | 31.3 | 16.4 | 47.7 | 68.2 | -20.5 | Peak | Vertical |
| | 10996.0 | 30.6 | 18.4 | 49.0 | 74.0 | -25.0 | Peak | Vertical |
| | 11557.0 | 30.3 | 19.5 | 49.8 | 74.0 | -24.2 | Peak | Vertical |

Note 1: "*" is not in restricted band, its limit is -27dBm/MHz. At a distance of 3 meters, the field strength limit in dBμV/m can be determined by adding a "conversion" factor of 95.2dB to the EIRP limit of -27dBm/MHz to obtain the limit for out of band spurious emissions.

Note 2: Measure Level (dBμV/m) = Reading Level (dBμV) + Factor (dB)

Factor (dB) = Cable Loss (dB) + Antenna Factor (dB/m) - Pre_Amplifier Gain (dB)

| | | | |
|---------------|---|-------------------|-------------------------|
| Product | OmniAccess Stellar | Temperature | 22 ~ 26°C |
| Test Engineer | David Lv | Relative Humidity | 44 ~ 57 % |
| Test Site | AC1 | Test Date | 2019/11/26 ~ 2020/02/24 |
| Test Mode | 802.11ax-HE20 - Ant 0 + 1 + 2 + 3 (CDD Mode) | Test Channel | 157 |
| Model No. | OAW-AP1362 | | |
| Remark: | 1. Average measurement was not performed if peak level lower than average limit. 2. Other frequency was 20dB below limit line within 1-18GHz, there is not show in the report. | | |

| Mark | Frequency (MHz) | Reading Level (dBμV) | Factor (dB) | Measure Level (dBμV/m) | Limit (dBμV/m) | Margin (dB) | Detector | Polarization |
|------|-----------------|----------------------|-------------|------------------------|----------------|-------------|----------|--------------|
| * | 9721.0 | 32.7 | 14.6 | 47.3 | 68.2 | -20.9 | Peak | Horizontal |
| * | 10239.5 | 31.4 | 15.9 | 47.3 | 68.2 | -20.9 | Peak | Horizontal |
| | 10936.5 | 31.2 | 17.9 | 49.1 | 74.0 | -24.9 | Peak | Horizontal |
| | 11582.5 | 30.4 | 19.8 | 50.2 | 74.0 | -23.8 | Peak | Horizontal |
| * | 9814.5 | 32.4 | 15.0 | 47.4 | 68.2 | -20.8 | Peak | Vertical |
| * | 10171.5 | 32.4 | 15.3 | 47.7 | 68.2 | -20.5 | Peak | Vertical |
| | 10979.0 | 30.6 | 18.1 | 48.7 | 74.0 | -25.3 | Peak | Vertical |
| | 11540.0 | 29.6 | 20.3 | 49.9 | 74.0 | -24.1 | Peak | Vertical |

Note 1: "*" is not in restricted band, its limit is -27dBm/MHz. At a distance of 3 meters, the field strength limit in dBμV/m can be determined by adding a "conversion" factor of 95.2dB to the EIRP limit of -27dBm/MHz to obtain the limit for out of band spurious emissions.

Note 2: Measure Level (dBμV/m) = Reading Level (dBμV) + Factor (dB)

Factor (dB) = Cable Loss (dB) + Antenna Factor (dB/m) - Pre_Amplifier Gain (dB)

| | | | |
|---------------|---|-------------------|-------------------------|
| Product | OmniAccess Stellar | Temperature | 22 ~ 26°C |
| Test Engineer | David Lv | Relative Humidity | 44 ~ 57 % |
| Test Site | AC1 | Test Date | 2019/11/26 ~ 2020/02/24 |
| Test Mode | 802.11ax-HE20 - Ant 0 + 1 + 2 + 3 (CDD Mode) | Test Channel | 165 |
| Model No. | OAW-AP1362 | | |
| Remark: | 1. Average measurement was not performed if peak level lower than average limit. 2. Other frequency was 20dB below limit line within 1-18GHz, there is not show in the report. | | |

| Mark | Frequency (MHz) | Reading Level (dBμV) | Factor (dB) | Measure Level (dBμV/m) | Limit (dBμV/m) | Margin (dB) | Detector | Polarization |
|------|-----------------|----------------------|-------------|------------------------|----------------|-------------|----------|--------------|
| * | 9729.5 | 32.8 | 14.6 | 47.4 | 68.2 | -20.8 | Peak | Horizontal |
| * | 10290.5 | 31.2 | 16.2 | 47.4 | 68.2 | -20.8 | Peak | Horizontal |
| | 11540.0 | 29.6 | 20.3 | 49.9 | 74.0 | -24.1 | Peak | Horizontal |
| | 12118.0 | 30.6 | 19.8 | 50.4 | 74.0 | -23.6 | Peak | Horizontal |
| * | 9814.5 | 30.3 | 15.0 | 45.3 | 68.2 | -22.9 | Peak | Vertical |
| * | 10324.5 | 30.5 | 16.5 | 47.0 | 68.2 | -21.2 | Peak | Vertical |
| | 11616.5 | 30.7 | 19.6 | 50.3 | 74.0 | -23.7 | Peak | Vertical |
| | 12279.5 | 30.5 | 20.8 | 51.3 | 74.0 | -22.7 | Peak | Vertical |

Note 1: "*" is not in restricted band, its limit is -27dBm/MHz. At a distance of 3 meters, the field strength limit in dBμV/m can be determined by adding a "conversion" factor of 95.2dB to the EIRP limit of -27dBm/MHz to obtain the limit for out of band spurious emissions.

Note 2: Measure Level (dBμV/m) = Reading Level (dBμV) + Factor (dB)

Factor (dB) = Cable Loss (dB) + Antenna Factor (dB/m) - Pre_Amplifier Gain (dB)

| | | | |
|---------------|---|-------------------|-------------------------|
| Product | OmniAccess Stellar | Temperature | 22 ~ 26°C |
| Test Engineer | David Lv | Relative Humidity | 44 ~ 57 % |
| Test Site | AC1 | Test Date | 2019/11/26 ~ 2020/02/24 |
| Test Mode | 802.11ax-HE40 - Ant 0 + 1 + 2 + 3 (CDD Mode) | Test Channel | 38 |
| Model No. | OAW-AP1362 | | |
| Remark: | 1. Average measurement was not performed if peak level lower than average limit. 2. Other frequency was 20dB below limit line within 1-18GHz, there is not show in the report. | | |

| Mark | Frequency (MHz) | Reading Level (dBμV) | Factor (dB) | Measure Level (dBμV/m) | Limit (dBμV/m) | Margin (dB) | Detector | Polarization |
|------|-----------------|----------------------|-------------|------------------------|----------------|-------------|----------|--------------|
| * | 9814.5 | 31.0 | 15.0 | 46.0 | 68.2 | -22.2 | Peak | Horizontal |
| * | 10290.5 | 31.8 | 16.2 | 48.0 | 68.2 | -20.2 | Peak | Horizontal |
| | 11531.5 | 30.6 | 19.7 | 50.3 | 74.0 | -23.7 | Peak | Horizontal |
| | 12126.5 | 30.5 | 20.0 | 50.5 | 74.0 | -23.5 | Peak | Horizontal |
| * | 9780.5 | 32.0 | 14.9 | 46.9 | 68.2 | -21.3 | Peak | Vertical |
| * | 10137.5 | 32.4 | 15.0 | 47.4 | 68.2 | -20.8 | Peak | Vertical |
| | 11081.0 | 30.6 | 18.3 | 48.9 | 74.0 | -25.1 | Peak | Vertical |
| | 11633.5 | 30.6 | 19.6 | 50.2 | 74.0 | -23.8 | Peak | Vertical |

Note 1: "*" is not in restricted band, its limit is -27dBm/MHz. At a distance of 3 meters, the field strength limit in dBμV/m can be determined by adding a "conversion" factor of 95.2dB to the EIRP limit of -27dBm/MHz to obtain the limit for out of band spurious emissions.

Note 2: Measure Level (dBμV/m) = Reading Level (dBμV) + Factor (dB)

Factor (dB) = Cable Loss (dB) + Antenna Factor (dB/m) - Pre_Amplifier Gain (dB)

| | | | |
|---------------|---|-------------------|-------------------------|
| Product | OmniAccess Stellar | Temperature | 22 ~ 26°C |
| Test Engineer | David Lv | Relative Humidity | 44 ~ 57 % |
| Test Site | AC1 | Test Date | 2019/11/26 ~ 2020/02/24 |
| Test Mode | 802.11ax-HE40 - Ant 0 + 1 + 2 + 3 (CDD Mode) | Test Channel | 46 |
| Model No. | OAW-AP1362 | | |
| Remark: | 1. Average measurement was not performed if peak level lower than average limit. 2. Other frequency was 20dB below limit line within 1-18GHz, there is not show in the report. | | |

| Mark | Frequency (MHz) | Reading Level (dBμV) | Factor (dB) | Measure Level (dBμV/m) | Limit (dBμV/m) | Margin (dB) | Detector | Polarization |
|------|-----------------|----------------------|-------------|------------------------|----------------|-------------|----------|--------------|
| * | 9891.0 | 31.5 | 15.4 | 46.9 | 68.2 | -21.3 | Peak | Horizontal |
| * | 10248.0 | 31.7 | 16.2 | 47.9 | 68.2 | -20.3 | Peak | Horizontal |
| | 11548.5 | 29.9 | 19.9 | 49.8 | 74.0 | -24.2 | Peak | Horizontal |
| | 12160.5 | 30.5 | 20.2 | 50.7 | 74.0 | -23.3 | Peak | Horizontal |
| * | 9789.0 | 31.6 | 14.8 | 46.4 | 68.2 | -21.8 | Peak | Vertical |
| * | 10239.5 | 31.7 | 15.9 | 47.6 | 68.2 | -20.6 | Peak | Vertical |
| | 10860.0 | 31.3 | 17.8 | 49.1 | 74.0 | -24.9 | Peak | Vertical |
| | 11540.0 | 30.6 | 20.3 | 50.9 | 74.0 | -23.1 | Peak | Vertical |

Note 1: "*" is not in restricted band, its limit is -27dBm/MHz. At a distance of 3 meters, the field strength limit in dBμV/m can be determined by adding a "conversion" factor of 95.2dB to the EIRP limit of -27dBm/MHz to obtain the limit for out of band spurious emissions.

Note 2: Measure Level (dBμV/m) = Reading Level (dBμV) + Factor (dB)

Factor (dB) = Cable Loss (dB) + Antenna Factor (dB/m) - Pre_Amplifier Gain (dB)

| | | | |
|---------------|---|-------------------|-------------------------|
| Product | OmniAccess Stellar | Temperature | 22 ~ 26°C |
| Test Engineer | David Lv | Relative Humidity | 44 ~ 57 % |
| Test Site | AC1 | Test Date | 2019/11/26 ~ 2020/02/24 |
| Test Mode | 802.11ax-HE40 - Ant 0 + 1 + 2 + 3 (CDD Mode) | Test Channel | 151 |
| Model No. | OAW-AP1362 | | |
| Remark: | 1. Average measurement was not performed if peak level lower than average limit. 2. Other frequency was 20dB below limit line within 1-18GHz, there is not show in the report. | | |

| Mark | Frequency (MHz) | Reading Level (dBμV) | Factor (dB) | Measure Level (dBμV/m) | Limit (dBμV/m) | Margin (dB) | Detector | Polarization |
|------|-----------------|----------------------|-------------|------------------------|----------------|-------------|----------|--------------|
| * | 9772.0 | 33.3 | 14.9 | 48.2 | 68.2 | -20.0 | Peak | Horizontal |
| * | 10316.0 | 31.1 | 16.6 | 47.7 | 68.2 | -20.5 | Peak | Horizontal |
| | 11608.0 | 31.1 | 19.7 | 50.8 | 74.0 | -23.2 | Peak | Horizontal |
| | 12313.5 | 30.4 | 20.1 | 50.5 | 74.0 | -23.5 | Peak | Horizontal |
| * | 9525.5 | 31.6 | 14.5 | 46.1 | 68.2 | -22.1 | Peak | Vertical |
| * | 10103.5 | 32.4 | 14.8 | 47.2 | 68.2 | -21.0 | Peak | Vertical |
| | 11540.0 | 30.0 | 20.3 | 50.3 | 74.0 | -23.7 | Peak | Vertical |
| | 12339.0 | 31.1 | 20.8 | 51.9 | 74.0 | -22.1 | Peak | Vertical |

Note 1: "*" is not in restricted band, its limit is -27dBm/MHz. At a distance of 3 meters, the field strength limit in dBμV/m can be determined by adding a "conversion" factor of 95.2dB to the EIRP limit of -27dBm/MHz to obtain the limit for out of band spurious emissions.

Note 2: Measure Level (dBμV/m) = Reading Level (dBμV) + Factor (dB)

Factor (dB) = Cable Loss (dB) + Antenna Factor (dB/m) - Pre_Amplifier Gain (dB)

| | | | |
|---------------|---|-------------------|-------------------------|
| Product | OmniAccess Stellar | Temperature | 22 ~ 26°C |
| Test Engineer | David Lv | Relative Humidity | 44 ~ 57 % |
| Test Site | AC1 | Test Date | 2019/11/26 ~ 2020/02/24 |
| Test Mode | 802.11ax-HE40 - Ant 0 + 1 + 2 + 3 (CDD Mode) | Test Channel | 159 |
| Model No. | OAW-AP1362 | | |
| Remark: | 1. Average measurement was not performed if peak level lower than average limit. 2. Other frequency was 20dB below limit line within 1-18GHz, there is not show in the report. | | |

| Mark | Frequency (MHz) | Reading Level (dBμV) | Factor (dB) | Measure Level (dBμV/m) | Limit (dBμV/m) | Margin (dB) | Detector | Polarization |
|------|-----------------|----------------------|-------------|------------------------|----------------|-------------|----------|--------------|
| * | 9721.0 | 32.2 | 14.6 | 46.8 | 68.2 | -21.4 | Peak | Horizontal |
| * | 10316.0 | 32.0 | 16.6 | 48.6 | 68.2 | -19.6 | Peak | Horizontal |
| | 11548.5 | 30.6 | 19.9 | 50.5 | 74.0 | -23.5 | Peak | Horizontal |
| | 12237.0 | 29.4 | 20.8 | 50.2 | 74.0 | -23.8 | Peak | Horizontal |
| * | 9746.5 | 31.9 | 14.9 | 46.8 | 68.2 | -21.4 | Peak | Vertical |
| * | 10375.5 | 31.5 | 16.5 | 48.0 | 68.2 | -20.2 | Peak | Vertical |
| | 11591.0 | 30.4 | 20.1 | 50.5 | 74.0 | -23.5 | Peak | Vertical |
| | 12109.5 | 30.9 | 19.9 | 50.8 | 74.0 | -23.2 | Peak | Vertical |

Note 1: "*" is not in restricted band, its limit is -27dBm/MHz. At a distance of 3 meters, the field strength limit in dBμV/m can be determined by adding a "conversion" factor of 95.2dB to the EIRP limit of -27dBm/MHz to obtain the limit for out of band spurious emissions.

Note 2: Measure Level (dBμV/m) = Reading Level (dBμV) + Factor (dB)

Factor (dB) = Cable Loss (dB) + Antenna Factor (dB/m) - Pre_Amplifier Gain (dB)

| | | | |
|---------------|---|-------------------|-------------------------|
| Product | OmniAccess Stellar | Temperature | 22 ~ 26°C |
| Test Engineer | David Lv | Relative Humidity | 44 ~ 57 % |
| Test Site | AC1 | Test Date | 2019/11/26 ~ 2020/02/24 |
| Test Mode | 802.11ax-HE80 - Ant 0 + 1 + 2 + 3 (CDD Mode) | Test Channel | 42 |
| Model No. | OAW-AP1362 | | |
| Remark: | 1. Average measurement was not performed if peak level lower than average limit. 2. Other frequency was 20dB below limit line within 1-18GHz, there is not show in the report. | | |

| Mark | Frequency (MHz) | Reading Level (dBμV) | Factor (dB) | Measure Level (dBμV/m) | Limit (dBμV/m) | Margin (dB) | Detector | Polarization |
|------|-----------------|----------------------|-------------|------------------------|----------------|-------------|----------|--------------|
| * | 9695.5 | 32.4 | 14.6 | 47.0 | 68.2 | -21.2 | Peak | Horizontal |
| * | 10171.5 | 31.8 | 15.3 | 47.1 | 68.2 | -21.1 | Peak | Horizontal |
| | 11047.0 | 30.8 | 18.7 | 49.5 | 74.0 | -24.5 | Peak | Horizontal |
| | 12101.0 | 31.9 | 20.1 | 52.0 | 74.0 | -22.0 | Peak | Horizontal |
| * | 9746.5 | 32.6 | 14.9 | 47.5 | 68.2 | -20.7 | Peak | Vertical |
| * | 10248.0 | 31.6 | 16.2 | 47.8 | 68.2 | -20.4 | Peak | Vertical |
| | 11591.0 | 30.5 | 20.1 | 50.6 | 74.0 | -23.4 | Peak | Vertical |
| | 12126.5 | 30.5 | 20.0 | 50.5 | 74.0 | -23.5 | Peak | Vertical |

Note 1: "*" is not in restricted band, its limit is -27dBm/MHz. At a distance of 3 meters, the field strength limit in dBμV/m can be determined by adding a "conversion" factor of 95.2dB to the EIRP limit of -27dBm/MHz to obtain the limit for out of band spurious emissions.

Note 2: Measure Level (dBμV/m) = Reading Level (dBμV) + Factor (dB)

Factor (dB) = Cable Loss (dB) + Antenna Factor (dB/m) - Pre_Amplifier Gain (dB)

| | | | |
|---------------|---|-------------------|-------------------------|
| Product | OmniAccess Stellar | Temperature | 22 ~ 26°C |
| Test Engineer | David Lv | Relative Humidity | 44 ~ 57 % |
| Test Site | AC1 | Test Date | 2019/11/26 ~ 2020/02/24 |
| Test Mode | 802.11ax-HE80 - Ant 0 + 1 + 2 + 3 (CDD Mode) | Test Channel | 155 |
| Model No. | OAW-AP1362 | | |
| Remark: | 1. Average measurement was not performed if peak level lower than average limit. 2. Other frequency was 20dB below limit line within 1-18GHz, there is not show in the report. | | |

| Mark | Frequency (MHz) | Reading Level (dBμV) | Factor (dB) | Measure Level (dBμV/m) | Limit (dBμV/m) | Margin (dB) | Detector | Polarization |
|------|-----------------|----------------------|-------------|------------------------|----------------|-------------|----------|--------------|
| * | 9789.0 | 32.4 | 14.8 | 47.2 | 68.2 | -21.0 | Peak | Horizontal |
| * | 10324.5 | 31.1 | 16.5 | 47.6 | 68.2 | -20.6 | Peak | Horizontal |
| | 10962.0 | 30.8 | 17.8 | 48.6 | 74.0 | -25.4 | Peak | Horizontal |
| | 11676.0 | 30.7 | 19.6 | 50.3 | 74.0 | -23.7 | Peak | Horizontal |
| * | 9644.5 | 32.6 | 14.3 | 46.9 | 68.2 | -21.3 | Peak | Vertical |
| * | 10273.5 | 31.2 | 16.1 | 47.3 | 68.2 | -20.9 | Peak | Vertical |
| | 11565.5 | 31.7 | 19.5 | 51.2 | 74.0 | -22.8 | Peak | Vertical |
| | 12075.5 | 30.0 | 19.9 | 49.9 | 74.0 | -24.1 | Peak | Vertical |

Note 1: "*" is not in restricted band, its limit is -27dBm/MHz. At a distance of 3 meters, the field strength limit in dBμV/m can be determined by adding a "conversion" factor of 95.2dB to the EIRP limit of -27dBm/MHz to obtain the limit for out of band spurious emissions.

Note 2: Measure Level (dBμV/m) = Reading Level (dBμV) + Factor (dB)

Factor (dB) = Cable Loss (dB) + Antenna Factor (dB/m) - Pre_Amplifier Gain (dB)

| | | | |
|---------------|---|-------------------|-------------------------|
| Product | OmniAccess Stellar | Temperature | 22 ~ 26°C |
| Test Engineer | David Lv | Relative Humidity | 44 ~ 57 % |
| Test Site | AC1 | Test Date | 2019/11/26 ~ 2020/02/24 |
| Test Mode: | 802.11a | Test Channel: | 36 |
| Model No. | OAW-AP1362 – Scan Antenna | | |
| Remark: | 1. Average measurement was not performed if peak level lower than average limit. 2. Other frequency was 20dB below limit line within 1-18GHz, there is not show in the report. | | |

| Mark | Frequency (MHz) | Reading Level (dBμV) | Factor (dB) | Measure Level (dBμV/m) | Limit (dBμV/m) | Margin (dB) | Detector | Polarization |
|------|-----------------|----------------------|-------------|------------------------|----------------|-------------|----------|--------------|
| * | 7188.0 | 32.6 | 11.9 | 44.5 | 68.2 | -23.7 | Peak | Horizontal |
| * | 7817.0 | 32.3 | 11.9 | 44.2 | 68.2 | -24.0 | Peak | Horizontal |
| | 8140.0 | 32.5 | 12.4 | 44.9 | 74.0 | -29.1 | Peak | Horizontal |
| | 9100.5 | 31.4 | 14.5 | 45.9 | 74.0 | -28.1 | Peak | Horizontal |
| * | 7171.0 | 34.0 | 11.8 | 45.8 | 68.2 | -22.4 | Peak | Vertical |
| * | 7885.0 | 32.5 | 11.8 | 44.3 | 68.2 | -23.9 | Peak | Vertical |
| | 8429.0 | 30.4 | 12.4 | 42.8 | 74.0 | -31.2 | Peak | Vertical |
| | 9075.0 | 30.1 | 14.4 | 44.5 | 74.0 | -29.5 | Peak | Vertical |

Note 1: "*" is not in restricted band, its limit is -27dBm/MHz. At a distance of 3 meters, the field strength limit in dBμV/m can be determined by adding a "conversion" factor of 95.2dB to the EIRP limit of -27dBm/MHz to obtain the limit for out of band spurious emissions.

Note 2: Measure Level (dBμV/m) = Reading Level (dBμV) + Factor (dB)

Factor (dB) = Cable Loss (dB) + Antenna Factor (dB/m) - Pre_Amplifier Gain (dB)

| | | | |
|---------------|---|-------------------|-------------------------|
| Product | OmniAccess Stellar | Temperature | 22 ~ 26°C |
| Test Engineer | David Lv | Relative Humidity | 44 ~ 57 % |
| Test Site | AC1 | Test Date | 2019/11/26 ~ 2020/02/24 |
| Test Mode | 802.11a | Test Channel | 44 |
| Model No. | OAW-AP1362 – Scan Antenna | | |
| Remark: | 1. Average measurement was not performed if peak level lower than average limit. 2. Other frequency was 20dB below limit line within 1-18GHz, there is not show in the report. | | |

| Mark | Frequency (MHz) | Reading Level (dBμV) | Factor (dB) | Measure Level (dBμV/m) | Limit (dBμV/m) | Margin (dB) | Detector | Polarization |
|------|-----------------|----------------------|-------------|------------------------|----------------|-------------|----------|--------------|
| * | 7026.5 | 32.8 | 10.8 | 43.6 | 68.2 | -24.6 | Peak | Horizontal |
| * | 7817.0 | 33.6 | 11.9 | 45.5 | 68.2 | -22.7 | Peak | Horizontal |
| | 8395.0 | 31.6 | 12.4 | 44.0 | 74.0 | -30.0 | Peak | Horizontal |
| | 9032.5 | 29.2 | 14.4 | 43.6 | 74.0 | -30.4 | Peak | Horizontal |
| * | 7188.0 | 33.0 | 11.9 | 44.9 | 68.2 | -23.3 | Peak | Vertical |
| * | 7825.5 | 32.2 | 11.9 | 44.1 | 68.2 | -24.1 | Peak | Vertical |
| | 8437.5 | 32.8 | 12.4 | 45.2 | 74.0 | -28.8 | Peak | Vertical |
| | 9024.0 | 31.1 | 14.7 | 45.8 | 74.0 | -28.2 | Peak | Vertical |

Note 1: "*" is not in restricted band, its limit is -27dBm/MHz. At a distance of 3 meters, the field strength limit in dBμV/m can be determined by adding a "conversion" factor of 95.2dB to the EIRP limit of -27dBm/MHz to obtain the limit for out of band spurious emissions.

Note 2: Measure Level (dBμV/m) = Reading Level (dBμV) + Factor (dB)

Factor (dB) = Cable Loss (dB) + Antenna Factor (dB/m) - Pre_Amplifier Gain (dB)

| | | | |
|---------------|---|-------------------|-------------------------|
| Product | OmniAccess Stellar | Temperature | 22 ~ 26°C |
| Test Engineer | David Lv | Relative Humidity | 44 ~ 57 % |
| Test Site | AC1 | Test Date | 2019/11/26 ~ 2020/02/24 |
| Test Mode | 802.11a | Test Channel | 48 |
| Model No. | OAW-AP1362 – Scan Antenna | | |
| Remark: | 1. Average measurement was not performed if peak level lower than average limit. 2. Other frequency was 20dB below limit line within 1-18GHz, there is not show in the report. | | |

| Mark | Frequency (MHz) | Reading Level (dBμV) | Factor (dB) | Measure Level (dBμV/m) | Limit (dBμV/m) | Margin (dB) | Detector | Polarization |
|------|-----------------|----------------------|-------------|------------------------|----------------|-------------|----------|--------------|
| * | 7205.0 | 32.2 | 12.2 | 44.4 | 68.2 | -23.8 | Peak | Horizontal |
| * | 7876.5 | 32.6 | 11.9 | 44.5 | 68.2 | -23.7 | Peak | Horizontal |
| | 8318.5 | 32.6 | 12.2 | 44.8 | 74.0 | -29.2 | Peak | Horizontal |
| | 9049.5 | 31.0 | 14.2 | 45.2 | 74.0 | -28.8 | Peak | Horizontal |
| * | 7171.0 | 33.1 | 11.8 | 44.9 | 68.2 | -23.3 | Peak | Vertical |
| * | 7944.5 | 32.7 | 12.2 | 44.9 | 68.2 | -23.3 | Peak | Vertical |
| | 8429.0 | 30.8 | 12.4 | 43.2 | 74.0 | -30.8 | Peak | Vertical |
| | 9058.0 | 30.2 | 14.3 | 44.5 | 74.0 | -29.5 | Peak | Vertical |

Note 1: "*" is not in restricted band, its limit is -27dBm/MHz. At a distance of 3 meters, the field strength limit in dBμV/m can be determined by adding a "conversion" factor of 95.2dB to the EIRP limit of -27dBm/MHz to obtain the limit for out of band spurious emissions.

Note 2: Measure Level (dBμV/m) = Reading Level (dBμV) + Factor (dB)

Factor (dB) = Cable Loss (dB) + Antenna Factor (dB/m) - Pre_Amplifier Gain (dB)

| | | | |
|---------------|---|-------------------|-------------------------|
| Product | OmniAccess Stellar | Temperature | 22 ~ 26°C |
| Test Engineer | David Lv | Relative Humidity | 44 ~ 57 % |
| Test Site | AC1 | Test Date | 2019/11/26 ~ 2020/02/24 |
| Test Mode | 802.11a | Test Channel | 149 |
| Model No. | OAW-AP1362 – Scan Antenna | | |
| Remark: | 1. Average measurement was not performed if peak level lower than average limit. 2. Other frequency was 20dB below limit line within 1-18GHz, there is not show in the report. | | |

| Mark | Frequency (MHz) | Reading Level (dBμV) | Factor (dB) | Measure Level (dBμV/m) | Limit (dBμV/m) | Margin (dB) | Detector | Polarization |
|------|-----------------|----------------------|-------------|------------------------|----------------|-------------|----------|--------------|
| * | 6525.0 | 32.3 | 8.7 | 41.0 | 68.2 | -27.2 | Peak | Horizontal |
| * | 6856.5 | 33.1 | 9.9 | 43.0 | 68.2 | -25.2 | Peak | Horizontal |
| | 7256.0 | 32.6 | 11.8 | 44.4 | 74.0 | -29.6 | Peak | Horizontal |
| | 8293.0 | 31.2 | 12.2 | 43.4 | 74.0 | -30.6 | Peak | Horizontal |
| * | 7179.5 | 32.5 | 11.9 | 44.4 | 68.2 | -23.8 | Peak | Vertical |
| * | 7944.5 | 33.4 | 12.2 | 45.6 | 68.2 | -22.6 | Peak | Vertical |
| | 8310.0 | 30.3 | 12.1 | 42.4 | 74.0 | -31.6 | Peak | Vertical |
| | 9092.0 | 29.7 | 14.5 | 44.2 | 74.0 | -29.8 | Peak | Vertical |

Note 1: "*" is not in restricted band, its limit is -27dBm/MHz. At a distance of 3 meters, the field strength limit in dBμV/m can be determined by adding a "conversion" factor of 95.2dB to the EIRP limit of -27dBm/MHz to obtain the limit for out of band spurious emissions.

Note 2: Measure Level (dBμV/m) = Reading Level (dBμV) + Factor (dB)

Factor (dB) = Cable Loss (dB) + Antenna Factor (dB/m) - Pre_Amplifier Gain (dB)

| | | | |
|---------------|---|-------------------|-------------------------|
| Product | OmniAccess Stellar | Temperature | 22 ~ 26°C |
| Test Engineer | David Lv | Relative Humidity | 44 ~ 57 % |
| Test Site | AC1 | Test Date | 2019/11/26 ~ 2020/02/24 |
| Test Mode | 802.11a | Test Channel | 157 |
| Model No. | OAW-AP1362 – Scan Antenna | | |
| Remark: | 1. Average measurement was not performed if peak level lower than average limit. 2. Other frequency was 20dB below limit line within 1-18GHz, there is not show in the report. | | |

| Mark | Frequency (MHz) | Reading Level (dBμV) | Factor (dB) | Measure Level (dBμV/m) | Limit (dBμV/m) | Margin (dB) | Detector | Polarization |
|------|-----------------|----------------------|-------------|------------------------|----------------|-------------|----------|--------------|
| * | 7171.0 | 32.9 | 11.8 | 44.7 | 68.2 | -23.5 | Peak | Horizontal |
| * | 7944.5 | 31.4 | 12.2 | 43.6 | 68.2 | -24.6 | Peak | Horizontal |
| | 8412.0 | 32.5 | 12.4 | 44.9 | 74.0 | -29.1 | Peak | Horizontal |
| | 9092.0 | 30.5 | 14.5 | 45.0 | 74.0 | -29.0 | Peak | Horizontal |
| * | 7086.0 | 31.5 | 11.9 | 43.4 | 68.2 | -24.8 | Peak | Vertical |
| * | 7842.5 | 33.6 | 11.9 | 45.5 | 68.2 | -22.7 | Peak | Vertical |
| | 8199.5 | 29.7 | 12.3 | 42.0 | 74.0 | -32.0 | Peak | Vertical |
| | 9092.0 | 29.8 | 14.5 | 44.3 | 74.0 | -29.7 | Peak | Vertical |

Note 1: "*" is not in restricted band, its limit is -27dBm/MHz. At a distance of 3 meters, the field strength limit in dBμV/m can be determined by adding a "conversion" factor of 95.2dB to the EIRP limit of -27dBm/MHz to obtain the limit for out of band spurious emissions.

Note 2: Measure Level (dBμV/m) = Reading Level (dBμV) + Factor (dB)

Factor (dB) = Cable Loss (dB) + Antenna Factor (dB/m) - Pre_Amplifier Gain (dB)

| | | | |
|---------------|---|-------------------|-------------------------|
| Product | OmniAccess Stellar | Temperature | 22 ~ 26°C |
| Test Engineer | David Lv | Relative Humidity | 44 ~ 57 % |
| Test Site | AC1 | Test Date | 2019/11/26 ~ 2020/02/24 |
| Test Mode | 802.11a | Test Channel | 165 |
| Model No. | OAW-AP1362 – Scan Antenna | | |
| Remark: | 1. Average measurement was not performed if peak level lower than average limit. 2. Other frequency was 20dB below limit line within 1-18GHz, there is not show in the report. | | |

| Mark | Frequency (MHz) | Reading Level (dBμV) | Factor (dB) | Measure Level (dBμV/m) | Limit (dBμV/m) | Margin (dB) | Detector | Polarization |
|------|-----------------|----------------------|-------------|------------------------|----------------|-------------|----------|--------------|
| * | 7145.5 | 32.6 | 11.6 | 44.2 | 68.2 | -24.0 | Peak | Horizontal |
| * | 7842.5 | 32.9 | 11.9 | 44.8 | 68.2 | -23.4 | Peak | Horizontal |
| | 8250.5 | 30.5 | 12.4 | 42.9 | 74.0 | -31.1 | Peak | Horizontal |
| | 9083.5 | 30.5 | 14.4 | 44.9 | 74.0 | -29.1 | Peak | Horizontal |
| * | 7162.5 | 32.2 | 11.7 | 43.9 | 68.2 | -24.3 | Peak | Vertical |
| * | 7936.0 | 32.7 | 12.2 | 44.9 | 68.2 | -23.3 | Peak | Vertical |
| | 8310.0 | 30.4 | 12.1 | 42.5 | 74.0 | -31.5 | Peak | Vertical |
| | 9092.0 | 31.2 | 14.5 | 45.7 | 74.0 | -28.3 | Peak | Vertical |

Note 1: "*" is not in restricted band, its limit is -27dBm/MHz. At a distance of 3 meters, the field strength limit in dBμV/m can be determined by adding a "conversion" factor of 95.2dB to the EIRP limit of -27dBm/MHz to obtain the limit for out of band spurious emissions.

Note 2: Measure Level (dBμV/m) = Reading Level (dBμV) + Factor (dB)

Factor (dB) = Cable Loss (dB) + Antenna Factor (dB/m) - Pre_Amplifier Gain (dB)