

# MEASUREMENT REPORT

## FCC PART 15.247 / Bluetooth-LE

---

**FCC ID:** 2AI9TOAW-AP133X  
**Applicant:** ALE USA Inc.  
**Application Type:** Certification  
**Product:** OmniAccess Stellar  
**Model No.:** OAW-AP1331  
**Brand Name:** Alcatel-Lucent Enterprise  
**FCC Classification:** Digital Transmission System (DTS)  
**FCC Rule Part(s):** Part15 Subpart C (Section 15.247)  
**Test Procedure(s):** ANSI C63.10-2013  
**Test Date:** September 29 ~ November 13, 2021

Reviewed By:

*Paddy Chen*

( Paddy Chen )

Approved By:

*Chenz Ker*

( Chenz Ker )



Testing Laboratory  
3261

The test results relate only to the samples tested.

This equipment has been shown to be capable of compliance with the applicable technical standards as indicated in the measurement report and was tested in accordance with the measurement procedures specified in ANSI C63.10-2013. Test results reported herein relate only to the item(s) tested.

The test report shall not be reproduced except in full without the written approval of MRT Technology (Taiwan) Co., Ltd.

---

## Revision History

Report No.	Version	Description	Issue Date	Note
2108TW0004-U1	V1.0	Initial Report	11-30-2021	Valid

---

## CONTENTS

Description	Page
<b>1. INTRODUCTION .....</b>	<b>6</b>
1.1. Scope .....	6
1.2. MRT Test Location .....	6
<b>2. PRODUCT INFORMATION .....</b>	<b>7</b>
2.1. Equipment Description .....	7
2.2. Product Specification Subjective to this Report.....	7
2.3. Working Frequencies for this Report.....	8
2.4. Description of Available Antennas .....	9
2.5. Duty Cycle .....	10
2.6. Description of Test Configuration and Software.....	11
2.7. EMI Suppression Device(s)/Modifications .....	11
2.8. Labeling Requirements.....	11
<b>3. DESCRIPTION OF TEST .....</b>	<b>12</b>
3.1. Measurement Procedure.....	12
3.2. AC Line Conducted Emissions.....	12
3.3. Radiated Emissions.....	13
<b>4. ANTENNA REQUIREMENTS .....</b>	<b>14</b>
<b>5. TEST EQUIPMENT CALIBRATION DATE .....</b>	<b>15</b>
<b>6. MEASUREMENT UNCERTAINTY .....</b>	<b>17</b>
<b>7. TEST RESULT.....</b>	<b>18</b>
7.1. Summary .....	18
7.2. 6dB Bandwidth Measurement .....	19
7.2.1. Test Limit.....	19
7.2.2. Test Procedure used .....	19
7.2.3. Test Setting .....	19
7.2.4. Test Setup .....	19
7.2.5. Test Result .....	20
7.3. Output Power Measurement.....	22
7.3.1. Test Limit.....	22
7.3.2. Test Procedure Used.....	22
7.3.3. Test Setting .....	22
7.3.4. Test Setup .....	23
7.3.5. Test Result .....	24
7.4. Power Spectral Density Measurement .....	25
7.4.1. Test Limit.....	25
7.4.2. Test Procedure Used.....	25
7.4.3. Test Setting .....	25

---

7.4.4. Test Setup .....	25
7.4.5. Test Result .....	26
7.5. Conducted Band Edge and Out-of-Band Emissions .....	28
7.5.1. Test Limit .....	28
7.5.2. Test Procedure Used.....	28
7.5.3. Test Settintg .....	28
7.5.4. Test Setup .....	29
7.5.5. Test Result .....	30
7.6. Radiated Spurious Emission Measurement .....	33
7.6.1. Test Limit .....	33
7.6.2. Test Procedure Used.....	33
7.6.3. Test Setting .....	33
7.6.4. Test Setup .....	35
7.6.5. Test Result .....	36
7.7. Radiated Restricted Band Edge Measurement .....	48
7.7.1. Test Limit .....	50
7.7.2. Test Procedure Used.....	51
7.7.3. Test Setting .....	51
7.7.4. Test Setup .....	52
7.7.5. Test Result .....	53
7.8. AC Conducted Emissions Measurement.....	64
7.8.1. Test Limit .....	64
7.8.2. Test Setup .....	64
7.8.3. Test Result .....	65
<b>8. CONCLUSION.....</b>	<b>67</b>
<b>Appendix A - Test Setup Photograph.....</b>	<b>68</b>
<b>Appendix B - EUT Photograph .....</b>	<b>69</b>

## General Information

<b>Applicant</b>	ALE USA Inc.
<b>Applicant Address</b>	26801 West Agoura Road, Calabasas, CA 91301, United States
<b>Manufacturer</b>	ALE USA Inc.
<b>Manufacturer Address</b>	26801 West Agoura Road, Calabasas, CA 91301, United States
<b>Test Site</b>	MRT Technology (Taiwan) Co., Ltd
<b>Test Site Address</b>	No. 38, Fuxing Second Rd., Guishan Dist., Taoyuan City 333, Taiwan (R.O.C)
<b>MRT FCC Registration No.</b>	291082
<b>FCC Rule Part(s)</b>	Part 15.247

### Test Facility / Accreditations

1. MRT facility is a FCC registered (Reg. No. 291082) test facility with the site description report on file and is designated by the FCC as an Accredited Test Firm.
2. MRT facility is an IC registered (MRT Reg. No. 21723) test laboratory with the site description on file at Industry Canada.
3. MRT Lab is accredited to ISO 17025 by the Taiwan Accreditation Foundation (TAF Cert. No. 3261) in EMC, Telecommunications and Radio testing for FCC (Designation Number: TW3261), Industry Taiwan, EU and TELEC Rules.

## 1. INTRODUCTION

### 1.1. Scope

Measurement and determination of electromagnetic emissions (EMC) of radio frequency devices including intentional and/or unintentional radiators for compliance with the technical rules and regulations of the Federal Communications Commission and the Innovation, Science and Economic Development Canada and Certification and Engineering Bureau.

### 1.2. MRT Test Location

The map below shows the location of the MRT LABORATORY, its proximity to the Taoyuan City. These measurement tests were conducted at the MRT Technology (Taiwan) Co., Ltd. Facility located at No.38, Fuxing 2nd Rd., Guishan Dist., Taoyuan City 33377, Taiwan (R.O.C).

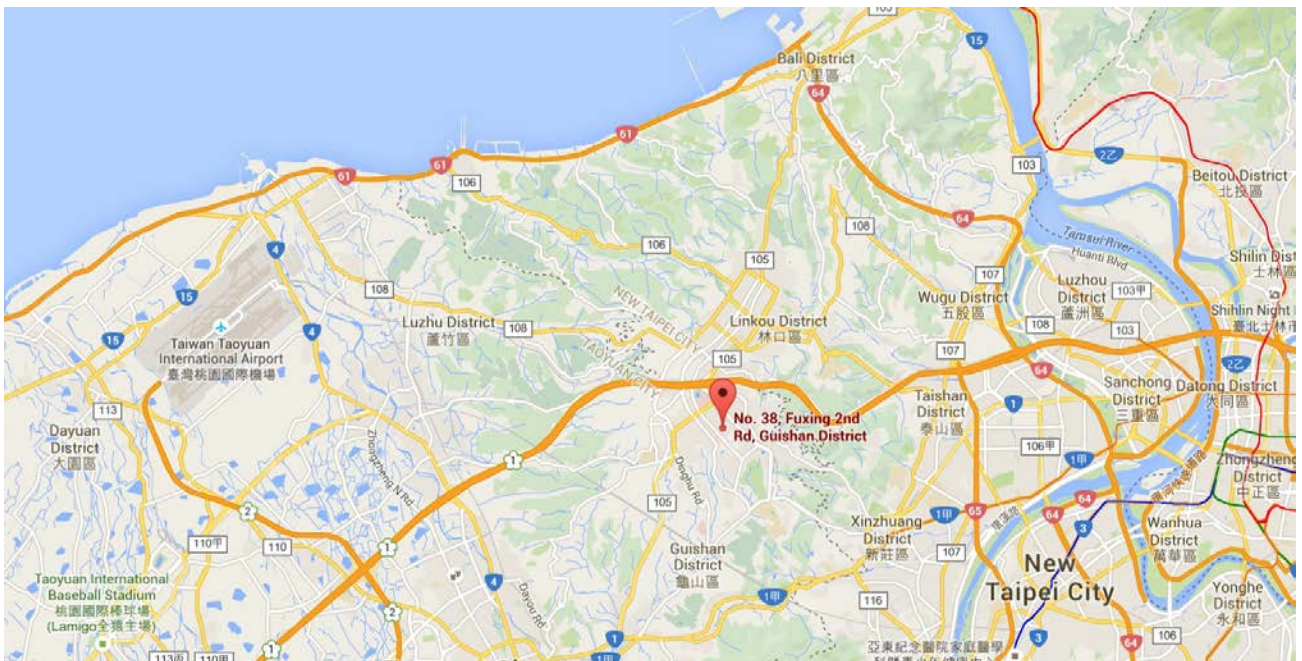

## 2. PRODUCT INFORMATION

### 2.1. Equipment Description

Product Name	OmniAccess Stellar
Model No.	OAW-AP1331
Wi-Fi Specification	802.11a/b/g/n/ac/ax
Bluetooth Specification	v5.0 single mode, BLE only
Operating Temperature	-10 ~ 50 °C
Power Type	AC Power Adapter or PoE Injector Input
EUT Identification No.:	20210827Sample#07 (Conducted) 20210827Sample#04 (Radiated & AC conducted emission)
Operating Environment	Indoor Use
Antenna Information	Refer to Section 2.4

Note: The information shown above was provided by manufacturer, and the accuracy of the information shall be the responsibility of the manufacturer.

### 2.2. Product Specification Subjective to this Report

Bluetooth Frequency	2402 ~ 2480MHz
Bluetooth Version	v5.0 single mode, BLE only
Type of modulation	GFSK
Data Rate	1Mbps & 2Mbps

Note: For other features of this EUT, test reports will be issued separately.

### 2.3. Working Frequencies for this Report

Channel	Frequency	Channel	Frequency	Channel	Frequency
00	2402 MHz	01	2404 MHz	02	2406 MHz
03	2408 MHz	04	2410 MHz	05	2412 MHz
06	2414 MHz	07	2416 MHz	08	2418 MHz
09	2420 MHz	10	2422 MHz	11	2424 MHz
12	2426 MHz	13	2428 MHz	14	2430 MHz
15	2432 MHz	16	2434 MHz	17	2436 MHz
18	2438 MHz	19	2440 MHz	20	2442 MHz
21	2444 MHz	22	2446 MHz	23	2448 MHz
24	2450 MHz	25	2452 MHz	26	2454 MHz
27	2456 MHz	28	2458 MHz	29	2460 MHz
30	2462 MHz	31	2464 MHz	32	2466 MHz
33	2468 MHz	34	2470 MHz	35	2472 MHz
36	2474 MHz	37	2476 MHz	38	2478 MHz
39	2480 MHz	--	--	--	--



## 2.4. Description of Available Antennas

Antenna Type	Frequency Band (GHz)	Max Peak Gain (dBi)	CDD Directional Gain (dBi)		BF Directional Gain (dBi)
			For Power	For PSD	
Wi-Fi Antenna (4*4 MIMO)					
PIFA	2.4 ~ 2.5	3.90	3.90	9.92	9.92
	5.15 ~ 5.25	4.50	4.50	10.52	10.52
	5.25 ~ 5.35	4.50	4.50	10.52	10.52
	5.47 ~ 5.725	4.60	4.60	10.62	10.62
	5.725 ~ 5.85	4.50	4.50	10.52	10.52
Scan Antenna					
PIFA	2.4 ~ 2.5	3.50	--	--	--
	5.15 ~ 5.25	4.30	--	--	--
	5.725 ~ 5.85	4.50	--	--	--
Bluetooth Antenna					
PIFA	2.4 ~ 2.5	3.70	--	--	--

Note:

- The EUT supports Cyclic Delay Diversity (CDD) mode, and CDD signals are correlated. For CDD transmissions, directional gain is calculated as follows,  $N_{ANT} = 4$ ,  $N_{SS} = 1$ . If all antennas have the same gain,  $G_{ANT}$ , Directional gain =  $G_{ANT} + \text{Array Gain}$ , where Array Gain is as follows.
  - For power spectral density (PSD) measurements on all devices,
 
$$\text{Array Gain} = 10 \log (N_{ANT} / N_{SS}) \text{ dB} = 6.02;$$
  - For power measurements on IEEE 802.11 devices,
 
$$\text{Array Gain} = 0 \text{ dB for } N_{ANT} \leq 4;$$
- The EUT also supports Beam Forming mode, and the Beam Forming support 802.11n/ac/ax, not include 802.11a/b/g. Directional gain =  $G_{ANT} + \text{BF Gain}$ . BF mode power setting will be less than or equal to CDD power setting.

## 2.5. Duty Cycle

The maximum achievable duty cycles were determined based on measurements performed on a spectrum analyzer in zero-span mode with RBW = 8MHz, VBW = 50MHz. The RBW and VBW were both greater than 50/T, where T is the minimum transmission duration, and the number of sweep points across T was greater than 100. The duty cycles are as follows:

Test Mode	Duty Cycle
BLE - 1Mbps	84.93%
BLE - 2Mbps	56.80%

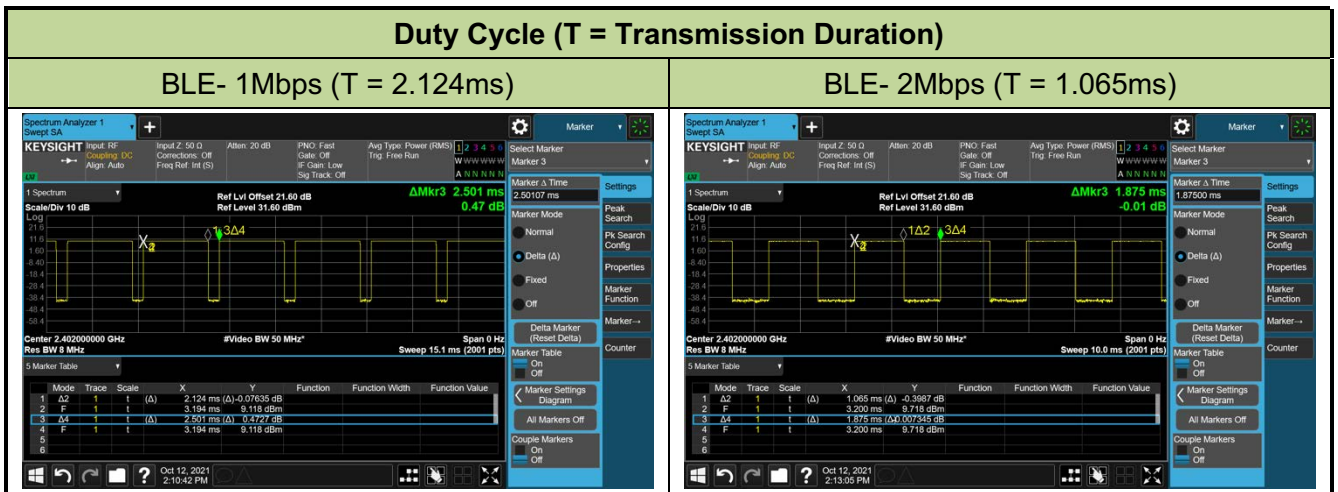

## 2.6. Description of Test Configuration and Software

The device was tested per the guidance ANSI C63.10-2013 was used to reference the appropriate EUT setup for radiated emissions testing and AC line conducted testing.

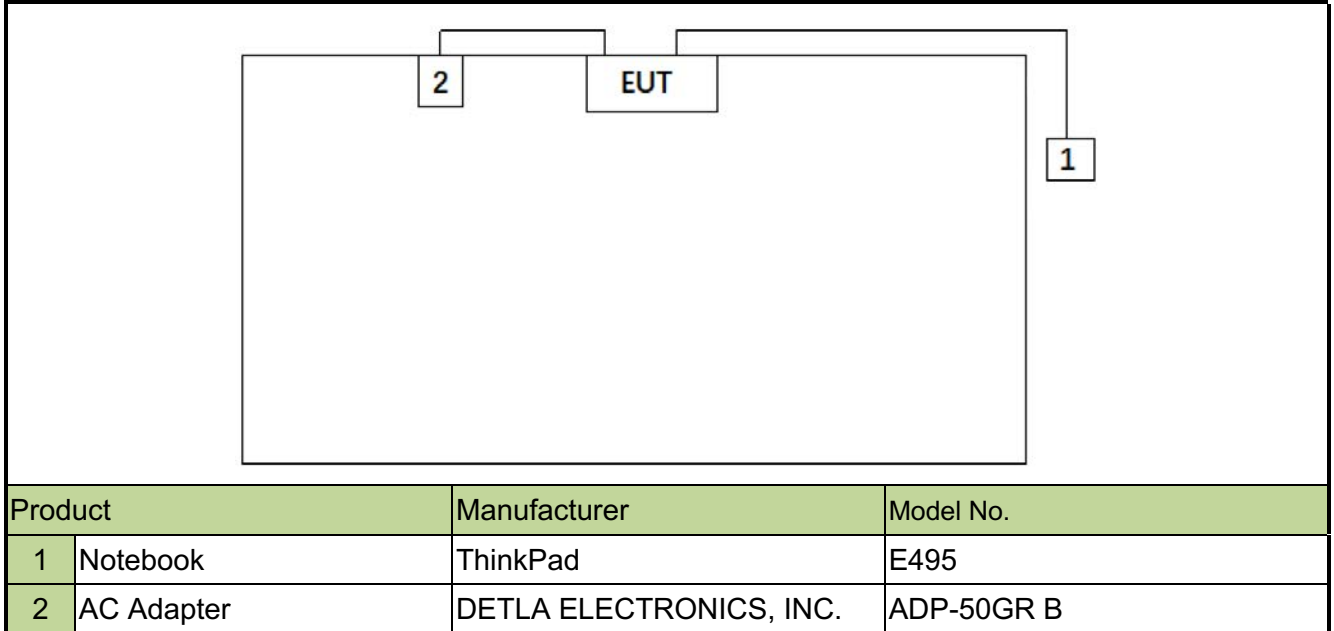

Note 1: The test utility software used during testing was “telnet.exe” and command was provided by the manufacturer.

Note 2: Detail power setting refer to operation description.

## 2.7. EMI Suppression Device(s)/Modifications

No EMI suppression device(s) were added and/or no modifications were made during testing.

## 2.8. Labeling Requirements

Per 2.1074 & 15.19; Docket 95-19

The label shall be permanently affixed at a conspicuous location on the device; instruction manual or pamphlet supplied to the user and be readily visible to the purchaser at the time of purchase.

However, when the device is so small wherein placement of the label with specified statement is not practical, only the FCC ID must be displayed on the device per Section 15.19(a)(5). Please see attachment for FCC ID label and label location.

### **3. DESCRIPTION OF TEST**

#### **3.1. Measurement Procedure**

The measurement procedure described in the document titled “American National Standard of Procedures for Compliance Testing of Unlicensed Wireless Devices” (ANSI C63.10-2013) was used in the measurement.

#### **3.2. AC Line Conducted Emissions**

The line-conducted facility is located inside an 8'x4'x4' shielded enclosure. A 1m x 2m wooden table 80cm high is placed 40cm away from the vertical wall and 80cm away from the sidewall of the shielded room. Two 10kHz-30MHz, 50Ω/50uH Line-Impedance Stabilization Networks (LISNs) are bonded to the shielded room floor. Power to the LISNs is filtered by external high-current high-insertion loss power line filters. These filters attenuate ambient signal noise from entering the measurement lines. These filters are also bonded to the shielded enclosure.

The EUT is powered from one LISN and the support equipment is powered from the second LISN. All interconnecting cables more than 1 meter were shortened to a 1 meter length by non-inductive bundling (serpentine fashion) and draped over the back edge of the test table. All cables were at least 40cm above the horizontal reference ground-plane. Power cables for support equipment were routed down to the second LISN while ensuring that that cables were not draped over the second LISN.

Sufficient time for the EUT, support equipment, and test equipment was allowed in order for them to warm up to their normal operating condition. The RF output of the LISN was connected to the receiver and exploratory measurements were made to determine the frequencies producing the maximum emission from the EUT. The receiver was scanned from 150kHz to 30MHz. The detector function was set to peak mode for exploratory measurements while the bandwidth of the analyzer was set to 9kHz. The EUT, support equipment, and interconnecting cables were arranged and manipulated to maximize each emission. Each emission was also maximized by varying: power lines, the mode of operation or data exchange speed, or support equipment whichever determined the worst-case emission. Once the worst case emissions have been identified, the one EUT cable configuration/arrangement and mode of operation that produced these emissions were used for final measurements on the same test site. The analyzer is set to CISPR quasi-peak and average detectors with a 9kHz resolution bandwidth for final measurements.

An extension cord was used to connect to a single LISN which powered by EUT. The extension cord was calibrated with LISN, the impedance and insertion loss are compliance with the requirements as stated in ANSI C63.10-2013.

### 3.3. Radiated Emissions

The radiated test facilities consisted of an indoor 3 meter semi-anechoic chamber used for final measurements and exploratory measurements, when necessary. The measurement area is contained within the semi-anechoic chamber which is shielded from any ambient interference. For measurements above 1GHz absorbers are arranged on the floor between the turn table and the Antenna mast in such a way so as to maximize the reduction of reflections. For measurements below 1GHz, the absorbers are removed. A MF Model 210SS turntable is used for radiated measurement. It is a continuously rotatable, remote controlled, metallic turntable and 2 meters (6.56 ft.) in diameter. The turn table is flush with the raised floor of the chamber in order to maintain its function as a ground plane. An 80cm high PVC support structure is placed on top of the turntable. For all measurements, the spectrum was scanned through all EUT azimuths and from 1 to 4 meter receive Antenna height using a broadband Antenna from 30MHz up to the upper frequency shown in 15.33(b)(1) depending on the highest frequency generated or used in the device or on which the device operates or tunes. For frequencies above 1GHz, linearly polarized double ridge horn Antennas were used. For frequencies below 30MHz, a calibrated loop Antenna was used. When exploratory measurements were necessary, they were performed at 1 meter test distance inside the semi-anechoic chamber using broadband Antennas, broadband amplifiers, and spectrum analyzers to determine the frequencies and modes producing the maximum emissions. Sufficient time for the EUT, support equipment, and test equipment was allowed in order for them to warm up to their normal operating condition. The test set-up for frequencies below 1GHz was placed on top of the 0.8 meter high, 1 x 1.5 meter table; and test set-up for frequencies 1-40GHz was placed on top of the 1.5 meter high, 1 x 1.5 meter table. The EUT, support equipment, and interconnecting cables were arranged and manipulated to maximize each emission. Appropriate precaution was taken to ensure that all emissions from the EUT were maximized and investigated. The system configuration, clock speed, mode of operation or video resolution, if applicable, turntable azimuth, and receive Antenna height was noted for each frequency found.

Final measurements were made in the semi-anechoic chamber using calibrated, linearly polarized broadband and horn Antennas. The test setup was configured to the setup that produced the worst case emissions. The spectrum analyzer was set to investigate all frequencies required for testing to compare the highest radiated disturbances with respect to the specified limits. The turntable containing the EUT was rotated through 360 degrees and the height of the receive Antenna was varied 1 to 4 meters and stopped at the azimuth and height producing the maximum emission. Each emission was maximized by changing the orientation of the EUT through three orthogonal planes and changing the polarity of the receive Antenna, whichever produced the worst-case emissions. According to 3dB Beam-Width of horn Antenna, the horn Antenna should be always directed to the EUT when rising height.

## 4. ANTENNA REQUIREMENTS

### **Excerpt from §15.203 of the FCC Rules/Regulations:**

“An intentional radiator antenna shall be designed to ensure that no antenna other than that furnished by the responsible party can be used with the device. The use of a permanently attached antenna or of an antenna that uses a unique coupling to the intentional radiator shall be considered sufficient to comply with the provisions of this section.”

- The antenna of the device is **permanently attached**.
- There are no provisions for connection to an external antenna.

### **Conclusion:**

The unit complies with the requirement of §15.203.

## 5. TEST EQUIPMENT CALIBRATION DATE

### Conducted Emissions – SR2

Instrument	Manufacturer	Type No.	Asset No.	Cali. Interval	Cali. Due Date
Two-Line V-Network	R&S	ENV 216	MRTTWA00019	1 year	2022/3/23
Two-Line V-Network	R&S	ENV 216	MRTTWA00020	1 year	2022/4/24
8-Wire ISN (T8)	R&S	ENY81	MRTTWA00018	1 year	2022/5/30
EMI Test Receiver	R&S	ESR3	MRTTWA00045	1 year	2022/5/25
Temperature/Humidity Meter	TFA	35.1083	MRTTWA00050	1 year	2022/6/3

### Radiated Emissions - AC1/AC2

Instrument	Manufacturer	Type No.	Asset No.	Cali. Interval	Cali. Due Date
Active Loop Antenna	SCHWARZBECK	FMZB 1519B	MRTTWA00002	1 year	2022/4/27
Broadband TRILOG Antenna	SCHWARZBECK	VULB 9162	MRTTWA00001	1 year	2022/10/4
Broadband Horn Antenna	SCHWARZBECK	BBHA 9120D	MRTTWA00003	1 year	2022/4/24
Broadband Horn Antenna	RFSPIN	DRH18-E	MRTTWA00087	1 year	2022/6/28
Broadband Horn Antenna	SCHWARZBECK	BBHA 9170	MRTTWA00004	1 year	2022/4/24
Broadband Preamplifier	SCHWARZBECK	BBV 9718	MRTTWA00005	1 year	2022/4/24
Broadband Preamplifier	EMC Instruments corporation	EMC118A45S E	MRTTWA00088	1 year	2022/6/28
Broadband Amplifier	SCHWARZBECK	BBV 9721	MRTTWA00006	1 year	2022/4/24
Signal Analyzer	R&S	FSV40	MRTTWA00007	1 year	2022/3/23
EMI Test Receiver	R&S	ESR3	MRTTWA00009	1 year	2022/3/24
EXA Signal Analyzer	KEYSIGHT	N9010A	MRTTWA00012	1 year	2022/10/18
Antenna Cable	HUBERSUHNER	SF106	MRTTWE00010	1 year	2022/6/28
Cable	Rosnol	K1K50-UP026 4-K1K50-4M	MRTTWE00012	1 year	2022/6/20
Antenna Cable	HUBERSUHNER	SF106	MRTTWE00034	1 year	2022/6/28
Cable	HUBERSUHNER	EMC105-NM- NM-3000	MRTTWE00035	1 year	2022/6/28
Temperature/Humidity Meter	TFA	35.1078.10.IT	MRTTWA00032	1 year	2022/6/6

### Conducted Test Equipment – SR2

Instrument	Manufacturer	Type No.	Asset No.	Cali. Interval	Cali. Due Date
X-Series USB Peak and Average Power Sensor	KEYSIGHT	U2021XA	MRTTWA00014	1 year	2022/4/21
EXA Signal Analyzer	KEYSIGHT	N9010A	MRTTWA00012	1 year	2022/10/18
EXA Signal Analyzer	KEYSIGHT	N9010B	MRTTWA00074	1 year	2022/7/19

Attenuator	WTI	218FS-20	MRTTWE00027	1 year	2022/6/16
Attenuator	WTI	218FS-10	MRTTWE00028	1 year	2022/6/16
Attenuator	WTI	218FS-06	MRTTWE00029	1 year	2022/6/16
Temperature/Humidity Meter	TFA	35.1083	MRTTWA00050	1 year	2022/6/3

Software	Version	Function
e3	9.160520a	EMI Test Software



## 6. MEASUREMENT UNCERTAINTY

Where relevant, the following test uncertainty levels have been estimated for tests performed on the EUT as specified in CISPR 16-4-2. This uncertainty represents an expanded uncertainty expressed at approximately the 95% confidence level using a coverage factor of  $k = 2$ .

<b>AC Conducted Emission Measurement</b>
Measuring Uncertainty for a Level of Confidence of 95% ( $U=2Uc(y)$ ): 150kHz~30MHz: 2.53dB
<b>Radiated Emission Measurement</b>
Measuring Uncertainty for a Level of Confidence of 95% ( $U=2Uc(y)$ ): 9kHz ~ 1GHz: 4.25dB 1GHz ~ 40GHz: 4.45dB
<b>Conducted Power</b>
Measuring Uncertainty for a Level of Confidence of 95% ( $U=2Uc(y)$ ): $\pm 0.84$ dB
<b>Conducted Spurious Emission</b>
Measuring Uncertainty for a Level of Confidence of 95% ( $U=2Uc(y)$ ): $\pm 2.65$ dB
<b>Occupied Bandwidth</b>
Measuring Uncertainty for a Level of Confidence of 95% ( $U=2Uc(y)$ ): 3.3%
<b>Temp. / Humidity</b>
Measuring Uncertainty for a Level of Confidence of 95% ( $U=2Uc(y)$ ): $\pm 0.82^{\circ}\text{C} / \pm 3\%$

## 7. TEST RESULT

### 7.1. Summary

FCC Part Section(s)	Test Description	Test Limit	Test Condition	Test Result	Reference
15.247(a)(2)	6dB Bandwidth	$\geq 500\text{kHz}$	Conducted	Pass	Section 7.2
15.247(b)(3)	Output Power	$\leq 1\text{Watt}$		Pass	Section 7.3
15.247(e)	Power Spectral Density	$\leq 8\text{dBm} / 3\text{kHz}$		Pass	Section 7.4
15.247(d)	Band Edge / Out-of-Band Emissions	$\geq 20\text{dBc (Peak)}$		Pass	Section 7.5
15.205 15.209	General Field Strength (Restricted Bands and Radiated Emission)	Emissions in restricted bands must meet the radiated limits detailed in 15.209	Radiated	Pass	Section 7.6 & 7.7
15.207	AC Conducted Emissions 150kHz - 30MHz	< FCC 15.207 limits	Line Conducted	Pass	Section 7.8

Notes:

- 1) The analyzer plots shown in this section were all taken with a correction table loaded into the analyzer. The correction table was used to account for the losses of the cables and attenuators used as part of the system to connect the EUT to the analyzer at all frequencies of interest.
- 2) All modes of operation and data rates were investigated. For radiated emission test, every axis (X, Y, Z) was also verified. The test results shown in the following sections represent the worst case emissions.
- 3) Determining compliance is based on the test results met the regulation limits or requirements declared by clients, and the test results don't take into account the value of measurement uncertainty.

## 7.2. 6dB Bandwidth Measurement

### 7.2.1. Test Limit

The minimum 6dB bandwidth shall be at least 500 kHz.

### 7.2.2. Test Procedure used

ANSI C63.10-2013 Section 11.8

### 7.2.3. Test Setting

1. The Spectrum's automatic bandwidth measurement capability was used to perform the 6dB bandwidth measurement. The bandwidth measurement was not influenced by any intermediate power nulls in the fundamental emission.
2. Set RBW = 100 kHz
3. VBW  $\geq 3 \times$  RBW
4. Detector = Peak
5. Trace mode = Max hold
6. Sweep = auto couple
7. Allow the trace was allowed to stabilize

### 7.2.4. Test Setup

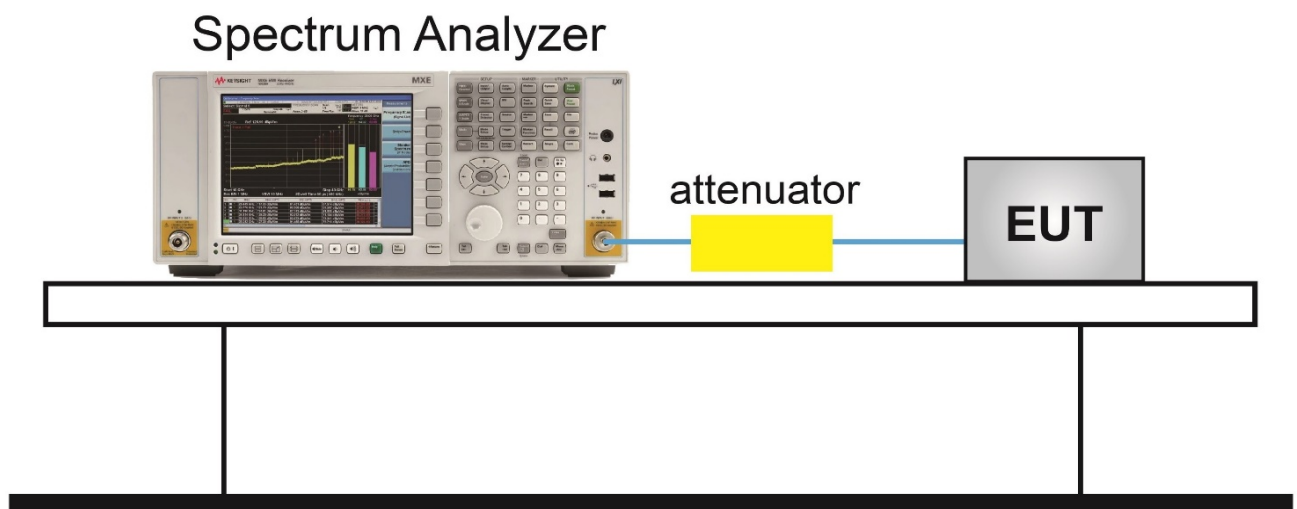

**7.2.5. Test Result**

Product	OmniAccess Stellar	Test Engineer	Eric Lin
Test Site	SR2	Test Date	2021/10/13

Test Mode	Data Rate (Mbps)	Channel No.	Frequency (MHz)	6dB Bandwidth (MHz)	Limit (MHz)	Result
BLE	1	00	2402	0.665	≥ 0.5	Pass
BLE	1	19	2440	0.664	≥ 0.5	Pass
BLE	1	39	2480	0.663	≥ 0.5	Pass
BLE	2	00	2402	1.183	≥ 0.5	Pass
BLE	2	19	2440	1.186	≥ 0.5	Pass
BLE	2	39	2480	1.177	≥ 0.5	Pass

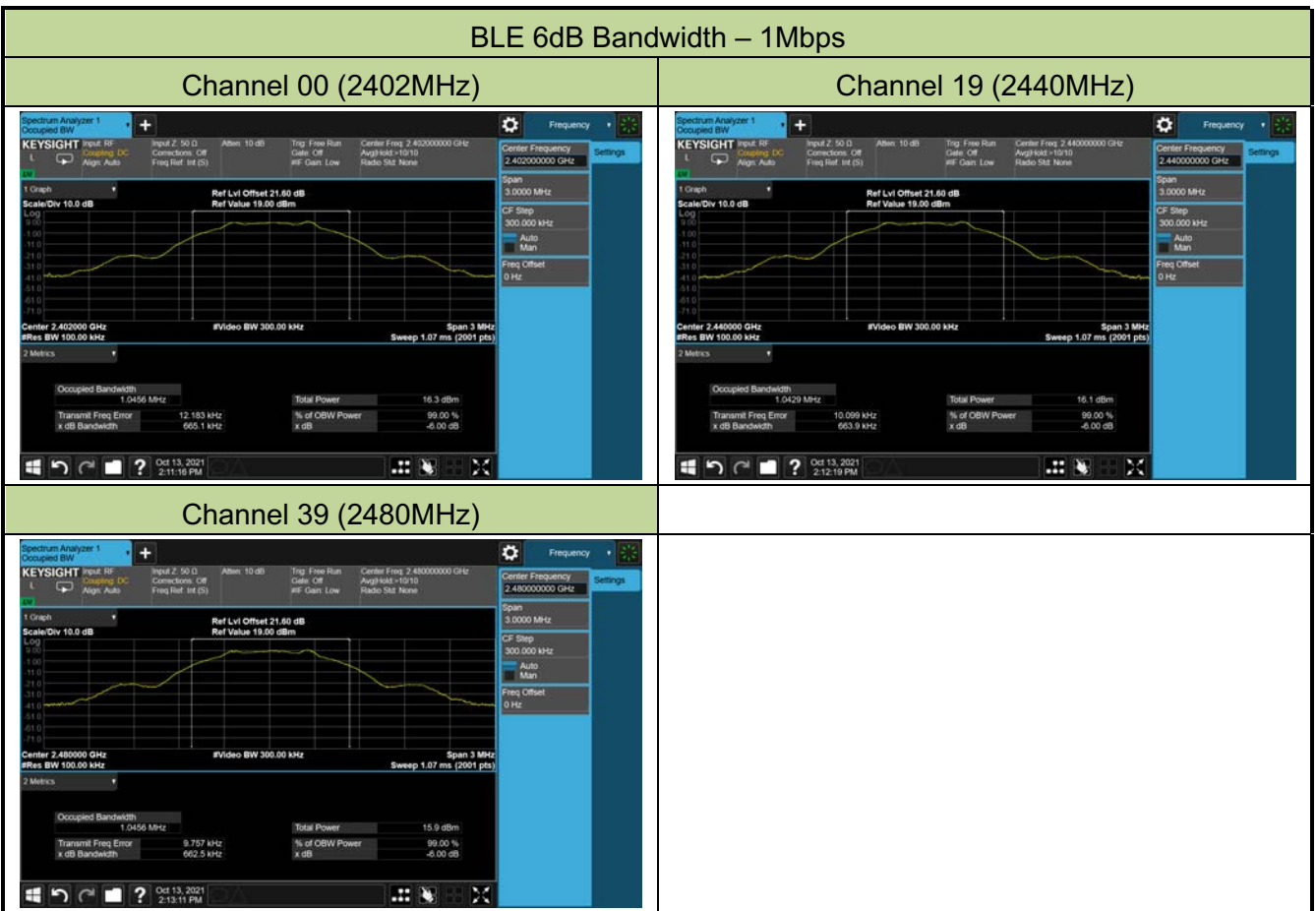

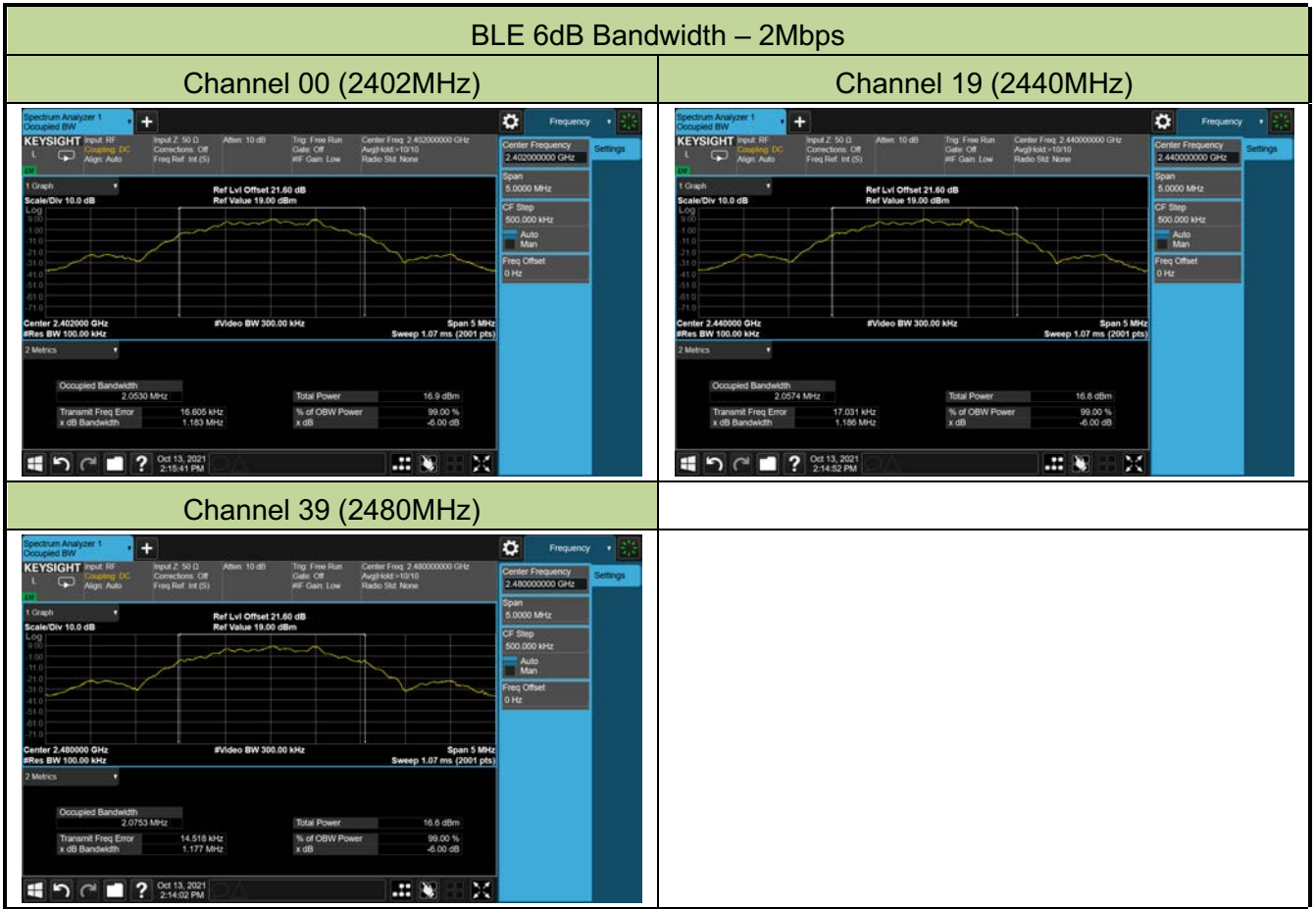

### **7.3. Output Power Measurement**

#### **7.3.1. Test Limit**

The maximum out power shall be less 1 Watt (30dBm).

The conducted output power limit specified in paragraph FCC Part 15.247(b) of this section is based on the use of antennas with directional gains that do not exceed 6 dBi. If transmitting antennas of directional gain greater than 6 dBi are used, the conducted output power from the intentional radiator shall be reduced below the stated values in paragraphs FCC Part 15.247(b)(3) of this section, as appropriate, by the amount in dB that the directional gain of the antenna exceeds 6 dBi.

#### **7.3.2. Test Procedure Used**

ANSI C63.10-2013 Section 11.9.1.3

ANSI C63.10-2013 Section 11.9.2.3

#### **7.3.3. Test Setting**

##### **Method PKPM1 (Peak Power Measurement of Signals with DTS BW $\leq$ 50MHz)**

Peak power measurements were performed only when the EUT was transmitting at its maximum power control level using a broadband power meter with a pulse sensor. The pulse sensor employs a VBW = 50MHz so this method was only used for signals whose DTS bandwidth was less than or equal to 50MHz.

##### **Average Power Measurement**

Average power measurements were performed only when the EUT was transmitting at its maximum power control level using a broadband power meter with a pulse sensor. The power meter implemented triggering and gating capabilities which were set up such that power measurements were recorded only during the ON time of the transmitter.

### 7.3.4. Test Setup

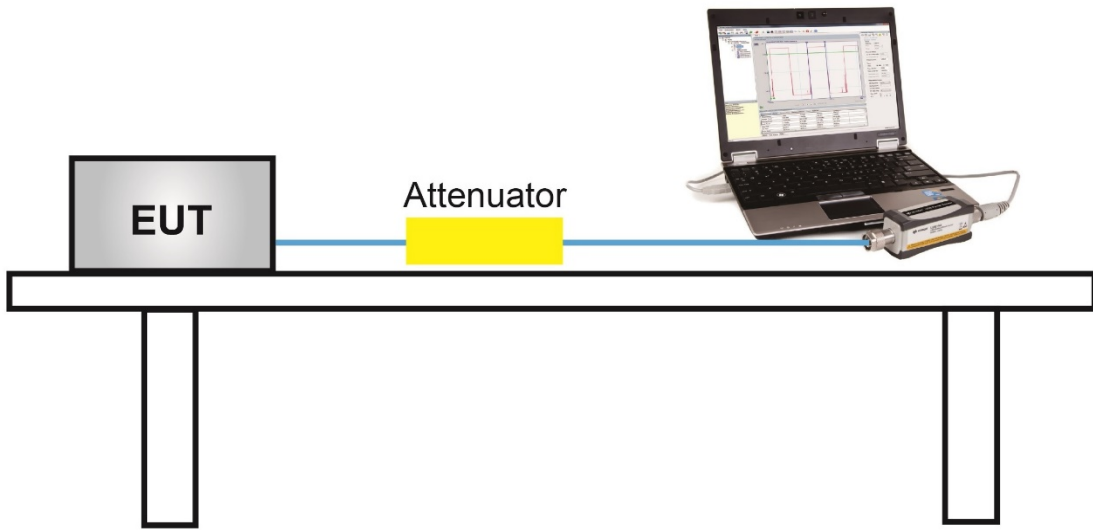

### 7.3.5. Test Result

Product	OmniAccess Stellar	Test Engineer	Eric Lin
Test Site	SR2	Test Date	2021/10/11

#### Test Result of Peak Output Power

Test Mode	Data Rate (Mbps)	Channel No.	Frequency (MHz)	Peak Power (dBm)	Limit (dBm)	Result
BLE	1	00	2402	9.75	≤ 30.00	Pass
BLE	1	19	2440	9.67	≤ 30.00	Pass
BLE	1	39	2480	9.37	≤ 30.00	Pass
BLE	2	00	2402	9.76	≤ 30.00	Pass
BLE	2	19	2440	9.67	≤ 30.00	Pass
BLE	2	39	2480	9.38	≤ 30.00	Pass

#### Test Result of Average Output Power (Reporting Only)

Test Mode	Data Rate (Mbps)	Channel No.	Frequency (MHz)	Average Power (dBm)	Limit (dBm)	Result
BLE	1	00	2402	9.46	≤ 30.00	Pass
BLE	1	19	2440	9.34	≤ 30.00	Pass
BLE	1	39	2480	9.06	≤ 30.00	Pass
BLE	2	00	2402	9.47	≤ 30.00	Pass
BLE	2	19	2440	9.35	≤ 30.00	Pass
BLE	2	39	2480	9.07	≤ 30.00	Pass



## 7.4. Power Spectral Density Measurement

### 7.4.1. Test Limit

The maximum permissible power spectral density is 8dBm in any 3 kHz band.

The same method of determining the conducted output power shall be used to determine the power spectral density.

### 7.4.2. Test Procedure Used

ANSI C63.10-2013 Section 11.10.2

### 7.4.3. Test Setting

1. Analyzer was set to the center frequency of the DTS channel under investigation
2. Span = 1.5 times the DTS channel bandwidth
3. RBW = 3kHz
4. VBW = 10kHz
5. Detector = peak
6. Sweep time = auto couple
7. Trace mode = max hold
8. Trace was allowed to stabilize

### 7.4.4. Test Setup

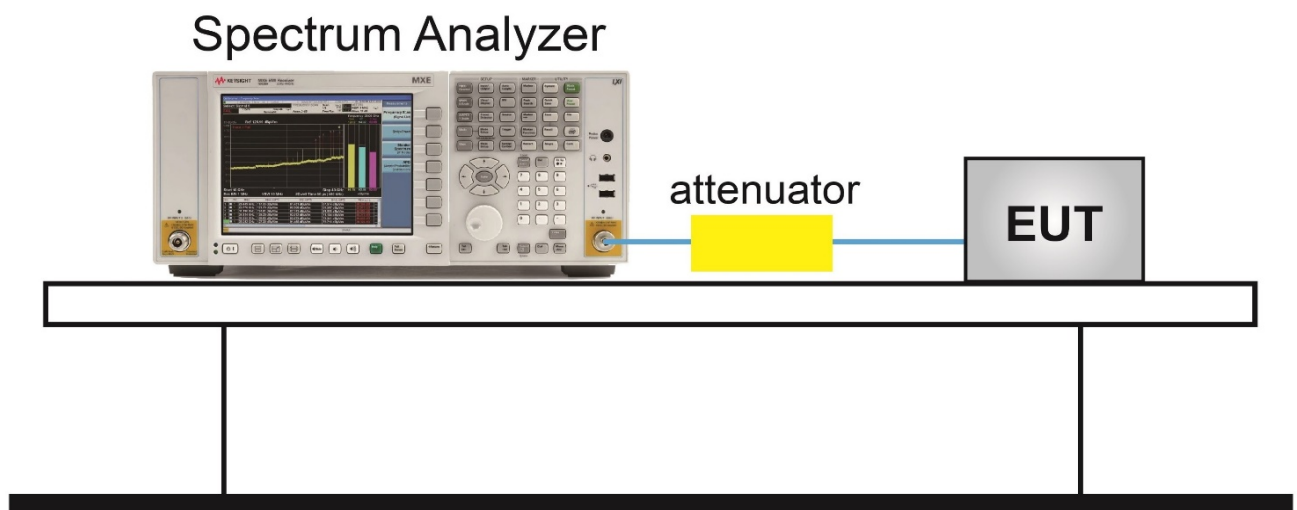

**7.4.5. Test Result**

Product	OmniAccess Stellar	Test Engineer	Eric Lin
Test Site	SR2	Test Date	2021/10/11

Test Mode	Data Rate (Mbps)	Channel No.	Frequency (MHz)	PSD Result (dBm / 3kHz)	Limit (dBm / 3kHz)	Result
BLE	1	00	2402	-6.57	≤ 8.00	Pass
BLE	1	19	2440	-6.74	≤ 8.00	Pass
BLE	1	39	2480	-7.05	≤ 8.00	Pass
BLE	2	00	2402	-10.04	≤ 8.00	Pass
BLE	2	19	2440	-10.08	≤ 8.00	Pass
BLE	2	39	2480	-10.29	≤ 8.00	Pass

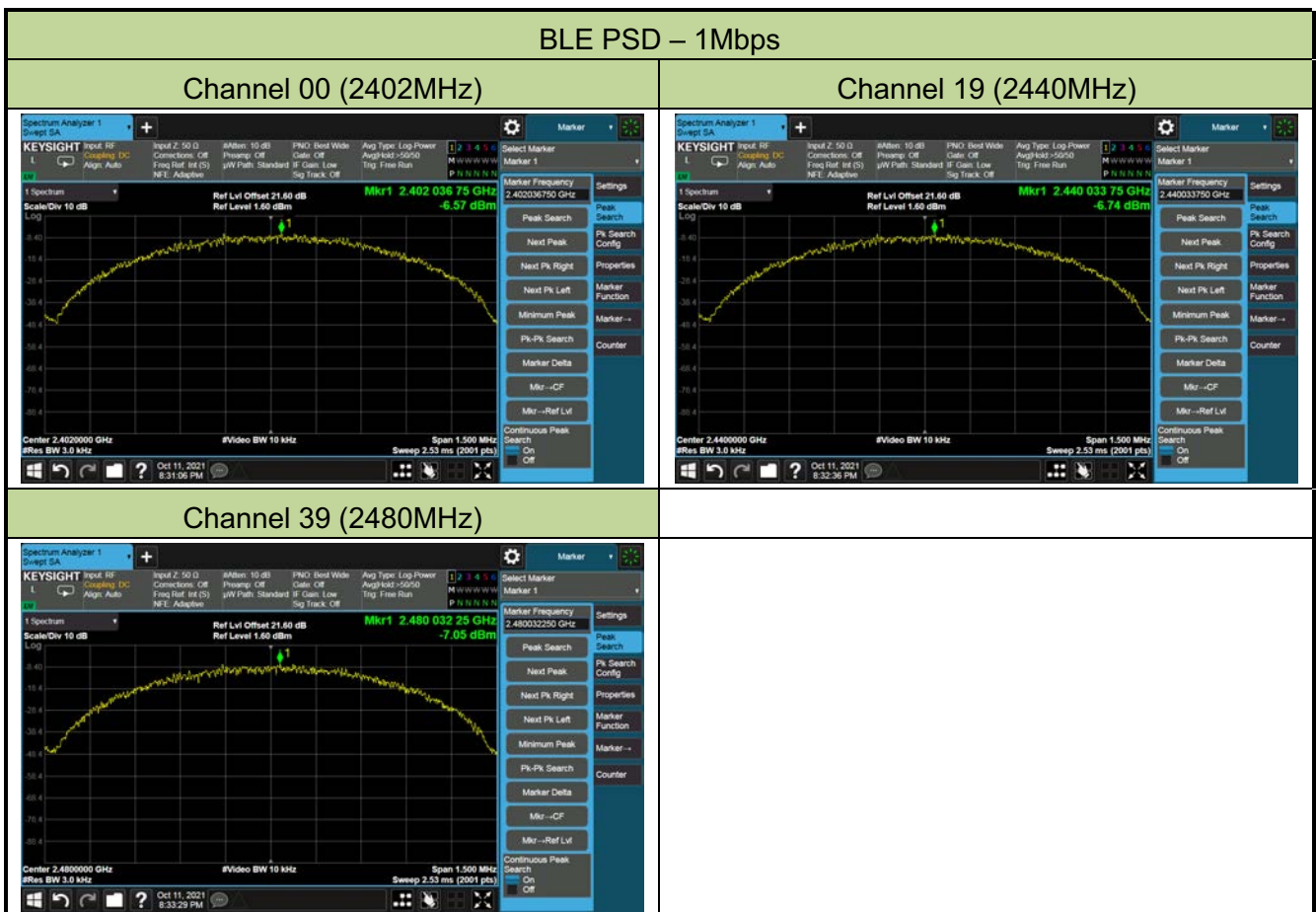

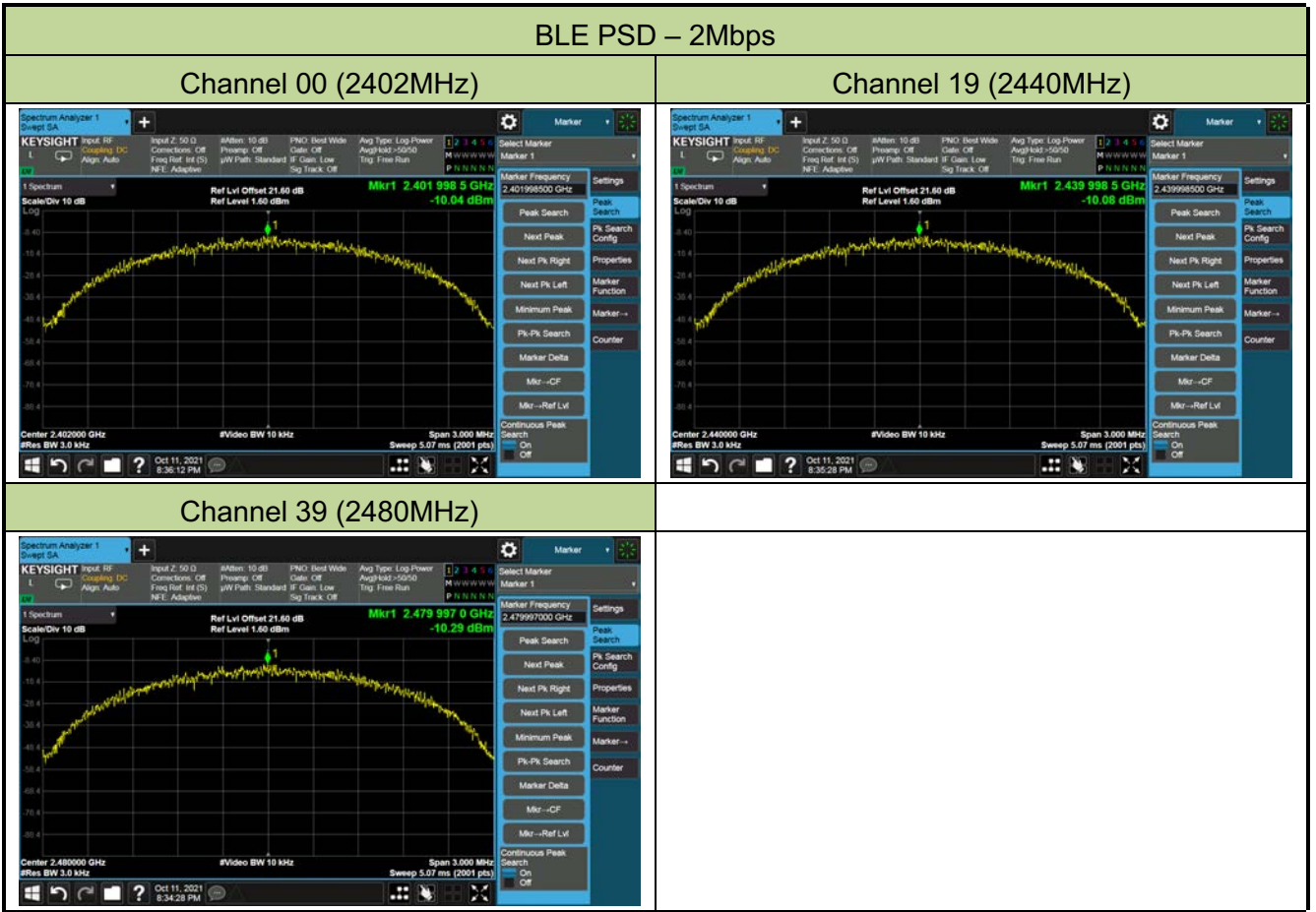

## **7.5. Conducted Band Edge and Out-of-Band Emissions**

### **7.5.1. Test Limit**

The limit for out-of-band spurious emissions at the band edge is 20dB below the fundamental emission level, as determined from the in-band power measurement of the DTS channel performed in a 100kHz bandwidth per the PSD procedure.

### **7.5.2. Test Procedure Used**

ANSI C63.10-2013 Section 11.11

### **7.5.3. Test Setting**

#### **1. Reference level measurement**

- a) Set instrument center frequency to DTS channel center frequency
- b) Set the span to  $\geq 1.5$  times the DTS bandwidth
- c) Set the RBW = 100 kHz
- d) Set the VBW  $\geq 3 \times$  RBW
- e) Detector = peak
- f) Sweep time = auto couple
- g) Trace mode = max hold
- h) Allow trace to fully stabilize

#### **2. Emission level measurement**

- a) Start frequency was set to 30MHz and stop frequency was set to 25GHz (separated into two plots per channel)
- b) RBW = 100kHz
- c) VBW = 300kHz
- d) Detector = Peak
- e) Trace mode = max hold
- f) Sweep time = auto couple
- g) The trace was allowed to stabilize

### 7.5.4. Test Setup

## Spectrum Analyzer

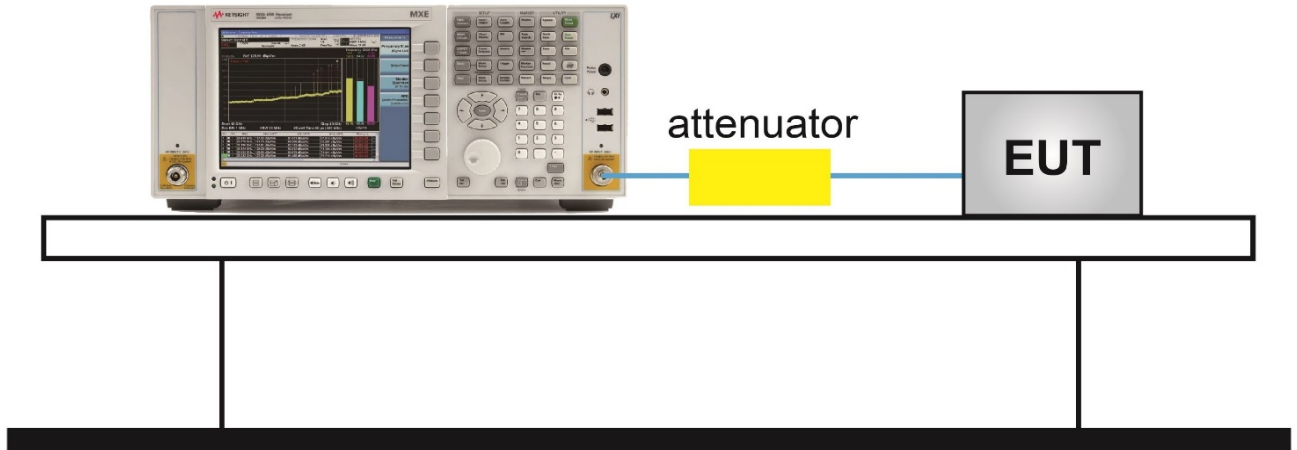

**7.5.5. Test Result**

Product	OmniAccess Stellar	Test Engineer	Eric Lin
Test Site	SR2	Test Date	2021/10/14

Test Mode	Data Rate (Mbps)	Channel No.	Frequency (MHz)	Limit	Result
BLE	1	00	2402	20dBc	Pass
BLE	1	19	2440	20dBc	Pass
BLE	1	39	2480	20dBc	Pass
BLE	2	00	2402	20dBc	Pass
BLE	2	19	2440	20dBc	Pass
BLE	2	39	2480	20dBc	Pass

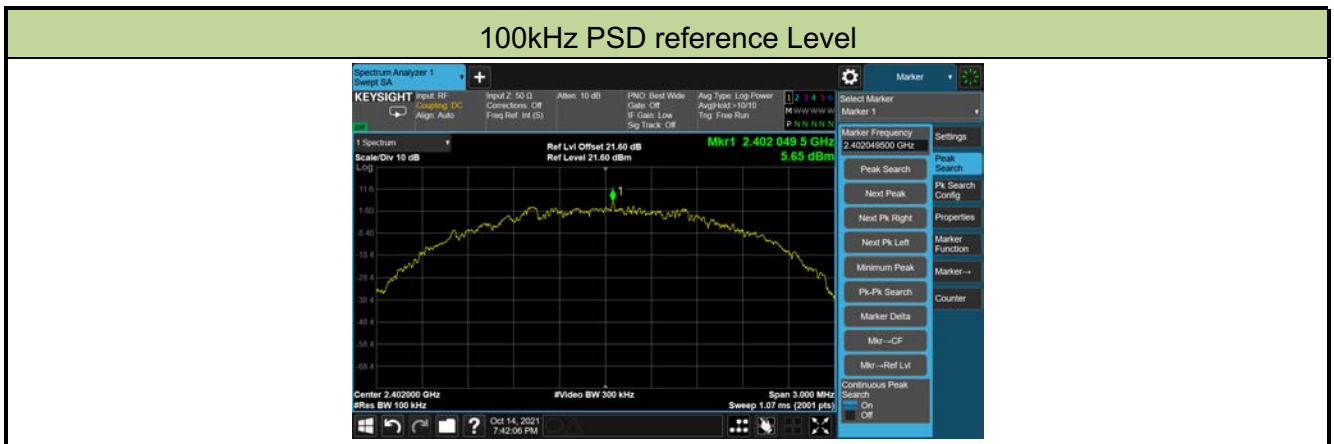

### BLE Out-of-Band Emissions – 1Mbps

#### Channel 00 (2402MHz)

##### Low Band Edge

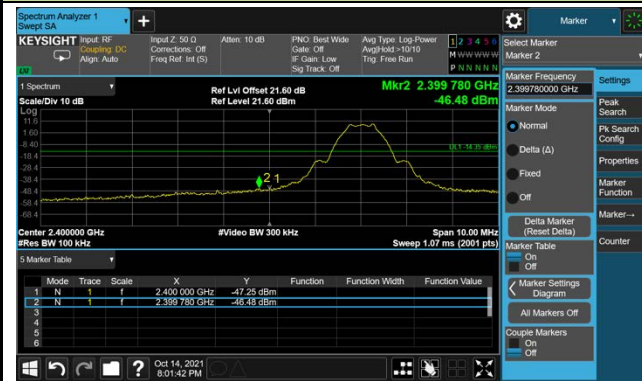

##### Spurious Emission 30MHz ~ 25GHz



#### Channel 19 (2440MHz)

##### Spurious Emission 30MHz ~ 25GHz

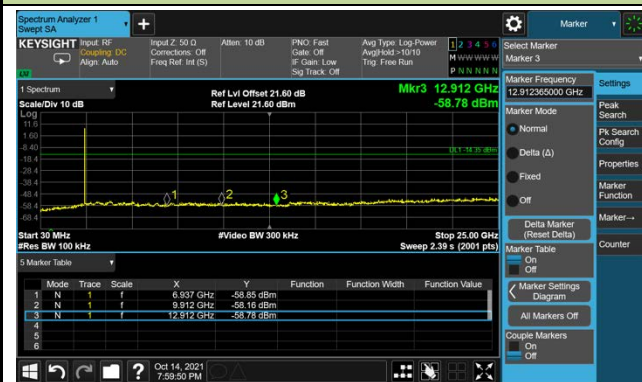

#### Channel 39 (2480MHz)

##### High Band Edge



##### Spurious Emission 30MHz ~ 25GHz

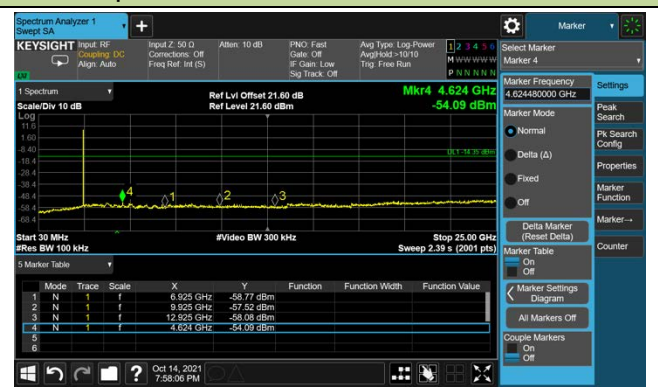



## BLE Out-of-Band Emissions – 2Mbps

### Channel 00 (2402MHz)

#### Low Band Edge



#### Spurious Emission 30MHz ~ 25GHz



### Channel 19 (2440MHz)

#### Spurious Emission 30MHz ~ 25GHz

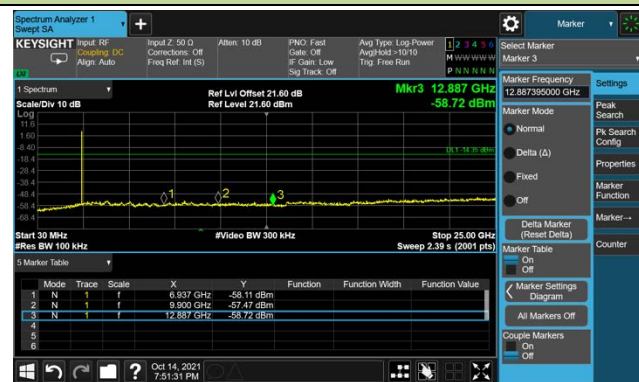

### Channel 39 (2480MHz)

#### High Band Edge



#### Spurious Emission 30MHz ~ 25GHz





**7.6. Radiated Spurious Emission Measurement**

**7.6.1. Test Limit**

All out of band emissions appearing in a restricted band as specified in Section 15.205 of the Title 47 CFR must not exceed the limits shown in Table per Section 15.209.

FCC Part 15 Subpart C Paragraph 15.209		
Frequency [MHz]	Field Strength [ $\mu$ V/m]	Measured Distance [Meters]
0.009 - 0.490	2400/F (kHz)	300
0.490 - 1.705	24000/F (kHz)	30
1.705 - 30	30	30
30 - 88	100	3
88 - 216	150	3
216 - 960	200	3
Above 960	500	3

**7.6.2. Test Procedure Used**

ANSI C63.10-2013 Section 6.3 (General Requirements)

ANSI C63.10-2013 Section 6.4 (Standard test method below 30MHz)

ANSI C63.10-2013 Section 6.5 (Standard test method above 30MHz to 1GHz)

ANSI C63.10-2013 Section 6.6 (Standard test method above 1GHz)

ANSI C63.10-2013 Section 11.11 & 11.12

**7.6.3. Test Setting**

**Table 1 - RBW as a function of frequency**

Frequency	RBW
9 ~ 150 kHz	200 ~ 300 Hz
0.15 ~ 30 MHz	9 ~ 10 kHz
30 ~ 1000 MHz	100 ~ 120 kHz

**Quasi-Peak Measurements below 1GHz**

1. Analyzer center frequency was set to the frequency of the radiated spurious emission of interest
2. Span was set greater than 1MHz
3. RBW = as specified in Table 1
4. Detector = CISPR quasi-peak
5. Sweep time = auto couple
6. Trace was allowed to stabilize

**Peak Measurements above 1GHz**

1. Analyzer center frequency was set to the frequency of the radiated spurious emission of interest
2. RBW = 1MHz
3. VBW = 3MHz
4. Detector = peak
5. Sweep time = auto couple
6. Trace mode = max hold
7. Trace was allowed to stabilize

**Average Measurements above 1GHz**

1. Analyzer center frequency was set to the frequency of the radiated spurious emission of interest
2. RBW = 1MHz
3. VBW = 1 / T
4. Average Type = Voltage
5. Detector = Peak
6. Sweep time = auto
7. Trace mode = max hold
8. Trace was allowed to stabilize

### 7.6.4. Test Setup

#### Below 1GHz Test Setup:

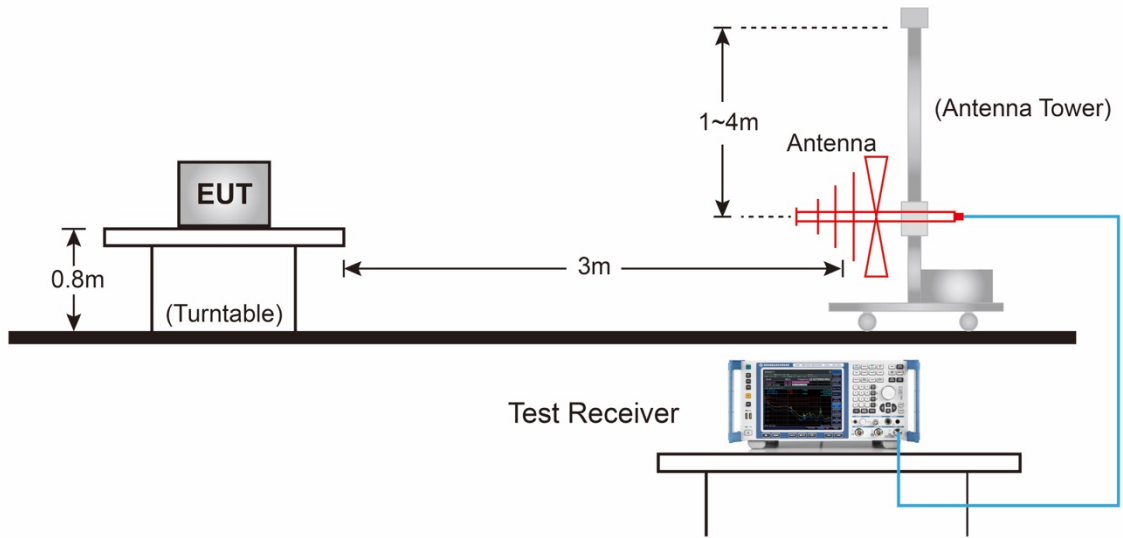

#### Above 1GHz Test Setup:

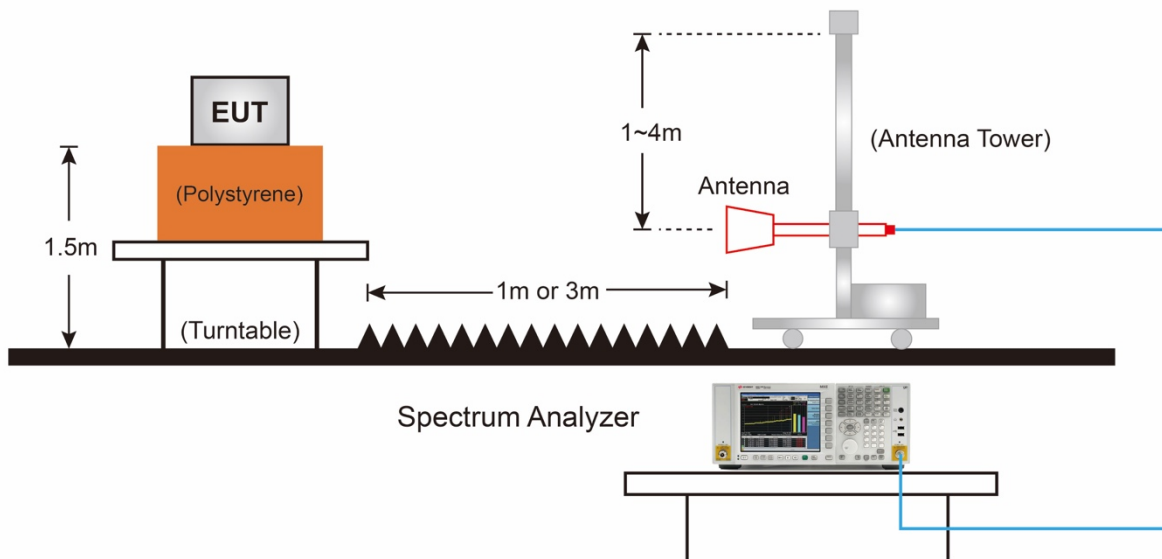

**7.6.5. Test Result**

EUT	OmniAccess Stellar	Date of Test	2021-11-12
Factor	BBHA 9120D (1GHz~18GHz)	Temp. / Humidity	23°C/53%
Polarity	Horizontal	Site / Test Engineer	AC1 / Tim
Test Mode	Transmit at 2402MHz by BLE 1Mbps	Test Voltage	AC 120V/60Hz

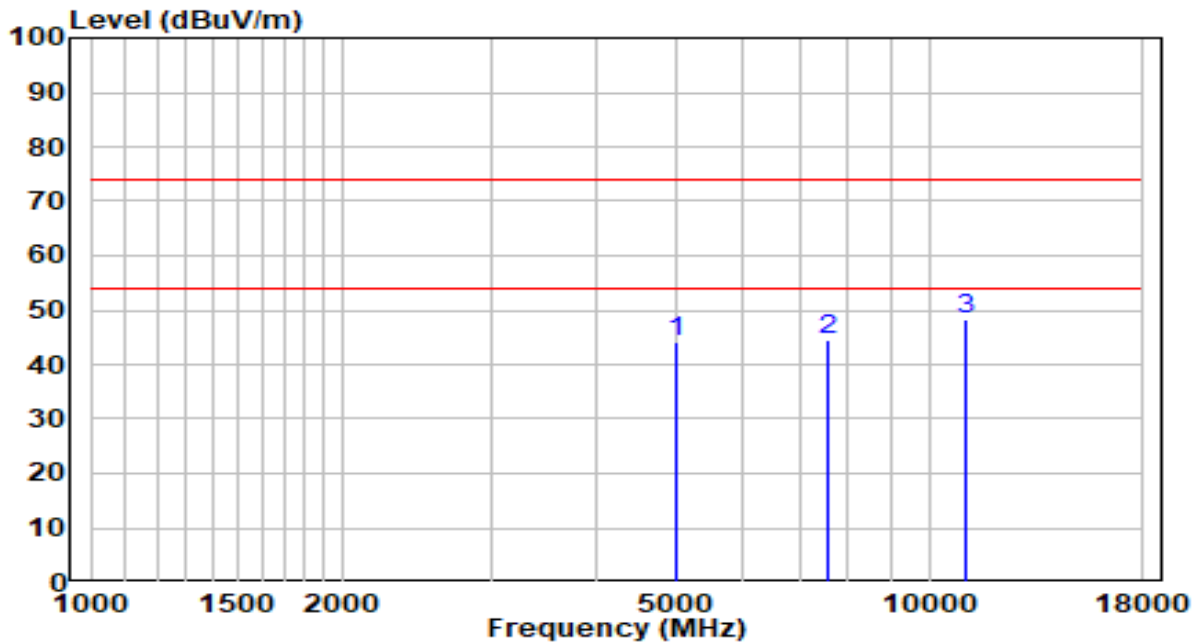

No	Frequency (MHz)	Reading (dB $\mu$ V)	C.F (dB/m)	Measurement (dB $\mu$ V/m)	Margin (dB)	Limit (dB $\mu$ V/m)	Remark (QP/PK/AV)
1	5003.500	40.20	3.96	44.16	-29.84	74.00	Peak
2	7596.000	31.46	13.09	44.55	-29.45	74.00	Peak
3	* 11072.500	29.05	19.39	48.44	-25.56	74.00	Peak

Note:

1. " \*", means this data is the worst emission level.
2. C.F (Correction Factor) = Antenna Factor (dB/m)+ Cable Loss (dB)– Preamplifier(dB).
3. Measurement(dB $\mu$ V/m) = Reading(dB $\mu$ V) + C.F (Correction Factor).

EUT	OmniAccess Stellar	Date of Test	2021-11-13
Factor	BBHA 9120D (1GHz~18GHz)	Temp. / Humidity	23°C/53%
Polarity	Vertical	Site / Test Engineer	AC1 / Tim
Test Mode	Transmit at 2402MHz by BLE 1Mbps	Test Voltage	AC 120V/60Hz

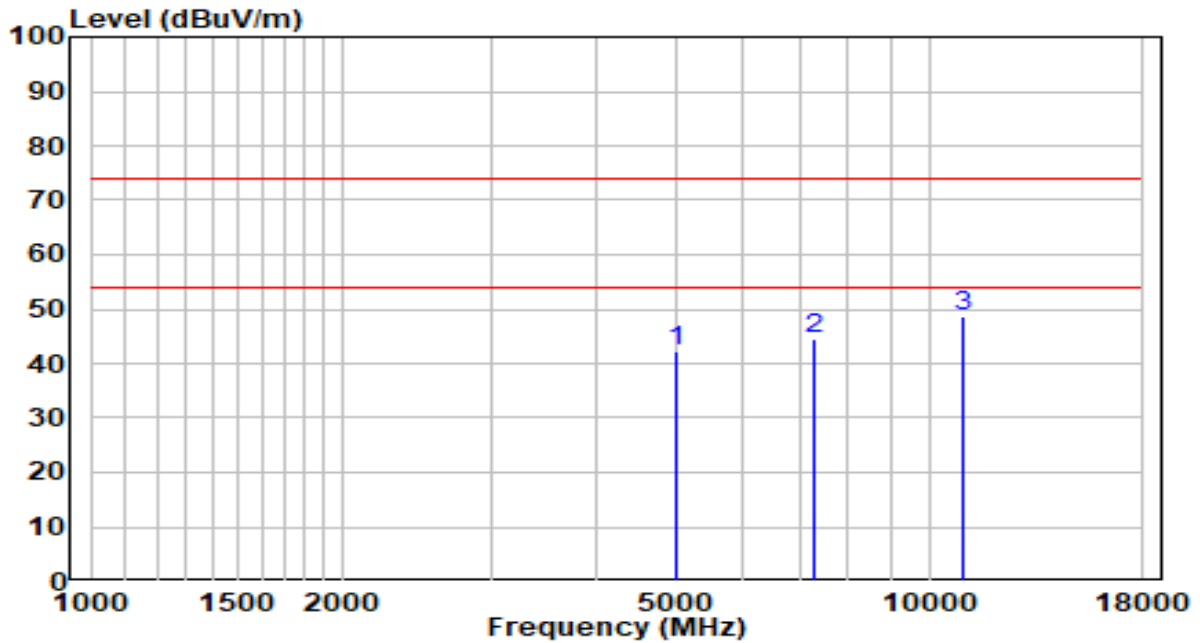

No	Frequency (MHz)	Reading (dB $\mu$ V)	C.F (dB/m)	Measurement (dB $\mu$ V/m)	Margin (dB)	Limit (dB $\mu$ V/m)	Remark (QP/PK/AV)
1	5003.500	38.18	3.96	42.13	-31.87	74.00	Peak
2	7281.500	32.63	12.05	44.67	-29.33	74.00	Peak
3	* 10996.000	29.24	19.27	48.51	-25.49	74.00	Peak

Note:

1. " \*", means this data is the worst emission level.
2. C.F (Correction Factor) = Antenna Factor (dB/m)+ Cable Loss (dB)– Preamplifier(dB).
3. Measurement(dB $\mu$ V/m) = Reading(dB $\mu$ V) + C.F (Correction Factor).

EUT	OmniAccess Stellar	Date of Test	2021-11-13
Factor	BBHA 9120D (1GHz~18GHz)	Temp. / Humidity	23°C/53%
Polarity	Horizontal	Site / Test Engineer	AC1 / Tim
Test Mode	Transmit at 2440MHz by BLE 1Mbps	Test Voltage	AC 120V/60Hz

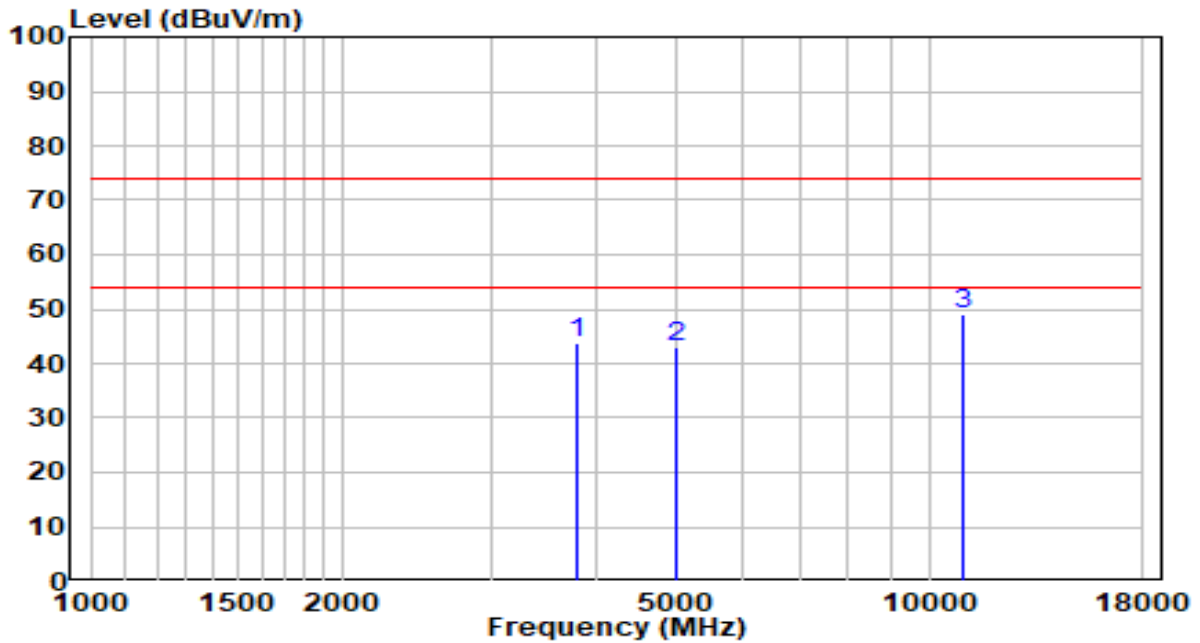

No	Frequency (MHz)	Reading (dBμV)	C.F (dB/m)	Measurement (dBμV/m)	Margin (dB)	Limit (dBμV/m)	Remark (QP/PK/AV)
1	3796.500	43.23	0.56	43.79	-30.21	74.00	Peak
2	5003.500	39.20	3.96	43.16	-30.84	74.00	Peak
3	* 10962.000	29.97	19.23	49.20	-24.80	74.00	Peak

Note:

1. "\*" , means this data is the worst emission level.
2. C.F (Correction Factor) = Antenna Factor (dB/m)+ Cable Loss (dB)– Preamplifier(dB).
3. Measurement(dBμV/m) = Reading(dBμV) + C.F (Correction Factor).

EUT	OmniAccess Stellar	Date of Test	2021-11-13
Factor	BBHA 9120D (1GHz~18GHz)	Temp. / Humidity	23°C/53%
Polarity	Vertical	Site / Test Engineer	AC1 / Tim
Test Mode	Transmit at 2440MHz by BLE 1Mbps	Test Voltage	AC 120V/60Hz

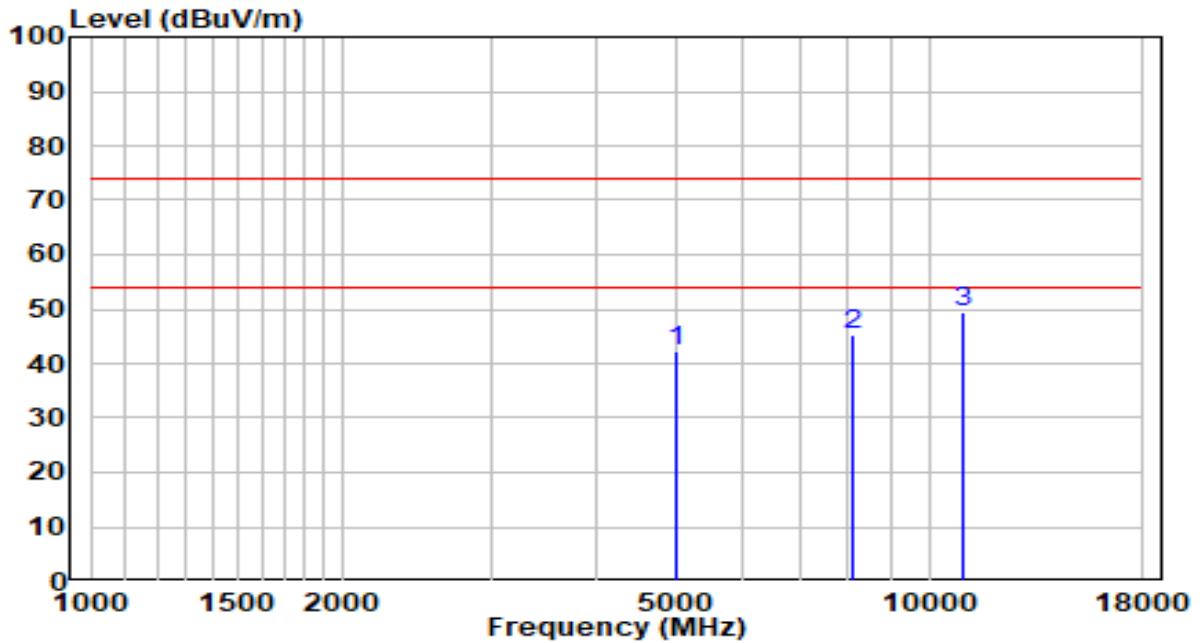

No	Frequency (MHz)	Reading (dBμV)	C.F (dB/m)	Measurement (dBμV/m)	Margin (dB)	Limit (dBμV/m)	Remark (QP/PK/AV)
1	5003.500	38.32	3.96	42.27	-31.73	74.00	Peak
2	8131.500	31.83	13.49	45.32	-28.68	74.00	Peak
3	* 10996.000	30.11	19.27	49.38	-24.62	74.00	Peak

Note:

1. " \*", means this data is the worst emission level.
2. C.F (Correction Factor) = Antenna Factor (dB/m)+ Cable Loss (dB)– Preamplifier(dB).
3. Measurement(dBμV/m) = Reading(dBμV) + C.F (Correction Factor).

EUT	OmniAccess Stellar	Date of Test	2021-11-13
Factor	BBHA 9120D (1GHz~18GHz)	Temp. / Humidity	23°C/53%
Polarity	Horizontal	Site / Test Engineer	AC1 / Tim
Test Mode	Transmit at 2480MHz by BLE 1Mbps	Test Voltage	AC 120V/60Hz

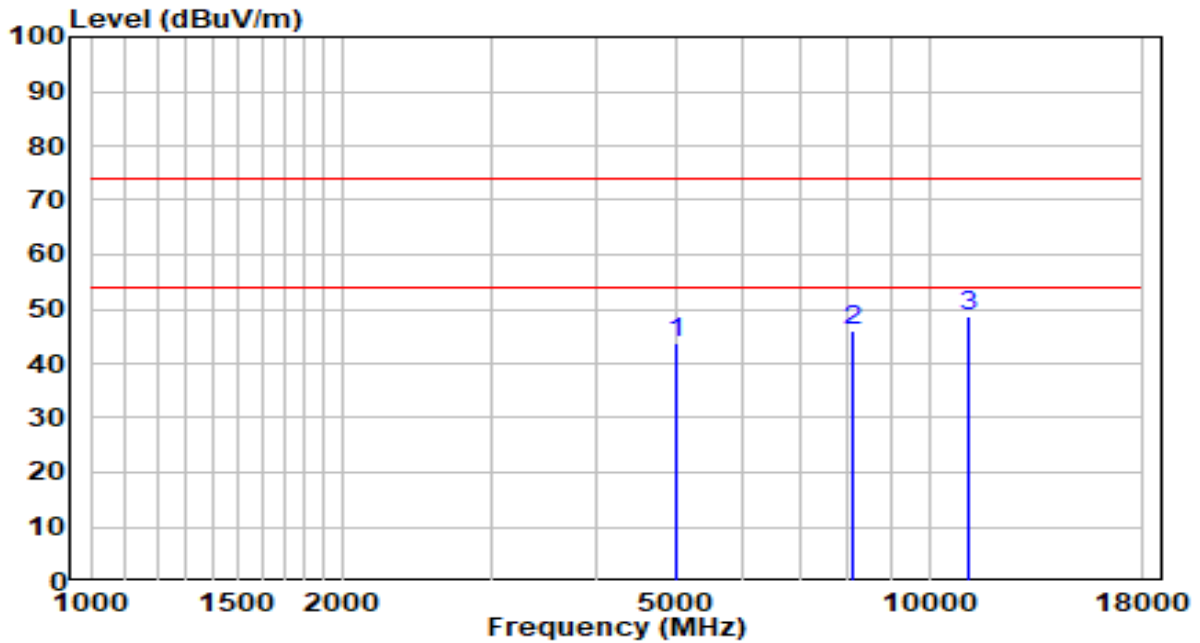

No	Frequency (MHz)	Reading (dBμV)	C.F (dB/m)	Measurement (dBμV/m)	Margin (dB)	Limit (dBμV/m)	Remark (QP/PK/AV)
1	5003.500	39.97	3.96	43.92	-30.08	74.00	Peak
2	8106.000	32.40	13.48	45.88	-28.12	74.00	Peak
3	* 11166.000	29.32	19.54	48.86	-25.14	74.00	Peak

Note:

1. "\*" , means this data is the worst emission level.
2. C.F (Correction Factor) = Antenna Factor (dB/m)+ Cable Loss (dB)– Preamplifier(dB).
3. Measurement(dBμV/m) = Reading(dBμV) + C.F (Correction Factor).
- 4.The emission levels of other frequencies are very lower than the limit and not show in test report.



EUT	OmniAccess Stellar	Date of Test	2021-11-13
Factor	BBHA 9120D (1GHz~18GHz)	Temp. / Humidity	23°C/53%
Polarity	Vertical	Site / Test Engineer	AC1 / Tim
Test Mode	Transmit at 2480MHz by BLE 1Mbps	Test Voltage	AC 120V/60Hz

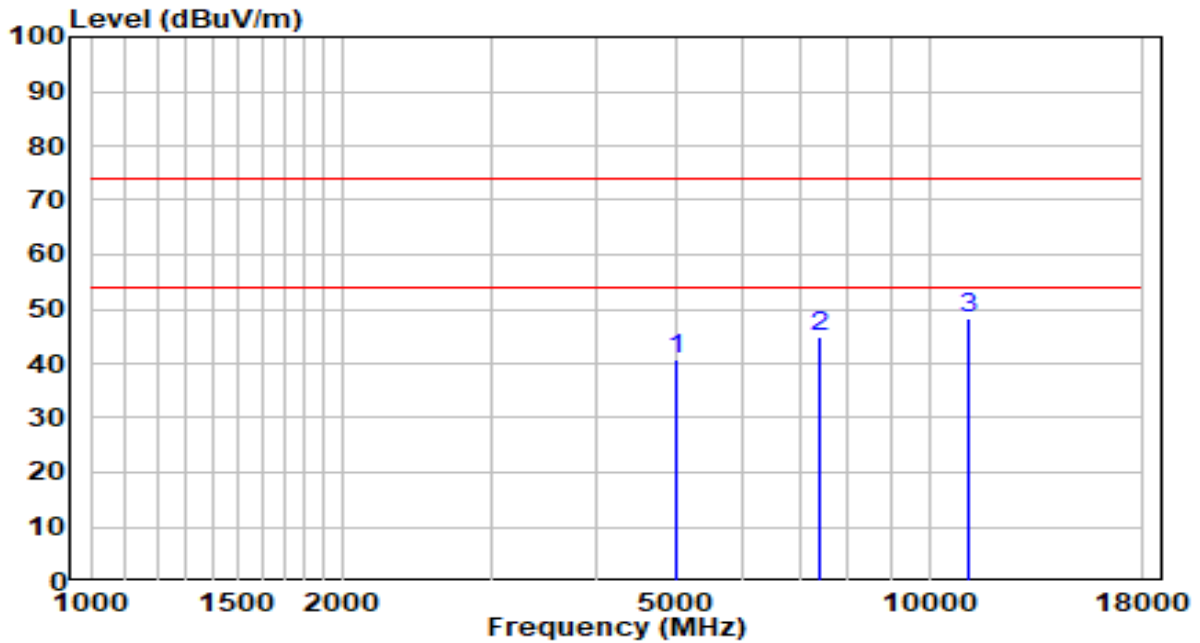

No	Frequency (MHz)	Reading (dB $\mu$ V)	C.F (dB/m)	Measurement (dB $\mu$ V/m)	Margin (dB)	Limit (dB $\mu$ V/m)	Remark (QP/PK/AV)
1	5003.500	36.79	3.96	40.75	-33.25	74.00	Peak
2	7426.000	32.33	12.69	45.02	-28.98	74.00	Peak
3	* 11166.000	28.84	19.54	48.37	-25.63	74.00	Peak

Note:

1. " \*", means this data is the worst emission level.
2. C.F (Correction Factor) = Antenna Factor (dB/m)+ Cable Loss (dB)– Preamplifier(dB).
3. Measurement(dB $\mu$ V/m) = Reading(dB $\mu$ V) + C.F (Correction Factor).

EUT	OmniAccess Stellar	Date of Test	2021-11-13
Factor	BBHA 9120D (1GHz~18GHz)	Temp. / Humidity	23°C/53%
Polarity	Vertical	Site / Test Engineer	AC1 / Tim
Test Mode	Transmit at 2402MHz by BLE 2Mbps	Test Voltage	AC 120V/60Hz

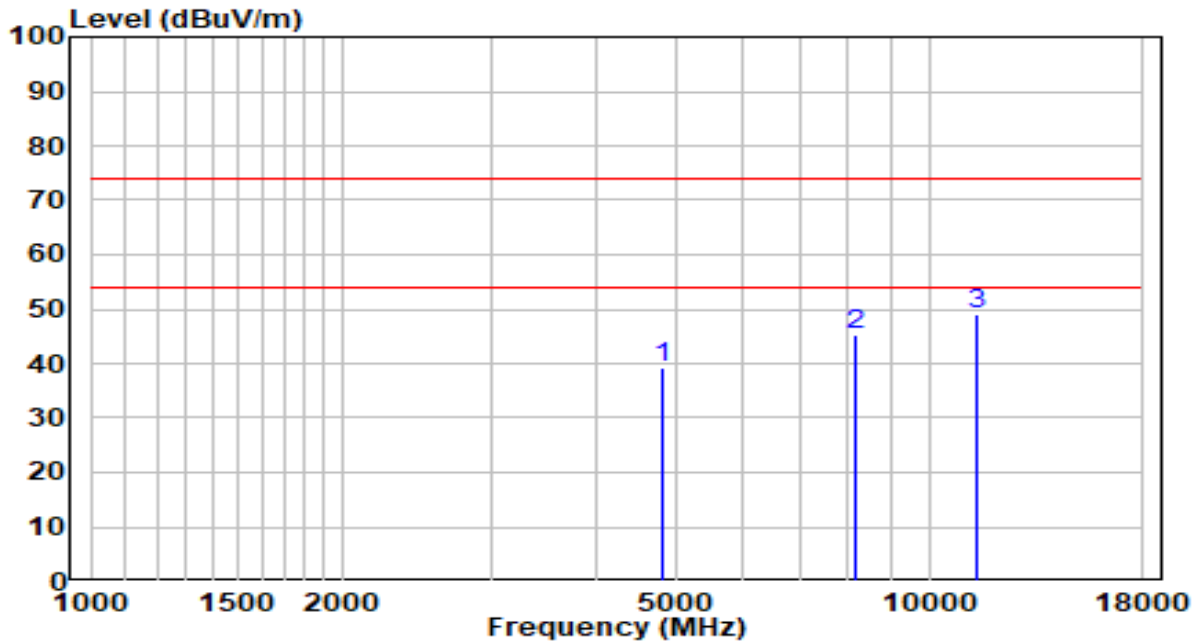

No	Frequency (MHz)	Reading (dB $\mu$ V)	C.F (dB/m)	Measurement (dB $\mu$ V/m)	Margin (dB)	Limit (dB $\mu$ V/m)	Remark (QP/PK/AV)
1	4799.500	35.77	3.59	39.36	-34.64	74.00	Peak
2	8157.000	31.92	13.50	45.42	-28.58	74.00	Peak
3	* 11429.500	29.18	19.94	49.12	-24.88	74.00	Peak

Note:

1. " \*", means this data is the worst emission level.
2. C.F (Correction Factor) = Antenna Factor (dB/m)+ Cable Loss (dB)– Preamplifier(dB).
3. Measurement(dB $\mu$ V/m) = Reading(dB $\mu$ V) + C.F (Correction Factor).

EUT	OmniAccess Stellar	Date of Test	2021-11-13
Factor	BBHA 9120D (1GHz~18GHz)	Temp. / Humidity	23°C/53%
Polarity	Horizontal	Site / Test Engineer	AC1 / Tim
Test Mode	Transmit at 2440MHz by BLE 2Mbps	Test Voltage	AC 120V/60Hz

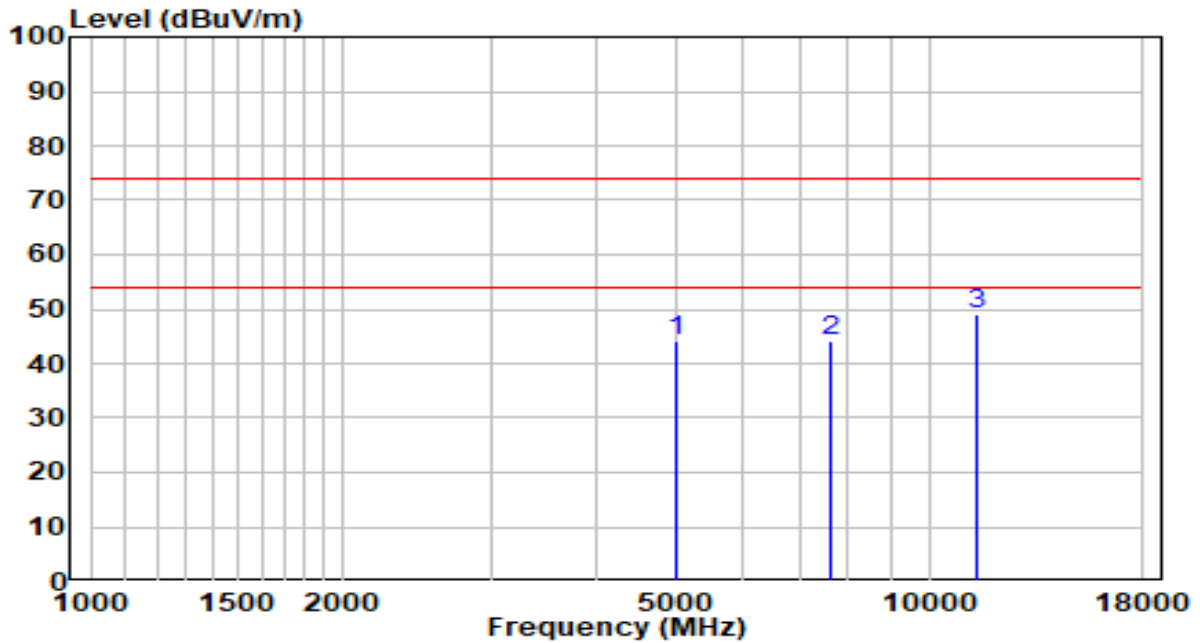

No	Frequency (MHz)	Reading (dB $\mu$ V)	C.F (dB/m)	Measurement (dB $\mu$ V/m)	Margin (dB)	Limit (dB $\mu$ V/m)	Remark (QP/PK/AV)
1	5003.500	40.28	3.96	44.24	-29.76	74.00	Peak
2	7655.500	30.95	13.14	44.09	-29.91	74.00	Peak
3	* 11421.000	29.15	19.93	49.08	-24.92	74.00	Peak

Note:

1. " \*", means this data is the worst emission level.
2. C.F (Correction Factor) = Antenna Factor (dB/m)+ Cable Loss (dB)– Preamplifier(dB).
3. Measurement(dB $\mu$ V/m) = Reading(dB $\mu$ V) + C.F (Correction Factor).

EUT	OmniAccess Stellar	Date of Test	2021-11-13
Factor	BBHA 9120D (1GHz~18GHz)	Temp. / Humidity	23°C/53%
Polarity	Vertical	Site / Test Engineer	AC1 / Tim
Test Mode	Transmit at 2440MHz by BLE 2Mbps	Test Voltage	AC 120V/60Hz

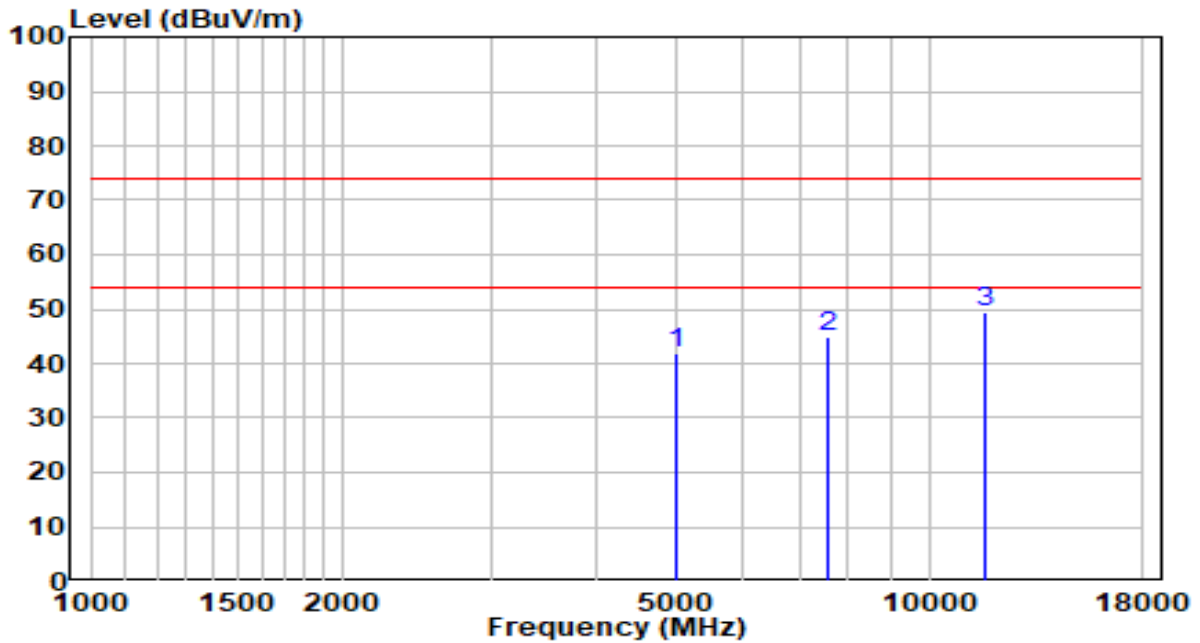

No	Frequency (MHz)	Reading (dB $\mu$ V)	C.F (dB/m)	Measurement (dB $\mu$ V/m)	Margin (dB)	Limit (dB $\mu$ V/m)	Remark (QP/PK/AV)
1	5003.500	37.88	3.96	41.84	-32.16	74.00	Peak
2	7579.000	31.95	13.08	45.03	-28.97	74.00	Peak
3	* 11633.500	29.50	19.75	49.25	-24.75	74.00	Peak

Note:

1. " \*", means this data is the worst emission level.
2. C.F (Correction Factor) = Antenna Factor (dB/m)+ Cable Loss (dB)– Preamplifier(dB).
3. Measurement(dB $\mu$ V/m) = Reading(dB $\mu$ V) + C.F (Correction Factor).

EUT	OmniAccess Stellar	Date of Test	2021-11-13
Factor	BBHA 9120D (1GHz~18GHz)	Temp. / Humidity	23°C/53%
Polarity	Horizontal	Site / Test Engineer	AC1 / Tim
Test Mode	Transmit at 2480MHz by BLE 2Mbps	Test Voltage	AC 120V/60Hz

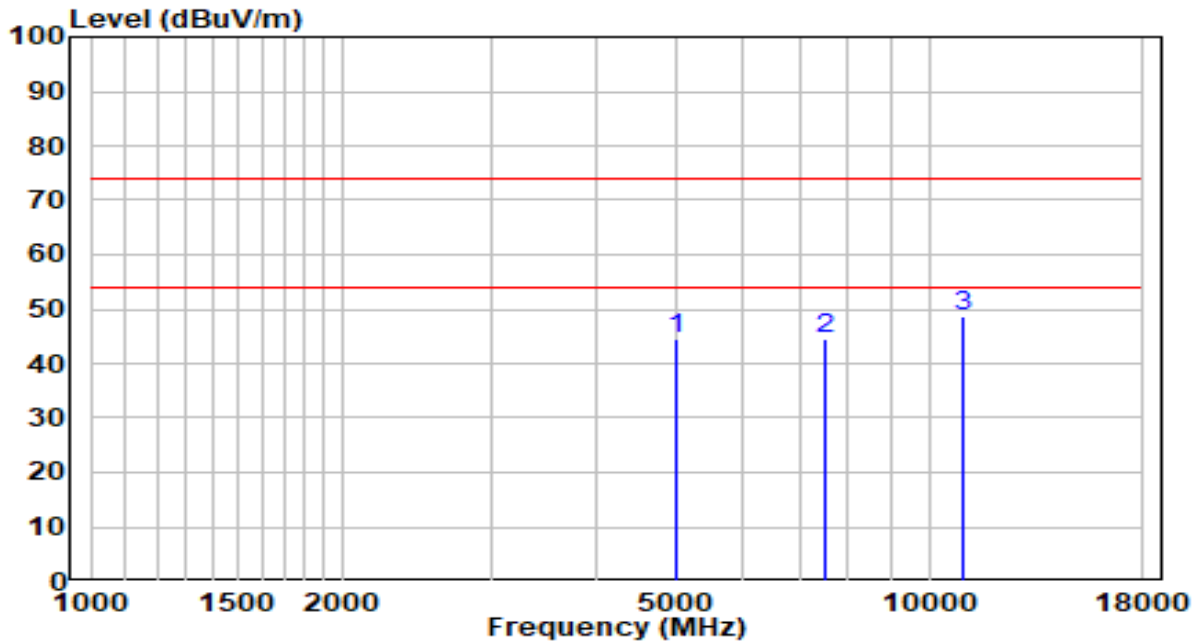

No	Frequency (MHz)	Reading (dB $\mu$ V)	C.F (dB/m)	Measurement (dB $\mu$ V/m)	Margin (dB)	Limit (dB $\mu$ V/m)	Remark (QP/PK/AV)
1	5003.500	40.69	3.96	44.65	-29.35	74.00	Peak
2	7511.000	31.46	13.02	44.48	-29.52	74.00	Peak
3	* 10996.000	29.59	19.27	48.86	-25.14	74.00	Peak

Note:

1. " \*", means this data is the worst emission level.
2. C.F (Correction Factor) = Antenna Factor (dB/m)+ Cable Loss (dB)– Preamplifier(dB).
3. Measurement(dB $\mu$ V/m) = Reading(dB $\mu$ V) + C.F (Correction Factor).

EUT	OmniAccess Stellar	Date of Test	2021-11-13
Factor	BBHA 9120D (1GHz~18GHz)	Temp. / Humidity	23°C/53%
Polarity	Vertical	Site / Test Engineer	AC1 / Tim
Test Mode	Transmit at 2480MHz by BLE 2Mbps	Test Voltage	AC 120V/60Hz

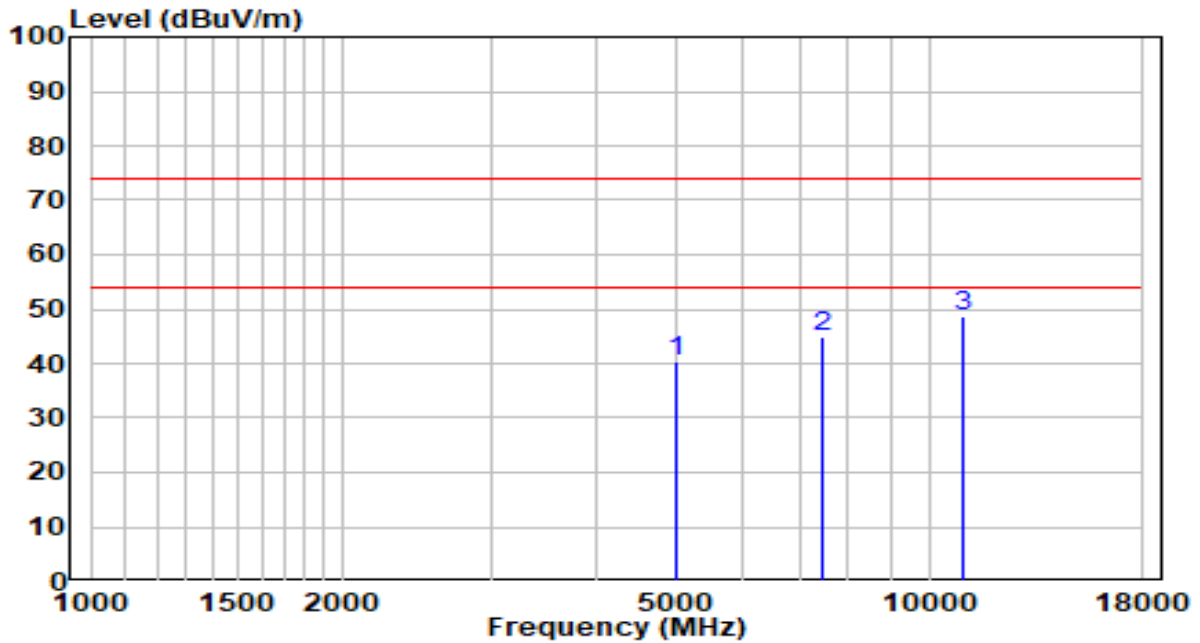

No	Frequency (MHz)	Reading (dBμV)	C.F (dB/m)	Measurement (dBμV/m)	Margin (dB)	Limit (dBμV/m)	Remark (QP/PK/AV)
1	5003.500	36.56	3.96	40.52	-33.48	74.00	Peak
2	7460.000	31.98	12.84	44.82	-29.18	74.00	Peak
3	* 10996.000	29.31	19.27	48.58	-25.42	74.00	Peak

Note:

1. " \*", means this data is the worst emission level.
2. C.F (Correction Factor) = Antenna Factor (dB/m)+ Cable Loss (dB)– Preamplifier(dB).
3. Measurement(dBμV/m) = Reading(dBμV) + C.F (Correction Factor).

EUT	OmniAccess Stellar	Date of Test	2021-11-13
Factor	BBHA 9120D (1GHz~18GHz)	Temp. / Humidity	23°C/53%
Polarity	Horizontal	Site / Test Engineer	AC1 / Tim
Test Mode	Transmit at 2402MHz by BLE 2Mbps	Test Voltage	AC 120V/60Hz

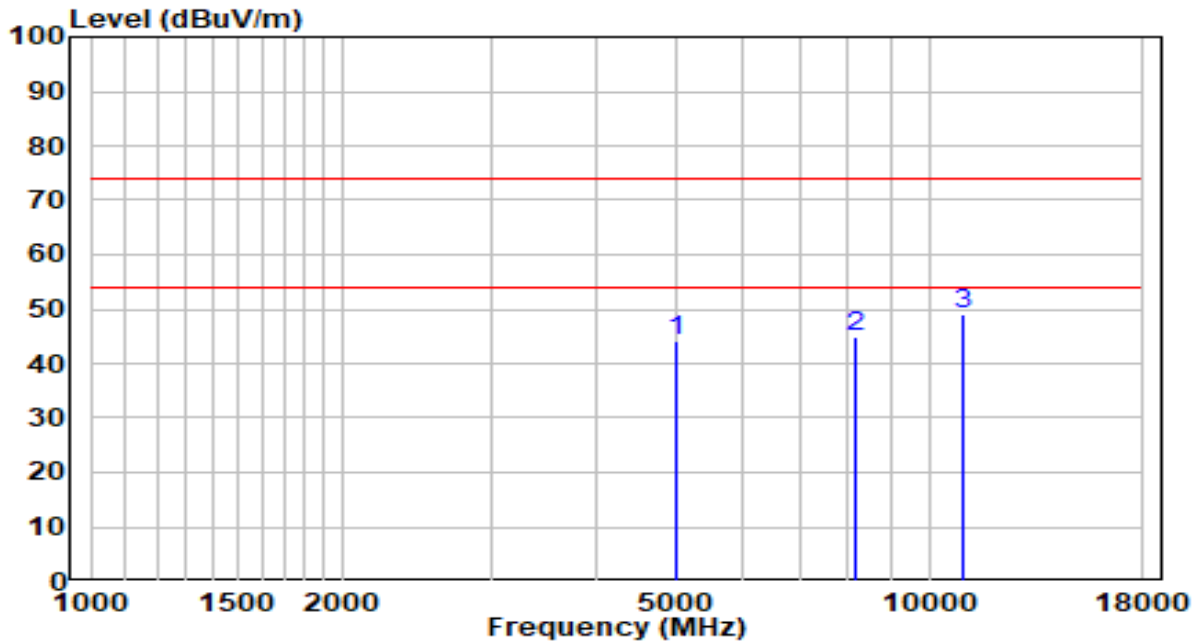

No	Frequency (MHz)	Reading (dBμV)	C.F (dB/m)	Measurement (dBμV/m)	Margin (dB)	Limit (dBμV/m)	Remark (QP/PK/AV)
1	5003.500	40.09	3.96	44.05	-29.95	74.00	Peak
2	8157.000	31.41	13.50	44.91	-29.09	74.00	Peak
3	* 10996.000	29.64	19.27	48.91	-25.09	74.00	Peak

Note:

1. " \*", means this data is the worst emission level.
2. C.F (Correction Factor) = Antenna Factor (dB/m)+ Cable Loss (dB)– Preamplifier(dB).
3. Measurement(dBμV/m) = Reading(dBμV) + C.F (Correction Factor).

**The Result of Radiated Spurious Emission below 1GHz:**

EUT	OmniAccess Stellar	Date of Test	2021-11-13
Factor	VULB 9162	Temp. / Humidity	21°C /47%
Polarity	Horizontal	Site / Test Engineer	AC1 / Tim
Test Mode	Transmit by BLE at channel 2402MHz	Test Voltage	AC 120V/60Hz

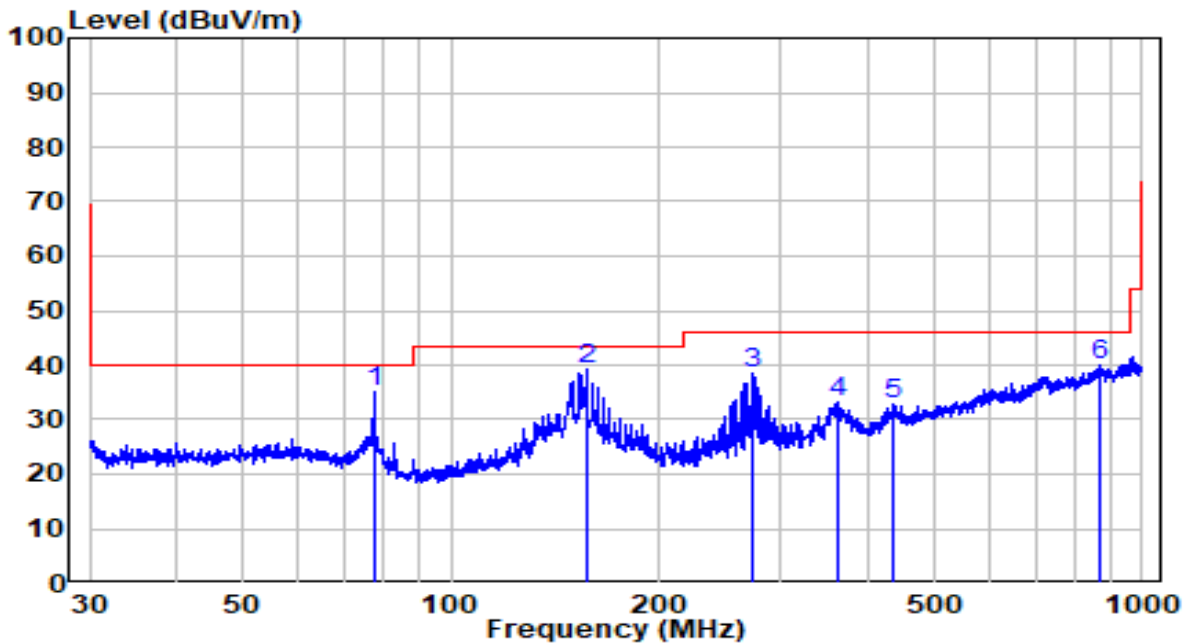

No	Frequency (MHz)	Reading (dBμV)	C.F (dB/m)	Measurement (dBμV/m)	Margin (dB)	Limit (dBμV/m)	Remark (QP/PK/AV)
1	77.321	20.03	15.05	35.08	-4.92	40.00	Peak
2	* 156.732	22.96	16.21	39.16	-4.34	43.50	Peak
3	272.278	17.65	20.78	38.43	-7.57	46.00	Peak
4	361.714	9.96	23.42	33.38	-12.62	46.00	Peak
5	434.827	8.12	24.64	32.76	-13.24	46.00	Peak
6	870.655	8.58	31.60	40.18	-5.82	46.00	Peak

**Note:**

1. " \*", means this data is the worst emission level.
2. C.F (Correction Factor) = Antenna Factor (dB/m)+ Cable Loss (dB).
3. Measurement(dBμV/m) = Reading(dBμV) + C.F (Correction Factor).
4. The amplitude of Radiated emissions (the test frequency range: 9kHz ~ 30MHz, 18GHz ~ 25GHz), is that proximity to ambient noise, which also are attenuated more than 20 dB below the permissible value. Therefore, the data is not presented in the report.



EUT	OmniAccess Stellar	Date of Test	2021-11-13
Factor	VULB 9162	Temp. / Humidity	21°C /47%
Polarity	Vertical	Site / Test Engineer	AC1 / Tim
Test Mode	Transmit by BLE at channel 2402MHz	Test Voltage	AC 120V/60Hz

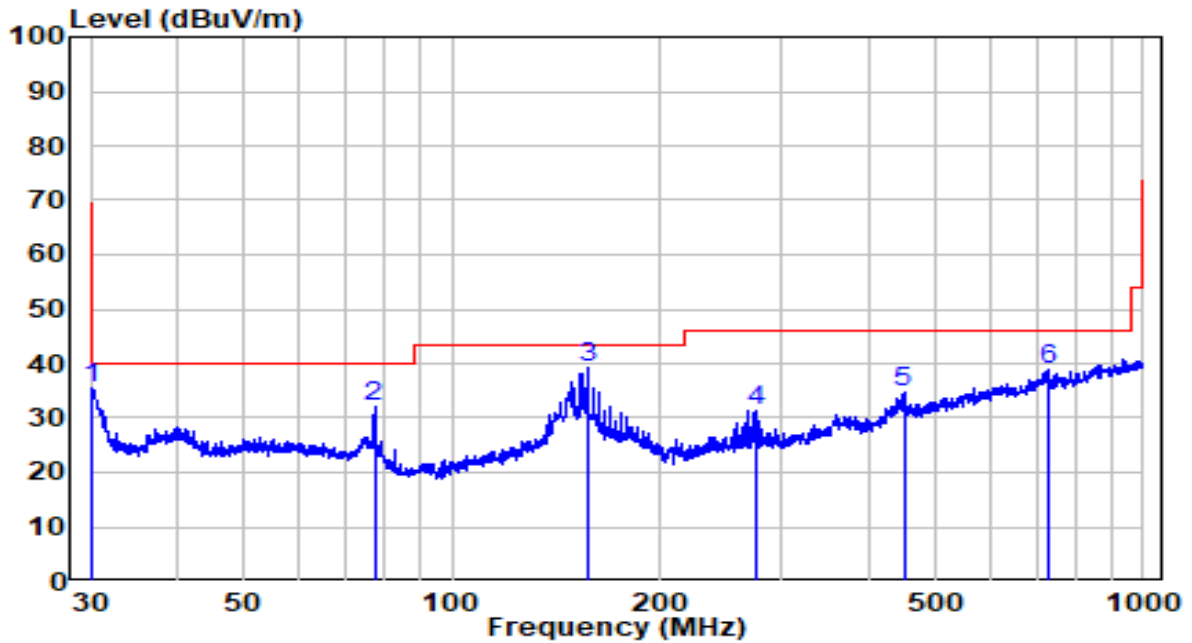

No	Frequency (MHz)	Reading (dB $\mu$ V)	C.F (dB/m)	Measurement (dB $\mu$ V/m)	Margin (dB)	Limit (dB $\mu$ V/m)	Remark (QP/PK/AV)
1	30.000	16.91	18.40	35.31	-4.69	40.00	Peak
2	77.186	16.98	15.09	32.07	-7.93	40.00	Peak
3	* 156.732	23.15	16.21	39.36	-4.14	43.50	Peak
4	275.157	10.60	20.88	31.48	-14.52	46.00	Peak
5	450.345	9.81	24.90	34.71	-11.29	46.00	Peak
6	728.081	9.00	29.76	38.76	-7.24	46.00	Peak

Note:

1. " \*", means this data is the worst emission level.
2. C.F (Correction Factor) = Antenna Factor (dB/m)+ Cable Loss (dB).
3. Measurement(dB $\mu$ V/m) = Reading(dB $\mu$ V) + C.F (Correction Factor).
4. The amplitude of Radiated emissions (the test frequency range: 9kHz ~ 30MHz, 18GHz ~ 25GHz), is that proximity to ambient noise, which also are attenuated more than 20 dB below the permissible value. Therefore, the data is not presented in the report.

## 7.7. Radiated Restricted Band Edge Measurement

### 7.7.1. Test Limit

#### For 15.205 requirement:

Radiated emissions which fall in the restricted bands, as defined in Section 15.205(a) of FCC part 15, must also comply with the radiated emission limits specified in Section 15.209(a).

Frequency (MHz)	Frequency (MHz)	Frequency (MHz)	Frequency (GHz)
0.090 - 0.110	16.42 - 16.423	399.9 - 410	4.5 - 5.15
<sup>1</sup> 0.495 - 0.505	16.69475 - 16.69525	608 - 614	5.35 - 5.46
2.1735 - 2.1905	16.80425 - 16.80475	960 - 1240	7.25 - 7.75
4.125 - 4.128	25.5 - 25.67	1300 - 1427	8.025 - 8.5
4.17725 - 4.17775	37.5 - 38.25	1435 - 1626.5	9.0 - 9.2
4.20725 - 4.20775	73 - 74.6	1645.5 - 1646.5	9.3 - 9.5
6.215 - 6.218	74.8 - 75.2	1660 - 1710	10.6 - 12.7
6.26775 - 6.26825	108 - 121.94	1718.8 - 1722.2	13.25 - 13.4
6.31175 - 6.31225	123 - 138	2200 - 2300	14.47 - 14.5
8.291 - 8.294	149.9 - 150.05	2310 - 2390	15.35 - 16.2
8.362 - 8.366	156.52475 - 156.525	2483.5 - 2500	17.7 - 21.4
8.37625 - 8.38675	156.7 - 156.9	2690 - 2900	22.01 - 23.12
8.41425 - 8.41475	162.0125 - 167.17	3260 - 3267	23.6 - 24.0
12.29 - 12.293	167.72 - 173.2	3332 - 3339	31.2 - 31.8
12.51975 - 12.52025	240 - 285	3345.8 - 3358	36.43 - 36.5
12.57675 - 12.57725	322 - 335.4	3600 - 4400	( <sup>2</sup> )
13.36 - 13.41	--	--	--

All out of band emissions appearing in a restricted band as specified in Section 15.205 of the Title 47CFR must not exceed the limits shown in Table per Section 15.209.

FCC Part 15 Subpart C Paragraph 15.209		
Frequency [MHz]	Field Strength [ $\mu$ V/m]	Measured Distance [Meters]
0.009 - 0.490	2400/F (kHz)	300
0.490 - 1.705	24000/F (kHz)	30
1.705 - 30	30	30
30 - 88	100	3
88 - 216	150	3
216 - 960	200	3
Above 960	500	3

### 7.7.2. Test Procedure Used

ANSI C63.10-2013 Section 6.3 (General Requirements)

ANSI C63.10-2013 Section 6.6 (Standard test method above 1GHz)

ANSI C63.10-2013 Section 11.13

### 7.7.3. Test Setting

#### Peak Field Strength Measurements

1. Analyzer center frequency was set to the frequency of the radiated spurious emission of interest
2. RBW = 1MHz
3. VBW = 3MHz
4. Detector = peak
5. Sweep time = auto couple
6. Trace mode = max hold
7. Trace was allowed to stabilize

### Average Field Strength Measurements

1. Analyzer center frequency was set to the frequency of the radiated spurious emission of interest
2. RBW = 1MHz
3. VBW  $\geq 1/T$ , (For 1Mbps, VBW = 10kHz; For 2Mbps, VBW = 20kHz)
4. Average Type = Voltage
5. Detector = Peak
6. Sweep time = auto
7. Trace mode = max hold
8. Trace was allowed to stabilize

#### 7.7.4. Test Setup

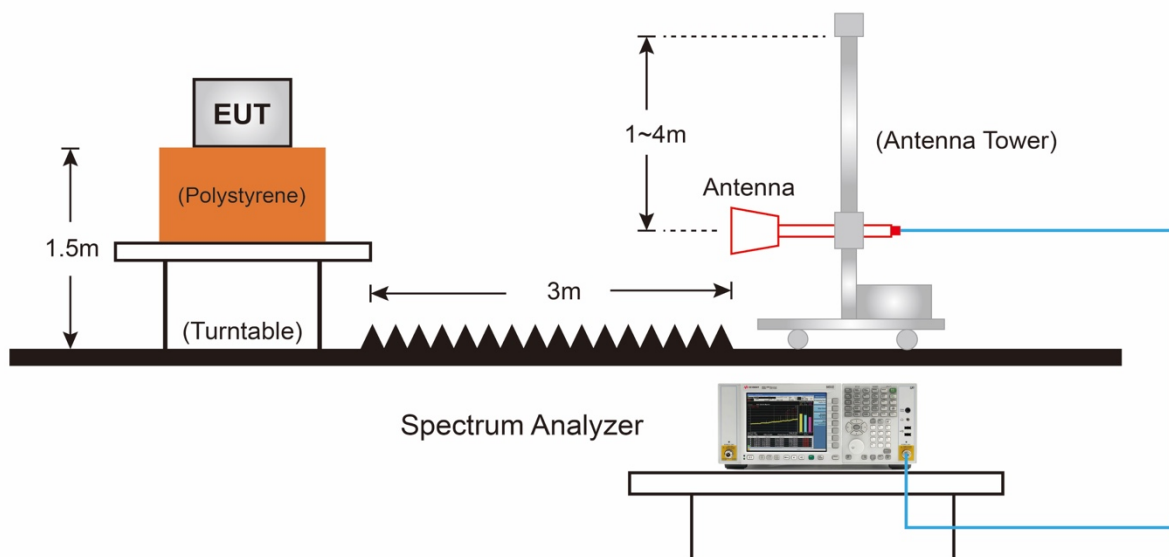

**7.7.5. Test Result**

EUT	OmniAccess Stellar	Date of Test	2021-09-29
Factor	DRH18-E	Temp. / Humidity	23°C /49%
Polarity	Horizontal	Site / Test Engineer	AC2 / Jay
Test Mode	BLE_TX_1Mbps_CH 0	Test Voltage	AC 120V/60Hz

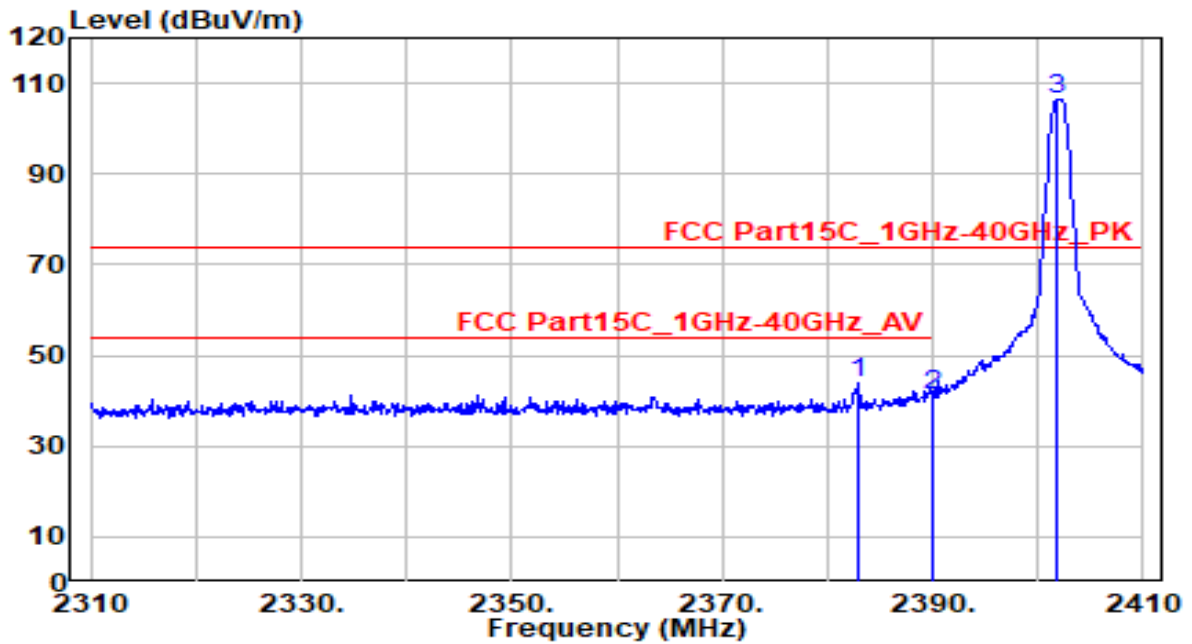

No	Frequency (MHz)	Reading (dB $\mu$ V)	C.F (dB/m)	Measurement (dB $\mu$ V/m)	Margin (dB)	Limit (dB $\mu$ V/m)	Height (cm)	Angle (deg)	Remark (QP/PK/AV)
1	2382.900	49.84	-5.99	43.86	-30.14	74.00	150	210	Peak
2	2390.000	47.25	-5.97	41.27	-32.73	74.00	150	210	Peak
3	* 2401.900	112.35	-5.96	106.40	N/A	N/A	150	210	Peak

Note:

1. " \*", means this data is the worst emission level.
2. C.F (Correction Factor) = Antenna Factor (dB/m)+ Cable Loss (dB) – Preamplifier(dB).
3. Measurement (dB $\mu$ V/m) = Reading(dB $\mu$ V) + C.F (Correction Factor).
4. The emission levels of other frequencies are very lower than the limit and not show in test report.

EUT	OmniAccess Stellar	Date of Test	2021-09-29
Factor	DRH18-E	Temp. / Humidity	23°C /49%
Polarity	Vertical	Site / Test Engineer	AC2 / Jay
Test Mode	BLE_TX_1Mbps_CH 0	Test Voltage	AC 120V/60Hz

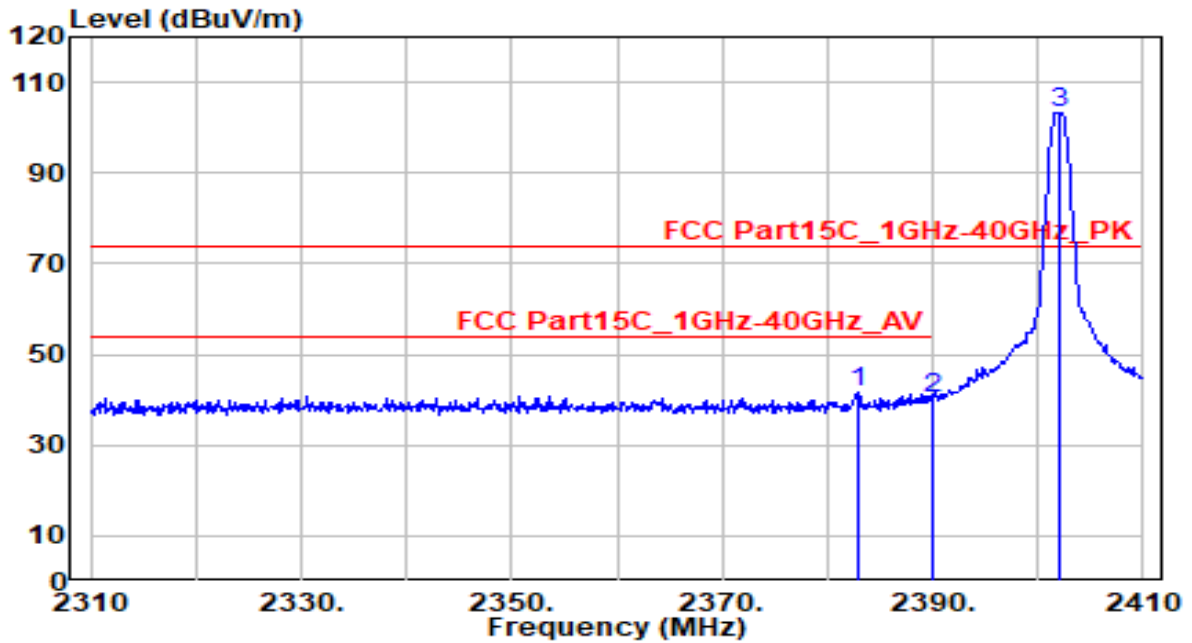

No	Frequency (MHz)	Reading (dBμV)	C.F (dB/m)	Measurement (dBμV/m)	Margin (dB)	Limit (dBμV/m)	Height (cm)	Angle (deg)	Remark (QP/PK/AV)
1	2382.900	47.69	-5.99	41.70	-32.30	74.00	200	200	Peak
2	2390.000	46.08	-5.97	40.10	-33.90	74.00	200	200	Peak
3	* 2402.000	109.41	-5.96	103.45	N/A	N/A	200	200	Peak

Note:

1. " \*", means this data is the worst emission level.
2. C.F (Correction Factor) = Antenna Factor (dB/m)+ Cable Loss (dB) – Pre-amplifier(dB).
3. Measurement (dBμV/m) = Reading(dBμV) + C.F (Correction Factor).
4. The emission levels of other frequencies are very lower than the limit and not show in test report.

EUT	OmniAccess Stellar	Date of Test	2021-09-29
Factor	DRH18-E	Temp. / Humidity	23°C /49%
Polarity	Horizontal	Site / Test Engineer	AC2 / Jay
Test Mode	BLE_TX_1Mbps_CH 39	Test Voltage	AC 120V/60Hz

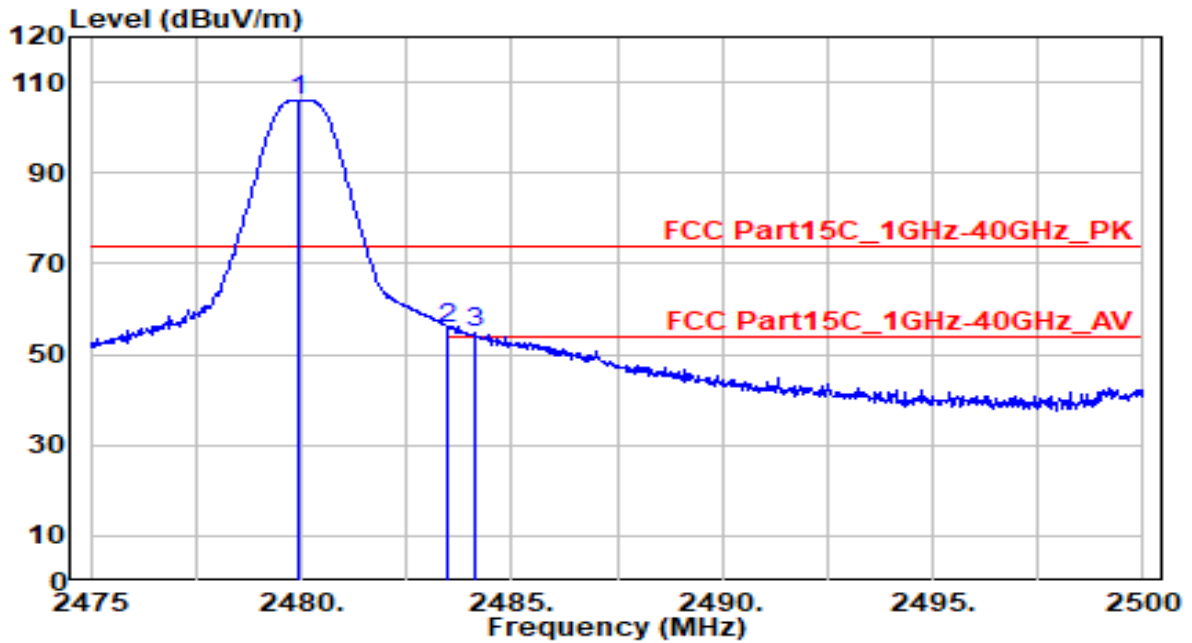

No	Frequency (MHz)	Reading (dBμV)	C.F (dB/m)	Measurement (dBμV/m)	Margin (dB)	Limit (dBμV/m)	Height (cm)	Angle (deg)	Remark (QP/PK/AV)	
1	*	2479.950	111.75	-5.87	105.88	N/A	N/A	150	210	Peak
2		2483.500	61.79	-5.86	55.92	-18.08	74.00	150	210	Peak
3		2484.100	60.43	-5.86	54.57	-19.43	74.00	150	210	Peak

Note:

1. " \*", means this data is the worst emission level.
2. C.F (Correction Factor) = Antenna Factor (dB/m)+ Cable Loss (dB) – Preamplifier(dB).
3. Measurement (dBμV/m) = Reading(dBμV) + C.F (Correction Factor).
4. The emission levels of other frequencies are very lower than the limit and not show in test report.

EUT	OmniAccess Stellar	Date of Test	2021-09-29
Factor	DRH18-E	Temp. / Humidity	23°C /49%
Polarity	Horizontal	Site / Test Engineer	AC2 / Jay
Test Mode	BLE_TX_1Mbps_CH 39	Test Voltage	AC 120V/60Hz

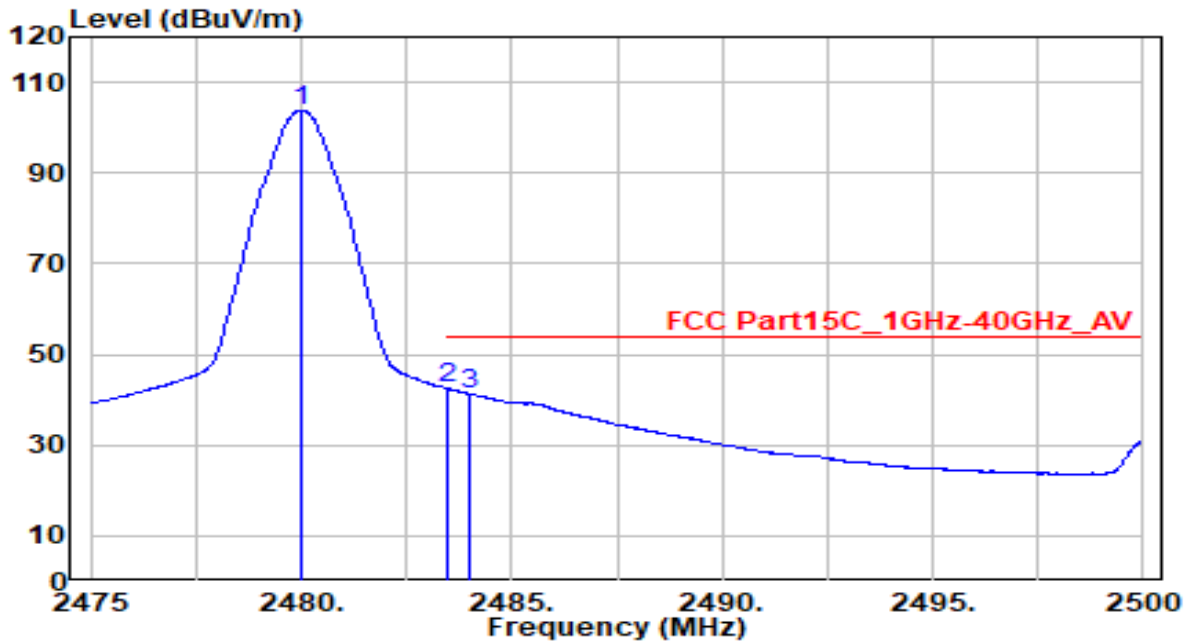

No	Frequency (MHz)	Reading (dB $\mu$ V)	C.F (dB/m)	Measurement (dB $\mu$ V/m)	Margin (dB)	Limit (dB $\mu$ V/m)	Height (cm)	Angle (deg)	Remark (QP/PK/AV)
1	2480.025	109.76	-5.87	103.90	N/A	N/A	150	210	Average
2	* 2483.500	48.27	-5.86	42.41	-11.59	54.00	150	210	Average
3	2483.975	47.27	-5.86	41.40	-12.60	54.00	150	210	Average

Note:

1. " \*", means this data is the worst emission level.
2. C.F (Correction Factor) = Antenna Factor (dB/m)+ Cable Loss (dB) – Pre-amplifier(dB).
3. Measurement (dB $\mu$ V/m) = Reading(dB $\mu$ V) + C.F (Correction Factor).
4. The emission levels of other frequencies are very lower than the limit and not show in test report.



EUT	OmniAccess Stellar	Date of Test	2021-09-29
Factor	DRH18-E	Temp. / Humidity	23°C /49%
Polarity	Vertical	Site / Test Engineer	AC2 / Jay
Test Mode	BLE_TX_1Mbps_CH 39	Test Voltage	AC 120V/60Hz

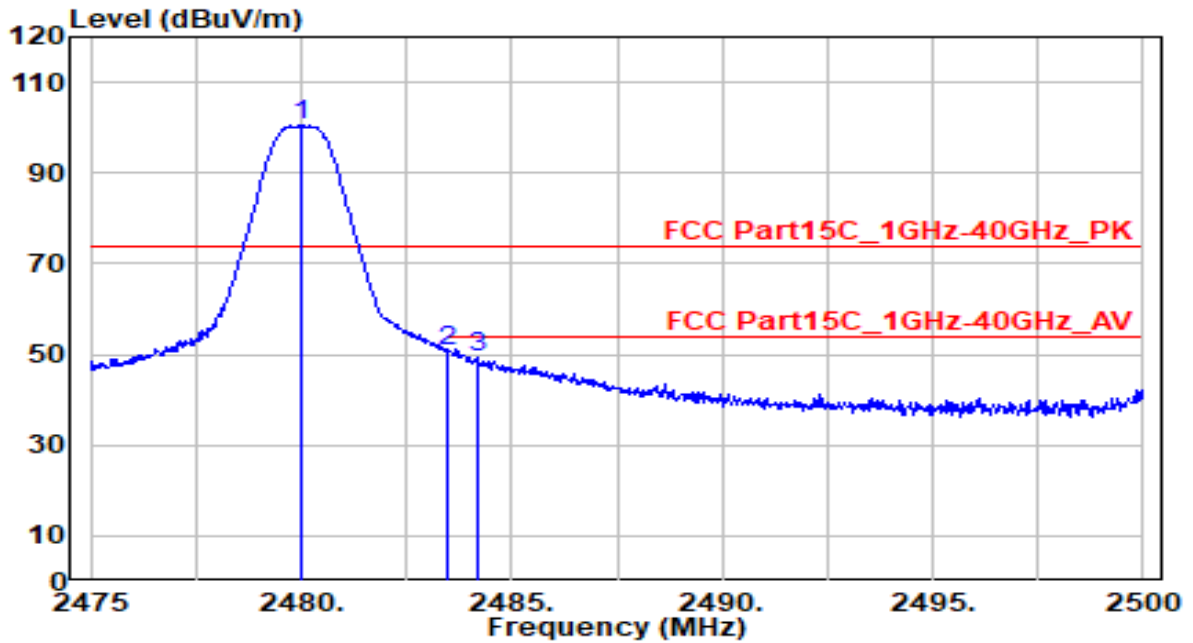

No	Frequency (MHz)	Reading (dBμV)	C.F (dB/m)	Measurement (dBμV/m)	Margin (dB)	Limit (dBμV/m)	Height (cm)	Angle (deg)	Remark (QP/PK/AV)
1	* 2480.000	106.22	-5.87	100.35	N/A	N/A	195	170	Peak
2	2483.500	56.66	-5.86	50.80	-23.20	74.00	195	170	Peak
3	2484.200	55.04	-5.86	49.18	-24.82	74.00	195	170	Peak

Note:

1. " \*", means this data is the worst emission level.
2. C.F (Correction Factor) = Antenna Factor (dB/m)+ Cable Loss (dB) – Preamplifier(dB).
3. Measurement (dBμV/m) = Reading(dBμV) + C.F (Correction Factor).
4. The emission levels of other frequencies are very lower than the limit and not show in test report.

EUT	OmniAccess Stellar	Date of Test	2021-09-29
Factor	DRH18-E	Temp. / Humidity	23°C /49%
Polarity	Horizontal	Site / Test Engineer	AC2 / Jay
Test Mode	BLE_TX_2Mbps_CH 0	Test Voltage	AC 120V/60Hz

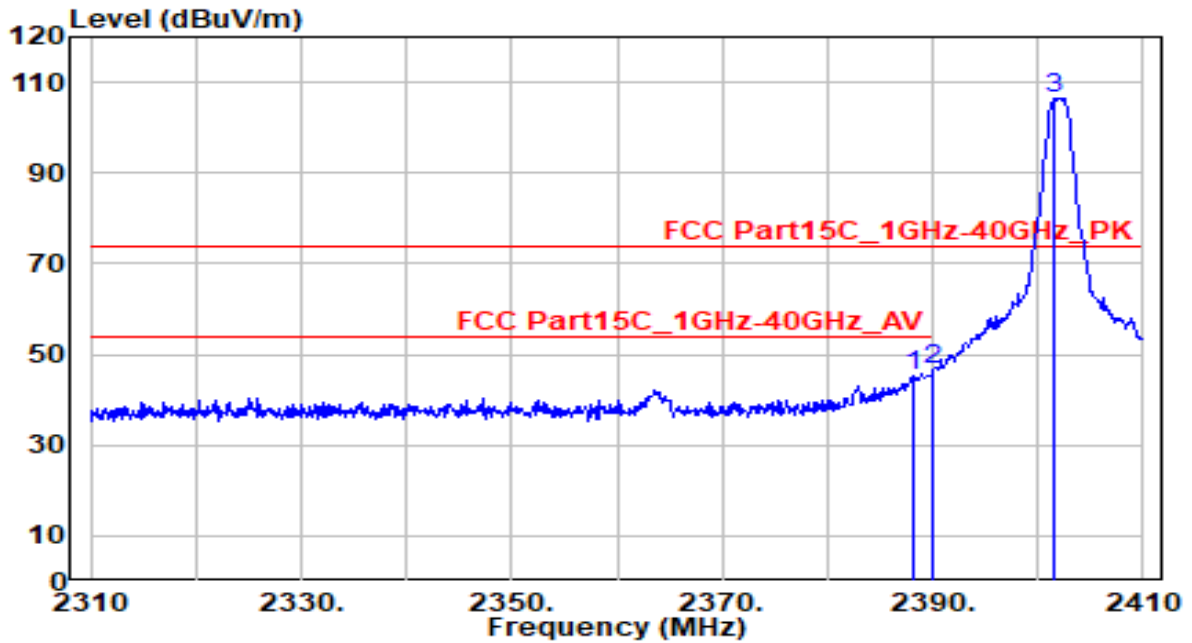

No	Frequency (MHz)	Reading (dB $\mu$ V)	C.F (dB/m)	Measurement (dB $\mu$ V/m)	Margin (dB)	Limit (dB $\mu$ V/m)	Height (cm)	Angle (deg)	Remark (QP/PK/AV)
1	2388.200	51.13	-5.98	45.15	-28.85	74.00	150	210	Peak
2	2390.000	52.65	-5.97	46.68	-27.32	74.00	150	210	Peak
3	* 2401.500	112.36	-5.96	106.40	N/A	N/A	150	210	Peak

Note:

1. " \*", means this data is the worst emission level.
2. C.F (Correction Factor) = Antenna Factor (dB/m)+ Cable Loss (dB) – Preamplifier(dB).
3. Measurement (dB $\mu$ V/m) = Reading(dB $\mu$ V) + C.F (Correction Factor).
4. The emission levels of other frequencies are very lower than the limit and not show in test report.

EUT	OmniAccess Stellar	Date of Test	2021-09-29
Factor	DRH18-E	Temp. / Humidity	23°C /49%
Polarity	Vertical	Site / Test Engineer	AC2 / Jay
Test Mode	BLE_TX_2Mbps_CH 0	Test Voltage	AC 120V/60Hz

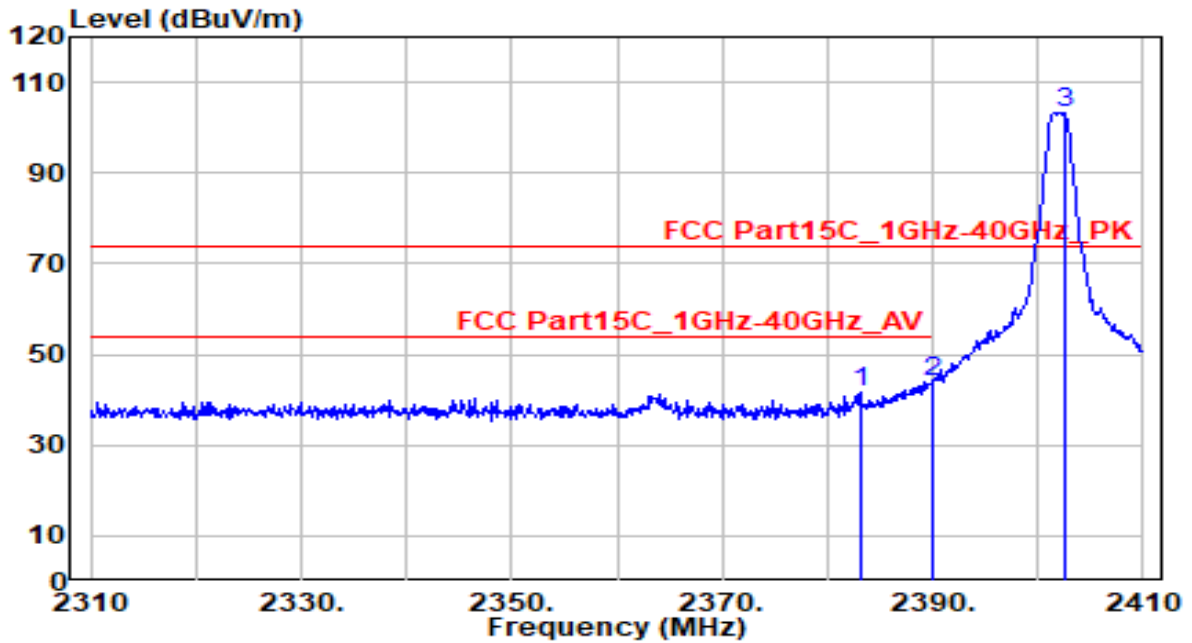

No	Frequency (MHz)	Reading (dB $\mu$ V)	C.F (dB/m)	Measurement (dB $\mu$ V/m)	Margin (dB)	Limit (dB $\mu$ V/m)	Height (cm)	Angle (deg)	Remark (QP/PK/AV)
1	2383.100	47.72	-5.99	41.73	-32.27	74.00	200	200	Peak
2	2390.000	49.88	-5.97	43.90	-30.10	74.00	200	200	Peak
3	* 2402.500	109.37	-5.96	103.41	N/A	N/A	200	200	Peak

Note:

1. " \*", means this data is the worst emission level.
2. C.F (Correction Factor) = Antenna Factor (dB/m)+ Cable Loss (dB) – Pre-amplifier(dB).
3. Measurement (dB $\mu$ V/m) = Reading(dB $\mu$ V) + C.F (Correction Factor).
4. The emission levels of other frequencies are very lower than the limit and not show in test report.

EUT	OmniAccess Stellar	Date of Test	2021-09-29
Factor	DRH18-E	Temp. / Humidity	23°C /49%
Polarity	Horizontal	Site / Test Engineer	AC2 / Jay
Test Mode	BLE_TX_2Mbps_CH 39	Test Voltage	AC 120V/60Hz

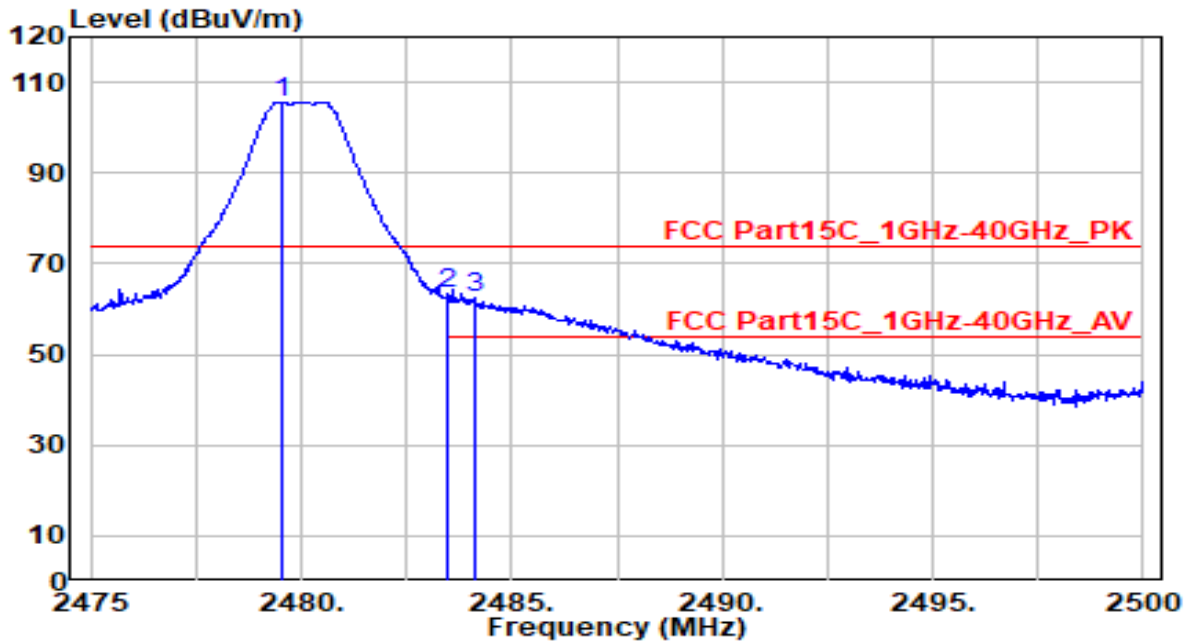

No	Frequency (MHz)	Reading (dB $\mu$ V)	C.F (dB/m)	Measurement (dB $\mu$ V/m)	Margin (dB)	Limit (dB $\mu$ V/m)	Height (cm)	Angle (deg)	Remark (QP/PK/AV)	
1	*	2479.525	111.58	-5.87	105.71	N/A	N/A	150	210	Peak
2		2483.500	69.16	-5.86	63.30	-10.70	74.00	150	210	Peak
3		2484.150	68.23	-5.86	62.37	-11.63	74.00	150	210	Peak

Note:

1. " \*", means this data is the worst emission level.
2. C.F (Correction Factor) = Antenna Factor (dB/m)+ Cable Loss (dB) – Pre-amplifier(dB).
3. Measurement (dB $\mu$ V/m) = Reading(dB $\mu$ V) + C.F (Correction Factor).
4. The emission levels of other frequencies are very lower than the limit and not show in test report.

EUT	OmniAccess Stellar	Date of Test	2021-09-29
Factor	DRH18-E	Temp. / Humidity	23°C /49%
Polarity	Horizontal	Site / Test Engineer	AC2 / Jay
Test Mode	BLE_TX_2Mbps_CH 39	Test Voltage	AC 120V/60Hz

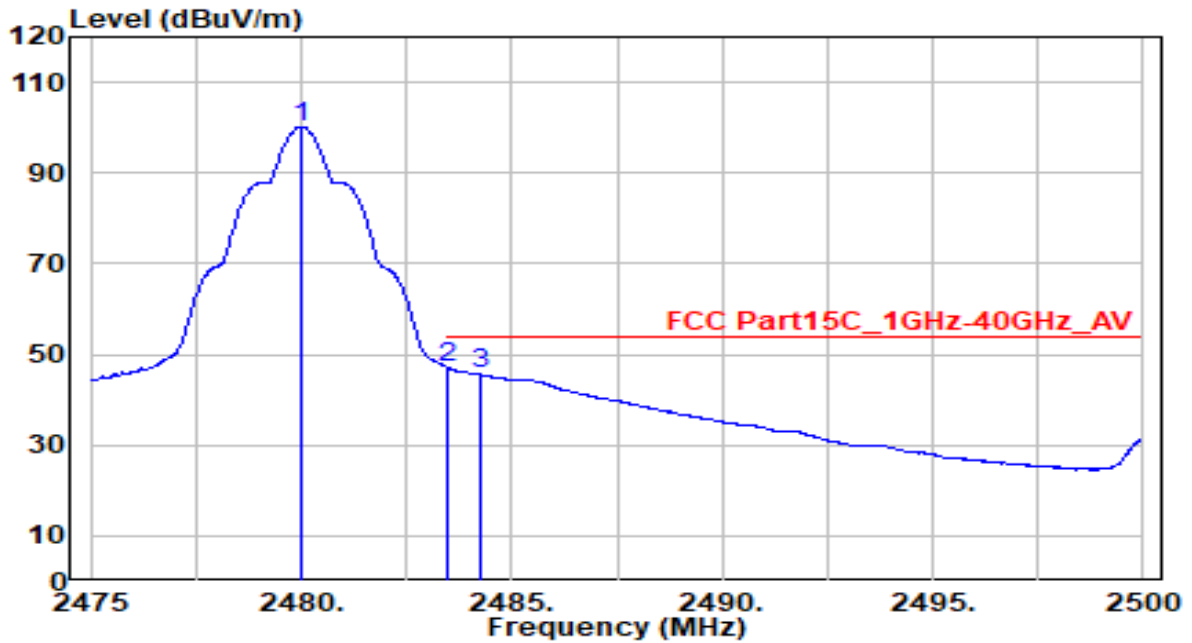

No	Frequency (MHz)	Reading (dBμV)	C.F (dB/m)	Measurement (dBμV/m)	Margin (dB)	Limit (dBμV/m)	Height (cm)	Angle (deg)	Remark (QP/PK/AV)
1	2480.000	106.03	-5.87	100.16	N/A	N/A	150	210	Average
2	* 2483.500	52.85	-5.86	46.99	-7.01	54.00	150	210	Average
3	2484.275	51.43	-5.86	45.56	-8.44	54.00	150	210	Average

Note:

1. " \*", means this data is the worst emission level.
2. C.F (Correction Factor) = Antenna Factor (dB/m)+ Cable Loss (dB) – Preamplifier(dB).
3. Measurement (dBμV/m) = Reading(dBμV) + C.F (Correction Factor).
4. The emission levels of other frequencies are very lower than the limit and not show in test report.

EUT	OmniAccess Stellar	Date of Test	2021-09-29
Factor	DRH18-E	Temp. / Humidity	23°C /49%
Polarity	Vertical	Site / Test Engineer	AC2 / Jay
Test Mode	BLE_TX_2Mbps_CH 39	Test Voltage	AC 120V/60Hz

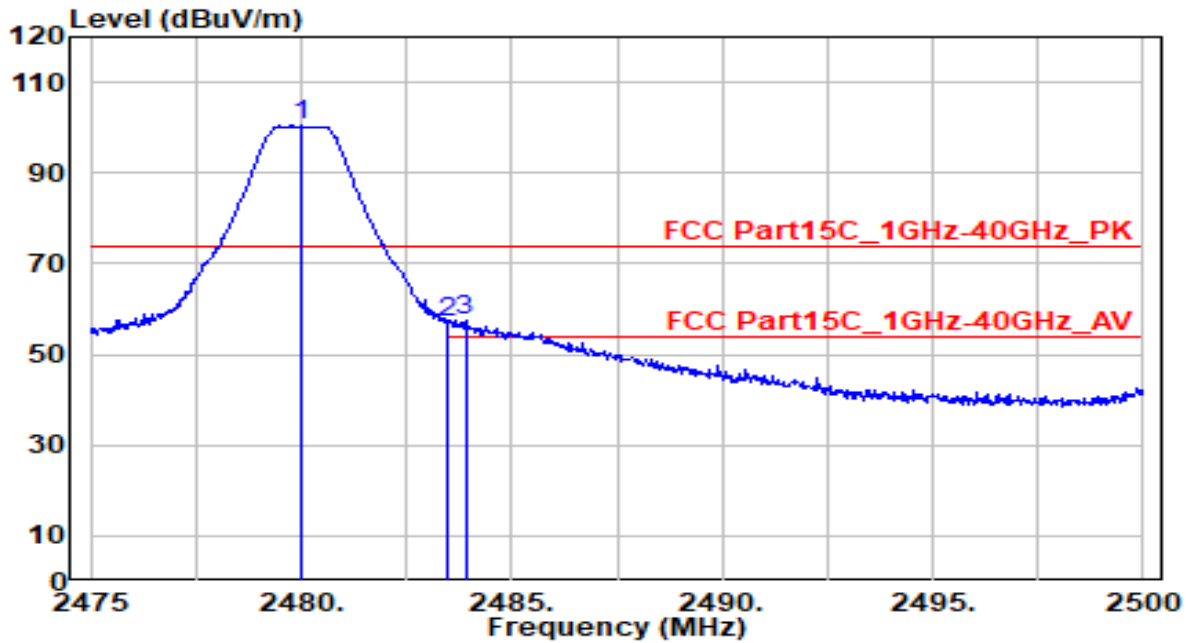

No	Frequency (MHz)	Reading (dB $\mu$ V)	C.F (dB/m)	Measurement (dB $\mu$ V/m)	Margin (dB)	Limit (dB $\mu$ V/m)	Height (cm)	Angle (deg)	Remark (QP/PK/AV)	
1	*	2479.975	106.20	-5.87	100.33	N/A	N/A	195	170	Peak
2		2483.500	62.93	-5.86	57.06	-16.94	74.00	195	170	Peak
3		2483.900	63.52	-5.86	57.66	-16.34	74.00	195	170	Peak

Note:

1. " \*", means this data is the worst emission level.
2. C.F (Correction Factor) = Antenna Factor (dB/m)+ Cable Loss (dB) – Pre-amplifier(dB).
3. Measurement (dB $\mu$ V/m) = Reading(dB $\mu$ V) + C.F (Correction Factor).
4. The emission levels of other frequencies are very lower than the limit and not show in test report.

EUT	OmniAccess Stellar	Date of Test	2021-09-29
Factor	DRH18-E	Temp. / Humidity	23°C /49%
Polarity	Vertical	Site / Test Engineer	AC2 / Jay
Test Mode	BLE_TX_2Mbps_CH 39	Test Voltage	AC 120V/60Hz

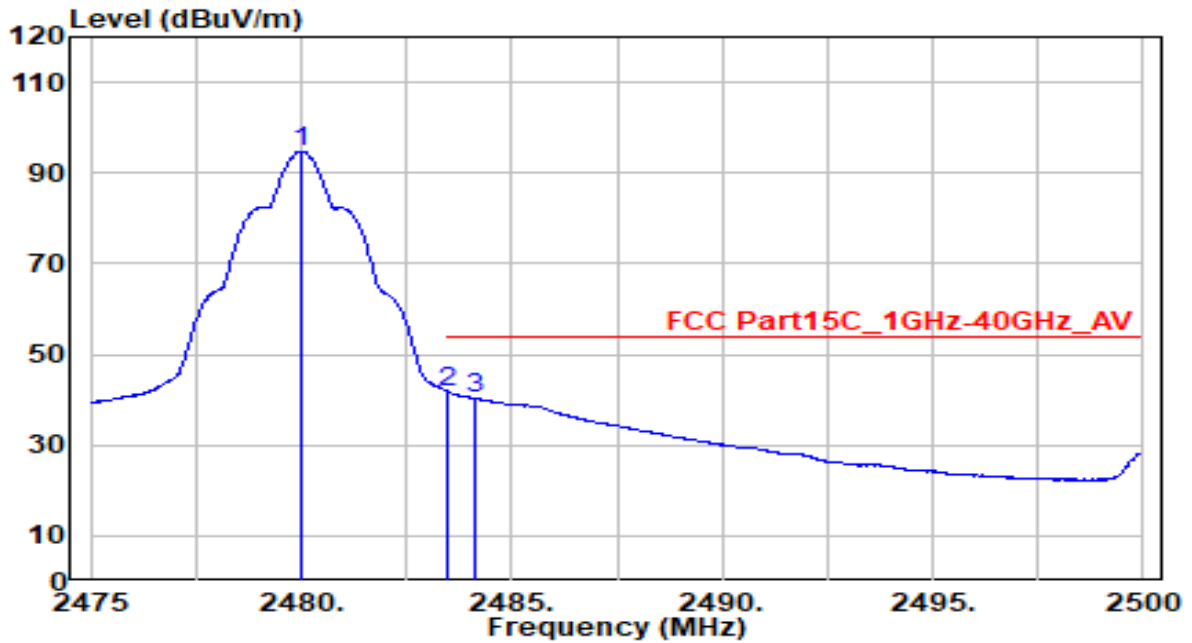

No	Frequency (MHz)	Reading (dB $\mu$ V)	C.F (dB/m)	Measurement (dB $\mu$ V/m)	Margin (dB)	Limit (dB $\mu$ V/m)	Height (cm)	Angle (deg)	Remark (QP/PK/AV)
1	2480.000	100.58	-5.87	94.72	N/A	N/A	195	170	Average
2	* 2483.500	47.52	-5.86	41.66	-12.34	54.00	195	170	Average
3	2484.100	46.30	-5.86	40.44	-13.56	54.00	195	170	Average

Note:

1. " \*", means this data is the worst emission level.
2. C.F (Correction Factor) = Antenna Factor (dB/m)+ Cable Loss (dB) – Preamplifier(dB).
3. Measurement (dB $\mu$ V/m) = Reading(dB $\mu$ V) + C.F (Correction Factor).
4. The emission levels of other frequencies are very lower than the limit and not show in test report.

## 7.8. AC Conducted Emissions Measurement

### 7.8.1. Test Limit

FCC Part 15 Subpart C Paragraph 15.207 Limits		
Frequency (MHz)	QP (dB $\mu$ V)	AV (dB $\mu$ V)
0.15 - 0.50	66 - 56	56 - 46
0.50 - 5.0	56	46
5.0 - 30	60	50

Note 1: The lower limit shall apply at the transition frequencies.

Note 2: The limit decreases linearly with the logarithm of the frequency in the range 0.15MHz to 0.5MHz.

### 7.8.2. Test Setup

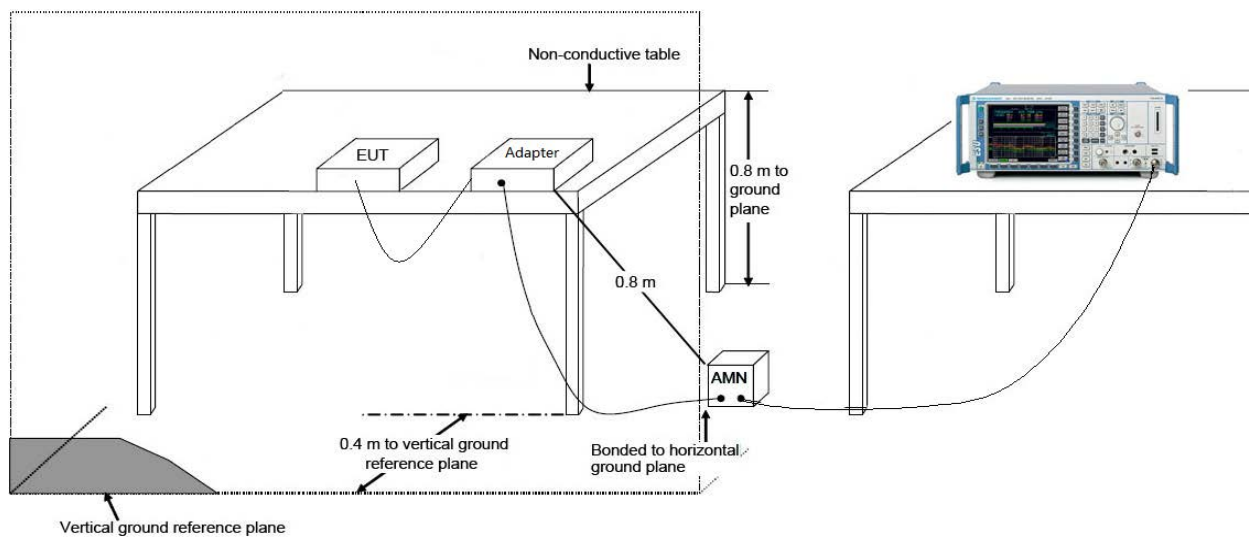



### 7.8.3. Test Result

EUT	OmniAccess Stellar	Date of Test	2021-11-05
Factor	CE_ENV216-N (Filter ON)	Temp. / Humidity	25.3°C / 57.6%
Polarity	Neutral	Site / Test Engineer	SR2 / Eric Lin
Test Mode	Transmit by BLE at channel 2402MHz	Test Voltage	AC 120V/60Hz

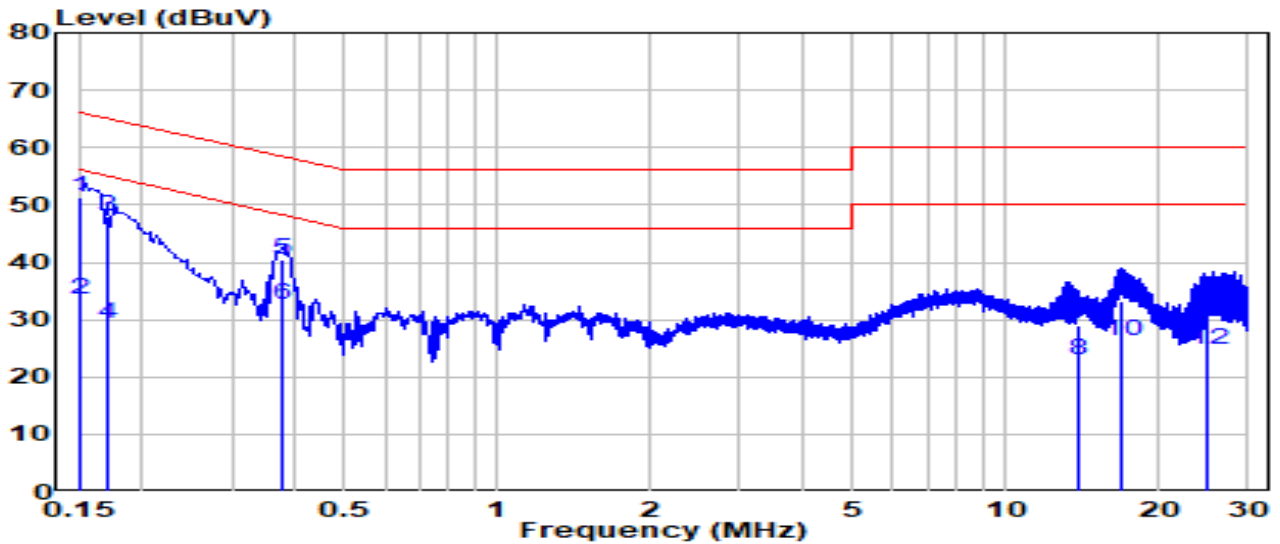

No	Frequency (MHz)	Reading (dBμV)	C.F (dB)	Measurement (dBμV)	Margin (dB)	Limit (dBμV)	Remark (QP/PK/AV)
1	*	41.69	9.62	51.31	-14.62	65.93	QP
2	0.151	23.89	9.62	33.51	-22.42	55.93	Average
3	0.172	38.49	9.62	48.11	-16.77	64.88	QP
4	0.172	19.69	9.62	29.31	-25.57	54.88	Average
5	0.379	30.77	9.64	40.41	-17.90	58.31	QP
6	0.379	22.97	9.64	32.61	-15.70	48.31	Average
7	13.877	18.96	9.99	28.95	-31.05	60.00	QP
8	13.877	13.06	9.99	23.05	-26.95	50.00	Average
9	16.940	23.29	10.04	33.33	-26.67	60.00	QP
10	16.940	16.29	10.04	26.33	-23.67	50.00	Average
11	24.974	20.73	10.18	30.91	-29.09	60.00	QP
12	24.974	14.53	10.18	24.71	-25.29	50.00	Average

Note:

1. " \*", means this data is the worst emission level.
2. C.F (Correction Factor) = LISN Factor (dB)+ Cable Loss (dB).
3. Measurement(dBμV) = Reading(dBμV) + C.F (Correction Factor).

EUT	OmniAccess Stellar	Date of Test	2021-11-05
Factor	CE_ENV216-L1 (Filter ON)	Temp. / Humidity	25.3°C / 57.6%
Polarity	Line	Site / Test Engineer	SR2 / Eric Lin
Test Mode	Transmit by BLE at channel 2402MHz	Test Voltage	AC 120V/60Hz

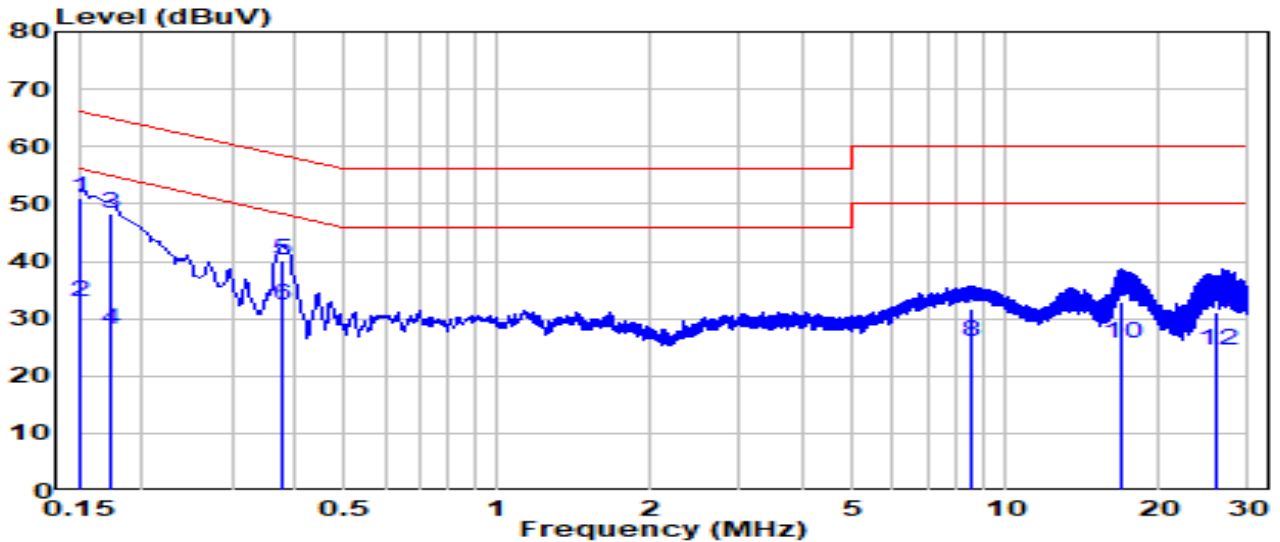

No	Frequency (MHz)	Reading (dB $\mu$ V)	C.F (dB)	Measurement (dB $\mu$ V)	Margin (dB)	Limit (dB $\mu$ V)	Remark (QP/PK/AV)
1	*	41.51	9.61	51.12	-14.87	65.99	QP
2		23.21	9.61	32.82	-23.17	55.99	Average
3		38.61	9.61	48.22	-16.62	64.84	QP
4		18.41	9.61	28.02	-26.82	54.84	Average
5		30.58	9.64	40.22	-18.07	58.29	QP
6		22.78	9.64	32.42	-15.87	48.29	Average
7		21.74	9.86	31.60	-28.40	60.00	QP
8		16.04	9.86	25.90	-24.10	50.00	Average
9		22.85	9.98	32.84	-27.16	60.00	QP
10		15.75	9.98	25.74	-24.26	50.00	Average
11		21.11	10.09	31.20	-28.80	60.00	QP
12		14.51	10.09	24.60	-25.40	50.00	Average

Note:

1. " \*", means this data is the worst emission level.
2. C.F (Correction Factor) = LISN Factor (dB)+ Cable Loss (dB).
3. Measurement(dB $\mu$ V) = Reading(dB $\mu$ V) + C.F (Correction Factor).

## 8. CONCLUSION

The data collected relate only the item(s) tested and show that the unit is compliance with Part 15C of the FCC Rules.

\_\_\_\_\_ The End \_\_\_\_\_

## **Appendix A - Test Setup Photograph**

Refer to “2108TW0004-Test setup photo” file.

## **Appendix B - EUT Photograph**

Refer to "OAW-AP1331-EUT Photo" file.