

802.11ax-HE20 Power Spectral Density - Ant 3 / Ant 0 + 1 + 2 + 3

Channel 52 (5260MHz)

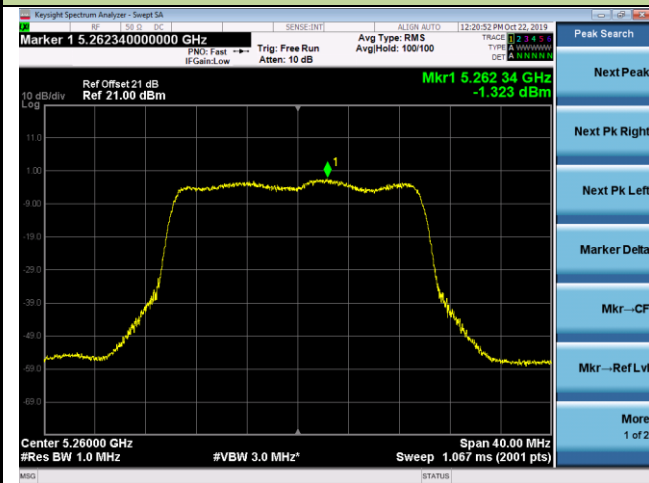

Channel 60 (5300MHz)

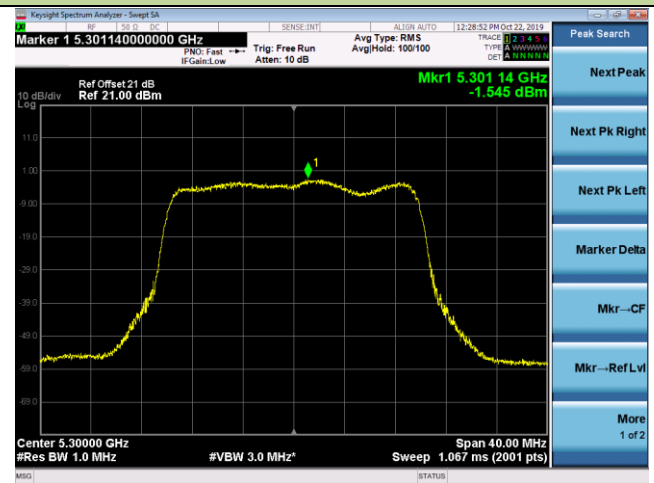

Channel 64 (5320MHz)

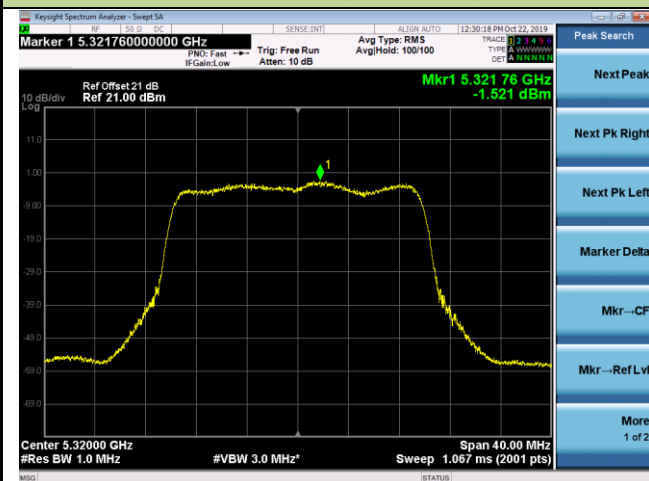

Channel 100 (5500MHz)

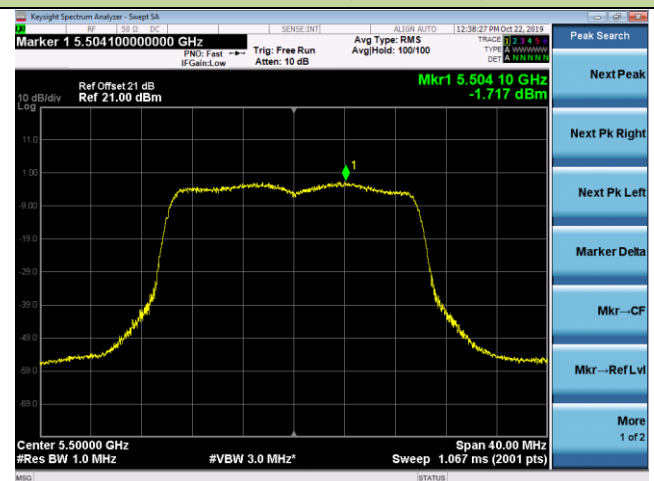

Channel 120 (5600MHz)

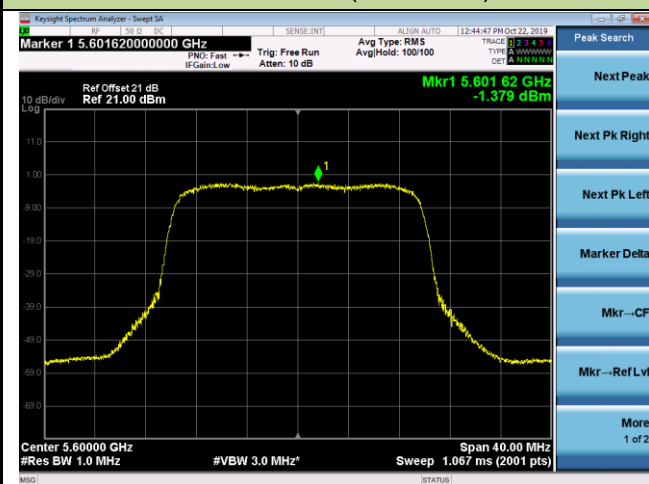

Channel 140 (5700MHz)

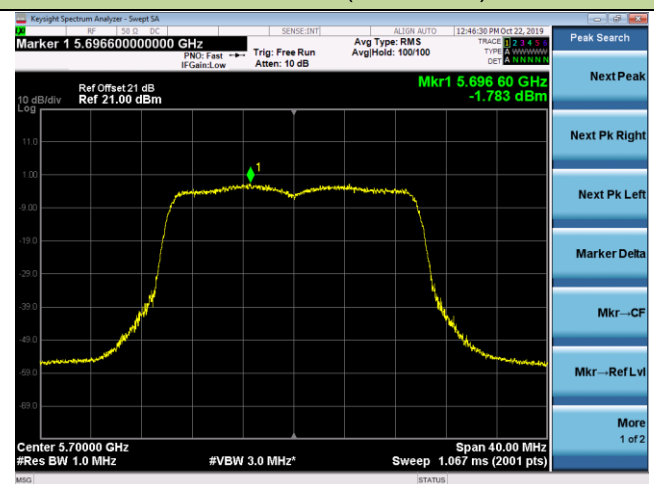

802.11ax-HE20 Power Spectral Density - Ant 3 / Ant 0 + 1 + 2 + 3

Channel 144 (5720MHz)

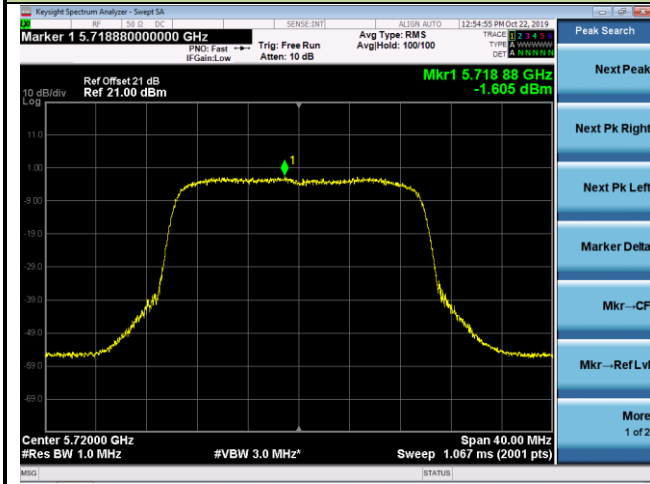

802.11ax-HE40 Power Spectral Density - Ant 3 / Ant 0 + 1 + 2 + 3

Channel 54 (5270MHz)

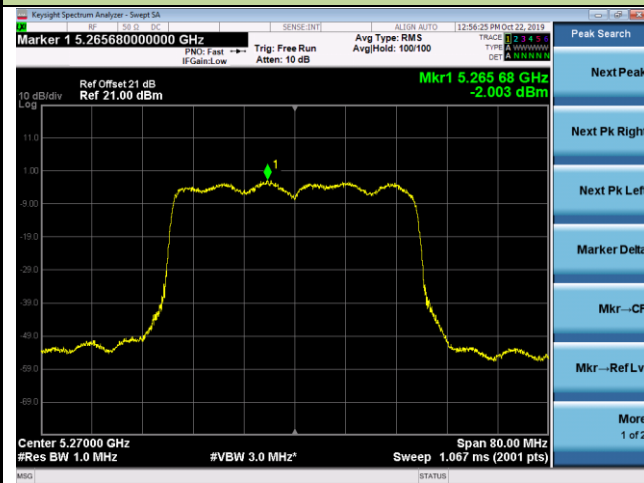

Channel 62 (5310MHz)

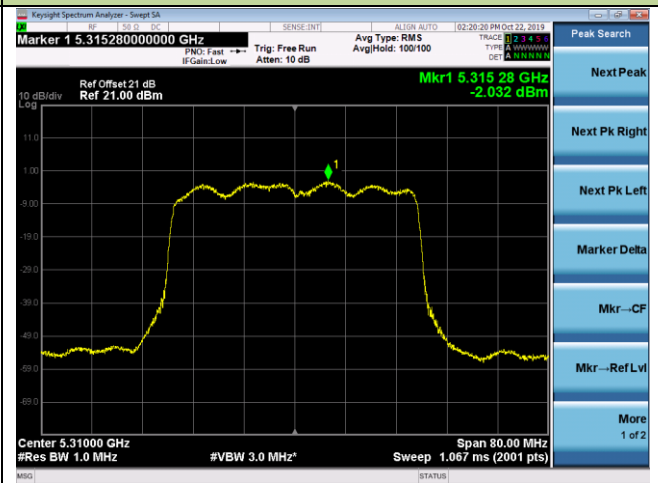

Channel 102 (5510MHz)

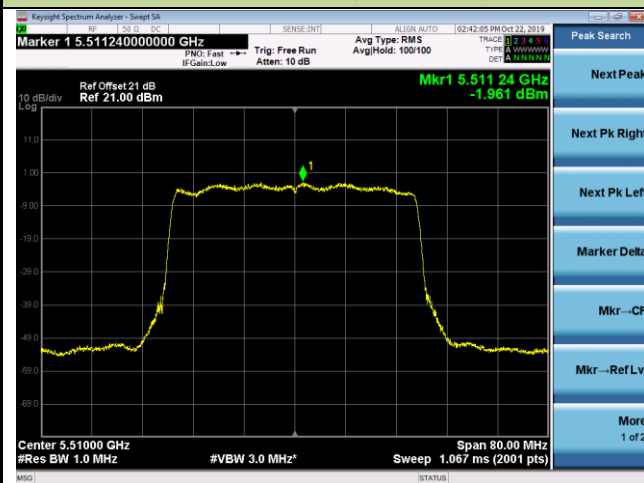

Channel 118 (5590MHz)

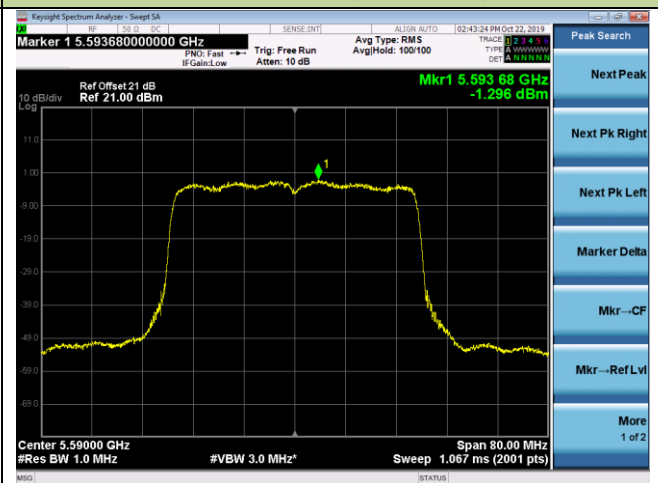

Channel 134 (5670MHz)

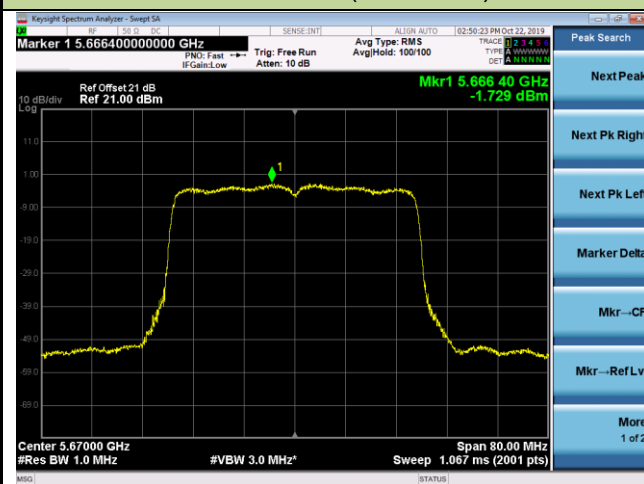

Channel 142 (5710MHz)

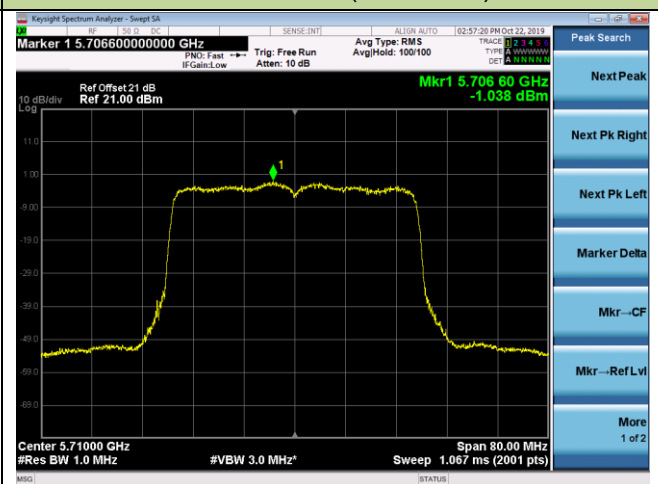

802.11ax-HE80 Power Spectral Density - Ant 3 / Ant 0 + 1 + 2 + 3

Channel 58 (5290MHz)

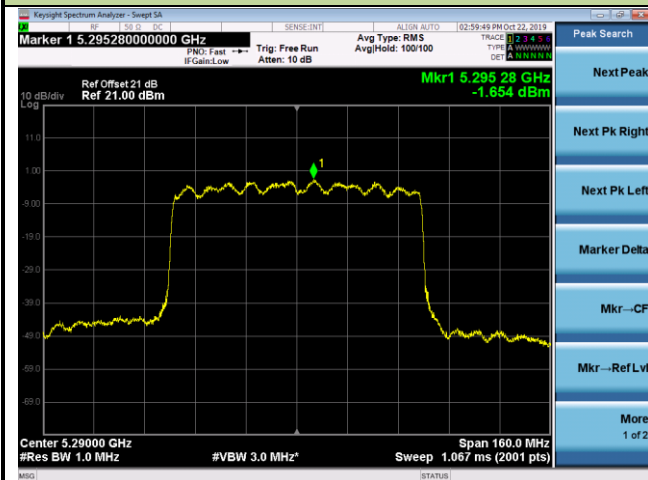

Channel 106 (5530MHz)

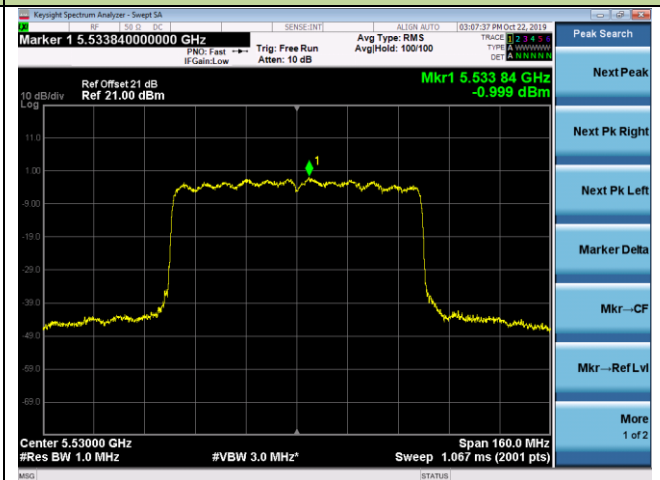

Channel 122 (5610MHz)

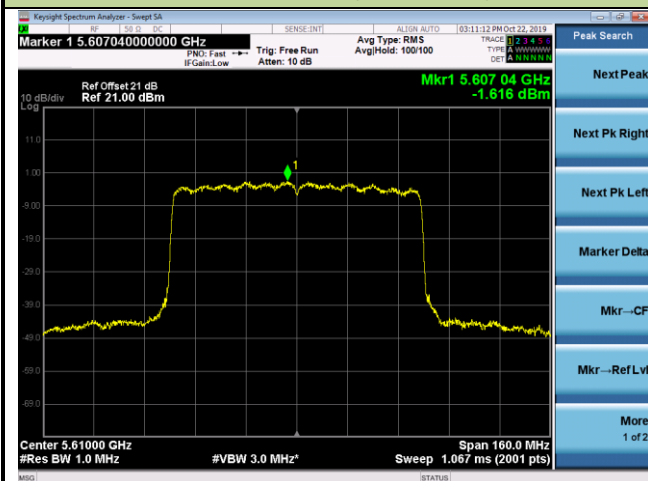

Channel 138 (5690MHz)

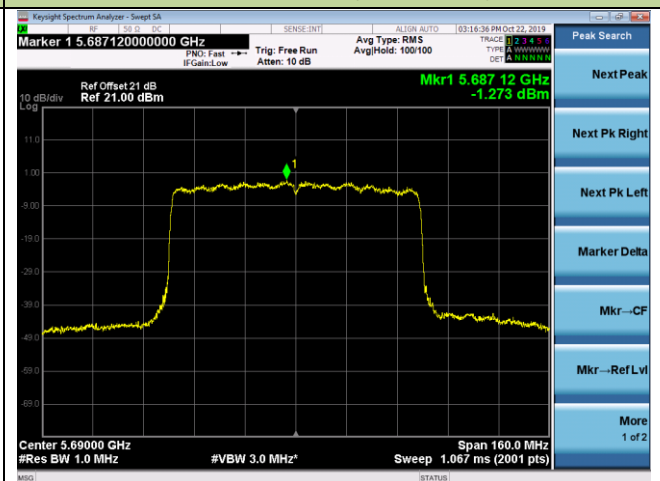

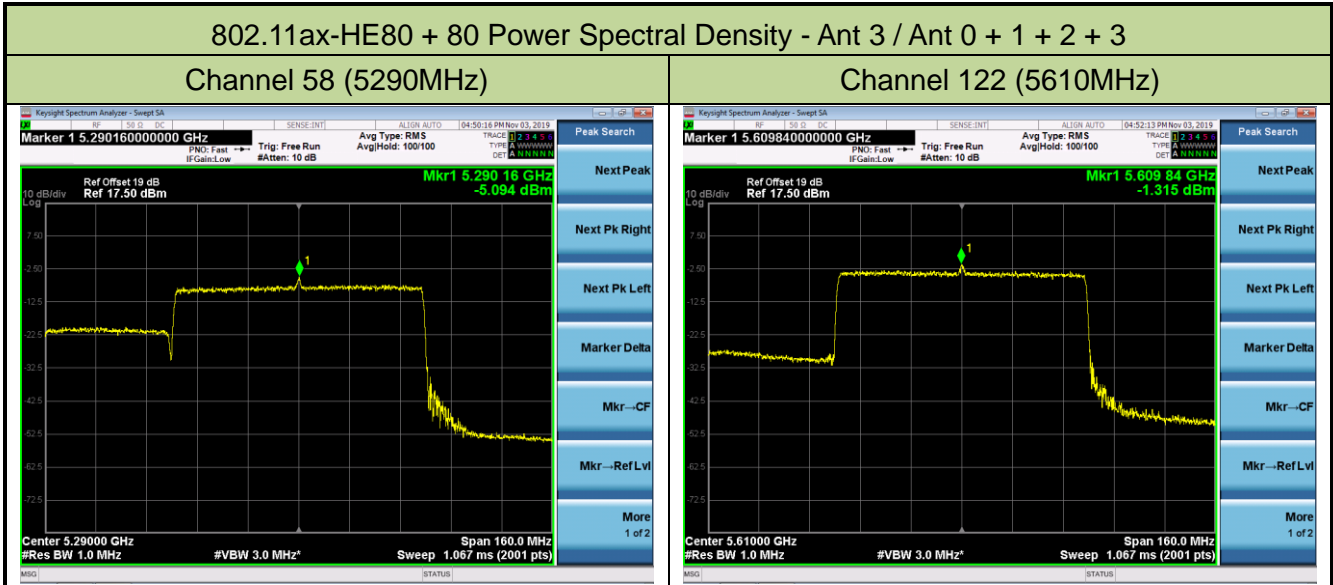

7.7. Frequency Stability Measurement

7.7.1. Test Limit

Manufacturers of U-NII devices are responsible for ensuring frequency stability such that an emission is maintained within the band of operation under all conditions of normal operation as specified in the user's manual.

The transmitter center frequency tolerance shall be ± 20 ppm maximum for the 5GHz band (IEEE 802.11 specification).

7.7.2. Test Procedure Used

Frequency Stability Under Temperature Variations:

The equipment under test was connected to an external AC or DC power supply and input rated voltage. RF output was connected to a frequency counter or spectrum analyzer via feed through attenuators. The EUT was placed inside the temperature chamber. Set the spectrum analyzer RBW low enough to obtain the desired frequency resolution and measure EUT 20°C operating frequency as reference frequency. Turn EUT off and set the chamber temperature to highest. After the temperature stabilized for approximately 30 minutes recorded the frequency. Repeat step measure with 10°C decreased per stage until the lowest temperature reached.

Frequency Stability Under Voltage Variations:

Set chamber temperature to 20°C. Use a variable AC power supply / DC power source to power the EUT and set the voltage to rated voltage. Set the spectrum analyzer RBW low enough to obtain the desired frequency resolution and recorded the frequency.

Reduce the input voltage to specify extreme voltage variation ($\pm 15\%$) and endpoint, record the maximum frequency change.

7.7.3. Test Setup

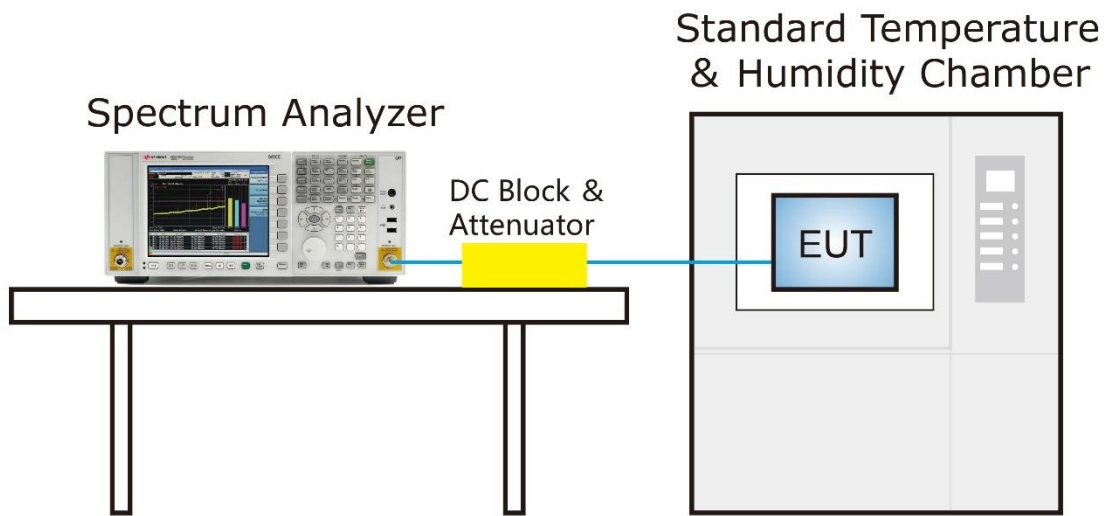

7.7.4. Test Result

Refer to MRT Report - "1909RSU036-U3".

7.8. Radiated Spurious Emission Measurement

7.8.1. Test Limit

All out of band emissions appearing in a restricted band as specified in Section 15.205 of the Title 47 CFR must not exceed the limits shown in Table per Section 15.209.

FCC Part 15 Subpart C Paragraph 15.209		
Frequency (MHz)	Field Strength (uV/m)	Measured Distance (Meters)
0.009 - 0.490	2400/F (kHz)	300
0.490 - 1.705	24000/F (kHz)	30
1.705 - 30	30	30
30 - 88	100	3
88 - 216	150	3
216 - 960	200	3
Above 960	500	3

7.8.2. Test Procedure Used

KDB 789033 D02v02r01 – Section G

7.8.3. Test Setting

Quasi-Peak & Average Measurements below 30MHz

1. Analyzer center frequency was set to the frequency of the radiated spurious emission of interest
2. Span was set greater than 1MHz
3. RBW = 200Hz for 9kHz to 150kHz frequency; RBW = 9kHz for 0.15MHz to 30MHz frequency
4. Detector = CISPR quasi-peak or power average (Average)
5. Sweep time = auto couple
6. Trace was allowed to stabilize

Quasi-Peak Measurements below 1GHz

1. Analyzer center frequency was set to the frequency of the radiated spurious emission of interest
2. Span was set greater than 1MHz
3. RBW = 120 kHz
4. Detector = CISPR quasi-peak
5. Sweep time = auto couple
6. Trace was allowed to stabilize

Peak Measurements above 1GHz

1. Analyzer center frequency was set to the frequency of the radiated spurious emission of interest
2. RBW = 1MHz
3. VBW = 3MHz
4. Detector = peak
5. Sweep time = auto couple
6. Trace mode = max hold
7. Trace was allowed to stabilize

Average Measurements above 1GHz (Method AD)

1. Analyzer center frequency was set to the frequency of the radiated spurious emission of interest
2. RBW = 1MHz
3. If duty cycle $\geq 98\%$, $VBW \leq RBW/100$ but not less than 10Hz; If duty cycle $< 98\%$, set $VBW \geq 1/T$.
4. Detector = Peak
5. Sweep time = auto
6. Trace mode = max hold
7. Allow max hold to run for at least 50 traces if the transmitted signal is continuous or has at least 98% duty cycle. For lower duty cycles, increase the minimum number of traces by a factor of $1/x$, where x is the duty cycle.

7.8.4. Test Setup

Below 1GHz Test Setup:

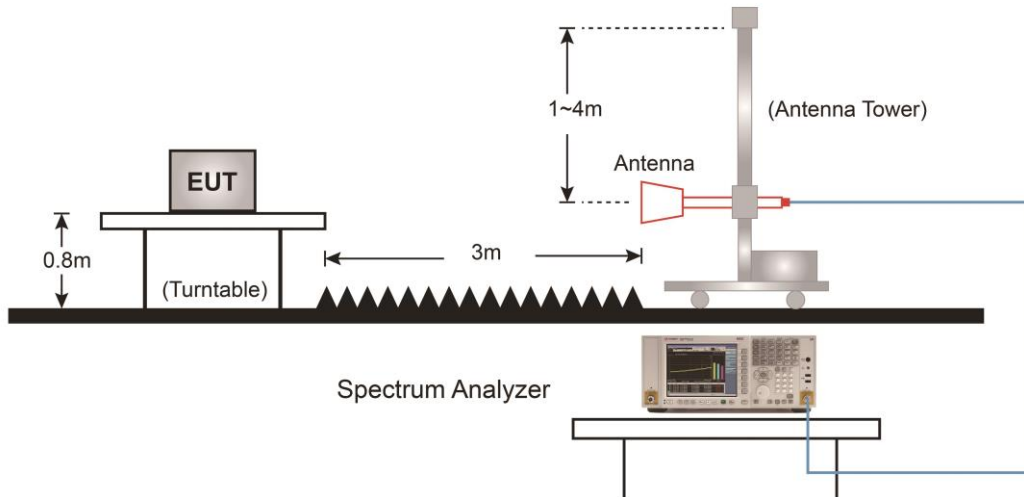

Above 1GHz Test Setup:

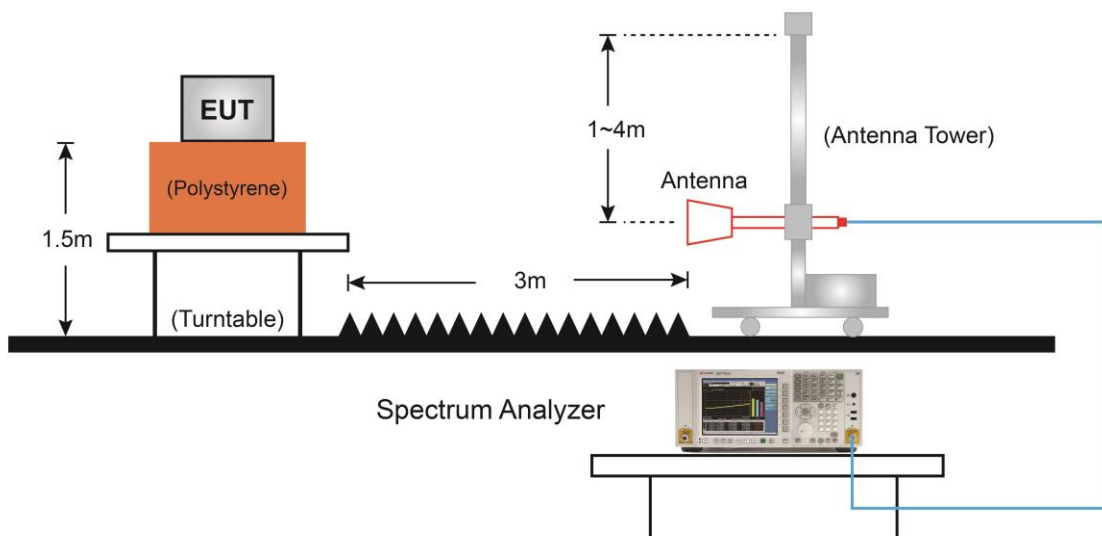

7.8.5. Test Result

For OAW-AP1321

Product	OmniAccess Stellar	Temperature	26°C
Test Engineer	Tyler Yuan	Relative Humidity	57 %
Test Site	AC1	Test Date	2019/12/12
Test Mode:	802.11a	Test Channel:	52
Remark:	1. Average measurement was not performed if peak level lower than average limit. 2. Other frequency was 20dB below limit line within 1-18GHz, there is not show in the report.		

Mark	Frequency (MHz)	Reading Level (dBμV)	Factor (dB)	Measure Level (dBμV/m)	Limit (dBμV/m)	Margin (dB)	Detector	Polarization
*	10129.0	31.9	15.3	47.2	68.2	-21.0	Peak	Horizontal
*	10520.0	32.4	16.7	49.1	68.2	-19.1	Peak	Horizontal
	11659.0	30.1	20.0	50.1	74.0	-23.9	Peak	Horizontal
	12628.0	30.1	20.3	50.4	74.0	-23.6	Peak	Horizontal
*	9746.5	31.9	13.9	45.8	68.2	-22.4	Peak	Vertical
*	10129.0	31.7	15.3	47.0	68.2	-21.2	Peak	Vertical
	10902.5	30.9	18.3	49.2	74.0	-24.8	Peak	Vertical
	12228.5	31.0	19.4	50.4	74.0	-23.6	Peak	Vertical

Note 1: "*" is not in restricted band, its limit is -27dBm/MHz. At a distance of 3 meters, the field strength limit in dBμV/m can be determined by adding a "conversion" factor of 95.2dB to the EIRP limit of -27dBm/MHz to obtain the limit for out of band spurious emissions.

Note 2: Measure Level (dBμV/m) = Reading Level (dBμV) + Factor (dB)

Factor (dB) = Cable Loss (dB) + Antenna Factor (dB/m) - Pre_Amplifier Gain (dB)

Product	OmniAccess Stellar	Temperature	26°C
Test Engineer	Tyler Yuan	Relative Humidity	57 %
Test Site	AC1	Test Date	2019/12/12
Test Mode:	802.11a	Test Channel:	60
Remark:	1. Average measurement was not performed if peak level lower than average limit. 2. Other frequency was 20dB below limit line within 1-18GHz, there is not show in the report.		

Mark	Frequency (MHz)	Reading Level (dBμV)	Factor (dB)	Measure Level (dBμV/m)	Limit (dBμV/m)	Margin (dB)	Detector	Polarization
*	9772.0	32.0	14.0	46.0	68.2	-22.2	Peak	Horizontal
*	10520.0	30.7	16.7	47.4	68.2	-20.8	Peak	Horizontal
	11064.0	30.9	18.5	49.4	74.0	-24.6	Peak	Horizontal
	12007.5	30.3	19.5	49.8	74.0	-24.2	Peak	Horizontal
*	9551.0	32.1	13.5	45.6	68.2	-22.6	Peak	Vertical
*	10129.0	32.9	15.3	48.2	68.2	-20.0	Peak	Vertical
	10928.0	31.6	18.3	49.9	74.0	-24.1	Peak	Vertical
	11378.5	30.6	19.4	50.0	74.0	-24.0	Peak	Vertical

Note 1: "*" is not in restricted band, its limit is -27dBm/MHz. At a distance of 3 meters, the field strength limit in dBμV/m can be determined by adding a "conversion" factor of 95.2dB to the EIRP limit of -27dBm/MHz to obtain the limit for out of band spurious emissions.

Note 2: Measure Level (dBμV/m) = Reading Level (dBμV) + Factor (dB)

Factor (dB) = Cable Loss (dB) + Antenna Factor (dB/m) - Pre_Amplifier Gain (dB)

Product	OmniAccess Stellar	Temperature	26°C
Test Engineer	Tyler Yuan	Relative Humidity	57 %
Test Site	AC1	Test Date	2019/12/12
Test Mode:	802.11a	Test Channel:	64
Remark:	1. Average measurement was not performed if peak level lower than average limit. 2. Other frequency was 20dB below limit line within 1-18GHz, there is not show in the report.		

Mark	Frequency (MHz)	Reading Level (dBμV)	Factor (dB)	Measure Level (dBμV/m)	Limit (dBμV/m)	Margin (dB)	Detector	Polarization
*	9627.5	32.2	13.6	45.8	68.2	-22.4	Peak	Horizontal
*	10435.0	32.2	15.9	48.1	68.2	-20.1	Peak	Horizontal
	11217.0	30.5	19.1	49.6	74.0	-24.4	Peak	Horizontal
	12084.0	30.4	19.9	50.3	74.0	-23.7	Peak	Horizontal
*	9772.0	32.3	14.0	46.3	68.2	-21.9	Peak	Vertical
*	10341.5	31.2	16.0	47.2	68.2	-21.0	Peak	Vertical
	11217.0	29.8	19.1	48.9	74.0	-25.1	Peak	Vertical
	11650.5	30.5	19.7	50.2	74.0	-23.8	Peak	Vertical

Note 1: "*" is not in restricted band, its limit is -27dBm/MHz. At a distance of 3 meters, the field strength limit in dBμV/m can be determined by adding a "conversion" factor of 95.2dB to the EIRP limit of -27dBm/MHz to obtain the limit for out of band spurious emissions.

Note 2: Measure Level (dBμV/m) = Reading Level (dBμV) + Factor (dB)

Factor (dB) = Cable Loss (dB) + Antenna Factor (dB/m) - Pre_Amplifier Gain (dB)

Product	OmniAccess Stellar	Temperature	26°C
Test Engineer	Tyler Yuan	Relative Humidity	57 %
Test Site	AC1	Test Date	2019/12/12
Test Mode:	802.11a	Test Channel:	100
Remark:	1. Average measurement was not performed if peak level lower than average limit. 2. Other frequency was 20dB below limit line within 1-18GHz, there is not show in the report.		

Mark	Frequency (MHz)	Reading Level (dBμV)	Factor (dB)	Measure Level (dBμV/m)	Limit (dBμV/m)	Margin (dB)	Detector	Polarization
*	9534.0	32.5	13.6	46.1	68.2	-22.1	Peak	Horizontal
*	10503.0	31.2	16.7	47.9	68.2	-20.3	Peak	Horizontal
	10996.0	32.9	18.6	51.5	74.0	-22.5	Peak	Horizontal
	11540.0	30.5	19.9	50.4	74.0	-23.6	Peak	Horizontal
*	9763.5	32.6	14.0	46.6	68.2	-21.6	Peak	Vertical
*	10452.0	31.6	16.4	48.0	68.2	-20.2	Peak	Vertical
	10928.0	31.3	18.3	49.6	74.0	-24.4	Peak	Vertical
	11616.5	31.6	19.2	50.8	74.0	-23.2	Peak	Vertical

Note 1: "*" is not in restricted band, its limit is -27dBm/MHz. At a distance of 3 meters, the field strength limit in dBμV/m can be determined by adding a "conversion" factor of 95.2dB to the EIRP limit of -27dBm/MHz to obtain the limit for out of band spurious emissions.

Note 2: Measure Level (dBμV/m) = Reading Level (dBμV) + Factor (dB)

Factor (dB) = Cable Loss (dB) + Antenna Factor (dB/m) - Pre_Amplifier Gain (dB)

Product	OmniAccess Stellar	Temperature	26°C
Test Engineer	Tyler Yuan	Relative Humidity	57 %
Test Site	AC1	Test Date	2019/12/12
Test Mode:	802.11a	Test Channel:	120
Remark:	1. Average measurement was not performed if peak level lower than average limit. 2. Other frequency was 20dB below limit line within 1-18GHz, there is not show in the report.		

Mark	Frequency (MHz)	Reading Level (dBμV)	Factor (dB)	Measure Level (dBμV/m)	Limit (dBμV/m)	Margin (dB)	Detector	Polarization
*	10120.5	31.9	15.0	46.9	68.2	-21.3	Peak	Horizontal
*	10460.5	32.0	16.4	48.4	68.2	-19.8	Peak	Horizontal
	11200.0	34.1	18.9	53.0	74.0	-21.0	Peak	Horizontal
	11489.0	30.9	20.2	51.1	74.0	-22.9	Peak	Horizontal
*	9712.5	32.7	13.7	46.4	68.2	-21.8	Peak	Vertical
*	10452.0	31.2	16.4	47.6	68.2	-20.6	Peak	Vertical
	11174.5	30.9	18.3	49.2	74.0	-24.8	Peak	Vertical
	12075.5	30.8	19.7	50.5	74.0	-23.5	Peak	Vertical

Note 1: "*" is not in restricted band, its limit is -27dBm/MHz. At a distance of 3 meters, the field strength limit in dBμV/m can be determined by adding a "conversion" factor of 95.2dB to the EIRP limit of -27dBm/MHz to obtain the limit for out of band spurious emissions.

Note 2: Measure Level (dBμV/m) = Reading Level (dBμV) + Factor (dB)

Factor (dB) = Cable Loss (dB) + Antenna Factor (dB/m) - Pre_Amplifier Gain (dB)

Product	OmniAccess Stellar	Temperature	26°C
Test Engineer	Tyler Yuan	Relative Humidity	57 %
Test Site	AC1	Test Date	2019/12/12
Test Mode:	802.11a	Test Channel:	140
Remark:	1. Average measurement was not performed if peak level lower than average limit. 2. Other frequency was 20dB below limit line within 1-18GHz, there is not show in the report.		

Mark	Frequency (MHz)	Reading Level (dBμV)	Factor (dB)	Measure Level (dBμV/m)	Limit (dBμV/m)	Margin (dB)	Detector	Polarization
*	10120.5	32.8	15.0	47.8	68.2	-20.4	Peak	Horizontal
*	10409.5	31.8	16.3	48.1	68.2	-20.1	Peak	Horizontal
	10902.5	31.3	18.3	49.6	74.0	-24.4	Peak	Horizontal
	11400.0	33.1	19.1	52.2	54.0	-1.8	Average	Horizontal
*	9772.0	32.2	14.0	46.2	68.2	-22.0	Peak	Vertical
*	10452.0	32.8	16.4	49.2	68.2	-19.0	Peak	Vertical
	10877.0	31.5	18.3	49.8	74.0	-24.2	Peak	Vertical
	11684.5	29.5	19.1	48.6	74.0	-25.4	Peak	Vertical

Note 1: "*" is not in restricted band, its limit is -27dBm/MHz. At a distance of 3 meters, the field strength limit in dBμV/m can be determined by adding a "conversion" factor of 95.2dB to the EIRP limit of -27dBm/MHz to obtain the limit for out of band spurious emissions.

Note 2: Measure Level (dBμV/m) = Reading Level (dBμV) + Factor (dB)

Factor (dB) = Cable Loss (dB) + Antenna Factor (dB/m) - Pre_Amplifier Gain (dB)

Product	OmniAccess Stellar	Temperature	26°C
Test Engineer	Tyler Yuan	Relative Humidity	57 %
Test Site	AC1	Test Date	2019/12/12
Test Mode:	802.11a	Test Channel:	144
Remark:	1. Average measurement was not performed if peak level lower than average limit. 2. Other frequency was 20dB below limit line within 1-18GHz, there is not show in the report.		

Mark	Frequency (MHz)	Reading Level (dBμV)	Factor (dB)	Measure Level (dBμV/m)	Limit (dBμV/m)	Margin (dB)	Detector	Polarization
*	9695.5	32.8	13.6	46.4	68.2	-21.8	Peak	Horizontal
*	10001.5	32.1	14.3	46.4	68.2	-21.8	Peak	Horizontal
	11438.0	33.6	19.4	53.0	74.0	-21.0	Peak	Horizontal
	12135.0	30.2	19.9	50.1	74.0	-23.9	Peak	Horizontal
*	9763.5	33.2	14.0	47.2	68.2	-21.0	Peak	Vertical
*	10265.0	30.9	15.4	46.3	68.2	-21.9	Peak	Vertical
	10885.5	31.4	18.3	49.7	74.0	-24.3	Peak	Vertical
	12101.0	30.6	19.6	50.2	74.0	-23.8	Peak	Vertical

Note 1: "*" is not in restricted band, its limit is -27dBm/MHz. At a distance of 3 meters, the field strength limit in dBμV/m can be determined by adding a "conversion" factor of 95.2dB to the EIRP limit of -27dBm/MHz to obtain the limit for out of band spurious emissions.

Note 2: Measure Level (dBμV/m) = Reading Level (dBμV) + Factor (dB)

Factor (dB) = Cable Loss (dB) + Antenna Factor (dB/m) - Pre_Amplifier Gain (dB)

Product	OmniAccess Stellar	Temperature	26°C
Test Engineer	Tyler Yuan	Relative Humidity	57 %
Test Site	AC1	Test Date	2019/12/12
Test Mode:	802.11n-HT20	Test Channel:	52
Remark:	1. Average measurement was not performed if peak level lower than average limit. 2. Other frequency was 20dB below limit line within 1-18GHz, there is not show in the report.		

Mark	Frequency (MHz)	Reading Level (dBμV)	Factor (dB)	Measure Level (dBμV/m)	Limit (dBμV/m)	Margin (dB)	Detector	Polarization
*	9721.0	32.2	13.7	45.9	68.2	-22.3	Peak	Horizontal
*	10129.0	32.9	15.3	48.2	68.2	-20.0	Peak	Horizontal
	10877.0	31.0	18.3	49.3	74.0	-24.7	Peak	Horizontal
	11650.5	31.1	19.7	50.8	74.0	-23.2	Peak	Horizontal
*	9746.5	33.4	13.9	47.3	68.2	-20.9	Peak	Vertical
*	10511.5	31.6	16.7	48.3	68.2	-19.9	Peak	Vertical
	11089.5	31.5	18.4	49.9	74.0	-24.1	Peak	Vertical
	11778.0	30.6	19.6	50.2	74.0	-23.8	Peak	Vertical

Note 1: "*" is not in restricted band, its limit is -27dBm/MHz. At a distance of 3 meters, the field strength limit in dBμV/m can be determined by adding a "conversion" factor of 95.2dB to the EIRP limit of -27dBm/MHz to obtain the limit for out of band spurious emissions.

Note 2: Measure Level (dBμV/m) = Reading Level (dBμV) + Factor (dB)

Factor (dB) = Cable Loss (dB) + Antenna Factor (dB/m) - Pre_Amplifier Gain (dB)

Product	OmniAccess Stellar	Temperature	26°C
Test Engineer	Tyler Yuan	Relative Humidity	57 %
Test Site	AC1	Test Date	2019/12/12
Test Mode:	802.11n-HT20	Test Channel:	60
Remark:	1. Average measurement was not performed if peak level lower than average limit. 2. Other frequency was 20dB below limit line within 1-18GHz, there is not show in the report.		

Mark	Frequency (MHz)	Reading Level (dBμV)	Factor (dB)	Measure Level (dBμV/m)	Limit (dBμV/m)	Margin (dB)	Detector	Polarization
*	9806.0	32.2	14.2	46.4	68.2	-21.8	Peak	Horizontal
*	10596.5	32.1	16.6	48.7	68.2	-19.5	Peak	Horizontal
	11489.0	30.2	20.2	50.4	74.0	-23.6	Peak	Horizontal
	12186.0	29.8	20.2	50.0	74.0	-24.0	Peak	Horizontal
*	9678.5	33.0	13.6	46.6	68.2	-21.6	Peak	Vertical
*	10324.5	31.9	15.7	47.6	68.2	-20.6	Peak	Vertical
	11217.0	30.9	19.1	50.0	74.0	-24.0	Peak	Vertical
	12084.0	30.2	19.9	50.1	74.0	-23.9	Peak	Vertical

Note 1: "*" is not in restricted band, its limit is -27dBm/MHz. At a distance of 3 meters, the field strength limit in dBμV/m can be determined by adding a "conversion" factor of 95.2dB to the EIRP limit of -27dBm/MHz to obtain the limit for out of band spurious emissions.

Note 2: Measure Level (dBμV/m) = Reading Level (dBμV) + Factor (dB)

Factor (dB) = Cable Loss (dB) + Antenna Factor (dB/m) - Pre_Amplifier Gain (dB)

Product	OmniAccess Stellar	Temperature	26°C
Test Engineer	Tyler Yuan	Relative Humidity	57 %
Test Site	AC1	Test Date	2019/12/12
Test Mode:	802.11n-HT20	Test Channel:	64
Remark:	1. Average measurement was not performed if peak level lower than average limit. 2. Other frequency was 20dB below limit line within 1-18GHz, there is not show in the report.		

Mark	Frequency (MHz)	Reading Level (dBμV)	Factor (dB)	Measure Level (dBμV/m)	Limit (dBμV/m)	Margin (dB)	Detector	Polarization
*	9908.0	33.0	14.2	47.2	68.2	-21.0	Peak	Horizontal
*	10409.5	31.1	16.3	47.4	68.2	-20.8	Peak	Horizontal
	11659.0	30.5	20.0	50.5	74.0	-23.5	Peak	Horizontal
	12007.5	31.2	19.5	50.7	74.0	-23.3	Peak	Horizontal
*	9602.0	32.8	13.6	46.4	68.2	-21.8	Peak	Vertical
*	10554.0	31.9	16.8	48.7	68.2	-19.5	Peak	Vertical
	10962.0	31.3	18.5	49.8	74.0	-24.2	Peak	Vertical
	12356.0	30.3	19.6	49.9	74.0	-24.1	Peak	Vertical

Note 1: "*" is not in restricted band, its limit is -27dBm/MHz. At a distance of 3 meters, the field strength limit in dBμV/m can be determined by adding a "conversion" factor of 95.2dB to the EIRP limit of -27dBm/MHz to obtain the limit for out of band spurious emissions.

Note 2: Measure Level (dBμV/m) = Reading Level (dBμV) + Factor (dB)

Factor (dB) = Cable Loss (dB) + Antenna Factor (dB/m) - Pre_Amplifier Gain (dB)

Product	OmniAccess Stellar	Temperature	26°C
Test Engineer	Tyler Yuan	Relative Humidity	57 %
Test Site	AC1	Test Date	2019/12/12
Test Mode:	802.11n-HT20	Test Channel:	100
Remark:	1. Average measurement was not performed if peak level lower than average limit. 2. Other frequency was 20dB below limit line within 1-18GHz, there is not show in the report.		

Mark	Frequency (MHz)	Reading Level (dBμV)	Factor (dB)	Measure Level (dBμV/m)	Limit (dBμV/m)	Margin (dB)	Detector	Polarization
*	9653.0	32.1	13.7	45.8	68.2	-22.4	Peak	Horizontal
*	10129.0	32.5	15.3	47.8	68.2	-20.4	Peak	Horizontal
	10996.0	31.8	18.6	50.4	74.0	-23.6	Peak	Horizontal
	12628.0	30.0	20.3	50.3	74.0	-23.7	Peak	Horizontal
*	9738.0	32.2	13.8	46.0	68.2	-22.2	Peak	Vertical
*	10579.5	32.0	16.8	48.8	68.2	-19.4	Peak	Vertical
	11149.0	31.4	18.5	49.9	74.0	-24.1	Peak	Vertical
	12084.0	30.1	19.9	50.0	74.0	-24.0	Peak	Vertical

Note 1: "*" is not in restricted band, its limit is -27dBm/MHz. At a distance of 3 meters, the field strength limit in dBμV/m can be determined by adding a "conversion" factor of 95.2dB to the EIRP limit of -27dBm/MHz to obtain the limit for out of band spurious emissions.

Note 2: Measure Level (dBμV/m) = Reading Level (dBμV) + Factor (dB)

Factor (dB) = Cable Loss (dB) + Antenna Factor (dB/m) - Pre_Amplifier Gain (dB)

Product	OmniAccess Stellar	Temperature	26°C
Test Engineer	Tyler Yuan	Relative Humidity	57 %
Test Site	AC1	Test Date	2019/12/12
Test Mode:	802.11n-HT20	Test Channel:	120
Remark:	1. Average measurement was not performed if peak level lower than average limit. 2. Other frequency was 20dB below limit line within 1-18GHz, there is not show in the report.		

Mark	Frequency (MHz)	Reading Level (dBμV)	Factor (dB)	Measure Level (dBμV/m)	Limit (dBμV/m)	Margin (dB)	Detector	Polarization
*	9704.0	31.6	13.7	45.3	68.2	-22.9	Peak	Horizontal
*	10358.5	31.6	16.1	47.7	68.2	-20.5	Peak	Horizontal
	11200.0	33.6	18.9	52.5	74.0	-21.5	Peak	Horizontal
	12067.0	30.8	19.5	50.3	74.0	-23.7	Peak	Horizontal
*	9865.5	33.1	14.1	47.2	68.2	-21.0	Peak	Vertical
*	10562.5	31.7	16.9	48.6	68.2	-19.6	Peak	Vertical
	11081.0	30.8	18.3	49.1	74.0	-24.9	Peak	Vertical
	11659.0	29.5	20.0	49.5	74.0	-24.5	Peak	Vertical

Note 1: "*" is not in restricted band, its limit is -27dBm/MHz. At a distance of 3 meters, the field strength limit in dBμV/m can be determined by adding a "conversion" factor of 95.2dB to the EIRP limit of -27dBm/MHz to obtain the limit for out of band spurious emissions.

Note 2: Measure Level (dBμV/m) = Reading Level (dBμV) + Factor (dB)

Factor (dB) = Cable Loss (dB) + Antenna Factor (dB/m) - Pre_Amplifier Gain (dB)

Product	OmniAccess Stellar	Temperature	26°C
Test Engineer	Tyler Yuan	Relative Humidity	57 %
Test Site	AC1	Test Date	2019/12/12
Test Mode:	802.11n-HT20	Test Channel:	140
Remark:	1. Average measurement was not performed if peak level lower than average limit. 2. Other frequency was 20dB below limit line within 1-18GHz, there is not show in the report.		

Mark	Frequency (MHz)	Reading Level (dBμV)	Factor (dB)	Measure Level (dBμV/m)	Limit (dBμV/m)	Margin (dB)	Detector	Polarization
*	9627.5	32.8	13.6	46.4	68.2	-21.8	Peak	Horizontal
*	10129.0	32.7	15.3	48.0	68.2	-20.2	Peak	Horizontal
	11395.5	33.8	19.3	53.1	74.0	-20.9	Peak	Horizontal
	12033.0	30.4	19.5	49.9	74.0	-24.1	Peak	Horizontal
*	9644.5	32.2	13.7	45.9	68.2	-22.3	Peak	Vertical
*	10554.0	32.3	16.8	49.1	68.2	-19.1	Peak	Vertical
	10885.5	30.9	18.3	49.2	74.0	-24.8	Peak	Vertical
	11531.5	30.1	19.7	49.8	74.0	-24.2	Peak	Vertical

Note 1: "*" is not in restricted band, its limit is -27dBm/MHz. At a distance of 3 meters, the field strength limit in dBμV/m can be determined by adding a "conversion" factor of 95.2dB to the EIRP limit of -27dBm/MHz to obtain the limit for out of band spurious emissions.

Note 2: Measure Level (dBμV/m) = Reading Level (dBμV) + Factor (dB)

Factor (dB) = Cable Loss (dB) + Antenna Factor (dB/m) - Pre_Amplifier Gain (dB)

Product	OmniAccess Stellar	Temperature	26°C
Test Engineer	Tyler Yuan	Relative Humidity	57 %
Test Site	AC1	Test Date	2019/12/12
Test Mode:	802.11n-HT20	Test Channel:	144
Remark:	1. Average measurement was not performed if peak level lower than average limit. 2. Other frequency was 20dB below limit line within 1-18GHz, there is not show in the report.		

Mark	Frequency (MHz)	Reading Level (dBμV)	Factor (dB)	Measure Level (dBμV/m)	Limit (dBμV/m)	Margin (dB)	Detector	Polarization
*	9585.0	32.8	13.6	46.4	68.2	-21.8	Peak	Horizontal
*	10545.5	32.1	16.6	48.7	68.2	-19.5	Peak	Horizontal
	11438.0	33.5	19.4	52.9	74.0	-21.1	Peak	Horizontal
	12296.5	30.3	19.7	50.0	74.0	-24.0	Peak	Horizontal
*	9534.0	32.5	13.6	46.1	68.2	-22.1	Peak	Vertical
*	10384.0	31.7	16.3	48.0	68.2	-20.2	Peak	Vertical
	11591.0	29.7	19.8	49.5	74.0	-24.5	Peak	Vertical
	12177.5	30.4	19.9	50.3	74.0	-23.7	Peak	Vertical

Note 1: "*" is not in restricted band, its limit is -27dBm/MHz. At a distance of 3 meters, the field strength limit in dBμV/m can be determined by adding a "conversion" factor of 95.2dB to the EIRP limit of -27dBm/MHz to obtain the limit for out of band spurious emissions.

Note 2: Measure Level (dBμV/m) = Reading Level (dBμV) + Factor (dB)

Factor (dB) = Cable Loss (dB) + Antenna Factor (dB/m) - Pre_Amplifier Gain (dB)

Product	OmniAccess Stellar	Temperature	26°C
Test Engineer	Tyler Yuan	Relative Humidity	57 %
Test Site	AC1	Test Date	2019/12/12
Test Mode:	802.11n-HT40	Test Channel:	54
Remark:	1. Average measurement was not performed if peak level lower than average limit. 2. Other frequency was 20dB below limit line within 1-18GHz, there is not show in the report.		

Mark	Frequency (MHz)	Reading Level (dBμV)	Factor (dB)	Measure Level (dBμV/m)	Limit (dBμV/m)	Margin (dB)	Detector	Polarization
*	10103.5	34.0	14.7	48.7	68.2	-19.5	Peak	Horizontal
*	10384.0	33.3	16.3	49.6	68.2	-18.6	Peak	Horizontal
	11778.0	31.8	19.6	51.4	74.0	-22.6	Peak	Horizontal
	12092.5	32.1	19.7	51.8	74.0	-22.2	Peak	Horizontal
*	9593.5	34.0	13.6	47.6	68.2	-20.6	Peak	Vertical
*	10137.5	33.5	15.1	48.6	68.2	-19.6	Peak	Vertical
	10962.0	32.8	18.5	51.3	74.0	-22.7	Peak	Vertical
	11812.0	32.0	19.4	51.4	74.0	-22.6	Peak	Vertical

Note 1: "*" is not in restricted band, its limit is -27dBm/MHz. At a distance of 3 meters, the field strength limit in dBμV/m can be determined by adding a "conversion" factor of 95.2dB to the EIRP limit of -27dBm/MHz to obtain the limit for out of band spurious emissions.

Note 2: Measure Level (dBμV/m) = Reading Level (dBμV) + Factor (dB)

Factor (dB) = Cable Loss (dB) + Antenna Factor (dB/m) - Pre_Amplifier Gain (dB)

Product	OmniAccess Stellar	Temperature	26°C
Test Engineer	Tyler Yuan	Relative Humidity	57 %
Test Site	AC1	Test Date	2019/12/12
Test Mode:	802.11n-HT40	Test Channel:	62
Remark:	1. Average measurement was not performed if peak level lower than average limit. 2. Other frequency was 20dB below limit line within 1-18GHz, there is not show in the report.		

Mark	Frequency (MHz)	Reading Level (dBμV)	Factor (dB)	Measure Level (dBμV/m)	Limit (dBμV/m)	Margin (dB)	Detector	Polarization
*	10061.0	34.3	14.7	49.0	68.2	-19.2	Peak	Horizontal
*	10494.5	34.5	16.5	51.0	68.2	-17.2	Peak	Horizontal
	10834.5	32.9	17.7	50.6	74.0	-23.4	Peak	Horizontal
	11599.5	32.5	19.7	52.2	74.0	-21.8	Peak	Horizontal
*	10129.0	33.3	15.3	48.6	68.2	-19.6	Peak	Vertical
*	10494.5	34.3	16.5	50.8	68.2	-17.4	Peak	Vertical
	11489.0	31.2	20.2	51.4	74.0	-22.6	Peak	Vertical
	12135.0	31.4	19.9	51.3	74.0	-22.7	Peak	Vertical

Note 1: "*" is not in restricted band, its limit is -27dBm/MHz. At a distance of 3 meters, the field strength limit in dBμV/m can be determined by adding a "conversion" factor of 95.2dB to the EIRP limit of -27dBm/MHz to obtain the limit for out of band spurious emissions.

Note 2: Measure Level (dBμV/m) = Reading Level (dBμV) + Factor (dB)

Factor (dB) = Cable Loss (dB) + Antenna Factor (dB/m) - Pre_Amplifier Gain (dB)

Product	OmniAccess Stellar	Temperature	26°C
Test Engineer	Tyler Yuan	Relative Humidity	57 %
Test Site	AC1	Test Date	2019/12/12
Test Mode:	802.11n-HT40	Test Channel:	102
Remark:	1. Average measurement was not performed if peak level lower than average limit. 2. Other frequency was 20dB below limit line within 1-18GHz, there is not show in the report.		

Mark	Frequency (MHz)	Reading Level (dBμV)	Factor (dB)	Measure Level (dBμV/m)	Limit (dBμV/m)	Margin (dB)	Detector	Polarization
*	10129.0	33.8	15.3	49.1	68.2	-19.1	Peak	Horizontal
*	10494.5	33.0	16.5	49.5	68.2	-18.7	Peak	Horizontal
	11489.0	30.9	20.2	51.1	74.0	-22.9	Peak	Horizontal
	12033.0	32.2	19.5	51.7	74.0	-22.3	Peak	Horizontal
*	9806.0	34.0	14.2	48.2	68.2	-20.0	Peak	Vertical
*	10137.5	33.8	15.1	48.9	68.2	-19.3	Peak	Vertical
	11480.5	31.4	19.7	51.1	74.0	-22.9	Peak	Vertical
	12177.5	31.5	19.9	51.4	74.0	-22.6	Peak	Vertical

Note 1: "*" is not in restricted band, its limit is -27dBm/MHz. At a distance of 3 meters, the field strength limit in dBμV/m can be determined by adding a "conversion" factor of 95.2dB to the EIRP limit of -27dBm/MHz to obtain the limit for out of band spurious emissions.

Note 2: Measure Level (dBμV/m) = Reading Level (dBμV) + Factor (dB)

Factor (dB) = Cable Loss (dB) + Antenna Factor (dB/m) - Pre_Amplifier Gain (dB)

Product	OmniAccess Stellar	Temperature	26°C
Test Engineer	Tyler Yuan	Relative Humidity	57 %
Test Site	AC1	Test Date	2019/12/12
Test Mode:	802.11n-HT40	Test Channel:	118
Remark:	1. Average measurement was not performed if peak level lower than average limit. 2. Other frequency was 20dB below limit line within 1-18GHz, there is not show in the report.		

Mark	Frequency (MHz)	Reading Level (dBμV)	Factor (dB)	Measure Level (dBμV/m)	Limit (dBμV/m)	Margin (dB)	Detector	Polarization
*	9772.0	34.6	14.0	48.6	68.2	-19.6	Peak	Horizontal
	11106.5	32.8	18.4	51.2	74.0	-22.8	Peak	Horizontal
	12075.5	31.5	19.7	51.2	74.0	-22.8	Peak	Horizontal
*	16767.5	36.2	22.6	58.8	68.2	-9.4	Peak	Horizontal
*	10248.0	33.1	15.5	48.6	68.2	-19.6	Peak	Vertical
	11004.5	33.0	18.4	51.4	74.0	-22.6	Peak	Vertical
	11914.0	32.5	19.5	52.0	74.0	-22.0	Peak	Vertical
*	16767.5	39.7	22.6	62.3	68.2	-5.9	Peak	Vertical

Note 1: "*" is not in restricted band, its limit is -27dBm/MHz. At a distance of 3 meters, the field strength limit in dBμV/m can be determined by adding a "conversion" factor of 95.2dB to the EIRP limit of -27dBm/MHz to obtain the limit for out of band spurious emissions.

Note 2: Measure Level (dBμV/m) = Reading Level (dBμV) + Factor (dB)

Factor (dB) = Cable Loss (dB) + Antenna Factor (dB/m) - Pre_Amplifier Gain (dB)

Product	OmniAccess Stellar	Temperature	26°C
Test Engineer	Tyler Yuan	Relative Humidity	57 %
Test Site	AC1	Test Date	2019/12/12
Test Mode:	802.11n-HT40	Test Channel:	134
Remark:	1. Average measurement was not performed if peak level lower than average limit. 2. Other frequency was 20dB below limit line within 1-18GHz, there is not show in the report.		

Mark	Frequency (MHz)	Reading Level (dBμV)	Factor (dB)	Measure Level (dBμV/m)	Limit (dBμV/m)	Margin (dB)	Detector	Polarization
*	9695.5	34.2	13.6	47.8	68.2	-20.4	Peak	Horizontal
*	10384.0	32.6	16.3	48.9	68.2	-19.3	Peak	Horizontal
	10809.0	33.5	17.5	51.0	74.0	-23.0	Peak	Horizontal
	12024.5	31.9	19.6	51.5	74.0	-22.5	Peak	Horizontal
*	9661.5	34.0	13.6	47.6	68.2	-20.6	Peak	Vertical
*	10129.0	34.7	15.3	50.0	68.2	-18.2	Peak	Vertical
	11319.0	32.5	19.2	51.7	74.0	-22.3	Peak	Vertical
	11616.5	32.5	19.2	51.7	74.0	-22.3	Peak	Vertical

Note 1: "*" is not in restricted band, its limit is -27dBm/MHz. At a distance of 3 meters, the field strength limit in dBμV/m can be determined by adding a "conversion" factor of 95.2dB to the EIRP limit of -27dBm/MHz to obtain the limit for out of band spurious emissions.

Note 2: Measure Level (dBμV/m) = Reading Level (dBμV) + Factor (dB)

Factor (dB) = Cable Loss (dB) + Antenna Factor (dB/m) - Pre_Amplifier Gain (dB)

Product	OmniAccess Stellar	Temperature	26°C
Test Engineer	Tyler Yuan	Relative Humidity	57 %
Test Site	AC1	Test Date	2019/12/12
Test Mode:	802.11n-HT40	Test Channel:	142
Remark:	1. Average measurement was not performed if peak level lower than average limit. 2. Other frequency was 20dB below limit line within 1-18GHz, there is not show in the report.		

Mark	Frequency (MHz)	Reading Level (dBμV)	Factor (dB)	Measure Level (dBμV/m)	Limit (dBμV/m)	Margin (dB)	Detector	Polarization
*	9610.5	34.5	13.5	48.0	68.2	-20.2	Peak	Horizontal
*	10571.0	34.1	16.9	51.0	68.2	-17.2	Peak	Horizontal
	11540.0	32.2	19.9	52.1	74.0	-21.9	Peak	Horizontal
	12959.5	31.8	20.9	52.7	74.0	-21.3	Peak	Horizontal
*	10103.5	33.6	14.7	48.3	68.2	-19.9	Peak	Vertical
*	10511.5	34.0	16.7	50.7	68.2	-17.5	Peak	Vertical
	10902.5	32.9	18.3	51.2	74.0	-22.8	Peak	Vertical
	11421.0	33.8	19.3	53.1	74.0	-20.9	Peak	Vertical

Note 1: "*" is not in restricted band, its limit is -27dBm/MHz. At a distance of 3 meters, the field strength limit in dBμV/m can be determined by adding a "conversion" factor of 95.2dB to the EIRP limit of -27dBm/MHz to obtain the limit for out of band spurious emissions.

Note 2: Measure Level (dBμV/m) = Reading Level (dBμV) + Factor (dB)

Factor (dB) = Cable Loss (dB) + Antenna Factor (dB/m) - Pre_Amplifier Gain (dB)

Product	OmniAccess Stellar	Temperature	26°C
Test Engineer	Tyler Yuan	Relative Humidity	57 %
Test Site	AC1	Test Date	2019/12/12
Test Mode:	802.11ax-HE20	Test Channel:	52
Remark:	1. Average measurement was not performed if peak level lower than average limit. 2. Other frequency was 20dB below limit line within 1-18GHz, there is not show in the report.		

Mark	Frequency (MHz)	Reading Level (dBμV)	Factor (dB)	Measure Level (dBμV/m)	Limit (dBμV/m)	Margin (dB)	Detector	Polarization
*	7094.5	34.1	11.1	45.2	68.2	-23.0	Peak	Horizontal
	7536.5	33.9	11.7	45.6	74.0	-28.4	Peak	Horizontal
	8378.0	34.1	11.3	45.4	74.0	-28.6	Peak	Horizontal
*	9712.5	34.6	13.7	48.3	68.2	-19.9	Peak	Horizontal
	8463.0	32.3	11.4	43.7	74.0	-30.3	Peak	Vertical
	9168.5	33.3	13.8	47.1	74.0	-26.9	Peak	Vertical
*	9695.5	34.8	13.6	48.4	68.2	-19.8	Peak	Vertical
*	10503.0	34.0	16.7	50.7	68.2	-17.5	Peak	Vertical

Note 1: "*" is not in restricted band, its limit is -27dBm/MHz. At a distance of 3 meters, the field strength limit in dBμV/m can be determined by adding a "conversion" factor of 95.2dB to the EIRP limit of -27dBm/MHz to obtain the limit for out of band spurious emissions.

Note 2: Measure Level (dBμV/m) = Reading Level (dBμV) + Factor (dB)

Factor (dB) = Cable Loss (dB) + Antenna Factor (dB/m) - Pre_Amplifier Gain (dB)

Product	OmniAccess Stellar	Temperature	26°C
Test Engineer	Tyler Yuan	Relative Humidity	57 %
Test Site	AC1	Test Date	2019/12/12
Test Mode:	802.11ax-HE20	Test Channel:	60
Remark:	1. Average measurement was not performed if peak level lower than average limit. 2. Other frequency was 20dB below limit line within 1-18GHz, there is not show in the report.		

Mark	Frequency (MHz)	Reading Level (dBμV)	Factor (dB)	Measure Level (dBμV/m)	Limit (dBμV/m)	Margin (dB)	Detector	Polarization
	8097.5	32.8	11.6	44.4	74.0	-29.6	Peak	Horizontal
*	8641.5	32.9	12.2	45.1	68.2	-23.1	Peak	Horizontal
	9160.0	32.5	13.9	46.4	74.0	-27.6	Peak	Horizontal
*	10358.5	33.8	16.1	49.9	68.2	-18.3	Peak	Horizontal
*	7120.0	34.9	10.8	45.7	68.2	-22.5	Peak	Vertical
	8250.5	34.0	11.3	45.3	74.0	-28.7	Peak	Vertical
*	8871.0	32.8	12.7	45.5	68.2	-22.7	Peak	Vertical
	10809.0	33.2	17.5	50.7	74.0	-23.3	Peak	Vertical

Note 1: "*" is not in restricted band, its limit is -27dBm/MHz. At a distance of 3 meters, the field strength limit in dBμV/m can be determined by adding a "conversion" factor of 95.2dB to the EIRP limit of -27dBm/MHz to obtain the limit for out of band spurious emissions.

Note 2: Measure Level (dBμV/m) = Reading Level (dBμV) + Factor (dB)

Factor (dB) = Cable Loss (dB) + Antenna Factor (dB/m) - Pre_Amplifier Gain (dB)

Product	OmniAccess Stellar	Temperature	26°C
Test Engineer	Tyler Yuan	Relative Humidity	57 %
Test Site	AC1	Test Date	2019/12/12
Test Mode:	802.11ax-HE20	Test Channel:	64
Remark:	1. Average measurement was not performed if peak level lower than average limit. 2. Other frequency was 20dB below limit line within 1-18GHz, there is not show in the report.		

Mark	Frequency (MHz)	Reading Level (dBμV)	Factor (dB)	Measure Level (dBμV/m)	Limit (dBμV/m)	Margin (dB)	Detector	Polarization
	7502.5	33.6	11.8	45.4	74.0	-28.6	Peak	Horizontal
*	7953.0	33.9	11.6	45.5	68.2	-22.7	Peak	Horizontal
*	8607.5	33.8	12.1	45.9	68.2	-22.3	Peak	Horizontal
	9381.0	32.2	13.5	45.7	74.0	-28.3	Peak	Horizontal
	8174.0	34.4	11.6	46.0	74.0	-28.0	Peak	Vertical
	9083.5	33.8	13.1	46.9	74.0	-27.1	Peak	Vertical
*	10163.0	33.9	15.0	48.9	68.2	-19.3	Peak	Vertical
*	10477.5	31.2	16.3	47.5	68.2	-20.7	Peak	Vertical

Note 1: "*" is not in restricted band, its limit is -27dBm/MHz. At a distance of 3 meters, the field strength limit in dBμV/m can be determined by adding a "conversion" factor of 95.2dB to the EIRP limit of -27dBm/MHz to obtain the limit for out of band spurious emissions.

Note 2: Measure Level (dBμV/m) = Reading Level (dBμV) + Factor (dB)

Factor (dB) = Cable Loss (dB) + Antenna Factor (dB/m) - Pre_Amplifier Gain (dB)

Product	OmniAccess Stellar	Temperature	26°C
Test Engineer	Tyler Yuan	Relative Humidity	57 %
Test Site	AC1	Test Date	2019/12/13
Test Mode:	802.11ax-HE20	Test Channel:	100
Remark:	1. Average measurement was not performed if peak level lower than average limit. 2. Other frequency was 20dB below limit line within 1-18GHz, there is not show in the report.		

Mark	Frequency (MHz)	Reading Level (dBμV)	Factor (dB)	Measure Level (dBμV/m)	Limit (dBμV/m)	Margin (dB)	Detector	Polarization
	9143.0	33.1	13.6	46.7	74.0	-27.3	Peak	Horizontal
*	9755.0	34.1	14.0	48.1	68.2	-20.1	Peak	Horizontal
*	10571.0	33.4	16.9	50.3	68.2	-17.9	Peak	Horizontal
	11582.5	32.3	19.5	51.8	74.0	-22.2	Peak	Horizontal
*	8675.5	33.8	12.3	46.1	68.2	-22.1	Peak	Vertical
	9466.0	31.3	13.4	44.7	74.0	-29.3	Peak	Vertical
*	10129.0	33.7	15.3	49.0	68.2	-19.2	Peak	Vertical
	10945.0	32.8	18.4	51.2	74.0	-22.8	Peak	Vertical

Note 1: "*" is not in restricted band, its limit is -27dBm/MHz. At a distance of 3 meters, the field strength limit in dBμV/m can be determined by adding a "conversion" factor of 95.2dB to the EIRP limit of -27dBm/MHz to obtain the limit for out of band spurious emissions.

Note 2: Measure Level (dBμV/m) = Reading Level (dBμV) + Factor (dB)

Factor (dB) = Cable Loss (dB) + Antenna Factor (dB/m) - Pre_Amplifier Gain (dB)

Product	OmniAccess Stellar	Temperature	26°C
Test Engineer	Tyler Yuan	Relative Humidity	57 %
Test Site	AC1	Test Date	2019/12/13
Test Mode:	802.11ax-HE20	Test Channel:	120
Remark:	1. Average measurement was not performed if peak level lower than average limit. 2. Other frequency was 20dB below limit line within 1-18GHz, there is not show in the report.		

Mark	Frequency (MHz)	Reading Level (dBμV)	Factor (dB)	Measure Level (dBμV/m)	Limit (dBμV/m)	Margin (dB)	Detector	Polarization
	8658.5	32.8	12.3	45.1	68.2	-23.1	Peak	Horizontal
*	9092.0	32.3	13.3	45.6	74.0	-28.4	Peak	Horizontal
*	9338.5	32.5	13.5	46.0	74.0	-28.0	Peak	Horizontal
	10112.0	34.8	14.7	49.5	68.2	-18.7	Peak	Horizontal
	8658.5	32.7	12.3	45.0	68.2	-23.2	Peak	Vertical
*	9168.5	33.2	13.8	47.0	74.0	-27.0	Peak	Vertical
*	10129.0	34.0	15.3	49.3	68.2	-18.9	Peak	Vertical
	11200.0	34.0	18.9	52.9	74.0	-21.1	Peak	Vertical

Note 1: "*" is not in restricted band, its limit is -27dBm/MHz. At a distance of 3 meters, the field strength limit in dBμV/m can be determined by adding a "conversion" factor of 95.2dB to the EIRP limit of -27dBm/MHz to obtain the limit for out of band spurious emissions.

Note 2: Measure Level (dBμV/m) = Reading Level (dBμV) + Factor (dB)

Factor (dB) = Cable Loss (dB) + Antenna Factor (dB/m) - Pre_Amplifier Gain (dB)

Product	OmniAccess Stellar	Temperature	26°C
Test Engineer	Tyler Yuan	Relative Humidity	57 %
Test Site	AC1	Test Date	2019/12/13
Test Mode:	802.11ax-HE20	Test Channel:	140
Remark:	1. Average measurement was not performed if peak level lower than average limit. 2. Other frequency was 20dB below limit line within 1-18GHz, there is not show in the report.		

Mark	Frequency (MHz)	Reading Level (dBμV)	Factor (dB)	Measure Level (dBμV/m)	Limit (dBμV/m)	Margin (dB)	Detector	Polarization
*	8624.5	33.4	12.1	45.5	68.2	-22.7	Peak	Horizontal
	9160.0	33.3	13.9	47.2	74.0	-26.8	Peak	Horizontal
*	10129.0	33.3	15.3	48.6	68.2	-19.6	Peak	Horizontal
	11506.0	32.4	19.5	51.9	74.0	-22.1	Peak	Horizontal
	7613.0	34.2	11.3	45.5	74.0	-28.5	Peak	Vertical
*	8675.5	35.5	12.3	47.8	68.2	-20.4	Peak	Vertical
	9381.0	32.5	13.5	46.0	74.0	-28.0	Peak	Vertical
*	10426.5	34.3	16.0	50.3	68.2	-17.9	Peak	Vertical

Note 1: "*" is not in restricted band, its limit is -27dBm/MHz. At a distance of 3 meters, the field strength limit in dBμV/m can be determined by adding a "conversion" factor of 95.2dB to the EIRP limit of -27dBm/MHz to obtain the limit for out of band spurious emissions.

Note 2: Measure Level (dBμV/m) = Reading Level (dBμV) + Factor (dB)

Factor (dB) = Cable Loss (dB) + Antenna Factor (dB/m) - Pre_Amplifier Gain (dB)

Product	OmniAccess Stellar	Temperature	26°C
Test Engineer	Tyler Yuan	Relative Humidity	57 %
Test Site	AC1	Test Date	2019/12/13
Test Mode:	802.11ax-HE20	Test Channel:	144
Remark:	1. Average measurement was not performed if peak level lower than average limit. 2. Other frequency was 20dB below limit line within 1-18GHz, there is not show in the report.		

Mark	Frequency (MHz)	Reading Level (dBμV)	Factor (dB)	Measure Level (dBμV/m)	Limit (dBμV/m)	Margin (dB)	Detector	Polarization
*	7876.5	32.6	11.6	44.2	68.2	-24.0	Peak	Horizontal
	9100.5	34.0	13.3	47.3	74.0	-26.7	Peak	Horizontal
*	10384.0	33.7	16.3	50.0	68.2	-18.2	Peak	Horizontal
	10860.0	33.2	17.9	51.1	74.0	-22.9	Peak	Horizontal
	7502.5	33.7	11.8	45.5	74.0	-28.5	Peak	Vertical
*	7868.0	34.2	11.6	45.8	68.2	-22.4	Peak	Vertical
	8242.0	34.4	11.4	45.8	74.0	-28.2	Peak	Vertical
*	8650.0	33.8	12.3	46.1	68.2	-22.1	Peak	Vertical

Note 1: "*" is not in restricted band, its limit is -27dBm/MHz. At a distance of 3 meters, the field strength limit in dBμV/m can be determined by adding a "conversion" factor of 95.2dB to the EIRP limit of -27dBm/MHz to obtain the limit for out of band spurious emissions.

Note 2: Measure Level (dBμV/m) = Reading Level (dBμV) + Factor (dB)

Factor (dB) = Cable Loss (dB) + Antenna Factor (dB/m) - Pre_Amplifier Gain (dB)

Product	OmniAccess Stellar	Temperature	26°C
Test Engineer	Tyler Yuan	Relative Humidity	57 %
Test Site	AC1	Test Date	2019/12/13
Test Mode:	802.11ax-HE40	Test Channel:	54
Remark:	1. Average measurement was not performed if peak level lower than average limit. 2. Other frequency was 20dB below limit line within 1-18GHz, there is not show in the report.		

Mark	Frequency (MHz)	Reading Level (dBμV)	Factor (dB)	Measure Level (dBμV/m)	Limit (dBμV/m)	Margin (dB)	Detector	Polarization
	7502.5	33.8	11.8	45.6	74.0	-28.4	Peak	Horizontal
*	8658.5	34.6	12.3	46.9	68.2	-21.3	Peak	Horizontal
*	9704.0	34.3	13.7	48.0	68.2	-20.2	Peak	Horizontal
	11081.0	32.5	18.3	50.8	74.0	-23.2	Peak	Horizontal
*	8641.5	34.8	12.2	47.0	68.2	-21.2	Peak	Vertical
	9168.5	33.9	13.8	47.7	74.0	-26.3	Peak	Vertical
*	10154.5	34.2	14.9	49.1	68.2	-19.1	Peak	Vertical
	10885.5	33.4	18.3	51.7	74.0	-22.3	Peak	Vertical

Note 1: "*" is not in restricted band, its limit is -27dBm/MHz. At a distance of 3 meters, the field strength limit in dBμV/m can be determined by adding a "conversion" factor of 95.2dB to the EIRP limit of -27dBm/MHz to obtain the limit for out of band spurious emissions.

Note 2: Measure Level (dBμV/m) = Reading Level (dBμV) + Factor (dB)

Factor (dB) = Cable Loss (dB) + Antenna Factor (dB/m) - Pre_Amplifier Gain (dB)

Product	OmniAccess Stellar	Temperature	26°C
Test Engineer	Tyler Yuan	Relative Humidity	57 %
Test Site	AC1	Test Date	2019/12/13
Test Mode:	802.11ax-HE40	Test Channel:	62
Remark:	1. Average measurement was not performed if peak level lower than average limit. 2. Other frequency was 20dB below limit line within 1-18GHz, there is not show in the report.		

Mark	Frequency (MHz)	Reading Level (dBμV)	Factor (dB)	Measure Level (dBμV/m)	Limit (dBμV/m)	Margin (dB)	Detector	Polarization
	7358.0	33.8	11.8	45.6	74.0	-28.4	Peak	Horizontal
	8182.5	33.4	11.6	45.0	74.0	-29.0	Peak	Horizontal
*	8607.5	34.1	12.1	46.2	68.2	-22.0	Peak	Horizontal
*	9704.0	35.1	13.7	48.8	68.2	-19.4	Peak	Horizontal
	7256.0	33.6	11.9	45.5	74.0	-28.5	Peak	Vertical
	7604.5	34.8	11.4	46.2	74.0	-27.8	Peak	Vertical
*	8633.0	33.9	12.2	46.1	68.2	-22.1	Peak	Vertical
*	10001.5	31.6	14.3	45.9	68.2	-22.3	Peak	Vertical

Note 1: "*" is not in restricted band, its limit is -27dBm/MHz. At a distance of 3 meters, the field strength limit in dBμV/m can be determined by adding a "conversion" factor of 95.2dB to the EIRP limit of -27dBm/MHz to obtain the limit for out of band spurious emissions.

Note 2: Measure Level (dBμV/m) = Reading Level (dBμV) + Factor (dB)

Factor (dB) = Cable Loss (dB) + Antenna Factor (dB/m) - Pre_Amplifier Gain (dB)

Product	OmniAccess Stellar	Temperature	26°C
Test Engineer	Tyler Yuan	Relative Humidity	57 %
Test Site	AC1	Test Date	2019/12/13
Test Mode:	802.11ax-HE40	Test Channel:	102
Remark:	1. Average measurement was not performed if peak level lower than average limit. 2. Other frequency was 20dB below limit line within 1-18GHz, there is not show in the report.		

Mark	Frequency (MHz)	Reading Level (dBμV)	Factor (dB)	Measure Level (dBμV/m)	Limit (dBμV/m)	Margin (dB)	Detector	Polarization
	7502.5	33.8	11.8	45.6	74.0	-28.4	Peak	Horizontal
	8174.0	34.3	11.6	45.9	74.0	-28.1	Peak	Horizontal
*	8956.0	33.7	12.4	46.1	68.2	-22.1	Peak	Horizontal
*	10129.0	33.5	15.3	48.8	68.2	-19.4	Peak	Horizontal
	7715.0	34.4	11.5	45.9	74.0	-28.1	Peak	Vertical
*	9687.0	34.1	13.6	47.7	68.2	-20.5	Peak	Vertical
*	10120.5	34.6	15.0	49.6	68.2	-18.6	Peak	Vertical
	11608.0	32.2	19.5	51.7	74.0	-22.3	Peak	Vertical

Note 1: "*" is not in restricted band, its limit is -27dBm/MHz. At a distance of 3 meters, the field strength limit in dBμV/m can be determined by adding a "conversion" factor of 95.2dB to the EIRP limit of -27dBm/MHz to obtain the limit for out of band spurious emissions.

Note 2: Measure Level (dBμV/m) = Reading Level (dBμV) + Factor (dB)

Factor (dB) = Cable Loss (dB) + Antenna Factor (dB/m) - Pre_Amplifier Gain (dB)

Product	OmniAccess Stellar	Temperature	26°C
Test Engineer	Tyler Yuan	Relative Humidity	57 %
Test Site	AC1	Test Date	2019/12/13
Test Mode:	802.11ax-HE40	Test Channel:	118
Remark:	1. Average measurement was not performed if peak level lower than average limit. 2. Other frequency was 20dB below limit line within 1-18GHz, there is not show in the report.		

Mark	Frequency (MHz)	Reading Level (dBμV)	Factor (dB)	Measure Level (dBμV/m)	Limit (dBμV/m)	Margin (dB)	Detector	Polarization
*	8650.0	33.8	12.3	46.1	68.2	-22.1	Peak	Horizontal
*	10129.0	33.2	15.3	48.5	68.2	-19.7	Peak	Horizontal
	10851.5	32.8	17.9	50.7	74.0	-23.3	Peak	Horizontal
	11548.5	32.4	19.8	52.2	74.0	-21.8	Peak	Horizontal
	9109.0	33.0	13.3	46.3	74.0	-27.7	Peak	Vertical
*	9797.5	33.7	14.1	47.8	68.2	-20.4	Peak	Vertical
*	10571.0	34.2	16.9	51.1	68.2	-17.1	Peak	Vertical
	11591.0	31.6	19.8	51.4	74.0	-22.6	Peak	Vertical

Note 1: "*" is not in restricted band, its limit is -27dBm/MHz. At a distance of 3 meters, the field strength limit in dBμV/m can be determined by adding a "conversion" factor of 95.2dB to the EIRP limit of -27dBm/MHz to obtain the limit for out of band spurious emissions.

Note 2: Measure Level (dBμV/m) = Reading Level (dBμV) + Factor (dB)

Factor (dB) = Cable Loss (dB) + Antenna Factor (dB/m) - Pre_Amplifier Gain (dB)

Product	OmniAccess Stellar	Temperature	26°C
Test Engineer	Tyler Yuan	Relative Humidity	57 %
Test Site	AC1	Test Date	2019/12/13
Test Mode:	802.11ax-HE40	Test Channel:	134
Remark:	1. Average measurement was not performed if peak level lower than average limit. 2. Other frequency was 20dB below limit line within 1-18GHz, there is not show in the report.		

Mark	Frequency (MHz)	Reading Level (dBμV)	Factor (dB)	Measure Level (dBμV/m)	Limit (dBμV/m)	Margin (dB)	Detector	Polarization
*	8633.0	33.3	12.2	45.5	68.2	-22.7	Peak	Horizontal
*	10129.0	33.6	15.3	48.9	68.2	-19.3	Peak	Horizontal
	10877.0	32.4	18.3	50.7	74.0	-23.3	Peak	Horizontal
	11548.5	31.7	19.8	51.5	74.0	-22.5	Peak	Horizontal
	7366.5	31.7	11.9	43.6	74.0	-30.4	Peak	Vertical
	8131.5	34.4	11.6	46.0	74.0	-28.0	Peak	Vertical
*	8675.5	33.4	12.3	45.7	68.2	-22.5	Peak	Vertical
*	10460.5	33.7	16.4	50.1	68.2	-18.1	Peak	Vertical

Note 1: "*" is not in restricted band, its limit is -27dBm/MHz. At a distance of 3 meters, the field strength limit in dBμV/m can be determined by adding a "conversion" factor of 95.2dB to the EIRP limit of -27dBm/MHz to obtain the limit for out of band spurious emissions.

Note 2: Measure Level (dBμV/m) = Reading Level (dBμV) + Factor (dB)

Factor (dB) = Cable Loss (dB) + Antenna Factor (dB/m) - Pre_Amplifier Gain (dB)

Product	OmniAccess Stellar	Temperature	26°C
Test Engineer	Tyler Yuan	Relative Humidity	57 %
Test Site	AC1	Test Date	2019/12/13
Test Mode:	802.11ax-HE40	Test Channel:	142
Remark:	1. Average measurement was not performed if peak level lower than average limit. 2. Other frequency was 20dB below limit line within 1-18GHz, there is not show in the report.		

Mark	Frequency (MHz)	Reading Level (dBμV)	Factor (dB)	Measure Level (dBμV/m)	Limit (dBμV/m)	Margin (dB)	Detector	Polarization
*	8658.5	34.0	12.3	46.3	68.2	-21.9	Peak	Horizontal
*	9780.5	34.0	14.0	48.0	68.2	-20.2	Peak	Horizontal
	10860.0	33.3	17.9	51.2	74.0	-22.8	Peak	Horizontal
	11421.0	32.4	19.3	51.7	74.0	-22.3	Peak	Horizontal
	7553.5	33.7	11.8	45.5	74.0	-28.5	Peak	Vertical
*	8701.0	34.6	12.5	47.1	68.2	-21.1	Peak	Vertical
*	9236.5	33.8	13.8	47.6	68.2	-20.6	Peak	Vertical
	11548.5	32.1	19.8	51.9	74.0	-22.1	Peak	Vertical

Note 1: "*" is not in restricted band, its limit is -27dBm/MHz. At a distance of 3 meters, the field strength limit in dBμV/m can be determined by adding a "conversion" factor of 95.2dB to the EIRP limit of -27dBm/MHz to obtain the limit for out of band spurious emissions.

Note 2: Measure Level (dBμV/m) = Reading Level (dBμV) + Factor (dB)

Factor (dB) = Cable Loss (dB) + Antenna Factor (dB/m) - Pre_Amplifier Gain (dB)

Product	OmniAccess Stellar	Temperature	26°C
Test Engineer	Tyler Yuan	Relative Humidity	57 %
Test Site	AC1	Test Date	2019/12/13
Test Mode:	802.11ax-HE80	Test Channel:	58
Remark:	1. Average measurement was not performed if peak level lower than average limit. 2. Other frequency was 20dB below limit line within 1-18GHz, there is not show in the report.		

Mark	Frequency (MHz)	Reading Level (dBμV)	Factor (dB)	Measure Level (dBμV/m)	Limit (dBμV/m)	Margin (dB)	Detector	Polarization
*	7885.0	34.9	11.5	46.4	68.2	-21.8	Peak	Horizontal
	9100.5	33.7	13.3	47.0	74.0	-27.0	Peak	Horizontal
*	10350.0	34.5	16.1	50.6	68.2	-17.6	Peak	Horizontal
	10860.0	33.7	17.9	51.6	74.0	-22.4	Peak	Horizontal
	7434.5	33.9	11.8	45.7	74.0	-28.3	Peak	Vertical
	8208.0	33.2	11.3	44.5	74.0	-29.5	Peak	Vertical
*	8641.5	34.5	12.2	46.7	68.2	-21.5	Peak	Vertical
*	10137.5	33.8	15.1	48.9	68.2	-19.3	Peak	Vertical

Note 1: "*" is not in restricted band, its limit is -27dBm/MHz. At a distance of 3 meters, the field strength limit in dBμV/m can be determined by adding a "conversion" factor of 95.2dB to the EIRP limit of -27dBm/MHz to obtain the limit for out of band spurious emissions.

Note 2: Measure Level (dBμV/m) = Reading Level (dBμV) + Factor (dB)

Factor (dB) = Cable Loss (dB) + Antenna Factor (dB/m) - Pre_Amplifier Gain (dB)

Product	OmniAccess Stellar	Temperature	26°C
Test Engineer	Tyler Yuan	Relative Humidity	57 %
Test Site	AC1	Test Date	2019/12/13
Test Mode:	802.11ax-HE80	Test Channel:	106
Remark:	1. Average measurement was not performed if peak level lower than average limit. 2. Other frequency was 20dB below limit line within 1-18GHz, there is not show in the report.		

Mark	Frequency (MHz)	Reading Level (dBμV)	Factor (dB)	Measure Level (dBμV/m)	Limit (dBμV/m)	Margin (dB)	Detector	Polarization
*	8735.0	31.9	12.8	44.7	68.2	-23.5	Peak	Horizontal
	9177.0	33.6	13.7	47.3	74.0	-26.7	Peak	Horizontal
*	10129.0	34.1	15.3	49.4	68.2	-18.8	Peak	Horizontal
	11540.0	31.9	19.9	51.8	74.0	-22.2	Peak	Horizontal
	7392.0	33.9	11.6	45.5	74.0	-28.5	Peak	Vertical
*	8599.0	34.1	12.1	46.2	68.2	-22.0	Peak	Vertical
	9134.5	33.7	13.4	47.1	74.0	-26.9	Peak	Vertical
*	9755.0	33.8	14.0	47.8	68.2	-20.4	Peak	Vertical

Note 1: "*" is not in restricted band, its limit is -27dBm/MHz. At a distance of 3 meters, the field strength limit in dBμV/m can be determined by adding a "conversion" factor of 95.2dB to the EIRP limit of -27dBm/MHz to obtain the limit for out of band spurious emissions.

Note 2: Measure Level (dBμV/m) = Reading Level (dBμV) + Factor (dB)

Factor (dB) = Cable Loss (dB) + Antenna Factor (dB/m) - Pre_Amplifier Gain (dB)

Product	OmniAccess Stellar	Temperature	26°C
Test Engineer	Tyler Yuan	Relative Humidity	57 %
Test Site	AC1	Test Date	2019/12/13
Test Mode:	802.11ax-HE80	Test Channel:	122
Remark:	1. Average measurement was not performed if peak level lower than average limit. 2. Other frequency was 20dB below limit line within 1-18GHz, there is not show in the report.		

Mark	Frequency (MHz)	Reading Level (dBμV)	Factor (dB)	Measure Level (dBμV/m)	Limit (dBμV/m)	Margin (dB)	Detector	Polarization
	8191.0	34.4	11.6	46.0	74.0	-28.0	Peak	Horizontal
*	8811.5	31.3	12.8	44.1	68.2	-24.1	Peak	Horizontal
*	9755.0	34.4	14.0	48.4	68.2	-19.8	Peak	Horizontal
	11489.0	32.2	20.2	52.4	74.0	-21.6	Peak	Horizontal
	7434.5	32.7	11.8	44.5	74.0	-29.5	Peak	Vertical
	8131.5	32.4	11.6	44.0	74.0	-30.0	Peak	Vertical
*	8658.5	33.7	12.3	46.0	68.2	-22.2	Peak	Vertical
*	10129.0	33.9	15.3	49.2	68.2	-19.0	Peak	Vertical

Note 1: "*" is not in restricted band, its limit is -27dBm/MHz. At a distance of 3 meters, the field strength limit in dBμV/m can be determined by adding a "conversion" factor of 95.2dB to the EIRP limit of -27dBm/MHz to obtain the limit for out of band spurious emissions.

Note 2: Measure Level (dBμV/m) = Reading Level (dBμV) + Factor (dB)

Factor (dB) = Cable Loss (dB) + Antenna Factor (dB/m) - Pre_Amplifier Gain (dB)

Product	OmniAccess Stellar	Temperature	26°C
Test Engineer	Tyler Yuan	Relative Humidity	57 %
Test Site	AC1	Test Date	2019/12/13
Test Mode:	802.11ax-HE80	Test Channel:	138
Remark:	1. Average measurement was not performed if peak level lower than average limit. 2. Other frequency was 20dB below limit line within 1-18GHz, there is not show in the report.		

Mark	Frequency (MHz)	Reading Level (dBμV)	Factor (dB)	Measure Level (dBμV/m)	Limit (dBμV/m)	Margin (dB)	Detector	Polarization
	7545.0	34.1	11.9	46.0	74.0	-28.0	Peak	Horizontal
	8165.5	33.9	11.5	45.4	74.0	-28.6	Peak	Horizontal
*	8607.5	34.5	12.1	46.6	68.2	-21.6	Peak	Horizontal
*	10171.5	33.5	15.1	48.6	68.2	-19.6	Peak	Horizontal
*	8726.5	33.6	12.8	46.4	68.2	-21.8	Peak	Vertical
*	10129.0	33.9	15.3	49.2	68.2	-19.0	Peak	Vertical
	10817.5	33.1	17.5	50.6	74.0	-23.4	Peak	Vertical
	11718.5	32.5	19.5	52.0	74.0	-22.0	Peak	Vertical

Note 1: "*" is not in restricted band, its limit is -27dBm/MHz. At a distance of 3 meters, the field strength limit in dBμV/m can be determined by adding a "conversion" factor of 95.2dB to the EIRP limit of -27dBm/MHz to obtain the limit for out of band spurious emissions.

Note 2: Measure Level (dBμV/m) = Reading Level (dBμV) + Factor (dB)

Factor (dB) = Cable Loss (dB) + Antenna Factor (dB/m) - Pre_Amplifier Gain (dB)

Product	OmniAccess Stellar	Temperature	26°C
Test Engineer	Tyler Yuan	Relative Humidity	57 %
Test Site	AC1	Test Date	2019/12/13
Test Mode:	802.11ax-HE80 + 80	Test Channel:	42 + 58
Remark:	1. Average measurement was not performed if peak level lower than average limit. 2. Other frequency was 20dB below limit line within 1-18GHz, there is not show in the report.		

Mark	Frequency (MHz)	Reading Level (dBμV)	Factor (dB)	Measure Level (dBμV/m)	Limit (dBμV/m)	Margin (dB)	Detector	Polarization
	7536.5	33.5	12.0	45.5	74.0	-28.5	Peak	Horizontal
	8191.0	33.7	12.5	46.2	74.0	-27.8	Peak	Horizontal
*	8650.0	32.9	13.3	46.2	68.2	-22.0	Peak	Horizontal
*	9746.5	32.8	14.9	47.7	68.2	-20.5	Peak	Horizontal
	7613.0	34.0	11.9	45.9	74.0	-28.1	Peak	Vertical
	8182.5	33.3	12.4	45.7	74.0	-28.3	Peak	Vertical
*	8667.0	33.6	13.4	47.0	68.2	-21.2	Peak	Vertical
*	9899.5	33.6	15.2	48.8	68.2	-19.4	Peak	Vertical

Note 1: "*" is not in restricted band, its limit is -27dBm/MHz. At a distance of 3 meters, the field strength limit in dBμV/m can be determined by adding a "conversion" factor of 95.2dB to the EIRP limit of -27dBm/MHz to obtain the limit for out of band spurious emissions.

Note 2: Measure Level (dBμV/m) = Reading Level (dBμV) + Factor (dB)

Factor (dB) = Cable Loss (dB) + Antenna Factor (dB/m) - Pre_Amplifier Gain (dB)

Product	OmniAccess Stellar	Temperature	26°C
Test Engineer	Tyler Yuan	Relative Humidity	57 %
Test Site	AC1	Test Date	2019/12/13
Test Mode:	802.11ax-HE80 + 80	Test Channel:	106 + 122
Remark:	1. Average measurement was not performed if peak level lower than average limit. 2. Other frequency was 20dB below limit line within 1-18GHz, there is not show in the report.		

Mark	Frequency (MHz)	Reading Level (dBμV)	Factor (dB)	Measure Level (dBμV/m)	Limit (dBμV/m)	Margin (dB)	Detector	Polarization
	7545.0	33.2	12.3	45.5	74.0	-28.5	Peak	Horizontal
	8208.0	33.5	12.2	45.7	74.0	-28.3	Peak	Horizontal
*	8650.0	33.1	13.3	46.4	68.2	-21.8	Peak	Horizontal
*	9670.0	34.1	14.3	48.4	68.2	-19.8	Peak	Horizontal
	7596.0	33.7	12.1	45.8	74.0	-28.2	Peak	Vertical
	8140.0	33.6	12.4	46.0	74.0	-28.0	Peak	Vertical
*	8607.5	34.1	13.3	47.4	68.2	-20.8	Peak	Vertical
*	9772.0	33.9	14.9	48.8	68.2	-19.4	Peak	Vertical

Note 1: "*" is not in restricted band, its limit is -27dBm/MHz. At a distance of 3 meters, the field strength limit in dBμV/m can be determined by adding a "conversion" factor of 95.2dB to the EIRP limit of -27dBm/MHz to obtain the limit for out of band spurious emissions.

Note 2: Measure Level (dBμV/m) = Reading Level (dBμV) + Factor (dB)

Factor (dB) = Cable Loss (dB) + Antenna Factor (dB/m) - Pre_Amplifier Gain (dB)

For OAW-AP1322

Product	OmniAccess Stellar	Temperature	26°C
Test Engineer	Tyler Yuan	Relative Humidity	57 %
Test Site	AC1	Test Date	2019/12/14
Test Mode:	802.11a (CDD Mode)	Test Channel:	52
Remark:	1. Average measurement was not performed if peak level lower than average limit. 2. Other frequency was 20dB below limit line within 1-18GHz, there is not show in the report.		

Mark	Frequency (MHz)	Reading Level (dBμV)	Factor (dB)	Measure Level (dBμV/m)	Limit (dBμV/m)	Margin (dB)	Detector	Polarization
	7485.5	31.0	12.0	43.0	74.0	-31.0	Peak	Horizontal
*	8573.5	31.4	12.0	43.4	68.2	-24.8	Peak	Horizontal
*	10520.0	33.1	16.7	49.8	68.2	-18.4	Peak	Horizontal
	15776.4	28.4	19.6	48.0	54.0	-6.0	Average	Horizontal
	7528.0	32.2	11.6	43.8	74.0	-30.2	Peak	Vertical
*	8692.5	30.5	12.4	42.9	68.2	-25.3	Peak	Vertical
*	10520.0	34.6	16.7	51.3	68.2	-16.9	Peak	Vertical
	15781.5	35.2	19.5	54.7	74.0	-19.3	Peak	Vertical

Note 1: "*" is not in restricted band, its limit is -27dBm/MHz. At a distance of 3 meters, the field strength limit in dBμV/m can be determined by adding a "conversion" factor of 95.2dB to the EIRP limit of -27dBm/MHz to obtain the limit for out of band spurious emissions.

Note 2: Measure Level (dBμV/m) = Reading Level (dBμV) + Factor (dB)

Factor (dB) = Cable Loss (dB) + Antenna Factor (dB/m) - Pre_Amplifier Gain (dB)

Product	OmniAccess Stellar	Temperature	26°C
Test Engineer	Tyler Yuan	Relative Humidity	57 %
Test Site	AC1	Test Date	2019/12/14
Test Mode:	802.11a (CDD Mode)	Test Channel:	60
Remark:	1. Average measurement was not performed if peak level lower than average limit. 2. Other frequency was 20dB below limit line within 1-18GHz, there is not show in the report.		

Mark	Frequency (MHz)	Reading Level (dBμV)	Factor (dB)	Measure Level (dBμV/m)	Limit (dBμV/m)	Margin (dB)	Detector	Polarization
*	7978.5	31.7	11.6	43.3	68.2	-24.9	Peak	Horizontal
*	8675.5	31.4	12.3	43.7	68.2	-24.5	Peak	Horizontal
	10605.0	36.5	16.6	53.1	74.0	-20.9	Peak	Horizontal
	15906.4	31.1	19.5	50.6	54.0	-3.4	Average	Horizontal
	7494.0	31.2	12.0	43.2	74.0	-30.8	Peak	Vertical
*	8769.0	31.2	12.7	43.9	68.2	-24.3	Peak	Vertical
*	10596.5	37.6	16.6	54.2	68.2	-14.0	Peak	Vertical
	15906.3	31.0	19.5	50.5	54.0	-3.5	Average	Vertical

Note 1: "*" is not in restricted band, its limit is -27dBm/MHz. At a distance of 3 meters, the field strength limit in dBμV/m can be determined by adding a "conversion" factor of 95.2dB to the EIRP limit of -27dBm/MHz to obtain the limit for out of band spurious emissions.

Note 2: Measure Level (dBμV/m) = Reading Level (dBμV) + Factor (dB)

Factor (dB) = Cable Loss (dB) + Antenna Factor (dB/m) - Pre_Amplifier Gain (dB)

Product	OmniAccess Stellar	Temperature	26°C
Test Engineer	Tyler Yuan	Relative Humidity	57 %
Test Site	AC1	Test Date	2019/12/14
Test Mode:	802.11a (CDD Mode)	Test Channel:	64
Remark:	1. Average measurement was not performed if peak level lower than average limit. 2. Other frequency was 20dB below limit line within 1-18GHz, there is not show in the report.		

Mark	Frequency (MHz)	Reading Level (dBμV)	Factor (dB)	Measure Level (dBμV/m)	Limit (dBμV/m)	Margin (dB)	Detector	Polarization
*	7987.0	31.1	11.6	42.7	68.2	-25.5	Peak	Horizontal
*	8811.5	30.8	12.8	43.6	68.2	-24.6	Peak	Horizontal
	10641.2	31.6	16.9	48.5	54.0	-5.5	Average	Horizontal
	15954.8	32.7	19.3	52.0	54.0	-2.0	Average	Horizontal
*	8845.5	30.5	12.6	43.1	68.2	-25.1	Peak	Vertical
*	9644.5	33.3	13.7	47.0	68.2	-21.2	Peak	Vertical
	10640.5	31.1	16.9	48.0	54.0	-6.0	Average	Vertical
	15961.8	31.1	19.1	50.2	54.0	-3.8	Average	Vertical

Note 1: "*" is not in restricted band, its limit is -27dBm/MHz. At a distance of 3 meters, the field strength limit in dBμV/m can be determined by adding a "conversion" factor of 95.2dB to the EIRP limit of -27dBm/MHz to obtain the limit for out of band spurious emissions.

Note 2: Measure Level (dBμV/m) = Reading Level (dBμV) + Factor (dB)

Factor (dB) = Cable Loss (dB) + Antenna Factor (dB/m) - Pre_Amplifier Gain (dB)

Product	OmniAccess Stellar	Temperature	26°C
Test Engineer	Tyler Yuan	Relative Humidity	57 %
Test Site	AC1	Test Date	2019/12/14
Test Mode:	802.11a (CDD Mode)	Test Channel:	100
Remark:	1. Average measurement was not performed if peak level lower than average limit. 2. Other frequency was 20dB below limit line within 1-18GHz, there is not show in the report.		

Mark	Frequency (MHz)	Reading Level (dBμV)	Factor (dB)	Measure Level (dBμV/m)	Limit (dBμV/m)	Margin (dB)	Detector	Polarization
	8488.5	31.4	11.5	42.9	74.0	-31.1	Peak	Horizontal
*	9950.5	32.2	14.3	46.5	68.2	-21.7	Peak	Horizontal
	11004.5	35.4	18.4	53.8	74.0	-20.2	Peak	Horizontal
*	16504.0	35.2	20.2	55.4	68.2	-12.8	Peak	Horizontal
	7519.5	33.0	11.6	44.6	74.0	-29.4	Peak	Vertical
*	9644.5	32.3	13.7	46.0	68.2	-22.2	Peak	Vertical
	11004.5	34.5	18.4	52.9	74.0	-21.1	Peak	Vertical
*	16512.5	34.6	20.3	54.9	68.2	-13.3	Peak	Vertical

Note 1: "*" is not in restricted band, its limit is -27dBm/MHz. At a distance of 3 meters, the field strength limit in dBμV/m can be determined by adding a "conversion" factor of 95.2dB to the EIRP limit of -27dBm/MHz to obtain the limit for out of band spurious emissions.

Note 2: Measure Level (dBμV/m) = Reading Level (dBμV) + Factor (dB)

Factor (dB) = Cable Loss (dB) + Antenna Factor (dB/m) - Pre_Amplifier Gain (dB)

Product	OmniAccess Stellar	Temperature	26°C
Test Engineer	Tyler Yuan	Relative Humidity	57 %
Test Site	AC1	Test Date	2019/12/14
Test Mode:	802.11a (CDD Mode)	Test Channel:	120
Remark:	1. Average measurement was not performed if peak level lower than average limit. 2. Other frequency was 20dB below limit line within 1-18GHz, there is not show in the report.		

Mark	Frequency (MHz)	Reading Level (dBμV)	Factor (dB)	Measure Level (dBμV/m)	Limit (dBμV/m)	Margin (dB)	Detector	Polarization
	8318.5	31.5	11.2	42.7	74.0	-31.3	Peak	Horizontal
*	9636.0	32.2	13.7	45.9	68.2	-22.3	Peak	Horizontal
	11200.0	33.6	18.9	52.5	74.0	-21.5	Peak	Horizontal
*	16810.0	37.4	23.3	60.7	68.2	-7.5	Peak	Horizontal
	8182.5	30.8	11.6	42.4	74.0	-31.6	Peak	Vertical
*	9644.5	32.1	13.7	45.8	68.2	-22.4	Peak	Vertical
	11200.0	34.5	18.9	53.4	74.0	-20.6	Peak	Vertical
*	16801.5	33.7	23.1	56.8	68.2	-11.4	Peak	Vertical

Note 1: "*" is not in restricted band, its limit is -27dBm/MHz. At a distance of 3 meters, the field strength limit in dBμV/m can be determined by adding a "conversion" factor of 95.2dB to the EIRP limit of -27dBm/MHz to obtain the limit for out of band spurious emissions.

Note 2: Measure Level (dBμV/m) = Reading Level (dBμV) + Factor (dB)

Factor (dB) = Cable Loss (dB) + Antenna Factor (dB/m) - Pre_Amplifier Gain (dB)

Product	OmniAccess Stellar	Temperature	26°C
Test Engineer	Tyler Yuan	Relative Humidity	57 %
Test Site	AC1	Test Date	2019/12/14
Test Mode:	802.11a (CDD Mode)	Test Channel:	140
Remark:	1. Average measurement was not performed if peak level lower than average limit. 2. Other frequency was 20dB below limit line within 1-18GHz, there is not show in the report.		

Mark	Frequency (MHz)	Reading Level (dBμV)	Factor (dB)	Measure Level (dBμV/m)	Limit (dBμV/m)	Margin (dB)	Detector	Polarization
	7443.0	31.6	11.8	43.4	74.0	-30.6	Peak	Horizontal
	11404.0	33.5	19.0	52.5	74.0	-21.5	Peak	Horizontal
*	13002.0	31.6	21.3	52.9	68.2	-15.3	Peak	Horizontal
*	17107.5	39.3	22.8	62.1	68.2	-6.1	Peak	Horizontal
	7341.0	32.1	11.6	43.7	74.0	-30.3	Peak	Vertical
*	9644.5	32.3	13.7	46.0	68.2	-22.2	Peak	Vertical
	11395.5	34.8	19.3	54.1	74.0	-19.9	Peak	Vertical
*	17099.0	37.0	22.7	59.7	68.2	-8.5	Peak	Vertical

Note 1: "*" is not in restricted band, its limit is -27dBm/MHz. At a distance of 3 meters, the field strength limit in dBμV/m can be determined by adding a "conversion" factor of 95.2dB to the EIRP limit of -27dBm/MHz to obtain the limit for out of band spurious emissions.

Note 2: Measure Level (dBμV/m) = Reading Level (dBμV) + Factor (dB)

Factor (dB) = Cable Loss (dB) + Antenna Factor (dB/m) - Pre_Amplifier Gain (dB)

Product	OmniAccess Stellar	Temperature	26°C
Test Engineer	Tyler Yuan	Relative Humidity	57 %
Test Site	AC1	Test Date	2019/12/14
Test Mode:	802.11a (CDD Mode)	Test Channel:	144
Remark:	1. Average measurement was not performed if peak level lower than average limit. 2. Other frequency was 20dB below limit line within 1-18GHz, there is not show in the report.		

Mark	Frequency (MHz)	Reading Level (dBμV)	Factor (dB)	Measure Level (dBμV/m)	Limit (dBμV/m)	Margin (dB)	Detector	Polarization
	8131.5	31.5	11.6	43.1	74.0	-30.9	Peak	Horizontal
	11438.0	33.0	19.4	52.4	74.0	-21.6	Peak	Horizontal
*	14107.0	31.0	23.3	54.3	68.2	-13.9	Peak	Horizontal
*	17158.5	40.4	23.3	63.7	68.2	-4.5	Peak	Horizontal
	7528.0	31.7	11.6	43.3	74.0	-30.7	Peak	Vertical
*	9644.5	33.8	13.7	47.5	68.2	-20.7	Peak	Vertical
	11430.0	31.1	19.3	50.4	54.0	-3.6	RMS	Vertical
*	17150.0	35.9	23.5	59.4	68.2	-8.8	Peak	Vertical

Note 1: "*" is not in restricted band, its limit is -27dBm/MHz. At a distance of 3 meters, the field strength limit in dBμV/m can be determined by adding a "conversion" factor of 95.2dB to the EIRP limit of -27dBm/MHz to obtain the limit for out of band spurious emissions.

Note 2: Measure Level (dBμV/m) = Reading Level (dBμV) + Factor (dB)

Factor (dB) = Cable Loss (dB) + Antenna Factor (dB/m) - Pre_Amplifier Gain (dB)

Product	OmniAccess Stellar	Temperature	26°C
Test Engineer	Tyler Yuan	Relative Humidity	57 %
Test Site	AC1	Test Date	2019/12/14
Test Mode:	802.11n-HT20 (CDD Mode)	Test Channel:	52
Remark:	1. Average measurement was not performed if peak level lower than average limit. 2. Other frequency was 20dB below limit line within 1-18GHz, there is not show in the report.		

Mark	Frequency (MHz)	Reading Level (dBμV)	Factor (dB)	Measure Level (dBμV/m)	Limit (dBμV/m)	Margin (dB)	Detector	Polarization
*	8012.5	32.3	11.7	44.0	68.2	-24.2	Peak	Horizontal
	12041.5	29.6	19.4	49.0	74.0	-25.0	Peak	Horizontal
*	15161.0	31.3	20.7	52.0	68.2	-16.2	Peak	Horizontal
	15773.0	33.0	19.7	52.7	74.0	-21.3	Peak	Horizontal
	8327.0	32.6	11.1	43.7	74.0	-30.3	Peak	Vertical
*	10528.5	32.7	16.6	49.3	68.2	-18.9	Peak	Vertical
	11497.5	29.9	19.9	49.8	74.0	-24.2	Peak	Vertical
*	14600.0	30.4	22.9	53.3	68.2	-14.9	Peak	Vertical

Note 1: "*" is not in restricted band, its limit is -27dBm/MHz. At a distance of 3 meters, the field strength limit in dBμV/m can be determined by adding a "conversion" factor of 95.2dB to the EIRP limit of -27dBm/MHz to obtain the limit for out of band spurious emissions.

Note 2: Measure Level (dBμV/m) = Reading Level (dBμV) + Factor (dB)

Factor (dB) = Cable Loss (dB) + Antenna Factor (dB/m) - Pre_Amplifier Gain (dB)

Product	OmniAccess Stellar	Temperature	26°C
Test Engineer	Tyler Yuan	Relative Humidity	57 %
Test Site	AC1	Test Date	2019/12/14
Test Mode:	802.11n-HT20 (CDD Mode)	Test Channel:	60
Remark:	1. Average measurement was not performed if peak level lower than average limit. 2. Other frequency was 20dB below limit line within 1-18GHz, there is not show in the report.		

Mark	Frequency (MHz)	Reading Level (dBμV)	Factor (dB)	Measure Level (dBμV/m)	Limit (dBμV/m)	Margin (dB)	Detector	Polarization
*	8658.5	31.8	12.3	44.1	68.2	-24.1	Peak	Horizontal
*	10596.5	33.2	16.6	49.8	68.2	-18.4	Peak	Horizontal
	12186.0	29.7	20.2	49.9	74.0	-24.1	Peak	Horizontal
	15900.5	34.2	19.6	53.8	74.0	-20.2	Peak	Horizontal
	7434.5	31.6	11.8	43.4	74.0	-30.6	Peak	Vertical
*	8616.0	32.3	12.1	44.4	68.2	-23.8	Peak	Vertical
	10605.0	33.6	16.6	50.2	74.0	-23.8	Peak	Vertical
*	16810.0	32.5	23.3	55.8	68.2	-12.4	Peak	Vertical

Note 1: "*" is not in restricted band, its limit is -27dBm/MHz. At a distance of 3 meters, the field strength limit in dBμV/m can be determined by adding a "conversion" factor of 95.2dB to the EIRP limit of -27dBm/MHz to obtain the limit for out of band spurious emissions.

Note 2: Measure Level (dBμV/m) = Reading Level (dBμV) + Factor (dB)

Factor (dB) = Cable Loss (dB) + Antenna Factor (dB/m) - Pre_Amplifier Gain (dB)

Product	OmniAccess Stellar	Temperature	26°C
Test Engineer	Tyler Yuan	Relative Humidity	57 %
Test Site	AC1	Test Date	2019/12/14
Test Mode:	802.11n-HT20 (CDD Mode)	Test Channel:	64
Remark:	1. Average measurement was not performed if peak level lower than average limit. 2. Other frequency was 20dB below limit line within 1-18GHz, there is not show in the report.		

Mark	Frequency (MHz)	Reading Level (dBμV)	Factor (dB)	Measure Level (dBμV/m)	Limit (dBμV/m)	Margin (dB)	Detector	Polarization
*	8760.5	31.6	12.7	44.3	68.2	-23.9	Peak	Horizontal
	10639.0	35.5	17.0	52.5	74.0	-21.5	Peak	Horizontal
*	14030.5	29.7	22.7	52.4	68.2	-15.8	Peak	Horizontal
	15951.5	33.1	19.3	52.4	74.0	-21.6	Peak	Horizontal
*	8760.5	31.6	12.7	44.3	68.2	-23.9	Peak	Vertical
	10639.0	35.5	17.0	52.5	74.0	-21.5	Peak	Vertical
*	14030.5	29.7	22.7	52.4	68.2	-15.8	Peak	Vertical
	15951.5	33.1	19.3	52.4	74.0	-21.6	Peak	Vertical

Note 1: "*" is not in restricted band, its limit is -27dBm/MHz. At a distance of 3 meters, the field strength limit in dBμV/m can be determined by adding a "conversion" factor of 95.2dB to the EIRP limit of -27dBm/MHz to obtain the limit for out of band spurious emissions.

Note 2: Measure Level (dBμV/m) = Reading Level (dBμV) + Factor (dB)

Factor (dB) = Cable Loss (dB) + Antenna Factor (dB/m) - Pre_Amplifier Gain (dB)

Product	OmniAccess Stellar	Temperature	26°C
Test Engineer	Tyler Yuan	Relative Humidity	57 %
Test Site	AC1	Test Date	2019/12/14
Test Mode:	802.11n-HT20 (CDD Mode)	Test Channel:	100
Remark:	1. Average measurement was not performed if peak level lower than average limit. 2. Other frequency was 20dB below limit line within 1-18GHz, there is not show in the report.		

Mark	Frequency (MHz)	Reading Level (dBμV)	Factor (dB)	Measure Level (dBμV/m)	Limit (dBμV/m)	Margin (dB)	Detector	Polarization
	8038.0	33.2	11.6	44.8	74.0	-29.2	Peak	Horizontal
*	9585.0	33.0	13.6	46.6	68.2	-21.6	Peak	Horizontal
	10996.0	31.3	18.6	49.9	74.0	-24.1	Peak	Horizontal
*	13724.5	30.7	22.1	52.8	68.2	-15.4	Peak	Horizontal
	7536.5	31.8	11.7	43.5	74.0	-30.5	Peak	Vertical
*	9644.5	32.0	13.7	45.7	68.2	-22.5	Peak	Vertical
	10998.5	29.8	18.6	48.4	54.0	-5.6	Average	Vertical
*	13886.0	30.1	23.3	53.4	68.2	-14.8	Peak	Vertical

Note 1: "*" is not in restricted band, its limit is -27dBm/MHz. At a distance of 3 meters, the field strength limit in dBμV/m can be determined by adding a "conversion" factor of 95.2dB to the EIRP limit of -27dBm/MHz to obtain the limit for out of band spurious emissions.

Note 2: Measure Level (dBμV/m) = Reading Level (dBμV) + Factor (dB)

Factor (dB) = Cable Loss (dB) + Antenna Factor (dB/m) - Pre_Amplifier Gain (dB)

Product	OmniAccess Stellar	Temperature	26°C
Test Engineer	Tyler Yuan	Relative Humidity	57 %
Test Site	AC1	Test Date	2019/12/14
Test Mode:	802.11n-HT20 (CDD Mode)	Test Channel:	120
Remark:	1. Average measurement was not performed if peak level lower than average limit. 2. Other frequency was 20dB below limit line within 1-18GHz, there is not show in the report.		

Mark	Frequency (MHz)	Reading Level (dBμV)	Factor (dB)	Measure Level (dBμV/m)	Limit (dBμV/m)	Margin (dB)	Detector	Polarization
	7485.5	31.7	12.0	43.7	74.0	-30.3	Peak	Horizontal
*	10035.5	32.9	14.5	47.4	68.2	-20.8	Peak	Horizontal
	11200.0	33.4	18.9	52.3	74.0	-21.7	Peak	Horizontal
*	14778.5	30.8	22.7	53.5	68.2	-14.7	Peak	Horizontal
	7545.0	32.2	11.9	44.1	74.0	-29.9	Peak	Vertical
*	10095.0	32.4	14.7	47.1	68.2	-21.1	Peak	Vertical
	11200.0	33.2	18.9	52.1	74.0	-21.9	Peak	Vertical
*	14804.0	30.3	23.2	53.5	68.2	-14.7	Peak	Vertical

Note 1: "*" is not in restricted band, its limit is -27dBm/MHz. At a distance of 3 meters, the field strength limit in dBμV/m can be determined by adding a "conversion" factor of 95.2dB to the EIRP limit of -27dBm/MHz to obtain the limit for out of band spurious emissions.

Note 2: Measure Level (dBμV/m) = Reading Level (dBμV) + Factor (dB)

Factor (dB) = Cable Loss (dB) + Antenna Factor (dB/m) - Pre_Amplifier Gain (dB)

Product	OmniAccess Stellar	Temperature	26°C
Test Engineer	Tyler Yuan	Relative Humidity	57 %
Test Site	AC1	Test Date	2019/12/14
Test Mode:	802.11n-HT20 (CDD Mode)	Test Channel:	140
Remark:	1. Average measurement was not performed if peak level lower than average limit. 2. Other frequency was 20dB below limit line within 1-18GHz, there is not show in the report.		

Mark	Frequency (MHz)	Reading Level (dBμV)	Factor (dB)	Measure Level (dBμV/m)	Limit (dBμV/m)	Margin (dB)	Detector	Polarization
*	7919.0	32.3	11.5	43.8	68.2	-24.4	Peak	Horizontal
*	9262.0	32.1	13.8	45.9	68.2	-22.3	Peak	Horizontal
	11404.0	31.9	19.0	50.9	74.0	-23.1	Peak	Horizontal
	14489.5	30.6	23.0	53.6	74.0	-20.4	Peak	Horizontal
	7630.0	32.3	11.2	43.5	74.0	-30.5	Peak	Vertical
*	9644.5	32.1	13.7	45.8	68.2	-22.4	Peak	Vertical
	11480.5	29.1	19.7	48.8	74.0	-25.2	Peak	Vertical
*	14583.0	31.1	23.0	54.1	68.2	-14.1	Peak	Vertical

Note 1: "*" is not in restricted band, its limit is -27dBm/MHz. At a distance of 3 meters, the field strength limit in dBμV/m can be determined by adding a "conversion" factor of 95.2dB to the EIRP limit of -27dBm/MHz to obtain the limit for out of band spurious emissions.

Note 2: Measure Level (dBμV/m) = Reading Level (dBμV) + Factor (dB)

Factor (dB) = Cable Loss (dB) + Antenna Factor (dB/m) - Pre_Amplifier Gain (dB)

Product	OmniAccess Stellar	Temperature	26°C
Test Engineer	Tyler Yuan	Relative Humidity	57 %
Test Site	AC1	Test Date	2019/12/14
Test Mode:	802.11n-HT20 (CDD Mode)	Test Channel:	144
Remark:	1. Average measurement was not performed if peak level lower than average limit. 2. Other frequency was 20dB below limit line within 1-18GHz, there is not show in the report.		

Mark	Frequency (MHz)	Reading Level (dBμV)	Factor (dB)	Measure Level (dBμV/m)	Limit (dBμV/m)	Margin (dB)	Detector	Polarization
	11438.0	31.3	19.4	50.7	74.0	-23.3	Peak	Horizontal
*	13937.0	29.8	23.2	53.0	68.2	-15.2	Peak	Horizontal
	15441.5	32.3	20.3	52.6	74.0	-21.4	Peak	Horizontal
*	17167.0	36.3	23.2	59.5	68.2	-8.7	Peak	Horizontal
	7604.5	32.6	11.4	44.0	74.0	-30.0	Peak	Vertical
*	9644.5	32.4	13.7	46.1	68.2	-22.1	Peak	Vertical
	11446.5	33.9	19.3	53.2	74.0	-20.8	Peak	Vertical
*	17158.5	35.1	23.3	58.4	68.2	-9.8	Peak	Vertical

Note 1: "*" is not in restricted band, its limit is -27dBm/MHz. At a distance of 3 meters, the field strength limit in dBμV/m can be determined by adding a "conversion" factor of 95.2dB to the EIRP limit of -27dBm/MHz to obtain the limit for out of band spurious emissions.

Note 2: Measure Level (dBμV/m) = Reading Level (dBμV) + Factor (dB)

Factor (dB) = Cable Loss (dB) + Antenna Factor (dB/m) - Pre_Amplifier Gain (dB)

Product	OmniAccess Stellar	Temperature	26°C
Test Engineer	Tyler Yuan	Relative Humidity	57 %
Test Site	AC1	Test Date	2019/12/14
Test Mode:	802.11n-HT40 (CDD Mode)	Test Channel:	54
Remark:	1. Average measurement was not performed if peak level lower than average limit. 2. Other frequency was 20dB below limit line within 1-18GHz, there is not show in the report.		

Mark	Frequency (MHz)	Reading Level (dBμV)	Factor (dB)	Measure Level (dBμV/m)	Limit (dBμV/m)	Margin (dB)	Detector	Polarization
	7630.0	31.7	11.2	42.9	74.0	-31.1	Peak	Horizontal
*	10469.0	31.3	16.3	47.6	68.2	-20.6	Peak	Horizontal
	11591.0	29.3	19.8	49.1	74.0	-24.9	Peak	Horizontal
*	16810.0	32.2	23.3	55.5	68.2	-12.7	Peak	Horizontal
	7426.0	32.0	11.9	43.9	74.0	-30.1	Peak	Vertical
*	10273.5	32.4	15.5	47.9	68.2	-20.3	Peak	Vertical
	12041.5	30.3	19.4	49.7	74.0	-24.3	Peak	Vertical
*	16861.0	31.7	23.4	55.1	68.2	-13.1	Peak	Vertical

Note 1: "*" is not in restricted band, its limit is -27dBm/MHz. At a distance of 3 meters, the field strength limit in dBμV/m can be determined by adding a "conversion" factor of 95.2dB to the EIRP limit of -27dBm/MHz to obtain the limit for out of band spurious emissions.

Note 2: Measure Level (dBμV/m) = Reading Level (dBμV) + Factor (dB)

Factor (dB) = Cable Loss (dB) + Antenna Factor (dB/m) - Pre_Amplifier Gain (dB)

Product	OmniAccess Stellar	Temperature	26°C
Test Engineer	Tyler Yuan	Relative Humidity	57 %
Test Site	AC1	Test Date	2019/12/14
Test Mode:	802.11n-HT40 (CDD Mode)	Test Channel:	62
Remark:	1. Average measurement was not performed if peak level lower than average limit. 2. Other frequency was 20dB below limit line within 1-18GHz, there is not show in the report.		

Mark	Frequency (MHz)	Reading Level (dBμV)	Factor (dB)	Measure Level (dBμV/m)	Limit (dBμV/m)	Margin (dB)	Detector	Polarization
	7383.5	32.0	11.8	43.8	74.0	-30.2	Peak	Horizontal
*	10061.0	30.5	14.7	45.2	68.2	-23.0	Peak	Horizontal
	10613.5	31.4	16.9	48.3	74.0	-25.7	Peak	Horizontal
*	16716.5	32.0	22.1	54.1	68.2	-14.1	Peak	Horizontal
	7545.0	31.9	11.9	43.8	74.0	-30.2	Peak	Vertical
*	9644.5	33.0	13.7	46.7	68.2	-21.5	Peak	Vertical
	10622.0	33.2	17.1	50.3	74.0	-23.7	Peak	Vertical
*	14608.5	31.2	22.6	53.8	68.2	-14.4	Peak	Vertical

Note 1: "*" is not in restricted band, its limit is -27dBm/MHz. At a distance of 3 meters, the field strength limit in dBμV/m can be determined by adding a "conversion" factor of 95.2dB to the EIRP limit of -27dBm/MHz to obtain the limit for out of band spurious emissions.

Note 2: Measure Level (dBμV/m) = Reading Level (dBμV) + Factor (dB)

Factor (dB) = Cable Loss (dB) + Antenna Factor (dB/m) - Pre_Amplifier Gain (dB)

Product	OmniAccess Stellar	Temperature	26°C
Test Engineer	Tyler Yuan	Relative Humidity	57 %
Test Site	AC1	Test Date	2019/12/14
Test Mode:	802.11n-HT40 (CDD Mode)	Test Channel:	102
Remark:	1. Average measurement was not performed if peak level lower than average limit. 2. Other frequency was 20dB below limit line within 1-18GHz, there is not show in the report.		

Mark	Frequency (MHz)	Reading Level (dBμV)	Factor (dB)	Measure Level (dBμV/m)	Limit (dBμV/m)	Margin (dB)	Detector	Polarization
	7392.0	32.0	11.6	43.6	74.0	-30.4	Peak	Horizontal
*	9644.5	32.5	13.7	46.2	68.2	-22.0	Peak	Horizontal
	11548.5	29.3	19.8	49.1	74.0	-24.9	Peak	Horizontal
*	14413.0	30.2	23.5	53.7	68.2	-14.5	Peak	Horizontal
	7553.5	31.4	11.8	43.2	74.0	-30.8	Peak	Vertical
*	9644.5	32.4	13.7	46.1	68.2	-22.1	Peak	Vertical
	10979.0	30.3	18.4	48.7	74.0	-25.3	Peak	Vertical
*	14107.0	29.4	23.3	52.7	68.2	-15.5	Peak	Vertical

Note 1: "*" is not in restricted band, its limit is -27dBm/MHz. At a distance of 3 meters, the field strength limit in dBμV/m can be determined by adding a "conversion" factor of 95.2dB to the EIRP limit of -27dBm/MHz to obtain the limit for out of band spurious emissions.

Note 2: Measure Level (dBμV/m) = Reading Level (dBμV) + Factor (dB)

Factor (dB) = Cable Loss (dB) + Antenna Factor (dB/m) - Pre_Amplifier Gain (dB)

Product	OmniAccess Stellar	Temperature	26°C
Test Engineer	Tyler Yuan	Relative Humidity	57 %
Test Site	AC1	Test Date	2019/12/14
Test Mode:	802.11n-HT40 (CDD Mode)	Test Channel:	118
Remark:	1. Average measurement was not performed if peak level lower than average limit. 2. Other frequency was 20dB below limit line within 1-18GHz, there is not show in the report.		

Mark	Frequency (MHz)	Reading Level (dBμV)	Factor (dB)	Measure Level (dBμV/m)	Limit (dBμV/m)	Margin (dB)	Detector	Polarization
	7434.5	32.2	11.8	44.0	74.0	-30.0	Peak	Horizontal
*	9653.0	32.5	13.7	46.2	68.2	-22.0	Peak	Horizontal
	11174.5	31.1	18.3	49.4	74.0	-24.6	Peak	Horizontal
*	14846.5	30.7	22.1	52.8	68.2	-15.4	Peak	Horizontal
	7511.0	31.9	11.6	43.5	74.0	-30.5	Peak	Vertical
*	9644.5	32.6	13.7	46.3	68.2	-21.9	Peak	Vertical
	11191.5	31.3	18.5	49.8	74.0	-24.2	Peak	Vertical
*	13826.5	29.8	22.8	52.6	68.2	-15.6	Peak	Vertical

Note 1: "*" is not in restricted band, its limit is -27dBm/MHz. At a distance of 3 meters, the field strength limit in dBμV/m can be determined by adding a "conversion" factor of 95.2dB to the EIRP limit of -27dBm/MHz to obtain the limit for out of band spurious emissions.

Note 2: Measure Level (dBμV/m) = Reading Level (dBμV) + Factor (dB)

Factor (dB) = Cable Loss (dB) + Antenna Factor (dB/m) - Pre_Amplifier Gain (dB)

Product	OmniAccess Stellar	Temperature	26°C
Test Engineer	Tyler Yuan	Relative Humidity	57 %
Test Site	AC1	Test Date	2019/12/14
Test Mode:	802.11n-HT40 (CDD Mode)	Test Channel:	134
Remark:	1. Average measurement was not performed if peak level lower than average limit. 2. Other frequency was 20dB below limit line within 1-18GHz, there is not show in the report.		

Mark	Frequency (MHz)	Reading Level (dBμV)	Factor (dB)	Measure Level (dBμV/m)	Limit (dBμV/m)	Margin (dB)	Detector	Polarization
	8335.5	32.2	11.2	43.4	74.0	-30.6	Peak	Horizontal
*	9797.5	31.4	14.1	45.5	68.2	-22.7	Peak	Horizontal
	11344.5	31.1	18.8	49.9	74.0	-24.1	Peak	Horizontal
*	14736.0	30.7	23.0	53.7	68.2	-14.5	Peak	Horizontal
	7477.0	31.8	11.9	43.7	74.0	-30.3	Peak	Vertical
*	9644.5	32.4	13.7	46.1	68.2	-22.1	Peak	Vertical
	11336.0	32.3	19.0	51.3	74.0	-22.7	Peak	Vertical
*	13809.5	30.0	22.6	52.6	68.2	-15.6	Peak	Vertical

Note 1: "*" is not in restricted band, its limit is -27dBm/MHz. At a distance of 3 meters, the field strength limit in dBμV/m can be determined by adding a "conversion" factor of 95.2dB to the EIRP limit of -27dBm/MHz to obtain the limit for out of band spurious emissions.

Note 2: Measure Level (dBμV/m) = Reading Level (dBμV) + Factor (dB)

Factor (dB) = Cable Loss (dB) + Antenna Factor (dB/m) - Pre_Amplifier Gain (dB)

Product	OmniAccess Stellar	Temperature	26°C
Test Engineer	Tyler Yuan	Relative Humidity	57 %
Test Site	AC1	Test Date	2019/12/14
Test Mode:	802.11n-HT40 (CDD Mode)	Test Channel:	142
Remark:	1. Average measurement was not performed if peak level lower than average limit. 2. Other frequency was 20dB below limit line within 1-18GHz, there is not show in the report.		

Mark	Frequency (MHz)	Reading Level (dBμV)	Factor (dB)	Measure Level (dBμV/m)	Limit (dBμV/m)	Margin (dB)	Detector	Polarization
	7562.0	32.2	11.6	43.8	74.0	-30.2	Peak	Horizontal
*	10044.0	32.7	14.5	47.2	68.2	-21.0	Peak	Horizontal
	11582.5	30.5	19.5	50.0	74.0	-24.0	Peak	Horizontal
*	14583.0	31.4	23.0	54.4	68.2	-13.8	Peak	Horizontal
	7519.5	32.1	11.6	43.7	74.0	-30.3	Peak	Vertical
*	9644.5	32.9	13.7	46.6	68.2	-21.6	Peak	Vertical
	11395.5	32.7	19.3	52.0	74.0	-22.0	Peak	Vertical
*	14328.0	29.8	23.0	52.8	68.2	-15.4	Peak	Vertical

Note 1: "*" is not in restricted band, its limit is -27dBm/MHz. At a distance of 3 meters, the field strength limit in dBμV/m can be determined by adding a "conversion" factor of 95.2dB to the EIRP limit of -27dBm/MHz to obtain the limit for out of band spurious emissions.

Note 2: Measure Level (dBμV/m) = Reading Level (dBμV) + Factor (dB)

Factor (dB) = Cable Loss (dB) + Antenna Factor (dB/m) - Pre_Amplifier Gain (dB)

Product	OmniAccess Stellar	Temperature	26°C
Test Engineer	Tyler Yuan	Relative Humidity	57 %
Test Site	AC1	Test Date	2019/12/14
Test Mode:	802.11ax-HE20 (CDD Mode)	Test Channel:	52
Remark:	1. Average measurement was not performed if peak level lower than average limit. 2. Other frequency was 20dB below limit line within 1-18GHz, there is not show in the report.		

Mark	Frequency (MHz)	Reading Level (dBμV)	Factor (dB)	Measure Level (dBμV/m)	Limit (dBμV/m)	Margin (dB)	Detector	Polarization
	7349.5	32.2	11.7	43.9	74.0	-30.1	Peak	Horizontal
*	9814.5	32.4	14.1	46.5	68.2	-21.7	Peak	Horizontal
	11038.5	30.5	18.5	49.0	74.0	-25.0	Peak	Horizontal
*	13444.0	29.7	23.2	52.9	68.2	-15.3	Peak	Horizontal
	7655.5	32.6	11.4	44.0	74.0	-30.0	Peak	Vertical
*	10027.0	32.1	14.5	46.6	68.2	-21.6	Peak	Vertical
	11285.0	29.7	18.9	48.6	74.0	-25.4	Peak	Vertical
*	13444.0	28.8	23.2	52.0	68.2	-16.2	Peak	Vertical

Note 1: "*" is not in restricted band, its limit is -27dBm/MHz. At a distance of 3 meters, the field strength limit in dBμV/m can be determined by adding a "conversion" factor of 95.2dB to the EIRP limit of -27dBm/MHz to obtain the limit for out of band spurious emissions.

Note 2: Measure Level (dBμV/m) = Reading Level (dBμV) + Factor (dB)

Factor (dB) = Cable Loss (dB) + Antenna Factor (dB/m) - Pre_Amplifier Gain (dB)

Product	OmniAccess Stellar	Temperature	26°C
Test Engineer	Tyler Yuan	Relative Humidity	57 %
Test Site	AC1	Test Date	2019/12/14
Test Mode:	802.11ax-HE20 (CDD Mode)	Test Channel:	60
Remark:	1. Average measurement was not performed if peak level lower than average limit. 2. Other frequency was 20dB below limit line within 1-18GHz, there is not show in the report.		

Mark	Frequency (MHz)	Reading Level (dBμV)	Factor (dB)	Measure Level (dBμV/m)	Limit (dBμV/m)	Margin (dB)	Detector	Polarization
	7613.0	35.6	11.9	47.5	74.0	-26.6	Peak	Horizontal
	8369.5	36.1	12.3	48.4	74.0	-25.6	Peak	Horizontal
*	8794.5	34.0	13.3	47.4	68.2	-20.8	Peak	Horizontal
*	10137.5	34.7	16.2	50.9	68.2	-17.3	Peak	Horizontal
	7468.5	35.7	11.8	47.5	74.0	-26.5	Peak	Vertical
	8140.0	35.3	12.5	47.8	74.0	-26.2	Peak	Vertical
*	8871.0	34.4	13.5	47.9	68.2	-20.3	Peak	Vertical
*	9755.0	33.4	15.9	49.3	68.2	-18.9	Peak	Vertical

Note 1: "*" is not in restricted band, its limit is -27dBm/MHz. At a distance of 3 meters, the field strength limit in dBμV/m can be determined by adding a "conversion" factor of 95.2dB to the EIRP limit of -27dBm/MHz to obtain the limit for out of band spurious emissions.

Note 2: Measure Level (dBμV/m) = Reading Level (dBμV) + Factor (dB)

Factor (dB) = Cable Loss (dB) + Antenna Factor (dB/m) - Pre_Amplifier Gain (dB)

Product	OmniAccess Stellar	Temperature	26°C
Test Engineer	Tyler Yuan	Relative Humidity	57 %
Test Site	AC1	Test Date	2019/12/14
Test Mode:	802.11ax-HE20 (CDD Mode)	Test Channel:	64
Remark:	1. Average measurement was not performed if peak level lower than average limit. 2. Other frequency was 20dB below limit line within 1-18GHz, there is not show in the report.		

Mark	Frequency (MHz)	Reading Level (dBμV)	Factor (dB)	Measure Level (dBμV/m)	Limit (dBμV/m)	Margin (dB)	Detector	Polarization
*	8599.0	32.2	12.1	44.3	68.2	-23.9	Peak	Horizontal
*	9772.0	31.9	14.0	45.9	68.2	-22.3	Peak	Horizontal
	10639.0	27.8	17.0	44.8	54.0	-9.2	Average	Horizontal
	15951.5	33.0	19.3	52.3	74.0	-21.7	Peak	Horizontal
	7417.5	32.4	11.7	44.1	74.0	-29.9	Peak	Vertical
*	9644.5	33.2	13.7	46.9	68.2	-21.3	Peak	Vertical
	10630.5	33.4	17.1	50.5	74.0	-23.5	Peak	Vertical
*	14047.5	31.3	23.1	54.4	68.2	-13.8	Peak	Vertical

Note 1: "*" is not in restricted band, its limit is -27dBm/MHz. At a distance of 3 meters, the field strength limit in dBμV/m can be determined by adding a "conversion" factor of 95.2dB to the EIRP limit of -27dBm/MHz to obtain the limit for out of band spurious emissions.

Note 2: Measure Level (dBμV/m) = Reading Level (dBμV) + Factor (dB)

Factor (dB) = Cable Loss (dB) + Antenna Factor (dB/m) - Pre_Amplifier Gain (dB)

Product	OmniAccess Stellar	Temperature	26°C
Test Engineer	Tyler Yuan	Relative Humidity	57 %
Test Site	AC1	Test Date	2019/12/14
Test Mode:	802.11ax-HE20 (CDD Mode)	Test Channel:	100
Remark:	1. Average measurement was not performed if peak level lower than average limit. 2. Other frequency was 20dB below limit line within 1-18GHz, there is not show in the report.		

Mark	Frequency (MHz)	Reading Level (dBμV)	Factor (dB)	Measure Level (dBμV/m)	Limit (dBμV/m)	Margin (dB)	Detector	Polarization
	7400.5	31.7	11.6	43.3	74.0	-30.7	Peak	Horizontal
*	9721.0	32.7	13.7	46.4	68.2	-21.8	Peak	Horizontal
	10996.0	31.8	18.6	50.4	74.0	-23.6	Peak	Horizontal
*	13818.0	30.1	23.1	53.2	68.2	-15.0	Peak	Horizontal
	7256.0	31.9	11.9	43.8	74.0	-30.2	Peak	Vertical
*	8726.5	31.4	12.8	44.2	68.2	-24.0	Peak	Vertical
	11047.0	30.6	18.6	49.2	74.0	-24.8	Peak	Vertical
*	14268.5	30.5	23.5	54.0	68.2	-14.2	Peak	Vertical

Note 1: "*" is not in restricted band, its limit is -27dBm/MHz. At a distance of 3 meters, the field strength limit in dBμV/m can be determined by adding a "conversion" factor of 95.2dB to the EIRP limit of -27dBm/MHz to obtain the limit for out of band spurious emissions.

Note 2: Measure Level (dBμV/m) = Reading Level (dBμV) + Factor (dB)

Factor (dB) = Cable Loss (dB) + Antenna Factor (dB/m) - Pre_Amplifier Gain (dB)

Product	OmniAccess Stellar	Temperature	26°C
Test Engineer	Tyler Yuan	Relative Humidity	57 %
Test Site	AC1	Test Date	2019/12/14
Test Mode:	802.11ax-HE20 (CDD Mode)	Test Channel:	120
Remark:	1. Average measurement was not performed if peak level lower than average limit. 2. Other frequency was 20dB below limit line within 1-18GHz, there is not show in the report.		

Mark	Frequency (MHz)	Reading Level (dBμV)	Factor (dB)	Measure Level (dBμV/m)	Limit (dBμV/m)	Margin (dB)	Detector	Polarization
	7528.0	33.3	11.6	44.9	74.0	-29.1	Peak	Horizontal
*	9644.5	32.5	13.7	46.2	68.2	-22.0	Peak	Horizontal
	11200.0	32.8	18.9	51.7	74.0	-22.3	Peak	Horizontal
*	16801.5	34.1	23.1	57.2	68.2	-11.0	Peak	Horizontal
	7519.5	31.7	11.6	43.3	74.0	-30.7	Peak	Vertical
*	9644.5	34.3	13.7	48.0	68.2	-20.2	Peak	Vertical
	11191.5	34.0	18.5	52.5	74.0	-21.5	Peak	Vertical
*	16801.5	34.1	23.1	57.2	68.2	-11.0	Peak	Vertical

Note 1: "*" is not in restricted band, its limit is -27dBm/MHz. At a distance of 3 meters, the field strength limit in dBμV/m can be determined by adding a "conversion" factor of 95.2dB to the EIRP limit of -27dBm/MHz to obtain the limit for out of band spurious emissions.

Note 2: Measure Level (dBμV/m) = Reading Level (dBμV) + Factor (dB)

Factor (dB) = Cable Loss (dB) + Antenna Factor (dB/m) - Pre_Amplifier Gain (dB)

Product	OmniAccess Stellar	Temperature	26°C
Test Engineer	Tyler Yuan	Relative Humidity	57 %
Test Site	AC1	Test Date	2019/12/14
Test Mode:	802.11ax-HE20 (CDD Mode)	Test Channel:	140
Remark:	1. Average measurement was not performed if peak level lower than average limit. 2. Other frequency was 20dB below limit line within 1-18GHz, there is not show in the report.		

Mark	Frequency (MHz)	Reading Level (dBμV)	Factor (dB)	Measure Level (dBμV/m)	Limit (dBμV/m)	Margin (dB)	Detector	Polarization
	7434.5	31.9	11.8	43.7	74.0	-30.3	Peak	Horizontal
*	10571.0	32.0	16.9	48.9	68.2	-19.3	Peak	Horizontal
	11404.0	31.8	19.0	50.8	74.0	-23.2	Peak	Horizontal
*	17099.0	35.0	22.7	57.7	68.2	-10.5	Peak	Horizontal
	7468.5	31.0	11.8	42.8	74.0	-31.2	Peak	Vertical
*	9746.5	32.6	13.9	46.5	68.2	-21.7	Peak	Vertical
	11404.0	29.8	19.0	48.8	54.0	-5.2	Peak	Vertical
*	14268.5	29.7	23.5	53.2	68.2	-15.0	Peak	Vertical

Note 1: "*" is not in restricted band, its limit is -27dBm/MHz. At a distance of 3 meters, the field strength limit in dBμV/m can be determined by adding a "conversion" factor of 95.2dB to the EIRP limit of -27dBm/MHz to obtain the limit for out of band spurious emissions.

Note 2: Measure Level (dBμV/m) = Reading Level (dBμV) + Factor (dB)

Factor (dB) = Cable Loss (dB) + Antenna Factor (dB/m) - Pre_Amplifier Gain (dB)

Product	OmniAccess Stellar	Temperature	26°C
Test Engineer	Tyler Yuan	Relative Humidity	57 %
Test Site	AC1	Test Date	2019/12/14
Test Mode:	802.11ax-HE20 (CDD Mode)	Test Channel:	144
Remark:	1. Average measurement was not performed if peak level lower than average limit. 2. Other frequency was 20dB below limit line within 1-18GHz, there is not show in the report.		

Mark	Frequency (MHz)	Reading Level (dBμV)	Factor (dB)	Measure Level (dBμV/m)	Limit (dBμV/m)	Margin (dB)	Detector	Polarization
	7570.5	30.8	11.6	42.4	74.0	-31.6	Peak	Horizontal
*	9576.5	32.8	13.5	46.3	68.2	-21.9	Peak	Horizontal
	11446.5	31.7	19.3	51.0	74.0	-23.0	Peak	Horizontal
*	13869.0	30.4	23.1	53.5	68.2	-14.7	Peak	Horizontal
	7502.5	32.8	11.8	44.6	74.0	-29.4	Peak	Vertical
*	10256.5	33.3	15.5	48.8	68.2	-19.4	Peak	Vertical
	11438.0	33.8	19.4	53.2	74.0	-20.8	Peak	Vertical
*	13937.0	30.0	23.2	53.2	68.2	-15.0	Peak	Vertical

Note 1: "*" is not in restricted band, its limit is -27dBm/MHz. At a distance of 3 meters, the field strength limit in dBμV/m can be determined by adding a "conversion" factor of 95.2dB to the EIRP limit of -27dBm/MHz to obtain the limit for out of band spurious emissions.

Note 2: Measure Level (dBμV/m) = Reading Level (dBμV) + Factor (dB)

Factor (dB) = Cable Loss (dB) + Antenna Factor (dB/m) - Pre_Amplifier Gain (dB)

Product	OmniAccess Stellar	Temperature	26°C
Test Engineer	Tyler Yuan	Relative Humidity	57 %
Test Site	AC1	Test Date	2019/12/15
Test Mode:	802.11ax-HE40 (CDD Mode)	Test Channel:	54
Remark:	1. Average measurement was not performed if peak level lower than average limit. 2. Other frequency was 20dB below limit line within 1-18GHz, there is not show in the report.		

Mark	Frequency (MHz)	Reading Level (dBμV)	Factor (dB)	Measure Level (dBμV/m)	Limit (dBμV/m)	Margin (dB)	Detector	Polarization
	7426.0	32.6	11.9	44.5	74.0	-29.5	Peak	Horizontal
*	10401.0	32.2	16.3	48.5	68.2	-19.7	Peak	Horizontal
	11480.5	30.3	19.7	50.0	74.0	-24.0	Peak	Horizontal
*	14693.5	30.6	23.1	53.7	68.2	-14.5	Peak	Horizontal
	7383.5	32.8	11.8	44.6	74.0	-29.4	Peak	Vertical
*	9644.5	33.9	13.7	47.6	68.2	-20.6	Peak	Vertical
	10962.0	31.7	18.5	50.2	74.0	-23.8	Peak	Vertical
*	13962.5	30.3	22.6	52.9	68.2	-15.3	Peak	Vertical

Note 1: "*" is not in restricted band, its limit is -27dBm/MHz. At a distance of 3 meters, the field strength limit in dBμV/m can be determined by adding a "conversion" factor of 95.2dB to the EIRP limit of -27dBm/MHz to obtain the limit for out of band spurious emissions.

Note 2: Measure Level (dBμV/m) = Reading Level (dBμV) + Factor (dB)

Factor (dB) = Cable Loss (dB) + Antenna Factor (dB/m) - Pre_Amplifier Gain (dB)

Product	OmniAccess Stellar	Temperature	26°C
Test Engineer	Tyler Yuan	Relative Humidity	57 %
Test Site	AC1	Test Date	2019/12/15
Test Mode:	802.11ax-HE40 (CDD Mode)	Test Channel:	62
Remark:	1. Average measurement was not performed if peak level lower than average limit. 2. Other frequency was 20dB below limit line within 1-18GHz, there is not show in the report.		

Mark	Frequency (MHz)	Reading Level (dBμV)	Factor (dB)	Measure Level (dBμV/m)	Limit (dBμV/m)	Margin (dB)	Detector	Polarization
	7443.0	32.4	11.8	44.2	74.0	-29.8	Peak	Horizontal
*	9636.0	32.7	13.7	46.4	68.2	-21.8	Peak	Horizontal
	10630.5	33.7	17.1	50.8	74.0	-23.2	Peak	Horizontal
*	13707.5	30.5	22.0	52.5	68.2	-15.7	Peak	Horizontal
	7426.0	32.0	11.9	43.9	74.0	-30.1	Peak	Vertical
*	9644.5	33.0	13.7	46.7	68.2	-21.5	Peak	Vertical
	11548.5	30.1	19.8	49.9	74.0	-24.1	Peak	Vertical
*	13444.0	29.0	23.2	52.2	68.2	-16.0	Peak	Vertical

Note 1: "*" is not in restricted band, its limit is -27dBm/MHz. At a distance of 3 meters, the field strength limit in dBμV/m can be determined by adding a "conversion" factor of 95.2dB to the EIRP limit of -27dBm/MHz to obtain the limit for out of band spurious emissions.

Note 2: Measure Level (dBμV/m) = Reading Level (dBμV) + Factor (dB)

Factor (dB) = Cable Loss (dB) + Antenna Factor (dB/m) - Pre_Amplifier Gain (dB)

Product	OmniAccess Stellar	Temperature	26°C
Test Engineer	Tyler Yuan	Relative Humidity	57 %
Test Site	AC1	Test Date	2019/12/15
Test Mode:	802.11ax-HE40 (CDD Mode)	Test Channel:	102
Remark:	1. Average measurement was not performed if peak level lower than average limit. 2. Other frequency was 20dB below limit line within 1-18GHz, there is not show in the report.		

Mark	Frequency (MHz)	Reading Level (dBμV)	Factor (dB)	Measure Level (dBμV/m)	Limit (dBμV/m)	Margin (dB)	Detector	Polarization
	7494.0	32.6	12.0	44.6	74.0	-29.4	Peak	Horizontal
*	10571.0	31.9	16.9	48.8	68.2	-19.4	Peak	Horizontal
	11540.0	30.2	19.9	50.1	74.0	-23.9	Peak	Horizontal
*	13937.0	29.6	23.2	52.8	68.2	-15.4	Peak	Horizontal
	7460.0	33.1	11.6	44.7	74.0	-29.3	Peak	Vertical
*	9644.5	32.8	13.7	46.5	68.2	-21.7	Peak	Vertical
	10868.5	31.5	18.1	49.6	74.0	-24.4	Peak	Vertical
*	14413.0	30.1	23.5	53.6	68.2	-14.6	Peak	Vertical

Note 1: "*" is not in restricted band, its limit is -27dBm/MHz. At a distance of 3 meters, the field strength limit in dBμV/m can be determined by adding a "conversion" factor of 95.2dB to the EIRP limit of -27dBm/MHz to obtain the limit for out of band spurious emissions.

Note 2: Measure Level (dBμV/m) = Reading Level (dBμV) + Factor (dB)

Factor (dB) = Cable Loss (dB) + Antenna Factor (dB/m) - Pre_Amplifier Gain (dB)

Product	OmniAccess Stellar	Temperature	26°C
Test Engineer	Tyler Yuan	Relative Humidity	57 %
Test Site	AC1	Test Date	2019/12/15
Test Mode:	802.11ax-HE40 (CDD Mode)	Test Channel:	118
Remark:	1. Average measurement was not performed if peak level lower than average limit. 2. Other frequency was 20dB below limit line within 1-18GHz, there is not show in the report.		

Mark	Frequency (MHz)	Reading Level (dBμV)	Factor (dB)	Measure Level (dBμV/m)	Limit (dBμV/m)	Margin (dB)	Detector	Polarization
	7553.5	32.5	11.8	44.3	74.0	-29.7	Peak	Horizontal
*	10494.5	32.5	16.5	49.0	68.2	-19.2	Peak	Horizontal
	11174.5	32.4	18.3	50.7	74.0	-23.3	Peak	Horizontal
*	13444.0	29.7	23.2	52.9	68.2	-15.3	Peak	Horizontal
	7672.5	33.6	11.4	45.0	74.0	-29.0	Peak	Vertical
*	9644.5	33.9	13.7	47.6	68.2	-20.6	Peak	Vertical
	11200.0	31.1	18.9	50.0	74.0	-24.0	Peak	Vertical
*	13996.5	31.4	23.1	54.5	68.2	-13.7	Peak	Vertical

Note 1: "*" is not in restricted band, its limit is -27dBm/MHz. At a distance of 3 meters, the field strength limit in dBμV/m can be determined by adding a "conversion" factor of 95.2dB to the EIRP limit of -27dBm/MHz to obtain the limit for out of band spurious emissions.

Note 2: Measure Level (dBμV/m) = Reading Level (dBμV) + Factor (dB)

Factor (dB) = Cable Loss (dB) + Antenna Factor (dB/m) - Pre_Amplifier Gain (dB)

Product	OmniAccess Stellar	Temperature	26°C
Test Engineer	Tyler Yuan	Relative Humidity	57 %
Test Site	AC1	Test Date	2019/12/15
Test Mode:	802.11ax-HE40 (CDD Mode)	Test Channel:	134
Remark:	1. Average measurement was not performed if peak level lower than average limit. 2. Other frequency was 20dB below limit line within 1-18GHz, there is not show in the report.		

Mark	Frequency (MHz)	Reading Level (dBμV)	Factor (dB)	Measure Level (dBμV/m)	Limit (dBμV/m)	Margin (dB)	Detector	Polarization
	7494.0	32.2	12.0	44.2	74.0	-29.8	Peak	Horizontal
*	10163.0	32.7	15.0	47.7	68.2	-20.5	Peak	Horizontal
	11336.0	31.7	19.0	50.7	74.0	-23.3	Peak	Horizontal
*	13886.0	29.1	23.3	52.4	68.2	-15.8	Peak	Horizontal
	7672.5	32.8	11.4	44.2	74.0	-29.8	Peak	Vertical
*	10299.0	32.0	15.7	47.7	68.2	-20.5	Peak	Vertical
	11336.0	33.4	19.0	52.4	74.0	-21.6	Peak	Vertical
*	13860.5	30.3	22.6	52.9	68.2	-15.3	Peak	Vertical

Note 1: "*" is not in restricted band, its limit is -27dBm/MHz. At a distance of 3 meters, the field strength limit in dBμV/m can be determined by adding a "conversion" factor of 95.2dB to the EIRP limit of -27dBm/MHz to obtain the limit for out of band spurious emissions.

Note 2: Measure Level (dBμV/m) = Reading Level (dBμV) + Factor (dB)

Factor (dB) = Cable Loss (dB) + Antenna Factor (dB/m) - Pre_Amplifier Gain (dB)

Product	OmniAccess Stellar	Temperature	26°C
Test Engineer	Tyler Yuan	Relative Humidity	57 %
Test Site	AC1	Test Date	2019/12/15
Test Mode:	802.11ax-HE40 (CDD Mode)	Test Channel:	142
Remark:	1. Average measurement was not performed if peak level lower than average limit. 2. Other frequency was 20dB below limit line within 1-18GHz, there is not show in the report.		

Mark	Frequency (MHz)	Reading Level (dBμV)	Factor (dB)	Measure Level (dBμV/m)	Limit (dBμV/m)	Margin (dB)	Detector	Polarization
	7409.0	32.3	11.6	43.9	74.0	-30.1	Peak	Horizontal
*	10035.5	32.6	14.5	47.1	68.2	-21.1	Peak	Horizontal
	11429.5	31.8	19.3	51.1	74.0	-22.9	Peak	Horizontal
*	14047.5	30.3	23.1	53.4	68.2	-14.8	Peak	Horizontal
	7349.5	32.2	11.7	43.9	74.0	-30.1	Peak	Vertical
*	10231.0	30.7	15.3	46.0	68.2	-22.2	Peak	Vertical
	11514.5	30.8	19.5	50.3	74.0	-23.7	Peak	Vertical
*	13435.5	29.2	22.8	52.0	68.2	-16.2	Peak	Vertical

Note 1: "*" is not in restricted band, its limit is -27dBm/MHz. At a distance of 3 meters, the field strength limit in dBμV/m can be determined by adding a "conversion" factor of 95.2dB to the EIRP limit of -27dBm/MHz to obtain the limit for out of band spurious emissions.

Note 2: Measure Level (dBμV/m) = Reading Level (dBμV) + Factor (dB)

Factor (dB) = Cable Loss (dB) + Antenna Factor (dB/m) - Pre_Amplifier Gain (dB)

Product	OmniAccess Stellar	Temperature	26°C
Test Engineer	Tyler Yuan	Relative Humidity	57 %
Test Site	AC1	Test Date	2019/12/15
Test Mode:	802.11ax-HE80 (CDD Mode)	Test Channel:	58
Remark:	1. Average measurement was not performed if peak level lower than average limit. 2. Other frequency was 20dB below limit line within 1-18GHz, there is not show in the report.		

Mark	Frequency (MHz)	Reading Level (dBμV)	Factor (dB)	Measure Level (dBμV/m)	Limit (dBμV/m)	Margin (dB)	Detector	Polarization
	7434.5	32.6	11.8	44.4	74.0	-29.6	Peak	Horizontal
*	9959.0	33.1	14.5	47.6	68.2	-20.6	Peak	Horizontal
	11489.0	30.2	20.2	50.4	74.0	-23.6	Peak	Horizontal
*	14175.0	30.2	23.5	53.7	68.2	-14.5	Peak	Horizontal
	7426.0	32.8	11.9	44.7	74.0	-29.3	Peak	Vertical
*	10248.0	33.2	15.5	48.7	68.2	-19.5	Peak	Vertical
	11540.0	30.7	19.9	50.6	74.0	-23.4	Peak	Vertical
*	14277.0	29.8	23.5	53.3	68.2	-14.9	Peak	Vertical

Note 1: "*" is not in restricted band, its limit is -27dBm/MHz. At a distance of 3 meters, the field strength limit in dBμV/m can be determined by adding a "conversion" factor of 95.2dB to the EIRP limit of -27dBm/MHz to obtain the limit for out of band spurious emissions.

Note 2: Measure Level (dBμV/m) = Reading Level (dBμV) + Factor (dB)

Factor (dB) = Cable Loss (dB) + Antenna Factor (dB/m) - Pre_Amplifier Gain (dB)

Product	OmniAccess Stellar	Temperature	26°C
Test Engineer	Tyler Yuan	Relative Humidity	57 %
Test Site	AC1	Test Date	2019/12/15
Test Mode:	802.11ax-HE80 (CDD Mode)	Test Channel:	106
Remark:	1. Average measurement was not performed if peak level lower than average limit. 2. Other frequency was 20dB below limit line within 1-18GHz, there is not show in the report.		

Mark	Frequency (MHz)	Reading Level (dBμV)	Factor (dB)	Measure Level (dBμV/m)	Limit (dBμV/m)	Margin (dB)	Detector	Polarization
	7468.5	31.9	11.8	43.7	74.0	-30.3	Peak	Horizontal
*	9755.0	32.1	14.0	46.1	68.2	-22.1	Peak	Horizontal
	11582.5	30.8	19.5	50.3	74.0	-23.7	Peak	Horizontal
*	14277.0	30.7	23.5	54.2	68.2	-14.0	Peak	Horizontal
	7460.0	32.3	11.6	43.9	74.0	-30.1	Peak	Vertical
*	9644.5	32.5	13.7	46.2	68.2	-22.0	Peak	Vertical
	10911.0	31.1	18.3	49.4	74.0	-24.6	Peak	Vertical
*	14413.0	28.9	23.5	52.4	68.2	-15.8	Peak	Vertical

Note 1: "*" is not in restricted band, its limit is -27dBm/MHz. At a distance of 3 meters, the field strength limit in dBμV/m can be determined by adding a "conversion" factor of 95.2dB to the EIRP limit of -27dBm/MHz to obtain the limit for out of band spurious emissions.

Note 2: Measure Level (dBμV/m) = Reading Level (dBμV) + Factor (dB)

Factor (dB) = Cable Loss (dB) + Antenna Factor (dB/m) - Pre_Amplifier Gain (dB)

Product	OmniAccess Stellar	Temperature	26°C
Test Engineer	Tyler Yuan	Relative Humidity	57 %
Test Site	AC1	Test Date	2019/12/15
Test Mode:	802.11ax-HE80 (CDD Mode)	Test Channel:	122
Remark:	1. Average measurement was not performed if peak level lower than average limit. 2. Other frequency was 20dB below limit line within 1-18GHz, there is not show in the report.		

Mark	Frequency (MHz)	Reading Level (dBμV)	Factor (dB)	Measure Level (dBμV/m)	Limit (dBμV/m)	Margin (dB)	Detector	Polarization
	7545.0	32.4	11.9	44.3	74.0	-29.7	Peak	Horizontal
*	10035.5	32.5	14.5	47.0	68.2	-21.2	Peak	Horizontal
	11489.0	31.0	20.2	51.2	74.0	-22.8	Peak	Horizontal
*	13435.5	29.5	22.8	52.3	68.2	-15.9	Peak	Horizontal
	7434.5	31.1	11.8	42.9	74.0	-31.1	Peak	Vertical
*	9823.0	32.1	14.1	46.2	68.2	-22.0	Peak	Vertical
	11217.0	30.8	19.1	49.9	74.0	-24.1	Peak	Vertical
*	14039.0	30.7	22.9	53.6	68.2	-14.6	Peak	Vertical

Note 1: "*" is not in restricted band, its limit is -27dBm/MHz. At a distance of 3 meters, the field strength limit in dBμV/m can be determined by adding a "conversion" factor of 95.2dB to the EIRP limit of -27dBm/MHz to obtain the limit for out of band spurious emissions.

Note 2: Measure Level (dBμV/m) = Reading Level (dBμV) + Factor (dB)

Factor (dB) = Cable Loss (dB) + Antenna Factor (dB/m) - Pre_Amplifier Gain (dB)

Product	OmniAccess Stellar	Temperature	26°C
Test Engineer	Tyler Yuan	Relative Humidity	57 %
Test Site	AC1	Test Date	2019/12/15
Test Mode:	802.11ax-HE80 (CDD Mode)	Test Channel:	138
Remark:	1. Average measurement was not performed if peak level lower than average limit. 2. Other frequency was 20dB below limit line within 1-18GHz, there is not show in the report.		

Mark	Frequency (MHz)	Reading Level (dBμV)	Factor (dB)	Measure Level (dBμV/m)	Limit (dBμV/m)	Margin (dB)	Detector	Polarization
	7545.0	32.1	11.9	44.0	74.0	-30.0	Peak	Horizontal
*	10180.0	32.3	15.2	47.5	68.2	-20.7	Peak	Horizontal
	11378.5	31.5	19.4	50.9	74.0	-23.1	Peak	Horizontal
*	16861.0	33.0	23.4	56.4	68.2	-11.8	Peak	Horizontal
	7494.0	32.7	12.0	44.7	74.0	-29.3	Peak	Vertical
*	9644.5	33.8	13.7	47.5	68.2	-20.7	Peak	Vertical
	11361.5	32.0	19.0	51.0	74.0	-23.0	Peak	Vertical
*	14651.0	31.2	22.6	53.8	68.2	-14.4	Peak	Vertical

Note 1: "*" is not in restricted band, its limit is -27dBm/MHz. At a distance of 3 meters, the field strength limit in dBμV/m can be determined by adding a "conversion" factor of 95.2dB to the EIRP limit of -27dBm/MHz to obtain the limit for out of band spurious emissions.

Note 2: Measure Level (dBμV/m) = Reading Level (dBμV) + Factor (dB)

Factor (dB) = Cable Loss (dB) + Antenna Factor (dB/m) - Pre_Amplifier Gain (dB)

Product	OmniAccess Stellar	Temperature	26°C
Test Engineer	Tyler Yuan	Relative Humidity	57 %
Test Site	AC1	Test Date	2019/12/15
Test Mode:	802.11ax-HE80 + 80 (CDD Mode)	Test Channel:	42 + 58
Remark:	1. Average measurement was not performed if peak level lower than average limit. 2. Other frequency was 20dB below limit line within 1-18GHz, there is not show in the report.		

Mark	Frequency (MHz)	Reading Level (dBμV)	Factor (dB)	Measure Level (dBμV/m)	Limit (dBμV/m)	Margin (dB)	Detector	Polarization
	7681.0	33.6	12.2	45.8	74.0	-28.2	Peak	Horizontal
	8199.5	32.8	12.3	45.1	74.0	-28.9	Peak	Horizontal
*	8786.0	32.4	13.7	46.1	68.2	-22.1	Peak	Horizontal
*	9678.5	33.9	14.4	48.3	68.2	-19.9	Peak	Horizontal
	7579.0	32.7	12.1	44.8	74.0	-29.2	Peak	Vertical
	8208.0	32.7	12.2	44.9	74.0	-29.1	Peak	Vertical
*	8752.0	32.7	13.8	46.5	68.2	-21.7	Peak	Vertical
*	10579.5	35.4	16.8	52.2	68.2	-16.0	Peak	Vertical

Note 1: "*" is not in restricted band, its limit is -27dBm/MHz. At a distance of 3 meters, the field strength limit in dBμV/m can be determined by adding a "conversion" factor of 95.2dB to the EIRP limit of -27dBm/MHz to obtain the limit for out of band spurious emissions.

Note 2: Measure Level (dBμV/m) = Reading Level (dBμV) + Factor (dB)

Factor (dB) = Cable Loss (dB) + Antenna Factor (dB/m) - Pre_Amplifier Gain (dB)

Product	OmniAccess Stellar	Temperature	26°C
Test Engineer	Tyler Yuan	Relative Humidity	57 %
Test Site	AC1	Test Date	2019/12/15
Test Mode:	802.11ax-HE80 + 80 (CDD Mode)	Test Channel:	106 + 122
Remark:	1. Average measurement was not performed if peak level lower than average limit. 2. Other frequency was 20dB below limit line within 1-18GHz, there is not show in the report.		

Mark	Frequency (MHz)	Reading Level (dBμV)	Factor (dB)	Measure Level (dBμV/m)	Limit (dBμV/m)	Margin (dB)	Detector	Polarization
	7630.0	33.8	11.9	45.7	74.0	-28.3	Peak	Horizontal
	8106.0	33.4	12.9	46.3	74.0	-27.7	Peak	Horizontal
*	8692.5	32.3	13.5	45.8	68.2	-22.4	Peak	Horizontal
*	10324.5	32.7	16.5	49.2	68.2	-19.0	Peak	Horizontal
	8276.0	33.1	12.3	45.4	74.0	-28.6	Peak	Vertical
*	8658.5	32.4	13.4	45.8	68.2	-22.4	Peak	Vertical
*	10214.0	33.1	15.9	49.0	68.2	-19.2	Peak	Vertical
	11217.0	35.3	18.9	54.2	74.0	-19.8	Peak	Vertical
	11220.3	31.5	18.9	50.4	54.0	-3.6	Average	Vertical

Note 1: "*" is not in restricted band, its limit is -27dBm/MHz. At a distance of 3 meters, the field strength limit in dBμV/m can be determined by adding a "conversion" factor of 95.2dB to the EIRP limit of -27dBm/MHz to obtain the limit for out of band spurious emissions.

Note 2: Measure Level (dBμV/m) = Reading Level (dBμV) + Factor (dB)

Factor (dB) = Cable Loss (dB) + Antenna Factor (dB/m) - Pre_Amplifier Gain (dB)

Product	OmniAccess Stellar	Temperature	26°C
Test Engineer	Tyler Yuan	Relative Humidity	57 %
Test Site	AC1	Test Date	2019/12/15
Test Mode:	802.11n-HT20 (Beamforming Mode)	Test Channel:	52
Remark:	1. Average measurement was not performed if peak level lower than average limit. 2. Other frequency was 20dB below limit line within 1-18GHz, there is not show in the report.		

Mark	Frequency (MHz)	Reading Level (dBμV)	Factor (dB)	Measure Level (dBμV/m)	Limit (dBμV/m)	Margin (dB)	Detector	Polarization
	7434.5	34.8	11.9	46.6	74.0	-27.4	Peak	Horizontal
	8344.0	35.3	12.0	47.3	74.0	-26.8	Peak	Horizontal
*	8913.5	34.0	13.4	47.3	68.2	-20.9	Peak	Horizontal
*	10188.5	33.2	16.3	49.4	68.2	-18.8	Peak	Horizontal
	7502.5	33.5	12.0	45.5	74.0	-28.5	Peak	Vertical
	8310.0	35.3	12.4	47.7	74.0	-26.3	Peak	Vertical
*	8871.0	34.6	13.5	48.0	68.2	-20.2	Peak	Vertical
*	10579.5	33.3	17.2	50.5	68.2	-17.7	Peak	Vertical

Note 1: "*" is not in restricted band, its limit is -27dBm/MHz. At a distance of 3 meters, the field strength limit in dBμV/m can be determined by adding a "conversion" factor of 95.2dB to the EIRP limit of -27dBm/MHz to obtain the limit for out of band spurious emissions.

Note 2: Measure Level (dBμV/m) = Reading Level (dBμV) + Factor (dB)

Factor (dB) = Cable Loss (dB) + Antenna Factor (dB/m) - Pre_Amplifier Gain (dB)

Product	OmniAccess Stellar	Temperature	26°C
Test Engineer	Tyler Yuan	Relative Humidity	57 %
Test Site	AC1	Test Date	2019/12/15
Test Mode:	802.11n-HT20 (Beamforming Mode)	Test Channel:	60
Remark:	<ol style="list-style-type: none"> 1. Average measurement was not performed if peak level lower than average limit. 2. Other frequency was 20dB below limit line within 1-18GHz, there is not show in the report. 		

Mark	Frequency (MHz)	Reading Level (dBμV)	Factor (dB)	Measure Level (dBμV/m)	Limit (dBμV/m)	Margin (dB)	Detector	Polarization
	7511.0	36.0	11.9	47.9	74.0	-26.1	Peak	Horizontal
	8233.5	36.1	12.3	48.3	74.0	-25.7	Peak	Horizontal
*	8760.5	35.7	13.4	49.1	68.2	-19.1	Peak	Horizontal
*	9908.0	33.0	16.1	49.0	68.2	-19.2	Peak	Horizontal
	7681.0	36.7	11.8	48.4	74.0	-25.6	Peak	Vertical
	8216.5	35.1	12.3	47.4	74.0	-26.6	Peak	Vertical
*	8862.5	33.4	13.4	46.8	68.2	-21.4	Peak	Vertical
*	9857.0	32.4	16.0	48.5	68.2	-19.8	Peak	Vertical

Note 1: "*" is not in restricted band, its limit is -27dBm/MHz. At a distance of 3 meters, the field strength limit in dBμV/m can be determined by adding a "conversion" factor of 95.2dB to the EIRP limit of -27dBm/MHz to obtain the limit for out of band spurious emissions.

Note 2: Measure Level (dBμV/m) = Reading Level (dBμV) + Factor (dB)

Factor (dB) = Cable Loss (dB) + Antenna Factor (dB/m) - Pre_Amplifier Gain (dB)

Product	OmniAccess Stellar	Temperature	26°C
Test Engineer	Tyler Yuan	Relative Humidity	57 %
Test Site	AC1	Test Date	2019/12/15
Test Mode:	802.11n-HT20 (Beamforming Mode)	Test Channel:	64
Remark:	1. Average measurement was not performed if peak level lower than average limit. 2. Other frequency was 20dB below limit line within 1-18GHz, there is not show in the report.		

Mark	Frequency (MHz)	Reading Level (dBμV)	Factor (dB)	Measure Level (dBμV/m)	Limit (dBμV/m)	Margin (dB)	Detector	Polarization
	7434.5	35.3	11.9	47.1	74.0	-26.9	Peak	Horizontal
	8250.5	34.6	12.3	46.9	74.0	-27.1	Peak	Horizontal
*	8675.5	34.4	13.1	47.4	68.2	-20.8	Peak	Horizontal
*	9976.0	33.4	15.9	49.3	68.2	-18.9	Peak	Horizontal
	7536.5	34.3	11.9	46.2	74.0	-27.8	Peak	Vertical
	8335.5	34.0	12.1	46.1	74.0	-28.0	Peak	Vertical
*	8726.5	33.8	13.2	46.9	68.2	-21.3	Peak	Vertical
*	10282.0	32.0	16.7	48.8	68.2	-19.4	Peak	Vertical

Note 1: "*" is not in restricted band, its limit is -27dBm/MHz. At a distance of 3 meters, the field strength limit in dBμV/m can be determined by adding a "conversion" factor of 95.2dB to the EIRP limit of -27dBm/MHz to obtain the limit for out of band spurious emissions.

Note 2: Measure Level (dBμV/m) = Reading Level (dBμV) + Factor (dB)

Factor (dB) = Cable Loss (dB) + Antenna Factor (dB/m) - Pre_Amplifier Gain (dB)

Product	OmniAccess Stellar	Temperature	26°C
Test Engineer	Tyler Yuan	Relative Humidity	57 %
Test Site	AC1	Test Date	2019/12/15
Test Mode:	802.11n-HT20 (Beamforming Mode)	Test Channel:	100
Remark:	<ol style="list-style-type: none"> 1. Average measurement was not performed if peak level lower than average limit. 2. Other frequency was 20dB below limit line within 1-18GHz, there is not show in the report. 		

Mark	Frequency (MHz)	Reading Level (dBμV)	Factor (dB)	Measure Level (dBμV/m)	Limit (dBμV/m)	Margin (dB)	Detector	Polarization
	7519.5	34.5	11.9	46.4	74.0	-27.6	Peak	Horizontal
	8267.5	34.1	12.1	46.2	74.0	-27.8	Peak	Horizontal
*	8803.0	33.6	13.4	46.9	68.2	-21.3	Peak	Horizontal
*	9797.5	34.7	15.9	50.6	68.2	-17.6	Peak	Horizontal
	7604.5	34.4	11.8	46.2	74.0	-27.8	Peak	Vertical
	8199.5	33.9	12.4	46.3	74.0	-27.7	Peak	Vertical
*	8718.0	33.4	13.2	46.6	68.2	-21.6	Peak	Vertical
*	10027.0	32.3	16.0	48.4	68.2	-19.8	Peak	Vertical

Note 1: "*" is not in restricted band, its limit is -27dBm/MHz. At a distance of 3 meters, the field strength limit in dBμV/m can be determined by adding a "conversion" factor of 95.2dB to the EIRP limit of -27dBm/MHz to obtain the limit for out of band spurious emissions.

Note 2: Measure Level (dBμV/m) = Reading Level (dBμV) + Factor (dB)

Factor (dB) = Cable Loss (dB) + Antenna Factor (dB/m) - Pre_Amplifier Gain (dB)

Product	OmniAccess Stellar	Temperature	26°C
Test Engineer	Tyler Yuan	Relative Humidity	57 %
Test Site	AC1	Test Date	2019/12/15
Test Mode:	802.11n-HT20 (Beamforming Mode)	Test Channel:	120
Remark:	1. Average measurement was not performed if peak level lower than average limit. 2. Other frequency was 20dB below limit line within 1-18GHz, there is not show in the report.		

Mark	Frequency (MHz)	Reading Level (dBμV)	Factor (dB)	Measure Level (dBμV/m)	Limit (dBμV/m)	Margin (dB)	Detector	Polarization
	7468.5	34.9	11.8	46.8	74.0	-27.2	Peak	Horizontal
	8199.5	33.8	12.4	46.2	74.0	-27.8	Peak	Horizontal
*	8701.0	33.3	13.3	46.5	68.2	-21.7	Peak	Horizontal
*	9865.5	32.9	16.1	48.9	68.2	-19.3	Peak	Horizontal
	7553.5	35.4	11.9	47.3	74.0	-26.7	Peak	Vertical
	8318.5	33.5	12.3	45.8	74.0	-28.2	Peak	Vertical
*	8947.5	33.3	13.4	46.7	68.2	-21.5	Peak	Vertical
*	10010.0	32.3	16.1	48.4	68.2	-19.8	Peak	Vertical

Note 1: "*" is not in restricted band, its limit is -27dBm/MHz. At a distance of 3 meters, the field strength limit in dBμV/m can be determined by adding a "conversion" factor of 95.2dB to the EIRP limit of -27dBm/MHz to obtain the limit for out of band spurious emissions.

Note 2: Measure Level (dBμV/m) = Reading Level (dBμV) + Factor (dB)

Factor (dB) = Cable Loss (dB) + Antenna Factor (dB/m) - Pre_Amplifier Gain (dB)

Product	OmniAccess Stellar	Temperature	26°C
Test Engineer	Tyler Yuan	Relative Humidity	57 %
Test Site	AC1	Test Date	2019/12/15
Test Mode:	802.11n-HT20 (Beamforming Mode)	Test Channel:	140
Remark:	1. Average measurement was not performed if peak level lower than average limit. 2. Other frequency was 20dB below limit line within 1-18GHz, there is not show in the report.		

Mark	Frequency (MHz)	Reading Level (dBμV)	Factor (dB)	Measure Level (dBμV/m)	Limit (dBμV/m)	Margin (dB)	Detector	Polarization
	7545.0	35.9	11.9	47.8	74.0	-26.2	Peak	Horizontal
	8140.0	34.6	12.5	47.1	74.0	-26.9	Peak	Horizontal
*	8871.0	34.1	13.5	47.6	68.2	-20.6	Peak	Horizontal
*	9899.5	33.1	16.1	49.2	68.2	-19.0	Peak	Horizontal
	7468.5	35.1	11.8	46.9	74.0	-27.1	Peak	Vertical
	8216.5	34.7	12.3	47.0	74.0	-27.0	Peak	Vertical
*	8794.5	33.9	13.3	47.2	68.2	-21.0	Peak	Vertical
*	10248.0	35.0	16.5	51.5	68.2	-16.7	Peak	Vertical

Note 1: "*" is not in restricted band, its limit is -27dBm/MHz. At a distance of 3 meters, the field strength limit in dBμV/m can be determined by adding a "conversion" factor of 95.2dB to the EIRP limit of -27dBm/MHz to obtain the limit for out of band spurious emissions.

Note 2: Measure Level (dBμV/m) = Reading Level (dBμV) + Factor (dB)

Factor (dB) = Cable Loss (dB) + Antenna Factor (dB/m) - Pre_Amplifier Gain (dB)

Product	OmniAccess Stellar	Temperature	26°C
Test Engineer	Tyler Yuan	Relative Humidity	57 %
Test Site	AC1	Test Date	2019/12/15
Test Mode:	802.11n-HT20 (Beamforming Mode)	Test Channel:	144
Remark:	1. Average measurement was not performed if peak level lower than average limit. 2. Other frequency was 20dB below limit line within 1-18GHz, there is not show in the report.		

Mark	Frequency (MHz)	Reading Level (dBμV)	Factor (dB)	Measure Level (dBμV/m)	Limit (dBμV/m)	Margin (dB)	Detector	Polarization
	7630.0	34.3	11.7	46.0	74.0	-28.0	Peak	Horizontal
	8250.5	34.3	12.3	46.6	74.0	-27.4	Peak	Horizontal
*	8930.5	33.6	13.4	47.0	68.2	-21.2	Peak	Horizontal
*	9721.0	33.1	15.4	48.6	68.2	-19.7	Peak	Horizontal
	7502.5	34.8	12.0	46.8	74.0	-27.2	Peak	Vertical
	8250.5	34.8	12.3	47.1	74.0	-26.9	Peak	Vertical
*	8871.0	34.2	13.5	47.6	68.2	-20.6	Peak	Vertical
*	9848.5	33.5	16.1	49.6	68.2	-18.6	Peak	Vertical

Note 1: "*" is not in restricted band, its limit is -27dBm/MHz. At a distance of 3 meters, the field strength limit in dBμV/m can be determined by adding a "conversion" factor of 95.2dB to the EIRP limit of -27dBm/MHz to obtain the limit for out of band spurious emissions.

Note 2: Measure Level (dBμV/m) = Reading Level (dBμV) + Factor (dB)

Factor (dB) = Cable Loss (dB) + Antenna Factor (dB/m) - Pre_Amplifier Gain (dB)

Product	OmniAccess Stellar	Temperature	26°C
Test Engineer	Tyler Yuan	Relative Humidity	57 %
Test Site	AC1	Test Date	2019/12/15
Test Mode:	802.11n-HT40 (Beamforming Mode)	Test Channel:	54
Remark:	1. Average measurement was not performed if peak level lower than average limit. 2. Other frequency was 20dB below limit line within 1-18GHz, there is not show in the report.		

Mark	Frequency (MHz)	Reading Level (dBμV)	Factor (dB)	Measure Level (dBμV/m)	Limit (dBμV/m)	Margin (dB)	Detector	Polarization
	7485.5	35.5	11.9	47.4	74.0	-26.6	Peak	Horizontal
	8420.5	35.2	12.3	47.5	74.0	-26.5	Peak	Horizontal
*	8828.5	34.7	13.4	48.1	68.2	-20.1	Peak	Horizontal
*	10027.0	33.2	16.0	49.2	68.2	-19.0	Peak	Horizontal
	7502.5	35.6	12.0	47.6	74.0	-26.4	Peak	Vertical
	8216.5	34.9	12.3	47.2	74.0	-26.8	Peak	Vertical
*	8845.5	34.8	13.4	48.2	68.2	-20.1	Peak	Vertical
*	9899.5	34.6	16.1	50.7	68.2	-17.5	Peak	Vertical

Note 1: "*" is not in restricted band, its limit is -27dBm/MHz. At a distance of 3 meters, the field strength limit in dBμV/m can be determined by adding a "conversion" factor of 95.2dB to the EIRP limit of -27dBm/MHz to obtain the limit for out of band spurious emissions.

Note 2: Measure Level (dBμV/m) = Reading Level (dBμV) + Factor (dB)

Factor (dB) = Cable Loss (dB) + Antenna Factor (dB/m) - Pre_Amplifier Gain (dB)

Product	OmniAccess Stellar	Temperature	26°C
Test Engineer	Tyler Yuan	Relative Humidity	57 %
Test Site	AC1	Test Date	2019/12/15
Test Mode:	802.11n-HT40 (Beamforming Mode)	Test Channel:	62
Remark:	1. Average measurement was not performed if peak level lower than average limit. 2. Other frequency was 20dB below limit line within 1-18GHz, there is not show in the report.		

Mark	Frequency (MHz)	Reading Level (dBμV)	Factor (dB)	Measure Level (dBμV/m)	Limit (dBμV/m)	Margin (dB)	Detector	Polarization
	7638.5	34.2	11.6	45.8	74.0	-28.2	Peak	Horizontal
	8259.0	36.0	12.2	48.3	74.0	-25.7	Peak	Horizontal
*	8752.0	35.9	13.3	49.2	68.2	-19.0	Peak	Horizontal
*	10069.5	34.1	16.1	50.2	68.2	-18.0	Peak	Horizontal
	7434.5	34.4	11.9	46.3	74.0	-27.8	Peak	Vertical
	8140.0	35.6	12.5	48.0	74.0	-26.0	Peak	Vertical
*	8913.5	34.2	13.4	47.6	68.2	-20.6	Peak	Vertical
*	9746.5	34.8	15.8	50.7	68.2	-17.5	Peak	Vertical

Note 1: "*" is not in restricted band, its limit is -27dBm/MHz. At a distance of 3 meters, the field strength limit in dBμV/m can be determined by adding a "conversion" factor of 95.2dB to the EIRP limit of -27dBm/MHz to obtain the limit for out of band spurious emissions.

Note 2: Measure Level (dBμV/m) = Reading Level (dBμV) + Factor (dB)

Factor (dB) = Cable Loss (dB) + Antenna Factor (dB/m) - Pre_Amplifier Gain (dB)

Product	OmniAccess Stellar	Temperature	26°C
Test Engineer	Tyler Yuan	Relative Humidity	57 %
Test Site	AC1	Test Date	2019/12/15
Test Mode:	802.11n-HT40 (Beamforming Mode)	Test Channel:	102
Remark:	1. Average measurement was not performed if peak level lower than average limit. 2. Other frequency was 20dB below limit line within 1-18GHz, there is not show in the report.		

Mark	Frequency (MHz)	Reading Level (dBμV)	Factor (dB)	Measure Level (dBμV/m)	Limit (dBμV/m)	Margin (dB)	Detector	Polarization
	7570.5	33.4	11.8	45.3	74.0	-28.7	Peak	Horizontal
	8403.5	33.9	12.2	46.1	74.0	-27.9	Peak	Horizontal
*	8888.0	35.4	13.4	48.7	68.2	-19.5	Peak	Horizontal
*	9891.0	32.3	16.2	48.4	68.2	-19.8	Peak	Horizontal
	7570.5	33.7	11.8	45.5	74.0	-28.5	Peak	Vertical
	8284.5	33.7	12.1	45.7	74.0	-28.3	Peak	Vertical
*	8718.0	35.0	13.2	48.2	68.2	-20.0	Peak	Vertical
*	10103.5	33.8	16.3	50.1	68.2	-18.1	Peak	Vertical

Note 1: "*" is not in restricted band, its limit is -27dBm/MHz. At a distance of 3 meters, the field strength limit in dBμV/m can be determined by adding a "conversion" factor of 95.2dB to the EIRP limit of -27dBm/MHz to obtain the limit for out of band spurious emissions.

Note 2: Measure Level (dBμV/m) = Reading Level (dBμV) + Factor (dB)

Factor (dB) = Cable Loss (dB) + Antenna Factor (dB/m) - Pre_Amplifier Gain (dB)

Product	OmniAccess Stellar	Temperature	26°C
Test Engineer	Tyler Yuan	Relative Humidity	57 %
Test Site	AC1	Test Date	2019/12/15
Test Mode:	802.11n-HT40 (Beamforming Mode)	Test Channel:	118
Remark:	1. Average measurement was not performed if peak level lower than average limit. 2. Other frequency was 20dB below limit line within 1-18GHz, there is not show in the report.		

Mark	Frequency (MHz)	Reading Level (dBμV)	Factor (dB)	Measure Level (dBμV/m)	Limit (dBμV/m)	Margin (dB)	Detector	Polarization
	7647.0	35.6	11.6	47.1	74.0	-26.9	Peak	Horizontal
	8369.5	33.9	12.3	46.2	74.0	-27.9	Peak	Horizontal
*	8794.5	34.5	13.3	47.8	68.2	-20.4	Peak	Horizontal
*	10214.0	35.2	16.5	51.7	68.2	-16.6	Peak	Horizontal
	7536.5	34.7	11.9	46.5	74.0	-27.5	Peak	Vertical
	8208.0	35.1	12.3	47.4	74.0	-26.6	Peak	Vertical
*	8709.5	35.0	13.2	48.2	68.2	-20.0	Peak	Vertical
*	10120.5	33.8	16.2	50.0	68.2	-18.2	Peak	Vertical

Note 1: "*" is not in restricted band, its limit is -27dBm/MHz. At a distance of 3 meters, the field strength limit in dBμV/m can be determined by adding a "conversion" factor of 95.2dB to the EIRP limit of -27dBm/MHz to obtain the limit for out of band spurious emissions.

Note 2: Measure Level (dBμV/m) = Reading Level (dBμV) + Factor (dB)

Factor (dB) = Cable Loss (dB) + Antenna Factor (dB/m) - Pre_Amplifier Gain (dB)

Product	OmniAccess Stellar	Temperature	26°C
Test Engineer	Tyler Yuan	Relative Humidity	57 %
Test Site	AC1	Test Date	2019/12/15
Test Mode:	802.11n-HT40 (Beamforming Mode)	Test Channel:	134
Remark:	1. Average measurement was not performed if peak level lower than average limit. 2. Other frequency was 20dB below limit line within 1-18GHz, there is not show in the report.		

Mark	Frequency (MHz)	Reading Level (dBμV)	Factor (dB)	Measure Level (dBμV/m)	Limit (dBμV/m)	Margin (dB)	Detector	Polarization
	7664.0	36.0	11.7	47.7	74.0	-26.3	Peak	Horizontal
	8293.0	35.7	12.1	47.8	74.0	-26.2	Peak	Horizontal
*	8718.0	34.1	13.2	47.3	68.2	-20.9	Peak	Horizontal
*	10154.5	34.2	16.4	50.6	68.2	-17.6	Peak	Horizontal
	7468.5	35.5	11.8	47.4	74.0	-26.6	Peak	Vertical
	8148.5	35.9	12.4	48.3	74.0	-25.7	Peak	Vertical
*	8743.5	35.0	13.3	48.3	68.2	-20.0	Peak	Vertical
*	9840.0	35.0	16.1	51.1	68.2	-17.1	Peak	Vertical

Note 1: "*" is not in restricted band, its limit is -27dBm/MHz. At a distance of 3 meters, the field strength limit in dBμV/m can be determined by adding a "conversion" factor of 95.2dB to the EIRP limit of -27dBm/MHz to obtain the limit for out of band spurious emissions.

Note 2: Measure Level (dBμV/m) = Reading Level (dBμV) + Factor (dB)

Factor (dB) = Cable Loss (dB) + Antenna Factor (dB/m) - Pre_Amplifier Gain (dB)

Product	OmniAccess Stellar	Temperature	26°C
Test Engineer	Tyler Yuan	Relative Humidity	57 %
Test Site	AC1	Test Date	2019/12/15
Test Mode:	802.11n-HT40 (Beamforming Mode)	Test Channel:	142
Remark:	1. Average measurement was not performed if peak level lower than average limit. 2. Other frequency was 20dB below limit line within 1-18GHz, there is not show in the report.		

Mark	Frequency (MHz)	Reading Level (dBμV)	Factor (dB)	Measure Level (dBμV/m)	Limit (dBμV/m)	Margin (dB)	Detector	Polarization
	7383.5	36.0	11.7	47.7	74.0	-26.3	Peak	Horizontal
	8182.5	35.1	12.4	47.5	74.0	-26.5	Peak	Horizontal
*	8675.5	34.4	13.1	47.4	68.2	-20.8	Peak	Horizontal
*	10027.0	33.6	16.0	49.6	68.2	-18.6	Peak	Horizontal
	7562.0	35.7	11.9	47.6	74.0	-26.4	Peak	Vertical
	8182.5	34.2	12.4	46.7	74.0	-27.3	Peak	Vertical
*	8718.0	33.8	13.2	47.0	68.2	-21.2	Peak	Vertical
*	10256.5	33.0	16.5	49.6	68.2	-18.6	Peak	Vertical

Note 1: "*" is not in restricted band, its limit is -27dBm/MHz. At a distance of 3 meters, the field strength limit in dBμV/m can be determined by adding a "conversion" factor of 95.2dB to the EIRP limit of -27dBm/MHz to obtain the limit for out of band spurious emissions.

Note 2: Measure Level (dBμV/m) = Reading Level (dBμV) + Factor (dB)

Factor (dB) = Cable Loss (dB) + Antenna Factor (dB/m) - Pre_Amplifier Gain (dB)

Product	OmniAccess Stellar	Temperature	26°C
Test Engineer	Tyler Yuan	Relative Humidity	57 %
Test Site	AC1	Test Date	2019/12/16
Test Mode:	802.11ax-HE20 (Beamforming Mode)	Test Channel:	52
Remark:	1. Average measurement was not performed if peak level lower than average limit. 2. Other frequency was 20dB below limit line within 1-18GHz, there is not show in the report.		

Mark	Frequency (MHz)	Reading Level (dBμV)	Factor (dB)	Measure Level (dBμV/m)	Limit (dBμV/m)	Margin (dB)	Detector	Polarization
	7426.0	34.8	11.9	46.7	74.0	-27.3	Peak	Horizontal
	8182.5	34.4	12.4	46.8	74.0	-27.2	Peak	Horizontal
*	8752.0	34.1	13.3	47.5	68.2	-20.7	Peak	Horizontal
*	10001.5	32.2	16.1	48.3	68.2	-19.9	Peak	Horizontal
	7519.5	34.3	11.9	46.2	74.0	-27.8	Peak	Vertical
	8250.5	33.8	12.3	46.0	74.0	-28.0	Peak	Vertical
*	8760.5	33.4	13.4	46.7	68.2	-21.5	Peak	Vertical
*	9984.5	32.9	16.0	48.9	68.2	-19.3	Peak	Vertical

Note 1: "*" is not in restricted band, its limit is -27dBm/MHz. At a distance of 3 meters, the field strength limit in dBμV/m can be determined by adding a "conversion" factor of 95.2dB to the EIRP limit of -27dBm/MHz to obtain the limit for out of band spurious emissions.

Note 2: Measure Level (dBμV/m) = Reading Level (dBμV) + Factor (dB)

Factor (dB) = Cable Loss (dB) + Antenna Factor (dB/m) - Pre_Amplifier Gain (dB)

Product	OmniAccess Stellar	Temperature	26°C
Test Engineer	Tyler Yuan	Relative Humidity	57 %
Test Site	AC1	Test Date	2019/12/16
Test Mode:	802.11ax-HE20 (Beamforming Mode)	Test Channel:	60
Remark:	1. Average measurement was not performed if peak level lower than average limit. 2. Other frequency was 20dB below limit line within 1-18GHz, there is not show in the report.		

Mark	Frequency (MHz)	Reading Level (dBμV)	Factor (dB)	Measure Level (dBμV/m)	Limit (dBμV/m)	Margin (dB)	Detector	Polarization
	7443.0	33.2	11.9	45.1	74.0	-28.9	Peak	Horizontal
	8216.5	33.7	12.3	46.0	74.0	-28.0	Peak	Horizontal
*	8709.5	34.0	13.2	47.2	68.2	-21.0	Peak	Horizontal
*	9976.0	32.4	15.9	48.4	68.2	-19.8	Peak	Horizontal
	7375.0	33.8	11.7	45.5	74.0	-28.5	Peak	Vertical
	8216.5	33.5	12.3	45.7	74.0	-28.3	Peak	Vertical
*	8794.5	32.6	13.3	45.9	68.2	-22.3	Peak	Vertical
*	10044.0	32.2	16.1	48.3	68.2	-19.9	Peak	Vertical

Note 1: "*" is not in restricted band, its limit is -27dBm/MHz. At a distance of 3 meters, the field strength limit in dBμV/m can be determined by adding a "conversion" factor of 95.2dB to the EIRP limit of -27dBm/MHz to obtain the limit for out of band spurious emissions.

Note 2: Measure Level (dBμV/m) = Reading Level (dBμV) + Factor (dB)

Factor (dB) = Cable Loss (dB) + Antenna Factor (dB/m) - Pre_Amplifier Gain (dB)

Product	OmniAccess Stellar	Temperature	26°C
Test Engineer	Tyler Yuan	Relative Humidity	57 %
Test Site	AC1	Test Date	2019/12/16
Test Mode:	802.11ax-HE20 (Beamforming Mode)	Test Channel:	64
Remark:	1. Average measurement was not performed if peak level lower than average limit. 2. Other frequency was 20dB below limit line within 1-18GHz, there is not show in the report.		

Mark	Frequency (MHz)	Reading Level (dBμV)	Factor (dB)	Measure Level (dBμV/m)	Limit (dBμV/m)	Margin (dB)	Detector	Polarization
	7553.5	34.8	11.9	46.8	74.0	-27.3	Peak	Horizontal
	8335.5	33.3	12.1	45.4	74.0	-28.6	Peak	Horizontal
*	8794.5	33.3	13.3	46.7	68.2	-21.5	Peak	Horizontal
*	9780.5	32.7	15.9	48.5	68.2	-19.7	Peak	Horizontal
	7621.5	33.6	11.8	45.3	74.0	-28.7	Peak	Vertical
	8293.0	33.7	12.1	45.8	74.0	-28.2	Peak	Vertical
*	8675.5	32.9	13.1	45.9	68.2	-22.3	Peak	Vertical
*	10214.0	32.4	16.5	48.8	68.2	-19.4	Peak	Vertical

Note 1: "*" is not in restricted band, its limit is -27dBm/MHz. At a distance of 3 meters, the field strength limit in dBμV/m can be determined by adding a "conversion" factor of 95.2dB to the EIRP limit of -27dBm/MHz to obtain the limit for out of band spurious emissions.

Note 2: Measure Level (dBμV/m) = Reading Level (dBμV) + Factor (dB)

Factor (dB) = Cable Loss (dB) + Antenna Factor (dB/m) - Pre_Amplifier Gain (dB)

Product	OmniAccess Stellar	Temperature	26°C
Test Engineer	Tyler Yuan	Relative Humidity	57 %
Test Site	AC1	Test Date	2019/12/16
Test Mode:	802.11ax-HE20 (Beamforming Mode)	Test Channel:	100
Remark:	1. Average measurement was not performed if peak level lower than average limit. 2. Other frequency was 20dB below limit line within 1-18GHz, there is not show in the report.		

Mark	Frequency (MHz)	Reading Level (dBμV)	Factor (dB)	Measure Level (dBμV/m)	Limit (dBμV/m)	Margin (dB)	Detector	Polarization
	7511.0	32.5	11.9	44.4	74.0	-29.6	Peak	Horizontal
	8267.5	33.7	12.1	45.8	74.0	-28.2	Peak	Horizontal
*	8752.0	32.9	13.3	46.2	68.2	-22.0	Peak	Horizontal
*	9891.0	32.4	16.2	48.6	68.2	-19.6	Peak	Horizontal
	7570.5	33.1	11.8	45.0	74.0	-29.1	Peak	Vertical
	8327.0	34.1	12.2	46.3	74.0	-27.7	Peak	Vertical
*	8794.5	34.3	13.3	47.7	68.2	-20.5	Peak	Vertical
*	10392.5	33.9	16.9	50.8	68.2	-17.4	Peak	Vertical

Note 1: "*" is not in restricted band, its limit is -27dBm/MHz. At a distance of 3 meters, the field strength limit in dBμV/m can be determined by adding a "conversion" factor of 95.2dB to the EIRP limit of -27dBm/MHz to obtain the limit for out of band spurious emissions.

Note 2: Measure Level (dBμV/m) = Reading Level (dBμV) + Factor (dB)

Factor (dB) = Cable Loss (dB) + Antenna Factor (dB/m) - Pre_Amplifier Gain (dB)

Product	OmniAccess Stellar	Temperature	26°C
Test Engineer	Tyler Yuan	Relative Humidity	57 %
Test Site	AC1	Test Date	2019/12/16
Test Mode:	802.11ax-HE20 (Beamforming Mode)	Test Channel:	120
Remark:	1. Average measurement was not performed if peak level lower than average limit. 2. Other frequency was 20dB below limit line within 1-18GHz, there is not show in the report.		

Mark	Frequency (MHz)	Reading Level (dBμV)	Factor (dB)	Measure Level (dBμV/m)	Limit (dBμV/m)	Margin (dB)	Detector	Polarization
	7528.0	34.7	11.8	46.5	74.0	-27.5	Peak	Horizontal
	8335.5	34.8	12.1	46.9	74.0	-27.1	Peak	Horizontal
*	8777.5	33.3	13.3	46.6	68.2	-21.6	Peak	Horizontal
*	9933.5	32.7	16.1	48.7	68.2	-19.5	Peak	Horizontal
	7536.5	33.7	11.9	45.6	74.0	-28.4	Peak	Vertical
	8191.0	33.8	12.5	46.3	74.0	-27.7	Peak	Vertical
*	8803.0	33.8	13.4	47.1	68.2	-21.1	Peak	Vertical
*	10044.0	34.5	16.1	50.6	68.2	-17.6	Peak	Vertical

Note 1: "*" is not in restricted band, its limit is -27dBm/MHz. At a distance of 3 meters, the field strength limit in dBμV/m can be determined by adding a "conversion" factor of 95.2dB to the EIRP limit of -27dBm/MHz to obtain the limit for out of band spurious emissions.

Note 2: Measure Level (dBμV/m) = Reading Level (dBμV) + Factor (dB)

Factor (dB) = Cable Loss (dB) + Antenna Factor (dB/m) - Pre_Amplifier Gain (dB)

Product	OmniAccess Stellar	Temperature	26°C
Test Engineer	Tyler Yuan	Relative Humidity	57 %
Test Site	AC1	Test Date	2019/12/16
Test Mode:	802.11ax-HE20 (Beamforming Mode)	Test Channel:	140
Remark:	1. Average measurement was not performed if peak level lower than average limit. 2. Other frequency was 20dB below limit line within 1-18GHz, there is not show in the report.		

Mark	Frequency (MHz)	Reading Level (dBμV)	Factor (dB)	Measure Level (dBμV/m)	Limit (dBμV/m)	Margin (dB)	Detector	Polarization
	7655.5	33.7	11.6	45.3	74.0	-28.7	Peak	Horizontal
	8412.0	33.9	12.2	46.1	74.0	-27.9	Peak	Horizontal
*	8828.5	34.1	13.4	47.4	68.2	-20.8	Peak	Horizontal
*	10299.0	33.2	16.6	49.7	68.2	-18.5	Peak	Horizontal
	7519.5	34.8	11.9	46.7	74.0	-27.3	Peak	Vertical
	8344.0	34.5	12.0	46.4	74.0	-27.6	Peak	Vertical
*	8760.5	33.7	13.4	47.1	68.2	-21.1	Peak	Vertical
*	9925.0	32.1	16.0	48.1	68.2	-20.1	Peak	Vertical

Note 1: "*" is not in restricted band, its limit is -27dBm/MHz. At a distance of 3 meters, the field strength limit in dBμV/m can be determined by adding a "conversion" factor of 95.2dB to the EIRP limit of -27dBm/MHz to obtain the limit for out of band spurious emissions.

Note 2: Measure Level (dBμV/m) = Reading Level (dBμV) + Factor (dB)

Factor (dB) = Cable Loss (dB) + Antenna Factor (dB/m) - Pre_Amplifier Gain (dB)

Product	OmniAccess Stellar	Temperature	26°C
Test Engineer	Tyler Yuan	Relative Humidity	57 %
Test Site	AC1	Test Date	2019/12/16
Test Mode:	802.11ax-HE20 (Beamforming Mode)	Test Channel:	144
Remark:	1. Average measurement was not performed if peak level lower than average limit. 2. Other frequency was 20dB below limit line within 1-18GHz, there is not show in the report.		

Mark	Frequency (MHz)	Reading Level (dBμV)	Factor (dB)	Measure Level (dBμV/m)	Limit (dBμV/m)	Margin (dB)	Detector	Polarization
	7621.5	33.5	11.8	45.3	74.0	-28.7	Peak	Horizontal
	8250.5	33.9	12.3	46.1	74.0	-27.9	Peak	Horizontal
*	8633.0	33.8	13.1	46.8	68.2	-21.4	Peak	Horizontal
*	9984.5	32.2	16.0	48.2	68.2	-20.0	Peak	Horizontal
	7706.5	32.8	11.7	44.5	74.0	-29.5	Peak	Vertical
	8403.5	34.9	12.2	47.1	74.0	-26.9	Peak	Vertical
*	8752.0	33.6	13.3	47.0	68.2	-21.2	Peak	Vertical
*	9908.0	31.6	16.1	47.6	68.2	-20.6	Peak	Vertical

Note 1: "*" is not in restricted band, its limit is -27dBm/MHz. At a distance of 3 meters, the field strength limit in dBμV/m can be determined by adding a "conversion" factor of 95.2dB to the EIRP limit of -27dBm/MHz to obtain the limit for out of band spurious emissions.

Note 2: Measure Level (dBμV/m) = Reading Level (dBμV) + Factor (dB)

Factor (dB) = Cable Loss (dB) + Antenna Factor (dB/m) - Pre_Amplifier Gain (dB)

Product	OmniAccess Stellar	Temperature	26°C
Test Engineer	Tyler Yuan	Relative Humidity	57 %
Test Site	AC1	Test Date	2019/12/16
Test Mode:	802.11ax-HE40 (Beamforming Mode)	Test Channel:	54
Remark:	1. Average measurement was not performed if peak level lower than average limit. 2. Other frequency was 20dB below limit line within 1-18GHz, there is not show in the report.		

Mark	Frequency (MHz)	Reading Level (dBμV)	Factor (dB)	Measure Level (dBμV/m)	Limit (dBμV/m)	Margin (dB)	Detector	Polarization
	7604.5	33.5	11.8	45.3	74.0	-28.7	Peak	Horizontal
	8250.5	33.0	12.3	45.3	74.0	-28.7	Peak	Horizontal
*	8667.0	32.7	13.0	45.7	68.2	-22.5	Peak	Horizontal
*	10095.0	31.9	16.2	48.1	68.2	-20.1	Peak	Horizontal
	7681.0	34.5	11.8	46.3	74.0	-27.7	Peak	Vertical
	8276.0	33.5	12.0	45.5	74.0	-28.5	Peak	Vertical
*	8709.5	33.2	13.2	46.5	68.2	-21.8	Peak	Vertical
*	9797.5	33.3	15.9	49.2	68.2	-19.1	Peak	Vertical

Note 1: "*" is not in restricted band, its limit is -27dBm/MHz. At a distance of 3 meters, the field strength limit in dBμV/m can be determined by adding a "conversion" factor of 95.2dB to the EIRP limit of -27dBm/MHz to obtain the limit for out of band spurious emissions.

Note 2: Measure Level (dBμV/m) = Reading Level (dBμV) + Factor (dB)

Factor (dB) = Cable Loss (dB) + Antenna Factor (dB/m) - Pre_Amplifier Gain (dB)

Product	OmniAccess Stellar	Temperature	26°C
Test Engineer	Tyler Yuan	Relative Humidity	57 %
Test Site	AC1	Test Date	2019/12/16
Test Mode:	802.11ax-HE40 (Beamforming Mode)	Test Channel:	62
Remark:	1. Average measurement was not performed if peak level lower than average limit. 2. Other frequency was 20dB below limit line within 1-18GHz, there is not show in the report.		

Mark	Frequency (MHz)	Reading Level (dBμV)	Factor (dB)	Measure Level (dBμV/m)	Limit (dBμV/m)	Margin (dB)	Detector	Polarization
	7570.5	32.9	11.8	44.7	74.0	-29.3	Peak	Horizontal
	8216.5	33.5	12.3	45.8	74.0	-28.2	Peak	Horizontal
*	8684.0	33.8	13.1	47.0	68.2	-21.2	Peak	Horizontal
*	10103.5	32.3	16.3	48.5	68.2	-19.7	Peak	Horizontal
	7570.5	33.6	11.8	45.4	74.0	-28.6	Peak	Vertical
	8233.5	34.0	12.3	46.3	74.0	-27.8	Peak	Vertical
*	8709.5	33.7	13.2	46.9	68.2	-21.3	Peak	Vertical
*	10350.0	32.3	16.8	49.1	68.2	-19.1	Peak	Vertical

Note 1: "*" is not in restricted band, its limit is -27dBm/MHz. At a distance of 3 meters, the field strength limit in dBμV/m can be determined by adding a "conversion" factor of 95.2dB to the EIRP limit of -27dBm/MHz to obtain the limit for out of band spurious emissions.

Note 2: Measure Level (dBμV/m) = Reading Level (dBμV) + Factor (dB)

Factor (dB) = Cable Loss (dB) + Antenna Factor (dB/m) - Pre_Amplifier Gain (dB)

Product	OmniAccess Stellar	Temperature	26°C
Test Engineer	Tyler Yuan	Relative Humidity	57 %
Test Site	AC1	Test Date	2019/12/16
Test Mode:	802.11ax-HE40 (Beamforming Mode)	Test Channel:	102
Remark:	1. Average measurement was not performed if peak level lower than average limit. 2. Other frequency was 20dB below limit line within 1-18GHz, there is not show in the report.		

Mark	Frequency (MHz)	Reading Level (dBμV)	Factor (dB)	Measure Level (dBμV/m)	Limit (dBμV/m)	Margin (dB)	Detector	Polarization
	7604.5	34.6	11.8	46.4	74.0	-27.6	Peak	Horizontal
	8250.5	33.4	12.3	45.6	74.0	-28.4	Peak	Horizontal
*	8709.5	33.2	13.2	46.4	68.2	-21.8	Peak	Horizontal
*	10163.0	33.0	16.5	49.5	68.2	-18.7	Peak	Horizontal
	7502.5	33.8	12.0	45.8	74.0	-28.2	Peak	Vertical
	8148.5	34.0	12.4	46.4	74.0	-27.6	Peak	Vertical
*	8709.5	33.8	13.2	47.0	68.2	-21.2	Peak	Vertical
*	9746.5	34.0	15.8	49.9	68.2	-18.3	Peak	Vertical

Note 1: "*" is not in restricted band, its limit is -27dBm/MHz. At a distance of 3 meters, the field strength limit in dBμV/m can be determined by adding a "conversion" factor of 95.2dB to the EIRP limit of -27dBm/MHz to obtain the limit for out of band spurious emissions.

Note 2: Measure Level (dBμV/m) = Reading Level (dBμV) + Factor (dB)

Factor (dB) = Cable Loss (dB) + Antenna Factor (dB/m) - Pre_Amplifier Gain (dB)

Product	OmniAccess Stellar	Temperature	26°C
Test Engineer	Tyler Yuan	Relative Humidity	57 %
Test Site	AC1	Test Date	2019/12/16
Test Mode:	802.11ax-HE40 (Beamforming Mode)	Test Channel:	118
Remark:	1. Average measurement was not performed if peak level lower than average limit. 2. Other frequency was 20dB below limit line within 1-18GHz, there is not show in the report.		

Mark	Frequency (MHz)	Reading Level (dBμV)	Factor (dB)	Measure Level (dBμV/m)	Limit (dBμV/m)	Margin (dB)	Detector	Polarization
	7604.5	34.5	11.8	46.3	74.0	-27.7	Peak	Horizontal
	8182.5	35.4	12.4	47.8	74.0	-26.2	Peak	Horizontal
*	8981.5	34.3	13.4	47.7	68.2	-20.5	Peak	Horizontal
*	10350.0	32.2	16.8	49.0	68.2	-19.2	Peak	Horizontal
	7545.0	34.6	11.9	46.6	74.0	-27.5	Peak	Vertical
	8208.0	33.9	12.3	46.2	74.0	-27.8	Peak	Vertical
*	8845.5	33.1	13.4	46.5	68.2	-21.8	Peak	Vertical
*	10299.0	31.9	16.6	48.5	68.2	-19.7	Peak	Vertical

Note 1: "*" is not in restricted band, its limit is -27dBm/MHz. At a distance of 3 meters, the field strength limit in dBμV/m can be determined by adding a "conversion" factor of 95.2dB to the EIRP limit of -27dBm/MHz to obtain the limit for out of band spurious emissions.

Note 2: Measure Level (dBμV/m) = Reading Level (dBμV) + Factor (dB)

Factor (dB) = Cable Loss (dB) + Antenna Factor (dB/m) - Pre_Amplifier Gain (dB)

Product	OmniAccess Stellar	Temperature	26°C
Test Engineer	Tyler Yuan	Relative Humidity	57 %
Test Site	AC1	Test Date	2019/12/16
Test Mode:	802.11ax-HE40 (Beamforming Mode)	Test Channel:	134
Remark:	1. Average measurement was not performed if peak level lower than average limit. 2. Other frequency was 20dB below limit line within 1-18GHz, there is not show in the report.		

Mark	Frequency (MHz)	Reading Level (dBμV)	Factor (dB)	Measure Level (dBμV/m)	Limit (dBμV/m)	Margin (dB)	Detector	Polarization
	7613.0	34.4	11.9	46.2	74.0	-27.8	Peak	Horizontal
	8293.0	33.1	12.1	45.2	74.0	-28.8	Peak	Horizontal
*	8794.5	32.5	13.3	45.8	68.2	-22.4	Peak	Horizontal
*	10027.0	33.0	16.0	49.1	68.2	-19.1	Peak	Horizontal
	7570.5	35.5	11.8	47.3	74.0	-26.7	Peak	Vertical
	8250.5	33.2	12.3	45.5	74.0	-28.5	Peak	Vertical
*	8718.0	32.7	13.2	45.9	68.2	-22.3	Peak	Vertical
*	10256.5	34.9	16.5	51.4	68.2	-16.8	Peak	Vertical

Note 1: "*" is not in restricted band, its limit is -27dBm/MHz. At a distance of 3 meters, the field strength limit in dBμV/m can be determined by adding a "conversion" factor of 95.2dB to the EIRP limit of -27dBm/MHz to obtain the limit for out of band spurious emissions.

Note 2: Measure Level (dBμV/m) = Reading Level (dBμV) + Factor (dB)

Factor (dB) = Cable Loss (dB) + Antenna Factor (dB/m) - Pre_Amplifier Gain (dB)

Product	OmniAccess Stellar	Temperature	26°C
Test Engineer	Tyler Yuan	Relative Humidity	57 %
Test Site	AC1	Test Date	2019/12/16
Test Mode:	802.11ax-HE40 (Beamforming Mode)	Test Channel:	142
Remark:	1. Average measurement was not performed if peak level lower than average limit. 2. Other frequency was 20dB below limit line within 1-18GHz, there is not show in the report.		

Mark	Frequency (MHz)	Reading Level (dBμV)	Factor (dB)	Measure Level (dBμV/m)	Limit (dBμV/m)	Margin (dB)	Detector	Polarization
	7570.5	34.4	11.8	46.2	74.0	-27.8	Peak	Horizontal
	8335.5	33.6	12.1	45.7	74.0	-28.3	Peak	Horizontal
*	8820.0	33.2	13.4	46.6	68.2	-21.6	Peak	Horizontal
*	9933.5	32.9	16.1	48.9	68.2	-19.3	Peak	Horizontal
	7434.5	33.4	11.9	45.3	74.0	-28.7	Peak	Vertical
	8250.5	33.6	12.3	45.8	74.0	-28.2	Peak	Vertical
*	8752.0	33.6	13.3	47.0	68.2	-21.2	Peak	Vertical
*	10112.0	33.8	16.3	50.1	68.2	-18.1	Peak	Vertical

Note 1: "*" is not in restricted band, its limit is -27dBm/MHz. At a distance of 3 meters, the field strength limit in dBμV/m can be determined by adding a "conversion" factor of 95.2dB to the EIRP limit of -27dBm/MHz to obtain the limit for out of band spurious emissions.

Note 2: Measure Level (dBμV/m) = Reading Level (dBμV) + Factor (dB)

Factor (dB) = Cable Loss (dB) + Antenna Factor (dB/m) - Pre_Amplifier Gain (dB)

Product	OmniAccess Stellar	Temperature	26°C
Test Engineer	Tyler Yuan	Relative Humidity	57 %
Test Site	AC1	Test Date	2019/12/16
Test Mode:	802.11ax-HE80 (Beamforming Mode)	Test Channel:	58
Remark:	1. Average measurement was not performed if peak level lower than average limit. 2. Other frequency was 20dB below limit line within 1-18GHz, there is not show in the report.		

Mark	Frequency (MHz)	Reading Level (dBμV)	Factor (dB)	Measure Level (dBμV/m)	Limit (dBμV/m)	Margin (dB)	Detector	Polarization
	7570.5	33.5	11.8	45.3	74.0	-28.7	Peak	Horizontal
	8259.0	33.1	12.2	45.4	74.0	-28.6	Peak	Horizontal
*	8692.5	33.1	13.2	46.3	68.2	-21.9	Peak	Horizontal
*	9891.0	31.9	16.2	48.1	68.2	-20.1	Peak	Horizontal
	7417.5	33.2	11.8	45.0	74.0	-29.0	Peak	Vertical
	8369.5	35.5	12.3	47.8	74.0	-26.2	Peak	Vertical
*	8684.0	34.6	13.1	47.7	68.2	-20.5	Peak	Vertical
*	9950.5	34.9	16.1	51.0	68.2	-17.2	Peak	Vertical

Note 1: "*" is not in restricted band, its limit is -27dBm/MHz. At a distance of 3 meters, the field strength limit in dBμV/m can be determined by adding a "conversion" factor of 95.2dB to the EIRP limit of -27dBm/MHz to obtain the limit for out of band spurious emissions.

Note 2: Measure Level (dBμV/m) = Reading Level (dBμV) + Factor (dB)

Factor (dB) = Cable Loss (dB) + Antenna Factor (dB/m) - Pre_Amplifier Gain (dB)

Product	OmniAccess Stellar	Temperature	26°C
Test Engineer	Tyler Yuan	Relative Humidity	57 %
Test Site	AC1	Test Date	2019/12/16
Test Mode:	802.11ax-HE80 (Beamforming Mode)	Test Channel:	106
Remark:	1. Average measurement was not performed if peak level lower than average limit. 2. Other frequency was 20dB below limit line within 1-18GHz, there is not show in the report.		

Mark	Frequency (MHz)	Reading Level (dBμV)	Factor (dB)	Measure Level (dBμV/m)	Limit (dBμV/m)	Margin (dB)	Detector	Polarization
	7417.5	34.6	11.8	46.5	74.0	-27.6	Peak	Horizontal
	8182.5	35.0	12.4	47.4	74.0	-26.6	Peak	Horizontal
*	8743.5	33.3	13.3	46.5	68.2	-21.7	Peak	Horizontal
*	9891.0	33.2	16.2	49.4	68.2	-18.9	Peak	Horizontal
	7409.0	33.3	11.7	45.1	74.0	-29.0	Peak	Vertical
	8140.0	34.5	12.5	47.0	74.0	-27.0	Peak	Vertical
*	8709.5	34.0	13.2	47.2	68.2	-21.0	Peak	Vertical
*	10035.5	32.2	16.1	48.3	68.2	-19.9	Peak	Vertical

Note 1: "*" is not in restricted band, its limit is -27dBm/MHz. At a distance of 3 meters, the field strength limit in dBμV/m can be determined by adding a "conversion" factor of 95.2dB to the EIRP limit of -27dBm/MHz to obtain the limit for out of band spurious emissions.

Note 2: Measure Level (dBμV/m) = Reading Level (dBμV) + Factor (dB)

Factor (dB) = Cable Loss (dB) + Antenna Factor (dB/m) - Pre_Amplifier Gain (dB)

Product	OmniAccess Stellar	Temperature	26°C
Test Engineer	Tyler Yuan	Relative Humidity	57 %
Test Site	AC1	Test Date	2019/12/16
Test Mode:	802.11ax-HE80 (Beamforming Mode)	Test Channel:	122
Remark:	1. Average measurement was not performed if peak level lower than average limit. 2. Other frequency was 20dB below limit line within 1-18GHz, there is not show in the report.		

Mark	Frequency (MHz)	Reading Level (dBμV)	Factor (dB)	Measure Level (dBμV/m)	Limit (dBμV/m)	Margin (dB)	Detector	Polarization
	7596.0	33.4	11.8	45.1	74.0	-28.9	Peak	Horizontal
	8276.0	33.4	12.0	45.5	74.0	-28.6	Peak	Horizontal
*	8811.5	33.2	13.4	46.5	68.2	-21.7	Peak	Horizontal
*	10188.5	32.5	16.3	48.7	68.2	-19.5	Peak	Horizontal
	7596.0	34.1	11.8	45.8	74.0	-28.2	Peak	Vertical
	8242.0	33.3	12.3	45.6	74.0	-28.4	Peak	Vertical
*	8709.5	34.0	13.2	47.2	68.2	-21.0	Peak	Vertical
*	9755.0	32.3	15.9	48.2	68.2	-20.0	Peak	Vertical

Note 1: "*" is not in restricted band, its limit is -27dBm/MHz. At a distance of 3 meters, the field strength limit in dBμV/m can be determined by adding a "conversion" factor of 95.2dB to the EIRP limit of -27dBm/MHz to obtain the limit for out of band spurious emissions.

Note 2: Measure Level (dBμV/m) = Reading Level (dBμV) + Factor (dB)

Factor (dB) = Cable Loss (dB) + Antenna Factor (dB/m) - Pre_Amplifier Gain (dB)

Product	OmniAccess Stellar	Temperature	26°C
Test Engineer	Tyler Yuan	Relative Humidity	57 %
Test Site	AC1	Test Date	2019/12/16
Test Mode:	802.11ax-HE80 (Beamforming Mode)	Test Channel:	138
Remark:	1. Average measurement was not performed if peak level lower than average limit. 2. Other frequency was 20dB below limit line within 1-18GHz, there is not show in the report.		

Mark	Frequency (MHz)	Reading Level (dBμV)	Factor (dB)	Measure Level (dBμV/m)	Limit (dBμV/m)	Margin (dB)	Detector	Polarization
	7375.0	35.1	11.7	46.8	74.0	-27.2	Peak	Horizontal
	8191.0	33.7	12.5	46.2	74.0	-27.8	Peak	Horizontal
*	8854.0	33.9	13.4	47.3	68.2	-20.9	Peak	Horizontal
*	10205.5	33.8	16.3	50.1	68.2	-18.1	Peak	Horizontal
	7596.0	33.0	11.8	44.8	74.0	-29.2	Peak	Vertical
	8250.5	33.8	12.3	46.0	74.0	-28.0	Peak	Vertical
*	8752.0	33.5	13.3	46.8	68.2	-21.4	Peak	Vertical
*	10197.0	32.1	16.2	48.3	68.2	-19.9	Peak	Vertical

Note 1: "*" is not in restricted band, its limit is -27dBm/MHz. At a distance of 3 meters, the field strength limit in dBμV/m can be determined by adding a "conversion" factor of 95.2dB to the EIRP limit of -27dBm/MHz to obtain the limit for out of band spurious emissions.

Note 2: Measure Level (dBμV/m) = Reading Level (dBμV) + Factor (dB)

Factor (dB) = Cable Loss (dB) + Antenna Factor (dB/m) - Pre_Amplifier Gain (dB)

Product	OmniAccess Stellar	Temperature	26°C
Test Engineer	Tyler Yuan	Relative Humidity	57 %
Test Site	AC1	Test Date	2019/12/16
Test Mode:	802.11ax-HE80 + 80 (Beamforming Mode)	Test Channel:	42 + 58
Remark:	1. Average measurement was not performed if peak level lower than average limit. 2. Other frequency was 20dB below limit line within 1-18GHz, there is not show in the report.		

Mark	Frequency (MHz)	Reading Level (dBμV)	Factor (dB)	Measure Level (dBμV/m)	Limit (dBμV/m)	Margin (dB)	Detector	Polarization
	7511.0	33.8	11.9	45.7	74.0	-28.3	Peak	Horizontal
	8259.0	33.5	12.2	45.7	74.0	-28.3	Peak	Horizontal
*	8811.5	33.1	13.4	46.4	68.2	-21.8	Peak	Horizontal
*	10205.5	32.7	16.3	49.0	68.2	-19.2	Peak	Horizontal
	7375.0	33.3	11.7	45.0	74.0	-29.0	Peak	Vertical
	8327.0	35.9	12.2	48.2	74.0	-25.9	Peak	Vertical
*	8692.5	34.4	13.2	47.6	68.2	-20.6	Peak	Vertical
*	10401.0	31.6	16.8	48.4	68.2	-19.8	Peak	Vertical

Note 1: "*" is not in restricted band, its limit is -27dBm/MHz. At a distance of 3 meters, the field strength limit in dBμV/m can be determined by adding a "conversion" factor of 95.2dB to the EIRP limit of -27dBm/MHz to obtain the limit for out of band spurious emissions.

Note 2: Measure Level (dBμV/m) = Reading Level (dBμV) + Factor (dB)

Factor (dB) = Cable Loss (dB) + Antenna Factor (dB/m) - Pre_Amplifier Gain (dB)

Product	OmniAccess Stellar	Temperature	26°C
Test Engineer	Tyler Yuan	Relative Humidity	57 %
Test Site	AC1	Test Date	2019/12/16
Test Mode:	802.11ax-HE80 + 80 (Beamforming Mode)	Test Channel:	106 + 122
Remark:	1. Average measurement was not performed if peak level lower than average limit. 2. Other frequency was 20dB below limit line within 1-18GHz, there is not show in the report.		

Mark	Frequency (MHz)	Reading Level (dBμV)	Factor (dB)	Measure Level (dBμV/m)	Limit (dBμV/m)	Margin (dB)	Detector	Polarization
	7502.5	35.3	12.0	47.3	74.0	-26.7	Peak	Horizontal
	8352.5	36.0	12.1	48.1	74.0	-25.9	Peak	Horizontal
*	8913.5	34.5	13.4	47.9	68.2	-20.3	Peak	Horizontal
*	10027.0	33.4	16.0	49.4	68.2	-18.8	Peak	Horizontal
	7502.5	33.8	12.0	45.8	74.0	-28.2	Peak	Vertical
	8335.5	34.7	12.1	46.8	74.0	-27.2	Peak	Vertical
*	8709.5	34.7	13.2	47.9	68.2	-20.3	Peak	Vertical
*	9814.5	32.9	16.0	48.9	68.2	-19.3	Peak	Vertical

Note 1: "*" is not in restricted band, its limit is -27dBm/MHz. At a distance of 3 meters, the field strength limit in dBμV/m can be determined by adding a "conversion" factor of 95.2dB to the EIRP limit of -27dBm/MHz to obtain the limit for out of band spurious emissions.

Note 2: Measure Level (dBμV/m) = Reading Level (dBμV) + Factor (dB)

Factor (dB) = Cable Loss (dB) + Antenna Factor (dB/m) - Pre_Amplifier Gain (dB)

The worst case of Radiated Emission below 1GHz:

Site: AC1	Time: 2019/10/27 - 18:34
Limit: FCC_Part15.209_RSE(3m)	Engineer: David Lv
Probe: VULB9168_0.03-8GHz	Polarity: Horizontal
EUT: OmniAccess Stellar	Power: AC 120V/60Hz

Worst Case: Transmit by 802.11a at Channel 5320MHz

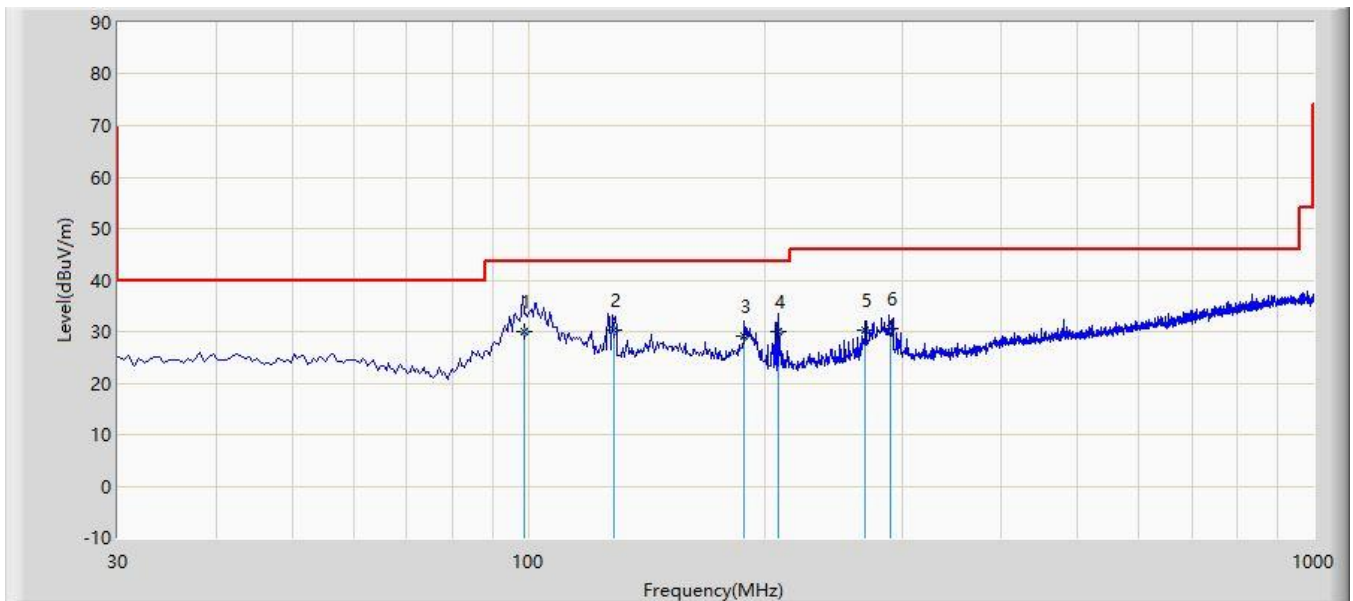

No	Flag	Mark	Frequency (MHz)	Measure Level (dBuV/m)	Reading Level (dBuV)	Margin (dB)	Limit (dBuV/m)	Factor (dB)	Type
1			98.620	29.861	19.220	-13.639	43.500	10.641	QP
2		*	128.626	30.419	17.030	-13.081	43.500	13.390	QP
3			188.620	29.076	17.620	-14.424	43.500	11.456	QP
4			207.921	29.881	18.990	-13.619	43.500	10.891	QP
5			268.626	30.253	17.230	-15.747	46.000	13.023	QP
6			288.626	30.463	16.900	-15.537	46.000	13.563	QP

Note 1: Measure Level (dBuV/m) = Reading Level (dBuV) + Factor (dB)

Factor (dB) = Cable Loss (dB) + Antenna Factor (dB/m)

Note 2: The test trace is same as the ambient noise and the amplitude of the emissions are attenuated more than 20dB below the permissible (the test frequency range: 9kHz ~ 30MHz, 18GHz ~ 25GHz), therefore no data appear in the report.

Site: AC2	Time: 2019/10/27 - 18:55
Limit: FCC_Part15.209_RSE(3m)	Engineer: David Lv
Probe: VULB9168_0.03-8GHz	Polarity: Vertical
EUT: OmniAccess Stellar	Power: AC 120V/60Hz
Worst Case: Transmit by 802.11a at Channel 5320MHz	

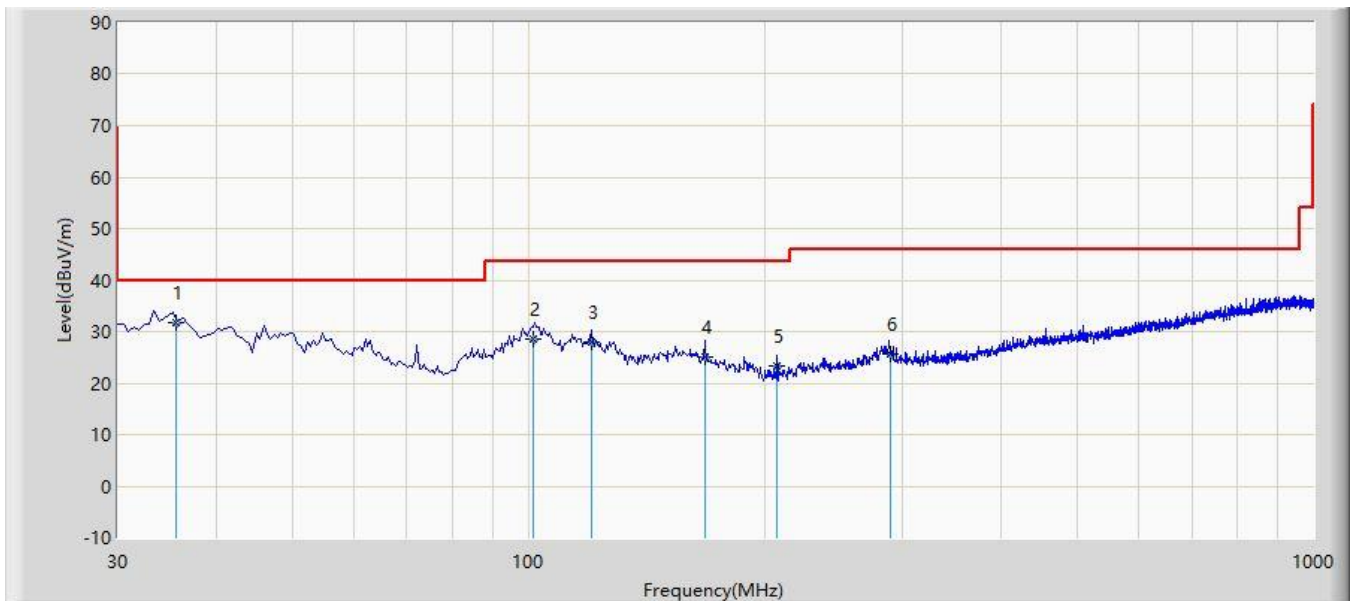

No	Flag	Mark	Frequency (MHz)	Measure Level (dBuV/m)	Reading Level (dBuV)	Margin (dB)	Limit (dBuV/m)	Factor (dB)	Type
1		*	35.621	31.795	17.950	-8.205	40.000	13.845	QP
2			101.635	28.471	17.560	-15.029	43.500	10.912	QP
3			120.360	27.978	15.080	-15.522	43.500	12.897	QP
4			167.650	25.155	10.980	-18.345	43.500	14.175	QP
5			207.150	23.406	12.530	-20.094	43.500	10.877	QP
6			288.626	25.593	12.030	-20.407	46.000	13.563	QP

Note 1: Measure Level (dBuV/m) = Reading Level (dBuV) + Factor (dB)

Factor (dB) = Cable Loss (dB) + Antenna Factor (dB/m)

Note 2: The test trace is same as the ambient noise and the amplitude of the emissions are attenuated more than 20dB below the permissible (the test frequency range: 9kHz ~ 30MHz, 18GHz ~ 25GHz), therefore no data appear in the report.

7.9. Radiated Restricted Band Edge Measurement

7.9.1. Test Limit

For 15.205 requirement:

Radiated emissions which fall in the restricted bands, as defined in Section 15.205(a) of FCC part 15, must also comply with the radiated emission limits specified in Section 15.209(a).

Frequency (MHz)	Frequency (MHz)	Frequency (MHz)	Frequency (GHz)
0.090 - 0.110	16.42-16.423	399.9 - 410	4.5-5.15
¹ 0.495 - 0.505	16.69475-16.69525	608 - 614	5.35-5.46
2.1735-2.1905	16.80425-16.80475	960 - 1240	7.25-7.75
4.125-4.128	25.5 -25.67	1300 - 1427	8.025 - 8.5
4.17725-4.17775	37.5-38.25	1435-1626.5	9.0-9.2
4.20725-4.20775	73-74.6	1645.5-1646.5	9.3-9.5
6.215-6.218	74.8-75.2	1660 - 1710	10.6-12.7
6.26775-6.26825	108-121.94	1718.8-1722.2	13.25-13.4
6.31175-6.31225	123 - 138	2200 - 2300	14.47-14.5
8.291-8.294	149.9-150.05	2310–2390	15.35-16.2
8.362-8.366	156.52475-156.525	2483.5 - 2500	17.7-21.4
8.37625-8.38675	156.7-156.9	2690 - 2900	22.01-23.12
8.41425-8.41475	162.0125-167.17	3260 - 3267	23.6-24.0
12.29-12.293	167.72-173.2	3332 - 3339	31.2-31.8
12.51975-12.52025	240 - 285	3345.8 - 3358	36.43-36.5
12.57675-12.57725	322-335.4	3600 - 4400	(²)
13.36-13.41	--	--	--

For 15.407(b) requirement:

For transmitters operating in the 5.25-5.35 GHz band: All emissions outside of the 5.15-5.35 GHz band shall not exceed an e.i.r.p. of -27 dBm/MHz.

For transmitters operating in the 5.47-5.725 GHz band: All emissions outside of the 5.47-5.725 GHz band shall not exceed an e.i.r.p. of -27 dBm/MHz.

Refer to KDB 789033 D02v01r04 G)2)c), as specified in § 15.407(b), emissions above 1000 MHz that are outside of the restricted bands are subject to a maximum emission limit of -27dBm/MHz as specified in § 15.407(b)(4)). However, an out-of-band emission that complies with both the peak and average limits of § 15.209 is not required to satisfy the -27dBm/MHz.

All out of band emissions appearing in a restricted band as specified in Section 15.205 of the Title

47CFR must not exceed the limits shown in Table per Section 15.209.

FCC Part 15 Subpart C Paragraph 15.209		
Frequency (MHz]	Field Strength (uV/m]	Measured Distance (Meters)
0.009 - 0.490	2400/F (kHz)	300
0.490 - 1.705	24000/F (kHz)	30
1.705 - 30	30	30
30 - 88	100	3
88 - 216	150	3
216 - 960	200	3
Above 960	500	3

7.9.2. Test Procedure Used

KDB 789033 D02v02r01 – Section G

7.9.3. Test Setting

Peak Measurements above 1GHz

1. Analyzer center frequency was set to the frequency of the radiated spurious emission of interest
2. RBW = 1MHz
3. VBW = 3MHz
4. Detector = peak
5. Sweep time = auto couple
6. Trace mode = max hold
7. Trace was allowed to stabilize

Average Measurements above 1GHz (Method AD)

1. Analyzer center frequency was set to the frequency of the radiated spurious emission of interest
2. RBW = 1MHz
3. If duty cycle $\geq 98\%$, $VBW \leq RBW/100$ but not less than 10Hz; If duty cycle $< 98\%$, set $VBW \geq 1/T$.
4. Detector = Peak
5. Sweep time = auto
6. Trace mode = max hold
7. Allow max hold to run for at least 50 traces if the transmitted signal is continuous or has at least 98% duty cycle. For lower duty cycles, increase the minimum number of traces by a factor of $1/x$, where x is the duty cycle.

7.9.4. Test Setup

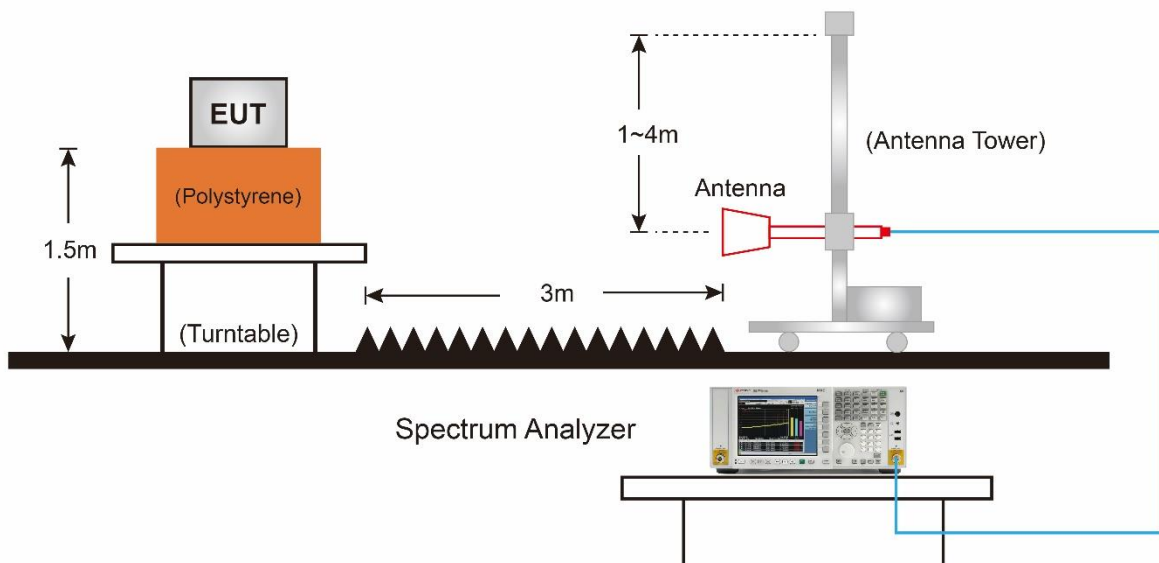

7.9.5.Test Result

For OAW-AP1321

Site: AC1	Time: 2020/02/21 - 15:23
Limit: FCC_Part15.209_RSE(3m)	Engineer: Jason Gao
Probe: BBHA9120D_1-18GHz	Polarity: Horizontal
EUT: OmniAccess Stellar	Power: AC 120V/60Hz
Note: Transmit by 802.11a at channel 5320MHz	

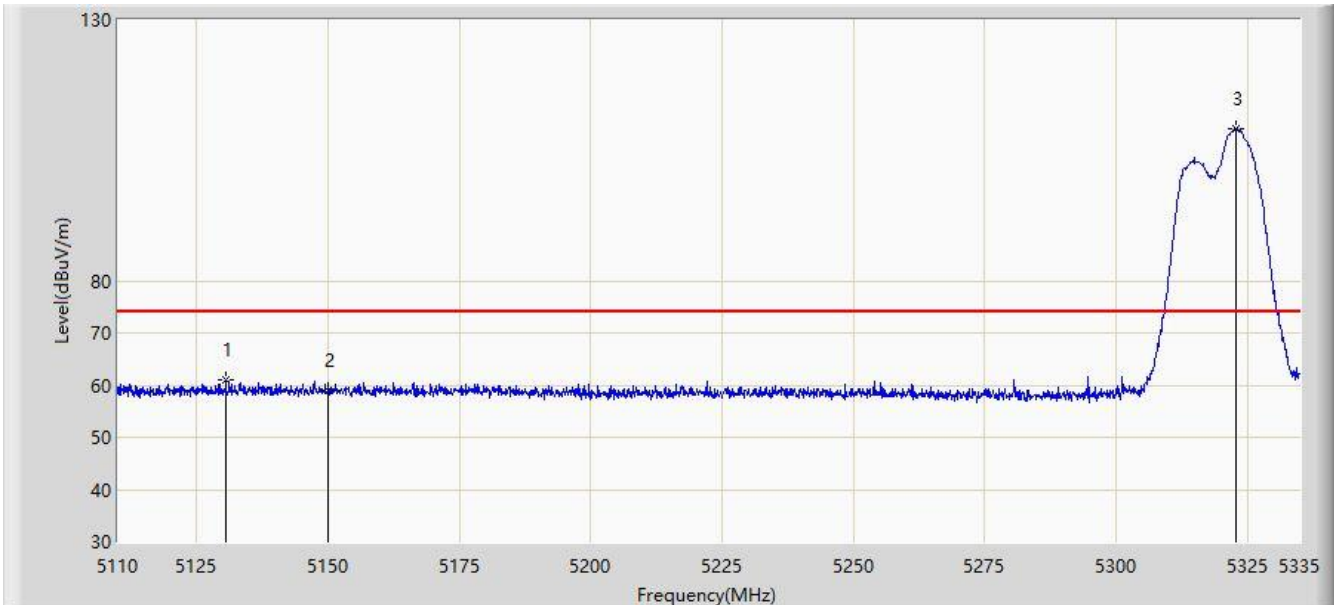

No	Flag	Mark	Frequency (MHz)	Measure Level (dBuV/m)	Reading Level (dBuV)	Margin (dB)	Limit (dBuV/m)	Factor (dB)	Type
1			5130.587	61.043	52.432	-12.957	74.000	8.611	PK
2			5150.000	59.078	50.550	-14.922	74.000	8.528	PK
3		*	5322.962	109.082	100.639	35.082	74.000	8.444	PK

Note: Measure Level (dB μ V/m) = Reading Level (dB μ V) + Factor (dB)

Factor (dB) = Cable Loss (dB) + Antenna Factor (dB/m) - Pre_Amplifier Gain (dB)

Site: AC1	Time: 2020/02/21 - 15:36
Limit: FCC_Part15.209_RSE(3m)	Engineer: Jason Gao
Probe: BBHA9120D_1-18GHz	Polarity: Horizontal
EUT: OmniAccess Stellar	Power: AC 120V/60Hz
Note: Transmit by 802.11a at channel 5320MHz	

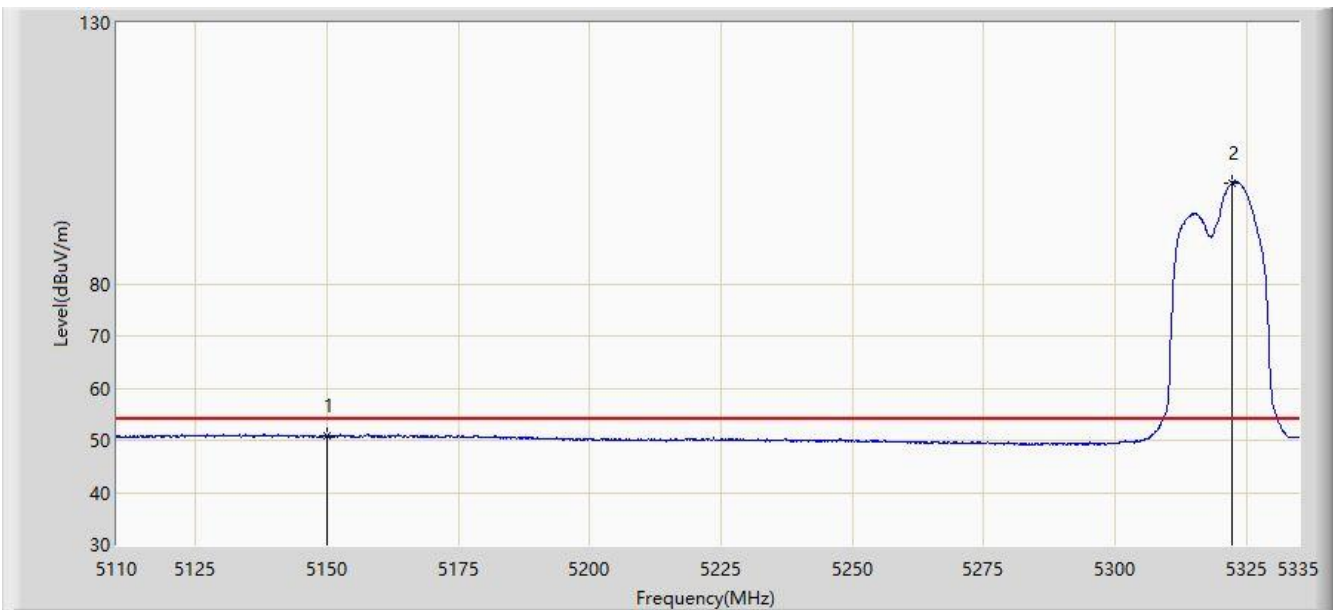

No	Flag	Mark	Frequency (MHz)	Measure Level (dBuV/m)	Reading Level (dBuV)	Margin (dB)	Limit (dBuV/m)	Factor (dB)	Type
1			5150.000	50.799	42.271	-3.201	54.000	8.528	AV
2		*	5322.288	99.411	90.970	45.411	54.000	8.441	AV

Note: Measure Level (dB μ V/m) = Reading Level (dB μ V) + Factor (dB)

Factor (dB) = Cable Loss (dB) + Antenna Factor (dB/m) - Pre_Amplifier Gain (dB)

Site: AC1	Time: 2020/02/21 - 15:39
Limit: FCC_Part15.209_RSE(3m)	Engineer: Jason Gao
Probe: BBHA9120D_1-18GHz	Polarity: Vertical
EUT: OmniAccess Stellar	Power: AC 120V/60Hz
Note: Transmit by 802.11a at channel 5320MHz	

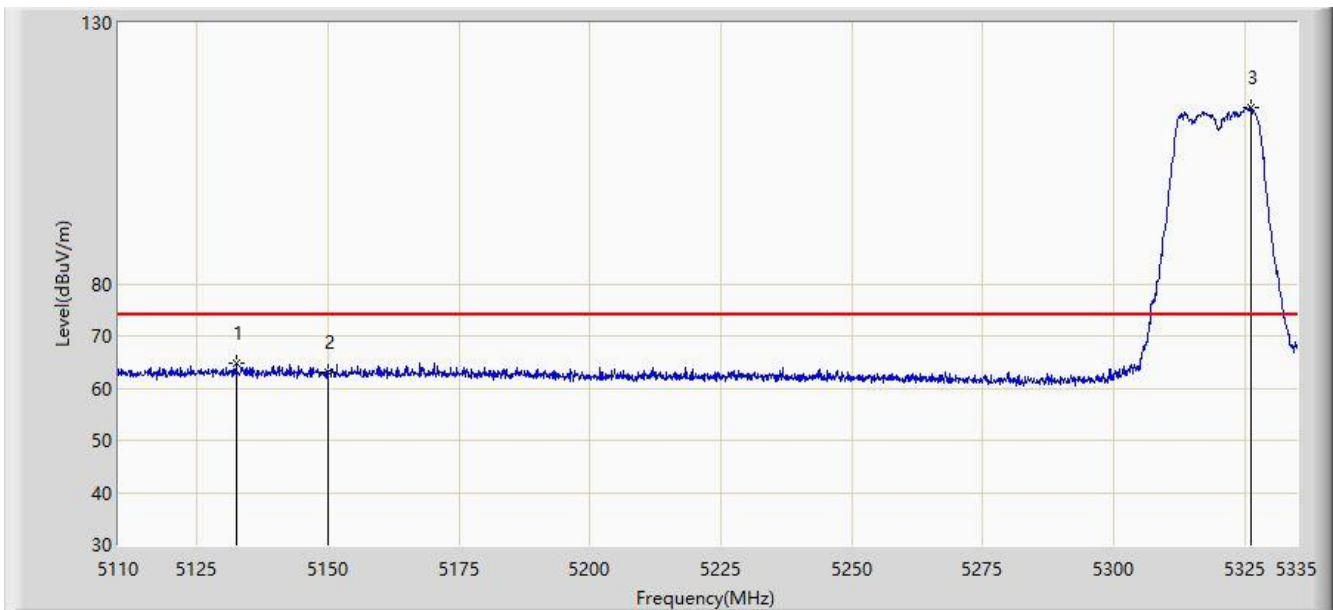

No	Flag	Mark	Frequency (MHz)	Measure Level (dBuV/m)	Reading Level (dBuV)	Margin (dB)	Limit (dBuV/m)	Factor (dB)	Type
1			5132.500	64.790	56.182	-9.210	74.000	8.608	PK
2			5150.000	62.936	54.408	-11.064	74.000	8.528	PK
3		*	5326.337	113.868	105.416	39.868	74.000	8.452	PK

Note: Measure Level (dB μ V/m) = Reading Level (dB μ V) + Factor (dB)

Factor (dB) = Cable Loss (dB) + Antenna Factor (dB/m) - Pre_Amplifier Gain (dB)

Site: AC1	Time: 2020/02/21 - 15:41
Limit: FCC_Part15.209_RSE(3m)	Engineer: Jason Gao
Probe: BBHA9120D_1-18GHz	Polarity: Vertical
EUT: OmniAccess Stellar	Power: AC 120V/60Hz
Note: Transmit by 802.11a at channel 5320MHz	

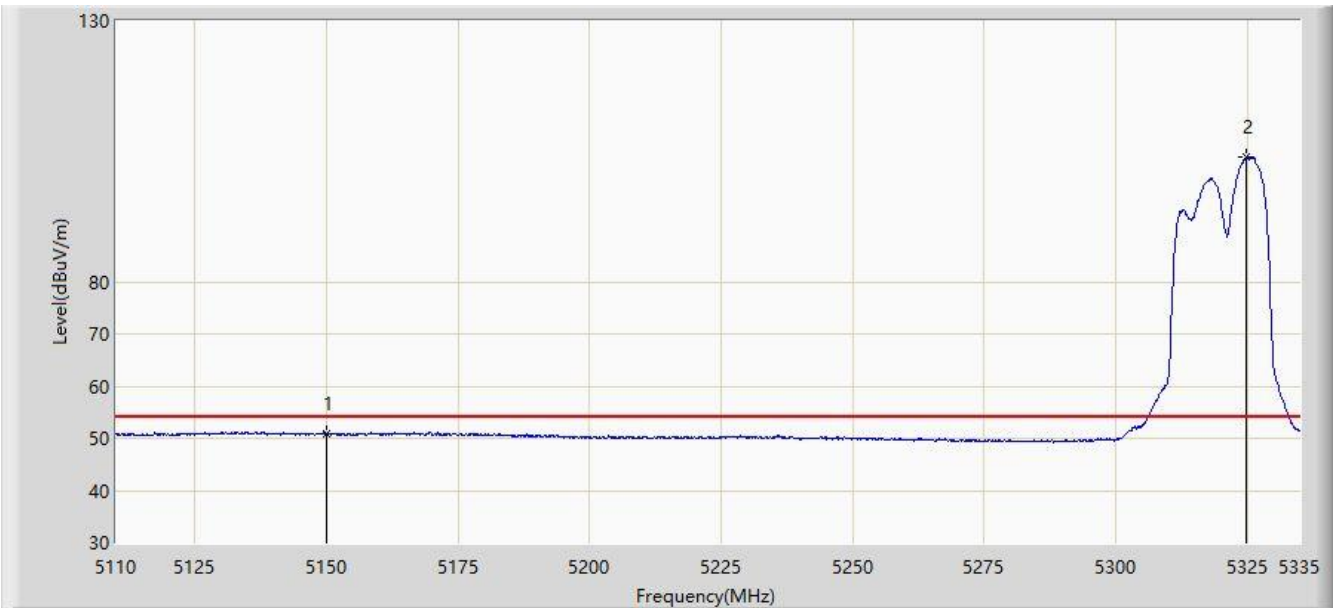

No	Flag	Mark	Frequency (MHz)	Measure Level (dBuV/m)	Reading Level (dBuV)	Margin (dB)	Limit (dBuV/m)	Factor (dB)	Type
1			5150.000	50.856	42.328	-3.144	54.000	8.528	AV
2		*	5324.875	103.809	95.361	49.809	54.000	8.449	AV

Note: Measure Level (dB μ V/m) = Reading Level (dB μ V) + Factor (dB)

Factor (dB) = Cable Loss (dB) + Antenna Factor (dB/m) - Pre_Amplifier Gain (dB)

Site: AC1	Time: 2019/11/04 - 17:04
Limit: FCC_Part15.209_RSE(3m)	Engineer: Tyler Yuan
Probe: BBHA9120D_1-18GHz	Polarity: Horizontal
EUT: OmniAccess Stellar	Power: AC 120V/60Hz
Note: Transmit by 802.11a at channel 5320MHz	

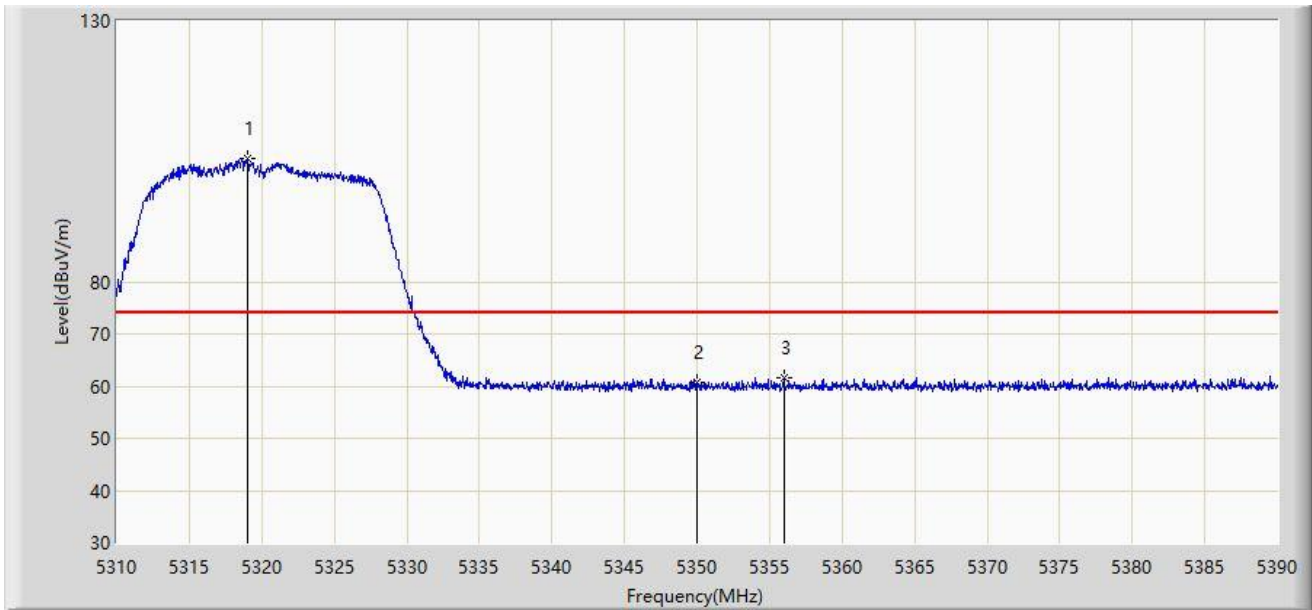

No	Flag	Mark	Frequency (MHz)	Measure Level (dBuV/m)	Reading Level (dBuV)	Margin (dB)	Limit (dBuV/m)	Factor (dB)	Type
1		*	5319.000	103.541	113.141	N/A	N/A	-9.600	PK
2			5350.000	60.680	70.150	-13.320	74.000	-9.469	PK
3			5356.000	61.613	71.089	-12.387	74.000	-9.476	PK

Note: Measure Level (dB μ V/m) = Reading Level (dB μ V) + Factor (dB)

Factor (dB) = Cable Loss (dB) + Antenna Factor (dB/m) - Pre_Amplifier Gain (dB)

Site: AC1	Time: 2019/11/04 - 17:50
Limit: FCC_Part15.209_RSE(3m)	Engineer: Tyler Yuan
Probe: BBHA9120D_1-18GHz	Polarity: Horizontal
EUT: OmniAccess Stellar	Power: AC 120V/60Hz
Note: Transmit by 802.11a at channel 5320MHz	

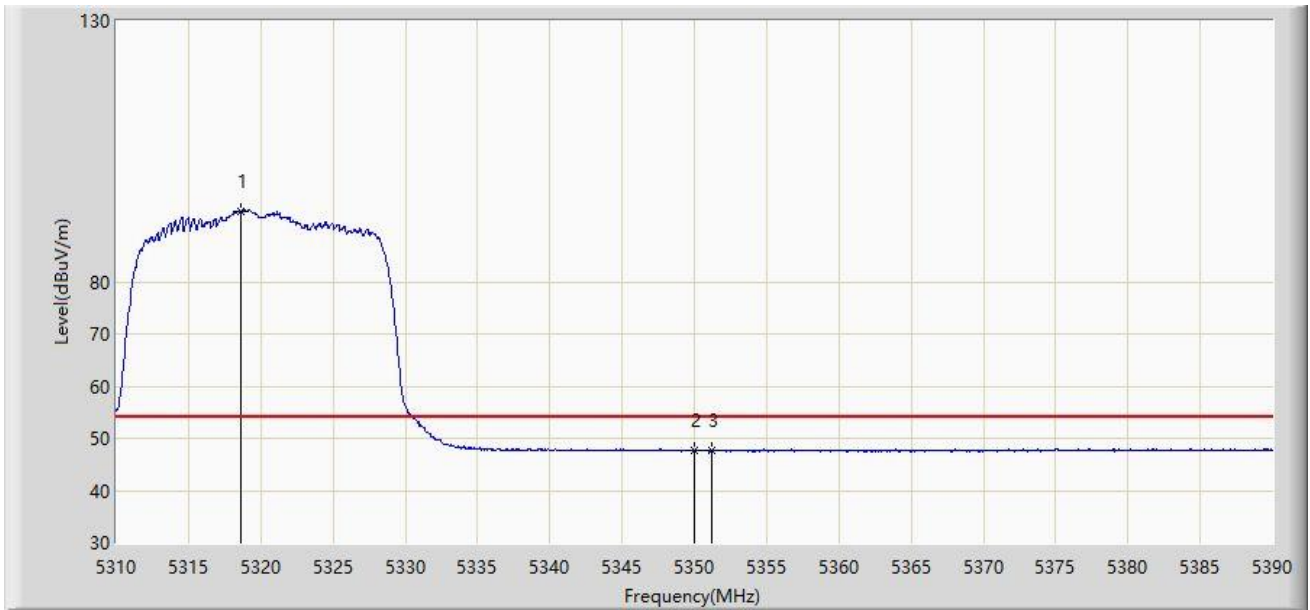

No	Flag	Mark	Frequency (MHz)	Measure Level (dBuV/m)	Reading Level (dBuV)	Margin (dB)	Limit (dBuV/m)	Factor (dB)	Type
1		*	5318.640	93.581	103.186	N/A	N/A	-9.604	AV
2			5350.000	47.643	57.113	-6.357	54.000	-9.469	AV
3			5351.160	47.761	57.235	-6.239	54.000	-9.474	AV

Note: Measure Level (dB μ V/m) = Reading Level (dB μ V) + Factor (dB)

Factor (dB) = Cable Loss (dB) + Antenna Factor (dB/m) - Pre_Amplifier Gain (dB)

Site: AC1	Time: 2019/11/04 - 17:52
Limit: FCC_Part15.209_RSE(3m)	Engineer: Tyler Yuan
Probe: BBHA9120D_1-18GHz	Polarity: Vertical
EUT: OmniAccess Stellar	Power: AC 120V/60Hz
Note: Transmit by 802.11a at channel 5320MHz	

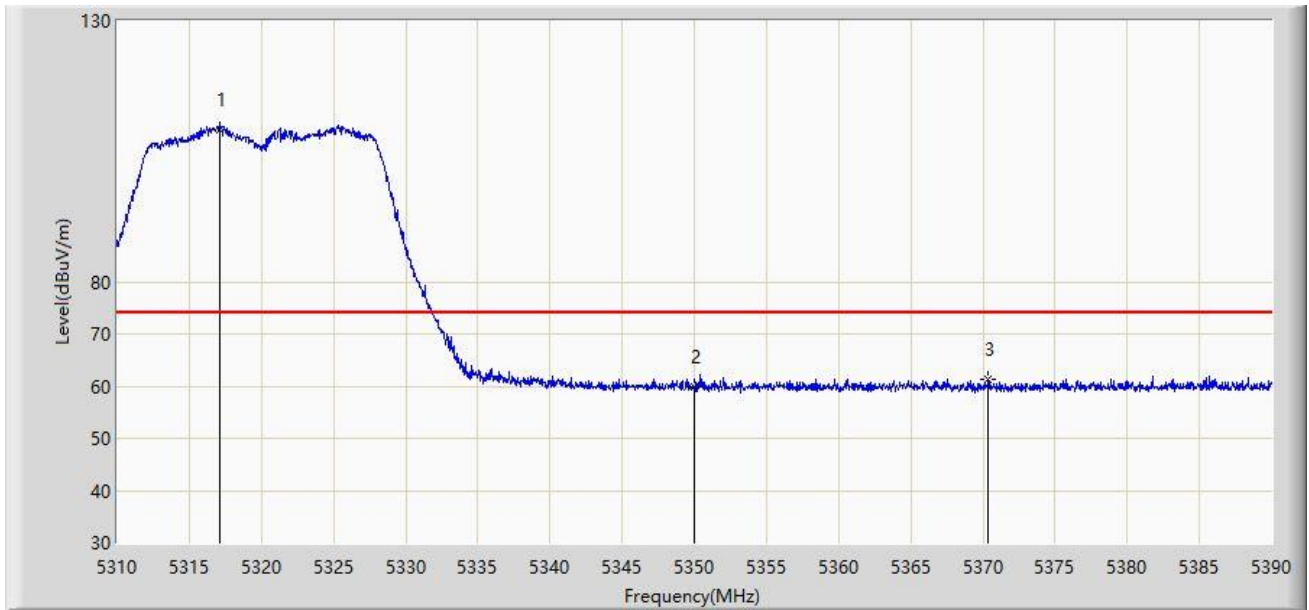

No	Flag	Mark	Frequency (MHz)	Measure Level (dBuV/m)	Reading Level (dBuV)	Margin (dB)	Limit (dBuV/m)	Factor (dB)	Type
1		*	5317.167	109.216	118.840	N/A	N/A	-9.624	PK
2			5350.000	59.784	69.254	-14.216	74.000	-9.469	PK
3			5370.360	61.443	70.906	-12.557	74.000	-9.463	PK

Note: Measure Level (dB μ V/m) = Reading Level (dB μ V) + Factor (dB)

Factor (dB) = Cable Loss (dB) + Antenna Factor (dB/m) - Pre_Amplifier Gain (dB)

Site: AC1	Time: 2019/11/04 - 17:54
Limit: FCC_Part15.209_RSE(3m)	Engineer: Tyler Yuan
Probe: BBHA9120D_1-18GHz	Polarity: Vertical
EUT: OmniAccess Stellar	Power: AC 120V/60Hz
Note: Transmit by 802.11a at channel 5320MHz	

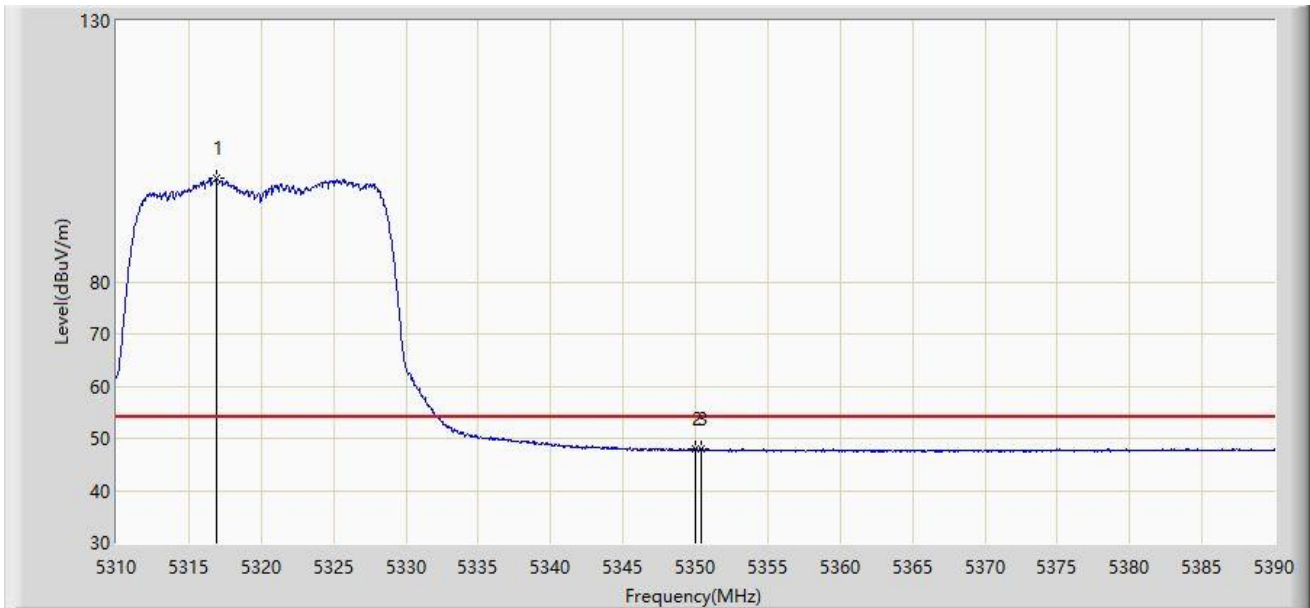

No	Flag	Mark	Frequency (MHz)	Measure Level (dBuV/m)	Reading Level (dBuV)	Margin (dB)	Limit (dBuV/m)	Factor (dB)	Type
1		*	5316.880	99.777	109.405	N/A	N/A	-9.628	AV
2			5350.000	47.869	57.339	-6.131	54.000	-9.469	AV
3			5350.400	47.882	57.353	-6.118	54.000	-9.470	AV

Note: Measure Level (dB μ V/m) = Reading Level (dB μ V) + Factor (dB)

Factor (dB) = Cable Loss (dB) + Antenna Factor (dB/m) - Pre_Amplifier Gain (dB)

Site: AC1	Time: 2019/11/04 - 17:57
Limit: FCC_Part15.209_RSE(3m)	Engineer: Tyler Yuan
Probe: BBHA9120D_1-18GHz	Polarity: Horizontal
EUT: OmniAccess Stellar	Power: AC 120V/60Hz
Note: Transmit by 802.11a at channel 5500MHz	

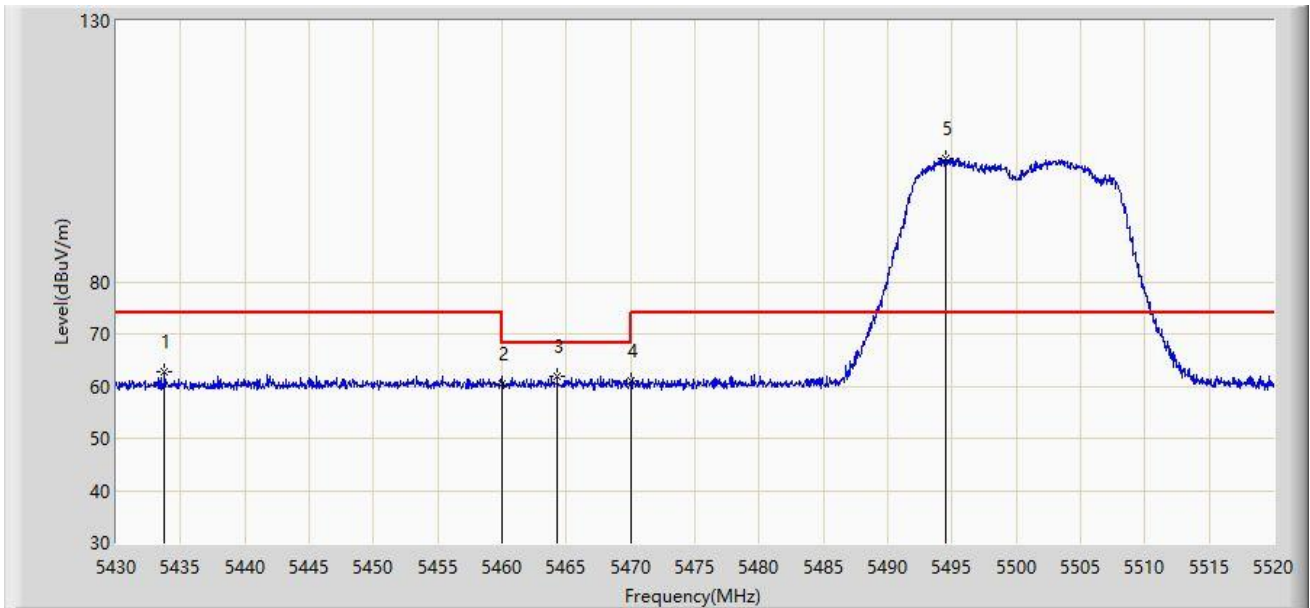

No	Flag	Mark	Frequency (MHz)	Measure Level (dBuV/m)	Reading Level (dBuV)	Margin (dB)	Limit (dBuV/m)	Factor (dB)	Type
1			5433.735	62.619	71.806	-11.381	74.000	-9.187	PK
2			5460.000	60.523	69.503	-13.477	74.000	-8.980	PK
3			5464.290	61.992	71.016	-6.208	68.200	-9.023	PK
4			5470.000	60.956	70.038	-7.244	68.200	-9.082	PK
5		*	5494.530	103.768	112.746	N/A	N/A	-8.978	PK

Note: Measure Level (dBuV/m) = Reading Level (dBuV) + Factor (dB)

Factor (dB) = Cable Loss (dB) + Antenna Factor (dB/m) - Pre_Amplifier Gain (dB)

Site: AC1	Time: 2019/11/04 - 18:15
Limit: FCC_Part15.209_RSE(3m)	Engineer: Tyler Yuan
Probe: BBHA9120D_1-18GHz	Polarity: Horizontal
EUT: OmniAccess Stellar	Power: AC 120V/60Hz
Note: Transmit by 802.11a at channel 5500MHz	

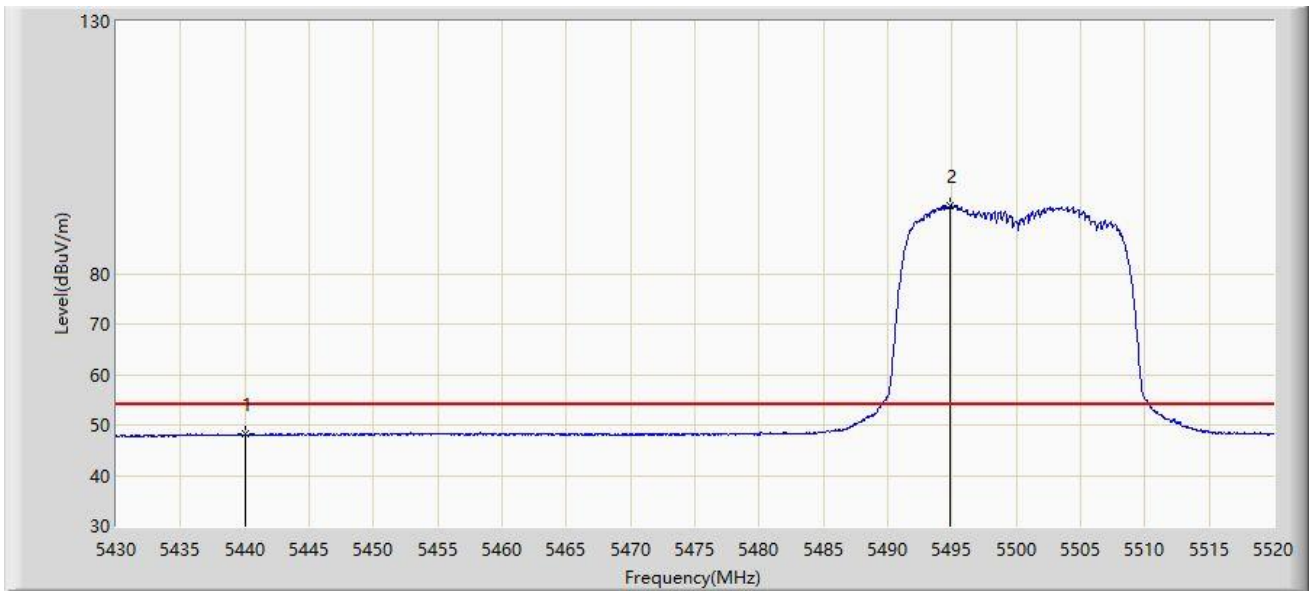

No	Flag	Mark	Frequency (MHz)	Measure Level (dBuV/m)	Reading Level (dBuV)	Margin (dB)	Limit (dBuV/m)	Factor (dB)	Type
1			5439.990	48.198	57.282	-5.802	54.000	-9.084	AV
2		*	5494.890	93.554	102.532	N/A	N/A	-8.979	AV

Note: Measure Level (dB μ V/m) = Reading Level (dB μ V) + Factor (dB)

Factor (dB) = Cable Loss (dB) + Antenna Factor (dB/m) - Pre_Amplifier Gain (dB)

Site: AC1	Time: 2019/11/04 - 18:16
Limit: FCC_Part15.209_RSE(3m)	Engineer: Tyler Yuan
Probe: BBHA9120D_1-18GHz	Polarity: Vertical
EUT: OmniAccess Stellar	Power: AC 120V/60Hz
Note: Transmit by 802.11a at channel 5500MHz	

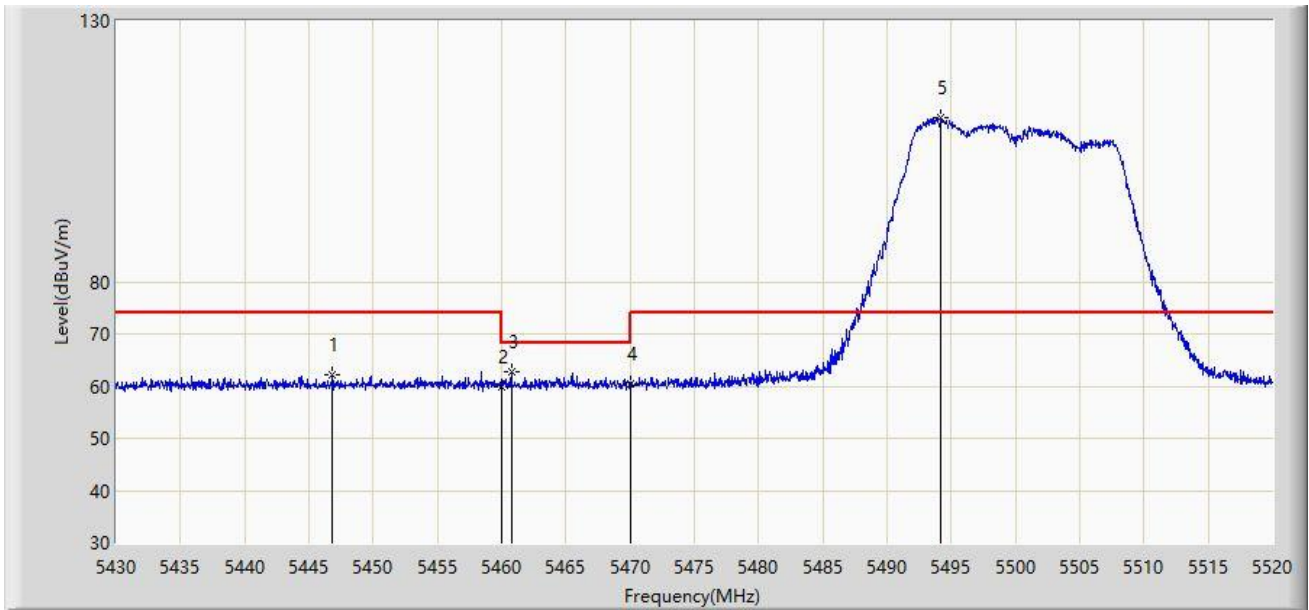

No	Flag	Mark	Frequency (MHz)	Measure Level (dBuV/m)	Reading Level (dBuV)	Margin (dB)	Limit (dBuV/m)	Factor (dB)	Type
1			5446.830	62.192	71.195	-11.808	74.000	-9.003	PK
2			5460.000	59.976	68.956	-14.024	74.000	-8.980	PK
3			5460.735	62.617	71.605	-5.583	68.200	-8.988	PK
4			5470.000	60.501	69.583	-7.699	68.200	-9.082	PK
5		*	5494.170	111.452	120.430	N/A	N/A	-8.978	PK

Note: Measure Level (dBuV/m) = Reading Level (dBuV) + Factor (dB)

Factor (dB) = Cable Loss (dB) + Antenna Factor (dB/m) - Pre_Amplifier Gain (dB)

Site: AC1	Time: 2019/11/04 - 18:17
Limit: FCC_Part15.209_RSE(3m)	Engineer: Tyler Yuan
Probe: BBHA9120D_1-18GHz	Polarity: Vertical
EUT: OmniAccess Stellar	Power: AC 120V/60Hz
Note: Transmit by 802.11a at channel 5500MHz	

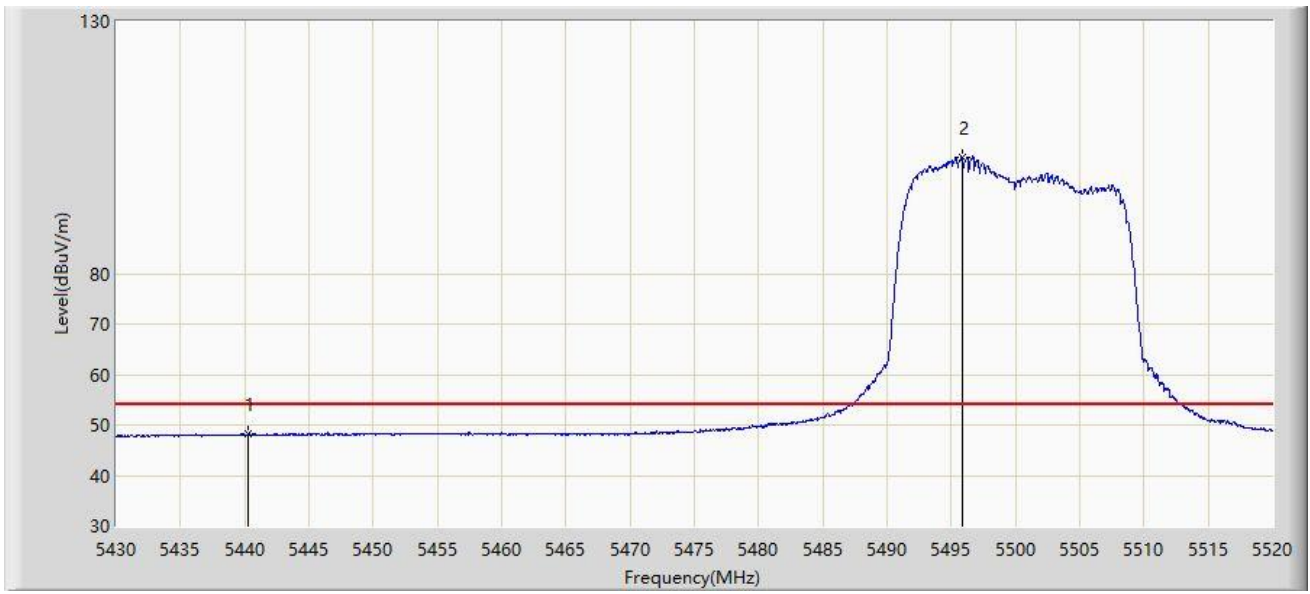

No	Flag	Mark	Frequency (MHz)	Measure Level (dBuV/m)	Reading Level (dBuV)	Margin (dB)	Limit (dBuV/m)	Factor (dB)	Type
1			5440.260	48.192	57.273	-5.808	54.000	-9.081	AV
2		*	5495.835	103.143	112.122	N/A	N/A	-8.979	AV

Note: Measure Level (dB μ V/m) = Reading Level (dB μ V) + Factor (dB)

Factor (dB) = Cable Loss (dB) + Antenna Factor (dB/m) - Pre_Amplifier Gain (dB)

Site: AC1	Time: 2019/11/04 - 18:19
Limit: FCC_Part15.209_RSE(3m)	Engineer: Tyler Yuan
Probe: BBHA9120D_1-18GHz	Polarity: Horizontal
EUT: OmniAccess Stellar	Power: AC 120V/60Hz
Note: Transmit by 802.11a at channel 5700MHz	

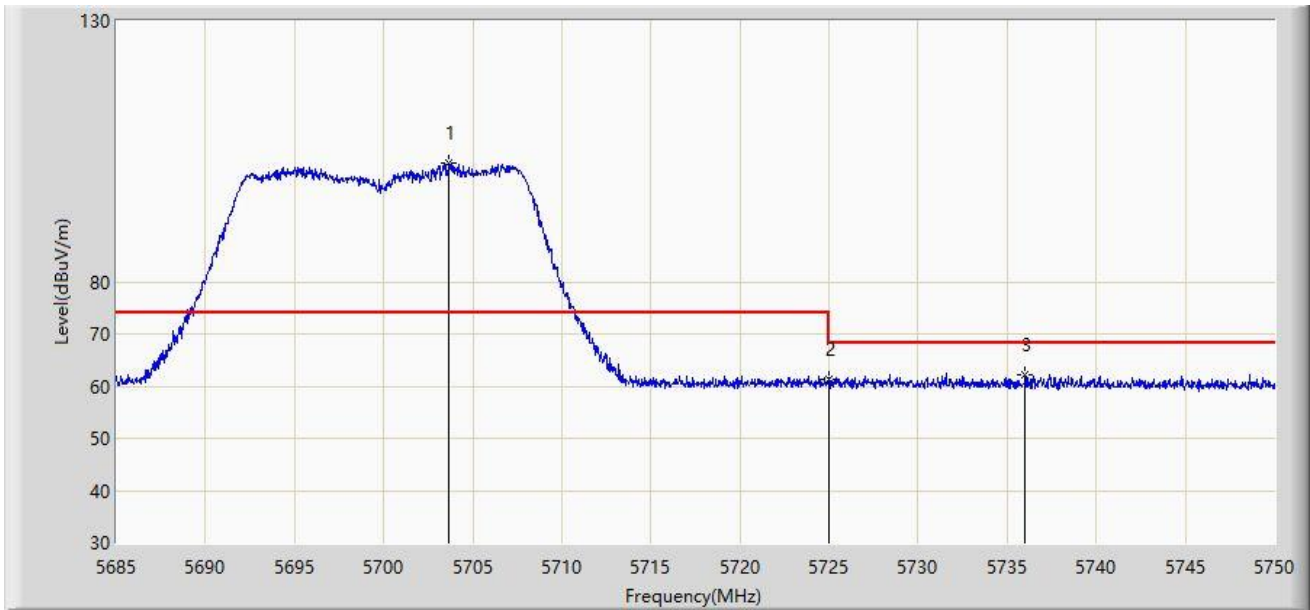

No	Flag	Mark	Frequency (MHz)	Measure Level (dBuV/m)	Reading Level (dBuV)	Margin (dB)	Limit (dBuV/m)	Factor (dB)	Type
1		*	5703.687	102.693	112.072	N/A	N/A	-9.379	PK
2			5725.000	61.171	70.283	-7.029	68.200	-9.112	PK
3			5736.025	62.197	71.412	-6.003	68.200	-9.216	PK

Note: Measure Level (dBμV/m) = Reading Level (dBμV) + Factor (dB)

Factor (dB) = Cable Loss (dB) + Antenna Factor (dB/m) - Pre_Amplifier Gain (dB)

Site: AC1	Time: 2019/11/04 - 18:22
Limit: FCC_Part15.209_RSE(3m)	Engineer: Tyler Yuan
Probe: BBHA9120D_1-18GHz	Polarity: Vertical
EUT: OmniAccess Stellar	Power: AC 120V/60Hz
Note: Transmit by 802.11a at channel 5700MHz	

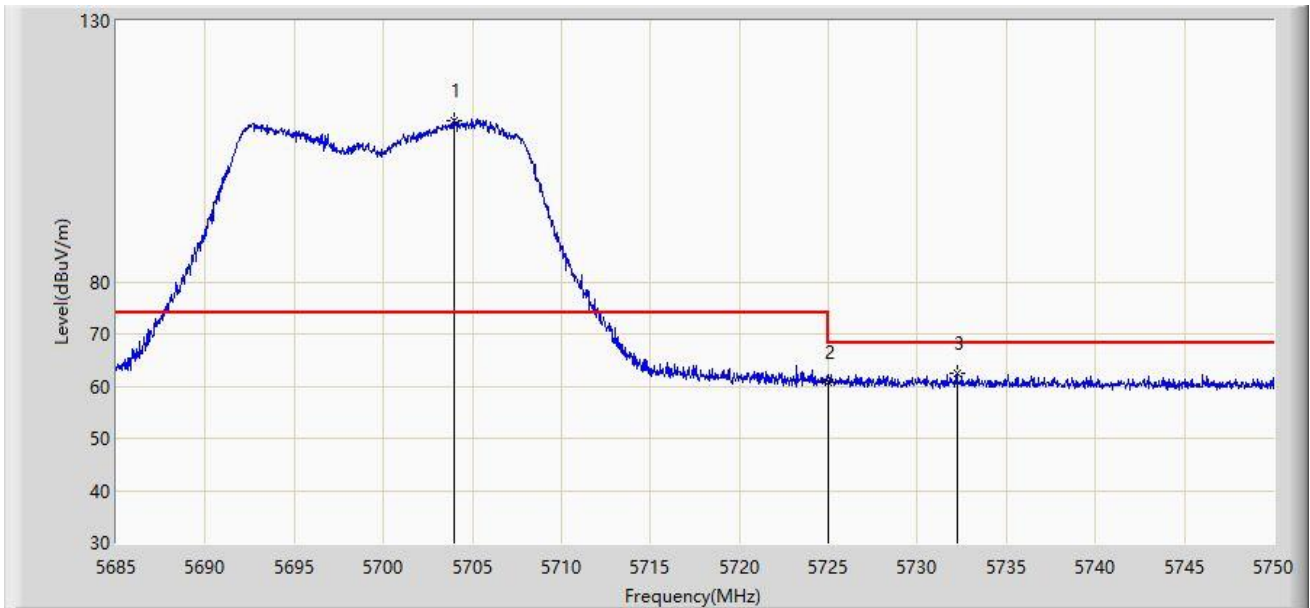

No	Flag	Mark	Frequency (MHz)	Measure Level (dBuV/m)	Reading Level (dBuV)	Margin (dB)	Limit (dBuV/m)	Factor (dB)	Type
1		*	5703.947	110.925	120.305	N/A	N/A	-9.380	PK
2			5725.000	60.810	69.922	-7.390	68.200	-9.112	PK
3			5732.223	62.590	71.759	-5.610	68.200	-9.169	PK

Note: Measure Level (dB μ V/m) = Reading Level (dB μ V) + Factor (dB)

Factor (dB) = Cable Loss (dB) + Antenna Factor (dB/m) - Pre_Amplifier Gain (dB)

Site: AC1	Time: 2020/02/21 - 15:44
Limit: FCC_Part15.209_RSE(3m)	Engineer: Jason Gao
Probe: BBHA9120D_1-18GHz	Polarity: Horizontal
EUT: OmniAccess Stellar	Power: AC 120V/60Hz
Note: Transmit by 802.11n-HT20 at channel 5320MHz	

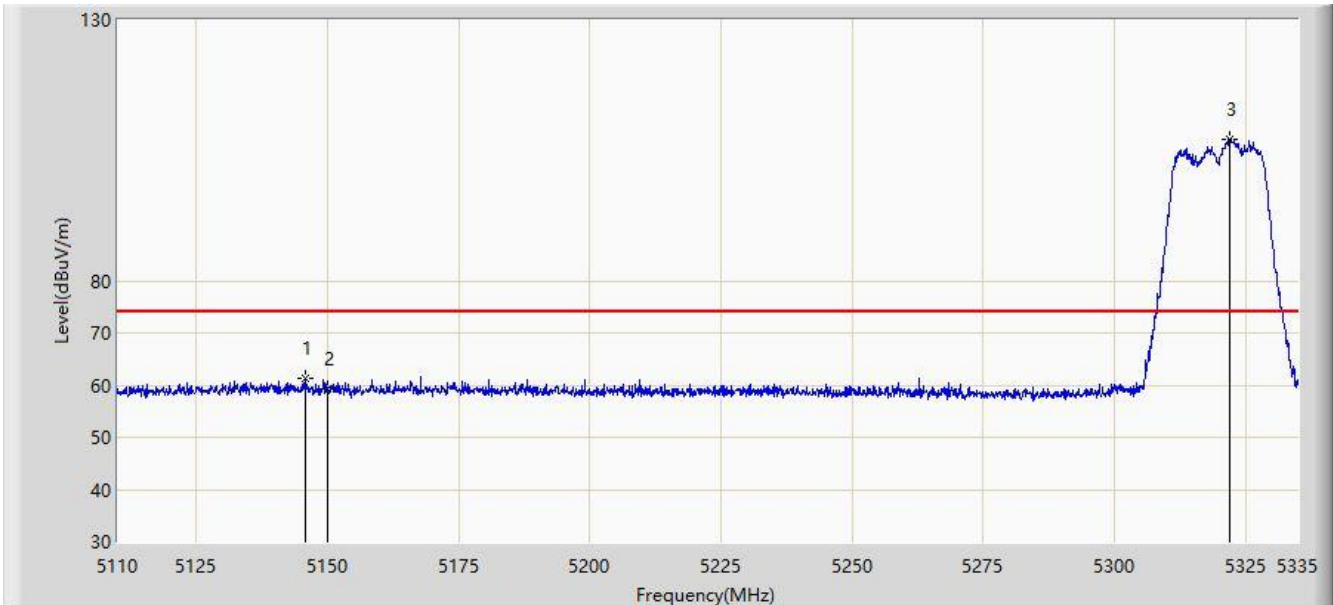

No	Flag	Mark	Frequency (MHz)	Measure Level (dBuV/m)	Reading Level (dBuV)	Margin (dB)	Limit (dBuV/m)	Factor (dB)	Type
1			5145.775	61.254	52.728	-12.746	74.000	8.526	PK
2			5150.000	59.318	50.790	-14.682	74.000	8.528	PK
3		*	5322.062	107.216	98.775	33.216	74.000	8.441	PK

Note: Measure Level (dB μ V/m) = Reading Level (dB μ V) + Factor (dB)

Factor (dB) = Cable Loss (dB) + Antenna Factor (dB/m) - Pre_Amplifier Gain (dB)

Site: AC1	Time: 2020/02/21 - 15:46
Limit: FCC_Part15.209_RSE(3m)	Engineer: Jason Gao
Probe: BBHA9120D_1-18GHz	Polarity: Horizontal
EUT: OmniAccess Stellar	Power: AC 120V/60Hz
Note: Transmit by 802.11n-HT20 at channel 5320MHz	

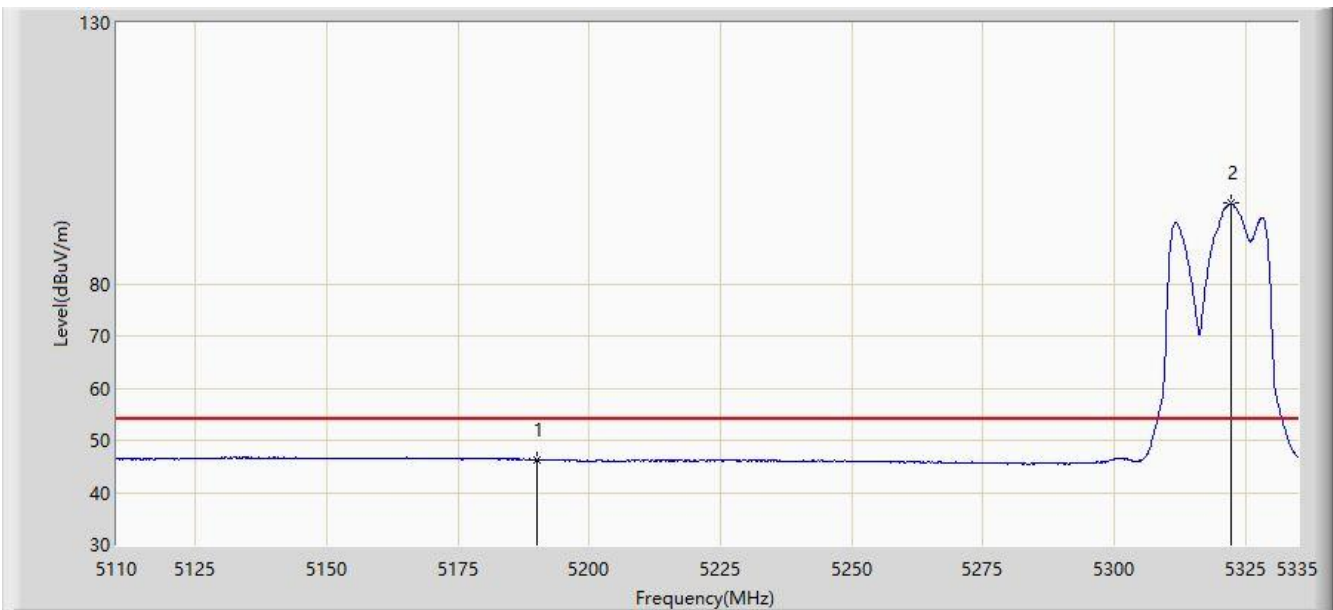

No	Flag	Mark	Frequency (MHz)	Measure Level (dBuV/m)	Reading Level (dBuV)	Margin (dB)	Limit (dBuV/m)	Factor (dB)	Type
1			5190.000	46.273	37.862	-7.727	54.000	8.411	AV
2		*	5322.175	95.392	86.951	41.392	54.000	8.442	AV

Note: Measure Level (dB μ V/m) = Reading Level (dB μ V) + Factor (dB)

Factor (dB) = Cable Loss (dB) + Antenna Factor (dB/m) - Pre_Amplifier Gain (dB)

Site: AC1	Time: 2020/02/21 - 15:51
Limit: FCC_Part15.209_RSE(3m)	Engineer: Jason Gao
Probe: BBHA9120D_1-18GHz	Polarity: Vertical
EUT: OmniAccess Stellar	Power: AC 120V/60Hz
Note: Transmit by 802.11n-HT20 at channel 5320MHz	

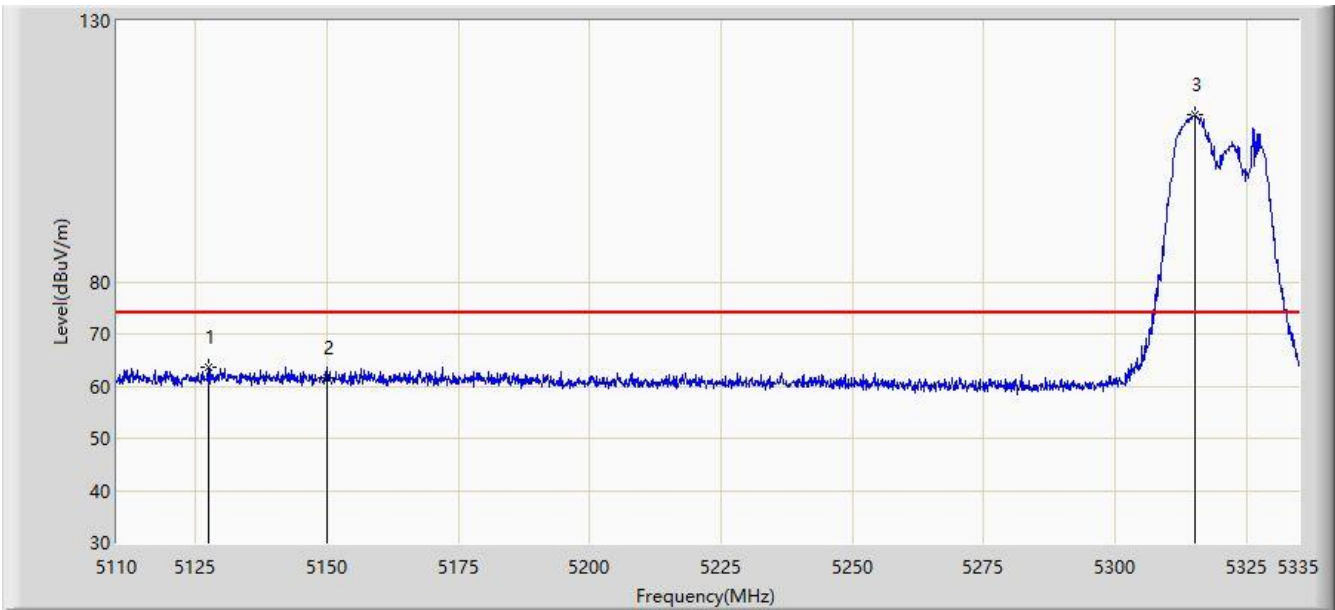

No	Flag	Mark	Frequency (MHz)	Measure Level (dBuV/m)	Reading Level (dBuV)	Margin (dB)	Limit (dBuV/m)	Factor (dB)	Type
1			5127.437	63.746	55.185	-10.254	74.000	8.562	PK
2			5150.000	61.571	53.043	-12.429	74.000	8.528	PK
3		*	5315.200	112.047	103.642	38.047	74.000	8.405	PK

Note: Measure Level (dB μ V/m) = Reading Level (dB μ V) + Factor (dB)

Factor (dB) = Cable Loss (dB) + Antenna Factor (dB/m) - Pre_Amplifier Gain (dB)

Site: AC1	Time: 2020/02/21 - 15:59
Limit: FCC_Part15.209_RSE(3m)	Engineer: Jason Gao
Probe: BBHA9120D_1-18GHz	Polarity: Vertical
EUT: OmniAccess Stellar	Power: AC 120V/60Hz
Note: Transmit by 802.11n-HT20 at channel 5320MHz	

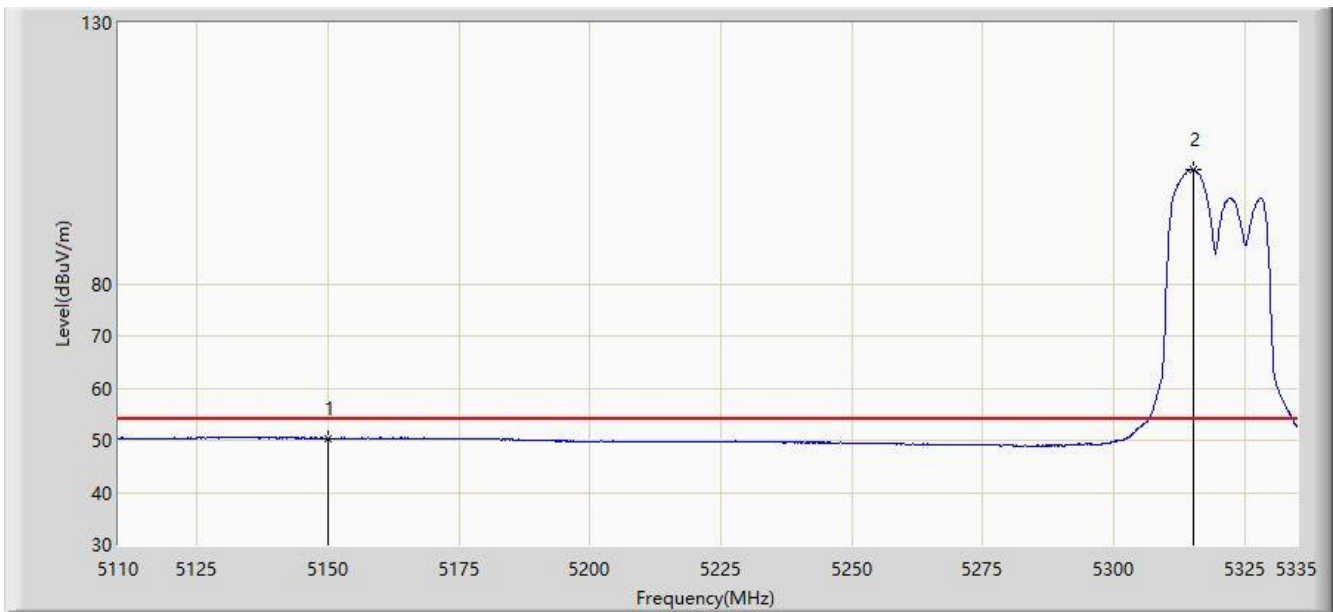

No	Flag	Mark	Frequency (MHz)	Measure Level (dBuV/m)	Reading Level (dBuV)	Margin (dB)	Limit (dBuV/m)	Factor (dB)	Type
1			5150.000	50.362	41.834	-3.638	54.000	8.528	AV
2		*	5315.312	101.907	93.501	47.907	54.000	8.407	AV

Note: Measure Level (dB μ V/m) = Reading Level (dB μ V) + Factor (dB)

Factor (dB) = Cable Loss (dB) + Antenna Factor (dB/m) - Pre_Amplifier Gain (dB)

Site: AC1	Time: 2019/11/04 - 18:23
Limit: FCC_Part15.209_RSE(3m)	Engineer: Tyler Yuan
Probe: BBHA9120D_1-18GHz	Polarity: Horizontal
EUT: OmniAccess Stellar	Power: AC 120V/60Hz
Note: Transmit by 802.11n-HT20 at channel 5320MHz	

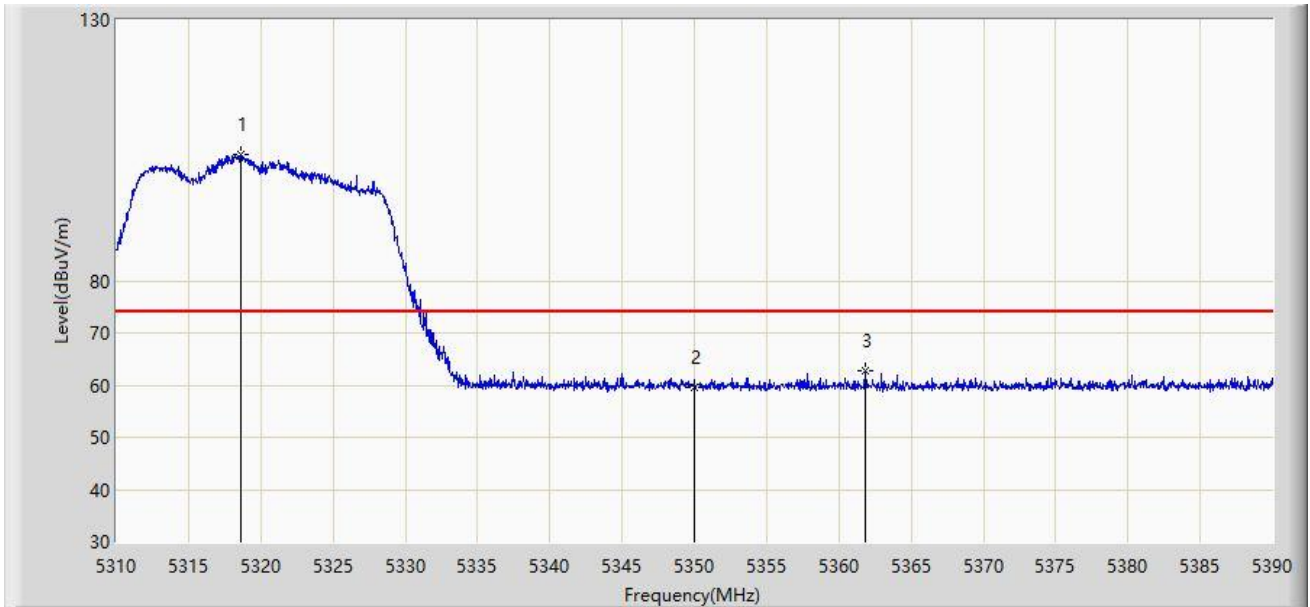

No	Flag	Mark	Frequency (MHz)	Measure Level (dBuV/m)	Reading Level (dBuV)	Margin (dB)	Limit (dBuV/m)	Factor (dB)	Type
1		*	5318.600	104.181	113.786	N/A	N/A	-9.605	PK
2			5350.000	59.436	68.906	-14.564	74.000	-9.469	PK
3			5361.840	62.822	72.296	-11.178	74.000	-9.474	PK

Note: Measure Level (dB μ V/m) = Reading Level (dB μ V) + Factor (dB)

Factor (dB) = Cable Loss (dB) + Antenna Factor (dB/m) - Pre_Amplifier Gain (dB)

Site: AC1	Time: 2019/11/04 - 18:26
Limit: FCC_Part15.209_RSE(3m)	Engineer: Tyler Yuan
Probe: BBHA9120D_1-18GHz	Polarity: Horizontal
EUT: OmniAccess Stellar	Power: AC 120V/60Hz
Note: Transmit by 802.11n-HT20 at channel 5320MHz	

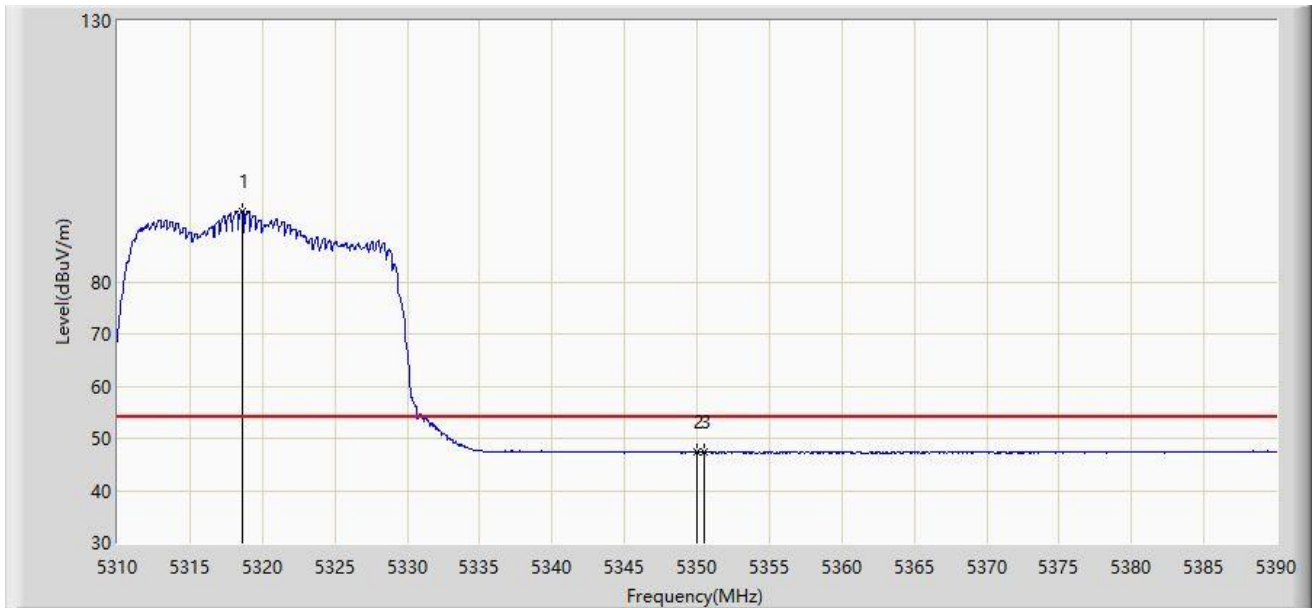

No	Flag	Mark	Frequency (MHz)	Measure Level (dBuV/m)	Reading Level (dBuV)	Margin (dB)	Limit (dBuV/m)	Factor (dB)	Type
1		*	5318.600	93.518	103.123	N/A	N/A	-9.605	AV
2			5350.000	47.332	56.802	-6.668	54.000	-9.469	AV
3			5350.520	47.384	56.856	-6.616	54.000	-9.472	AV

Note: Measure Level (dB μ V/m) = Reading Level (dB μ V) + Factor (dB)

Factor (dB) = Cable Loss (dB) + Antenna Factor (dB/m) - Pre_Amplifier Gain (dB)

Site: AC1	Time: 2019/11/04 - 18:27
Limit: FCC_Part15.209_RSE(3m)	Engineer: Tyler Yuan
Probe: BBHA9120D_1-18GHz	Polarity: Vertical
EUT: OmniAccess Stellar	Power: AC 120V/60Hz
Note: Transmit by 802.11n-HT20 at channel 5320MHz	

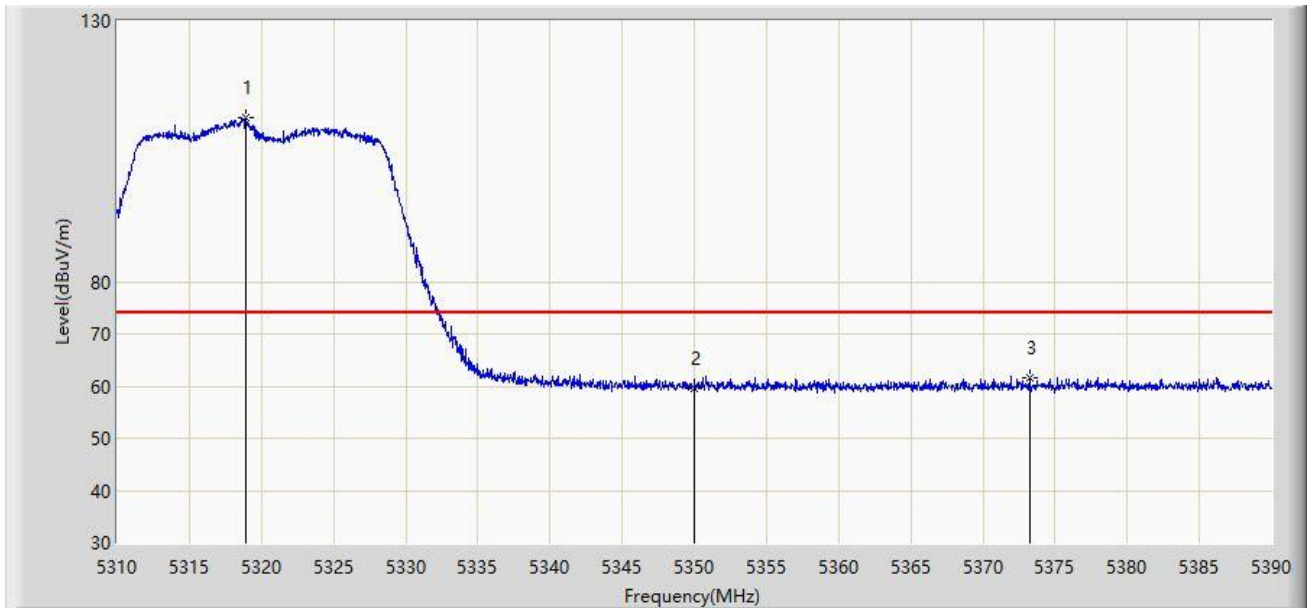

No	Flag	Mark	Frequency (MHz)	Measure Level (dBuV/m)	Reading Level (dBuV)	Margin (dB)	Limit (dBuV/m)	Factor (dB)	Type
1		*	5318.960	111.318	120.919	N/A	N/A	-9.601	PK
2			5350.000	59.613	69.083	-14.387	74.000	-9.469	PK
3			5373.240	61.611	71.056	-12.389	74.000	-9.445	PK

Note: Measure Level (dB μ V/m) = Reading Level (dB μ V) + Factor (dB)

Factor (dB) = Cable Loss (dB) + Antenna Factor (dB/m) - Pre_Amplifier Gain (dB)

Site: AC1	Time: 2019/11/04 - 18:28
Limit: FCC_Part15.209_RSE(3m)	Engineer: Tyler Yuan
Probe: BBHA9120D_1-18GHz	Polarity: Vertical
EUT: OmniAccess Stellar	Power: AC 120V/60Hz
Note: Transmit by 802.11n-HT20 at channel 5320MHz	

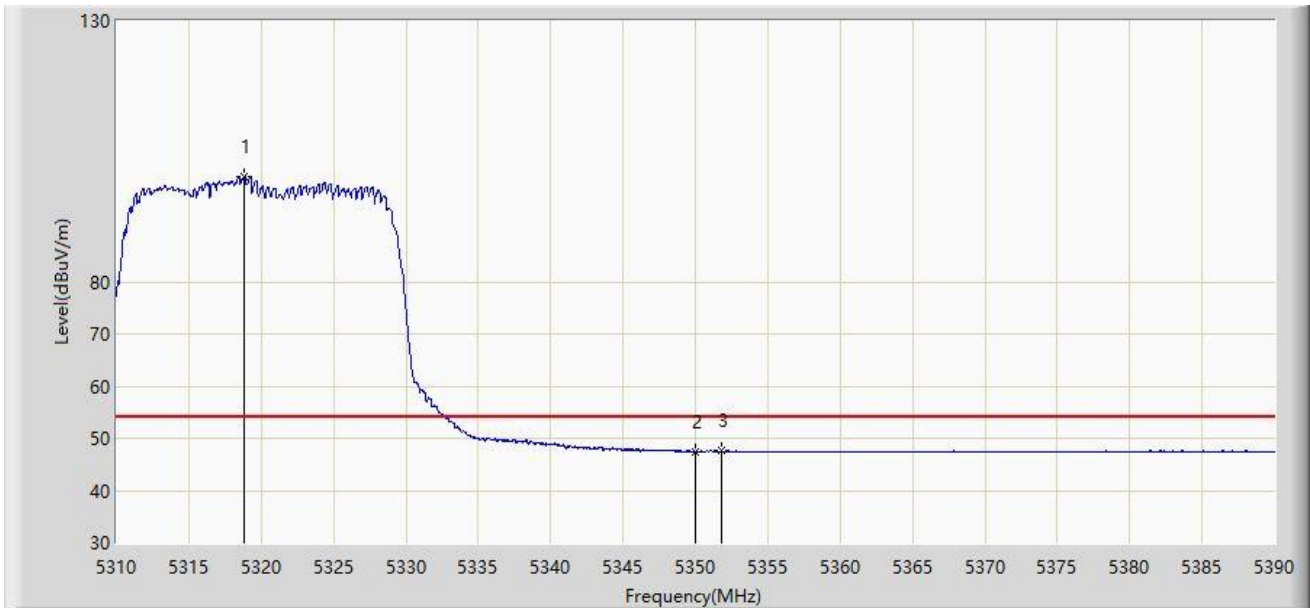

No	Flag	Mark	Frequency (MHz)	Measure Level (dBuV/m)	Reading Level (dBuV)	Margin (dB)	Limit (dBuV/m)	Factor (dB)	Type
1		*	5318.840	100.091	109.693	N/A	N/A	-9.602	AV
2			5350.000	47.441	56.911	-6.559	54.000	-9.469	AV
3			5351.800	47.652	57.128	-6.348	54.000	-9.477	AV

Note: Measure Level (dB μ V/m) = Reading Level (dB μ V) + Factor (dB)

Factor (dB) = Cable Loss (dB) + Antenna Factor (dB/m) - Pre_Amplifier Gain (dB)

Site: AC1	Time: 2019/11/04 - 18:31
Limit: FCC_Part15.209_RSE(3m)	Engineer: Tyler Yuan
Probe: BBHA9120D_1-18GHz	Polarity: Horizontal
EUT: OmniAccess Stellar	Power: AC 120V/60Hz
Note: Transmit by 802.11n-HT20 at channel 5500MHz	

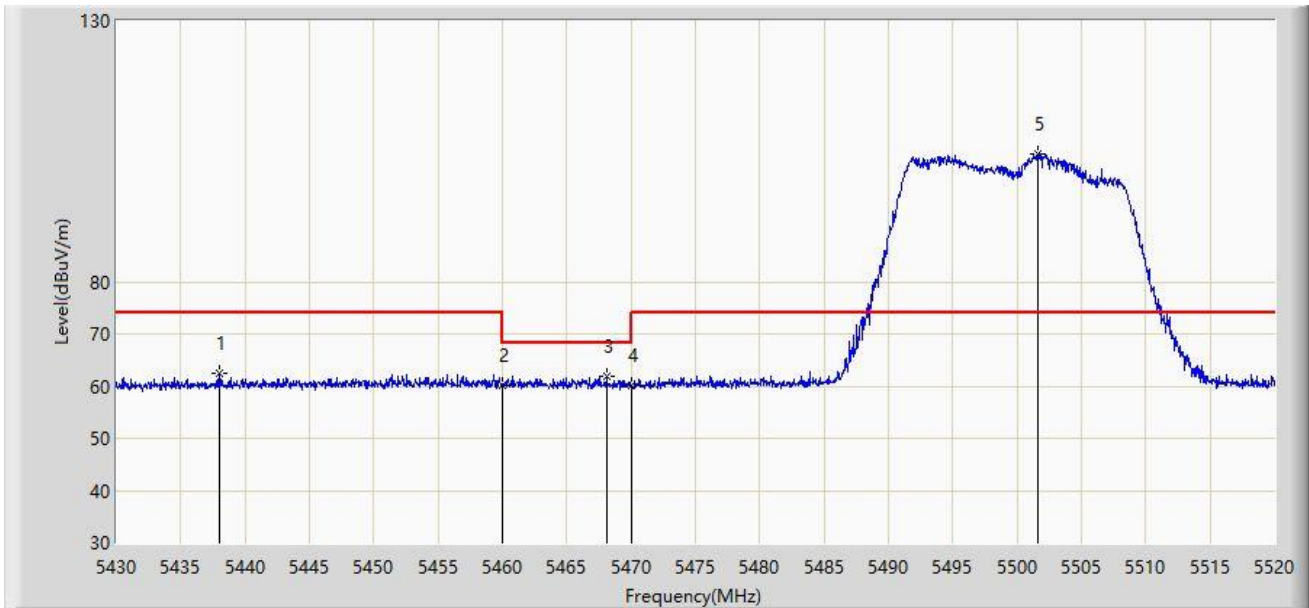

No	Flag	Mark	Frequency (MHz)	Measure Level (dBuV/m)	Reading Level (dBuV)	Margin (dB)	Limit (dBuV/m)	Factor (dB)	Type
1			5438.055	62.338	71.445	-11.662	74.000	-9.106	PK
2			5460.000	60.181	69.161	-13.819	74.000	-8.980	PK
3			5468.115	61.925	70.988	-6.275	68.200	-9.062	PK
4			5470.000	60.139	69.221	-8.061	68.200	-9.082	PK
5		*	5501.595	104.574	113.557	N/A	N/A	-8.984	PK

Note: Measure Level (dBuV/m) = Reading Level (dBuV) + Factor (dB)

Factor (dB) = Cable Loss (dB) + Antenna Factor (dB/m) - Pre_Amplifier Gain (dB)

Site: AC1	Time: 2019/11/04 - 18:32
Limit: FCC_Part15.209_RSE(3m)	Engineer: Tyler Yuan
Probe: BBHA9120D_1-18GHz	Polarity: Horizontal
EUT: OmniAccess Stellar	Power: AC 120V/60Hz
Note: Transmit by 802.11n-HT20 at channel 5500MHz	

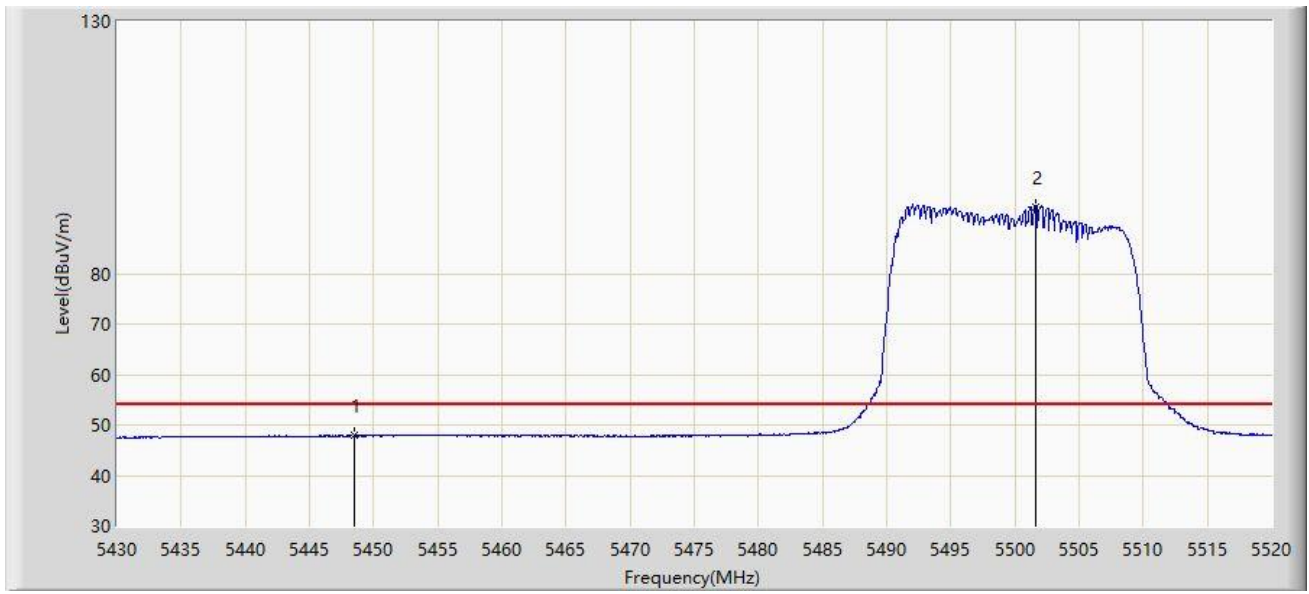

No	Flag	Mark	Frequency (MHz)	Measure Level (dBuV/m)	Reading Level (dBuV)	Margin (dB)	Limit (dBuV/m)	Factor (dB)	Type
1			5448.540	47.892	56.875	-6.108	54.000	-8.983	AV
2		*	5501.595	93.265	102.248	39.265	54.000	-8.984	AV

Note: Measure Level (dB μ V/m) = Reading Level (dB μ V) + Factor (dB)

Factor (dB) = Cable Loss (dB) + Antenna Factor (dB/m) - Pre_Amplifier Gain (dB)

Site: AC1	Time: 2019/11/04 - 18:34
Limit: FCC_Part15.209_RSE(3m)	Engineer: Tyler Yuan
Probe: BBHA9120D_1-18GHz	Polarity: Vertical
EUT: OmniAccess Stellar	Power: AC 120V/60Hz
Note: Transmit by 802.11n-HT20 at channel 5500MHz	

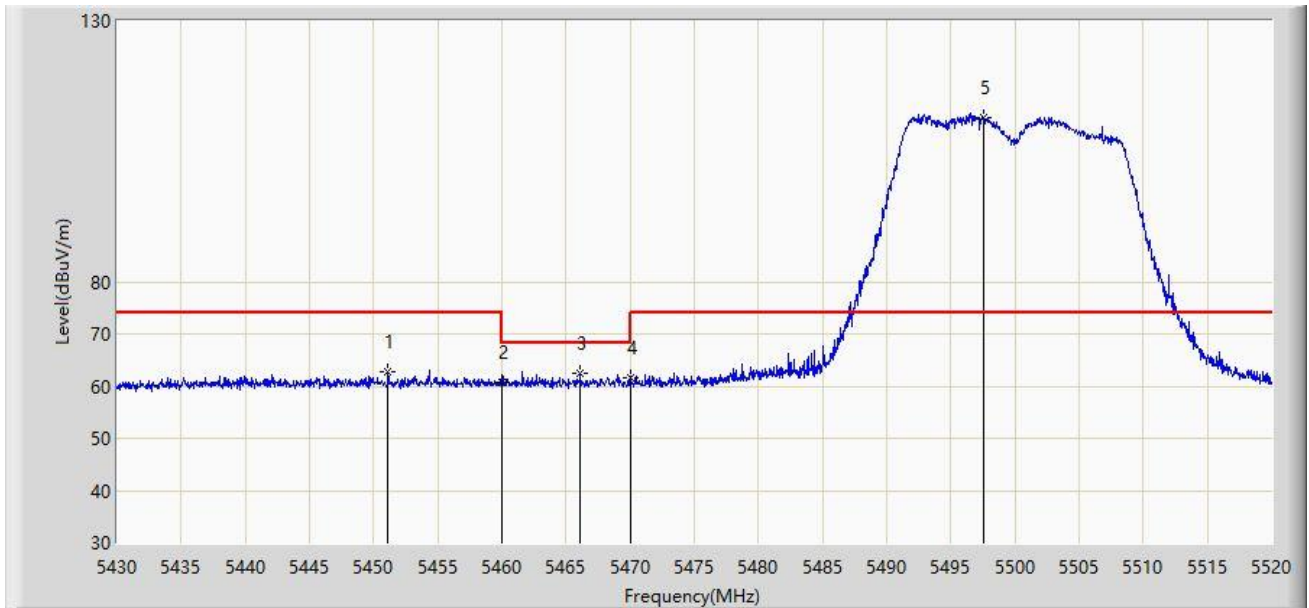

No	Flag	Mark	Frequency (MHz)	Measure Level (dBuV/m)	Reading Level (dBuV)	Margin (dB)	Limit (dBuV/m)	Factor (dB)	Type
1			5451.105	62.832	71.785	-11.168	74.000	-8.953	PK
2			5460.000	60.699	69.679	-13.301	74.000	-8.980	PK
3			5466.135	62.541	71.583	-5.659	68.200	-9.042	PK
4			5470.000	61.708	70.790	-6.492	68.200	-9.082	PK
5		*	5497.590	111.538	120.518	N/A	N/A	-8.980	PK

Note: Measure Level (dBuV/m) = Reading Level (dBuV) + Factor (dB)

Factor (dB) = Cable Loss (dB) + Antenna Factor (dB/m) - Pre_Amplifier Gain (dB)

Site: AC1	Time: 2019/11/04 - 18:36
Limit: FCC_Part15.209_RSE(3m)	Engineer: Tyler Yuan
Probe: BBHA9120D_1-18GHz	Polarity: Vertical
EUT: OmniAccess Stellar	Power: AC 120V/60Hz
Note: Transmit by 802.11n-HT20 at channel 5500MHz	

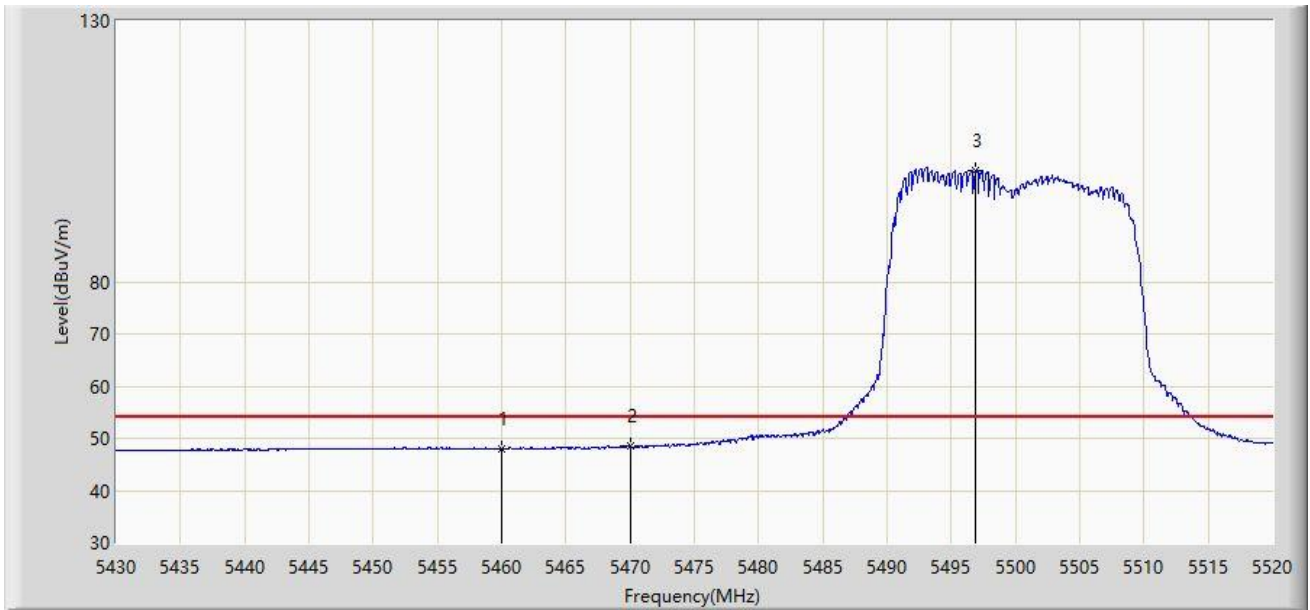

No	Flag	Mark	Frequency (MHz)	Measure Level (dBuV/m)	Reading Level (dBuV)	Margin (dB)	Limit (dBuV/m)	Factor (dB)	Type
1			5451.870	48.079	57.023	-5.921	54.000	-8.945	AV
2		*	5496.915	101.288	110.268	47.288	54.000	-8.980	AV

Note: Measure Level (dBuV/m) = Reading Level (dBuV) + Factor (dB)

Factor (dB) = Cable Loss (dB) + Antenna Factor (dB/m) - Pre_Amplifier Gain (dB)

Site: AC1	Time: 2019/11/04 - 18:38
Limit: FCC_Part15.209_RSE(3m)	Engineer: Tyler Yuan
Probe: BBHA9120D_1-18GHz	Polarity: Horizontal
EUT: OmniAccess Stellar	Power: AC 120V/60Hz
Note: Transmit by 802.11n-HT20 at channel 5700MHz	

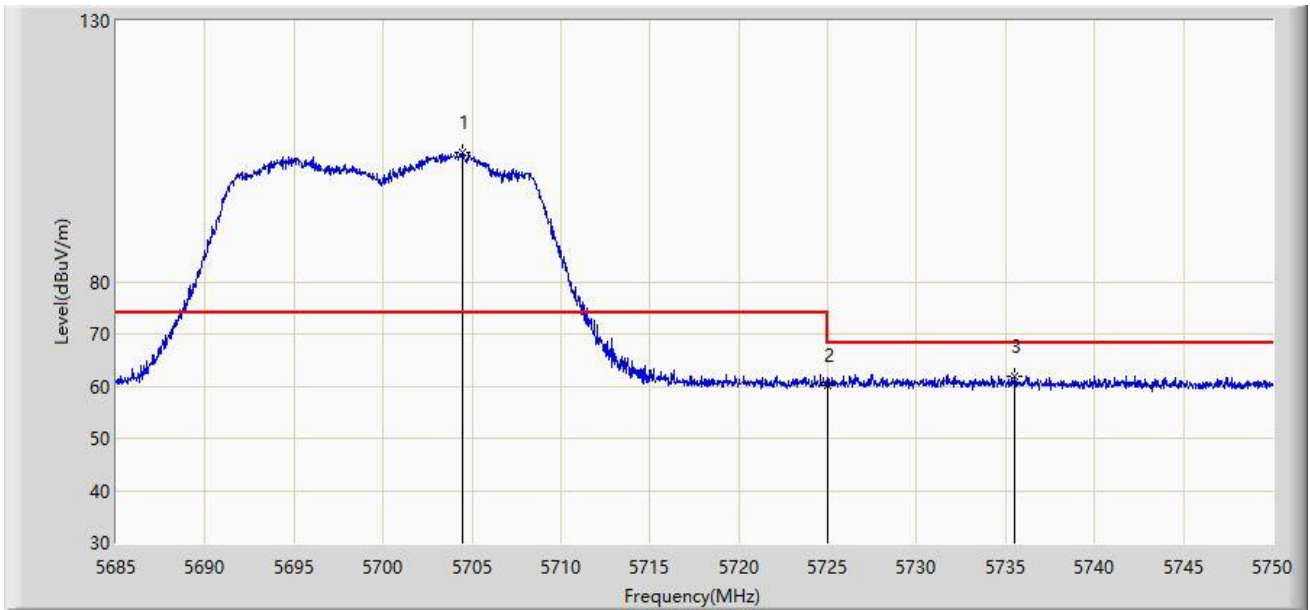

No	Flag	Mark	Frequency (MHz)	Measure Level (dBuV/m)	Reading Level (dBuV)	Margin (dB)	Limit (dBuV/m)	Factor (dB)	Type
1		*	5704.435	104.709	114.091	N/A	N/A	-9.383	PK
2			5725.000	60.201	69.313	-7.999	68.200	-9.112	PK
3			5735.473	62.008	71.217	-6.192	68.200	-9.209	PK

Note: Measure Level (dB μ V/m) = Reading Level (dB μ V) + Factor (dB)

Factor (dB) = Cable Loss (dB) + Antenna Factor (dB/m) - Pre_Amplifier Gain (dB)

Site: AC1	Time: 2019/11/04 - 18:40
Limit: FCC_Part15.209_RSE(3m)	Engineer: Tyler Yuan
Probe: BBHA9120D_1-18GHz	Polarity: Vertical
EUT: OmniAccess Stellar	Power: AC 120V/60Hz
Note: Transmit by 802.11n-HT20 at channel 5700MHz	

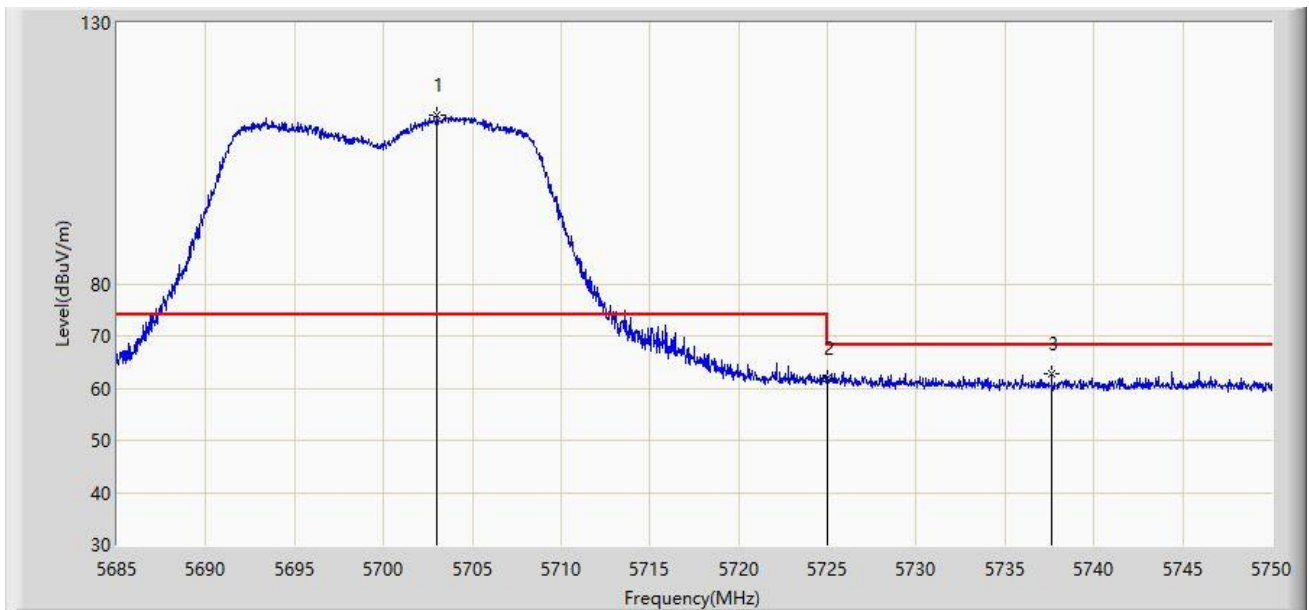

No	Flag	Mark	Frequency (MHz)	Measure Level (dBuV/m)	Reading Level (dBuV)	Margin (dB)	Limit (dBuV/m)	Factor (dB)	Type
1		*	5703.005	112.364	121.740	N/A	N/A	-9.376	PK
2			5725.000	61.757	70.869	-6.443	68.200	-9.112	PK
3			5737.618	62.767	72.002	-5.433	68.200	-9.235	PK

Note: Measure Level (dB μ V/m) = Reading Level (dB μ V) + Factor (dB)

Factor (dB) = Cable Loss (dB) + Antenna Factor (dB/m) - Pre_Amplifier Gain (dB)

Site: AC1	Time: 2020/02/21 - 16:01
Limit: FCC_Part15.209_RSE(3m)	Engineer: Jason Gao
Probe: BBHA9120D_1-18GHz	Polarity: Horizontal
EUT: OmniAccess Stellar	Power: AC 120V/60Hz
Note: Transmit by 802.11n-HT40 at channel 5310MHz	

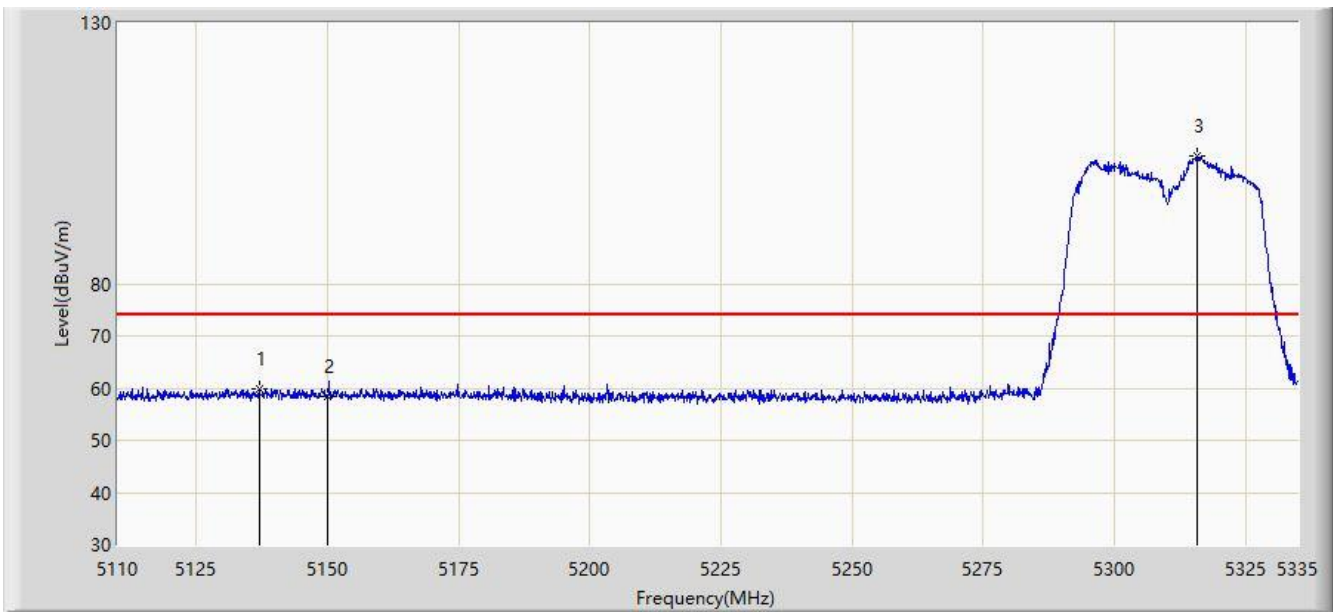

No	Flag	Mark	Frequency (MHz)	Measure Level (dBuV/m)	Reading Level (dBuV)	Margin (dB)	Limit (dBuV/m)	Factor (dB)	Type
1			5137.000	59.979	51.399	-14.021	74.000	8.580	PK
2			5150.000	58.400	49.872	-15.600	74.000	8.528	PK
3		*	5315.875	104.397	95.986	30.397	74.000	8.411	PK

Note: Measure Level (dB μ V/m) = Reading Level (dB μ V) + Factor (dB)

Factor (dB) = Cable Loss (dB) + Antenna Factor (dB/m) - Pre_Amplifier Gain (dB)

Site: AC1	Time: 2020/02/21 - 16:04
Limit: FCC_Part15.209_RSE(3m)	Engineer: Jason Gao
Probe: BBHA9120D_1-18GHz	Polarity: Horizontal
EUT: OmniAccess Stellar	Power: AC 120V/60Hz
Note: Transmit by 802.11n-HT40 at channel 5310MHz	

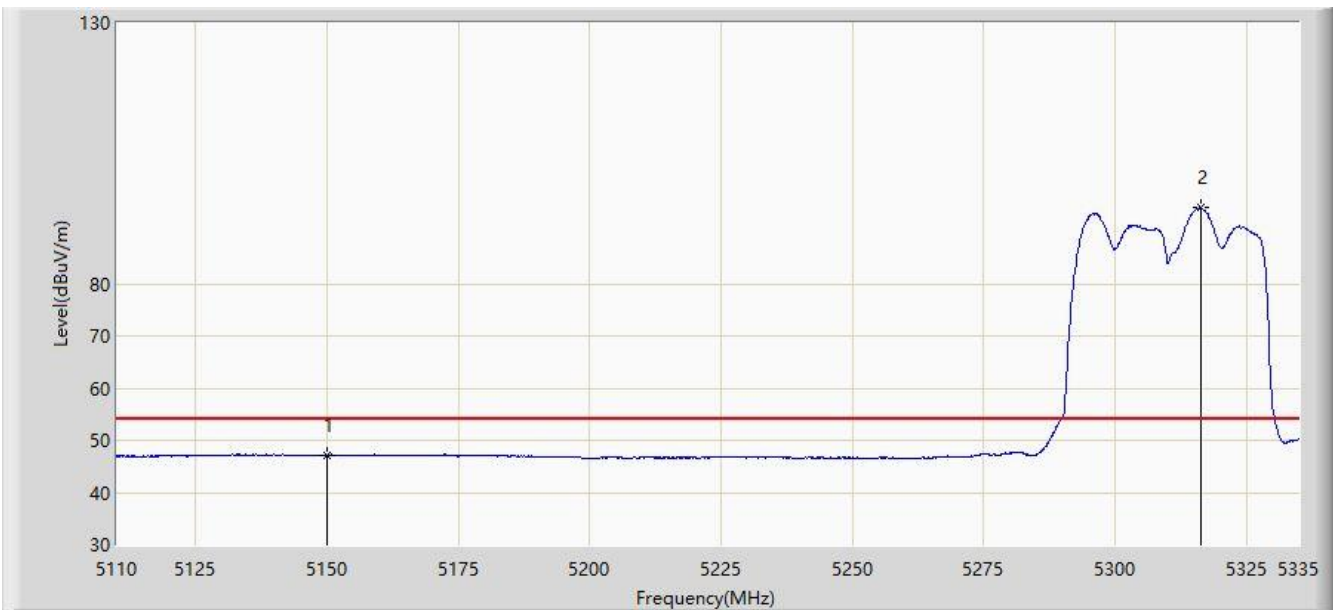

No	Flag	Mark	Frequency (MHz)	Measure Level (dBuV/m)	Reading Level (dBuV)	Margin (dB)	Limit (dBuV/m)	Factor (dB)	Type
1			5150.000	47.104	38.576	-6.896	54.000	8.528	AV
2		*	5316.325	94.545	86.130	40.545	54.000	8.415	AV

Note: Measure Level (dB μ V/m) = Reading Level (dB μ V) + Factor (dB)

Factor (dB) = Cable Loss (dB) + Antenna Factor (dB/m) - Pre_Amplifier Gain (dB)

Site: AC1	Time: 2020/02/21 - 16:06
Limit: FCC_Part15.209_RSE(3m)	Engineer: Jason Gao
Probe: BBHA9120D_1-18GHz	Polarity: Vertical
EUT: OmniAccess Stellar	Power: AC 120V/60Hz
Note: Transmit by 802.11n-HT40 at channel 5310MHz	

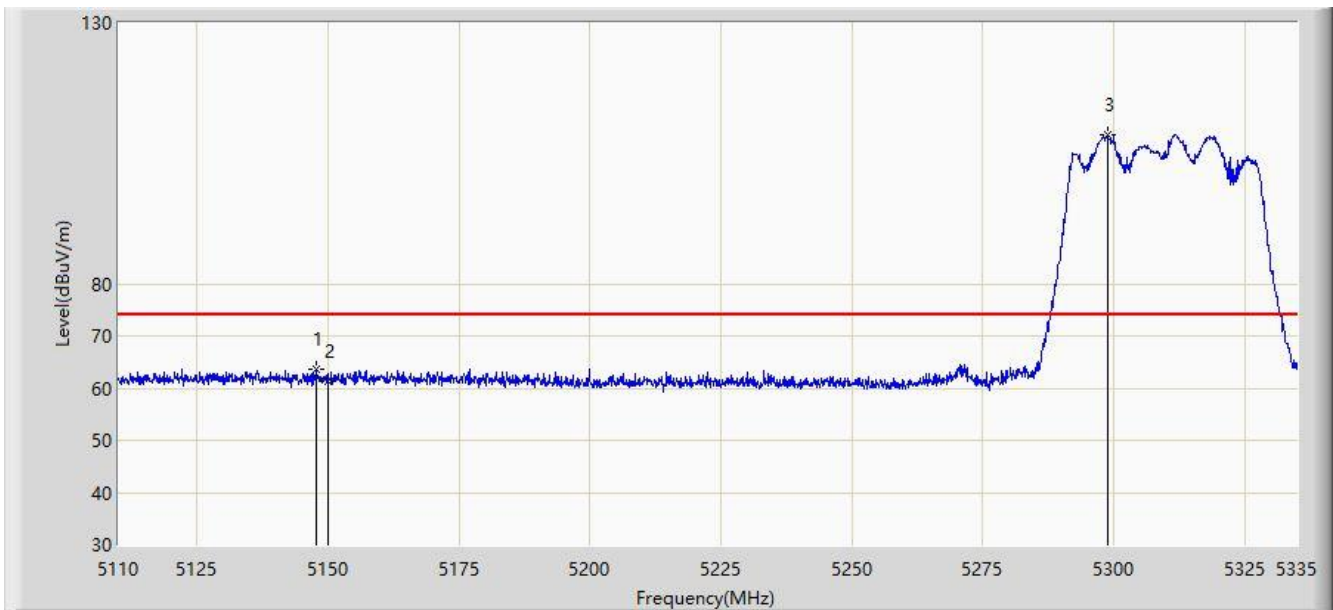

No	Flag	Mark	Frequency (MHz)	Measure Level (dBuV/m)	Reading Level (dBuV)	Margin (dB)	Limit (dBuV/m)	Factor (dB)	Type
1			5147.913	63.658	55.145	-10.342	74.000	8.512	PK
2			5150.000	61.314	52.786	-12.686	74.000	8.528	PK
3		*	5298.775	108.499	100.244	34.499	74.000	8.256	PK

Note: Measure Level (dB μ V/m) = Reading Level (dB μ V) + Factor (dB)

Factor (dB) = Cable Loss (dB) + Antenna Factor (dB/m) - Pre_Amplifier Gain (dB)

Site: AC1	Time: 2020/02/21 - 16:07
Limit: FCC_Part15.209_RSE(3m)	Engineer: Jason Gao
Probe: BBHA9120D_1-18GHz	Polarity: Vertical
EUT: OmniAccess Stellar	Power: AC 120V/60Hz
Note: Transmit by 802.11n-HT40 at channel 5310MHz	

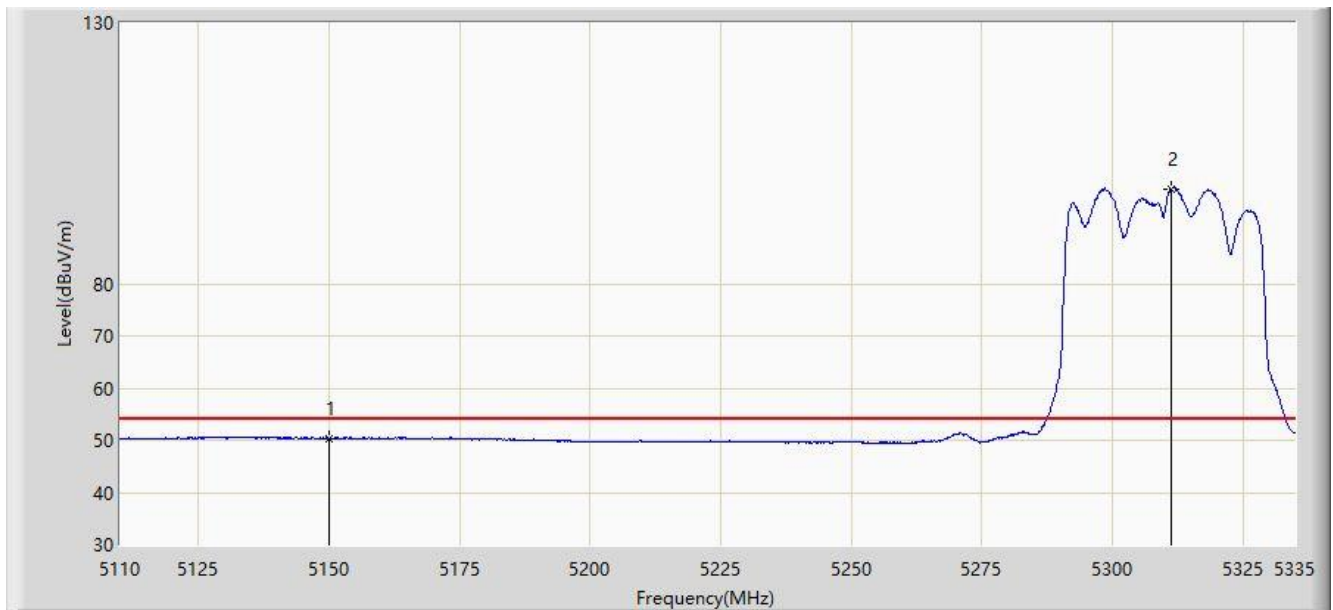

No	Flag	Mark	Frequency (MHz)	Measure Level (dBuV/m)	Reading Level (dBuV)	Margin (dB)	Limit (dBuV/m)	Factor (dB)	Type
1			5150.000	50.311	41.783	-3.689	54.000	8.528	AV
2		*	5311.375	98.228	89.857	44.228	54.000	8.372	AV

Note: Measure Level (dB μ V/m) = Reading Level (dB μ V) + Factor (dB)

Factor (dB) = Cable Loss (dB) + Antenna Factor (dB/m) - Pre_Amplifier Gain (dB)

Site: AC2	Time: 2019/10/04 - 16:34
Limit: FCC_Part15.209_RSE(3m)	Engineer: Bacon Dong
Probe: BBHA9120D_1-18GHz	Polarity: Horizontal
EUT: OmniAccess Stellar	Power: AC 120V/60Hz
Test Mode: Transmit by 802.11n-HT40 at Channel 5310MHz	

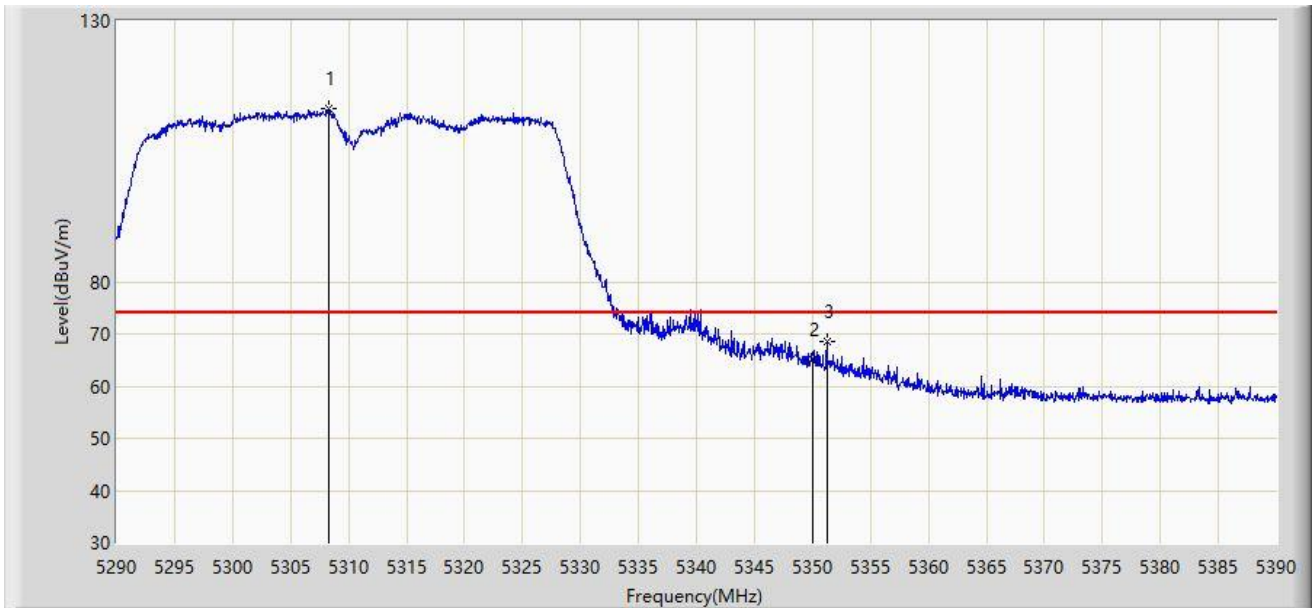

No	Flag	Mark	Frequency (MHz)	Measure Level (dBuV/m)	Reading Level (dBuV)	Margin (dB)	Limit (dBuV/m)	Factor (dB)	Type
1		*	5308.350	113.107	109.666	N/A	N/A	3.440	PK
2			5350.000	65.025	61.325	-8.975	74.000	3.701	PK
3			5351.250	68.440	64.736	-5.560	74.000	3.704	PK

Note: Measure Level (dB μ V/m) = Reading Level (dB μ V) + Factor (dB)

Factor (dB) = Cable Loss (dB) + Antenna Factor (dB/m) - Pre_Amplifier Gain (dB)

Site: AC2	Time: 2019/10/04 - 16:32
Limit: FCC_Part15.209_RSE(3m)	Engineer: Bacon Dong
Probe: BBHA9120D_1-18GHz	Polarity: Horizontal
EUT: OmniAccess Stellar	Power: AC 120V/60Hz
Test Mode: Transmit by 802.11n-HT40 at Channel 5310MHz	

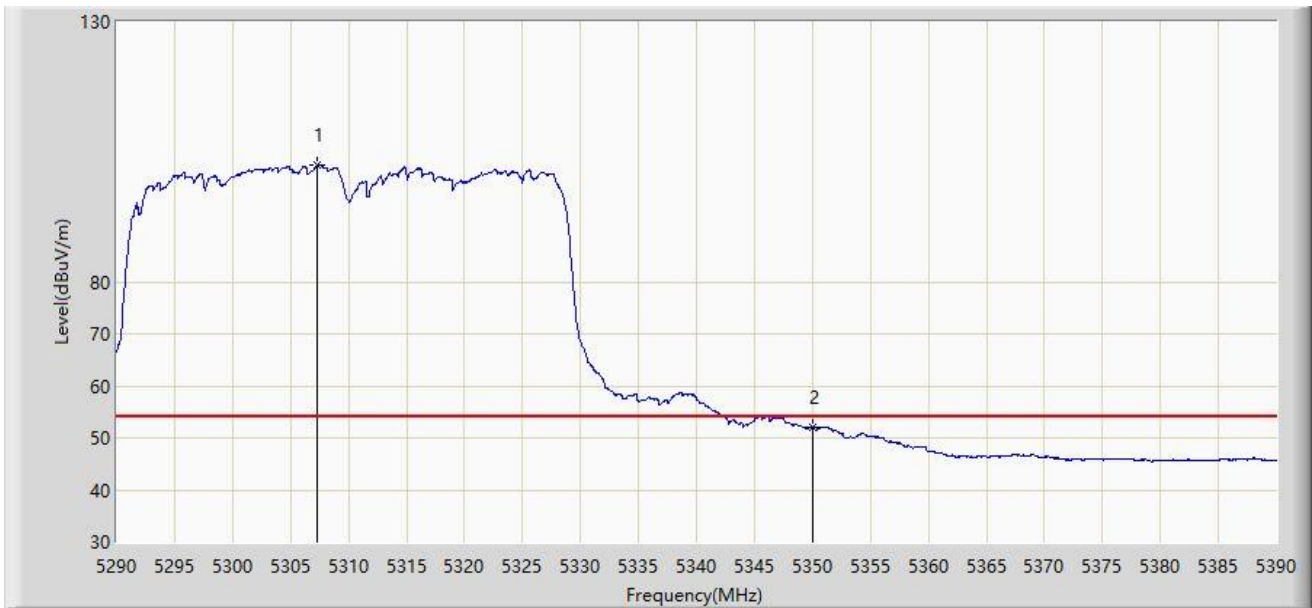

No	Flag	Mark	Frequency (MHz)	Measure Level (dBuV/m)	Reading Level (dBuV)	Margin (dB)	Limit (dBuV/m)	Factor (dB)	Type
1		*	5307.300	102.374	98.942	N/A	N/A	3.432	AV
2			5350.000	51.935	48.235	-2.065	54.000	3.701	AV

Note: Measure Level (dB μ V/m) = Reading Level (dB μ V) + Factor (dB)

Factor (dB) = Cable Loss (dB) + Antenna Factor (dB/m) - Pre_Amplifier Gain (dB)

Site: AC2	Time: 2019/10/04 - 16:34
Limit: FCC_Part15.209_RSE(3m)	Engineer: Bacon Dong
Probe: BBHA9120D_1-18GHz	Polarity: Vertical
EUT: OmniAccess Stellar	Power: AC 120V/60Hz
Test Mode: Transmit by 802.11n-HT40 at Channel 5310MHz	

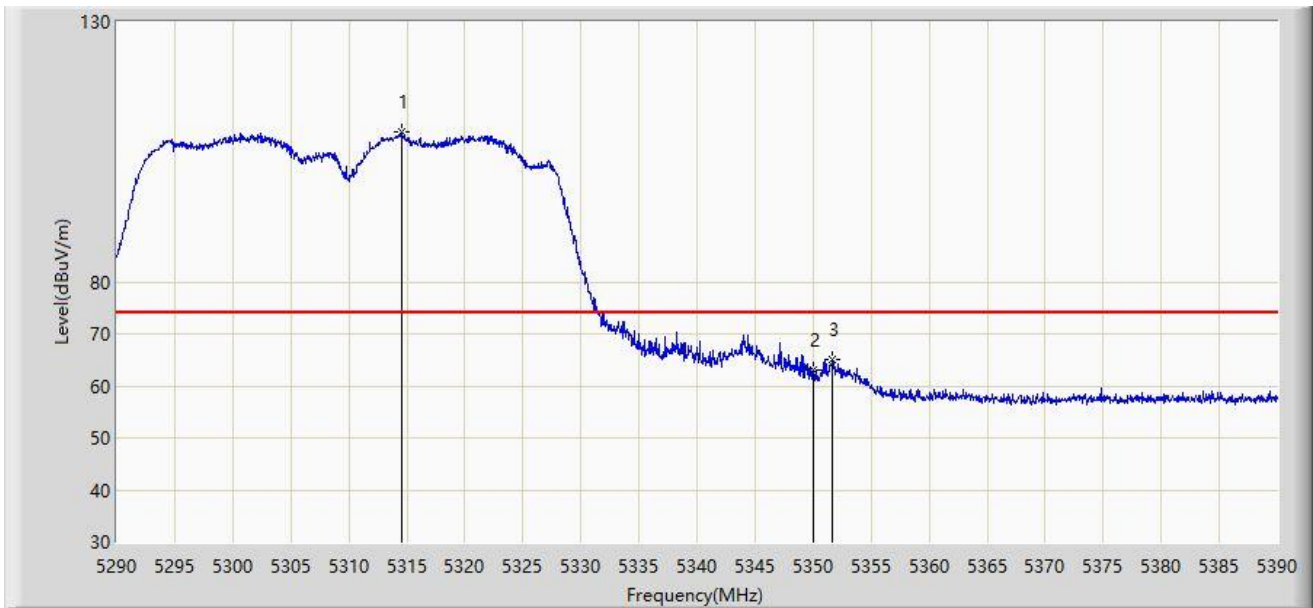

No	Flag	Mark	Frequency (MHz)	Measure Level (dBuV/m)	Reading Level (dBuV)	Margin (dB)	Limit (dBuV/m)	Factor (dB)	Type
1		*	5314.550	108.967	105.473	N/A	N/A	3.495	PK
2			5350.000	63.181	59.481	-10.819	74.000	3.701	PK
3			5351.650	65.047	61.342	-8.953	74.000	3.705	PK

Note: Measure Level (dB μ V/m) = Reading Level (dB μ V) + Factor (dB)

Factor (dB) = Cable Loss (dB) + Antenna Factor (dB/m) - Pre_Amplifier Gain (dB)

Site: AC2	Time: 2019/10/04 - 16:34
Limit: FCC_Part15.209_RSE(3m)	Engineer: Bacon Dong
Probe: BBHA9120D_1-18GHz	Polarity: Vertical
EUT: OmniAccess Stellar	Power: AC 120V/60Hz
Test Mode: Transmit by 802.11n-HT40 at Channel 5310MHz	

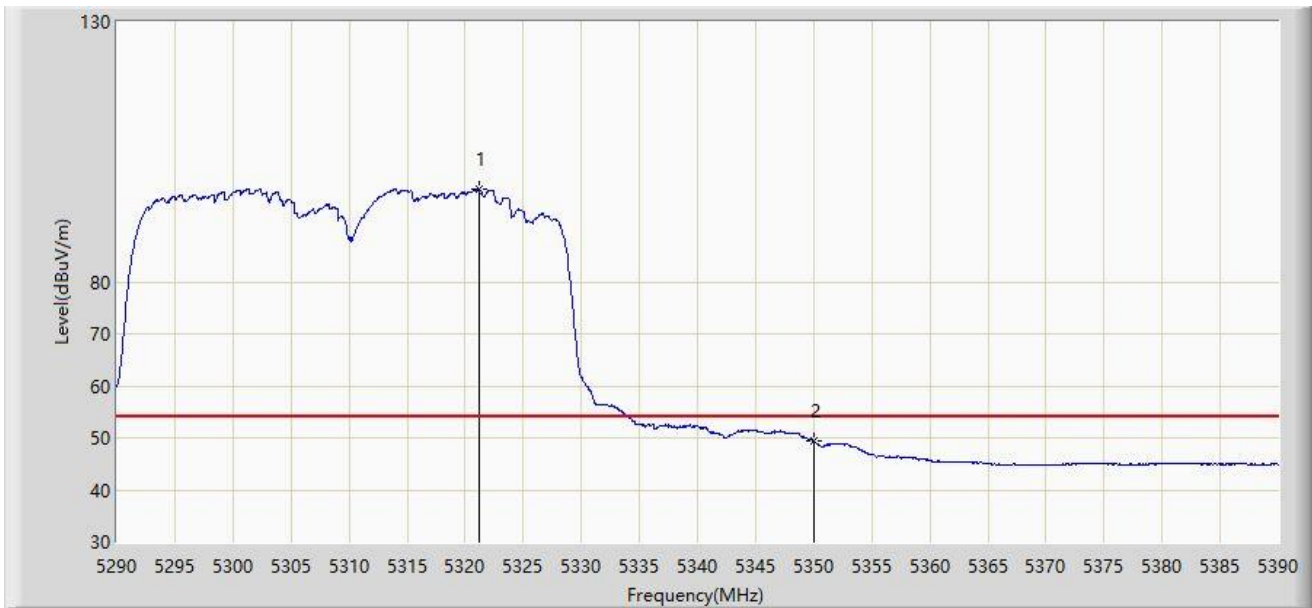

No	Flag	Mark	Frequency (MHz)	Measure Level (dBuV/m)	Reading Level (dBuV)	Margin (dB)	Limit (dBuV/m)	Factor (dB)	Type
1		*	5321.150	97.932	94.382	N/A	N/A	3.550	AV
2			5350.000	49.296	45.596	-4.704	54.000	3.701	AV

Note: Measure Level (dB μ V/m) = Reading Level (dB μ V) + Factor (dB)

Factor (dB) = Cable Loss (dB) + Antenna Factor (dB/m) - Pre_Amplifier Gain (dB)

Site: AC2	Time: 2019/10/04 - 16:40
Limit: FCC_Part15.209_RSE(3m)	Engineer: Bacon Dong
Probe: BBHA9120D_1-18GHz	Polarity: Horizontal
EUT: OmniAccess Stellar	Power: AC 120V/60Hz
Test Mode: Transmit by 802.11n-HT40 at Channel 5510MHz	

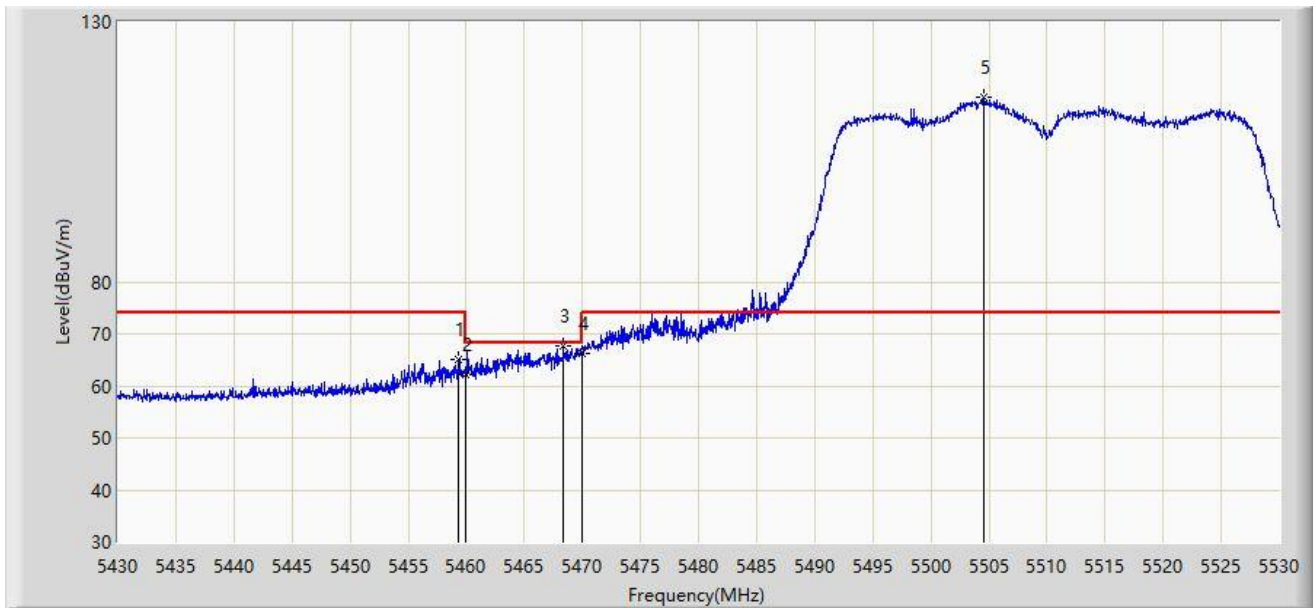

No	Flag	Mark	Frequency (MHz)	Measure Level (dBuV/m)	Reading Level (dBuV)	Margin (dB)	Limit (dBuV/m)	Factor (dB)	Type
1			5459.350	65.005	60.904	-8.995	74.000	4.100	PK
2			5460.000	62.123	58.028	-11.877	74.000	4.095	PK
3			5468.350	67.612	63.592	-0.588	68.200	4.019	PK
4			5470.000	66.282	62.277	-1.918	68.200	4.005	PK
5		*	5504.550	115.508	111.229	N/A	N/A	4.279	PK

Note: Measure Level (dBuV/m) = Reading Level (dBuV) + Factor (dB)

Factor (dB) = Cable Loss (dB) + Antenna Factor (dB/m) - Pre_Amplifier Gain (dB)

Site: AC2	Time: 2019/10/04 - 16:42
Limit: FCC_Part15.209_RSE(3m)	Engineer: Bacon Dong
Probe: BBHA9120D_1-18GHz	Polarity: Horizontal
EUT: OmniAccess Stellar	Power: AC 120V/60Hz
Test Mode: Transmit by 802.11n-HT40 at Channel 5510MHz	

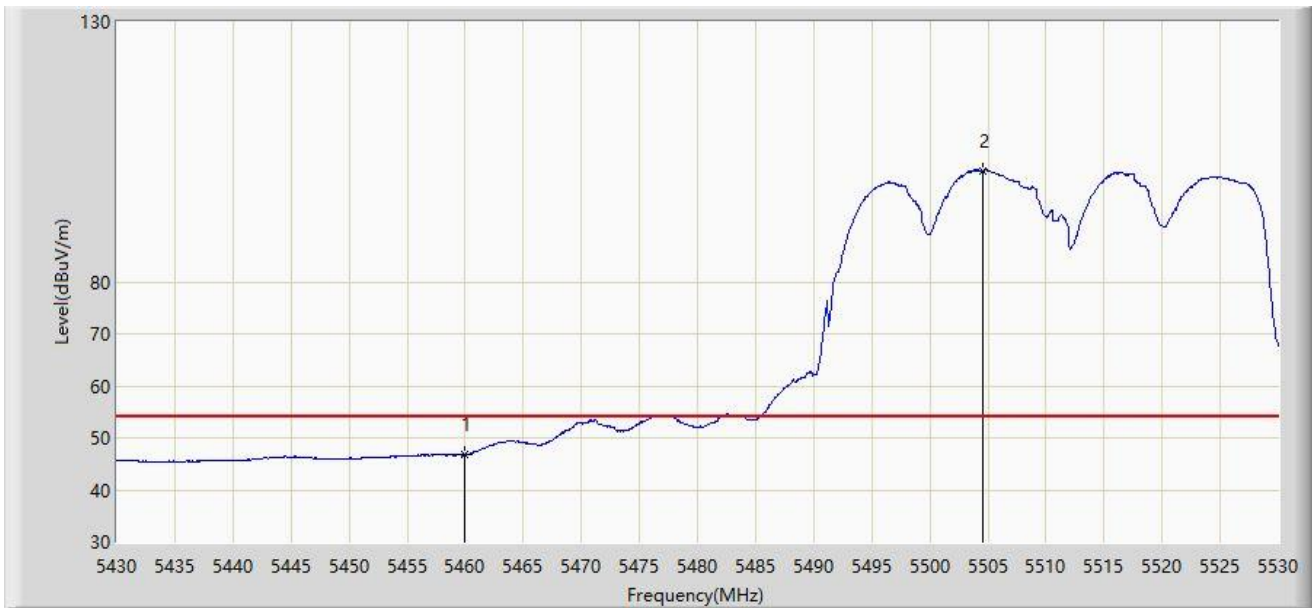

No	Flag	Mark	Frequency (MHz)	Measure Level (dBuV/m)	Reading Level (dBuV)	Margin (dB)	Limit (dBuV/m)	Factor (dB)	Type
1			5460.000	46.856	42.761	-7.144	54.000	4.095	AV
2		*	5504.600	101.447	97.167	N/A	N/A	4.279	AV

Note: Measure Level (dB μ V/m) = Reading Level (dB μ V) + Factor (dB)

Factor (dB) = Cable Loss (dB) + Antenna Factor (dB/m) - Pre_Amplifier Gain (dB)

Site: AC2	Time: 2019/10/04 - 16:43
Limit: FCC_Part15.209_RSE(3m)	Engineer: Bacon Dong
Probe: BBHA9120D_1-18GHz	Polarity: Vertical
EUT: OmniAccess Stellar	Power: AC 120V/60Hz
Test Mode: Transmit by 802.11n-HT40 at Channel 5510MHz	

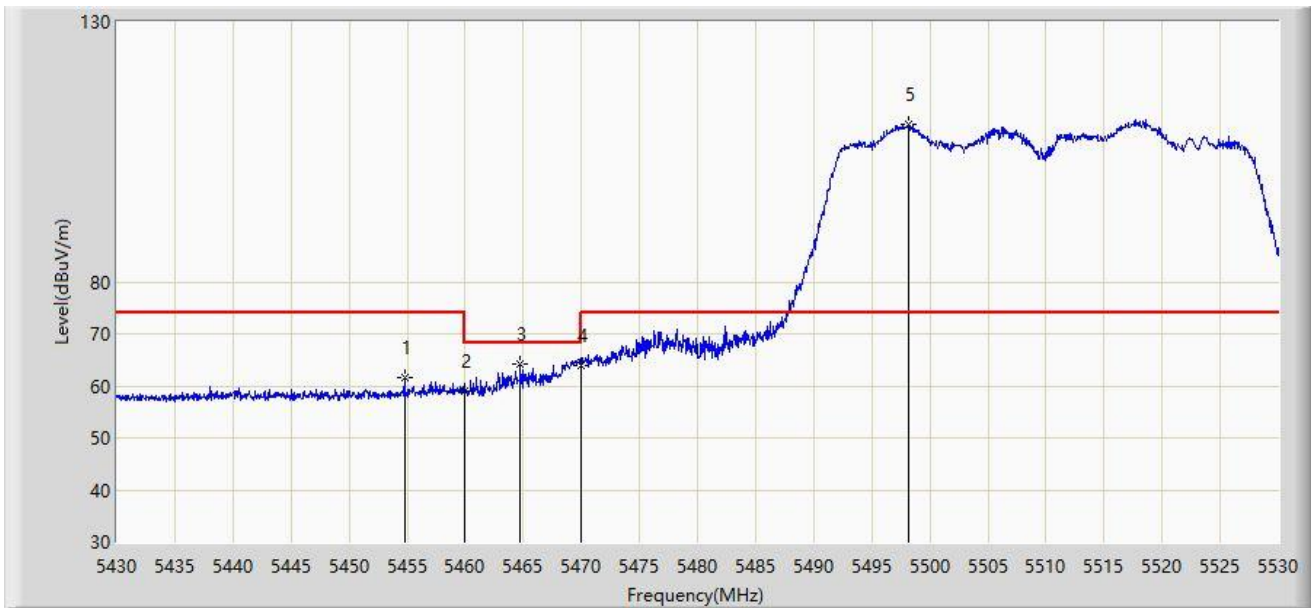

No	Flag	Mark	Frequency (MHz)	Measure Level (dBuV/m)	Reading Level (dBuV)	Margin (dB)	Limit (dBuV/m)	Factor (dB)	Type
1			5454.750	61.502	57.360	-12.498	74.000	4.142	PK
2			5460.000	59.013	54.918	-14.987	74.000	4.095	PK
3			5464.700	64.119	60.066	-4.081	68.200	4.053	PK
4			5470.000	63.963	59.958	-4.237	68.200	4.005	PK
5		*	5498.150	110.413	106.182	N/A	N/A	4.231	PK

Note: Measure Level (dBuV/m) = Reading Level (dBuV) + Factor (dB)

Factor (dB) = Cable Loss (dB) + Antenna Factor (dB/m) - Pre_Amplifier Gain (dB)

Site: AC2	Time: 2019/10/04 - 16:43
Limit: FCC_Part15.209_RSE(3m)	Engineer: Bacon Dong
Probe: BBHA9120D_1-18GHz	Polarity: Vertical
EUT: OmniAccess Stellar	Power: AC 120V/60Hz
Test Mode: Transmit by 802.11n-HT40 at Channel 5510MHz	

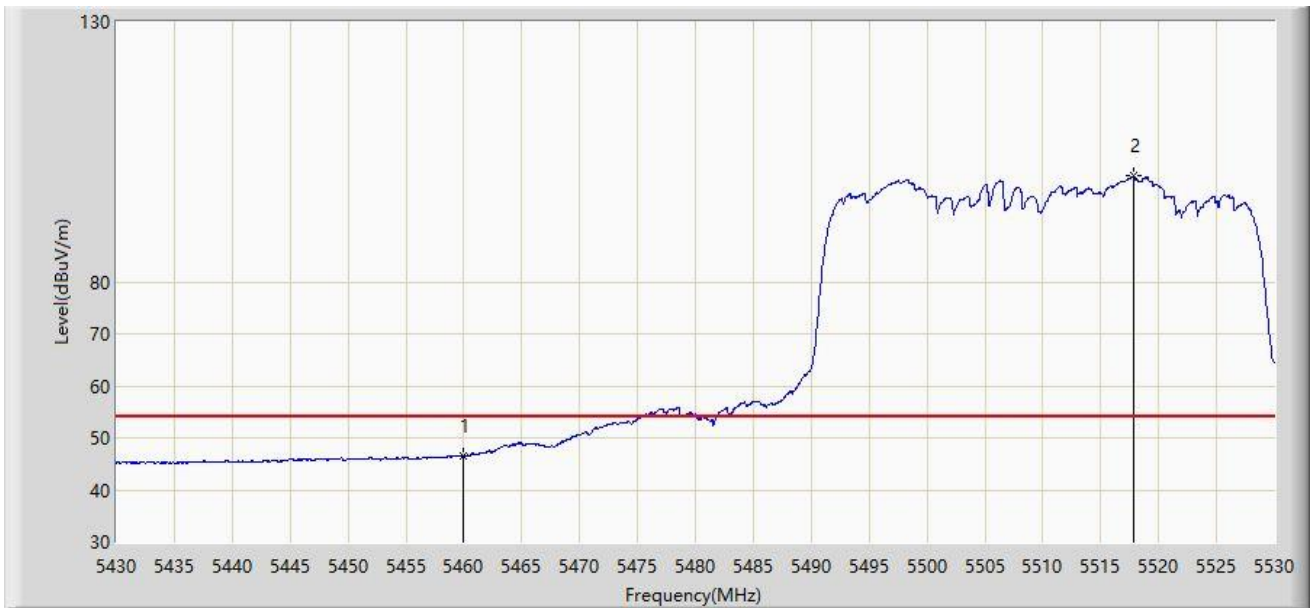

No	Flag	Mark	Frequency (MHz)	Measure Level (dBuV/m)	Reading Level (dBuV)	Margin (dB)	Limit (dBuV/m)	Factor (dB)	Type
1			5460.000	46.592	42.497	-7.408	54.000	4.095	AV
2		*	5517.850	100.399	96.253	N/A	N/A	4.146	AV

Note: Measure Level (dBuV/m) = Reading Level (dBuV) + Factor (dB)

Factor (dB) = Cable Loss (dB) + Antenna Factor (dB/m) - Pre_Amplifier Gain (dB)

Site: AC2	Time: 2019/10/04 - 16:50
Limit: FCC_Part15.209_RSE(3m)	Engineer: Bacon Dong
Probe: BBHA9120D_1-18GHz	Polarity: Horizontal
EUT: OmniAccess Stellar	Power: AC 120V/60Hz
Test Mode: Transmit by 802.11n-HT40 at Channel 5670MHz	

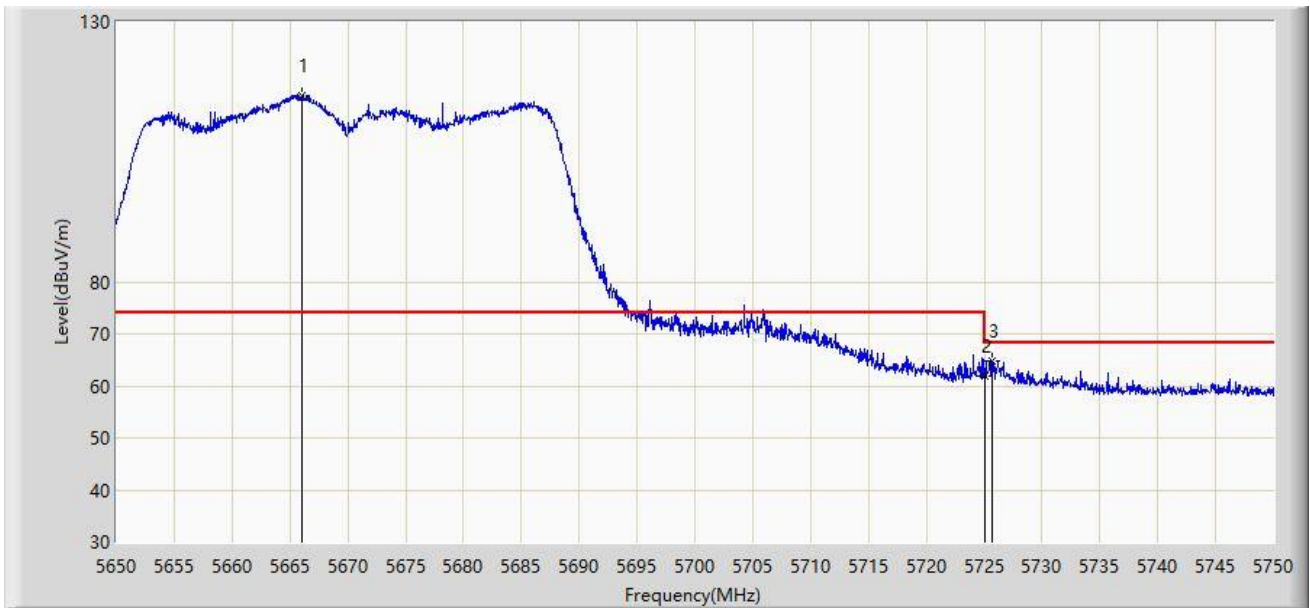

No	Flag	Mark	Frequency (MHz)	Measure Level (dBuV/m)	Reading Level (dBuV)	Margin (dB)	Limit (dBuV/m)	Factor (dB)	Type
1		*	5666.000	115.934	111.226	N/A	N/A	4.709	PK
2			5725.000	61.898	56.877	-6.302	68.200	5.021	PK
3			5725.700	64.733	59.695	-3.467	68.200	5.039	PK

Note: Measure Level (dB μ V/m) = Reading Level (dB μ V) + Factor (dB)

Factor (dB) = Cable Loss (dB) + Antenna Factor (dB/m) - Pre_Amplifier Gain (dB)

Site: AC2	Time: 2019/10/04 - 16:52
Limit: FCC_Part15.209_RSE(3m)	Engineer: Bacon Dong
Probe: BBHA9120D_1-18GHz	Polarity: Vertical
EUT: OmniAccess Stellar	Power: AC 120V/60Hz
Test Mode: Transmit by 802.11n-HT40 at Channel 5670MHz	

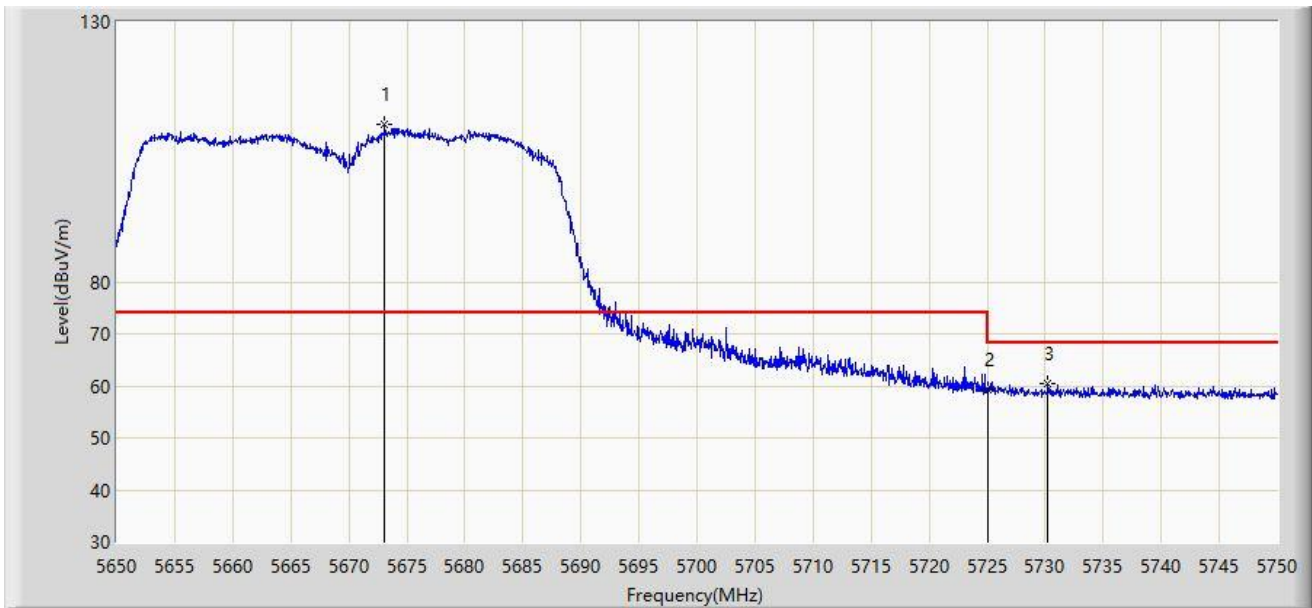

No	Flag	Mark	Frequency (MHz)	Measure Level (dBuV/m)	Reading Level (dBuV)	Margin (dB)	Limit (dBuV/m)	Factor (dB)	Type
1		*	5673.050	110.265	105.429	N/A	N/A	4.837	PK
2			5725.000	59.179	54.158	-9.021	68.200	5.021	PK
3			5730.250	60.525	55.466	-7.675	68.200	5.059	PK

Note: Measure Level (dB μ V/m) = Reading Level (dB μ V) + Factor (dB)

Factor (dB) = Cable Loss (dB) + Antenna Factor (dB/m) - Pre_Amplifier Gain (dB)

Site: AC1	Time: 2020/02/21 - 16:09
Limit: FCC_Part15.209_RSE(3m)	Engineer: Jason Gao
Probe: BBHA9120D_1-18GHz	Polarity: Horizontal
EUT: OmniAccess Stellar	Power: AC 120V/60Hz
Note: Transmit by 802.11ax-HE20 at channel 5320MHz	

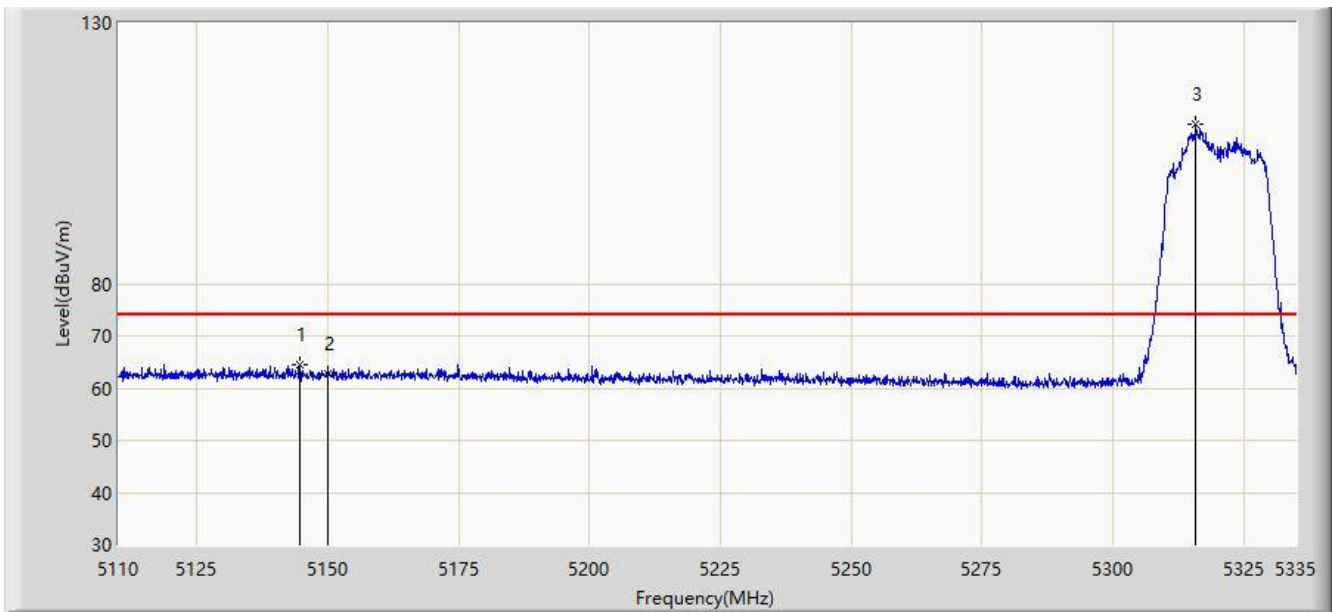

No	Flag	Mark	Frequency (MHz)	Measure Level (dBuV/m)	Reading Level (dBuV)	Margin (dB)	Limit (dBuV/m)	Factor (dB)	Type
1			5144.650	64.404	55.871	-9.596	74.000	8.533	PK
2			5150.000	62.669	54.141	-11.331	74.000	8.528	PK
3		*	5315.875	110.551	102.140	36.551	74.000	8.411	PK

Note: Measure Level (dBμV/m) = Reading Level (dBμV) + Factor (dB)

Factor (dB) = Cable Loss (dB) + Antenna Factor (dB/m) - Pre_Amplifier Gain (dB)

Site: AC1	Time: 2020/02/21 - 16:13
Limit: FCC_Part15.209_RSE(3m)	Engineer: Jason Gao
Probe: BBHA9120D_1-18GHz	Polarity: Horizontal
EUT: OmniAccess Stellar	Power: AC 120V/60Hz
Note: Transmit by 802.11ax-HE20 at channel 5320MHz	

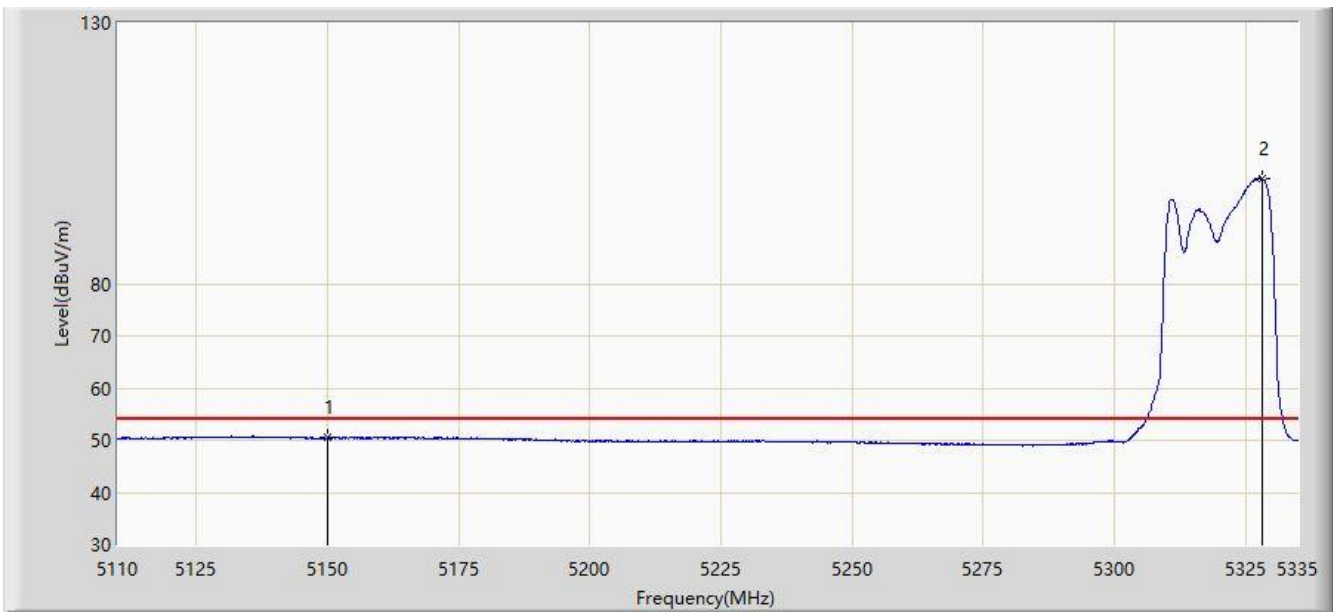

No	Flag	Mark	Frequency (MHz)	Measure Level (dBuV/m)	Reading Level (dBuV)	Margin (dB)	Limit (dBuV/m)	Factor (dB)	Type
1			5150.000	50.463	41.935	-3.537	54.000	8.528	AV
2		*	5328.250	100.185	91.728	46.185	54.000	8.457	AV

Note: Measure Level (dB μ V/m) = Reading Level (dB μ V) + Factor (dB)

Factor (dB) = Cable Loss (dB) + Antenna Factor (dB/m) - Pre_Amplifier Gain (dB)

Site: AC1	Time: 2020/02/21 - 16:15
Limit: FCC_Part15.209_RSE(3m)	Engineer: Jason Gao
Probe: BBHA9120D_1-18GHz	Polarity: Vertical
EUT: OmniAccess Stellar	Power: AC 120V/60Hz
Note: Transmit by 802.11ax-HE20 at channel 5320MHz	

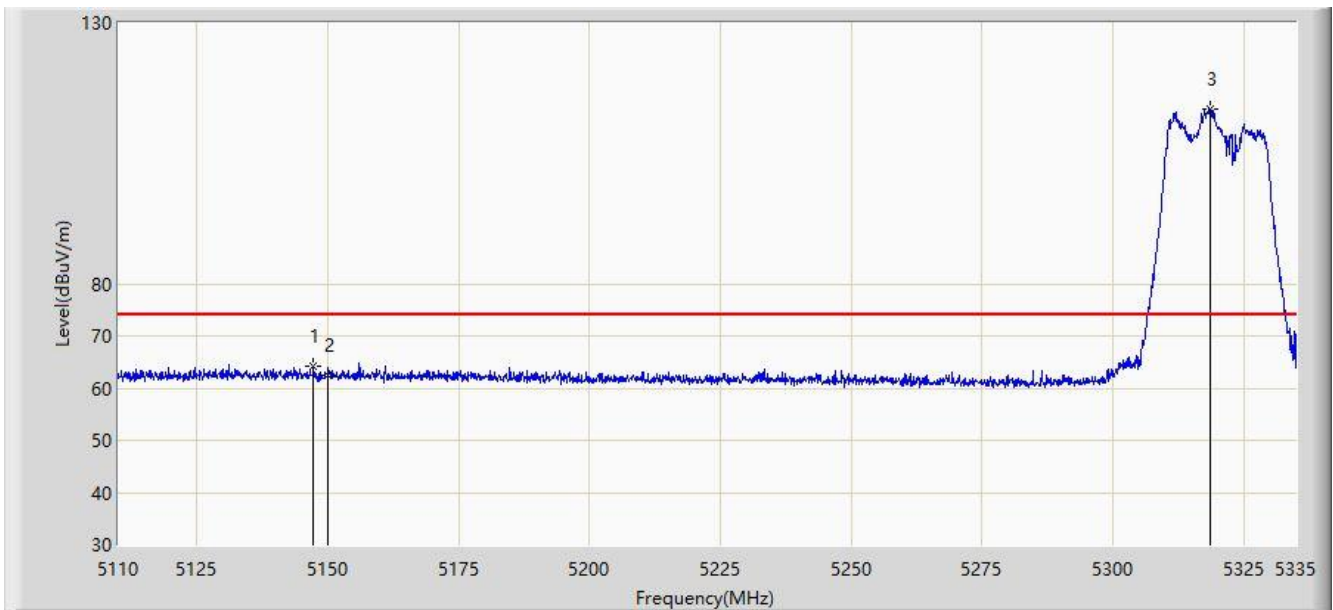

No	Flag	Mark	Frequency (MHz)	Measure Level (dBuV/m)	Reading Level (dBuV)	Margin (dB)	Limit (dBuV/m)	Factor (dB)	Type
1			5147.350	64.180	55.663	-9.820	74.000	8.516	PK
2			5150.000	62.466	53.938	-11.534	74.000	8.528	PK
3		*	5318.575	113.547	105.115	39.547	74.000	8.432	PK

Note: Measure Level (dB μ V/m) = Reading Level (dB μ V) + Factor (dB)

Factor (dB) = Cable Loss (dB) + Antenna Factor (dB/m) - Pre_Amplifier Gain (dB)

Site: AC1	Time: 2020/02/21 - 16:17
Limit: FCC_Part15.209_RSE(3m)	Engineer: Jason Gao
Probe: BBHA9120D_1-18GHz	Polarity: Vertical
EUT: OmniAccess Stellar	Power: AC 120V/60Hz
Note: Transmit by 802.11ax-HE20 at channel 5320MHz	

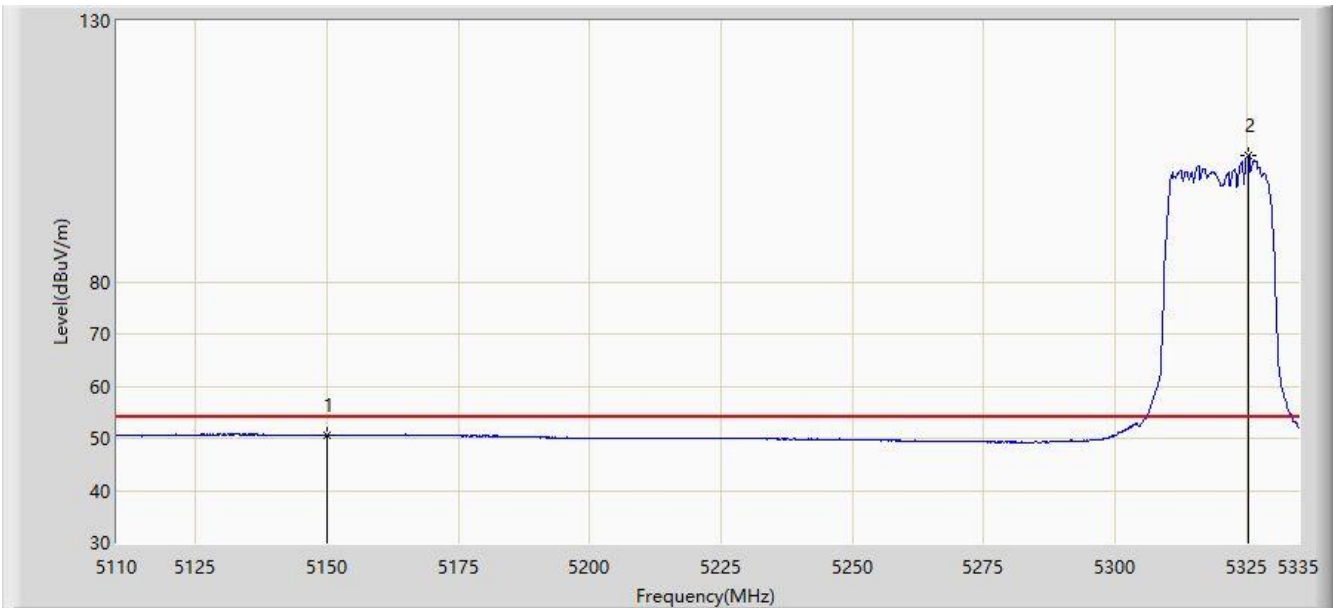

No	Flag	Mark	Frequency (MHz)	Measure Level (dBuV/m)	Reading Level (dBuV)	Margin (dB)	Limit (dBuV/m)	Factor (dB)	Type
1			5150.000	50.586	42.058	-3.414	54.000	8.528	AV
2		*	5325.437	104.078	95.629	50.078	54.000	8.450	AV

Note: Measure Level (dB μ V/m) = Reading Level (dB μ V) + Factor (dB)

Factor (dB) = Cable Loss (dB) + Antenna Factor (dB/m) - Pre_Amplifier Gain (dB)

Site: AC1	Time: 2019/11/04 - 18:58
Limit: FCC_Part15.209_RSE(3m)	Engineer: Tyler Yuan
Probe: BBHA9120D_1-18GHz	Polarity: Horizontal
EUT: OmniAccess Stellar	Power: AC 120V/60Hz
Note: Transmit by 802.11ax-HE20 at channel 5320MHz	

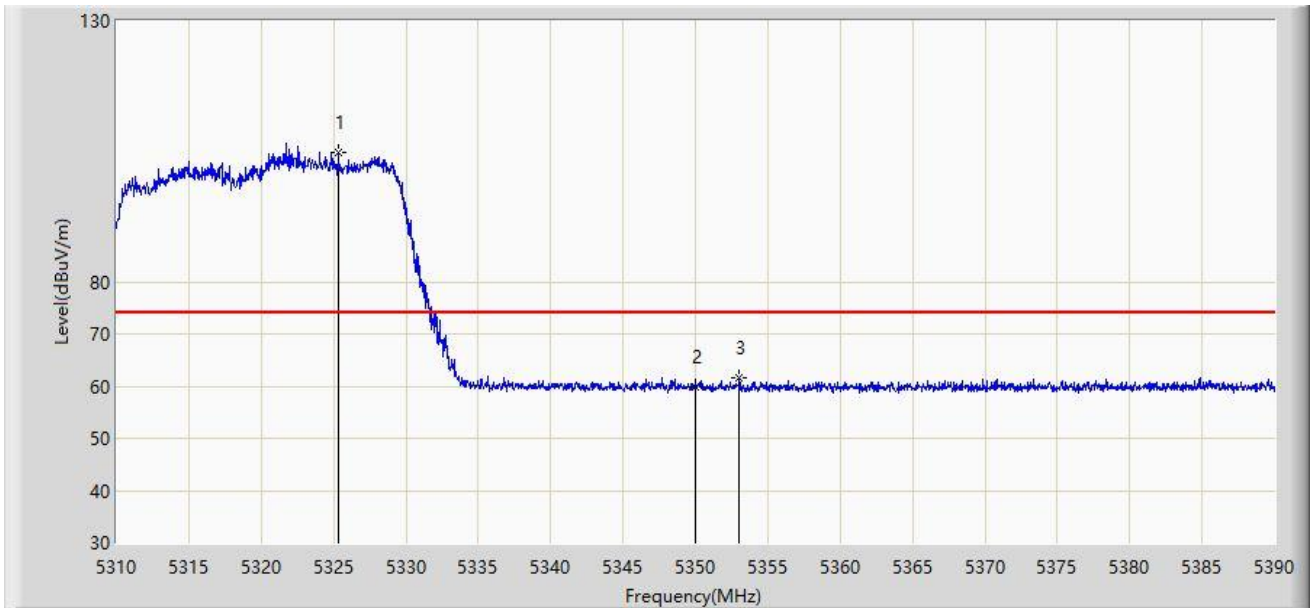

No	Flag	Mark	Frequency (MHz)	Measure Level (dBuV/m)	Reading Level (dBuV)	Margin (dB)	Limit (dBuV/m)	Factor (dB)	Type
1		*	5325.320	104.764	114.291	N/A	N/A	-9.527	PK
2			5350.000	59.845	69.315	-14.155	74.000	-9.469	PK
3			5353.040	61.499	70.976	-12.501	74.000	-9.477	PK

Note: Measure Level (dB μ V/m) = Reading Level (dB μ V) + Factor (dB)

Factor (dB) = Cable Loss (dB) + Antenna Factor (dB/m) - Pre_Amplifier Gain (dB)

Site: AC1	Time: 2019/11/04 - 19:00
Limit: FCC_Part15.209_RSE(3m)	Engineer: Tyler Yuan
Probe: BBHA9120D_1-18GHz	Polarity: Horizontal
EUT: OmniAccess Stellar	Power: AC 120V/60Hz
Note: Transmit by 802.11ax-HE20 at channel 5320MHz	

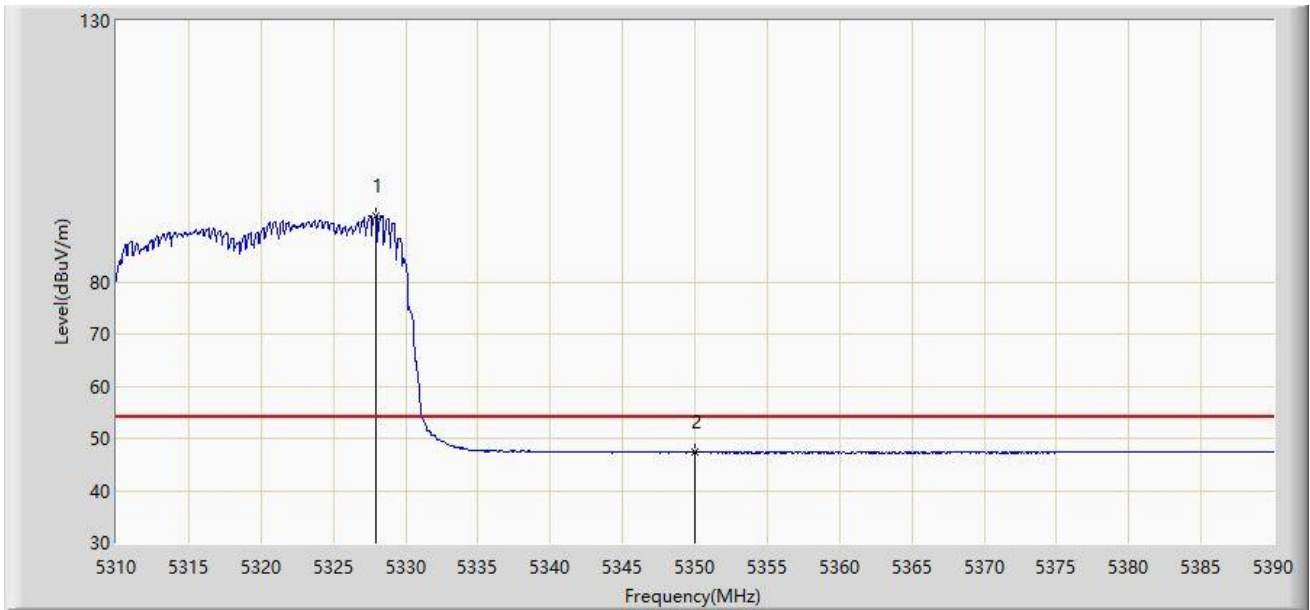

No	Flag	Mark	Frequency (MHz)	Measure Level (dBuV/m)	Reading Level (dBuV)	Margin (dB)	Limit (dBuV/m)	Factor (dB)	Type
1		*	5327.960	92.587	102.083	N/A	N/A	-9.496	AV
2			5350.000	47.345	56.815	-6.655	54.000	-9.469	AV

Note: Measure Level (dBuV/m) = Reading Level (dBuV) + Factor (dB)

Factor (dB) = Cable Loss (dB) + Antenna Factor (dB/m) - Pre_Amplifier Gain (dB)

Site: AC1	Time: 2019/11/04 - 19:01
Limit: FCC_Part15.209_RSE(3m)	Engineer: Tyler Yuan
Probe: BBHA9120D_1-18GHz	Polarity: Vertical
EUT: OmniAccess Stellar	Power: AC 120V/60Hz
Note: Transmit by 802.11ax-HE20 at channel 5320MHz	

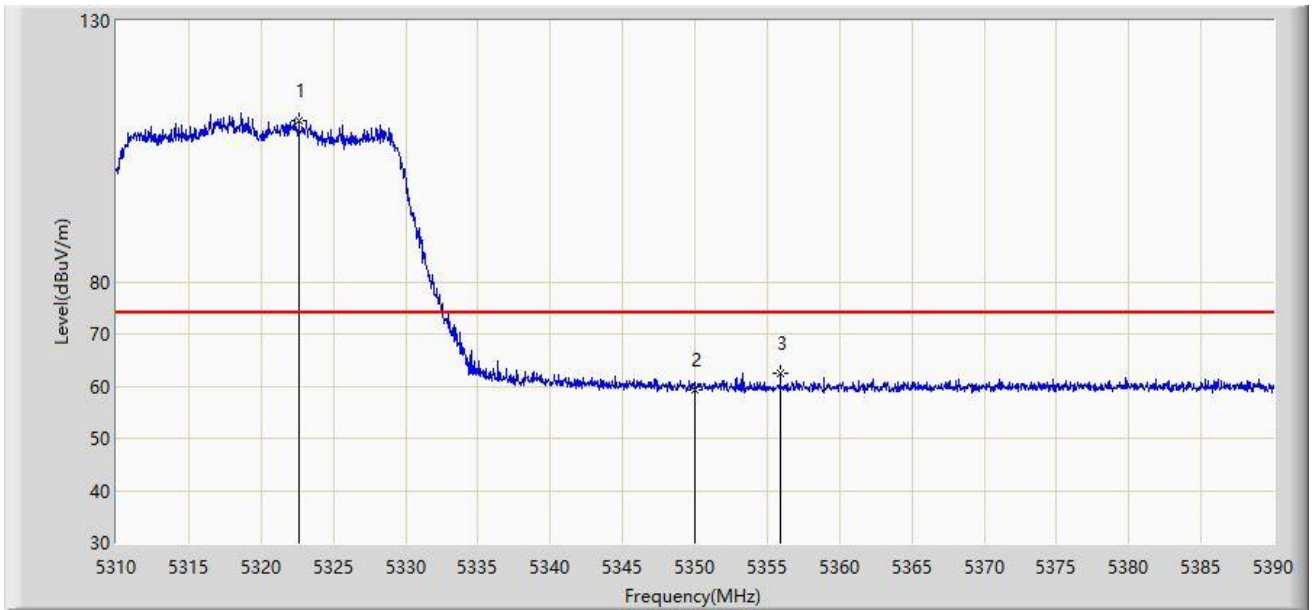

No	Flag	Mark	Frequency (MHz)	Measure Level (dBuV/m)	Reading Level (dBuV)	Margin (dB)	Limit (dBuV/m)	Factor (dB)	Type
1		*	5322.640	110.927	120.485	N/A	N/A	-9.558	PK
2			5350.000	59.331	68.801	-14.669	74.000	-9.469	PK
3			5355.920	62.412	71.888	-11.588	74.000	-9.476	PK

Note: Measure Level (dB μ V/m) = Reading Level (dB μ V) + Factor (dB)

Factor (dB) = Cable Loss (dB) + Antenna Factor (dB/m) - Pre_Amplifier Gain (dB)

Site: AC1	Time: 2019/11/04 - 19:02
Limit: FCC_Part15.209_RSE(3m)	Engineer: Tyler Yuan
Probe: BBHA9120D_1-18GHz	Polarity: Vertical
EUT: OmniAccess Stellar	Power: AC 120V/60Hz
Note: Transmit by 802.11ax-HE20 at channel 5320MHz	

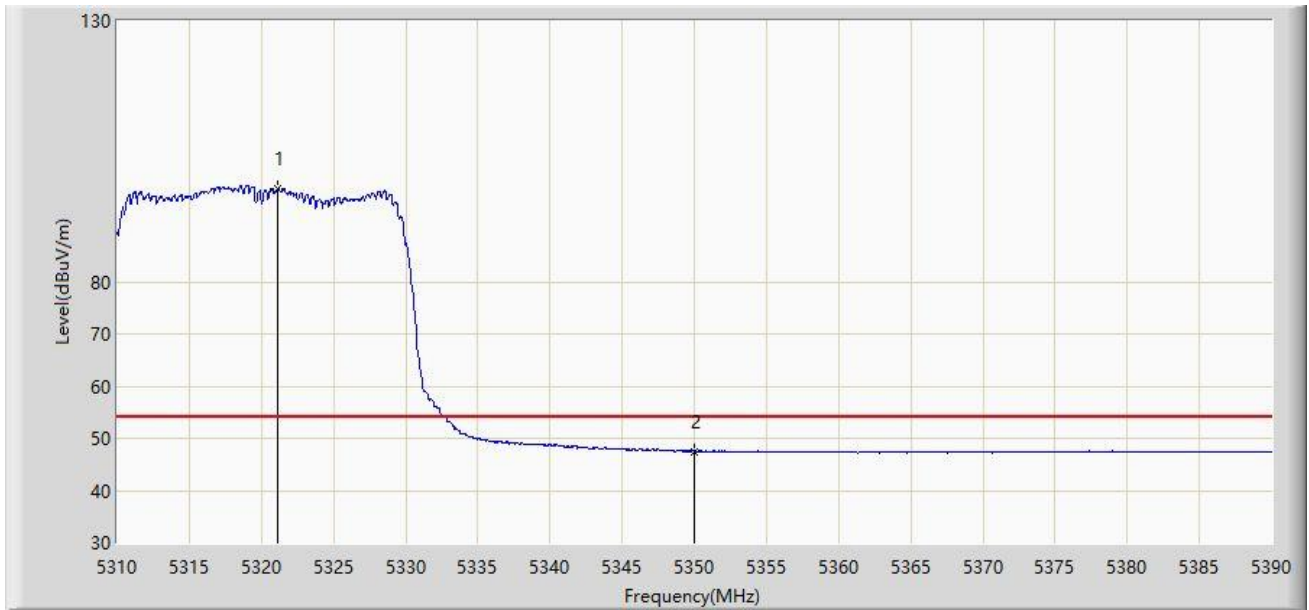

No	Flag	Mark	Frequency (MHz)	Measure Level (dBuV/m)	Reading Level (dBuV)	Margin (dB)	Limit (dBuV/m)	Factor (dB)	Type
1		*	5321.160	97.918	107.493	N/A	N/A	-9.576	AV
2			5350.000	47.505	56.975	-6.495	54.000	-9.469	AV

Note: Measure Level (dB μ V/m) = Reading Level (dB μ V) + Factor (dB)

Factor (dB) = Cable Loss (dB) + Antenna Factor (dB/m) - Pre_Amplifier Gain (dB)

Site: AC1	Time: 2019/11/04 - 19:03
Limit: FCC_Part15.209_RSE(3m)	Engineer: Tyler Yuan
Probe: BBHA9120D_1-18GHz	Polarity: Horizontal
EUT: OmniAccess Stellar	Power: AC 120V/60Hz
Note: Transmit by 802.11ax-HE20 at channel 5500MHz	

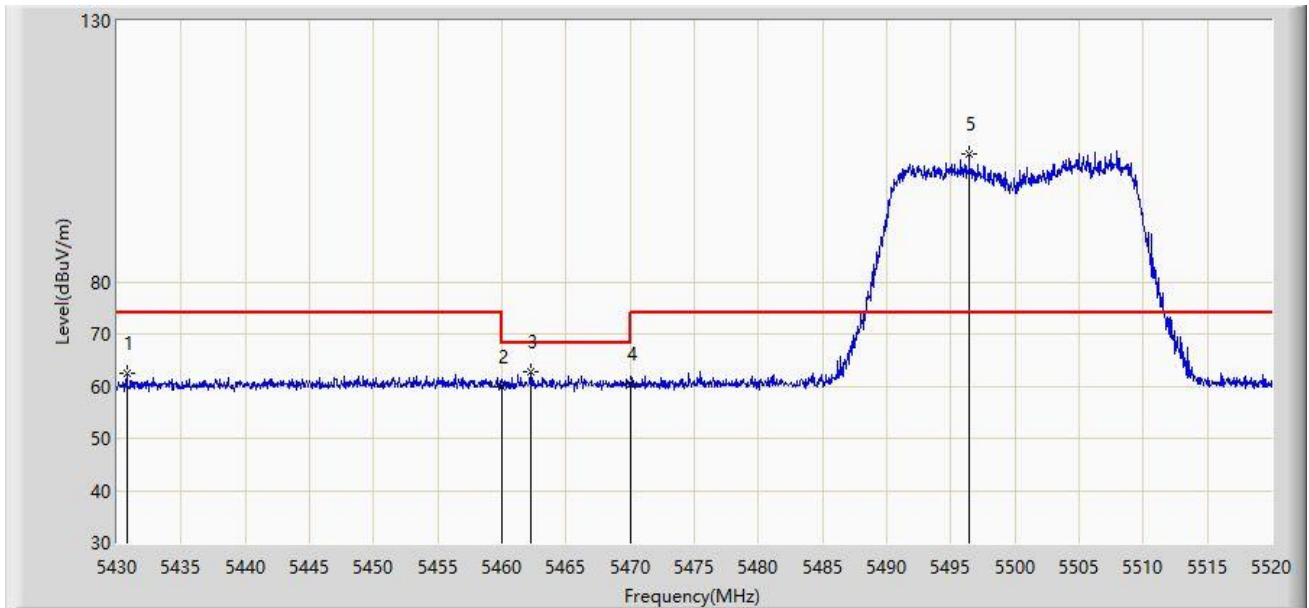

No	Flag	Mark	Frequency (MHz)	Measure Level (dBuV/m)	Reading Level (dBuV)	Margin (dB)	Limit (dBuV/m)	Factor (dB)	Type
1			5430.765	62.455	71.704	-11.545	74.000	-9.249	PK
2			5460.000	59.808	68.788	-14.192	74.000	-8.980	PK
3			5462.310	62.806	71.810	-5.394	68.200	-9.004	PK
4			5470.000	60.460	69.542	-7.740	68.200	-9.082	PK
5		*	5496.420	104.385	113.364	N/A	N/A	-8.979	PK

Note: Measure Level (dB μ V/m) = Reading Level (dB μ V) + Factor (dB)

Factor (dB) = Cable Loss (dB) + Antenna Factor (dB/m) - Pre_Amplifier Gain (dB)

Site: AC1	Time: 2019/11/04 - 19:06
Limit: FCC_Part15.209_RSE(3m)	Engineer: Tyler Yuan
Probe: BBHA9120D_1-18GHz	Polarity: Horizontal
EUT: OmniAccess Stellar	Power: AC 120V/60Hz
Note: Transmit by 802.11ax-HE20 at channel 5500MHz	

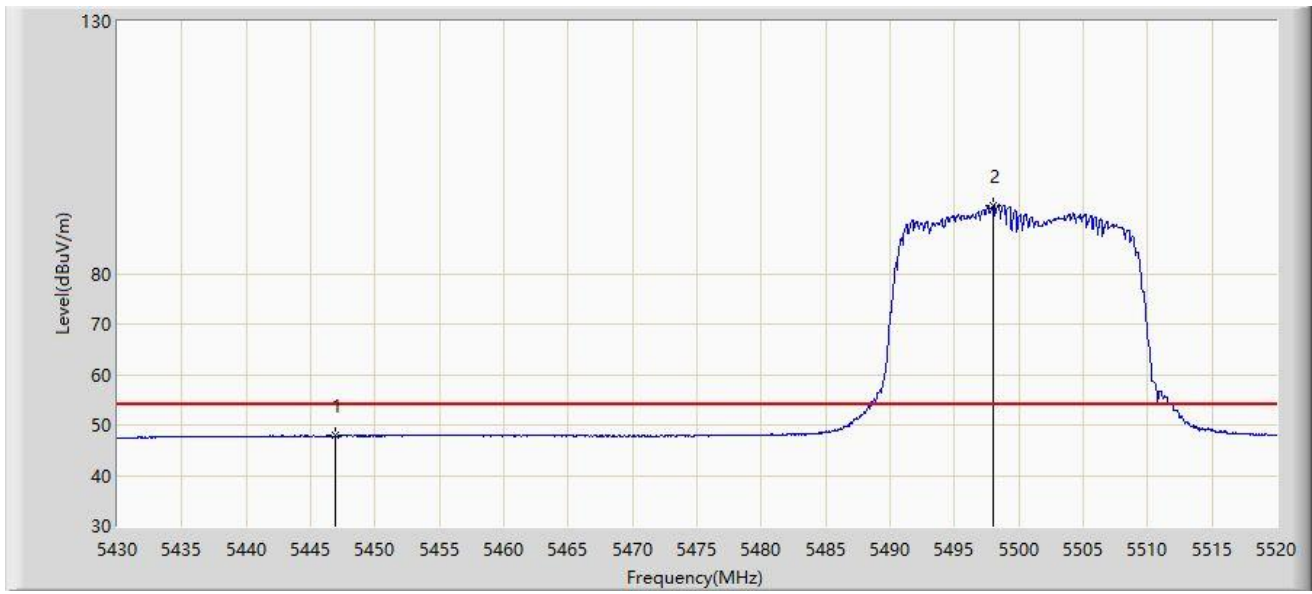

No	Flag	Mark	Frequency (MHz)	Measure Level (dBuV/m)	Reading Level (dBuV)	Margin (dB)	Limit (dBuV/m)	Factor (dB)	Type
1			5446.875	47.867	56.870	-6.133	54.000	-9.002	AV
2		*	5498.040	93.513	102.494	39.513	54.000	-8.980	AV

Note: Measure Level (dBμV/m) = Reading Level (dBμV) + Factor (dB)

Factor (dB) = Cable Loss (dB) + Antenna Factor (dB/m) - Pre_Amplifier Gain (dB)

Site: AC1	Time: 2019/11/04 - 19:06
Limit: FCC_Part15.209_RSE(3m)	Engineer: Tyler Yuan
Probe: BBHA9120D_1-18GHz	Polarity: Vertical
EUT: OmniAccess Stellar	Power: AC 120V/60Hz
Note: Transmit by 802.11ax-HE20 at channel 5500MHz	

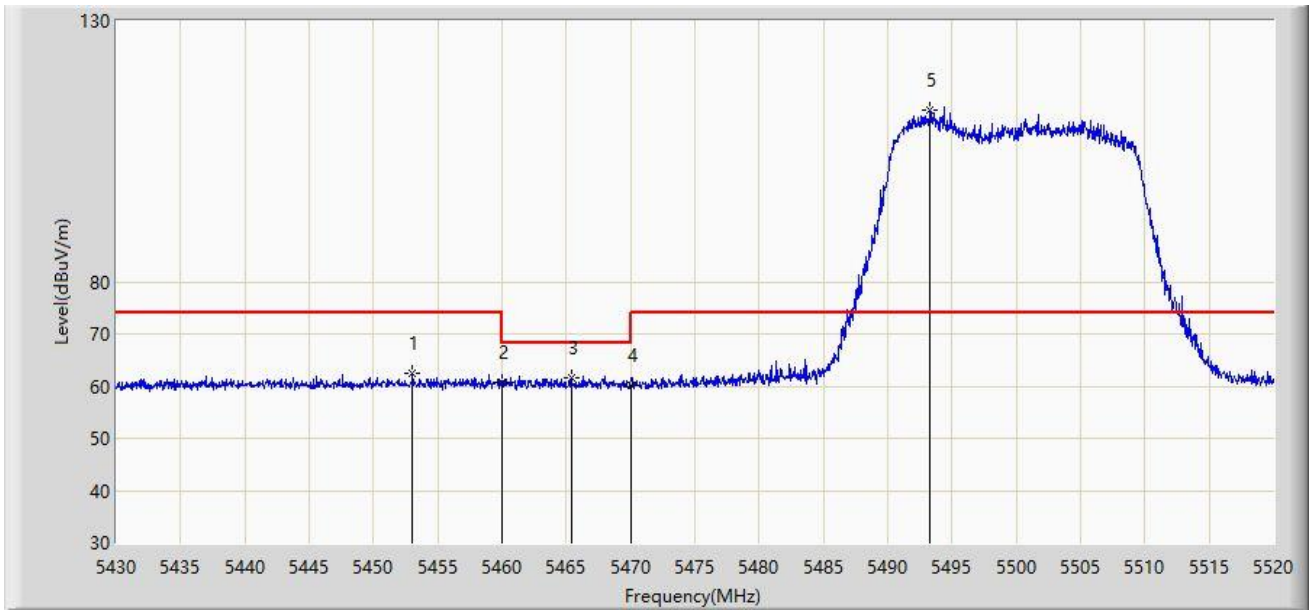

No	Flag	Mark	Frequency (MHz)	Measure Level (dBuV/m)	Reading Level (dBuV)	Margin (dB)	Limit (dBuV/m)	Factor (dB)	Type
1			5453.040	62.585	71.515	-11.415	74.000	-8.930	PK
2			5460.000	60.740	69.720	-13.260	74.000	-8.980	PK
3			5465.415	61.646	70.681	-6.554	68.200	-9.036	PK
4			5470.000	60.277	69.359	-7.923	68.200	-9.082	PK
5		*	5493.270	112.817	121.794	N/A	N/A	-8.978	PK

Note: Measure Level (dBuV/m) = Reading Level (dBuV) + Factor (dB)

Factor (dB) = Cable Loss (dB) + Antenna Factor (dB/m) - Pre_Amplifier Gain (dB)

Site: AC1	Time: 2019/11/04 - 19:08
Limit: FCC_Part15.209_RSE(3m)	Engineer: Tyler Yuan
Probe: BBHA9120D_1-18GHz	Polarity: Vertical
EUT: OmniAccess Stellar	Power: AC 120V/60Hz
Note: Transmit by 802.11ax-HE20 at channel 5500MHz	

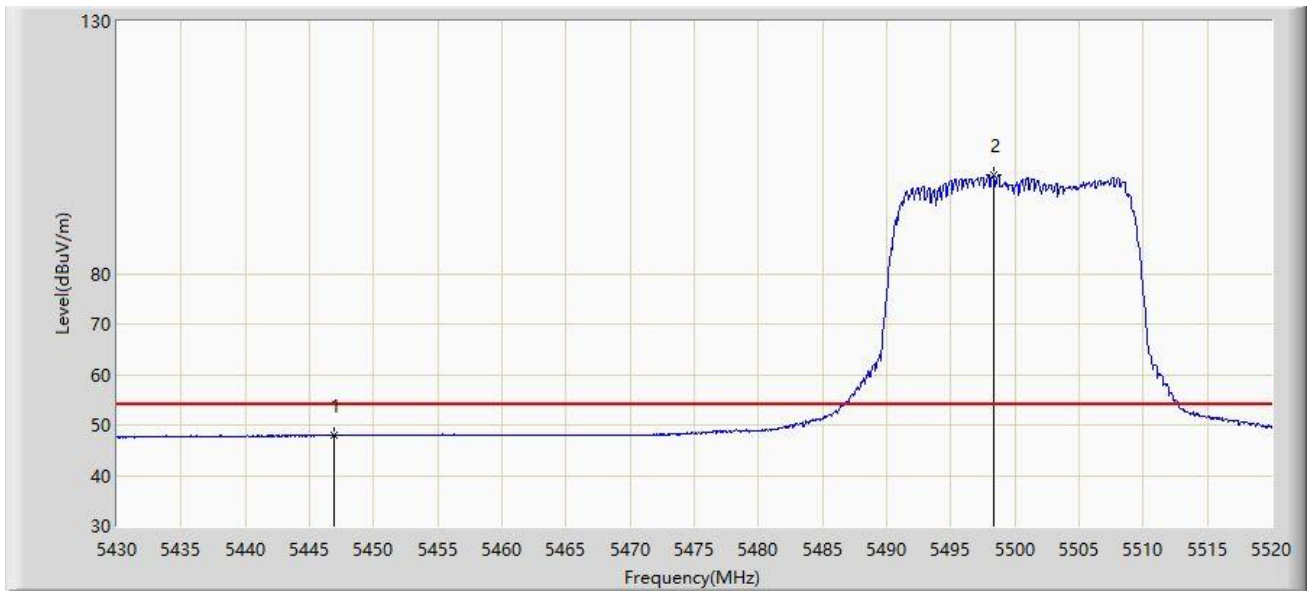

No	Flag	Mark	Frequency (MHz)	Measure Level (dBuV/m)	Reading Level (dBuV)	Margin (dB)	Limit (dBuV/m)	Factor (dB)	Type
1			5446.875	47.885	56.888	-6.115	54.000	-9.002	AV
2		*	5498.355	99.442	108.423	45.442	54.000	-8.981	AV

Note: Measure Level (dB μ V/m) = Reading Level (dB μ V) + Factor (dB)

Factor (dB) = Cable Loss (dB) + Antenna Factor (dB/m) - Pre_Amplifier Gain (dB)

Site: AC1	Time: 2019/11/04 - 19:10
Limit: FCC_Part15.209_RSE(3m)	Engineer: Tyler Yuan
Probe: BBHA9120D_1-18GHz	Polarity: Horizontal
EUT: OmniAccess Stellar	Power: AC 120V/60Hz
Note: Transmit by 802.11ax-HE20 at channel 5700MHz	

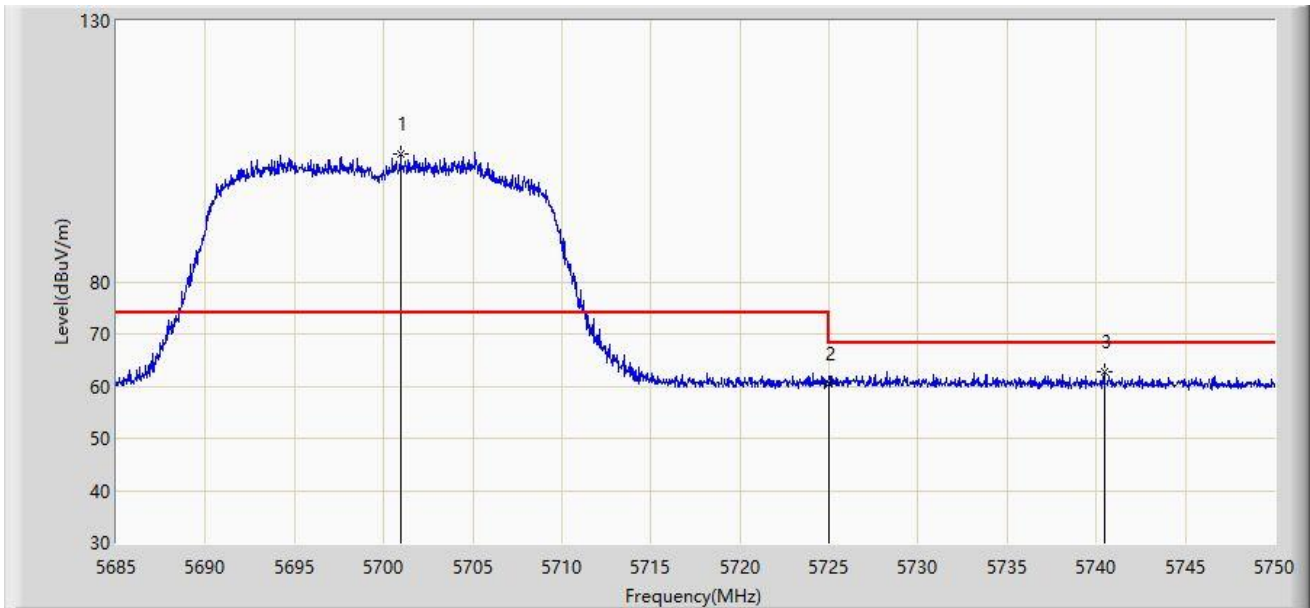

No	Flag	Mark	Frequency (MHz)	Measure Level (dBuV/m)	Reading Level (dBuV)	Margin (dB)	Limit (dBuV/m)	Factor (dB)	Type
1		*	5700.958	104.615	113.983	N/A	N/A	-9.368	PK
2			5725.000	60.512	69.624	-7.688	68.200	-9.112	PK
3			5740.445	62.641	71.910	-5.559	68.200	-9.269	PK

Note: Measure Level (dB μ V/m) = Reading Level (dB μ V) + Factor (dB)

Factor (dB) = Cable Loss (dB) + Antenna Factor (dB/m) - Pre_Amplifier Gain (dB)

Site: AC1	Time: 2019/11/04 - 19:12
Limit: FCC_Part15.209_RSE(3m)	Engineer: Tyler Yuan
Probe: BBHA9120D_1-18GHz	Polarity: Vertical
EUT: OmniAccess Stellar	Power: AC 120V/60Hz
Note: Transmit by 802.11ax-HE20 at channel 5700MHz	

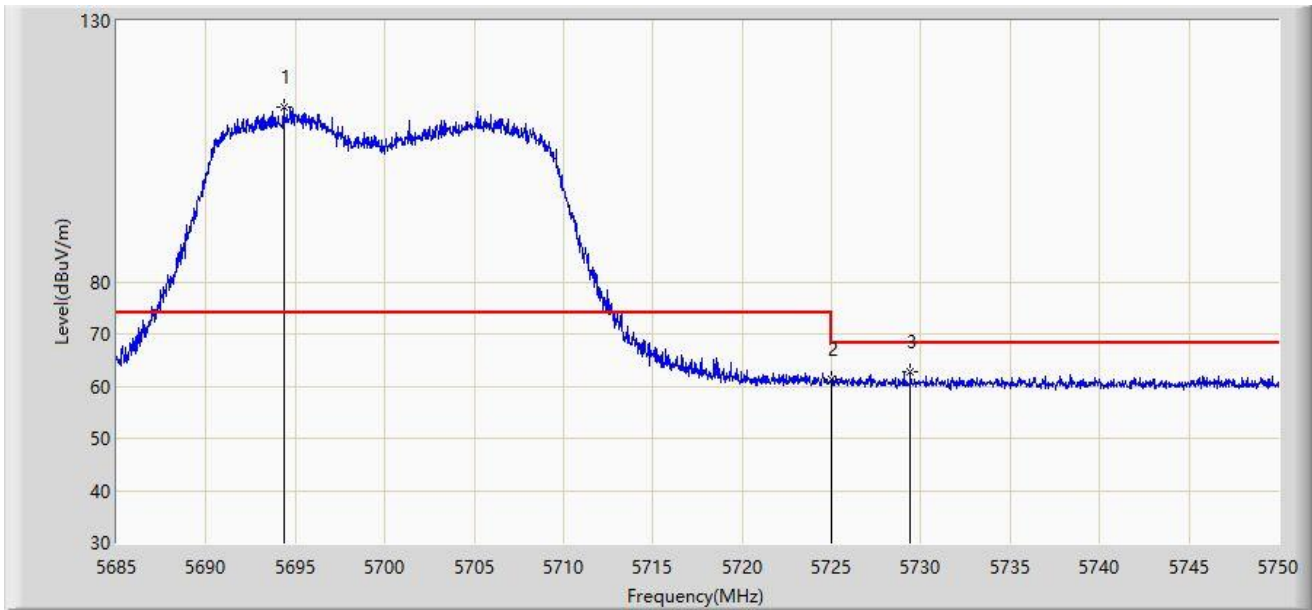

No	Flag	Mark	Frequency (MHz)	Measure Level (dBuV/m)	Reading Level (dBuV)	Margin (dB)	Limit (dBuV/m)	Factor (dB)	Type
1		*	5694.360	113.606	122.947	N/A	N/A	-9.340	PK
2			5725.000	61.198	70.310	-7.002	68.200	-9.112	PK
3			5729.428	62.668	71.804	-5.532	68.200	-9.135	PK

Note: Measure Level (dB μ V/m) = Reading Level (dB μ V) + Factor (dB)

Factor (dB) = Cable Loss (dB) + Antenna Factor (dB/m) - Pre_Amplifier Gain (dB)

Site: AC1	Time: 2020/02/21 - 16:19
Limit: FCC_Part15.209_RSE(3m)	Engineer: Jason Gao
Probe: BBHA9120D_1-18GHz	Polarity: Horizontal
EUT: OmniAccess Stellar	Power: AC 120V/60Hz
Note: Transmit by 802.11ax-HE40 at channel 5310MHz	

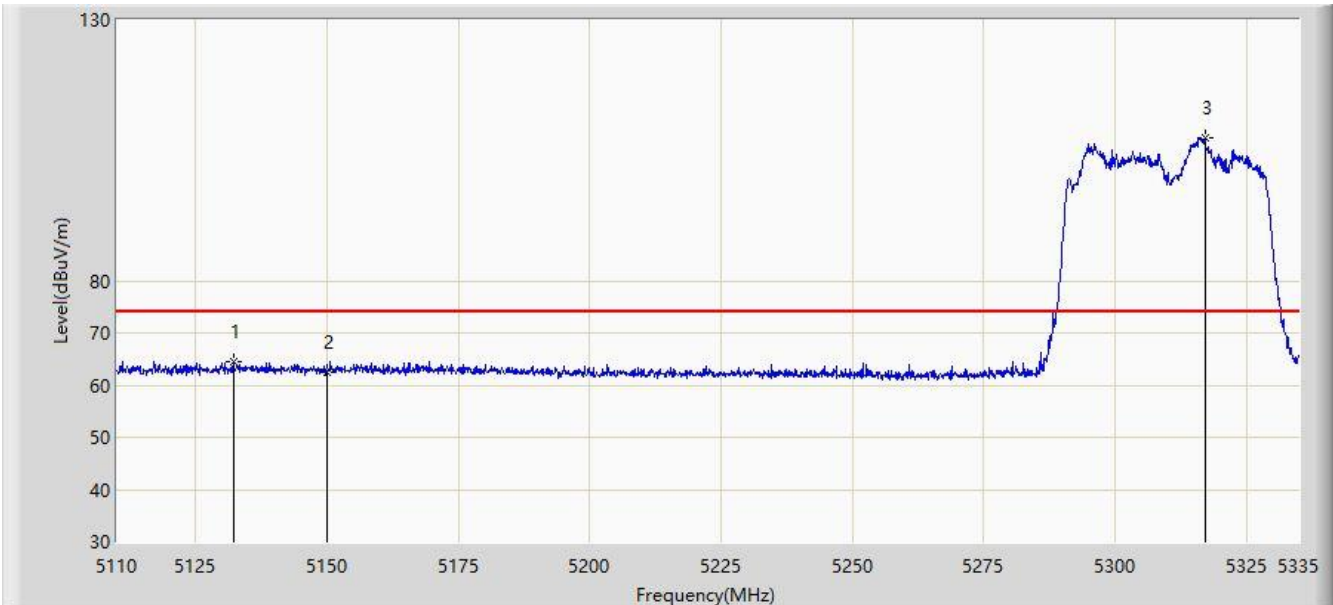

No	Flag	Mark	Frequency (MHz)	Measure Level (dBuV/m)	Reading Level (dBuV)	Margin (dB)	Limit (dBuV/m)	Factor (dB)	Type
1			5132.275	64.541	55.932	-9.459	74.000	8.610	PK
2			5150.000	62.590	54.062	-11.410	74.000	8.528	PK
3		*	5317.225	107.369	98.946	33.369	74.000	8.423	PK

Note: Measure Level (dB μ V/m) = Reading Level (dB μ V) + Factor (dB)

Factor (dB) = Cable Loss (dB) + Antenna Factor (dB/m) - Pre_Amplifier Gain (dB)

Site: AC1	Time: 2020/02/21 - 16:23
Limit: FCC_Part15.209_RSE(3m)	Engineer: Jason Gao
Probe: BBHA9120D_1-18GHz	Polarity: Horizontal
EUT: OmniAccess Stellar	Power: AC 120V/60Hz
Note: Transmit by 802.11ax-HE40 at channel 5310MHz	

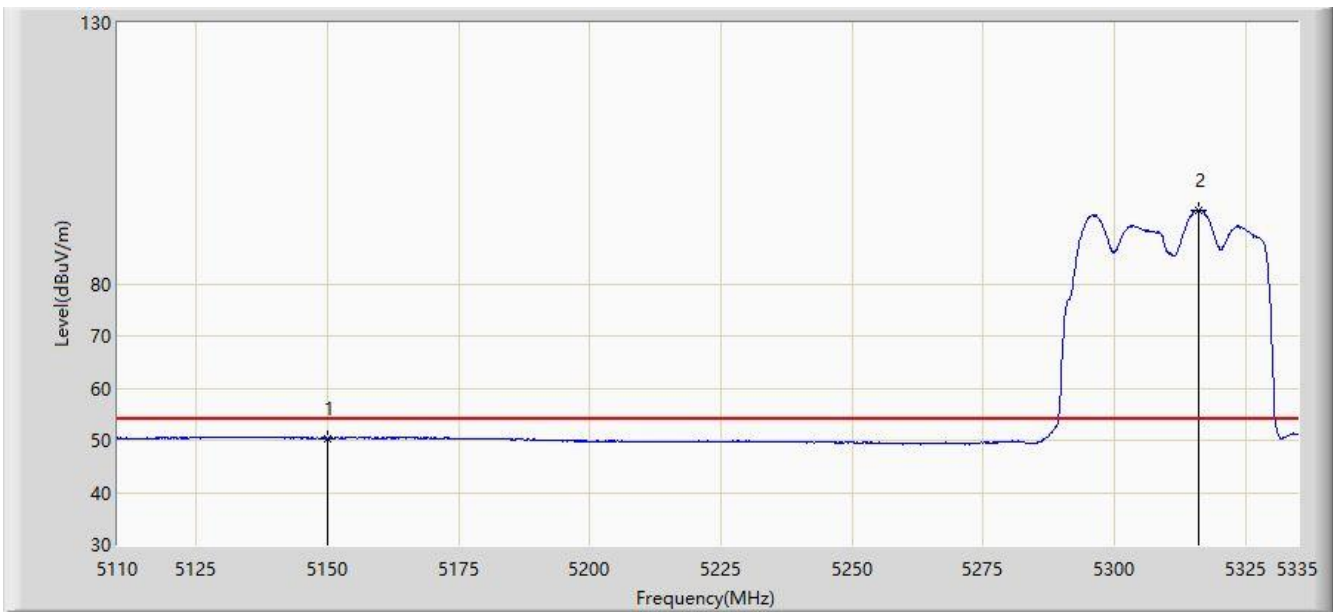

No	Flag	Mark	Frequency (MHz)	Measure Level (dBuV/m)	Reading Level (dBuV)	Margin (dB)	Limit (dBuV/m)	Factor (dB)	Type
1			5150.000	50.420	41.892	-3.580	54.000	8.528	AV
2		*	5316.100	94.195	85.782	40.195	54.000	8.413	AV

Note: Measure Level (dB μ V/m) = Reading Level (dB μ V) + Factor (dB)

Factor (dB) = Cable Loss (dB) + Antenna Factor (dB/m) - Pre_Amplifier Gain (dB)

Site: AC1	Time: 2020/02/21 - 16:25
Limit: FCC_Part15.209_RSE(3m)	Engineer: Jason Gao
Probe: BBHA9120D_1-18GHz	Polarity: Vertical
EUT: OmniAccess Stellar	Power: AC 120V/60Hz
Note: Transmit by 802.11ax-HE40 at channel 5310MHz	

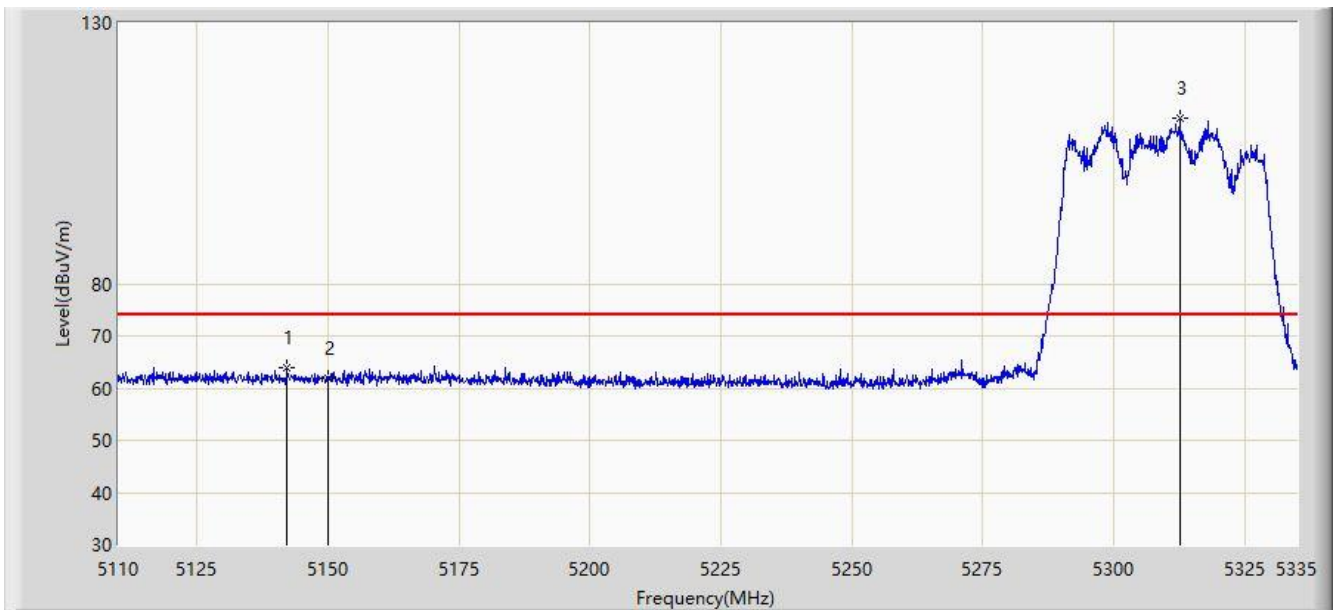

No	Flag	Mark	Frequency (MHz)	Measure Level (dBuV/m)	Reading Level (dBuV)	Margin (dB)	Limit (dBuV/m)	Factor (dB)	Type
1			5142.175	64.016	55.468	-9.984	74.000	8.548	PK
2			5150.000	61.762	53.234	-12.238	74.000	8.528	PK
3		*	5312.612	111.640	103.258	37.640	74.000	8.382	PK

Note: Measure Level (dB μ V/m) = Reading Level (dB μ V) + Factor (dB)

Factor (dB) = Cable Loss (dB) + Antenna Factor (dB/m) - Pre_Amplifier Gain (dB)

Site: AC1	Time: 2020/02/21 - 16:25
Limit: FCC_Part15.209_RSE(3m)	Engineer: Jason Gao
Probe: BBHA9120D_1-18GHz	Polarity: Vertical
EUT: OmniAccess Stellar	Power: AC 120V/60Hz
Note: Transmit by 802.11ax-HE40 at channel 5310MHz	

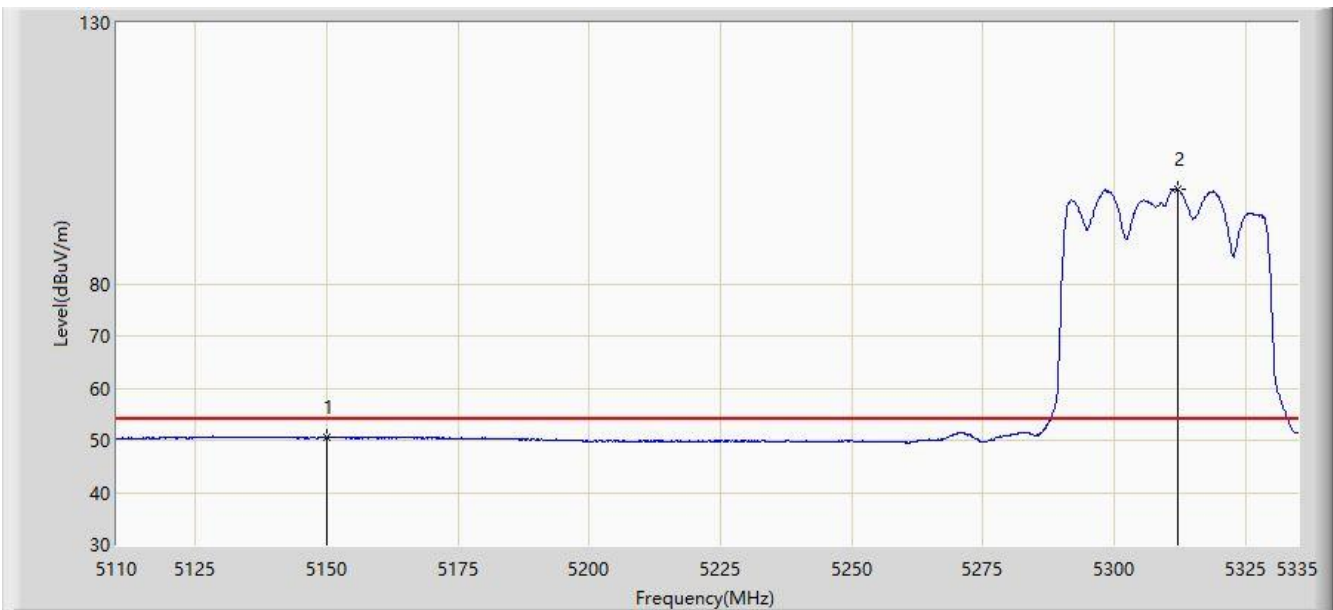

No	Flag	Mark	Frequency (MHz)	Measure Level (dBuV/m)	Reading Level (dBuV)	Margin (dB)	Limit (dBuV/m)	Factor (dB)	Type
1			5150.000	50.481	41.953	-3.519	54.000	8.528	AV
2		*	5312.163	98.030	89.652	44.030	54.000	8.378	AV

Note: Measure Level (dB μ V/m) = Reading Level (dB μ V) + Factor (dB)

Factor (dB) = Cable Loss (dB) + Antenna Factor (dB/m) - Pre_Amplifier Gain (dB)