

### Channel 11 (2462MHz)

#### 100kHz PSD reference Level



#### High Band Edge



#### Spurious Emission





### Channel 09 (2452MHz)

#### 100kHz PSD reference Level



#### High Band Edge



#### Spurious Emission

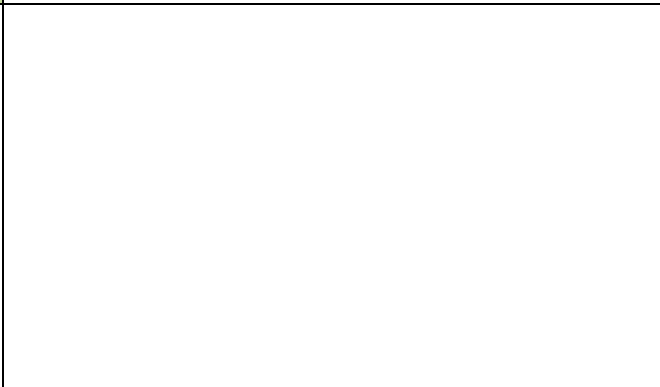

## 6.6. Radiated Spurious Emission Measurement

### 6.6.1. Test Limit

All out of band emissions appearing in a restricted band as specified in Section 15.205 of the Title 47 CFR must not exceed the limits shown in Table per Section 15.209.

FCC Part 15 Subpart C Paragraph 15.209		
Frequency (MHz)	Field Strength (uV/m)	Measured Distance (Meters)
0.009 – 0.490	2400/F (kHz)	300
0.490 – 1.705	24000/F (kHz)	30
1.705 – 30	30	30
30 – 88	100	3
88 – 216	150	3
216 – 960	200	3
Above 960	500	3

### 6.6.2. Test Procedure Used

ANSI C63.10 Section 6.3 (General Requirements)

ANSI C63.10 Section 6.4 (Standard test method below 30MHz)

ANSI C63.10 Section 6.5 (Standard test method above 30MHz to 1GHz)

ANSI C63.10 Section 6.6 (Standard test method above 1GHz)

### 6.6.3. Test Setting

#### Peak Field Strength Measurements

1. Analyzer center frequency was set to the frequency of the radiated spurious emission of interest
2. RBW = as specified in Table 1
3. VBW = 3MHz
4. Detector = peak
5. Sweep time = auto couple
6. Trace mode = max hold
7. Trace was allowed to stabilize

**Table 1 – RBW as a function of frequency**

Frequency	RBW
9 ~ 150 kHz	200 ~ 300 Hz
0.15 ~ 30 MHz	9 ~ 10 kHz
30 ~ 1000 MHz	100 ~ 120 kHz
> 1000 MHz	1 MHz

**Average Field Strength Measurements**

1. Analyzer center frequency was set to the frequency of the radiated spurious emission of interest
2. RBW = 1MHz
3. VBW  $\geq$  1/T
4. De As an alternative, the instrument may be set to linear detector mode. Ensure that video filtering is applied in linear voltage domain (rather than in a log or dB domain). Some instruments require linear display mode in order to accomplish this. Others have a setting for Average-VBW Type, which can be set to "Voltage" regardless of the display mode
5. Detector = Peak
6. Sweep time = auto
7. Trace mode = max hold
8. Allow max hold to run for at least 50 times (1/duty cycle) traces

### 6.6.4. Test Setup

#### Below 1GHz Test Setup:

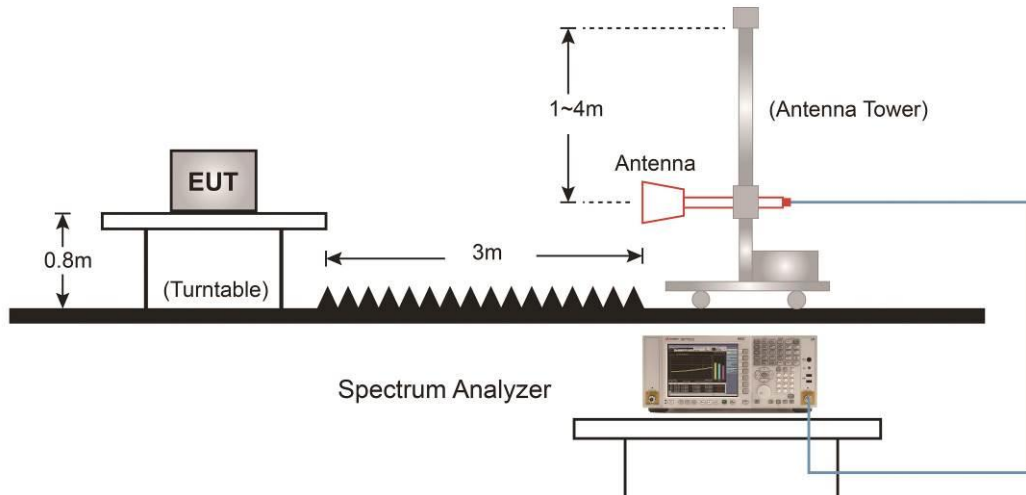

#### Above 1GHz Test Setup:

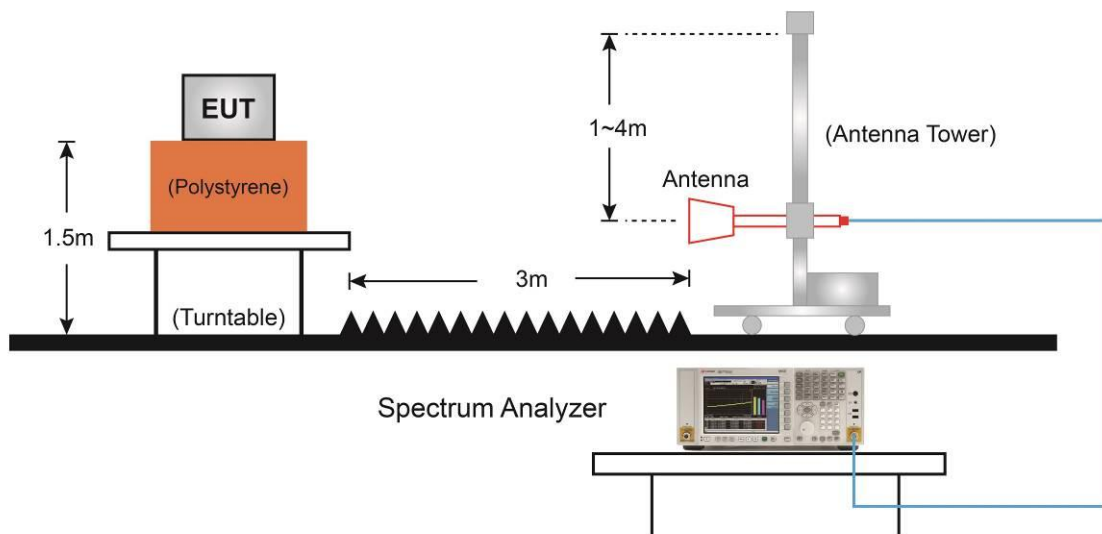

### 6.6.5. Test Result

EUT	OAW-AP1301	Date of Test	2020-10-17
Factor	BBHA 9120D	Temp. / Humidity	25.4°C/48.4%
Polarity	Horizontal	Site / Test Engineer	AC1 / Jay Chiu
Test Mode	Transmit by 802.11b at Channel 2412MHz	Test Voltage	120V/60Hz

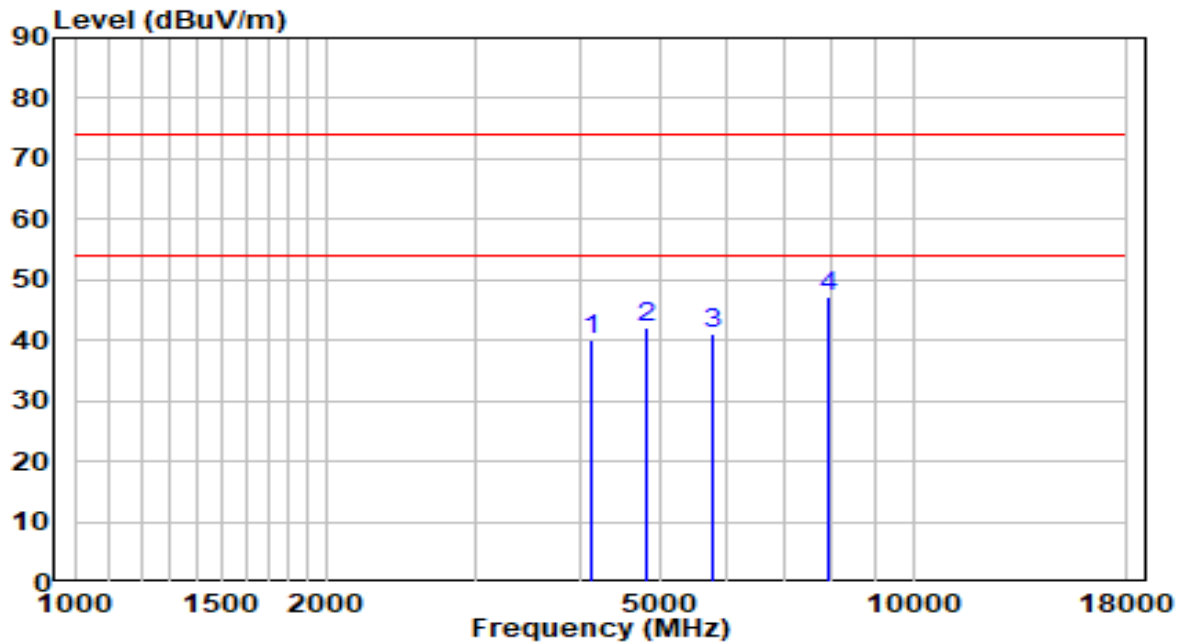

No	Frequency (MHz)	Reading (dBuV)	C.F (dB)	Measurement (dBuV/m)	Margin (dB)	Limit (dBuV/m)	Remark (QP/PK/AV)
1	4128.000	38.80	1.31	40.11	-33.89	74.00	Peak
2	4825.000	38.71	3.33	42.04	-31.96	74.00	Peak
3	5760.000	36.03	5.11	41.14	-32.86	74.00	Peak
4	* 7919.000	34.82	12.40	47.22	-26.78	74.00	Peak

Note:

1. " \*", means this data is the worst emission level.
2. C.F (Correction Factor) = Antenna Factor (dB)+ Cable Loss (dB)– Preamplifier(dB).
3. Measurement(dBuV/m) = Reading(dBuV) + C.F (Correction Factor).
4. The emission levels of other frequencies are very lower than the limit and not show in test report.

EUT	OAW-AP1301	Date of Test	2020-10-17
Factor	BBHA 9120D	Temp. / Humidity	25.4°C/48.4%
Polarity	Vertical	Site / Test Engineer	AC1 / Jay Chiu
Test Mode	Transmit by 802.11b at Channel 2412MHz	Test Voltage	120V/60Hz

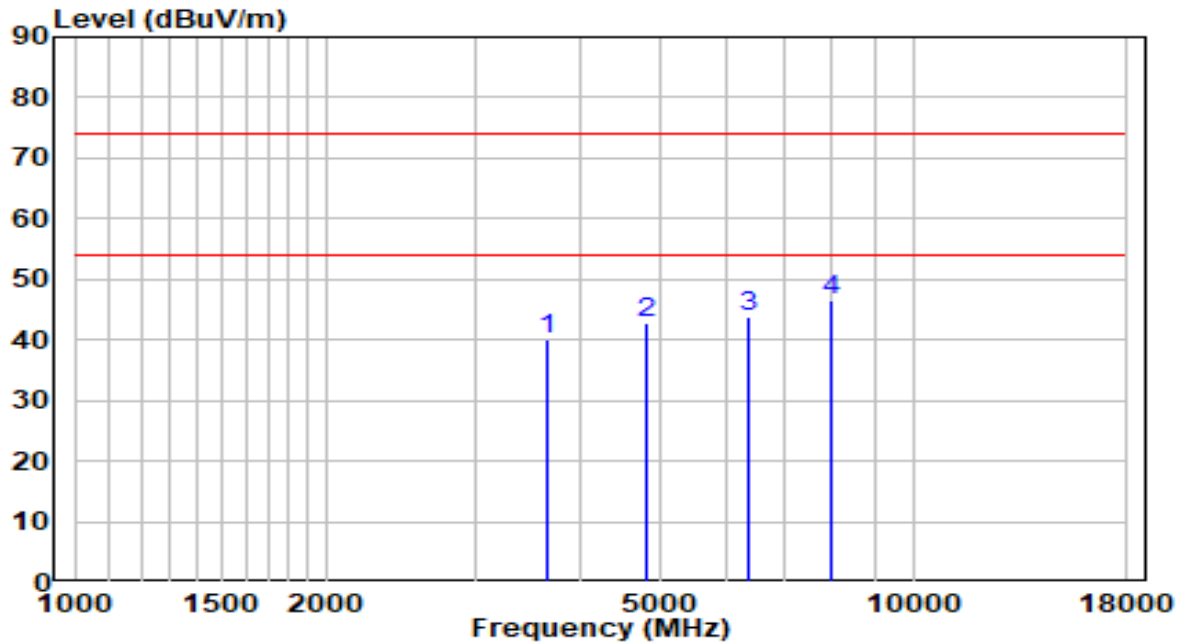

No		Frequency (MHz)	Reading (dBuV)	C.F (dB)	Measurement (dBuV/m)	Margin (dB)	Limit (dBuV/m)	Remark (QP/PK/AV)
1	0.00	3669.000	40.17	-0.26	39.91	-34.09	74.00	Peak
2	0.00	4825.000	39.61	3.33	42.94	-31.06	74.00	Peak
3	0.00	6372.000	36.45	7.53	43.98	-30.02	74.00	Peak
4	*	7987.000	33.99	12.51	46.50	-27.50	74.00	Peak

Note:

1. " \*", means this data is the worst emission level.
2. C.F (Correction Factor) = Antenna Factor (dB)+ Cable Loss (dB)- Preamplifier(dB).
3. Measurement(dBuV/m) = Reading(dBuV) + C.F (Correction Factor).
4. The emission levels of other frequencies are very lower than the limit and not show in test report.



EUT	OAW-AP1301	Date of Test	2020-10-17
Factor	BBHA 9120D	Temp. / Humidity	25.4°C/48.4%
Polarity	Horizontal	Site / Test Engineer	AC1 / Jay Chiu
Test Mode	Transmit by 802.11b at Channel 2437MHz	Test Voltage	120V/60Hz

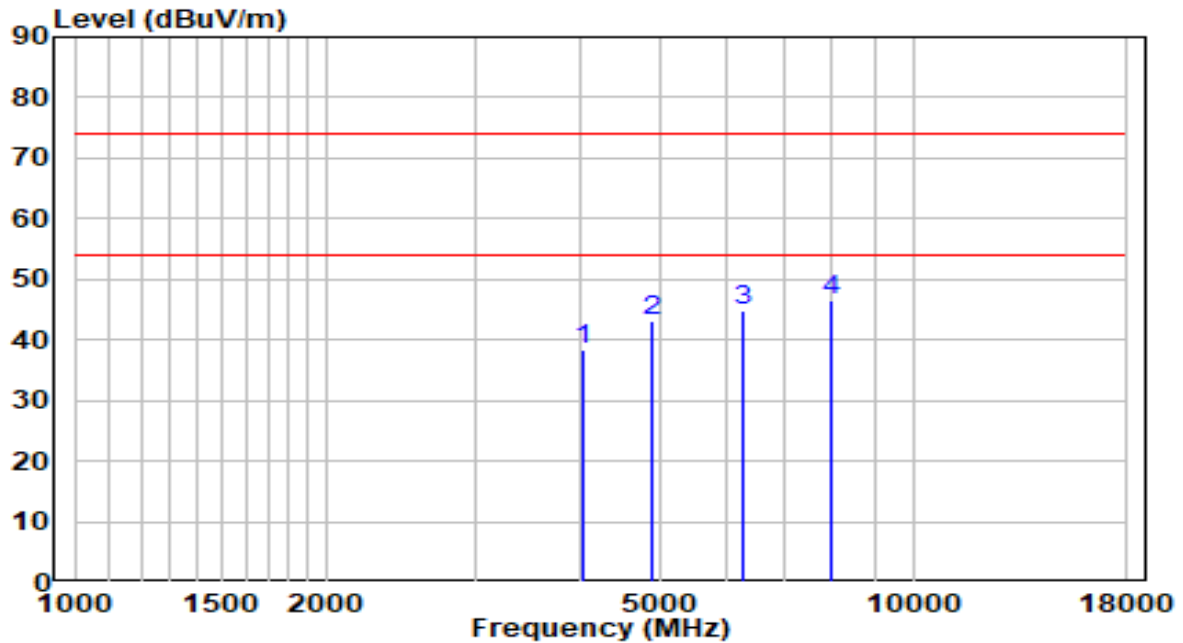

No	Frequency (MHz)	Reading (dBuV)	C.F (dB)	Measurement (dBuV/m)	Margin (dB)	Limit (dBuV/m)	Remark (QP/PK/AV)
1	4026.000	37.25	0.97	38.22	-35.78	74.00	Peak
2	4876.000	39.58	3.45	43.03	-30.97	74.00	Peak
3	6253.000	37.70	7.01	44.70	-29.30	74.00	Peak
4	* 7987.000	34.16	12.51	46.67	-27.33	74.00	Peak

Note:

1. " \*", means this data is the worst emission level.
2. C.F (Correction Factor) = Antenna Factor (dB)+ Cable Loss (dB)– Preamplifier(dB).
3. Measurement(dBuV/m) = Reading(dBuV) + C.F (Correction Factor).
4. The emission levels of other frequencies are very lower than the limit and not show in test report.

EUT	OAW-AP1301	Date of Test	2020-10-17
Factor	BBHA 9120D	Temp. / Humidity	25.4°C/48.4%
Polarity	Vertical	Site / Test Engineer	AC1 / Jay Chiu
Test Mode	Transmit by 802.11b at Channel 2437MHz	Test Voltage	120V/60Hz

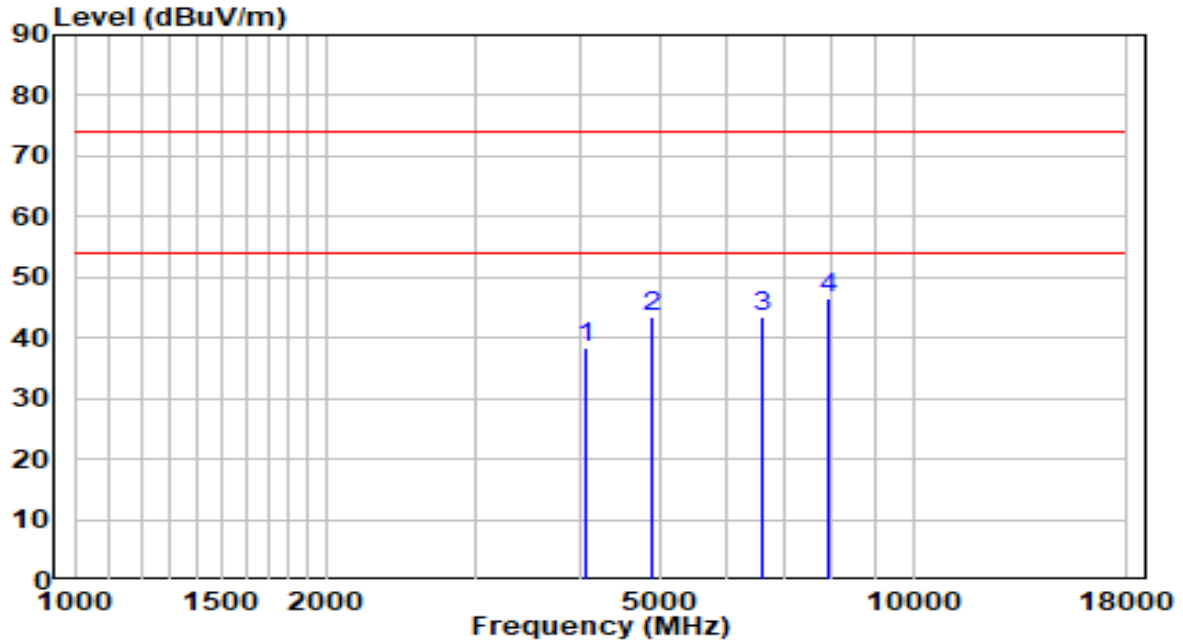

No	Frequency (MHz)	Reading (dBuV)	C.F (dB)	Measurement (dBuV/m)	Margin (dB)	Limit (dBuV/m)	Remark (QP/PK/AV)
1	4060.000	37.34	1.08	38.42	-35.58	74.00	Peak
2	4876.000	40.07	3.45	43.52	-30.48	74.00	Peak
3	6610.000	34.72	8.58	43.30	-30.70	74.00	Peak
4	* 7919.000	34.15	12.40	46.55	-27.45	74.00	Peak

Note:

1. " \*", means this data is the worst emission level.
2. C.F (Correction Factor) = Antenna Factor (dB)+ Cable Loss (dB)– Preamplifier(dB).
3. Measurement(dBuV/m) = Reading(dBuV) + C.F (Correction Factor).
4. The emission levels of other frequencies are very lower than the limit and not show in test report.

EUT	OAW-AP1301	Date of Test	2020-10-17
Factor	BBHA 9120D	Temp. / Humidity	25.4°C/48.4%
Polarity	Horizontal	Site / Test Engineer	AC1 / Jay Chiu
Test Mode	Transmit by 802.11b at Channel 2462MHz	Test Voltage	120V/60Hz

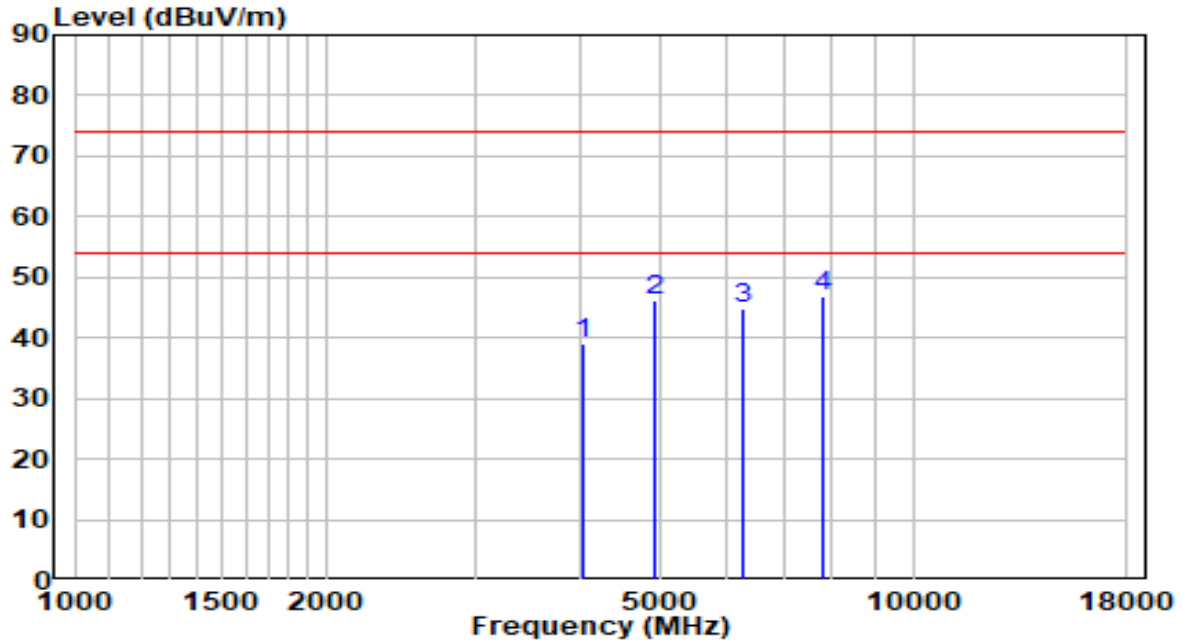

No	Frequency (MHz)	Reading (dBuV)	C.F (dB)	Measurement (dBuV/m)	Margin (dB)	Limit (dBuV/m)	Remark (QP/PK/AV)
1	4043.000	38.11	1.02	39.14	-34.86	74.00	Peak
2	4927.000	42.66	3.57	46.24	-27.76	74.00	Peak
3	6253.000	37.88	7.01	44.89	-29.11	74.00	Peak
4	* 7817.000	34.55	12.23	46.78	-27.22	74.00	Peak

Note:

1. " \*", means this data is the worst emission level.
2. C.F (Correction Factor) = Antenna Factor (dB)+ Cable Loss (dB)– Preamplifier(dB).
3. Measurement(dBuV/m) = Reading(dBuV) + C.F (Correction Factor).
4. The emission levels of other frequencies are very lower than the limit and not show in test report.

EUT	OAW-AP1301	Date of Test	2020-10-17
Factor	BBHA 9120D	Temp. / Humidity	25.4°C/48.4%
Polarity	Vertical	Site / Test Engineer	AC1 / Jay Chiu
Test Mode	Transmit by 802.11b at Channel 2462MHz	Test Voltage	120V/60Hz

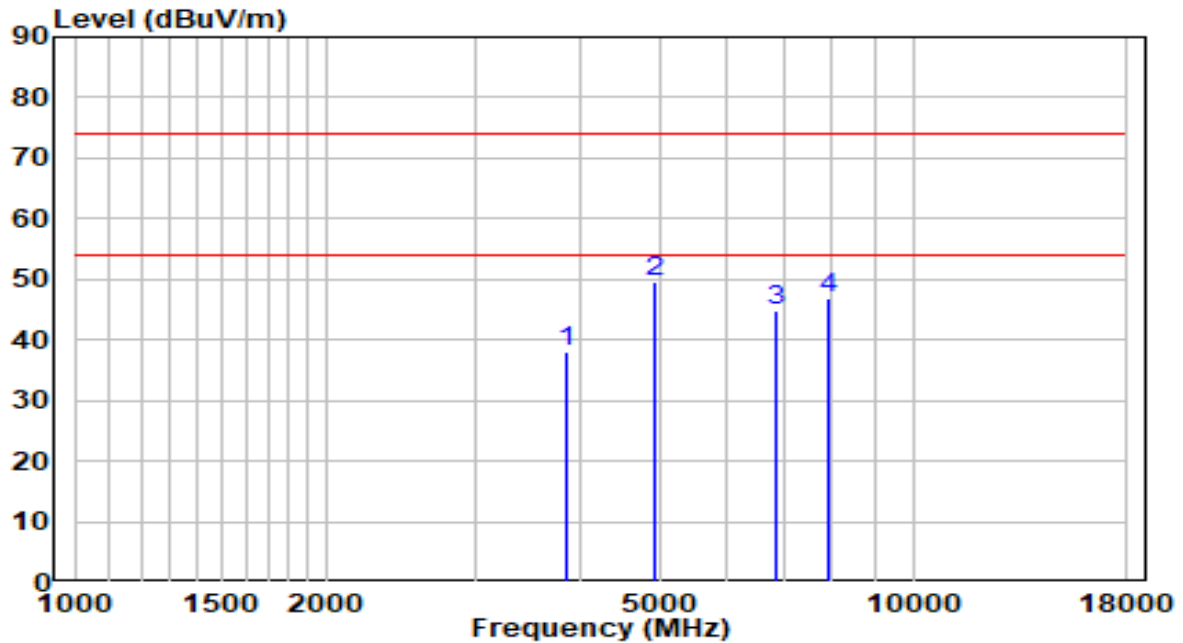

No	Frequency (MHz)	Reading (dBuV)	C.F (dB)	Measurement (dBuV/m)	Margin (dB)	Limit (dBuV/m)	Remark (QP/PK/AV)
1	3873.000	37.58	0.44	38.03	-35.97	74.00	Peak
2	* 4927.000	45.94	3.57	49.51	-24.49	74.00	Peak
3	6882.000	35.08	9.78	44.86	-29.14	74.00	Peak
4	7902.000	34.34	12.37	46.71	-27.29	74.00	Peak

Note:

- "\*", means this data is the worst emission level.
- C.F (Correction Factor) = Antenna Factor (dB)+ Cable Loss (dB)– Preamplifier(dB).
- Measurement(dBuV/m) = Reading(dBuV) + C.F (Correction Factor).
- The emission levels of other frequencies are very lower than the limit and not show in test report.

EUT	OAW-AP1301	Date of Test	2020-10-17
Factor	BBHA 9120D	Temp. / Humidity	25.4°C/48.4%
Polarity	Horizontal	Site / Test Engineer	AC1 / Jay Chiu
Test Mode	Transmit by 802.11g at Channel 2412MHz	Test Voltage	120V/60Hz

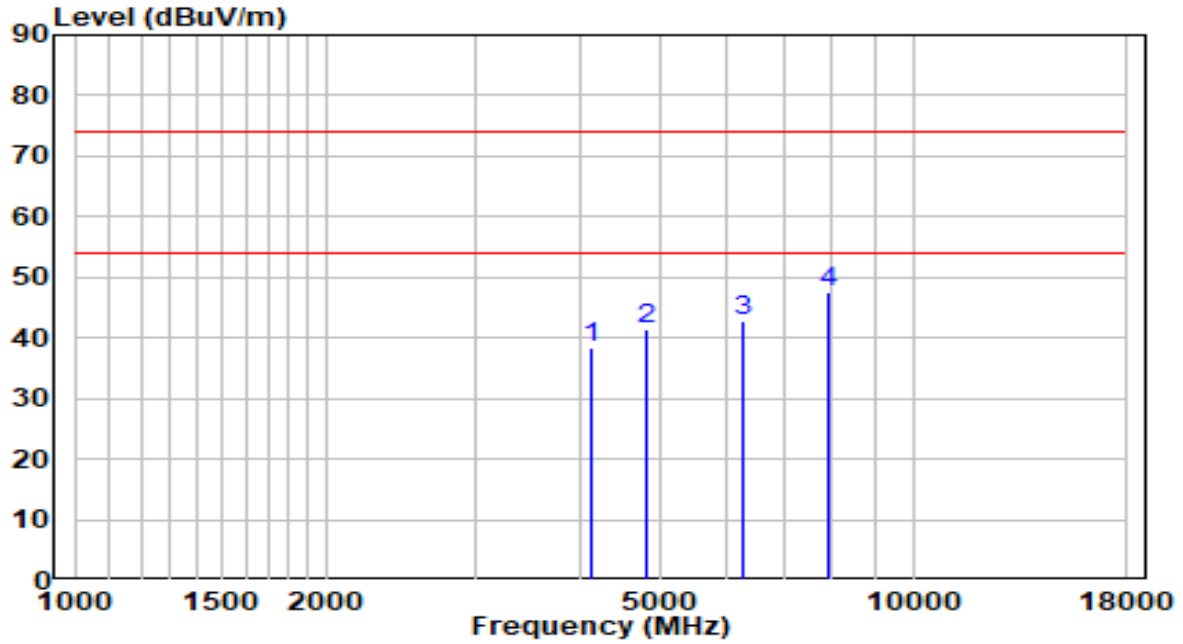

No	Frequency (MHz)	Reading (dBuV)	C.F (dB)	Measurement (dBuV/m)	Margin (dB)	Limit (dBuV/m)	Remark (QP/PK/AV)
1	4145.000	36.95	1.36	38.32	-35.68	74.00	Peak
2	4825.000	38.14	3.33	41.47	-32.53	74.00	Peak
3	6253.000	35.93	7.01	42.94	-31.06	74.00	Peak
4	* 7936.000	34.97	12.43	47.40	-26.60	74.00	Peak

Note:

1. " \*", means this data is the worst emission level.
2. C.F (Correction Factor) = Antenna Factor (dB)+ Cable Loss (dB)– Preamplifier(dB).
3. Measurement(dBuV/m) = Reading(dBuV) + C.F (Correction Factor).
- 4.The emission levels of other frequencies are very lower than the limit and not show in test report.

EUT	OAW-AP1301	Date of Test	2020-10-17
Factor	BBHA 9120D	Temp. / Humidity	25.4°C/48.4%
Polarity	Vertical	Site / Test Engineer	AC1 / Jay Chiu
Test Mode	Transmit by 802.11g at Channel 2412MHz	Test Voltage	120V/60Hz

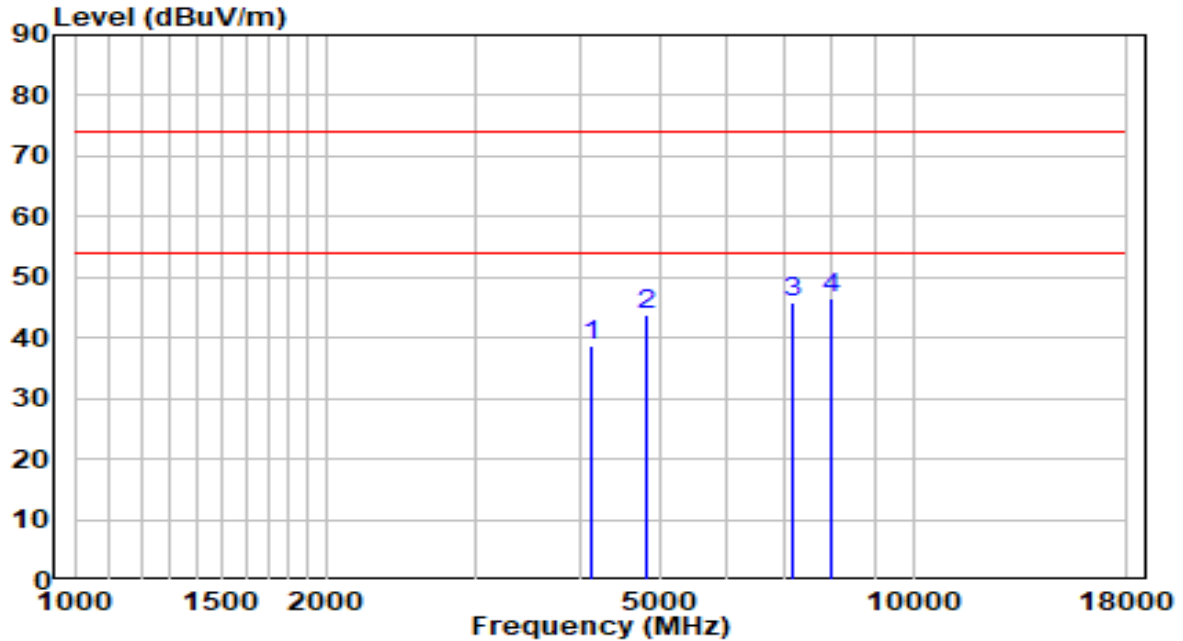

No	Frequency (MHz)	Reading (dBuV)	C.F (dB)	Measurement (dBuV/m)	Margin (dB)	Limit (dBuV/m)	Remark (QP/PK/AV)
1	4128.000	37.42	1.31	38.73	-35.27	74.00	Peak
2	4825.000	40.54	3.33	43.87	-30.13	74.00	Peak
3	7171.000	34.94	10.78	45.73	-28.27	74.00	Peak
4	* 7970.000	34.18	12.48	46.66	-27.34	74.00	Peak

Note:

1. " \*", means this data is the worst emission level.
2. C.F (Correction Factor) = Antenna Factor (dB)+ Cable Loss (dB)– Preamplifier(dB).
3. Measurement(dBuV/m) = Reading(dBuV) + C.F (Correction Factor).
- 4.The emission levels of other frequencies are very lower than the limit and not show in test report.

EUT	OAW-AP1301	Date of Test	2020-10-17
Factor	BBHA 9120D	Temp. / Humidity	25.4°C/48.4%
Polarity	Horizontal	Site / Test Engineer	AC1 / Jay Chiu
Test Mode	Transmit by 802.11g at Channel 2437MHz	Test Voltage	120V/60Hz

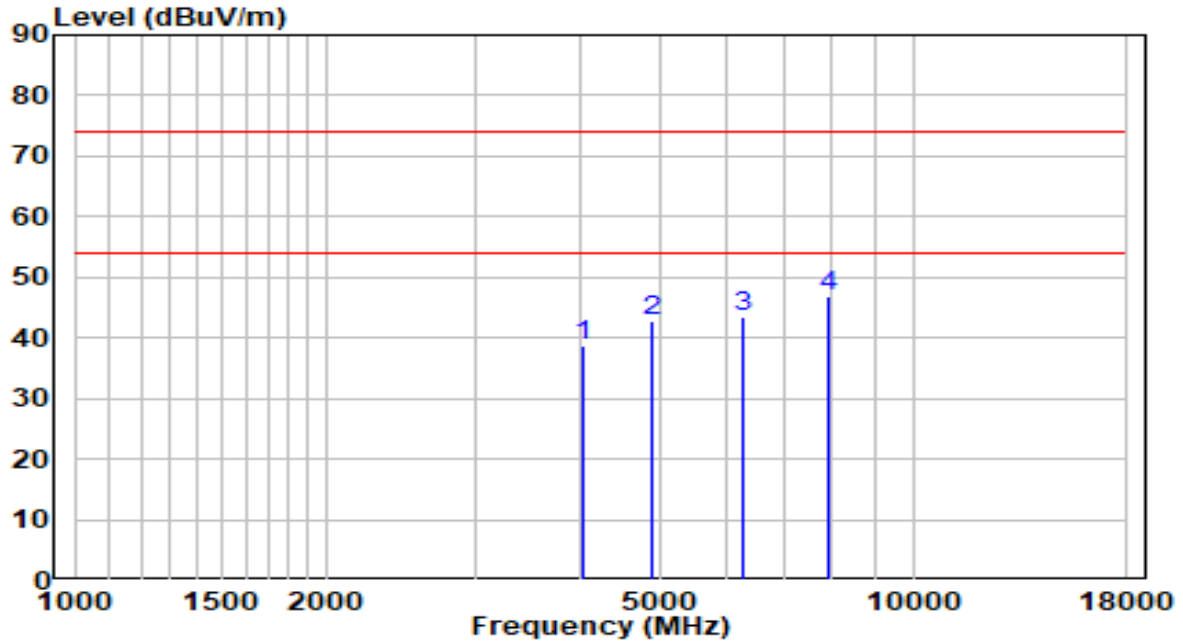

No	Frequency (MHz)	Reading (dBuV)	C.F (dB)	Measurement (dBuV/m)	Margin (dB)	Limit (dBuV/m)	Remark (QP/PK/AV)
1	4026.000	37.86	0.97	38.82	-35.18	74.00	Peak
2	4876.000	39.27	3.45	42.72	-31.28	74.00	Peak
3	6253.000	36.54	7.01	43.54	-30.46	74.00	Peak
4	* 7902.000	34.56	12.37	46.93	-27.07	74.00	Peak

Note:

1. " \*", means this data is the worst emission level.
2. C.F (Correction Factor) = Antenna Factor (dB)+ Cable Loss (dB)– Preamplifier(dB).
3. Measurement(dBuV/m) = Reading(dBuV) + C.F (Correction Factor).
4. The emission levels of other frequencies are very lower than the limit and not show in test report.

EUT	OAW-AP1301	Date of Test	2020-10-17
Factor	BBHA 9120D	Temp. / Humidity	25.4°C/48.4%
Polarity	Vertical	Site / Test Engineer	AC1 / Jay Chiu
Test Mode	Transmit by 802.11g at Channel 2437MHz	Test Voltage	120V/60Hz

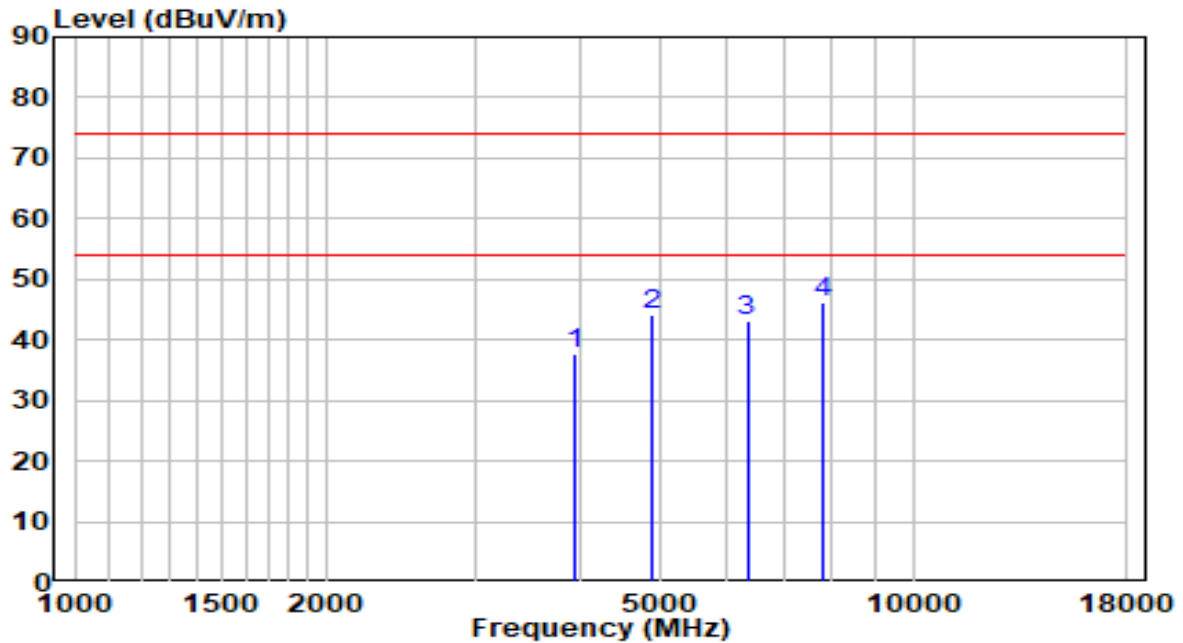

No	Frequency (MHz)	Reading (dBuV)	C.F (dB)	Measurement (dBuV/m)	Margin (dB)	Limit (dBuV/m)	Remark (QP/PK/AV)
1	3941.000	37.07	0.68	37.75	-36.25	74.00	Peak
2	4876.000	40.64	3.45	44.09	-29.91	74.00	Peak
3	6338.000	35.84	7.38	43.22	-30.78	74.00	Peak
4	* 7783.000	33.84	12.18	46.02	-27.98	74.00	Peak

Note:

1. " \*", means this data is the worst emission level.
2. C.F (Correction Factor) = Antenna Factor (dB)+ Cable Loss (dB)– Preamplifier(dB).
3. Measurement(dBuV/m) = Reading(dBuV) + C.F (Correction Factor).
4. The emission levels of other frequencies are very lower than the limit and not show in test report.



EUT	OAW-AP1301	Date of Test	2020-10-17
Factor	BBHA 9120D	Temp. / Humidity	25.4°C/48.4%
Polarity	Horizontal	Site / Test Engineer	AC1 / Jay Chiu
Test Mode	Transmit by 802.11g at Channel 2462MHz	Test Voltage	120V/60Hz

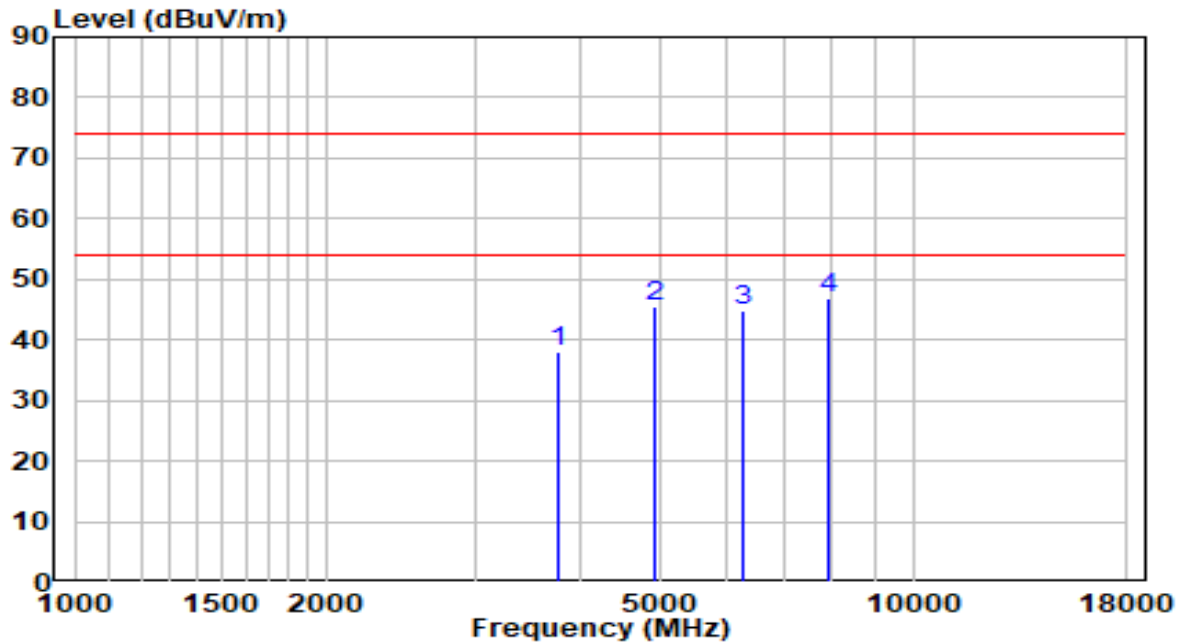

No	Frequency (MHz)	Reading (dBuV)	C.F (dB)	Measurement (dBuV/m)	Margin (dB)	Limit (dBuV/m)	Remark (QP/PK/AV)
1	3771.000	37.91	0.09	38.00	-36.00	74.00	Peak
2	4927.000	42.08	3.57	45.65	-28.35	74.00	Peak
3	6253.000	37.95	7.01	44.96	-29.04	74.00	Peak
4	* 7919.000	34.35	12.40	46.75	-27.25	74.00	Peak

Note:

1. " \*", means this data is the worst emission level.
2. C.F (Correction Factor) = Antenna Factor (dB)+ Cable Loss (dB)– Preamplifier(dB).
3. Measurement(dBuV/m) = Reading(dBuV) + C.F (Correction Factor).
4. The emission levels of other frequencies are very lower than the limit and not show in test report.

EUT	OAW-AP1301	Date of Test	2020-10-17
Factor	BBHA 9120D	Temp. / Humidity	25.4°C/48.4%
Polarity	Vertical	Site / Test Engineer	AC1 / Jay Chiu
Test Mode	Transmit by 802.11g at Channel 2462MHz	Test Voltage	120V/60Hz

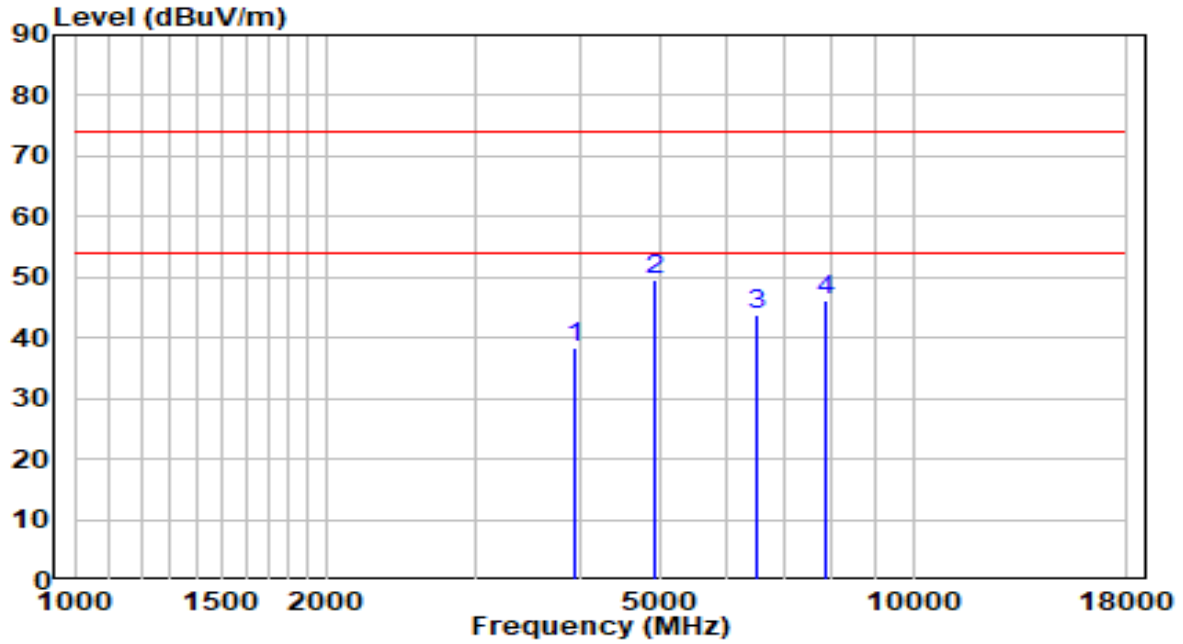

No	Frequency (MHz)	Reading (dBuV)	C.F (dB)	Measurement (dBuV/m)	Margin (dB)	Limit (dBuV/m)	Remark (QP/PK/AV)
1	3958.000	37.80	0.74	38.54	-35.46	74.00	Peak
2	* 4927.000	45.85	3.57	49.43	-24.57	74.00	Peak
3	6508.000	35.53	8.13	43.66	-30.34	74.00	Peak
4	7868.000	34.03	12.31	46.35	-27.65	74.00	Peak

Note:

- "\*", means this data is the worst emission level.
- C.F (Correction Factor) = Antenna Factor (dB)+ Cable Loss (dB)– Preamplifier(dB).
- Measurement(dBuV/m) = Reading(dBuV) + C.F (Correction Factor).
- The emission levels of other frequencies are very lower than the limit and not show in test report.

EUT	OAW-AP1301	Date of Test	2020-10-17
Factor	BBHA 9120D	Temp. / Humidity	25.4°C/48.4%
Polarity	Horizontal	Site / Test Engineer	AC1 / Jay Chiu
Test Mode	Transmit by 802.11n-HT20 at Channel 2412MHz	Test Voltage	120V/60Hz

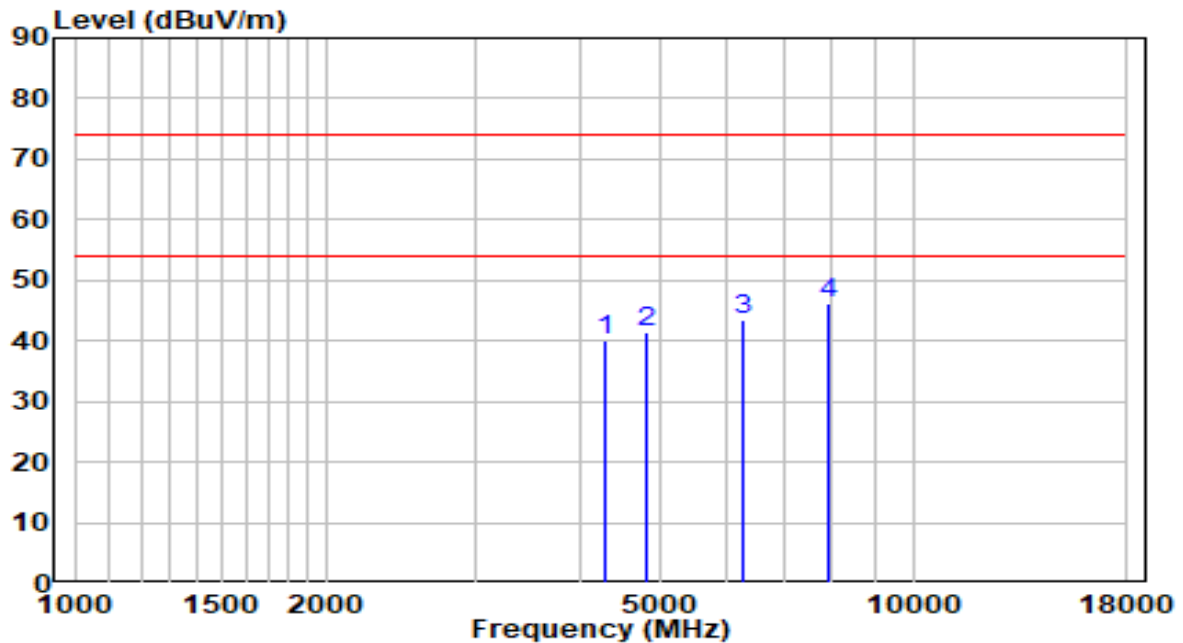

No	Frequency (MHz)	Reading (dBuV)	C.F (dB)	Measurement (dBuV/m)	Margin (dB)	Limit (dBuV/m)	Remark (QP/PK/AV)
1	4298.000	38.08	1.88	39.96	-34.04	74.00	Peak
2	4825.000	38.21	3.33	41.54	-32.46	74.00	Peak
3	6253.000	36.56	7.01	43.57	-30.43	74.00	Peak
4	* 7902.000	33.98	12.37	46.35	-27.65	74.00	Peak

Note:

1. " \*", means this data is the worst emission level.
2. C.F (Correction Factor) = Antenna Factor (dB)+ Cable Loss (dB)- Preamplifier(dB).
3. Measurement(dBuV/m) = Reading(dBuV) + C.F (Correction Factor).
- 4.The emission levels of other frequencies are very lower than the limit and not show in test report.

EUT	OAW-AP1301	Date of Test	2020-10-17
Factor	BBHA 9120D	Temp. / Humidity	25.4°C/48.4%
Polarity	Vertical	Site / Test Engineer	AC1 / Jay Chiu
Test Mode	Transmit by 802.11n-HT20 at Channel 2412MHz	Test Voltage	120V/60Hz

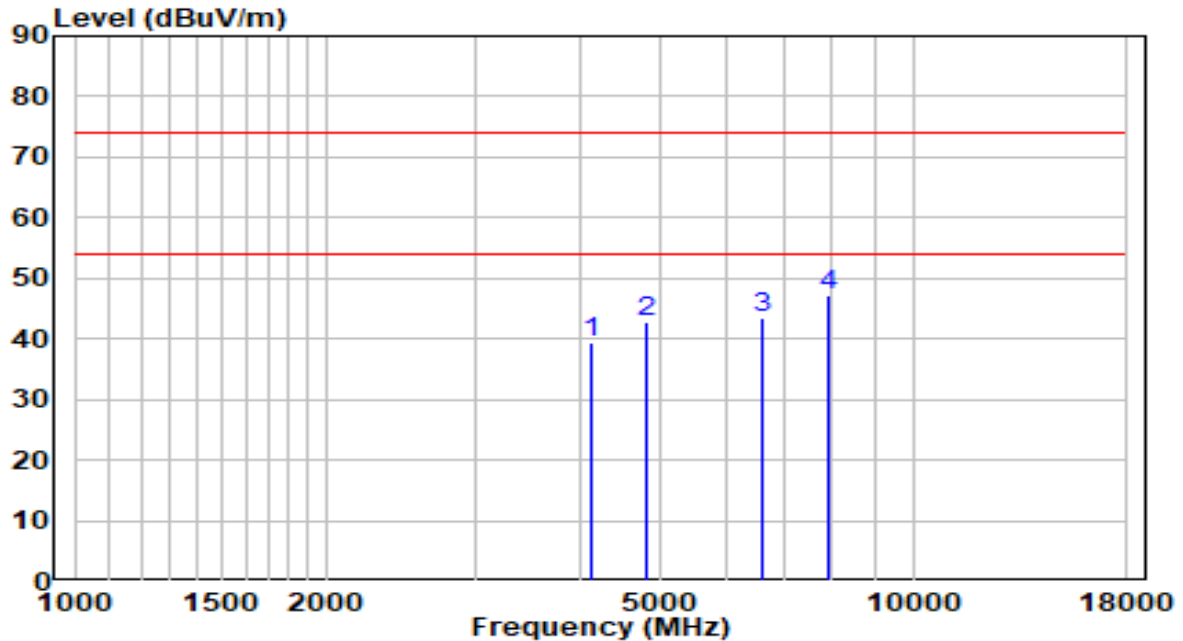

No	Frequency (MHz)	Reading (dBuV)	C.F (dB)	Measurement (dBuV/m)	Margin (dB)	Limit (dBuV/m)	Remark (QP/PK/AV)
1	4128.000	38.03	1.31	39.34	-34.66	74.00	Peak
2	4825.000	39.50	3.33	42.83	-31.17	74.00	Peak
3	6610.000	34.88	8.58	43.46	-30.54	74.00	Peak
4	* 7953.000	34.77	12.45	47.22	-26.78	74.00	Peak

Note:

1. " \*", means this data is the worst emission level.
2. C.F (Correction Factor) = Antenna Factor (dB)+ Cable Loss (dB)– Preamplifier(dB).
3. Measurement(dBuV/m) = Reading(dBuV) + C.F (Correction Factor).
- 4.The emission levels of other frequencies are very lower than the limit and not show in test report.

EUT	OAW-AP1301	Date of Test	2020-10-17
Factor	BBHA 9120D	Temp. / Humidity	25.4°C/48.4%
Polarity	Horizontal	Site / Test Engineer	AC1 / Jay Chiu
Test Mode	Transmit by 802.11n-HT20 at Channel 2437MHz	Test Voltage	120V/60Hz

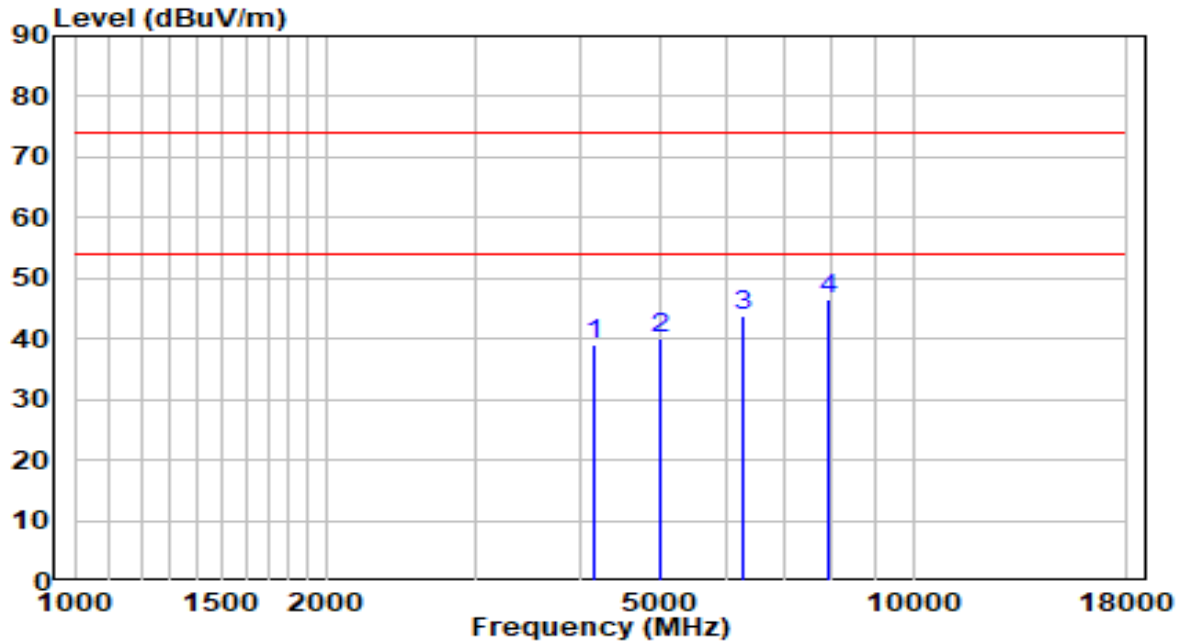

No	Frequency (MHz)	Reading (dBuV)	C.F (dB)	Measurement (dBuV/m)	Margin (dB)	Limit (dBuV/m)	Remark (QP/PK/AV)
1	4162.000	37.48	1.42	38.90	-35.10	74.00	Peak
2	4995.000	36.20	3.74	39.94	-34.06	74.00	Peak
3	6253.000	36.79	7.01	43.80	-30.20	74.00	Peak
4	* 7936.000	34.22	12.43	46.65	-27.35	74.00	Peak

Note:

- "\*" means this data is the worst emission level.
- C.F (Correction Factor) = Antenna Factor (dB)+ Cable Loss (dB)- Preamplifier(dB).
- Measurement(dBuV/m) = Reading(dBuV) + C.F (Correction Factor).
- The emission levels of other frequencies are very lower than the limit and not show in test report.

EUT	OAW-AP1301	Date of Test	2020-10-17
Factor	BBHA 9120D	Temp. / Humidity	25.4°C/48.4%
Polarity	Vertical	Site / Test Engineer	AC1 / Jay Chiu
Test Mode	Transmit by 802.11n-HT20 at Channel 2437MHz	Test Voltage	120V/60Hz

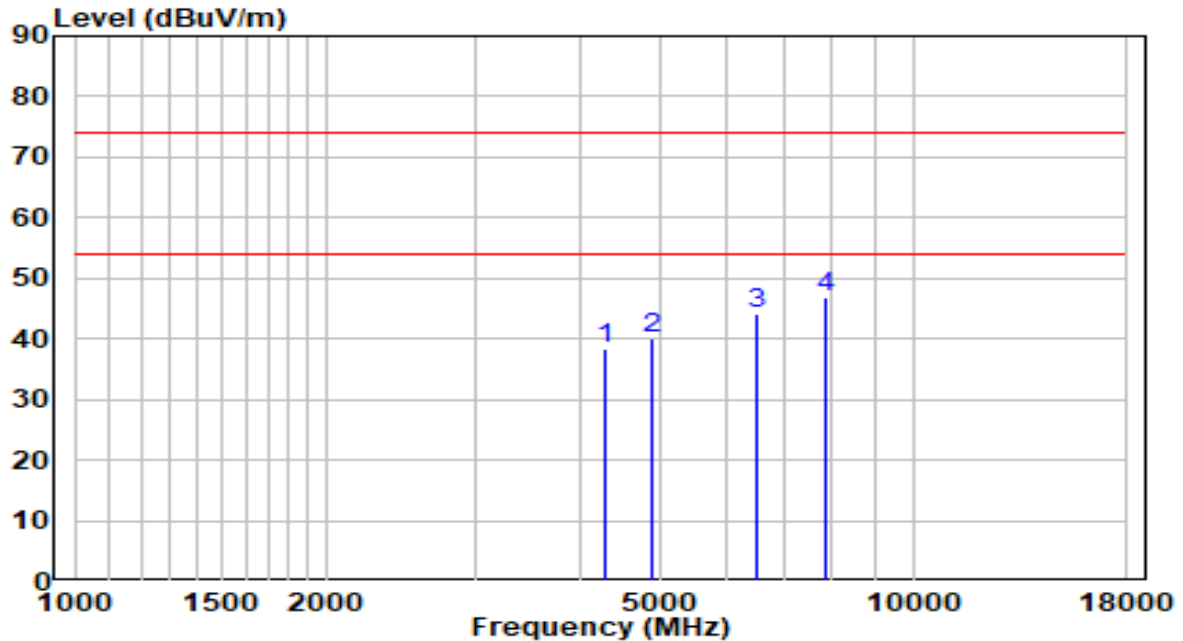

No	Frequency (MHz)	Reading (dBuV)	C.F (dB)	Measurement (dBuV/m)	Margin (dB)	Limit (dBuV/m)	Remark (QP/PK/AV)
1	4281.000	36.63	1.82	38.44	-35.56	74.00	Peak
2	4893.000	36.74	3.49	40.24	-33.76	74.00	Peak
3	6508.000	36.03	8.13	44.16	-29.84	74.00	Peak
4	* 7868.000	34.58	12.31	46.89	-27.11	74.00	Peak

Note:

1. " \*", means this data is the worst emission level.
2. C.F (Correction Factor) = Antenna Factor (dB)+ Cable Loss (dB)– Preamplifier(dB).
3. Measurement(dBuV/m) = Reading(dBuV) + C.F (Correction Factor).
- 4.The emission levels of other frequencies are very lower than the limit and not show in test report.

EUT	OAW-AP1301	Date of Test	2020-10-17
Factor	BBHA 9120D	Temp. / Humidity	25.4°C/48.4%
Polarity	Horizontal	Site / Test Engineer	AC1 / Jay Chiu
Test Mode	Transmit by 802.11n-HT20 at Channel 2462MHz	Test Voltage	120V/60Hz

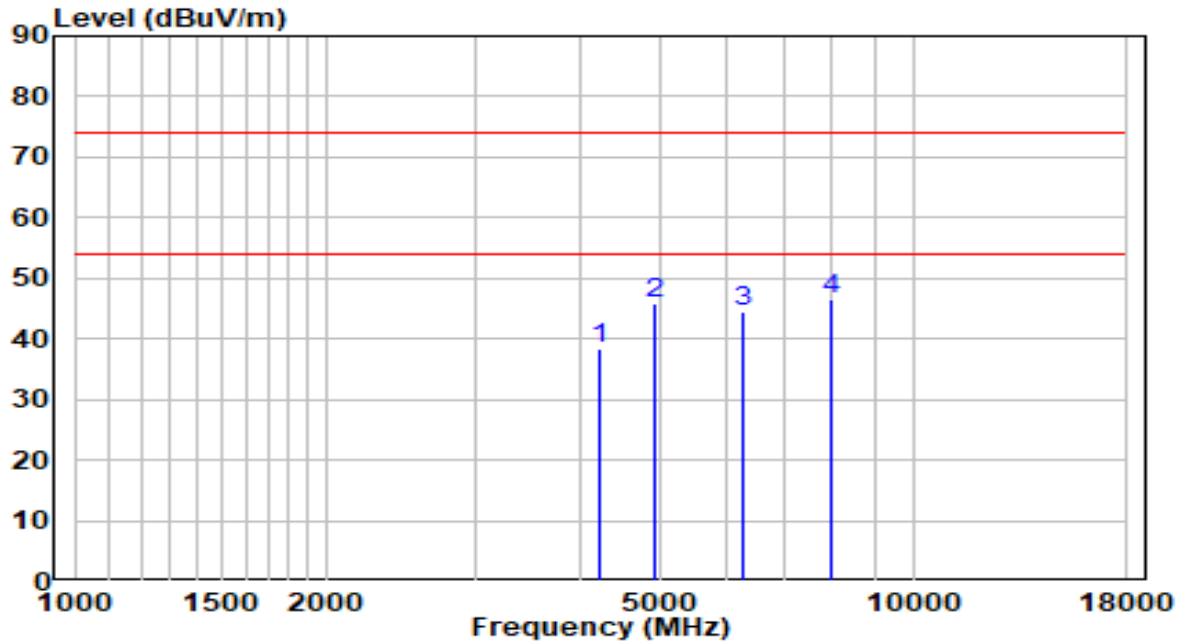

No	Frequency (MHz)	Reading (dBuV)	C.F (dB)	Measurement (dBuV/m)	Margin (dB)	Limit (dBuV/m)	Remark (QP/PK/AV)
1	4213.000	36.87	1.59	38.46	-35.54	74.00	Peak
2	4927.000	42.21	3.57	45.79	-28.21	74.00	Peak
3	6253.000	37.59	7.01	44.60	-29.40	74.00	Peak
4	* 7987.000	33.89	12.51	46.40	-27.60	74.00	Peak

Note:

- "\*" means this data is the worst emission level.
- C.F (Correction Factor) = Antenna Factor (dB)+ Cable Loss (dB)– Preamplifier(dB).
- Measurement(dBuV/m) = Reading(dBuV) + C.F (Correction Factor).
- The emission levels of other frequencies are very lower than the limit and not show in test report.

EUT	OAW-AP1301	Date of Test	2020-10-17
Factor	BBHA 9120D	Temp. / Humidity	25.4°C/48.4%
Polarity	Vertical	Site / Test Engineer	AC1 / Jay Chiu
Test Mode	Transmit by 802.11n-HT20 at Channel 2462MHz	Test Voltage	120V/60Hz

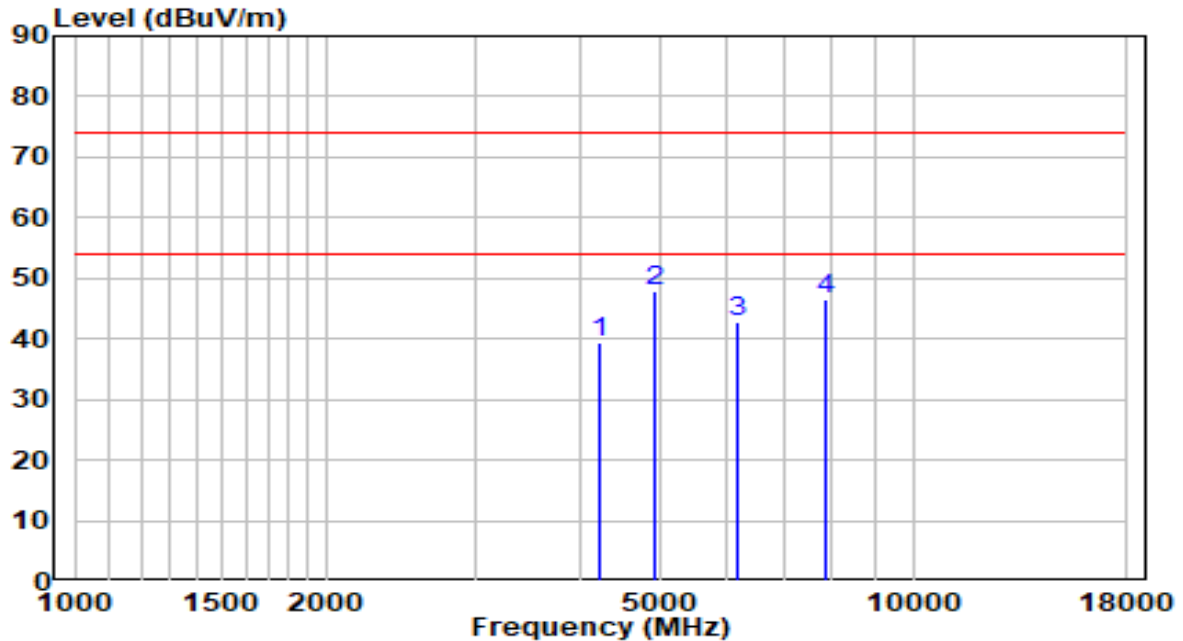

No	Frequency (MHz)	Reading (dBuV)	C.F (dB)	Measurement (dBuV/m)	Margin (dB)	Limit (dBuV/m)	Remark (QP/PK/AV)
1	4230.000	37.88	1.65	39.53	-34.47	74.00	Peak
2	* 4927.000	44.39	3.57	47.97	-26.03	74.00	Peak
3	6151.000	36.23	6.56	42.79	-31.21	74.00	Peak
4	7868.000	34.10	12.31	46.41	-27.59	74.00	Peak

Note:

1. " \*", means this data is the worst emission level.
2. C.F (Correction Factor) = Antenna Factor (dB)+ Cable Loss (dB)- Preamplifier(dB).
3. Measurement(dBuV/m) = Reading(dBuV) + C.F (Correction Factor).
- 4.The emission levels of other frequencies are very lower than the limit and not show in test report.



EUT	OAW-AP1301	Date of Test	2020-10-17
Factor	BBHA 9120D	Temp. / Humidity	25.4°C/48.4%
Polarity	Horizontal	Site / Test Engineer	AC1 / Jay Chiu
Test Mode	Transmit by 802.11n-HT40 at Channel 2422MHz	Test Voltage	120V/60Hz

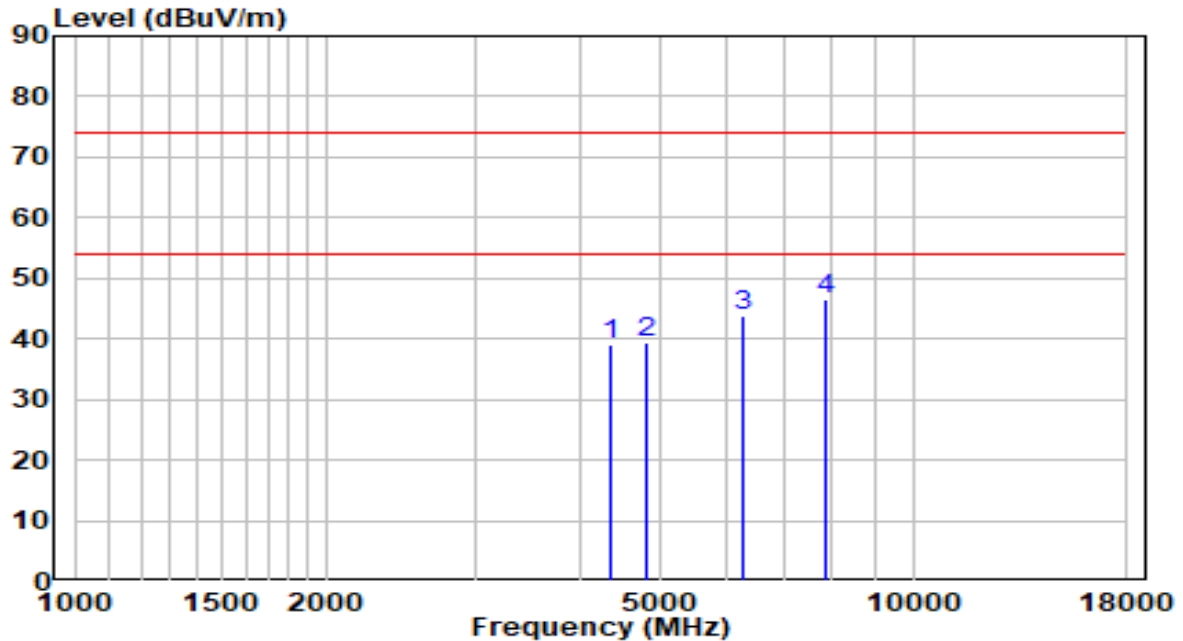

No	Frequency (MHz)	Reading (dBuV)	C.F (dB)	Measurement (dBuV/m)	Margin (dB)	Limit (dBuV/m)	Remark (QP/PK/AV)
1	4349.000	36.86	2.05	38.90	-35.10	74.00	Peak
2	4825.000	36.21	3.33	39.54	-34.46	74.00	Peak
3	6253.000	36.94	7.01	43.95	-30.05	74.00	Peak
4	* 7868.000	34.38	12.31	46.69	-27.31	74.00	Peak

Note:

- "\*" means this data is the worst emission level.
- C.F (Correction Factor) = Antenna Factor (dB)+ Cable Loss (dB)– Preamplifier(dB).
- Measurement(dBuV/m) = Reading(dBuV) + C.F (Correction Factor).
- The emission levels of other frequencies are very lower than the limit and not show in test report.

EUT	OAW-AP1301	Date of Test	2020-10-17
Factor	BBHA 9120D	Temp. / Humidity	25.4°C/48.4%
Polarity	Vertical	Site / Test Engineer	AC1 / Jay Chiu
Test Mode	Transmit by 802.11n-HT40 at Channel 2422MHz	Test Voltage	120V/60Hz

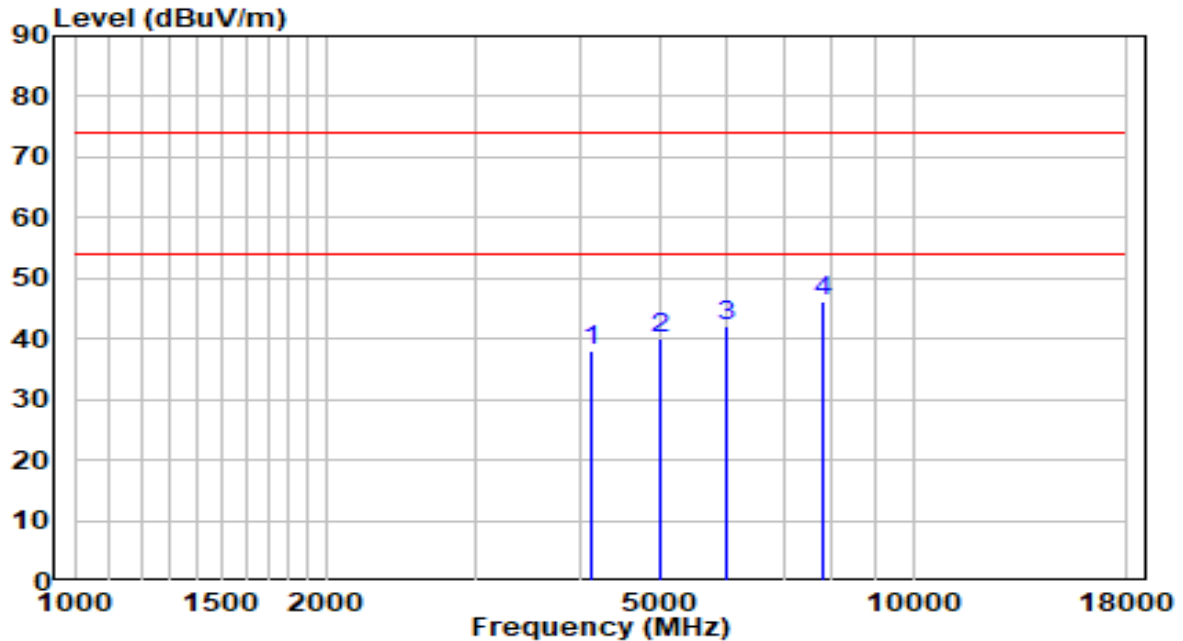

No	Frequency (MHz)	Reading (dBuV)	C.F (dB)	Measurement (dBuV/m)	Margin (dB)	Limit (dBuV/m)	Remark (QP/PK/AV)
1	4128.000	36.64	1.31	37.95	-36.05	74.00	Peak
2	4995.000	36.31	3.74	40.05	-33.95	74.00	Peak
3	5998.000	36.06	5.88	41.95	-32.05	74.00	Peak
4	* 7834.000	33.98	12.26	46.24	-27.76	74.00	Peak

Note:

- "\*" means this data is the worst emission level.
- C.F (Correction Factor) = Antenna Factor (dB)+ Cable Loss (dB)– Preamplifier(dB).
- Measurement(dBuV/m) = Reading(dBuV) + C.F (Correction Factor).
- The emission levels of other frequencies are very lower than the limit and not show in test report.

EUT	OAW-AP1301	Date of Test	2020-10-17
Factor	BBHA 9120D	Temp. / Humidity	25.4°C/48.4%
Polarity	Horizontal	Site / Test Engineer	AC1 / Jay Chiu
Test Mode	Transmit by 802.11n-HT40 at Channel 2437MHz	Test Voltage	120V/60Hz

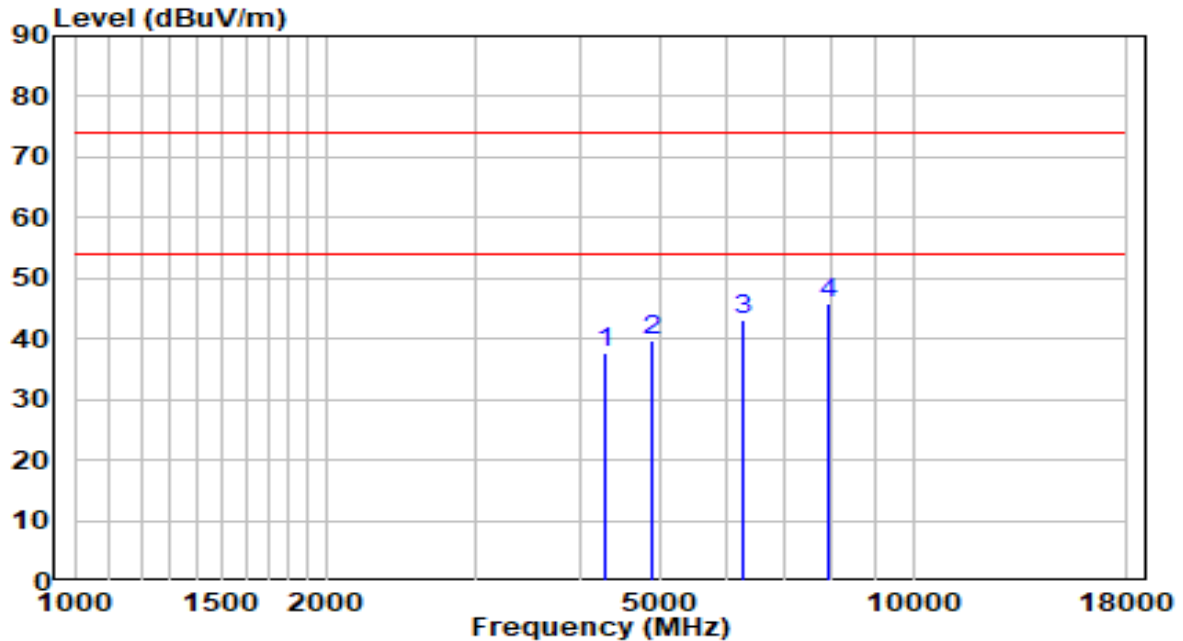

No	Frequency (MHz)	Reading (dBuV)	C.F (dB)	Measurement (dBuV/m)	Margin (dB)	Limit (dBuV/m)	Remark (QP/PK/AV)
1	4281.000	35.94	1.82	37.76	-36.25	74.00	Peak
2	4893.000	36.24	3.49	39.73	-34.27	74.00	Peak
3	6253.000	35.99	7.01	42.99	-31.01	74.00	Peak
4	* 7936.000	33.35	12.43	45.78	-28.22	74.00	Peak

Note:

1. " \*", means this data is the worst emission level.
2. C.F (Correction Factor) = Antenna Factor (dB)+ Cable Loss (dB)- Preamplifier(dB).
3. Measurement(dBuV/m) = Reading(dBuV) + C.F (Correction Factor).
- 4.The emission levels of other frequencies are very lower than the limit and not show in test report.

EUT	OAW-AP1301	Date of Test	2020-10-17
Factor	BBHA 9120D	Temp. / Humidity	25.4°C/48.4%
Polarity	Vertical	Site / Test Engineer	AC1 / Jay Chiu
Test Mode	Transmit by 802.11n-HT40 at Channel 2437MHz	Test Voltage	120V/60Hz

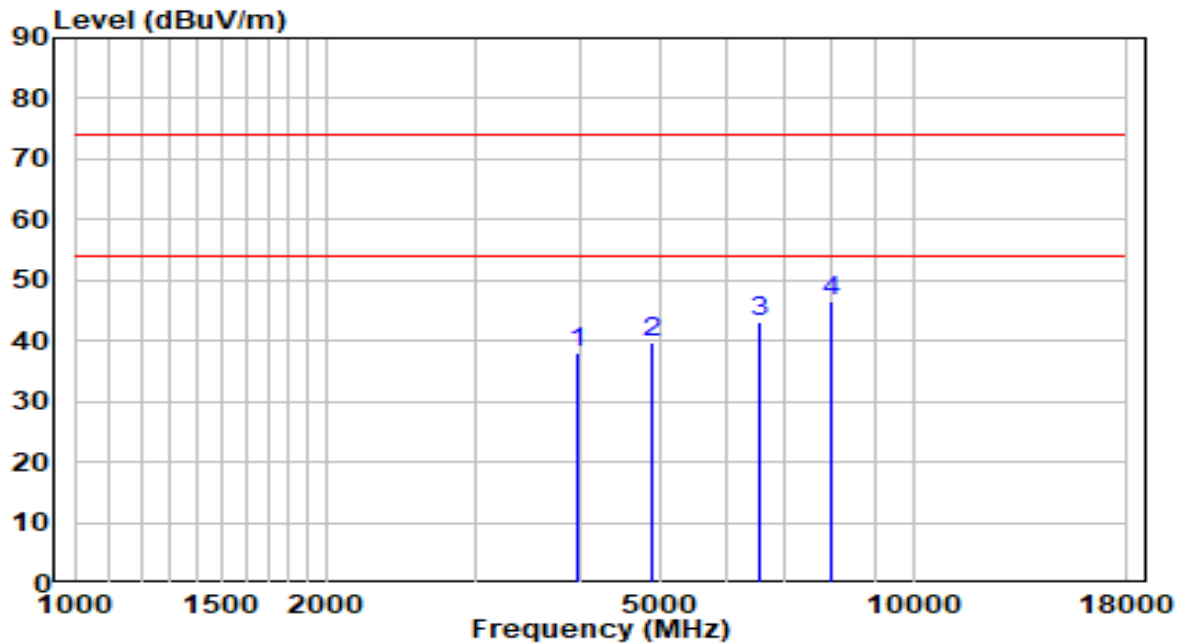

No	Frequency (MHz)	Reading (dBuV)	C.F (dB)	Measurement (dBuV/m)	Margin (dB)	Limit (dBuV/m)	Remark (QP/PK/AV)
1	3992.000	37.06	0.85	37.91	-36.09	74.00	Peak
2	4876.000	36.38	3.45	39.83	-34.17	74.00	Peak
3	6559.000	34.87	8.36	43.23	-30.77	74.00	Peak
4	* 7970.000	34.16	12.48	46.64	-27.36	74.00	Peak

Note:

- "\*" means this data is the worst emission level.
- C.F (Correction Factor) = Antenna Factor (dB)+ Cable Loss (dB)- Preamplifier(dB).
- Measurement(dBuV/m) = Reading(dBuV) + C.F (Correction Factor).
- The emission levels of other frequencies are very lower than the limit and not show in test report.

EUT	OAW-AP1301	Date of Test	2020-10-17
Factor	BBHA 9120D	Temp. / Humidity	25.4°C/48.4%
Polarity	Horizontal	Site / Test Engineer	AC1 / Jay Chiu
Test Mode	Transmit by 802.11n-HT40 at Channel 2452MHz	Test Voltage	120V/60Hz

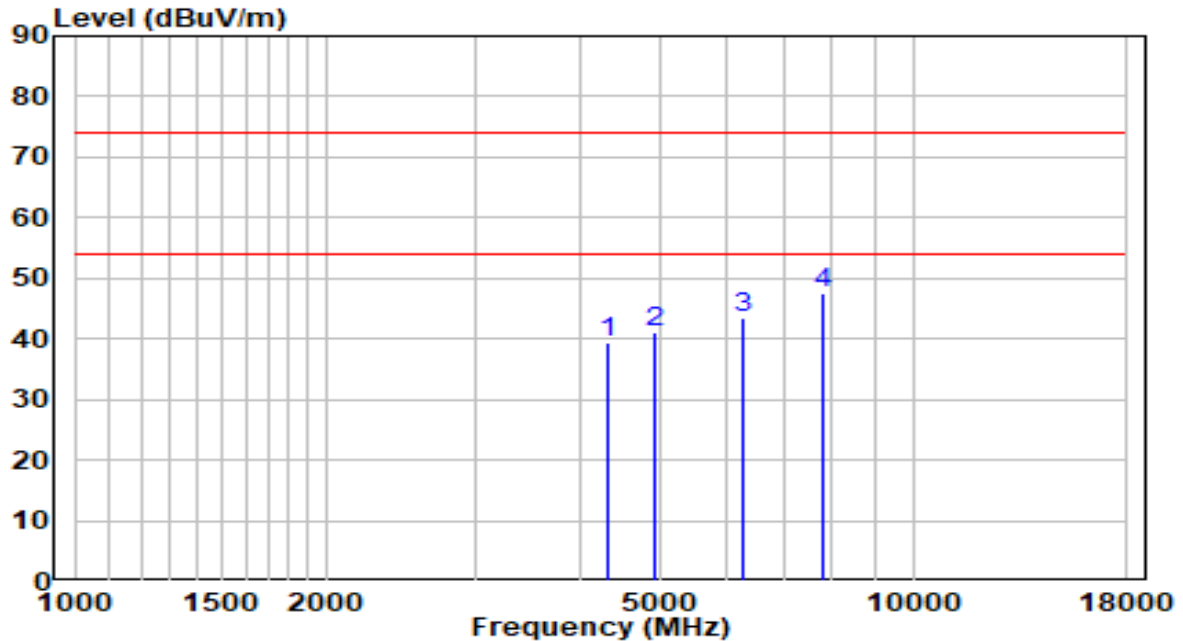

No	Frequency (MHz)	Reading (dBUV)	C.F (dB)	Measurement (dBUV/m)	Margin (dB)	Limit (dBUV/m)	Remark (QP/PK/AV)
1	4315.000	37.53	1.93	39.46	-34.54	74.00	Peak
2	4927.000	37.61	3.57	41.19	-32.81	74.00	Peak
3	6253.000	36.41	7.01	43.42	-30.58	74.00	Peak
4	* 7834.000	35.37	12.26	47.63	-26.37	74.00	Peak

Note:

1. " \*", means this data is the worst emission level.
2. C.F (Correction Factor) = Antenna Factor (dB)+ Cable Loss (dB)– Preamplifier(dB).
3. Measurement(dBUV/m) = Reading(dBUV) + C.F (Correction Factor).
- 4.The emission levels of other frequencies are very lower than the limit and not show in test report.

EUT	OAW-AP1301	Date of Test	2020-10-17
Factor	BBHA 9120D	Temp. / Humidity	25.4°C/48.4%
Polarity	Vertical	Site / Test Engineer	AC1 / Jay Chiu
Test Mode	Transmit by 802.11n-HT40 at Channel 2452MHz	Test Voltage	120V/60Hz

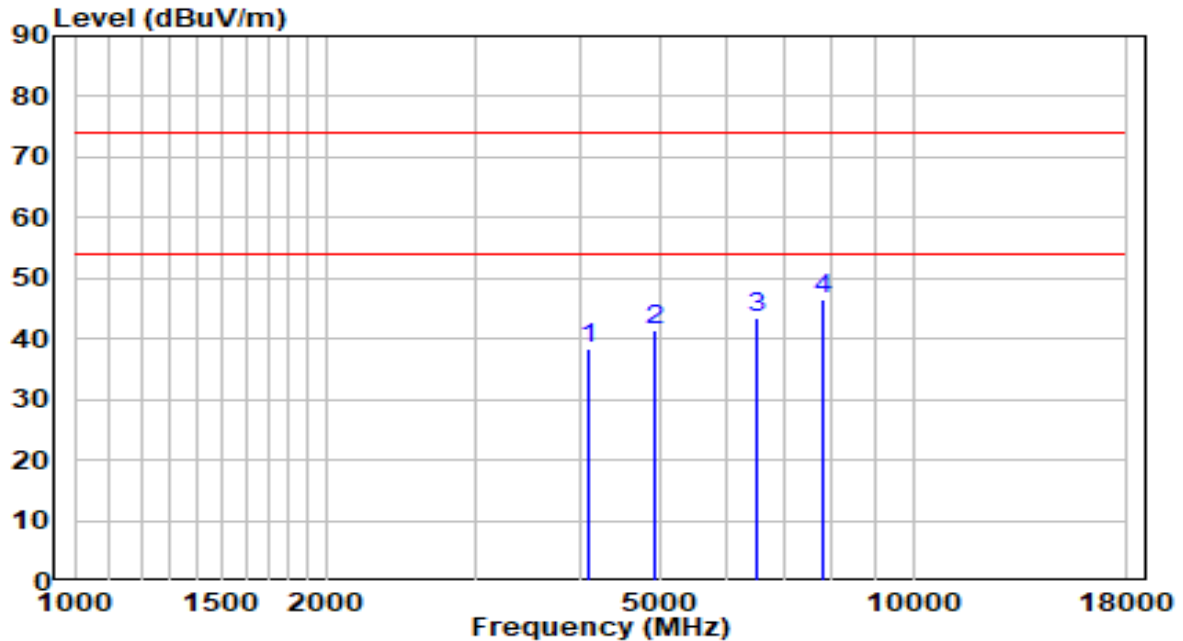

No	Frequency (MHz)	Reading (dBUV)	C.F (dB)	Measurement (dBUV/m)	Margin (dB)	Limit (dBUV/m)	Remark (QP/PK/AV)
1	4094.000	37.11	1.19	38.31	-35.69	74.00	Peak
2	4927.000	37.86	3.57	41.43	-32.57	74.00	Peak
3	6525.000	35.38	8.21	43.58	-30.42	74.00	Peak
4	* 7783.000	34.43	12.18	46.61	-27.39	74.00	Peak

Note:

1. " \*", means this data is the worst emission level.
2. C.F (Correction Factor) = Antenna Factor (dB)+ Cable Loss (dB)- Preamplifier(dB).
3. Measurement(dBUV/m) = Reading(dBUV) + C.F (Correction Factor).
- 4.The emission levels of other frequencies are very lower than the limit and not show in test report.

EUT	OAW-AP1301	Date of Test	2020-10-17
Factor	BBHA 9120D	Temp. / Humidity	25.4°C/48.4%
Polarity	Horizontal	Site / Test Engineer	AC1 / Jay Chiu
Test Mode	Transmit by VHT20 at Channel 2412MHz	Test Voltage	120V/60Hz

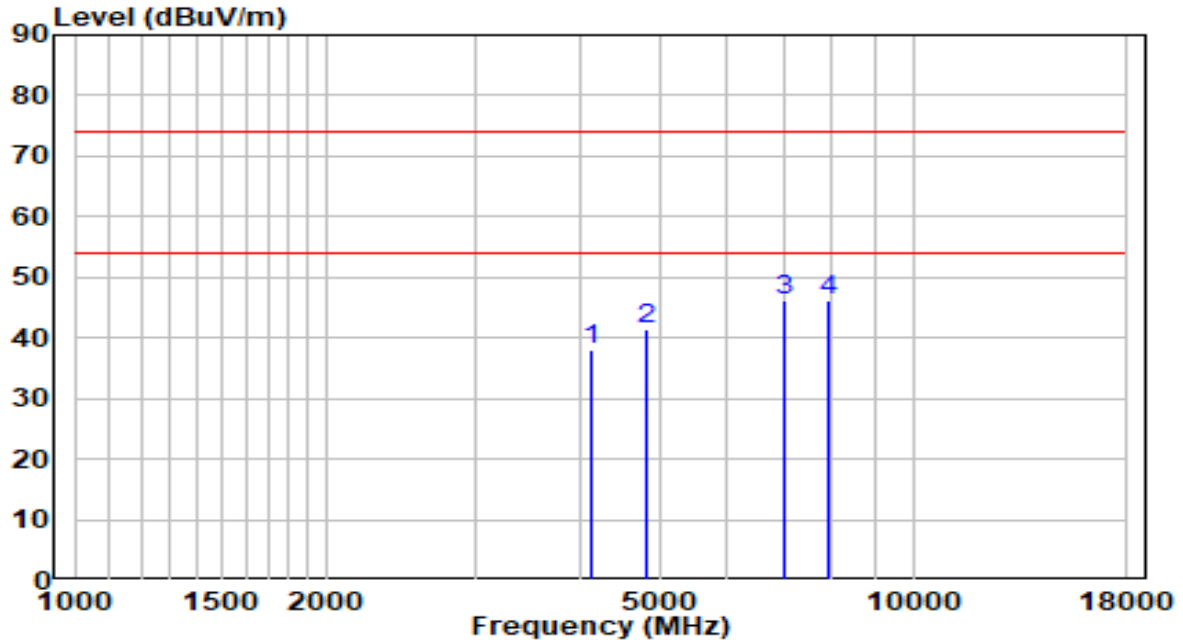

No	Frequency (MHz)	Reading (dBuV)	C.F (dB)	Measurement (dBuV/m)	Margin (dB)	Limit (dBuV/m)	Remark (QP/PK/AV)
1	4145.000	36.63	1.36	37.99	-36.01	74.00	Peak
2	4825.000	37.96	3.33	41.29	-32.71	74.00	Peak
3	* 7035.000	35.83	10.40	46.23	-27.77	74.00	Peak
4	7902.000	33.66	12.37	46.03	-27.97	74.00	Peak

Note:

- "\*" means this data is the worst emission level.
- C.F (Correction Factor) = Antenna Factor (dB)+ Cable Loss (dB)– Preamplifier(dB).
- Measurement(dBuV/m) = Reading(dBuV) + C.F (Correction Factor).
- The emission levels of other frequencies are very lower than the limit and not show in test report.

EUT	OAW-AP1301	Date of Test	2020-10-17
Factor	BBHA 9120D	Temp. / Humidity	25.4°C/48.4%
Polarity	Vertical	Site / Test Engineer	AC1 / Jay Chiu
Test Mode	Transmit by VHT20 at Channel 2412MHz	Test Voltage	120V/60Hz

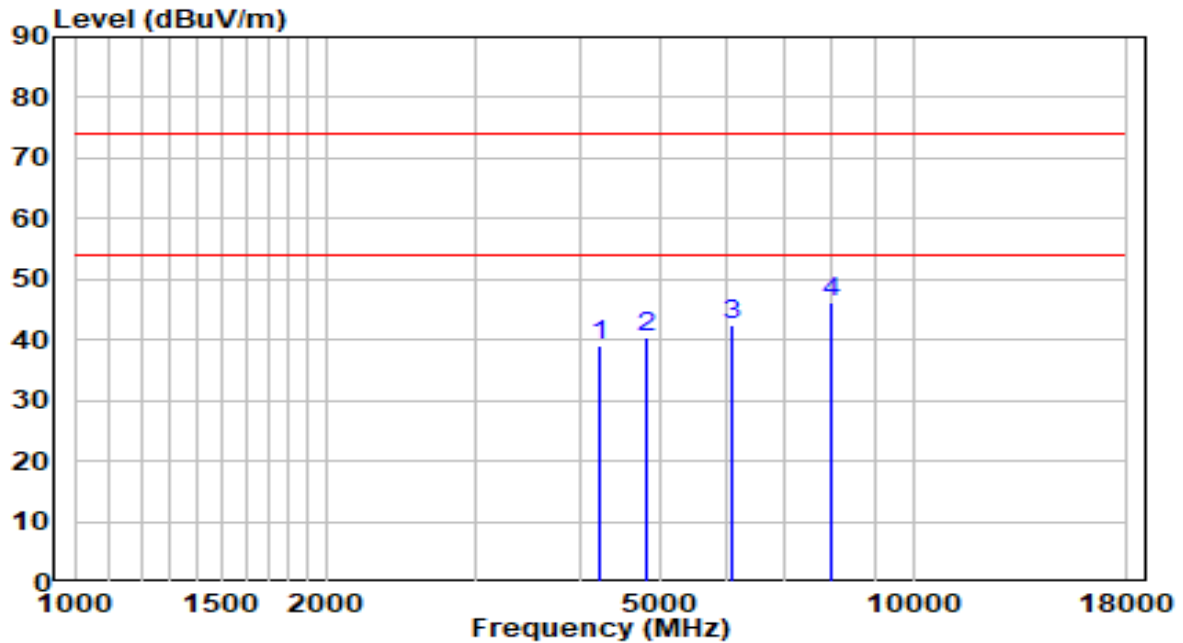

No	Frequency (MHz)	Reading (dBuV)	C.F (dB)	Measurement (dBuV/m)	Margin (dB)	Limit (dBuV/m)	Remark (QP/PK/AV)
1	4230.000	37.44	1.65	39.09	-34.91	74.00	Peak
2	4825.000	37.17	3.33	40.50	-33.50	74.00	Peak
3	6066.000	36.18	6.18	42.36	-31.64	74.00	Peak
4	* 7970.000	33.63	12.48	46.11	-27.89	74.00	Peak

Note:

1. " \*", means this data is the worst emission level.
2. C.F (Correction Factor) = Antenna Factor (dB)+ Cable Loss (dB)– Preamplifier(dB).
3. Measurement(dBuV/m) = Reading(dBuV) + C.F (Correction Factor).
4. The emission levels of other frequencies are very lower than the limit and not show in test report.



EUT	OAW-AP1301	Date of Test	2020-10-17
Factor	BBHA 9120D	Temp. / Humidity	25.4°C/48.4%
Polarity	Horizontal	Site / Test Engineer	AC1 / Jay Chiu
Test Mode	Transmit by VHT20 at Channel 2437MHz	Test Voltage	120V/60Hz

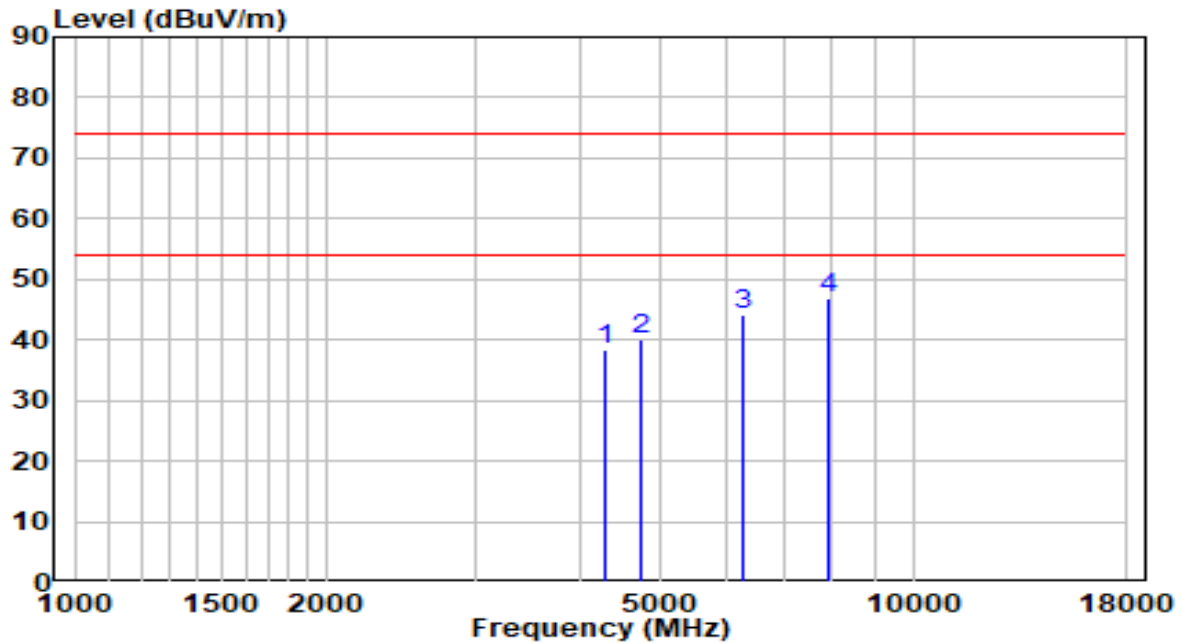

No	Frequency (MHz)	Reading (dBuV)	C.F (dB)	Measurement (dBuV/m)	Margin (dB)	Limit (dBuV/m)	Remark (QP/PK/AV)
1	4298.000	36.66	1.88	38.53	-35.47	74.00	Peak
2	4740.000	36.94	3.13	40.06	-33.94	74.00	Peak
3	6253.000	37.14	7.01	44.15	-29.85	74.00	Peak
4	* 7936.000	34.32	12.43	46.74	-27.26	74.00	Peak

Note:

1. " \*", means this data is the worst emission level.
2. C.F (Correction Factor) = Antenna Factor (dB)+ Cable Loss (dB)– Preamplifier(dB).
3. Measurement(dBuV/m) = Reading(dBuV) + C.F (Correction Factor).
4. The emission levels of other frequencies are very lower than the limit and not show in test report.

EUT	OAW-AP1301	Date of Test	2020-10-17
Factor	BBHA 9120D	Temp. / Humidity	25.4°C/48.4%
Polarity	Vertical	Site / Test Engineer	AC1 / Jay Chiu
Test Mode	Transmit by VHT20 at Channel 2437MHz	Test Voltage	120V/60Hz

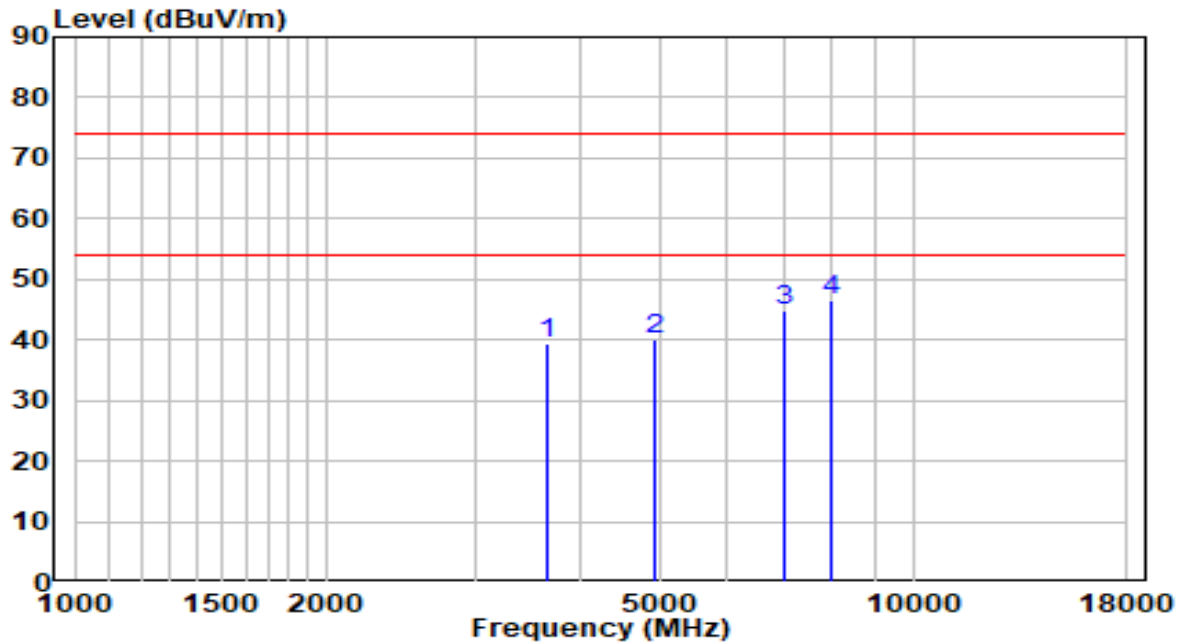

No	Frequency (MHz)	Reading (dBuV)	C.F (dB)	Measurement (dBuV/m)	Margin (dB)	Limit (dBuV/m)	Remark (QP/PK/AV)
1	3652.000	39.78	-0.32	39.46	-34.54	74.00	Peak
2	4910.000	36.38	3.53	39.91	-34.09	74.00	Peak
3	7018.000	34.32	10.35	44.67	-29.33	74.00	Peak
4	* 7987.000	34.10	12.51	46.61	-27.39	74.00	Peak

Note:

1. " \*", means this data is the worst emission level.
2. C.F (Correction Factor) = Antenna Factor (dB)+ Cable Loss (dB)– Preamplifier(dB).
3. Measurement(dBuV/m) = Reading(dBuV) + C.F (Correction Factor).
4. The emission levels of other frequencies are very lower than the limit and not show in test report.

EUT	OAW-AP1301	Date of Test	2020-10-17
Factor	BBHA 9120D	Temp. / Humidity	25.4°C/48.4%
Polarity	Horizontal	Site / Test Engineer	AC1 / Jay Chiu
Test Mode	Transmit by VHT20 at Channel 2462MHz	Test Voltage	120V/60Hz

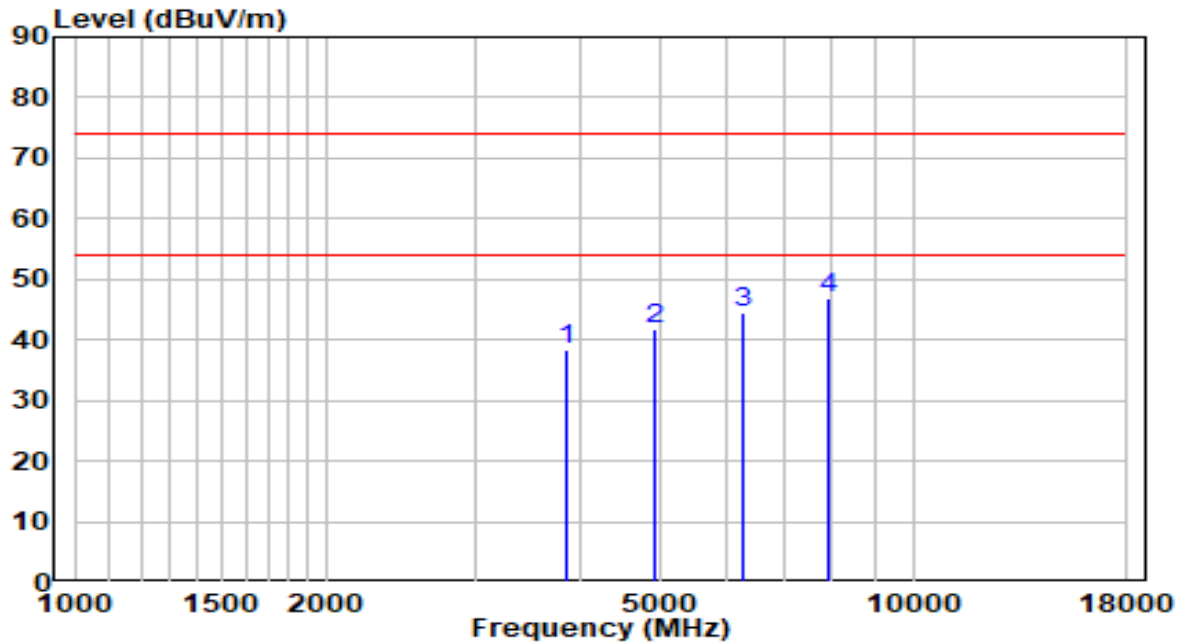

No	Frequency (MHz)	Reading (dBuV)	C.F (dB)	Measurement (dBuV/m)	Margin (dB)	Limit (dBuV/m)	Remark (QP/PK/AV)
1	3873.000	37.94	0.44	38.39	-35.61	74.00	Peak
2	4927.000	38.20	3.57	41.78	-32.22	74.00	Peak
3	6253.000	37.59	7.01	44.60	-29.40	74.00	Peak
4	* 7919.000	34.37	12.40	46.77	-27.23	74.00	Peak

Note:

1. " \*", means this data is the worst emission level.
2. C.F (Correction Factor) = Antenna Factor (dB)+ Cable Loss (dB)– Preamplifier(dB).
3. Measurement(dBuV/m) = Reading(dBuV) + C.F (Correction Factor).
4. The emission levels of other frequencies are very lower than the limit and not show in test report.

EUT	OAW-AP1301	Date of Test	2020-10-17
Factor	BBHA 9120D	Temp. / Humidity	25.4°C/48.4%
Polarity	Vertical	Site / Test Engineer	AC1 / Jay Chiu
Test Mode	Transmit by VHT20 at Channel 2462MHz	Test Voltage	120V/60Hz

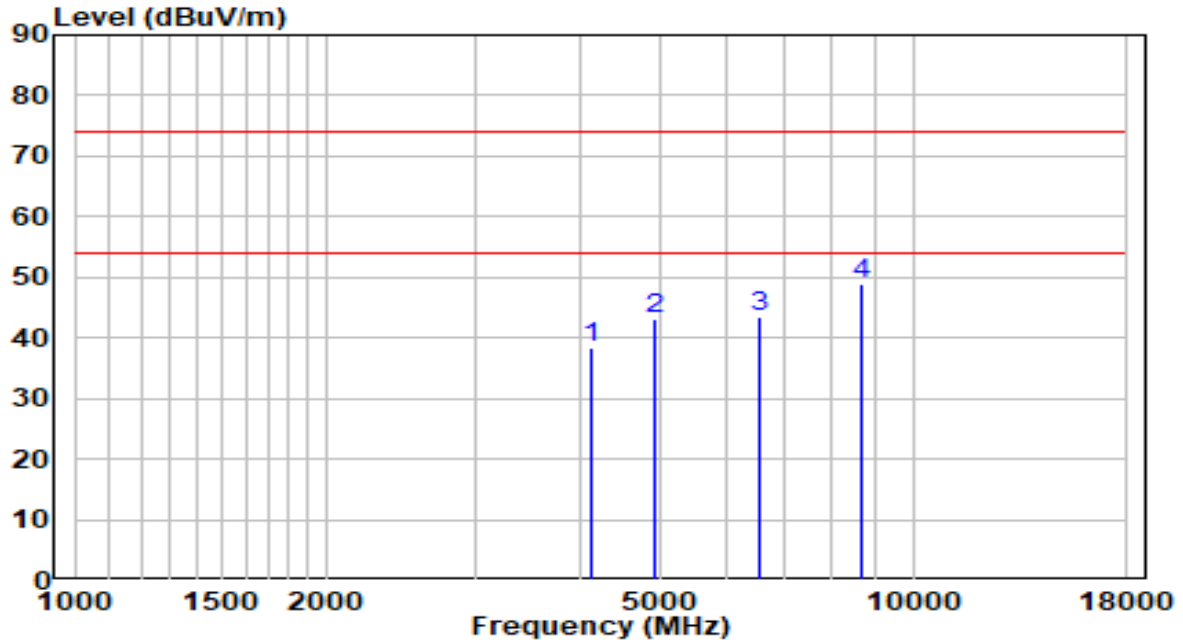

No	Frequency (MHz)	Reading (dBuV)	C.F (dB)	Measurement (dBuV/m)	Margin (dB)	Limit (dBuV/m)	Remark (QP/PK/AV)
1	4128.000	36.91	1.31	38.22	-35.78	74.00	Peak
2	4927.000	39.70	3.57	43.27	-30.73	74.00	Peak
3	6542.000	35.33	8.28	43.61	-30.39	74.00	Peak
4	* 8650.000	36.06	12.82	48.88	-25.12	74.00	Peak

Note:

1. " \*", means this data is the worst emission level.
2. C.F (Correction Factor) = Antenna Factor (dB)+ Cable Loss (dB)– Preamplifier(dB).
3. Measurement(dBuV/m) = Reading(dBuV) + C.F (Correction Factor).
4. The emission levels of other frequencies are very lower than the limit and not show in test report.

EUT	OAW-AP1301	Date of Test	2020-10-17
Factor	BBHA 9120D	Temp. / Humidity	25.4°C/48.4%
Polarity	Horizontal	Site / Test Engineer	AC1 / Jay Chiu
Test Mode	Transmit by VHT40 at Channel 2422MHz	Test Voltage	120V/60Hz

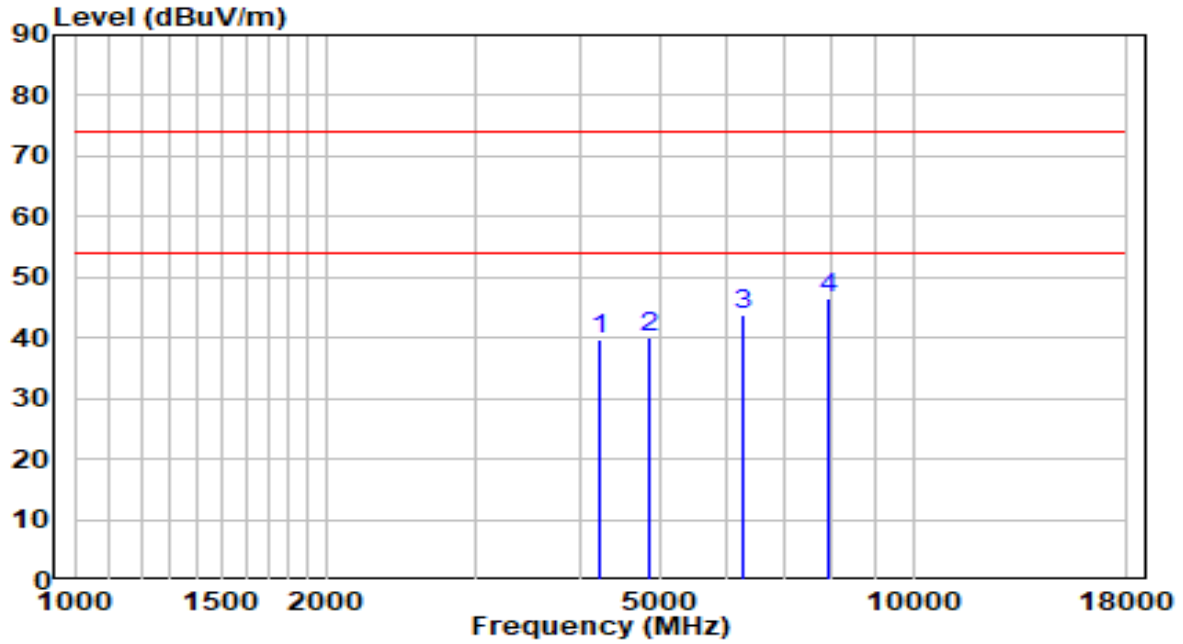

No	Frequency (MHz)	Reading (dBuV)	C.F (dB)	Measurement (dBuV/m)	Margin (dB)	Limit (dBuV/m)	Remark (QP/PK/AV)
1	4230.000	37.97	1.65	39.62	-34.38	74.00	Peak
2	4842.000	36.68	3.37	40.05	-33.95	74.00	Peak
3	6253.000	36.73	7.01	43.73	-30.27	74.00	Peak
4	* 7936.000	34.18	12.43	46.60	-27.40	74.00	Peak

Note:

1. " \*", means this data is the worst emission level.
2. C.F (Correction Factor) = Antenna Factor (dB)+ Cable Loss (dB)– Preamplifier(dB).
3. Measurement(dBuV/m) = Reading(dBuV) + C.F (Correction Factor).
4. The emission levels of other frequencies are very lower than the limit and not show in test report.

EUT	OAW-AP1301	Date of Test	2020-10-17
Factor	BBHA 9120D	Temp. / Humidity	25.4°C/48.4%
Polarity	Vertical	Site / Test Engineer	AC1 / Jay Chiu
Test Mode	Transmit by VHT40 at Channel 2422MHz	Test Voltage	120V/60Hz

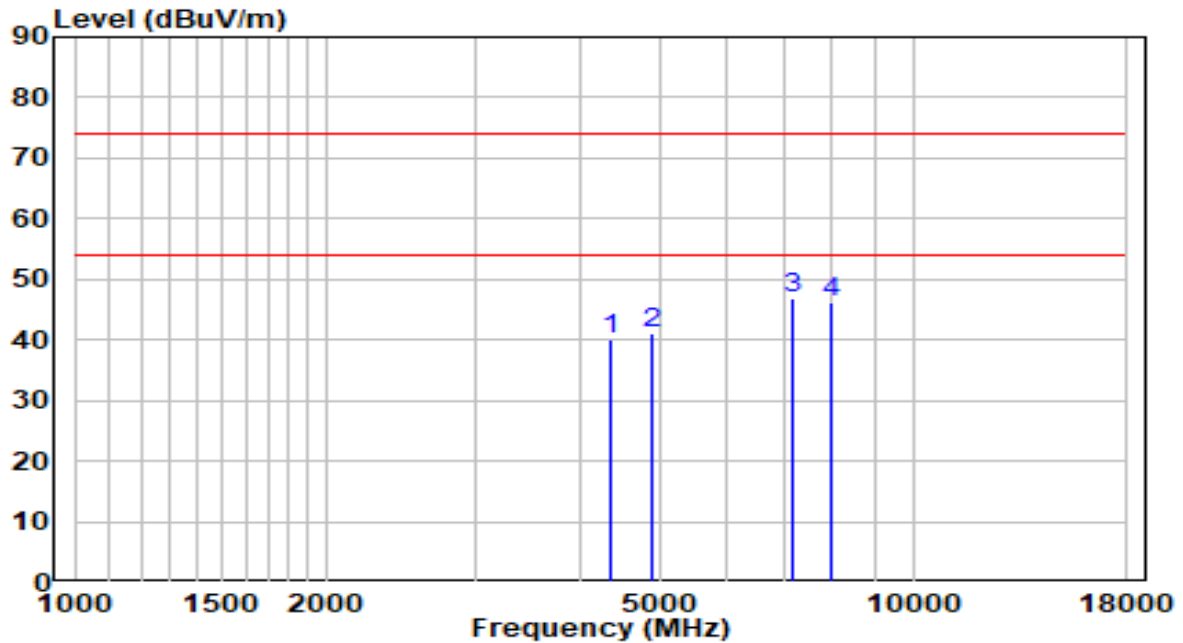

No	Frequency (MHz)	Reading (dBuV)	C.F (dB)	Measurement (dBuV/m)	Margin (dB)	Limit (dBuV/m)	Remark (QP/PK/AV)
1	4366.000	37.99	2.10	40.09	-33.91	74.00	Peak
2	4893.000	37.63	3.49	41.12	-32.88	74.00	Peak
3	* 7188.000	36.00	10.83	46.84	-27.16	74.00	Peak
4	7970.000	33.71	12.48	46.19	-27.81	74.00	Peak

Note:

- "\*" means this data is the worst emission level.
- C.F (Correction Factor) = Antenna Factor (dB)+ Cable Loss (dB)– Preamplifier(dB).
- Measurement(dBuV/m) = Reading(dBuV) + C.F (Correction Factor).
- The emission levels of other frequencies are very lower than the limit and not show in test report.

EUT	OAW-AP1301	Date of Test	2020-10-17
Factor	BBHA 9120D	Temp. / Humidity	25.4°C/48.4%
Polarity	Horizontal	Site / Test Engineer	AC1 / Jay Chiu
Test Mode	Transmit by VHT40 at Channel 2437MHz	Test Voltage	120V/60Hz

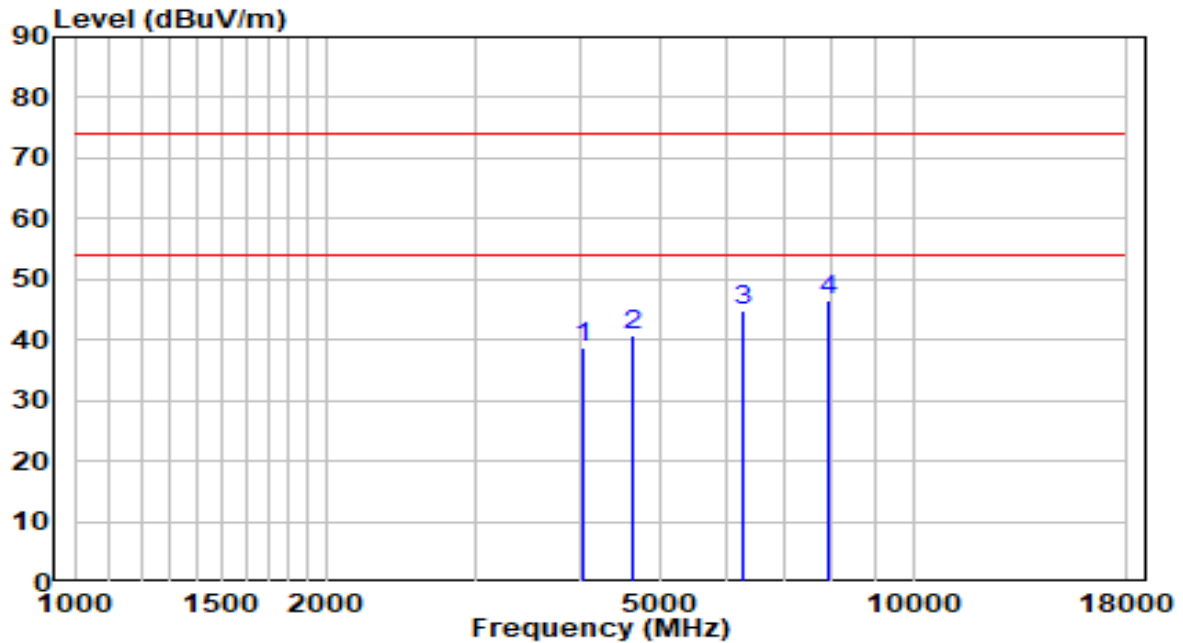

No	Frequency (MHz)	Reading (dBuV)	C.F (dB)	Measurement (dBuV/m)	Margin (dB)	Limit (dBuV/m)	Remark (QP/PK/AV)
1	4026.000	37.77	0.97	38.73	-35.27	74.00	Peak
2	4638.000	37.78	2.88	40.66	-33.34	74.00	Peak
3	6253.000	37.69	7.01	44.69	-29.31	74.00	Peak
4	* 7919.000	34.23	12.40	46.62	-27.38	74.00	Peak

Note:

1. " \*", means this data is the worst emission level.
2. C.F (Correction Factor) = Antenna Factor (dB)+ Cable Loss (dB)– Preamplifier(dB).
3. Measurement(dBuV/m) = Reading(dBuV) + C.F (Correction Factor).
4. The emission levels of other frequencies are very lower than the limit and not show in test report.

EUT	OAW-AP1301	Date of Test	2020-10-17
Factor	BBHA 9120D	Temp. / Humidity	25.4°C/48.4%
Polarity	Vertical	Site / Test Engineer	AC1 / Jay Chiu
Test Mode	Transmit by VHT40 at Channel 2437MHz	Test Voltage	120V/60Hz

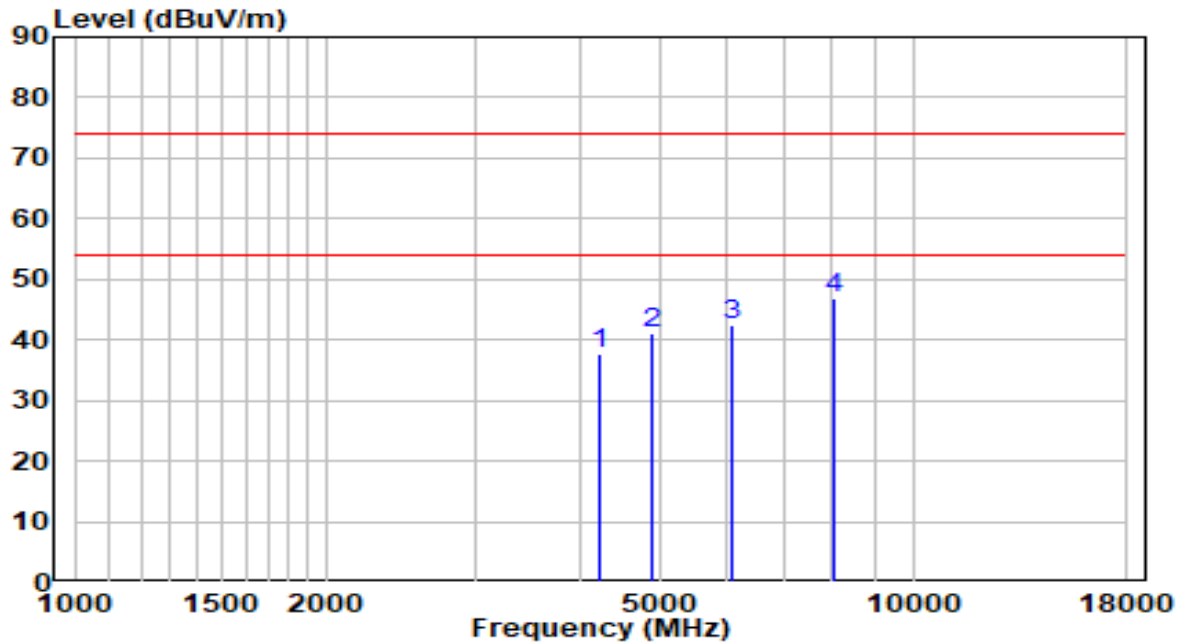

No	Frequency (MHz)	Reading (dBuV)	C.F (dB)	Measurement (dBuV/m)	Margin (dB)	Limit (dBuV/m)	Remark (QP/PK/AV)
1	4213.000	36.12	1.59	37.71	-36.29	74.00	Peak
2	4876.000	37.79	3.45	41.24	-32.76	74.00	Peak
3	6100.000	36.29	6.33	42.62	-31.38	74.00	Peak
4	* 8021.000	34.30	12.53	46.82	-27.18	74.00	Peak

Note:

1. " \*", means this data is the worst emission level.
2. C.F (Correction Factor) = Antenna Factor (dB)+ Cable Loss (dB)– Preamplifier(dB).
3. Measurement(dBuV/m) = Reading(dBuV) + C.F (Correction Factor).
4. The emission levels of other frequencies are very lower than the limit and not show in test report.



EUT	OAW-AP1301	Date of Test	2020-10-17
Factor	BBHA 9120D	Temp. / Humidity	25.4°C/48.4%
Polarity	Horizontal	Site / Test Engineer	AC1 / Jay Chiu
Test Mode	Transmit by VHT40 at Channel 2452MHz	Test Voltage	120V/60Hz

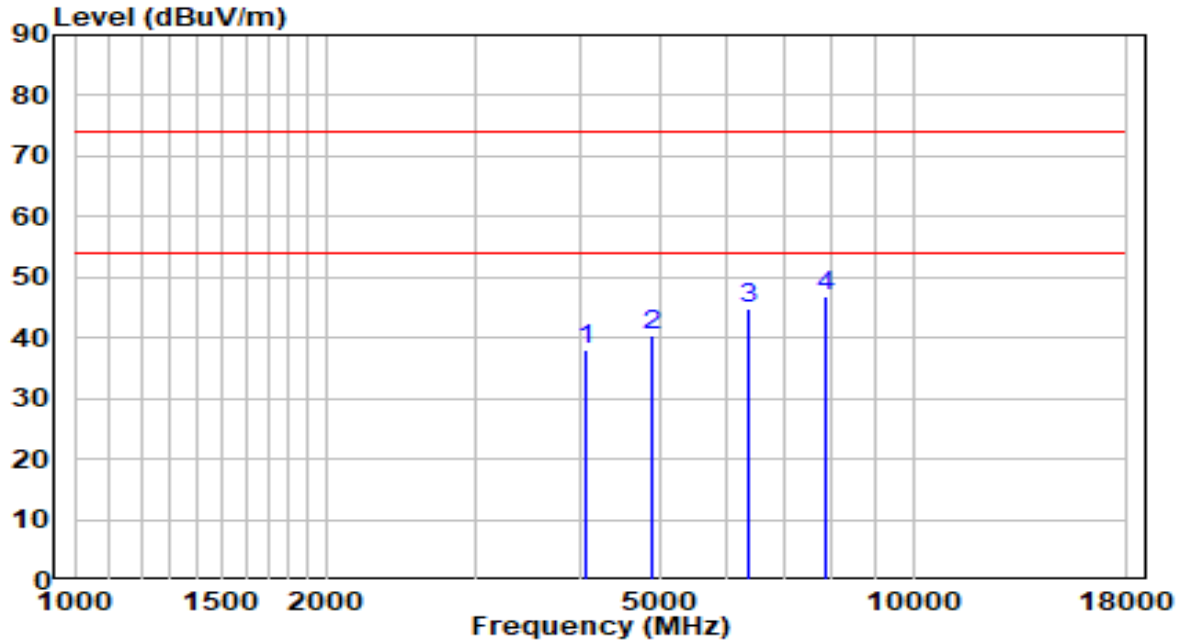

No	Frequency (MHz)	Reading (dBuV)	C.F (dB)	Measurement (dBuV/m)	Margin (dB)	Limit (dBuV/m)	Remark (QP/PK/AV)
1	4060.000	36.82	1.08	37.90	-36.10	74.00	Peak
2	4876.000	37.07	3.45	40.52	-33.48	74.00	Peak
3	6372.000	37.13	7.53	44.66	-29.34	74.00	Peak
4	* 7868.000	34.56	12.31	46.87	-27.13	74.00	Peak

Note:

1. " \*", means this data is the worst emission level.
2. C.F (Correction Factor) = Antenna Factor (dB)+ Cable Loss (dB)– Preamplifier(dB).
3. Measurement(dBuV/m) = Reading(dBuV) + C.F (Correction Factor).
4. The emission levels of other frequencies are very lower than the limit and not show in test report.

EUT	OAW-AP1301	Date of Test	2020-10-17
Factor	BBHA 9120D	Temp. / Humidity	25.4°C/48.4%
Polarity	Vertical	Site / Test Engineer	AC1 / Jay Chiu
Test Mode	Transmit by VHT40 at Channel 2452MHz	Test Voltage	120V/60Hz

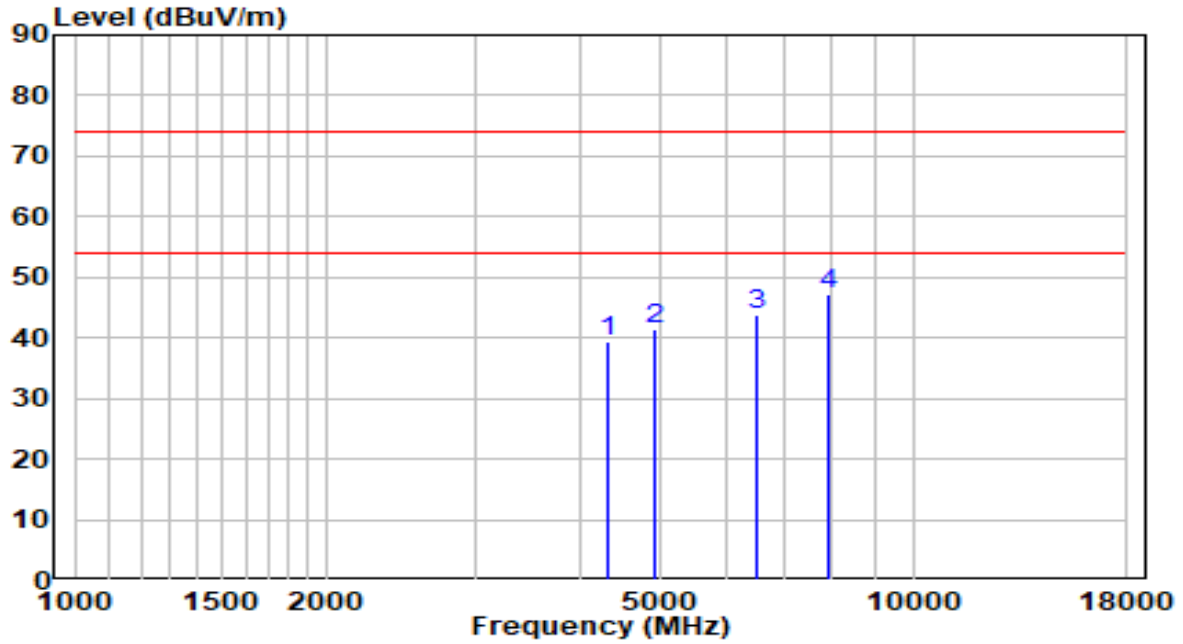

No	Frequency (MHz)	Reading (dBuV)	C.F (dB)	Measurement (dBuV/m)	Margin (dB)	Limit (dBuV/m)	Remark (QP/PK/AV)
1	4332.000	37.46	1.99	39.45	-34.55	74.00	Peak
2	4910.000	37.79	3.53	41.32	-32.68	74.00	Peak
3	6525.000	35.45	8.21	43.65	-30.35	74.00	Peak
4	* 7936.000	34.65	12.43	47.08	-26.92	74.00	Peak

Note:

1. " \*", means this data is the worst emission level.
2. C.F (Correction Factor) = Antenna Factor (dB)+ Cable Loss (dB)– Preamplifier(dB).
3. Measurement(dBuV/m) = Reading(dBuV) + C.F (Correction Factor).
4. The emission levels of other frequencies are very lower than the limit and not show in test report.

EUT	OAW-AP1301	Date of Test	2020-10-17
Factor	BBHA 9120D	Temp. / Humidity	25.4°C/48.4%
Polarity	Horizontal	Site / Test Engineer	AC1 / Jay Chiu
Test Mode	Transmit by 802.11ax-HE20 at Channel 2412MHz	Test Voltage	120V/60Hz

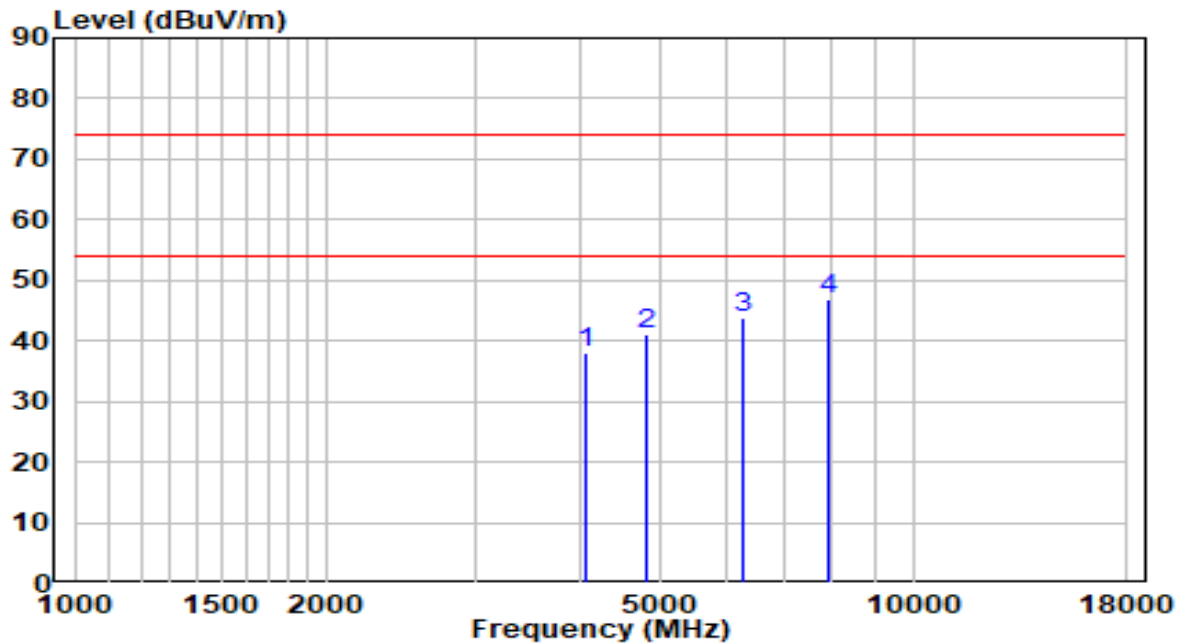

No	Frequency (MHz)	Reading (dBuV)	C.F (dB)	Measurement (dBuV/m)	Margin (dB)	Limit (dBuV/m)	Remark (QP/PK/AV)
1	4060.000	37.08	1.08	38.16	-35.84	74.00	Peak
2	4808.000	37.78	3.29	41.07	-32.93	74.00	Peak
3	6253.000	36.89	7.01	43.90	-30.10	74.00	Peak
4	* 7902.000	34.49	12.37	46.86	-27.14	74.00	Peak

Note:

1. " \*", means this data is the worst emission level.
2. C.F (Correction Factor) = Antenna Factor (dB)+ Cable Loss (dB)– Preamplifier(dB).
3. Measurement(dBuV/m) = Reading(dBuV) + C.F (Correction Factor).
- 4.The emission levels of other frequencies are very lower than the limit and not show in test report.

EUT	OAW-AP1301	Date of Test	2020-10-17
Factor	BBHA 9120D	Temp. / Humidity	25.4°C/48.4%
Polarity	Vertical	Site / Test Engineer	AC1 / Jay Chiu
Test Mode	Transmit by 802.11ax-HE20 at Channel 2412MHz	Test Voltage	120V/60Hz

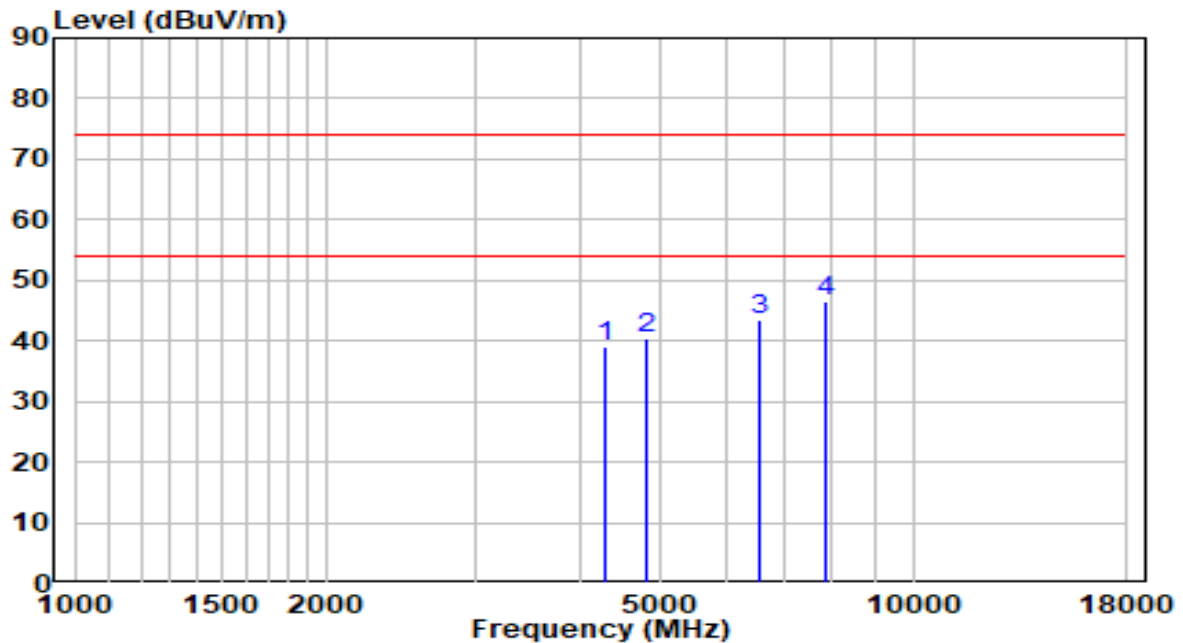

No	Frequency (MHz)	Reading (dBuV)	C.F (dB)	Measurement (dBuV/m)	Margin (dB)	Limit (dBuV/m)	Remark (QP/PK/AV)
1	4298.000	37.29	1.88	39.17	-34.83	74.00	Peak
2	4825.000	36.98	3.33	40.31	-33.69	74.00	Peak
3	6576.000	34.96	8.43	43.39	-30.61	74.00	Peak
4	* 7868.000	34.21	12.31	46.53	-27.47	74.00	Peak

Note:

- "\*" means this data is the worst emission level.
- C.F (Correction Factor) = Antenna Factor (dB)+ Cable Loss (dB)– Preamplifier(dB).
- Measurement(dBuV/m) = Reading(dBuV) + C.F (Correction Factor).
- The emission levels of other frequencies are very lower than the limit and not show in test report.

EUT	OAW-AP1301	Date of Test	2020-10-17
Factor	BBHA 9120D	Temp. / Humidity	25.4°C/48.4%
Polarity	Horizontal	Site / Test Engineer	AC1 / Jay Chiu
Test Mode	Transmit by 802.11ax-HE20 at Channel 2437MHz	Test Voltage	120V/60Hz

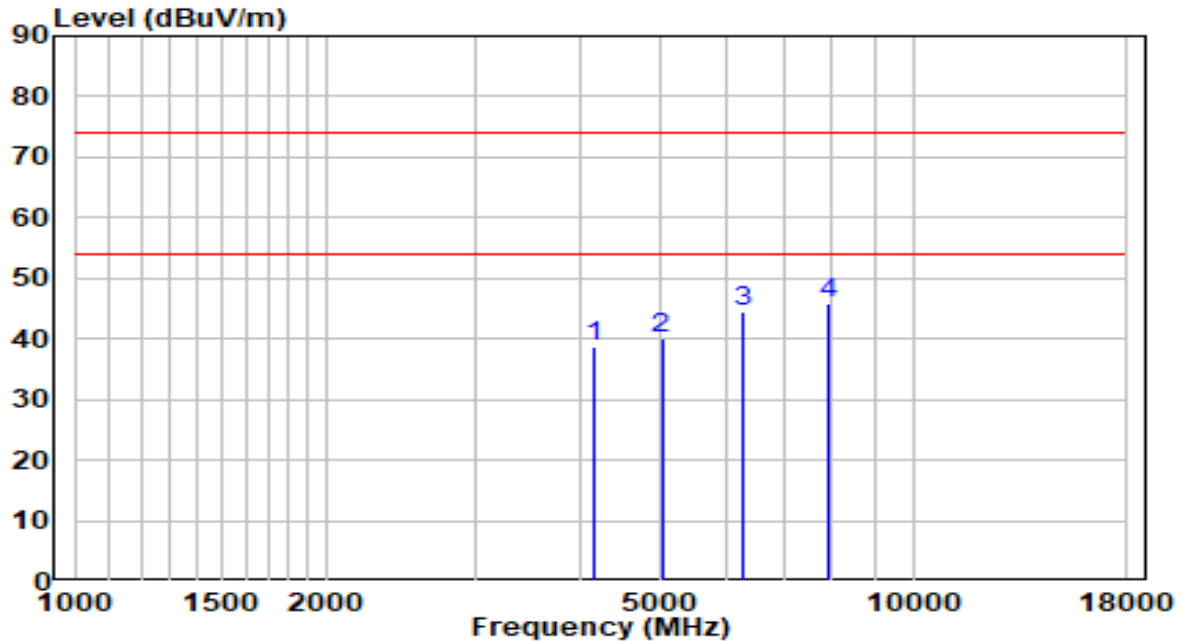

No	Frequency (MHz)	Reading (dBuV)	C.F (dB)	Measurement (dBuV/m)	Margin (dB)	Limit (dBuV/m)	Remark (QP/PK/AV)
1	4162.000	37.15	1.42	38.57	-35.43	74.00	Peak
2	5012.000	36.30	3.76	40.06	-33.94	74.00	Peak
3	6253.000	37.47	7.01	44.47	-29.53	74.00	Peak
4	* 7902.000	33.65	12.37	46.02	-27.98	74.00	Peak

Note:

1. " \*", means this data is the worst emission level.
2. C.F (Correction Factor) = Antenna Factor (dB)+ Cable Loss (dB)– Preamplifier(dB).
3. Measurement(dBuV/m) = Reading(dBuV) + C.F (Correction Factor).
- 4.The emission levels of other frequencies are very lower than the limit and not show in test report.

EUT	OAW-AP1301	Date of Test	2020-10-17
Factor	BBHA 9120D	Temp. / Humidity	25.4°C/48.4%
Polarity	Vertical	Site / Test Engineer	AC1 / Jay Chiu
Test Mode	Transmit by 802.11ax-HE20 at Channel 2437MHz	Test Voltage	120V/60Hz

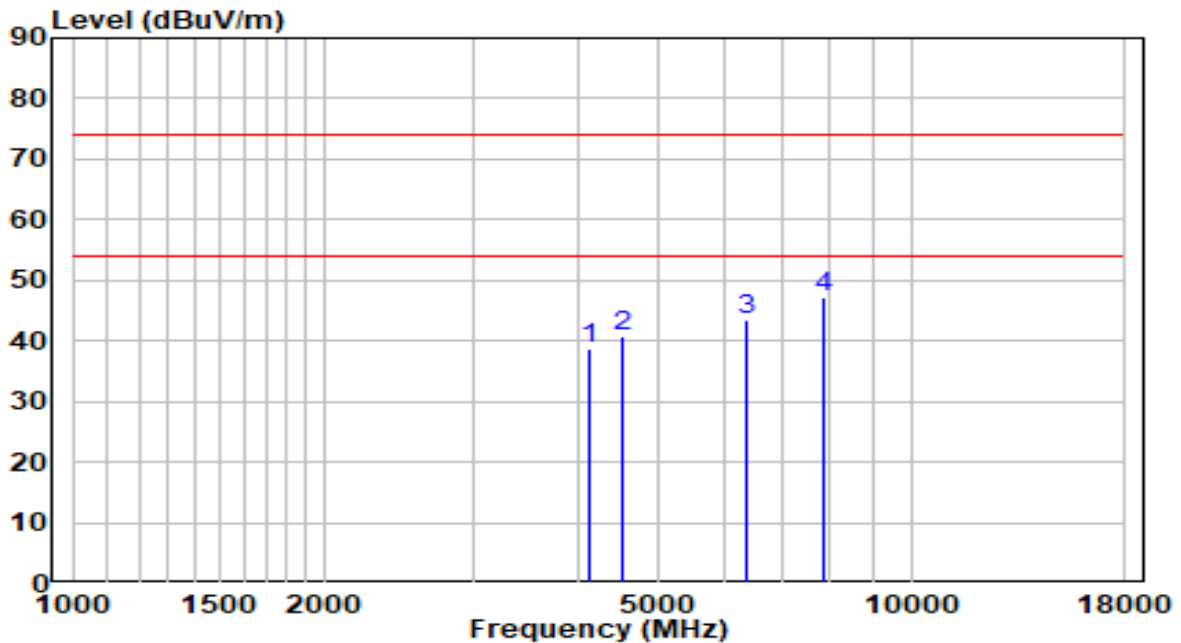

No	Frequency (MHz)	Reading (dBuV)	C.F (dB)	Measurement (dBuV/m)	Margin (dB)	Limit (dBuV/m)	Remark (QP/PK/AV)
1	4128.000	37.26	1.31	38.57	-35.43	74.00	Peak
2	4536.000	37.95	2.64	40.59	-33.41	74.00	Peak
3	6355.000	35.91	7.46	43.37	-30.63	74.00	Peak
4	* 7851.000	34.90	12.29	47.19	-26.81	74.00	Peak

Note:

1. " \*", means this data is the worst emission level.
2. C.F (Correction Factor) = Antenna Factor (dB)+ Cable Loss (dB)– Preamplifier(dB).
3. Measurement(dBuV/m) = Reading(dBuV) + C.F (Correction Factor).
- 4.The emission levels of other frequencies are very lower than the limit and not show in test report.

EUT	OAW-AP1301	Date of Test	2020-10-17
Factor	BBHA 9120D	Temp. / Humidity	25.4°C/48.4%
Polarity	Horizontal	Site / Test Engineer	AC1 / Jay Chiu
Test Mode	Transmit by 802.11ax-HE20 at Channel 2462MHz	Test Voltage	120V/60Hz

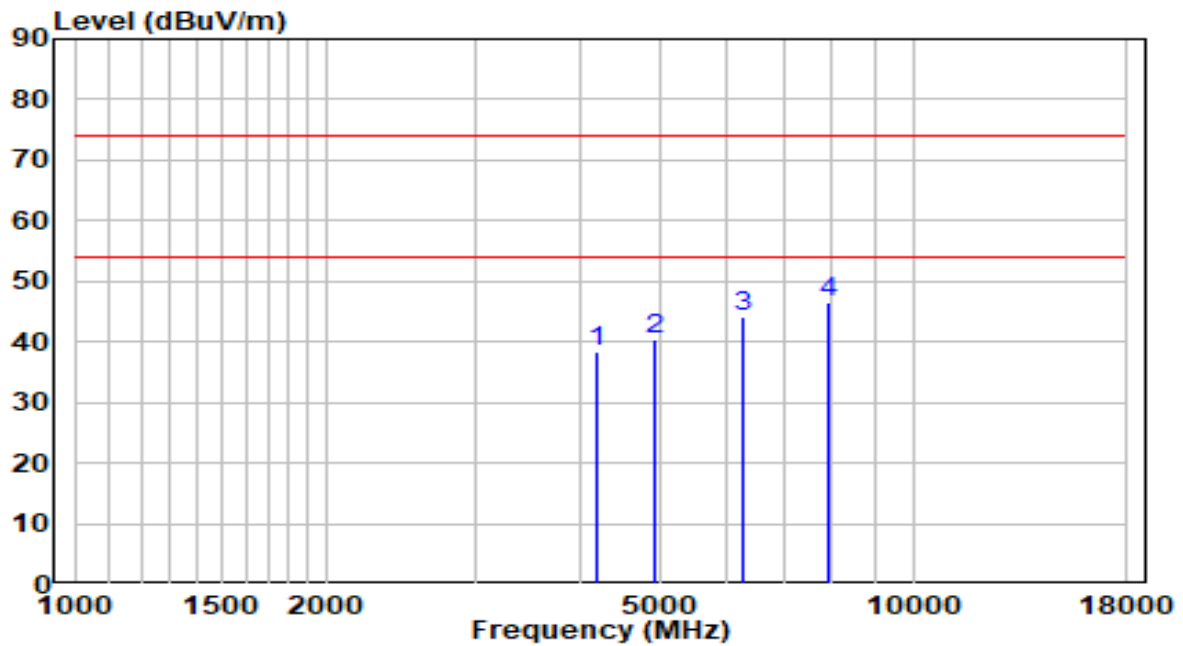

No	Frequency (MHz)	Reading (dBuV)	C.F (dB)	Measurement (dBuV/m)	Margin (dB)	Limit (dBuV/m)	Remark (QP/PK/AV)
1	4196.000	36.78	1.53	38.32	-35.68	74.00	Peak
2	4927.000	36.86	3.57	40.44	-33.56	74.00	Peak
3	6253.000	36.98	7.01	43.99	-30.01	74.00	Peak
4	* 7919.000	34.13	12.40	46.53	-27.47	74.00	Peak

Note:

1. " \*", means this data is the worst emission level.
2. C.F (Correction Factor) = Antenna Factor (dB)+ Cable Loss (dB)– Preamplifier(dB).
3. Measurement(dBuV/m) = Reading(dBuV) + C.F (Correction Factor).
- 4.The emission levels of other frequencies are very lower than the limit and not show in test report.

EUT	OAW-AP1301	Date of Test	2020-10-17
Factor	BBHA 9120D	Temp. / Humidity	25.4°C/48.4%
Polarity	Vertical	Site / Test Engineer	AC1 / Jay Chiu
Test Mode	Transmit by 802.11ax-HE20 at Channel 2462MHz	Test Voltage	120V/60Hz

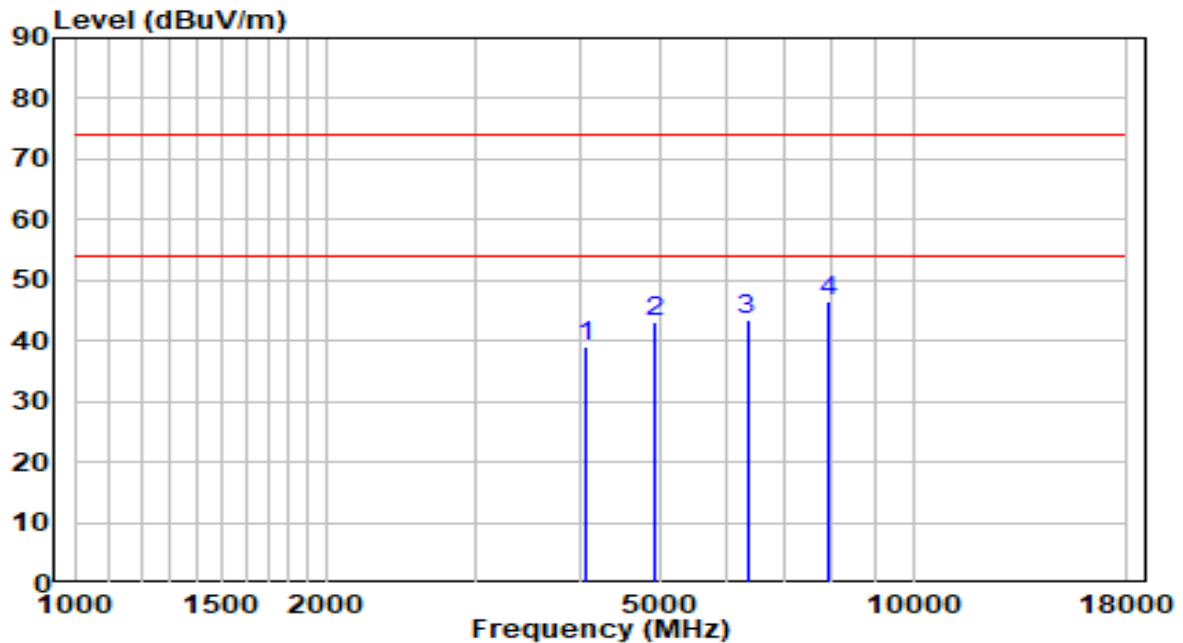

No	Frequency (MHz)	Reading (dBuV)	C.F (dB)	Measurement (dBuV/m)	Margin (dB)	Limit (dBuV/m)	Remark (QP/PK/AV)
1	4077.000	37.93	1.14	39.07	-34.93	74.00	Peak
2	4927.000	39.59	3.57	43.16	-30.84	74.00	Peak
3	6338.000	36.07	7.38	43.45	-30.55	74.00	Peak
4	* 7936.000	34.02	12.43	46.45	-27.55	74.00	Peak

Note:

1. " \*", means this data is the worst emission level.
2. C.F (Correction Factor) = Antenna Factor (dB)+ Cable Loss (dB)- Preamplifier(dB).
3. Measurement(dBuV/m) = Reading(dBuV) + C.F (Correction Factor).
- 4.The emission levels of other frequencies are very lower than the limit and not show in test report.



EUT	OAW-AP1301	Date of Test	2020-10-17
Factor	BBHA 9120D	Temp. / Humidity	25.4°C/48.4%
Polarity	Horizontal	Site / Test Engineer	AC1 / Jay Chiu
Test Mode	Transmit by 802.11ax-HE40 at Channel 2422MHz	Test Voltage	120V/60Hz

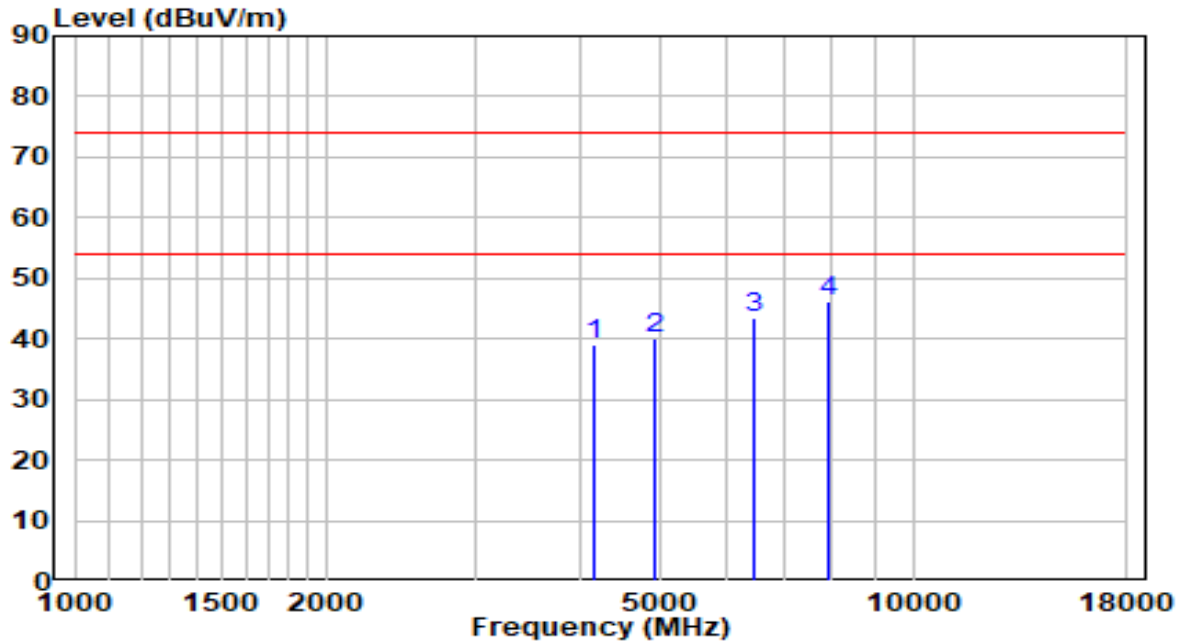

No	Frequency (MHz)	Reading (dBUV)	C.F (dB)	Measurement (dBUV/m)	Margin (dB)	Limit (dBUV/m)	Remark (QP/PK/AV)
1	4162.000	37.79	1.42	39.21	-34.79	74.00	Peak
2	4927.000	36.60	3.57	40.18	-33.82	74.00	Peak
3	6474.000	35.56	7.98	43.54	-30.46	74.00	Peak
4	* 7902.000	33.81	12.37	46.18	-27.82	74.00	Peak

Note:

1. " \*", means this data is the worst emission level.
2. C.F (Correction Factor) = Antenna Factor (dB)+ Cable Loss (dB)- Preamplifier(dB).
3. Measurement(dBUV/m) = Reading(dBUV) + C.F (Correction Factor).
- 4.The emission levels of other frequencies are very lower than the limit and not show in test report.

EUT	OAW-AP1301	Date of Test	2020-10-17
Factor	BBHA 9120D	Temp. / Humidity	25.4°C/48.4%
Polarity	Vertical	Site / Test Engineer	AC1 / Jay Chiu
Test Mode	Transmit by 802.11ax-HE40 at Channel 2422MHz	Test Voltage	120V/60Hz

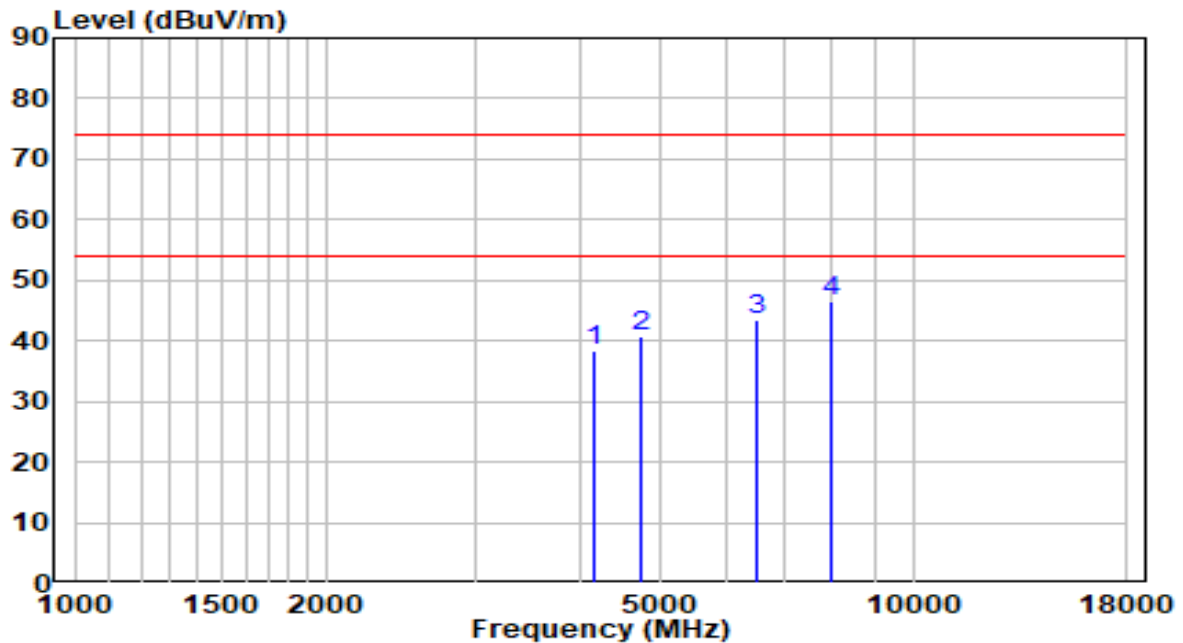

No	Frequency (MHz)	Reading (dBuV)	C.F (dB)	Measurement (dBuV/m)	Margin (dB)	Limit (dBuV/m)	Remark (QP/PK/AV)
1	4162.000	37.02	1.42	38.44	-35.56	74.00	Peak
2	4740.000	37.74	3.13	40.87	-33.13	74.00	Peak
3	6525.000	35.24	8.21	43.45	-30.55	74.00	Peak
4	* 7970.000	33.95	12.48	46.43	-27.57	74.00	Peak

Note:

1. " \*", means this data is the worst emission level.
2. C.F (Correction Factor) = Antenna Factor (dB)+ Cable Loss (dB)- Preamplifier(dB).
3. Measurement(dBuV/m) = Reading(dBuV) + C.F (Correction Factor).
- 4.The emission levels of other frequencies are very lower than the limit and not show in test report.

EUT	OAW-AP1301	Date of Test	2020-10-17
Factor	BBHA 9120D	Temp. / Humidity	25.4°C/48.4%
Polarity	Horizontal	Site / Test Engineer	AC1 / Jay Chiu
Test Mode	Transmit by 802.11ax-HE40 at Channel 2437MHz	Test Voltage	120V/60Hz

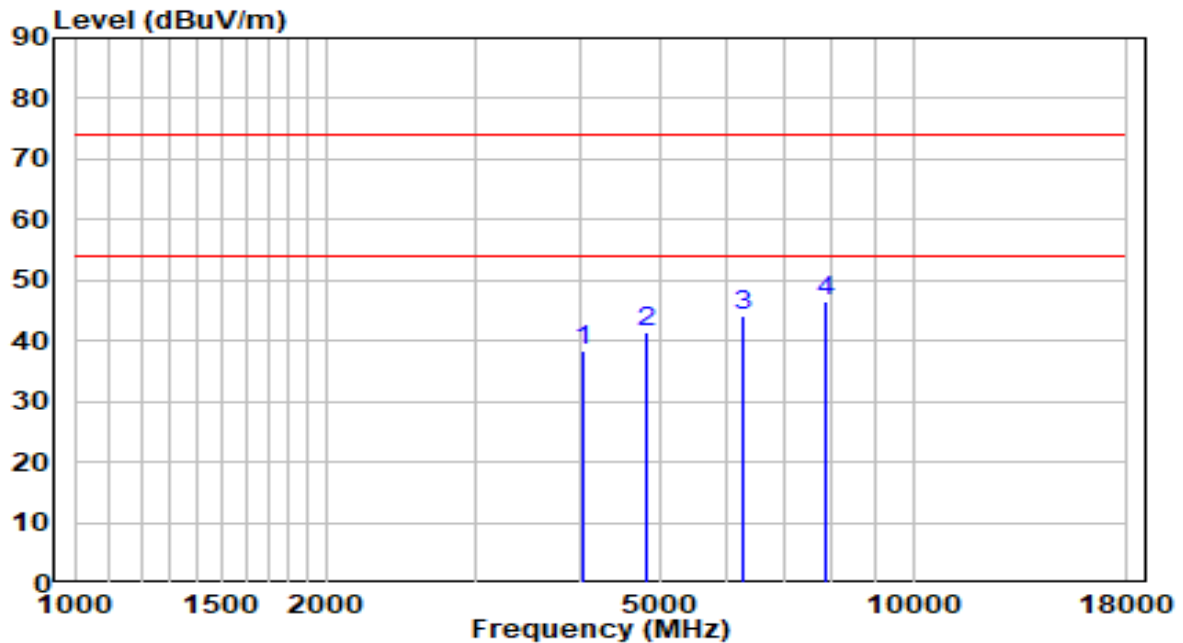

No	Frequency (MHz)	Reading (dBuV)	C.F (dB)	Measurement (dBuV/m)	Margin (dB)	Limit (dBuV/m)	Remark (QP/PK/AV)
1	4026.000	37.24	0.97	38.21	-35.79	74.00	Peak
2	4808.000	38.02	3.29	41.31	-32.69	74.00	Peak
3	6253.000	37.18	7.01	44.19	-29.81	74.00	Peak
4	* 7868.000	34.05	12.31	46.36	-27.64	74.00	Peak

Note:

- "\*" means this data is the worst emission level.
- C.F (Correction Factor) = Antenna Factor (dB)+ Cable Loss (dB)- Preamplifier(dB).
- Measurement(dBuV/m) = Reading(dBuV) + C.F (Correction Factor).
- The emission levels of other frequencies are very lower than the limit and not show in test report.

EUT	OAW-AP1301	Date of Test	2020-10-17
Factor	BBHA 9120D	Temp. / Humidity	25.4°C/48.4%
Polarity	Vertical	Site / Test Engineer	AC1 / Jay Chiu
Test Mode	Transmit by 802.11ax-HE40 at Channel 2437MHz	Test Voltage	120V/60Hz

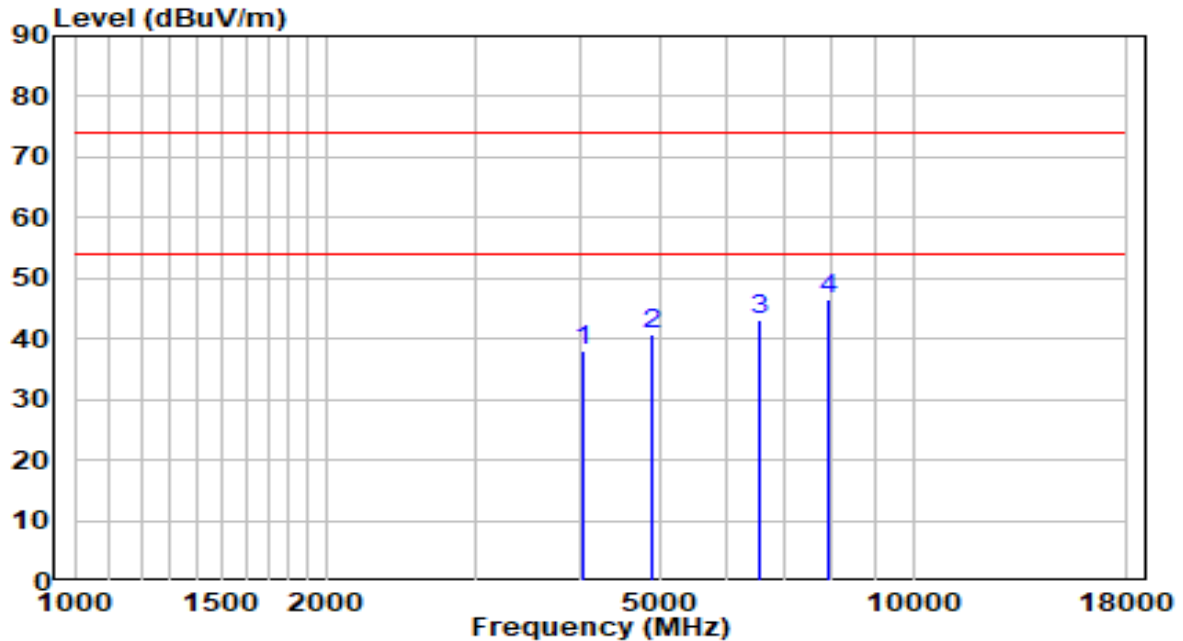

No	Frequency (MHz)	Reading (dBuV)	C.F (dB)	Measurement (dBuV/m)	Margin (dB)	Limit (dBuV/m)	Remark (QP/PK/AV)
1	4026.000	37.21	0.97	38.18	-35.82	74.00	Peak
2	4876.000	37.40	3.45	40.85	-33.15	74.00	Peak
3	6559.000	34.85	8.36	43.21	-30.79	74.00	Peak
4	* 7936.000	34.06	12.43	46.49	-27.51	74.00	Peak

Note:

- "\*" means this data is the worst emission level.
- C.F (Correction Factor) = Antenna Factor (dB)+ Cable Loss (dB)– Preamplifier(dB).
- Measurement(dBuV/m) = Reading(dBuV) + C.F (Correction Factor).
- The emission levels of other frequencies are very lower than the limit and not show in test report.

EUT	OAW-AP1301	Date of Test	2020-10-17
Factor	BBHA 9120D	Temp. / Humidity	25.4°C/48.4%
Polarity	Horizontal	Site / Test Engineer	AC1 / Jay Chiu
Test Mode	Transmit by 802.11ax-HE40 at Channel 2452MHz	Test Voltage	120V/60Hz

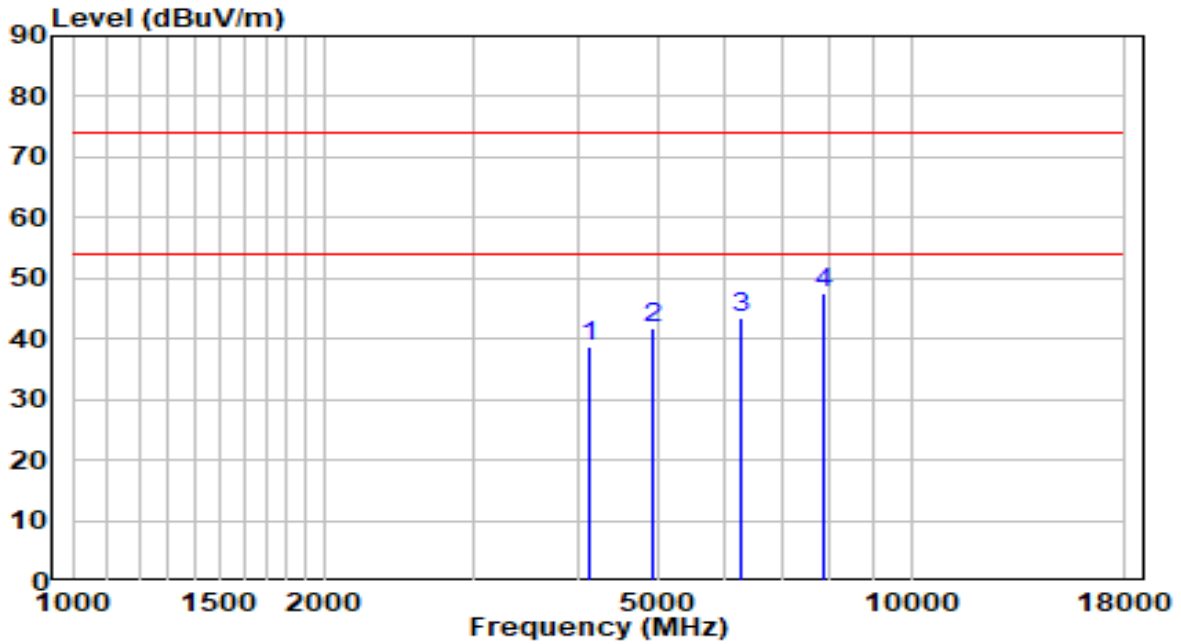

No	Frequency (MHz)	Reading (dBuV)	C.F (dB)	Measurement (dBuV/m)	Margin (dB)	Limit (dBuV/m)	Remark (QP/PK/AV)
1	4128.000	37.55	1.31	38.86	-35.14	74.00	Peak
2	4910.000	38.13	3.53	41.66	-32.34	74.00	Peak
3	6253.000	36.54	7.01	43.54	-30.46	74.00	Peak
4	* 7885.000	35.22	12.34	47.56	-26.44	74.00	Peak

Note:

1. " \*", means this data is the worst emission level.
2. C.F (Correction Factor) = Antenna Factor (dB)+ Cable Loss (dB)– Preamplifier(dB).
3. Measurement(dBuV/m) = Reading(dBuV) + C.F (Correction Factor).
- 4.The emission levels of other frequencies are very lower than the limit and not show in test report.

EUT	OAW-AP1301	Date of Test	2020-10-17
Factor	BBHA 9120D	Temp. / Humidity	25.4°C/48.4%
Polarity	Vertical	Site / Test Engineer	AC1 / Jay Chiu
Test Mode	Transmit by 802.11ax-HE40 at Channel 2452MHz	Test Voltage	120V/60Hz

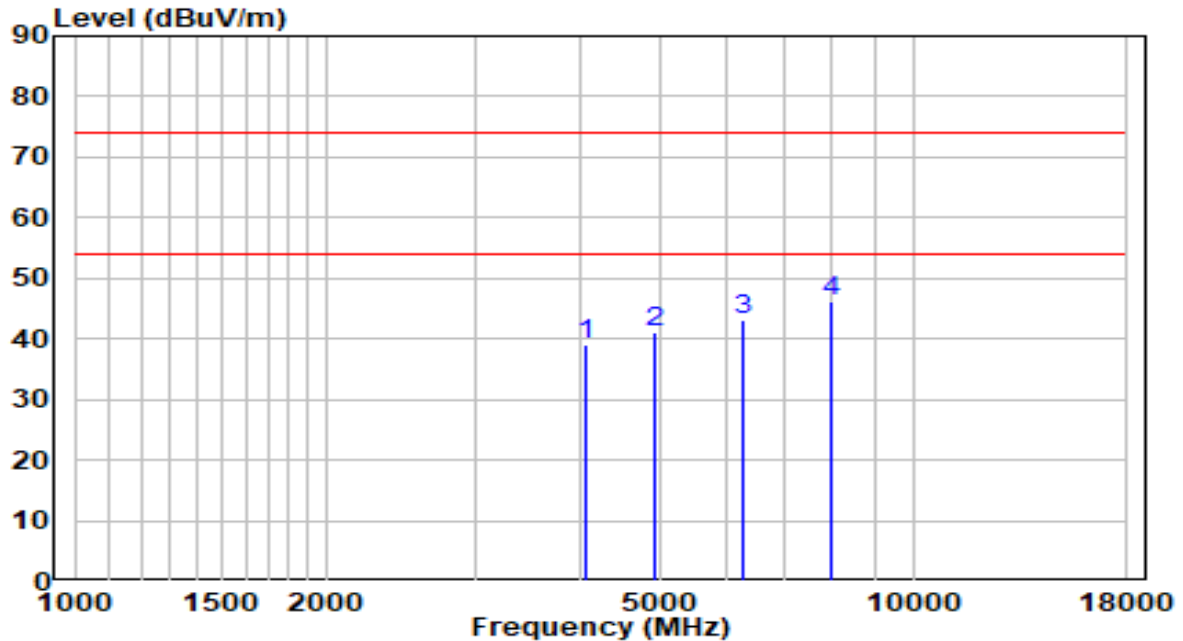

No	Frequency (MHz)	Reading (dBuV)	C.F (dB)	Measurement (dBuV/m)	Margin (dB)	Limit (dBuV/m)	Remark (QP/PK/AV)
1	4060.000	37.81	1.08	38.89	-35.11	74.00	Peak
2	4910.000	37.43	3.53	40.96	-33.04	74.00	Peak
3	6253.000	36.29	7.01	43.30	-30.70	74.00	Peak
4	* 7970.000	33.82	12.48	46.30	-27.70	74.00	Peak

Note:

1. " \*", means this data is the worst emission level.
2. C.F (Correction Factor) = Antenna Factor (dB)+ Cable Loss (dB)- Preamplifier(dB).
3. Measurement(dBuV/m) = Reading(dBuV) + C.F (Correction Factor).
- 4.The emission levels of other frequencies are very lower than the limit and not show in test report.

**The worst case of Radiated Emission below 1GHz:**

EUT	OAW-AP1301	Date of Test	2020-11-29
Factor	VULB 9162	Temp. / Humidity	25°C /54%
Polarity	Horizontal	Site / Test Engineer	AC1 / Jay Chiu
Test Mode	Transmit by 802.11b at channel 2412MHz	Test Voltage	120V/60Hz

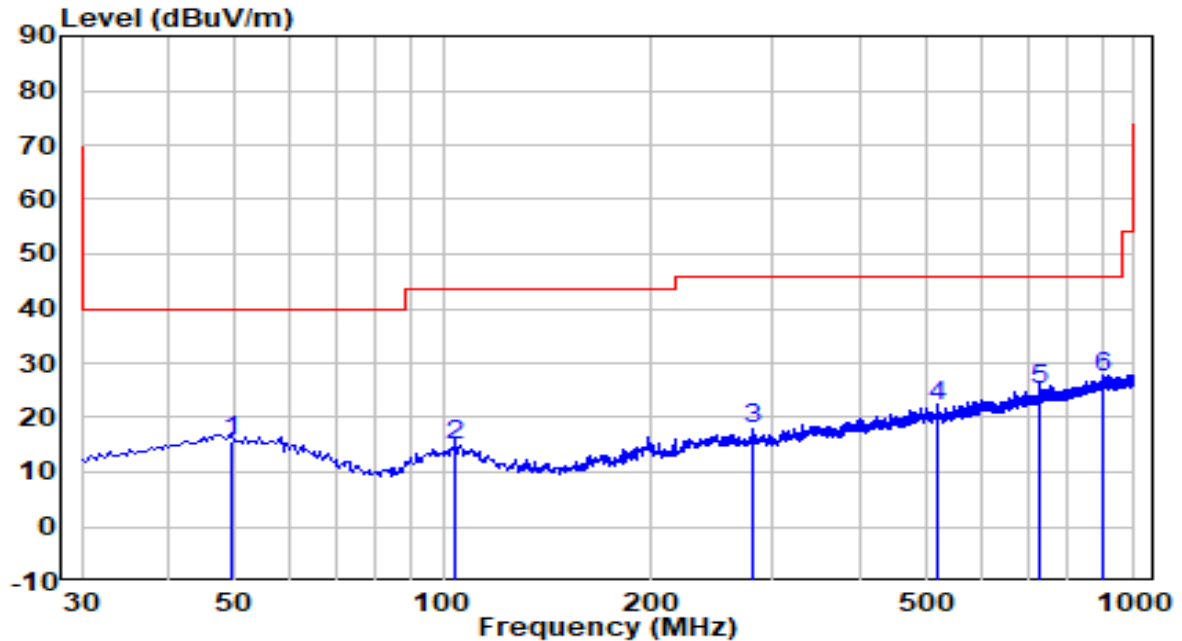

No	Frequency (MHz)	Reading (dBuV)	C.F (dB)	Measurement (dBuV/m)	Margin (dB)	Limit (dBuV/m)	Remark (QP/PK/AV)
1	49.400	-6.29	22.02	15.73	-24.27	40.00	QP
2	104.205	-4.17	18.98	14.81	-28.69	43.50	QP
3	281.715	-3.30	21.08	17.78	-28.22	46.00	QP
4	519.850	-4.38	26.45	22.07	-23.93	46.00	QP
5	727.430	-4.48	29.75	25.27	-20.73	46.00	QP
6	* 898.150	-4.47	31.76	27.29	-18.71	46.00	QP

Note:

- "\*", means this data is the worst emission level.
- C.F (Correction Factor) = Antenna Factor (dB)+ Cable Loss (dB).
- Measurement(dBuV/m) = Reading(dBuV) + C.F (Correction Factor).
- The emission levels of other frequencies are very lower than the limit and not show in test report.
- The amplitude of Radiated emissions (the test frequency range: 9kHz ~ 30MHz, 18GHz ~ 25GHz), is that proximity to ambient noise, which also are attenuated more than 20 dB below the permissible value. Therefore, the data is not presented in the report.

EUT	OAW-AP1301	Date of Test	2020-11-29
Factor	VULB 9162	Temp. / Humidity	25°C /54%
Polarity	Vertical	Site / Test Engineer	AC1 / Jay Chiu
Test Mode	Transmit by 802.11b at channel 2412MHz	Test Voltage	120V/60Hz

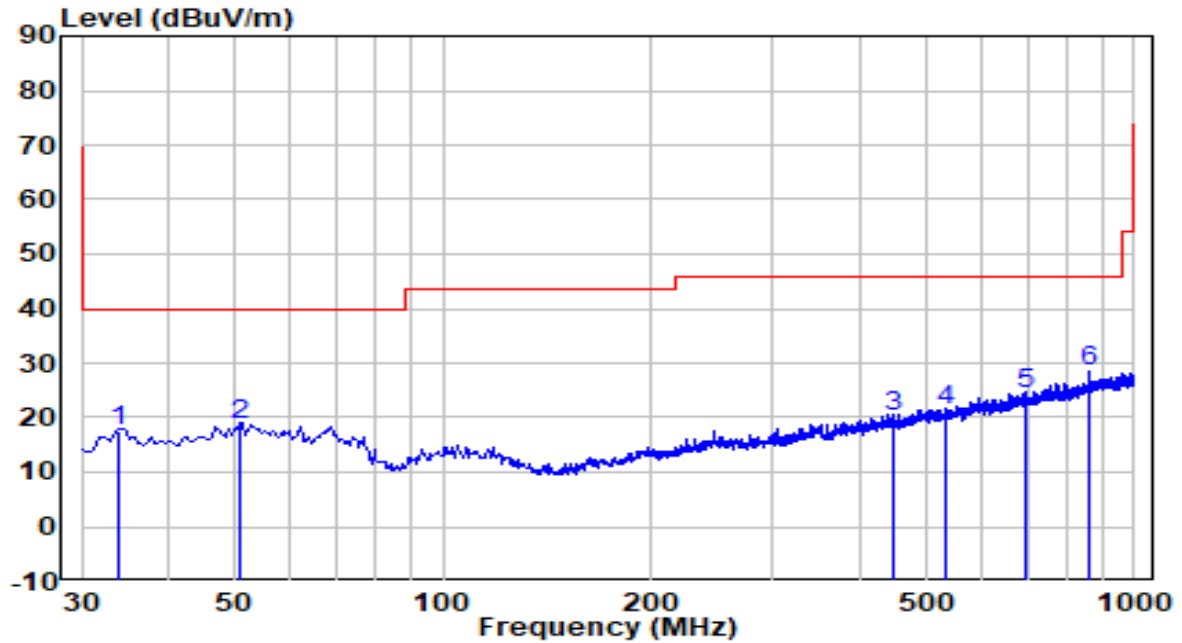

No	Frequency (MHz)	Reading (dBuV)	C.F (dB)	Measurement (dBuV/m)	Margin (dB)	Limit (dBuV/m)	Remark (QP/PK/AV)
1	33.880	-1.74	19.11	17.37	-22.63	40.00	QP
2	50.855	-3.12	21.89	18.77	-21.23	40.00	QP
3	447.100	-4.78	24.84	20.06	-25.94	46.00	QP
4	533.915	-5.22	26.62	21.40	-24.60	46.00	QP
5	695.420	-5.04	29.25	24.21	-21.79	46.00	QP
6	* 859.350	-3.11	31.54	28.43	-17.57	46.00	QP

Note:

- "\*" means this data is the worst emission level.
- C.F (Correction Factor) = Antenna Factor (dB)+ Cable Loss (dB).
- Measurement(dBuV/m) = Reading(dBuV) + C.F (Correction Factor).
- The emission levels of other frequencies are very lower than the limit and not show in test report.
- The amplitude of Radiated emissions (the test frequency range: 9kHz ~ 30MHz, 18GHz ~ 25GHz), is that proximity to ambient noise, which also are attenuated more than 20 dB below the permissible value. Therefore, the data is not presented in the report.



**Co-location Mode:**

EUT	OAW-AP1311	Date of Test	2020-10-12
Factor	BBHA 9120D	Temp. / Humidity	25.8°C/48.0%
Polarity	Horizontal	Site / Test Engineer	AC1 / Jay Chiu
Test Mode	2.4G Wi-Fi+5G Wi-Fi Transmit	Test Voltage	120V/60Hz

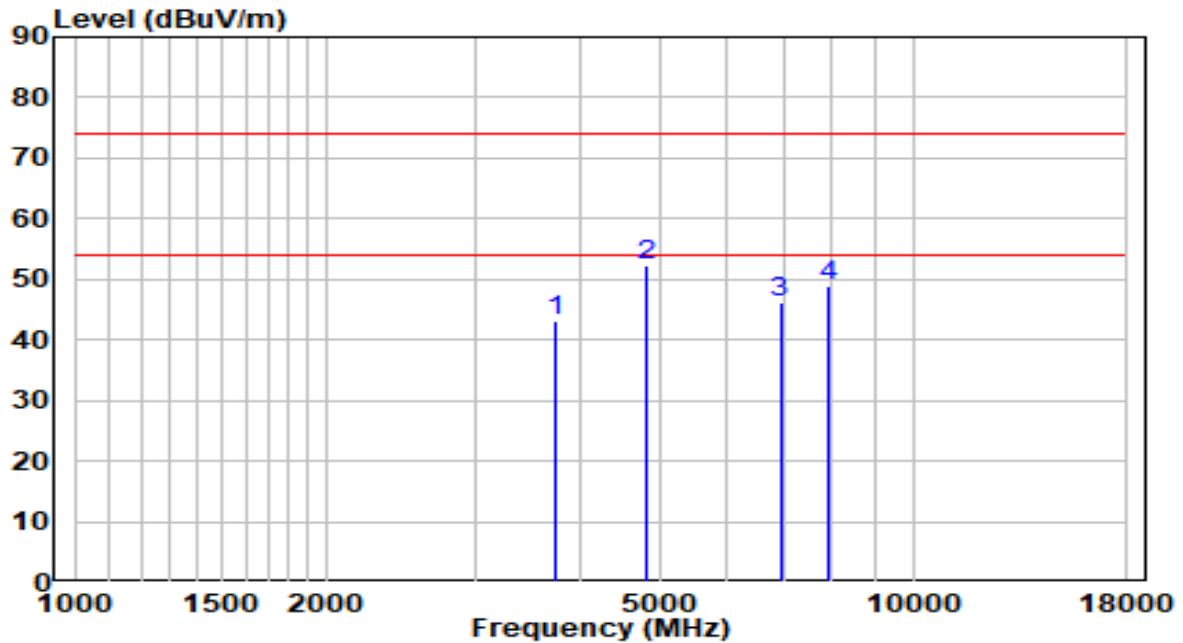

No	Frequency (MHz)	Reading (dBuV)	C.F (dB)	Measurement (dBuV/m)	Margin (dB)	Limit (dBuV/m)	Remark (QP/PK/AV)
1	3745.500	43.04	0.00	43.05	-30.95	74.00	Peak
2	* 4808.000	48.97	3.29	52.26	-21.74	74.00	Peak
3	6941.500	36.30	10.04	46.35	-27.65	74.00	Peak
4	7953.000	36.55	12.45	49.00	-25.00	74.00	Peak

**Note:**

- "\*" means this data is the worst emission level.
- C.F (Correction Factor) = Antenna Factor (dB)+ Cable Loss (dB)– Preamplifier(dB).
- Measurement(dBuV/m) = Reading(dBuV) + C.F (Correction Factor).
- The emission levels of other frequencies are very lower than the limit and not show in test report.

EUT	OAW-AP1311	Date of Test	2020-10-12
Factor	BBHA 9120D	Temp. / Humidity	25.8°C/48.0%
Polarity	Vertical	Site / Test Engineer	AC1 / Jay Chiu
Test Mode	2.4G Wi-Fi+5G Wi-Fi Transmit	Test Voltage	120V/60Hz

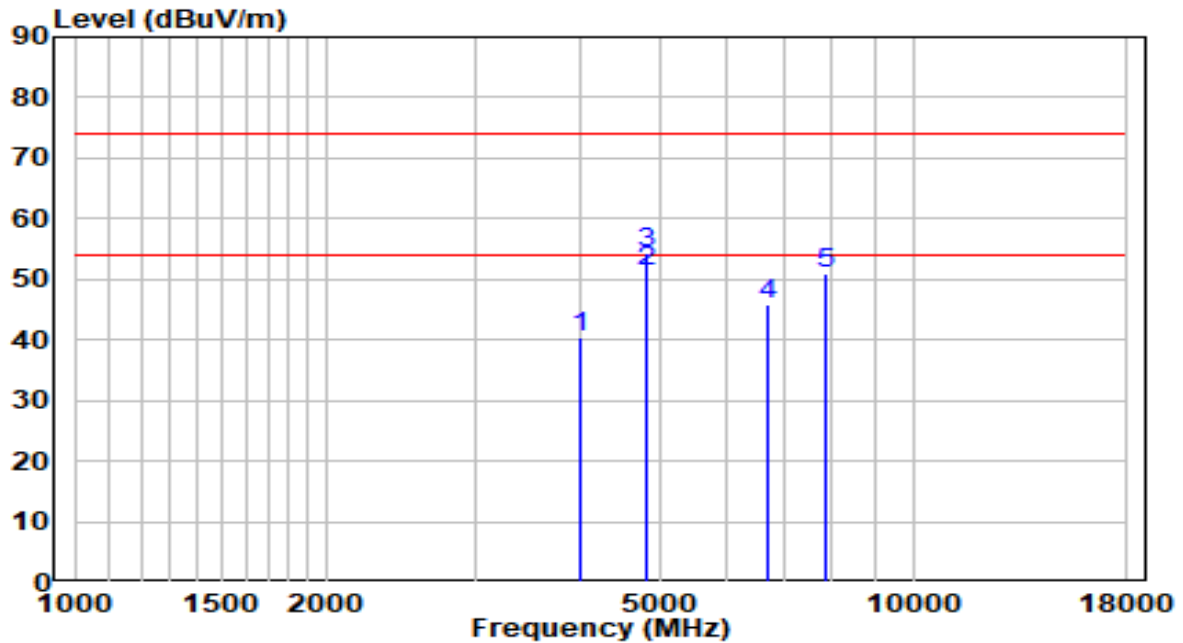

No	Frequency (MHz)	Reading (dBuV)	C.F (dB)	Measurement (dBuV/m)	Margin (dB)	Limit (dBuV/m)	Remark (QP/PK/AV)
1	4000.500	39.57	0.88	40.45	-33.55	74.00	Peak
2	* 4804.000	51.16	3.29	54.45	-19.55	74.00	Peak
3	4804.000	47.93	3.29	51.22	-2.78	54.00	Average
4	6703.500	36.91	8.99	45.90	-28.10	74.00	Peak
5	7876.500	38.47	12.33	50.79	-23.21	74.00	Peak

Note:

- "\*", means this data is the worst emission level.
- C.F (Correction Factor) = Antenna Factor (dB)+ Cable Loss (dB)- Preamplifier(dB).
- Measurement(dBuV/m) = Reading(dBuV) + C.F (Correction Factor).
- The emission levels of other frequencies are very lower than the limit and not show in test report.

## 6.7. Radiated Restricted Band Edge Measurement

### 6.7.1. Test Limit

#### For 15.205 requirement:

Radiated emissions which fall in the restricted bands, as defined in Section 15.205(a) of FCC part 15, must also comply with the radiated emission limits specified in Section 15.209(a).

Frequency (MHz)	Frequency (MHz)	Frequency (MHz)	Frequency (GHz)
0.090 - 0.110	16.42 - 16.423	399.9 - 410	4.5 - 5.15
<sup>1</sup> 0.495 - 0.505	16.69475 - 16.69525	608 - 614	5.35 - 5.46
2.1735 - 2.1905	16.80425 - 16.80475	960 - 1240	7.25 - 7.75
4.125 - 4.128	25.5 - 25.67	1300 - 1427	8.025 - 8.5
4.17725 - 4.17775	37.5 - 38.25	1435 - 1626.5	9.0 - 9.2
4.20725 - 4.20775	73 - 74.6	1645.5 - 1646.5	9.3 - 9.5
6.215 - 6.218	74.8 - 75.2	1660 - 1710	10.6 - 12.7
6.26775 - 6.26825	108 - 121.94	1718.8 - 1722.2	13.25 - 13.4
6.31175 - 6.31225	123 - 138	2200 - 2300	14.47 - 14.5
8.291 - 8.294	149.9 - 150.05	2310 - 2390	15.35 - 16.2
8.362 - 8.366	156.52475 - 156.525	2483.5 - 2500	17.7 - 21.4
8.37625 - 8.38675	156.7 - 156.9	2690 - 2900	22.01 - 23.12
8.41425 - 8.41475	162.0125 - 167.17	3260 - 3267	23.6 - 24.0
12.29 - 12.293	167.72 - 173.2	3332 - 3339	31.2 - 31.8
12.51975 - 12.52025	240 - 285	3345.8 - 3358	36.43 - 36.5
12.57675 - 12.57725	322 - 335.4	3600 - 4400	( <sup>2</sup> )
13.36 - 13.41	--	--	--

All out of band emissions appearing in a restricted band as specified in Section 15.205 of the Title 47CFR must not exceed the limits shown in Table per Section 15.209.

FCC Part 15 Subpart C Paragraph 15.209		
Frequency (MHz]	Field Strength (uV/m]	Measured Distance (Meters)
0.009 - 0.490	2400/F (kHz)	300
0.490 - 1.705	24000/F (kHz)	30
1.705 - 30	30	30
30 - 88	100	3
88 - 216	150	3
216 - 960	200	3
Above 960	500	3

**6.7.2. Test Procedure Used**

ANSI C63.10 Section 6.3 (General Requirements)

ANSI C63.10 Section 6.6 (Standard test method above 1GHz)

**6.7.3. Test Setting**

**Peak Field Strength Measurements**

1. Analyzer center frequency was set to the frequency of the radiated spurious emission of interest
2. RBW = 1MHz
3. VBW = 3MHz
4. Detector = peak
5. Sweep time = auto couple
6. Trace mode = max hold
7. Trace was allowed to stabilize

### Average Field Strength Measurements

1. Analyzer center frequency was set to the frequency of the radiated spurious emission of interest
2. RBW = 1MHz
3. VBW  $\geq 1/T$
4. De As an alternative, the instrument may be set to linear detector mode. Ensure that video filtering is applied in linear voltage domain (rather than in a log or dB domain). Some instruments require linear display mode in order to accomplish this. Others have a setting for Average-VBW Type, which can be set to "Voltage" regardless of the display mode
5. Detector = Peak
6. Sweep time = auto
7. Trace mode = max hold
8. Allow max hold to run for at least 50 times (1/duty cycle) traces

#### 6.7.4. Test Setup

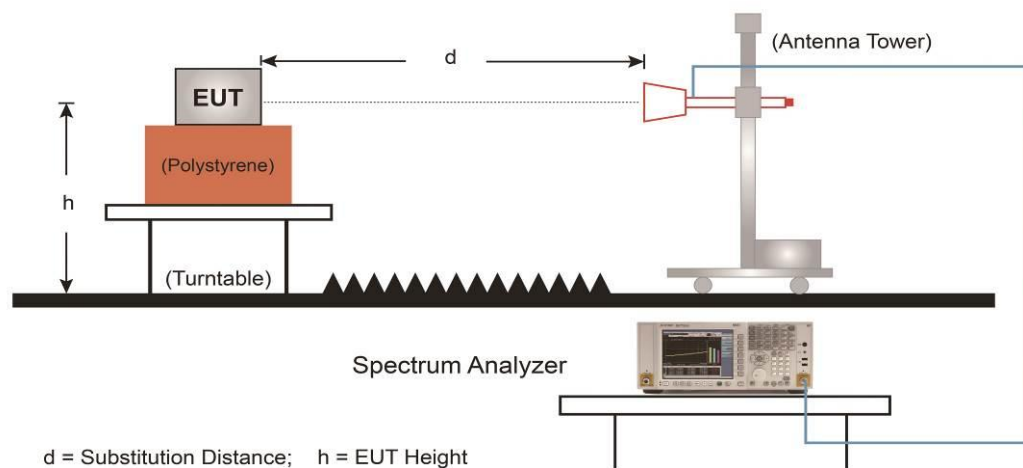

### 6.7.5. Test Result

EUT	OAW-AP1301	Date of Test	2020-11-26
Factor	BBHA 9120D	Temp. / Humidity	23.7°C/42%
Polarity	Horizontal	Site / Test Engineer	AC1 / Jay Chiu
Test Mode	Transmit by 802.11b at Channel 2412MHz	Test Voltage	120V/60Hz

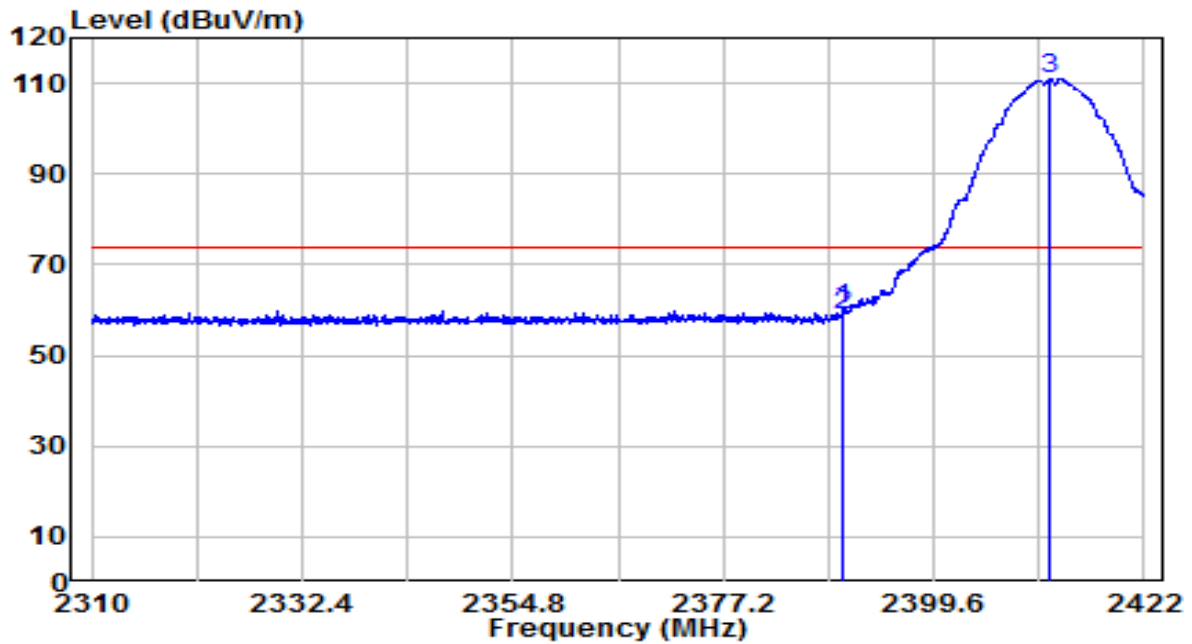

No	Frequency (MHz)	Reading (dBuV)	C.F (dB)	Measurement (dBuV/m)	Margin (dB)	Limit (dBuV/m)	Remark (QP/PK/AV)
1	2389.856	27.84	32.30	60.13	-13.87	74.00	Peak
2	2390.000	26.77	32.30	59.07	-14.93	74.00	Peak
3	* 2412.032	78.50	32.39	110.89	N/A	N/A	Peak

Note:

1. " \*", means this data is the worst emission level.
2. C.F (Correction Factor) = Antenna Factor (dB)+ Cable Loss (dB).
3. Measurement(dBuV/m) = Reading(dBuV) + C.F (Correction Factor).
4. The emission levels of other frequencies are very lower than the limit and not show in test report.

EUT	OAW-AP1301	Date of Test	2020-11-26
Factor	BBHA 9120D	Temp. / Humidity	23.7°C/42%
Polarity	Horizontal	Site / Test Engineer	AC1 / Jay Chiu
Test Mode	Transmit by 802.11b at Channel 2412MHz	Test Voltage	120V/60Hz

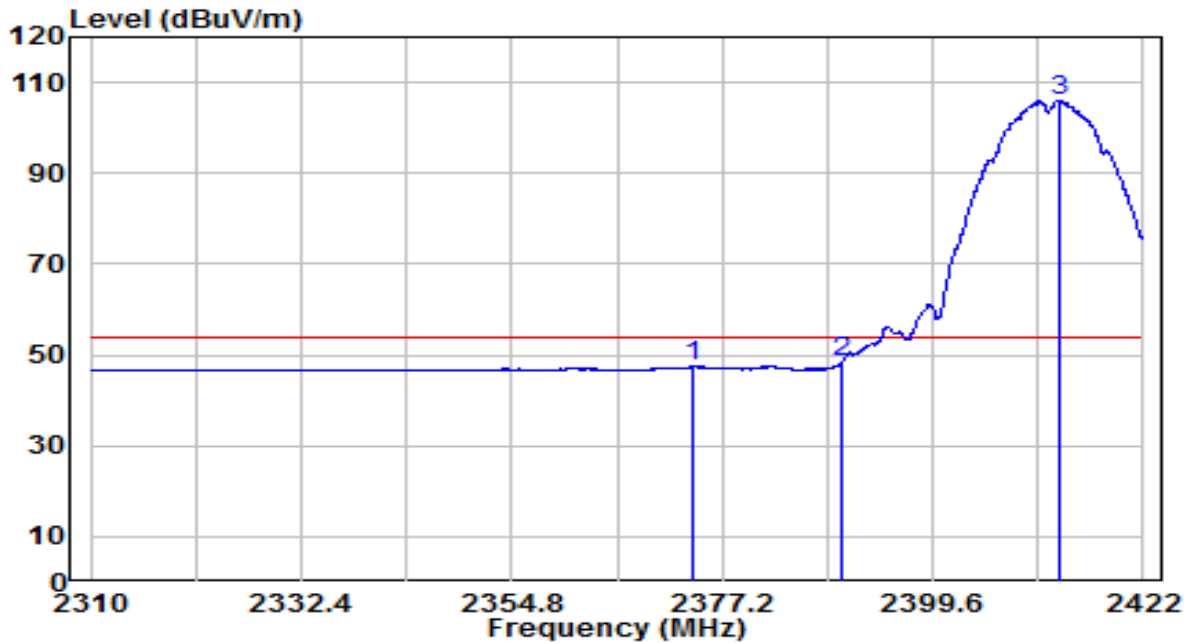

No	Frequency (MHz)	Reading (dBuV)	C.F (dB)	Measurement (dBuV/m)	Margin (dB)	Limit (dBuV/m)	Remark (QP/PK/AV)
1	2374.064	15.21	32.23	47.44	-6.56	54.00	Average
2	2390.024	16.29	32.30	48.58	-5.42	54.00	Average
3	* 2413.208	73.60	32.40	106.00	N/A	N/A	Average

Note:

1. " \*", means this data is the worst emission level.
2. C.F (Correction Factor) = Antenna Factor (dB)+ Cable Loss (dB).
3. Measurement(dBuV/m) = Reading(dBuV) + C.F (Correction Factor).
4. The emission levels of other frequencies are very lower than the limit and not show in test report.

EUT	OAW-AP1301	Date of Test	2020-11-26
Factor	BBHA 9120D	Temp. / Humidity	23.7°C/42%
Polarity	Vertical	Site / Test Engineer	AC1 / Jay Chiu
Test Mode	Transmit by 802.11b at Channel 2412MHz	Test Voltage	120V/60Hz

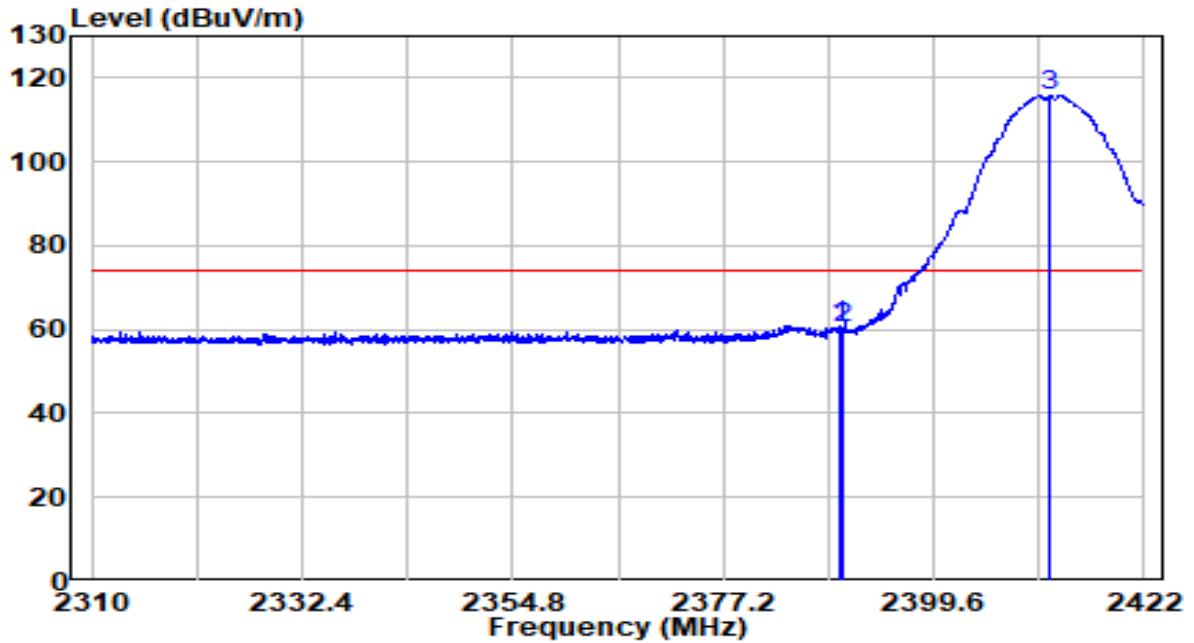

No	Frequency (MHz)	Reading (dBuV)	C.F (dB)	Measurement (dBuV/m)	Margin (dB)	Limit (dBuV/m)	Remark (QP/PK/AV)
1	2389.744	28.71	32.29	61.00	-13.00	74.00	Peak
2	2390.000	27.96	32.30	60.25	-13.75	74.00	Peak
3	* 2411.976	83.35	32.39	115.74	N/A	N/A	Peak

Note:

1. " \*", means this data is the worst emission level.
2. C.F (Correction Factor) = Antenna Factor (dB)+ Cable Loss (dB).
3. Measurement(dBuV/m) = Reading(dBuV) + C.F (Correction Factor).
4. The emission levels of other frequencies are very lower than the limit and not show in test report.



EUT	OAW-AP1301	Date of Test	2020-11-26
Factor	BBHA 9120D	Temp. / Humidity	23.7°C/42%
Polarity	Vertical	Site / Test Engineer	AC1 / Jay Chiu
Test Mode	Transmit by 802.11b at Channel 2412MHz	Test Voltage	120V/60Hz

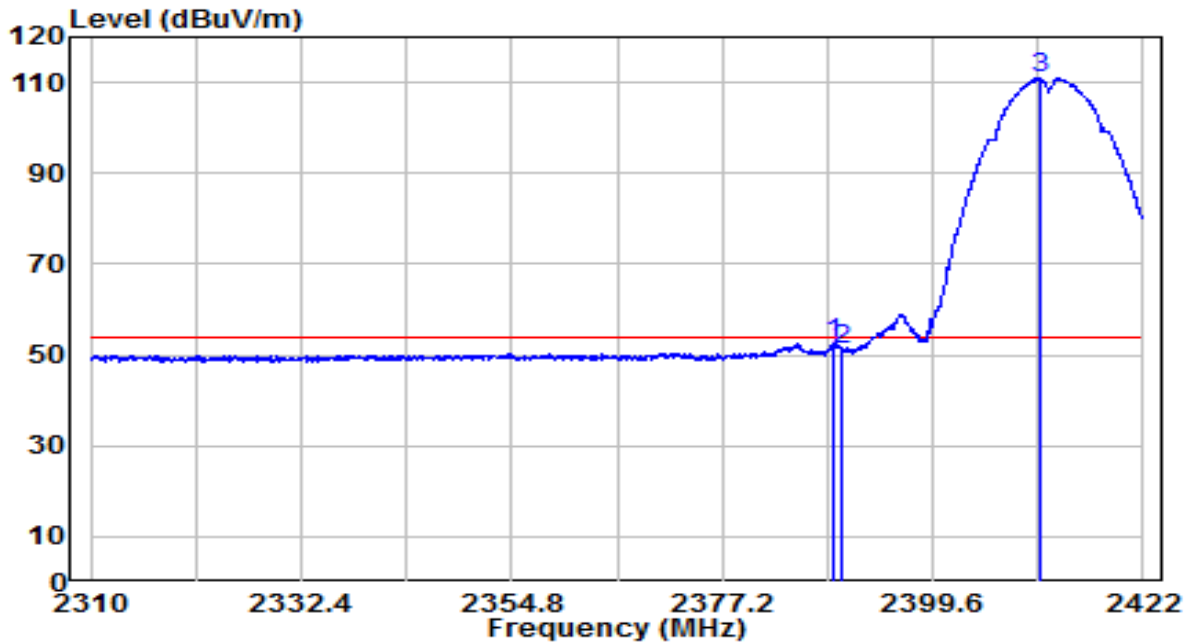

No	Frequency (MHz)	Reading (dBuV)	C.F (dB)	Measurement (dBuV/m)	Margin (dB)	Limit (dBuV/m)	Remark (QP/PK/AV)
1	2389.016	20.35	32.29	52.64	-1.36	54.00	Average
2	2390.000	19.04	32.30	51.33	-2.67	54.00	Average
3	* 2411.080	78.75	32.39	111.14	N/A	N/A	Average

Note:

1. " \*", means this data is the worst emission level.
2. C.F (Correction Factor) = Antenna Factor (dB)+ Cable Loss (dB).
3. Measurement(dBuV/m) = Reading(dBuV) + C.F (Correction Factor).
4. The emission levels of other frequencies are very lower than the limit and not show in test report.

EUT	OAW-AP1301	Date of Test	2020-12-18
Factor	BBHA 9120D	Temp. / Humidity	21.2°C/23%
Polarity	Vertical	Site / Test Engineer	AC1 / Jay Chiu
Test Mode	Transmit by 802.11b at Channel 2457MHz	Test Voltage	120V/60Hz

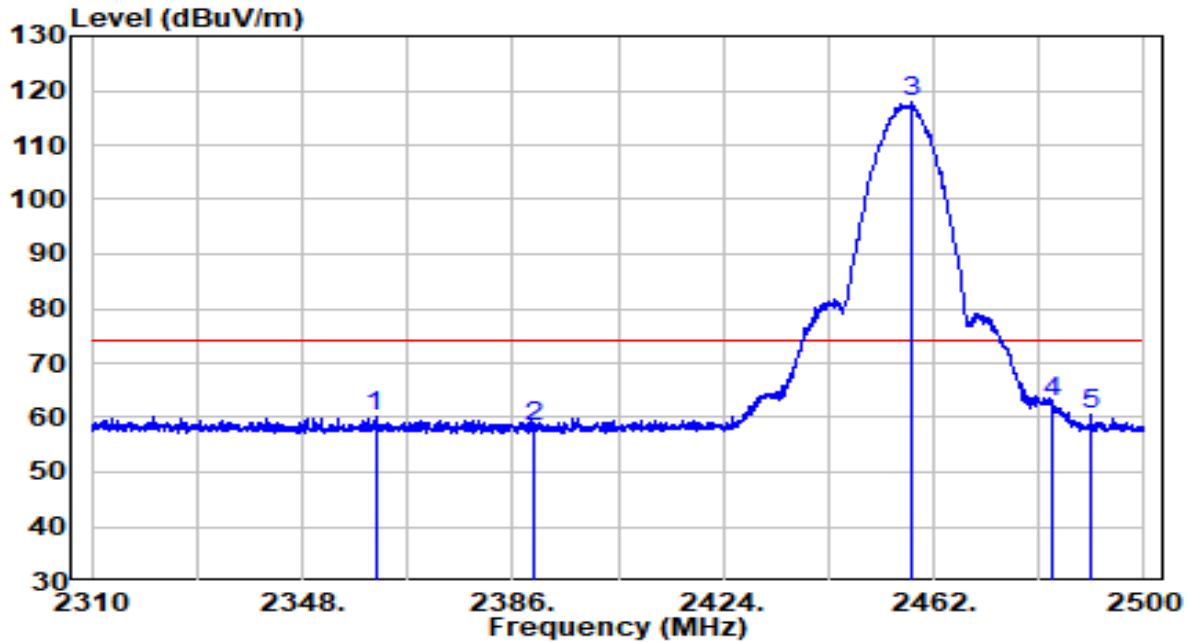

No	Frequency (MHz)	Reading (dBuV)	C.F (dB)	Measurement (dBuV/m)	Margin (dB)	Limit (dBuV/m)	Remark (QP/PK/AV)
1	2361.205	28.15	32.17	60.32	-13.68	74.00	Peak
2	2390.000	26.08	32.30	58.38	-15.62	74.00	Peak
3	* 2458.200	85.38	32.60	117.97	N/A	N/A	Peak
4	2483.500	30.18	32.71	62.89	-11.11	74.00	Peak
5	2490.310	27.84	32.74	60.58	-13.42	74.00	Peak

Note:

1. " \*", means this data is the worst emission level.
2. C.F (Correction Factor) = Antenna Factor (dB)+ Cable Loss (dB).
3. Measurement(dBuV/m) = Reading(dBuV) + C.F (Correction Factor).
4. The emission levels of other frequencies are very lower than the limit and not show in test report.

EUT	OAW-AP1301	Date of Test	2020-12-18
Factor	BBHA 9120D	Temp. / Humidity	21.2°C/23%
Polarity	Vertical	Site / Test Engineer	AC1 / Jay Chiu
Test Mode	Transmit by 802.11b at Channel 2457MHz	Test Voltage	120V/60Hz

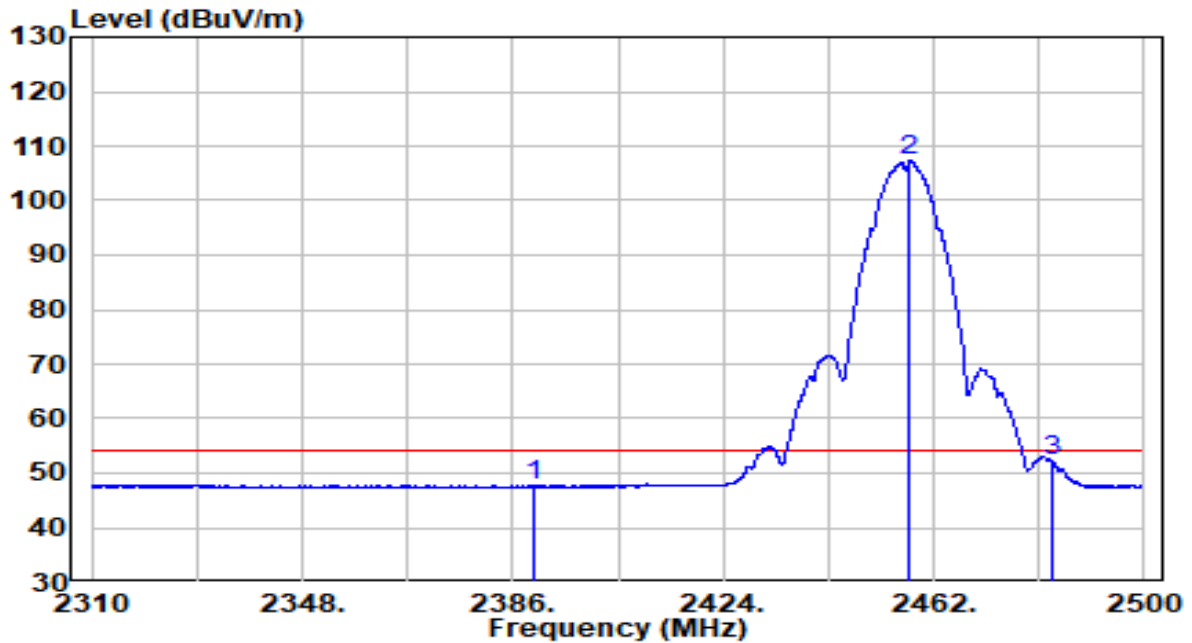

No	Frequency (MHz)	Reading (dBuV)	C.F (dB)	Measurement (dBuV/m)	Margin (dB)	Limit (dBuV/m)	Remark (QP/PK/AV)
1	2390.000	15.28	32.30	47.57	-6.43	54.00	Average
2	* 2457.725	74.69	32.59	107.29	N/A	N/A	Average
3	2483.500	19.64	32.71	52.35	-1.65	54.00	Average

Note:

1. " \*", means this data is the worst emission level.
2. C.F (Correction Factor) = Antenna Factor (dB)+ Cable Loss (dB).
3. Measurement(dBuV/m) = Reading(dBuV) + C.F (Correction Factor).
4. The emission levels of other frequencies are very lower than the limit and not show in test report.

EUT	OAW-AP1301	Date of Test	2020-11-26
Factor	BBHA 9120D	Temp. / Humidity	23.7°C/42%
Polarity	Horizontal	Site / Test Engineer	AC1 / Jay Chiu
Test Mode	Transmit by 802.11b at Channel 2462MHz	Test Voltage	120V/60Hz

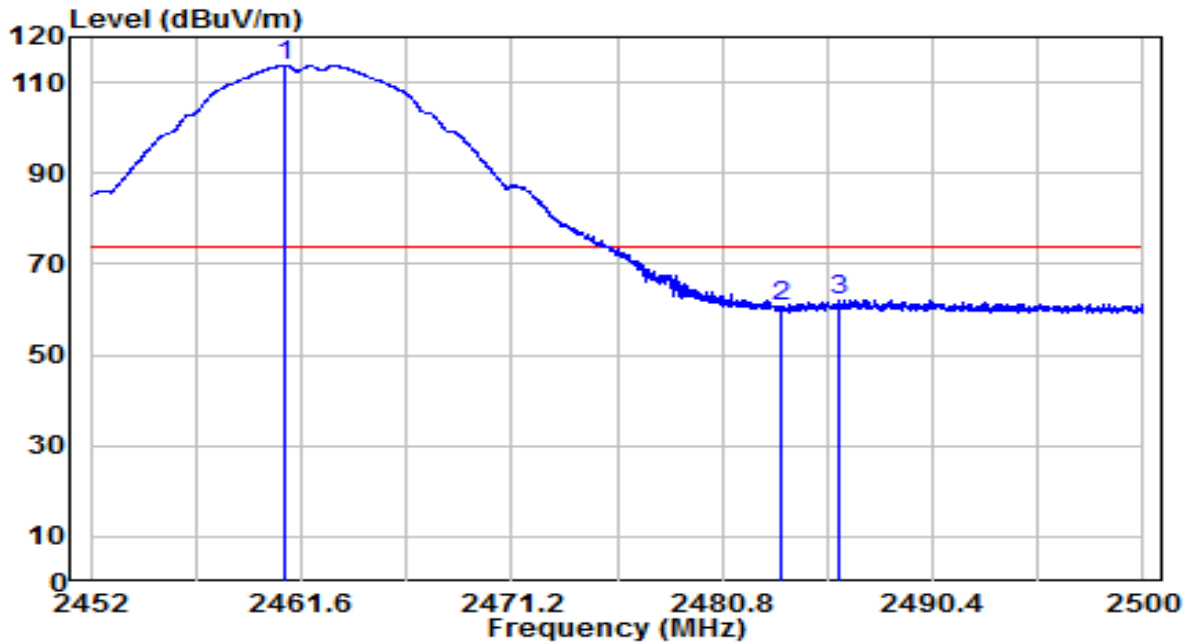

No	Frequency (MHz)	Reading (dBuV)	C.F (dB)	Measurement (dBuV/m)	Margin (dB)	Limit (dBuV/m)	Remark (QP/PK/AV)
1	* 2460.880	81.08	32.61	113.69	N/A	N/A	Peak
2	2483.500	27.81	32.71	60.52	-13.48	74.00	Peak
3	2486.152	29.35	32.72	62.07	-11.93	74.00	Peak

Note:

1. " \*", means this data is the worst emission level.
2. C.F (Correction Factor) = Antenna Factor (dB)+ Cable Loss (dB).
3. Measurement(dBuV/m) = Reading(dBuV) + C.F (Correction Factor).
4. The emission levels of other frequencies are very lower than the limit and not show in test report.

EUT	OAW-AP1301	Date of Test	2020-11-26
Factor	BBHA 9120D	Temp. / Humidity	23.7°C/42%
Polarity	Horizontal	Site / Test Engineer	AC1 / Jay Chiu
Test Mode	Transmit by 802.11b at Channel 2462MHz	Test Voltage	120V/60Hz

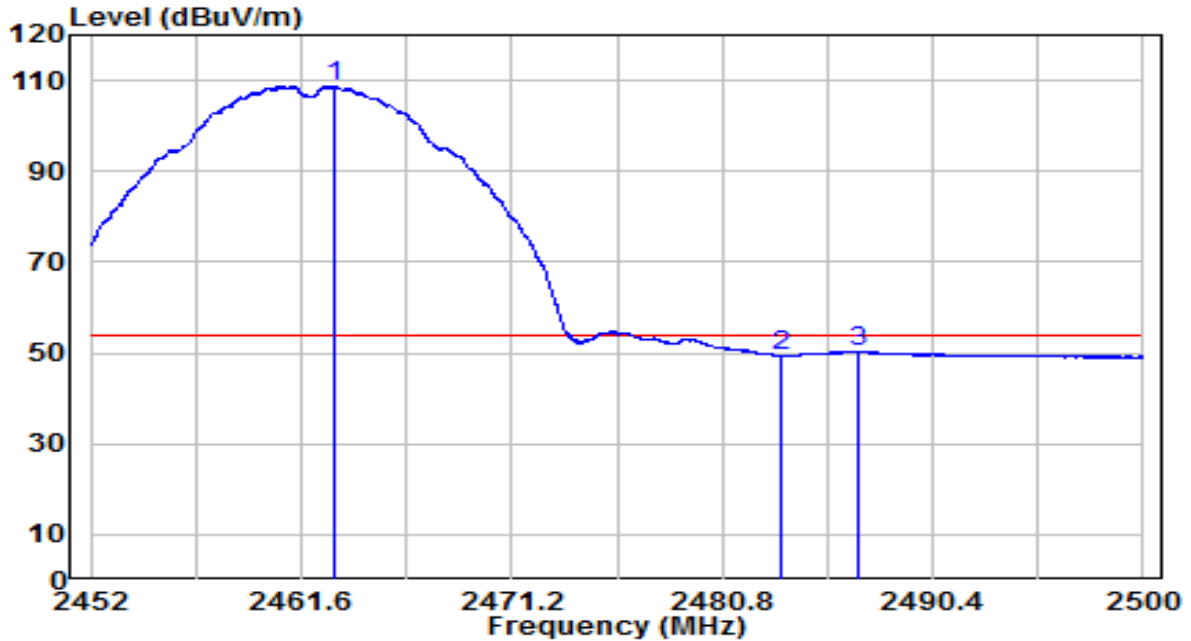

No	Frequency (MHz)	Reading (dBuV)	C.F (dB)	Measurement (dBuV/m)	Margin (dB)	Limit (dBuV/m)	Remark (QP/PK/AV)
1	* 2463.136	76.22	32.62	108.84	N/A	N/A	Average
2	2483.500	16.73	32.71	49.44	-4.56	54.00	Average
3	2487.016	17.71	32.72	50.44	-3.56	54.00	Average

Note:

1. " \*", means this data is the worst emission level.
2. C.F (Correction Factor) = Antenna Factor (dB)+ Cable Loss (dB).
3. Measurement(dBuV/m) = Reading(dBuV) + C.F (Correction Factor).
4. The emission levels of other frequencies are very lower than the limit and not show in test report.

EUT	OAW-AP1301	Date of Test	2020-11-26
Factor	BBHA 9120D	Temp. / Humidity	23.7°C/42%
Polarity	Vertical	Site / Test Engineer	AC1 / Jay Chiu
Test Mode	Transmit by 802.11b at Channel 2462MHz	Test Voltage	120V/60Hz

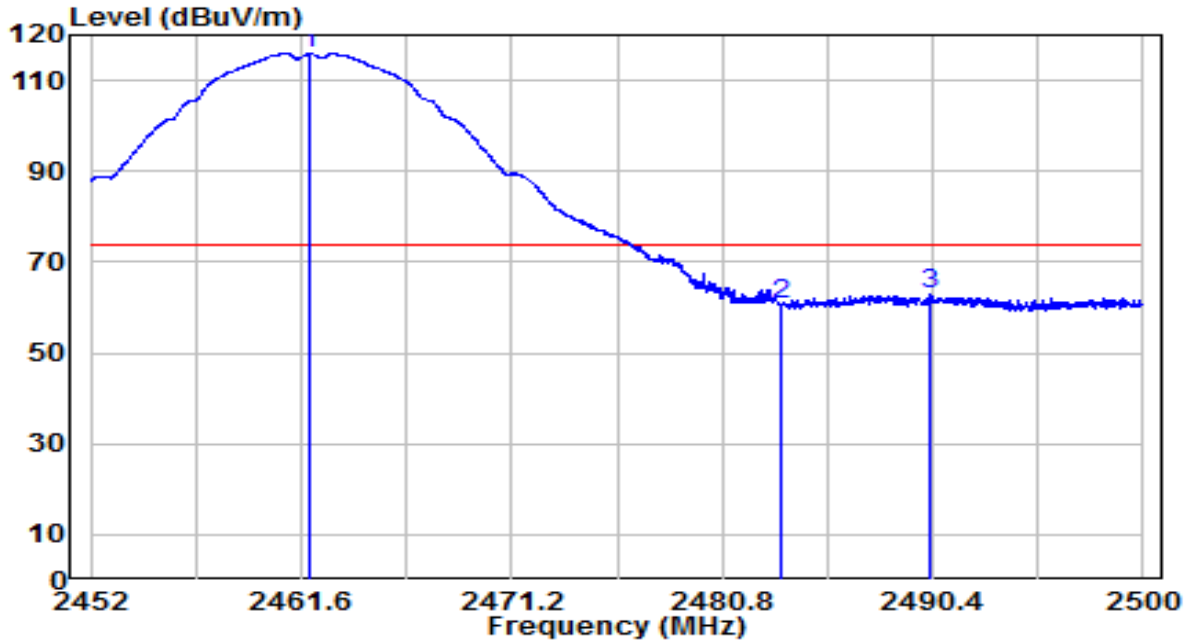

No	Frequency (MHz)	Reading (dBuV)	C.F (dB)	Measurement (dBuV/m)	Margin (dB)	Limit (dBuV/m)	Remark (QP/PK/AV)
1	* 2461.984	83.28	32.61	115.89	N/A	N/A	Peak
2	2483.500	28.09	32.71	60.80	-13.20	74.00	Peak
3	2490.280	29.98	32.74	62.72	-11.28	74.00	Peak

Note:

1. " \*", means this data is the worst emission level.
2. C.F (Correction Factor) = Antenna Factor (dB)+ Cable Loss (dB).
3. Measurement(dBuV/m) = Reading(dBuV) + C.F (Correction Factor).
4. The emission levels of other frequencies are very lower than the limit and not show in test report.

EUT	OAW-AP1301	Date of Test	2020-11-26
Factor	BBHA 9120D	Temp. / Humidity	23.7°C/42%
Polarity	Vertical	Site / Test Engineer	AC1 / Jay Chiu
Test Mode	Transmit by 802.11b at Channel 2462MHz	Test Voltage	120V/60Hz

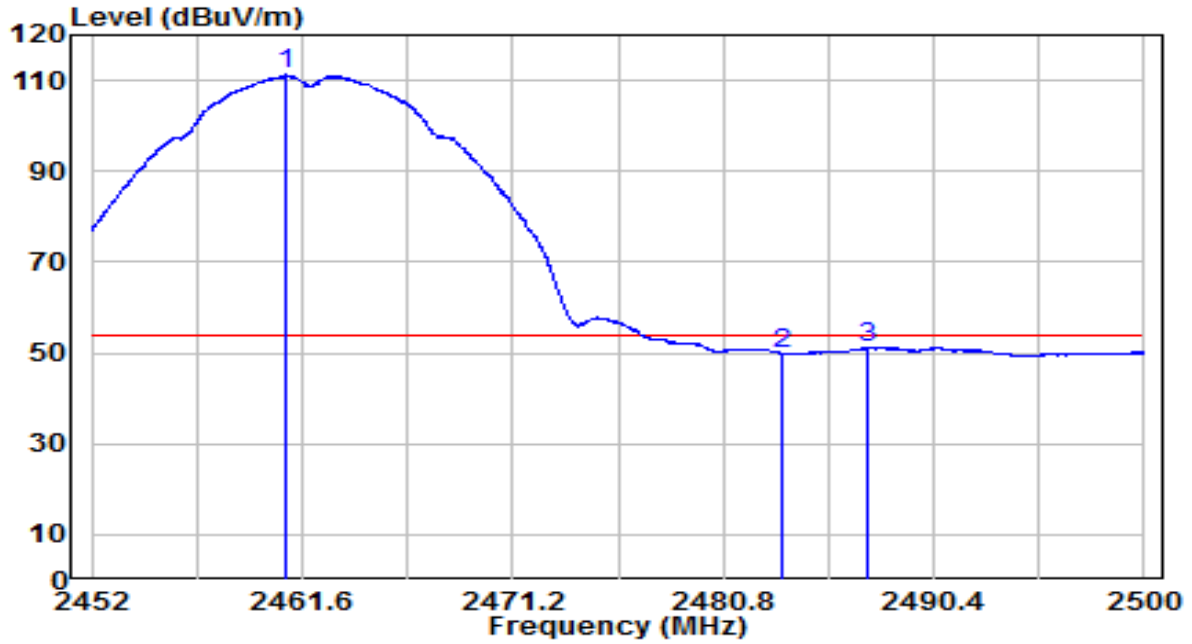

No	Frequency (MHz)	Reading (dBuV)	C.F (dB)	Measurement (dBuV/m)	Margin (dB)	Limit (dBuV/m)	Remark (QP/PK/AV)
1	* 2460.880	78.57	32.61	111.18	N/A	N/A	Average
2	2483.500	17.18	32.71	49.89	-4.11	54.00	Average
3	2487.376	18.43	32.72	51.16	-2.84	54.00	Average

Note:

1. " \*", means this data is the worst emission level.
2. C.F (Correction Factor) = Antenna Factor (dB)+ Cable Loss (dB).
3. Measurement(dBuV/m) = Reading(dBuV) + C.F (Correction Factor).
4. The emission levels of other frequencies are very lower than the limit and not show in test report.

EUT	OAW-AP1301	Date of Test	2020-11-26
Factor	BBHA 9120D	Temp. / Humidity	23.7°C/42%
Polarity	Horizontal	Site / Test Engineer	AC1 / Jay Chiu
Test Mode	Transmit by 802.11g at Channel 2412MHz	Test Voltage	120V/60Hz

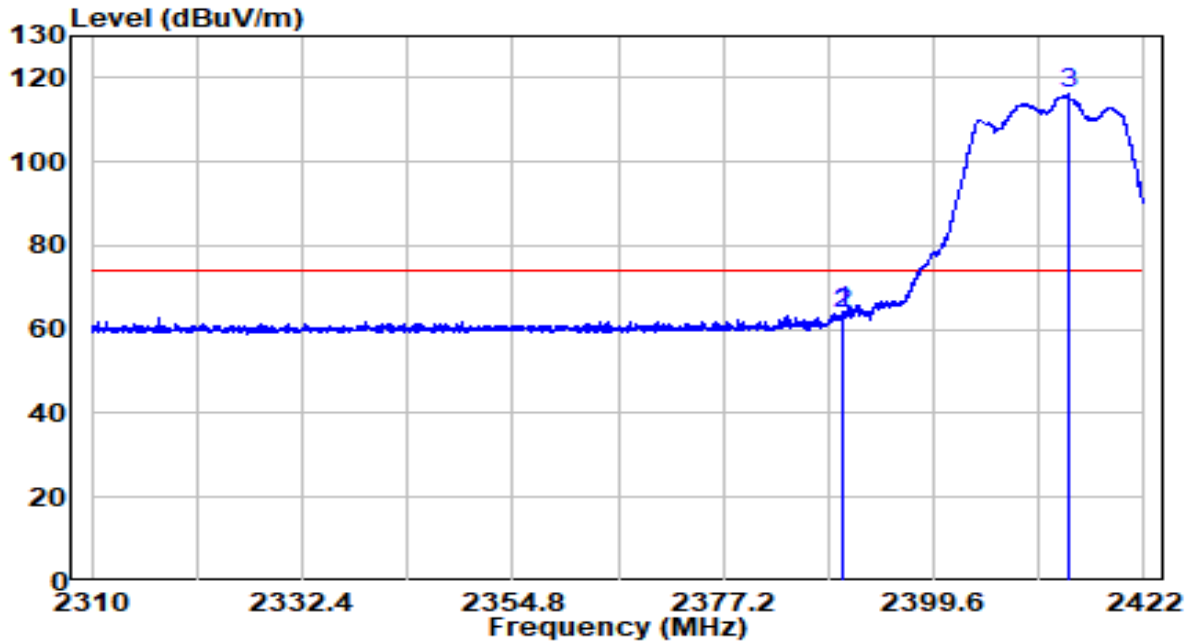

No	Frequency (MHz)	Reading (dBuV)	C.F (dB)	Measurement (dBuV/m)	Margin (dB)	Limit (dBuV/m)	Remark (QP/PK/AV)
1	2389.912	31.85	32.30	64.15	-9.85	74.00	Peak
2	2390.000	31.29	32.30	63.58	-10.42	74.00	Peak
3	* 2413.880	83.66	32.40	116.06	N/A	N/A	Peak

Note:

1. " \*", means this data is the worst emission level.
2. C.F (Correction Factor) = Antenna Factor (dB)+ Cable Loss (dB).
3. Measurement(dBuV/m) = Reading(dBuV) + C.F (Correction Factor).
4. The emission levels of other frequencies are very lower than the limit and not show in test report.



EUT	OAW-AP1301	Date of Test	2020-11-26
Factor	BBHA 9120D	Temp. / Humidity	23.7°C/42%
Polarity	Horizontal	Site / Test Engineer	AC1 / Jay Chiu
Test Mode	Transmit by 802.11g at Channel 2412MHz	Test Voltage	120V/60Hz

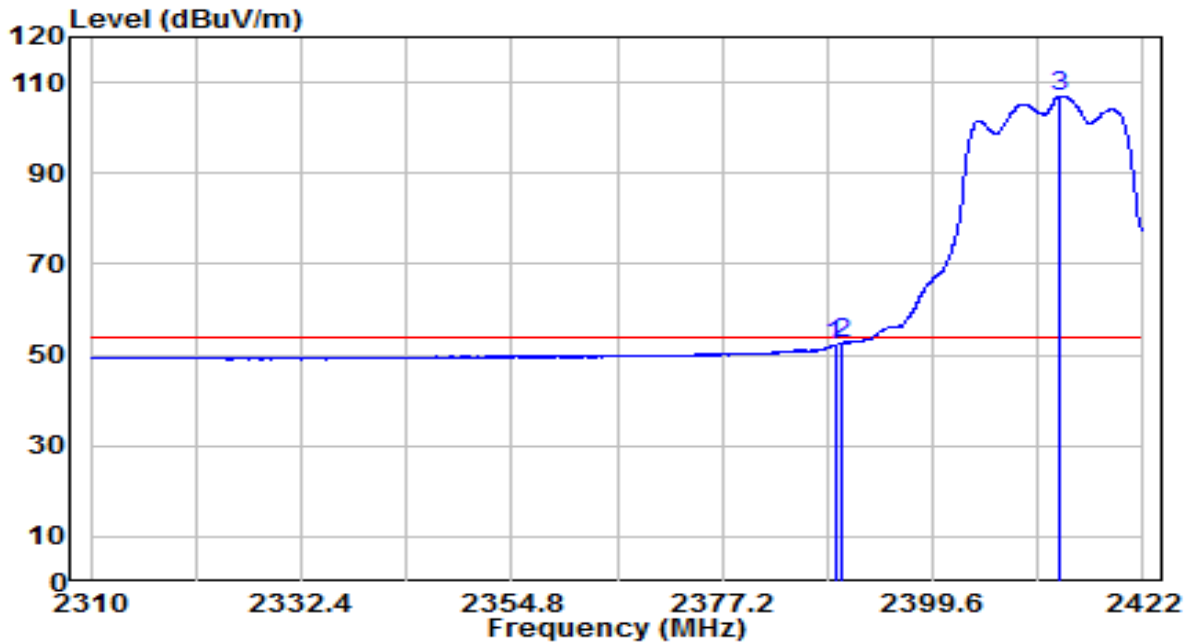

No	Frequency (MHz)	Reading (dBuV)	C.F (dB)	Measurement (dBuV/m)	Margin (dB)	Limit (dBuV/m)	Remark (QP/PK/AV)
1	2389.184	19.79	32.29	52.08	-1.92	54.00	Average
2	2390.000	20.28	32.30	52.58	-1.42	54.00	Average
3	* 2413.152	74.68	32.40	107.07	N/A	N/A	Average

Note:

1. " \*", means this data is the worst emission level.
2. C.F (Correction Factor) = Antenna Factor (dB)+ Cable Loss (dB).
3. Measurement(dBuV/m) = Reading(dBuV) + C.F (Correction Factor).
4. The emission levels of other frequencies are very lower than the limit and not show in test report.

EUT	OAW-AP1301	Date of Test	2020-11-26
Factor	BBHA 9120D	Temp. / Humidity	23.7°C/42%
Polarity	Vertical	Site / Test Engineer	AC1 / Jay Chiu
Test Mode	Transmit by 802.11g at Channel 2412MHz	Test Voltage	120V/60Hz

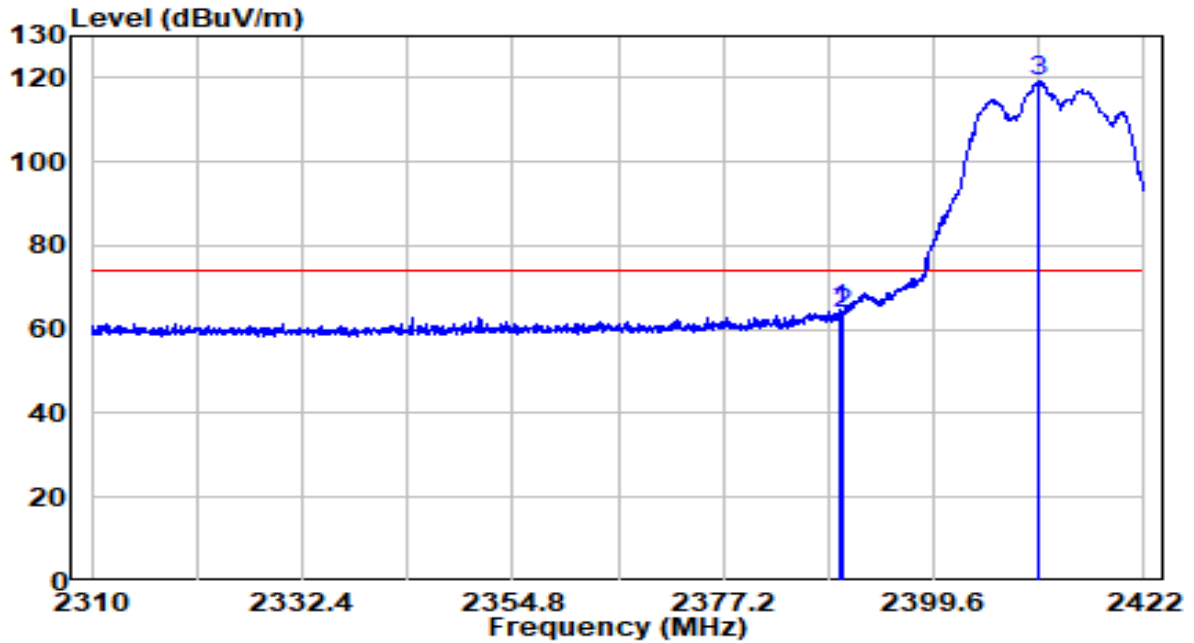

No	Frequency (MHz)	Reading (dBuV)	C.F (dB)	Measurement (dBuV/m)	Margin (dB)	Limit (dBuV/m)	Remark (QP/PK/AV)
1	2389.688	32.50	32.29	64.80	-9.20	74.00	Peak
2	2390.000	31.61	32.30	63.90	-10.10	74.00	Peak
3	* 2410.632	86.63	32.39	119.01	N/A	N/A	Peak

Note:

1. " \*", means this data is the worst emission level.
2. C.F (Correction Factor) = Antenna Factor (dB)+ Cable Loss (dB).
3. Measurement(dBuV/m) = Reading(dBuV) + C.F (Correction Factor).
4. The emission levels of other frequencies are very lower than the limit and not show in test report.

EUT	OAW-AP1301	Date of Test	2020-11-26
Factor	BBHA 9120D	Temp. / Humidity	23.7°C/42%
Polarity	Vertical	Site / Test Engineer	AC1 / Jay Chiu
Test Mode	Transmit by 802.11g at Channel 2412MHz	Test Voltage	120V/60Hz

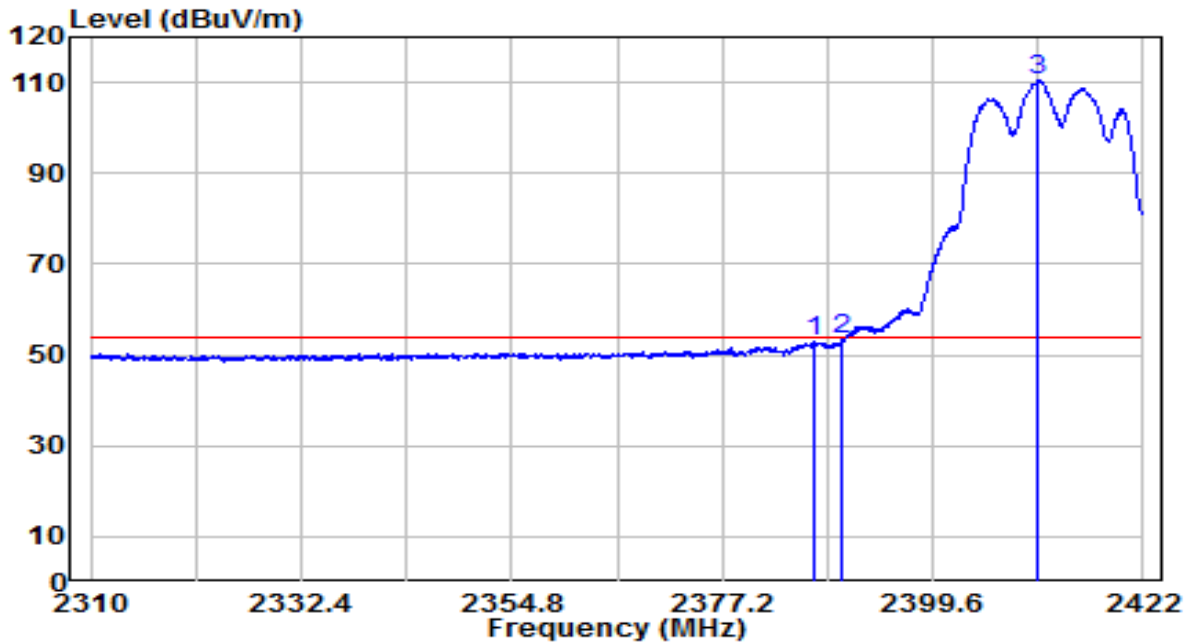

No	Frequency (MHz)	Reading (dBuV)	C.F (dB)	Measurement (dBuV/m)	Margin (dB)	Limit (dBuV/m)	Remark (QP/PK/AV)
1	2387.000	20.86	32.28	53.14	-0.86	54.00	Average
2	2390.000	20.95	32.30	53.24	-0.76	54.00	Average
3	* 2410.800	78.00	32.39	110.39	N/A	N/A	Average

Note:

1. " \*", means this data is the worst emission level.
2. C.F (Correction Factor) = Antenna Factor (dB)+ Cable Loss (dB).
3. Measurement(dBuV/m) = Reading(dBuV) + C.F (Correction Factor).
4. The emission levels of other frequencies are very lower than the limit and not show in test report.

EUT	OAW-AP1301	Date of Test	2020-12-18
Factor	BBHA 9120D	Temp. / Humidity	21.2°C/23%
Polarity	Vertical	Site / Test Engineer	AC1 / Jay Chiu
Test Mode	Transmit by 802.11g at Channel 2417MHz	Test Voltage	120V/60Hz

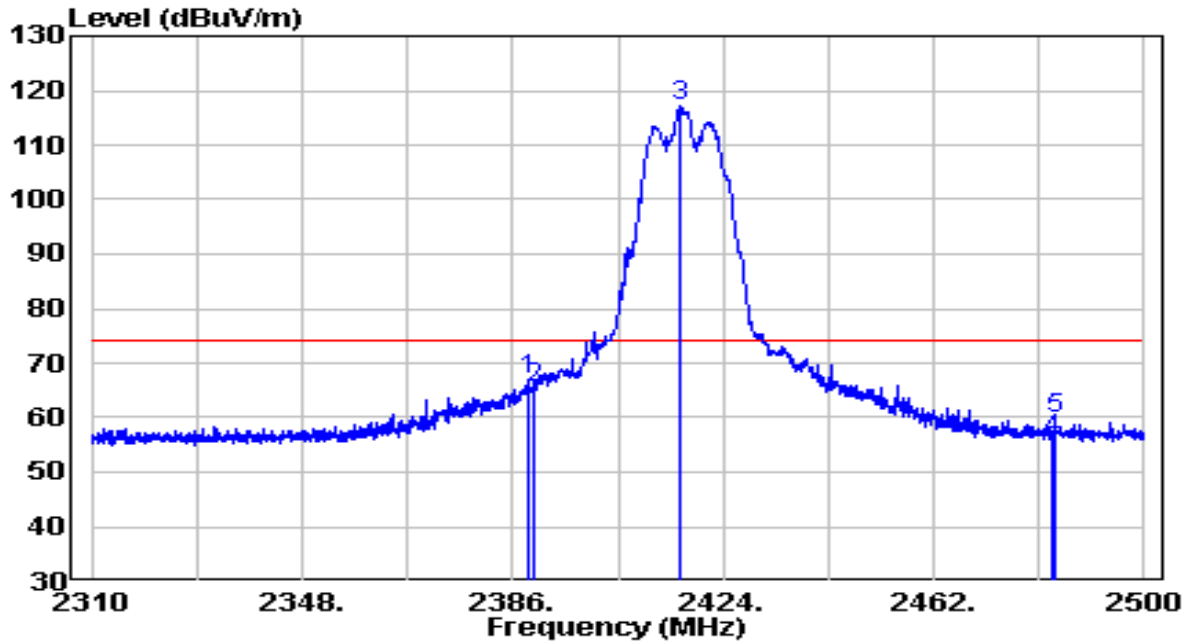

No	Frequency (MHz)	Reading (dBUV)	C.F (dB)	Measurement (dBUV/m)	Margin (dB)	Limit (dBUV/m)	Remark (QP/PK/AV)
1	2388.945	34.57	32.29	66.86	-7.14	74.00	Peak
2	2390.000	33.30	32.30	65.60	-8.40	74.00	Peak
3	* 2416.305	84.60	32.41	117.02	N/A	N/A	Peak
4	2483.500	23.40	32.71	56.11	-17.89	74.00	Peak
5	2483.945	26.93	32.71	59.64	-14.36	74.00	Peak

Note:

1. " \*", means this data is the worst emission level.
2. C.F (Correction Factor) = Antenna Factor (dB)+ Cable Loss (dB).
3. Measurement(dBUV/m) = Reading(dBUV) + C.F (Correction Factor).
4. The emission levels of other frequencies are very lower than the limit and not show in test report.

EUT	OAW-AP1301	Date of Test	2020-12-18
Factor	BBHA 9120D	Temp. / Humidity	21.2°C/23%
Polarity	Vertical	Site / Test Engineer	AC1 / Jay Chiu
Test Mode	Transmit by 802.11g at Channel 2417MHz	Test Voltage	120V/60Hz

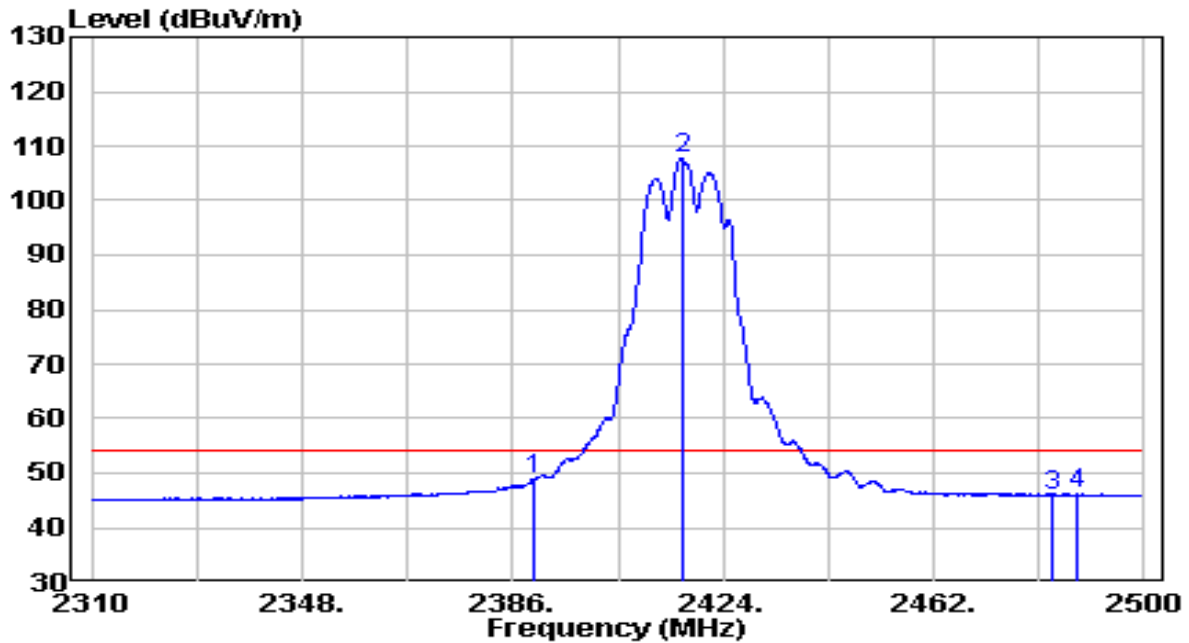

No	Frequency (MHz)	Reading (dBuV)	C.F (dB)	Measurement (dBuV/m)	Margin (dB)	Limit (dBuV/m)	Remark (QP/PK/AV)
1	2390.000	16.60	32.30	48.89	-5.11	54.00	Average
2	* 2416.495	75.28	32.41	107.69	N/A	N/A	Average
3	2483.470	13.24	32.71	45.95	-8.05	54.00	Average
4	2487.745	13.53	32.73	46.26	-7.74	54.00	Average

Note:

- "\*", means this data is the worst emission level.
- C.F (Correction Factor) = Antenna Factor (dB)+ Cable Loss (dB).
- Measurement(dBuV/m) = Reading(dBuV) + C.F (Correction Factor).
- The emission levels of other frequencies are very lower than the limit and not show in test report.

EUT	OAW-AP1301	Date of Test	2020-12-18
Factor	BBHA 9120D	Temp. / Humidity	21.2°C/23%
Polarity	Vertical	Site / Test Engineer	AC1 / Jay Chiu
Test Mode	Transmit by 802.11g at Channel 2457MHz	Test Voltage	120V/60Hz

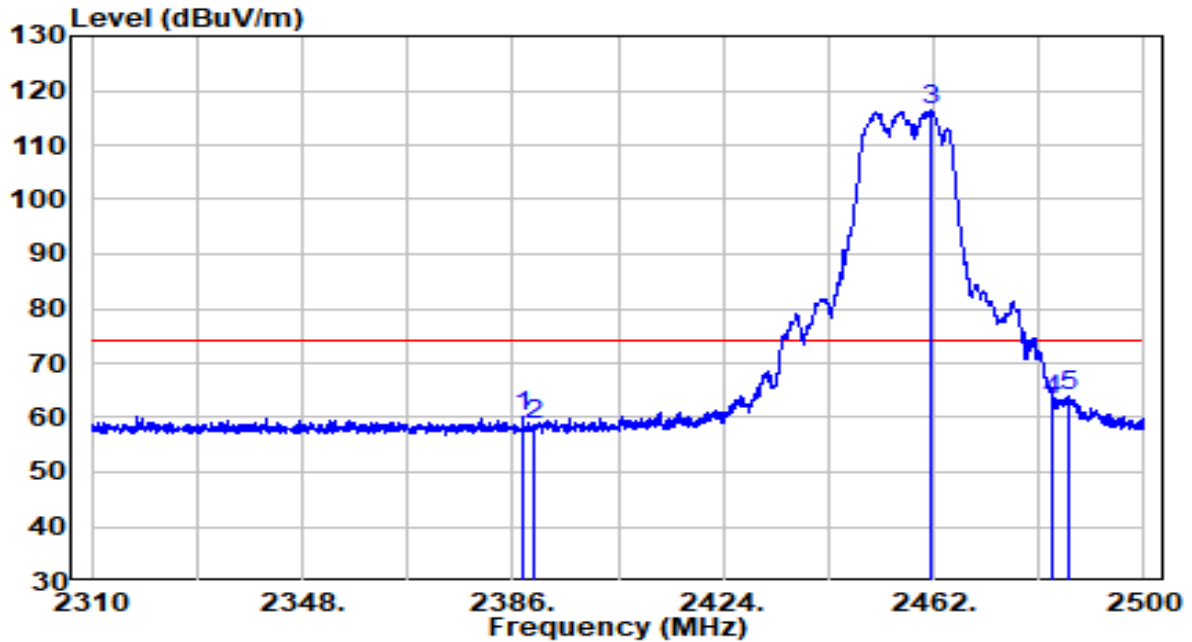

No	Frequency (MHz)	Reading (dBuV)	C.F (dB)	Measurement (dBuV/m)	Margin (dB)	Limit (dBuV/m)	Remark (QP/PK/AV)
1	2387.710	27.95	32.29	60.24	-13.76	74.00	Peak
2	2390.000	26.21	32.30	58.51	-15.49	74.00	Peak
3	* 2461.525	83.75	32.61	116.36	N/A	N/A	Peak
4	2483.500	30.63	32.71	63.34	-10.66	74.00	Peak
5	2486.605	31.15	32.72	63.87	-10.13	74.00	Peak

Note:

1. " \*", means this data is the worst emission level.
2. C.F (Correction Factor) = Antenna Factor (dB)+ Cable Loss (dB).
3. Measurement(dBuV/m) = Reading(dBuV) + C.F (Correction Factor).
4. The emission levels of other frequencies are very lower than the limit and not show in test report.

EUT	OAW-AP1301	Date of Test	2020-12-18
Factor	BBHA 9120D	Temp. / Humidity	21.2°C/23%
Polarity	Vertical	Site / Test Engineer	AC1 / Jay Chiu
Test Mode	Transmit by 802.11g at Channel 2457MHz	Test Voltage	120V/60Hz

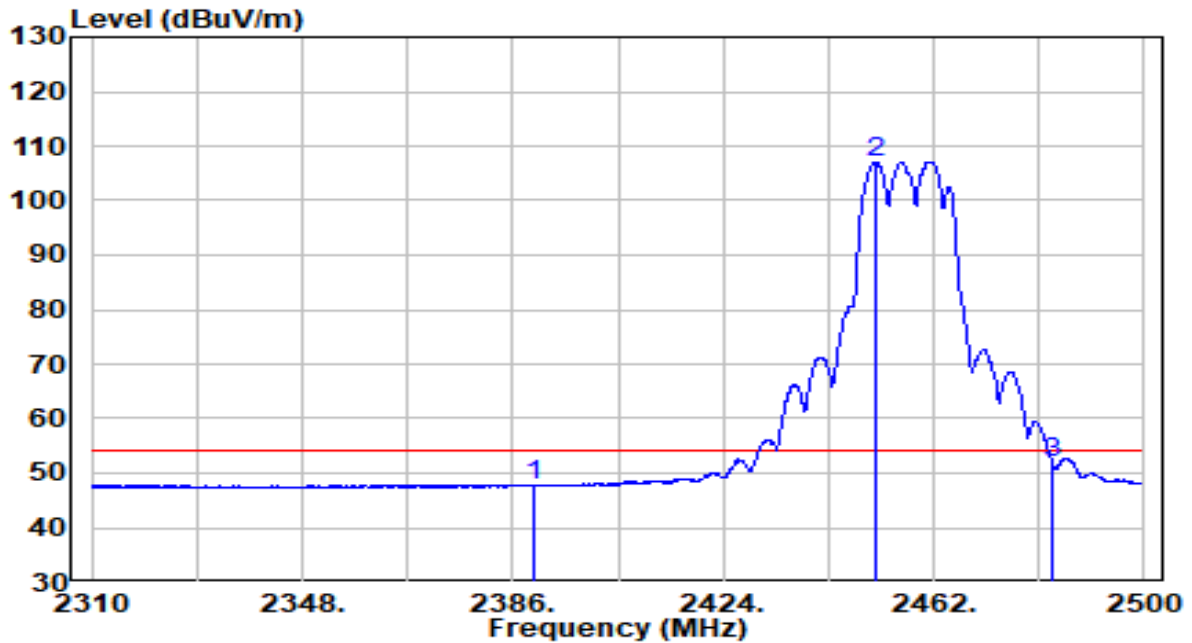

No	Frequency (MHz)	Reading (dBuV)	C.F (dB)	Measurement (dBuV/m)	Margin (dB)	Limit (dBuV/m)	Remark (QP/PK/AV)
1	2390.000	15.39	32.30	47.68	-6.32	54.00	Average
2	* 2451.550	74.58	32.57	107.15	N/A	N/A	Average
3	2483.500	19.16	32.71	51.87	-2.13	54.00	Average

Note:

1. " \*", means this data is the worst emission level.
2. C.F (Correction Factor) = Antenna Factor (dB)+ Cable Loss (dB).
3. Measurement(dBuV/m) = Reading(dBuV) + C.F (Correction Factor).
4. The emission levels of other frequencies are very lower than the limit and not show in test report.

EUT	OAW-AP1301	Date of Test	2020-11-26
Factor	BBHA 9120D	Temp. / Humidity	23.7°C/42%
Polarity	Horizontal	Site / Test Engineer	AC1 / Jay Chiu
Test Mode	Transmit by 802.11g at Channel 2462MHz	Test Voltage	120V/60Hz

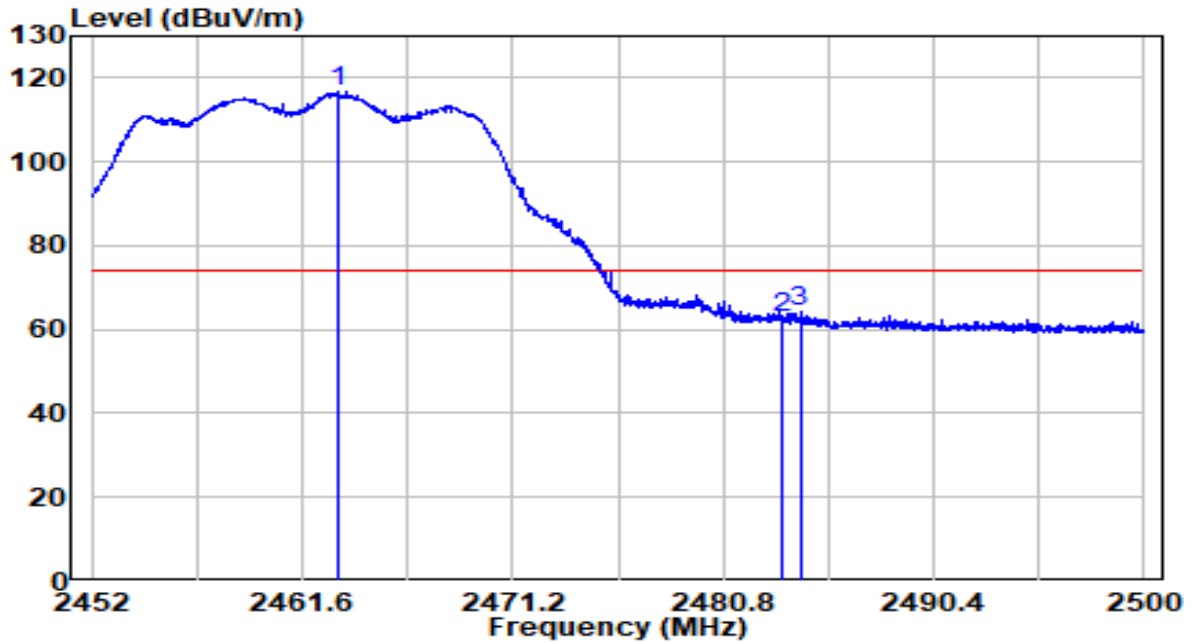

No	Frequency (MHz)	Reading (dBuV)	C.F (dB)	Measurement (dBuV/m)	Margin (dB)	Limit (dBuV/m)	Remark (QP/PK/AV)
1	* 2463.208	84.07	32.62	116.68	N/A	N/A	Peak
2	2483.500	30.15	32.71	62.86	-11.14	74.00	Peak
3	2484.304	31.51	32.71	64.22	-9.78	74.00	Peak

Note:

1. " \*", means this data is the worst emission level.
2. C.F (Correction Factor) = Antenna Factor (dB)+ Cable Loss (dB).
3. Measurement(dBuV/m) = Reading(dBuV) + C.F (Correction Factor).
4. The emission levels of other frequencies are very lower than the limit and not show in test report.



EUT	OAW-AP1301	Date of Test	2020-11-26
Factor	BBHA 9120D	Temp. / Humidity	23.7°C/42%
Polarity	Horizontal	Site / Test Engineer	AC1 / Jay Chiu
Test Mode	Transmit by 802.11g at Channel 2462MHz	Test Voltage	120V/60Hz

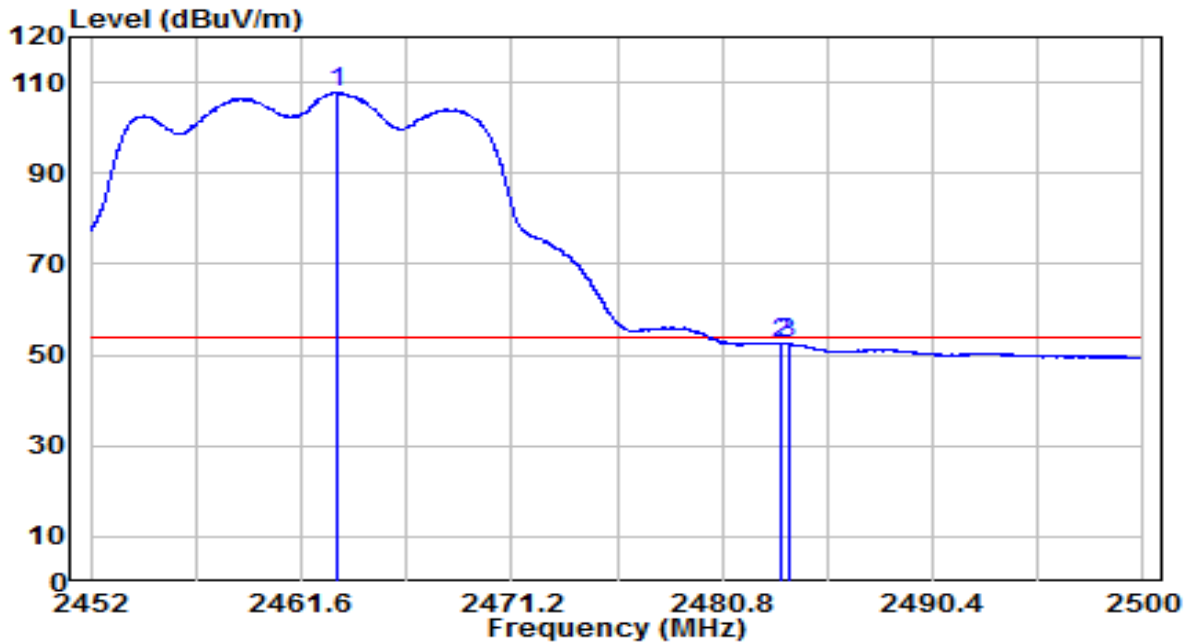

No	Frequency (MHz)	Reading (dBuV)	C.F (dB)	Measurement (dBuV/m)	Margin (dB)	Limit (dBuV/m)	Remark (QP/PK/AV)
1	* 2463.208	75.14	32.62	107.75	N/A	N/A	Average
2	2483.500	19.83	32.71	52.54	-1.46	54.00	Average
3	2483.800	19.95	32.71	52.66	-1.34	54.00	Average

Note:

1. " \*", means this data is the worst emission level.
2. C.F (Correction Factor) = Antenna Factor (dB)+ Cable Loss (dB).
3. Measurement(dBuV/m) = Reading(dBuV) + C.F (Correction Factor).
4. The emission levels of other frequencies are very lower than the limit and not show in test report.

EUT	OAW-AP1301	Date of Test	2020-11-26
Factor	BBHA 9120D	Temp. / Humidity	23.7°C/42%
Polarity	Vertical	Site / Test Engineer	AC1 / Jay Chiu
Test Mode	Transmit by 802.11g at Channel 2462MHz	Test Voltage	120V/60Hz

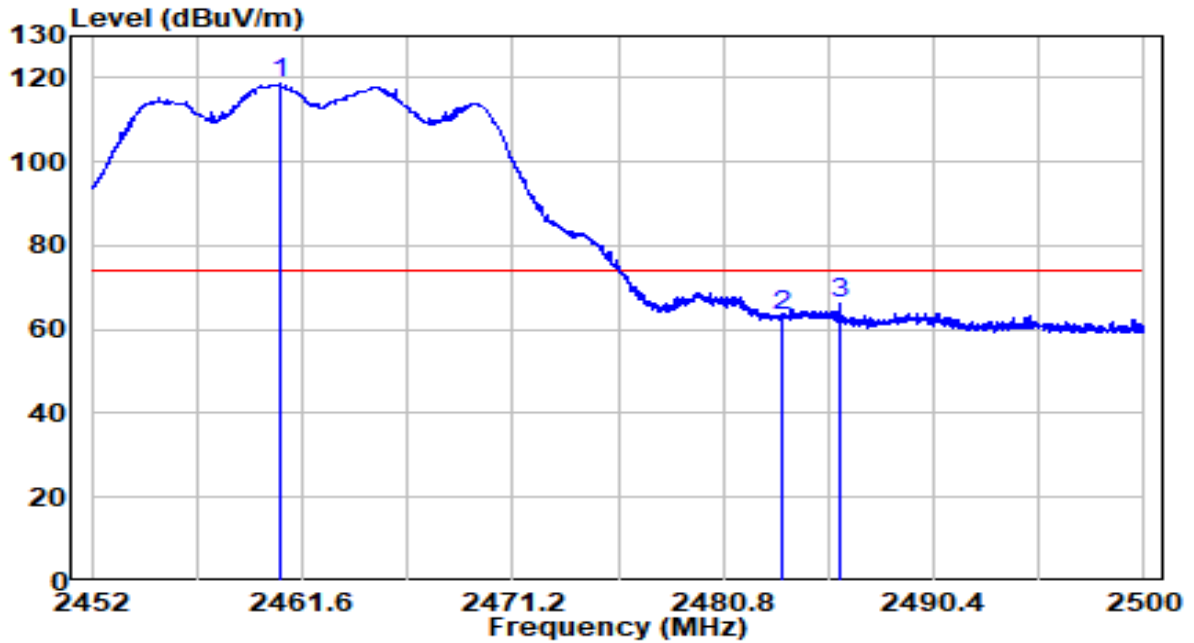

No	Frequency (MHz)	Reading (dBuV)	C.F (dB)	Measurement (dBuV/m)	Margin (dB)	Limit (dBuV/m)	Remark (QP/PK/AV)
1	* 2460.616	86.16	32.61	118.77	N/A	N/A	Peak
2	2483.500	30.35	32.71	63.06	-10.94	74.00	Peak
3	2486.152	33.66	32.72	66.38	-7.62	74.00	Peak

Note:

1. " \*", means this data is the worst emission level.
2. C.F (Correction Factor) = Antenna Factor (dB)+ Cable Loss (dB).
3. Measurement(dBuV/m) = Reading(dBuV) + C.F (Correction Factor).
4. The emission levels of other frequencies are very lower than the limit and not show in test report.

EUT	OAW-AP1301	Date of Test	2020-11-26
Factor	BBHA 9120D	Temp. / Humidity	23.7°C/42%
Polarity	Vertical	Site / Test Engineer	AC1 / Jay Chiu
Test Mode	Transmit by 802.11g at Channel 2462MHz	Test Voltage	120V/60Hz

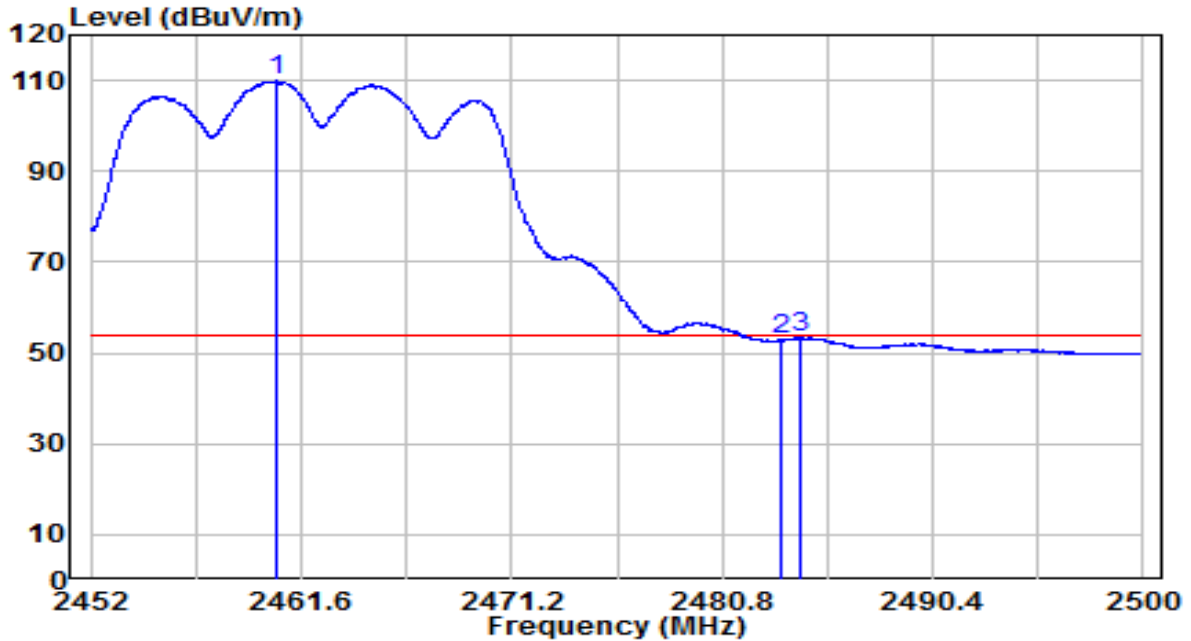

No	Frequency (MHz)	Reading (dBuV)	C.F (dB)	Measurement (dBuV/m)	Margin (dB)	Limit (dBuV/m)	Remark (QP/PK/AV)
1	* 2460.448	77.29	32.61	109.89	N/A	N/A	Average
2	2483.500	20.16	32.71	52.87	-1.13	54.00	Average
3	2484.328	20.71	32.71	53.42	-0.58	54.00	Average

Note:

1. " \*", means this data is the worst emission level.
2. C.F (Correction Factor) = Antenna Factor (dB)+ Cable Loss (dB).
3. Measurement(dBuV/m) = Reading(dBuV) + C.F (Correction Factor).
4. The emission levels of other frequencies are very lower than the limit and not show in test report.

EUT	OAW-AP1301	Date of Test	2020-11-26
Factor	BBHA 9120D	Temp. / Humidity	23.7°C/42%
Polarity	Horizontal	Site / Test Engineer	AC1 / Jay Chiu
Test Mode	Transmit by 802.11n-HT20 at Channel 2412MHz	Test Voltage	120V/60Hz

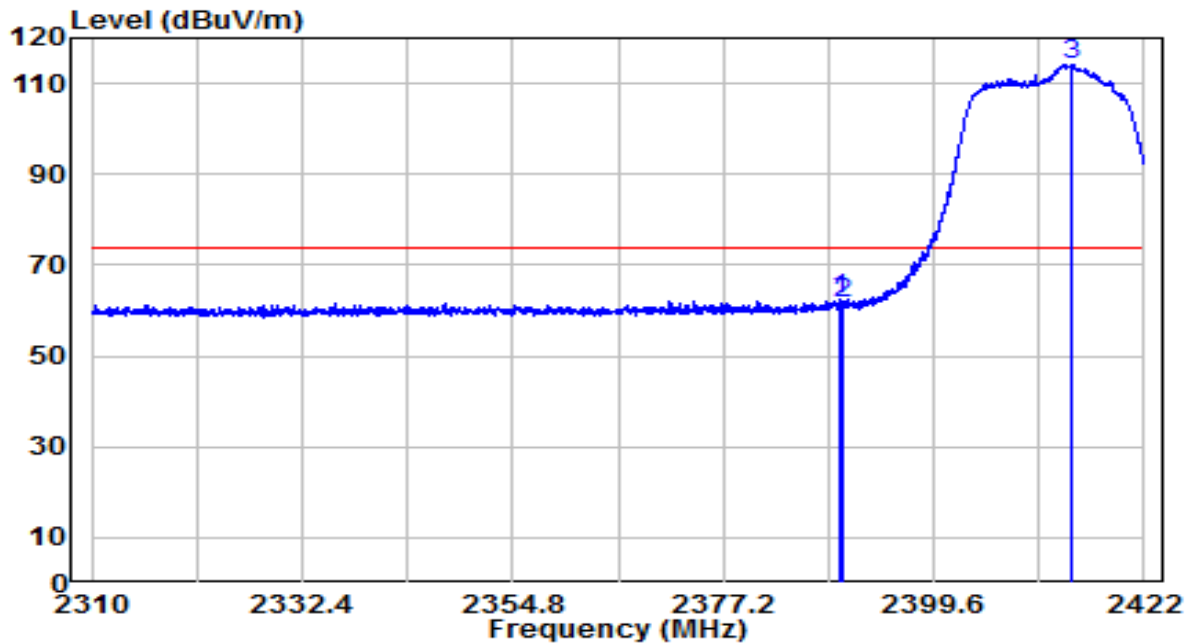

No	Frequency (MHz)	Reading (dBUV)	C.F (dB)	Measurement (dBUV/m)	Margin (dB)	Limit (dBUV/m)	Remark (QP/PK/AV)
1	2389.632	30.41	32.29	62.70	-11.30	74.00	Peak
2	2390.000	29.27	32.30	61.57	-12.43	74.00	Peak
3	* 2414.160	81.71	32.40	114.11	N/A	N/A	Peak

Note:

1. " \*", means this data is the worst emission level.
2. C.F (Correction Factor) = Antenna Factor (dB)+ Cable Loss (dB).
3. Measurement(dBUV/m) = Reading(dBUV) + C.F (Correction Factor).
- 4.The emission levels of other frequencies are very lower than the limit and not show in test report.

EUT	OAW-AP1301	Date of Test	2020-11-26
Factor	BBHA 9120D	Temp. / Humidity	23.7°C/42%
Polarity	Horizontal	Site / Test Engineer	AC1 / Jay Chiu
Test Mode	Transmit by 802.11n-HT20 at Channel 2412MHz	Test Voltage	120V/60Hz

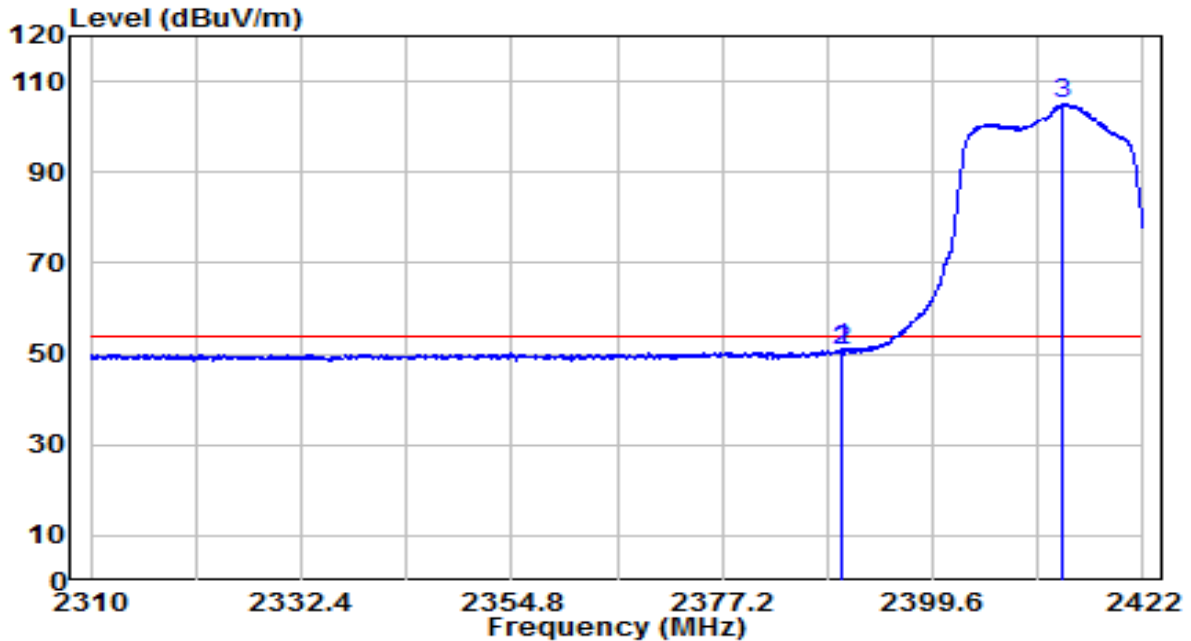

No	Frequency (MHz)	Reading (dBuV)	C.F (dB)	Measurement (dBuV/m)	Margin (dB)	Limit (dBuV/m)	Remark (QP/PK/AV)
1	2389.800	18.85	32.30	51.15	-2.85	54.00	Average
2	2390.000	18.29	32.30	50.58	-3.42	54.00	Average
3	* 2413.320	72.68	32.40	105.08	N/A	N/A	Average

Note:

1. " \*", means this data is the worst emission level.
2. C.F (Correction Factor) = Antenna Factor (dB)+ Cable Loss (dB).
3. Measurement(dBuV/m) = Reading(dBuV) + C.F (Correction Factor).
4. The emission levels of other frequencies are very lower than the limit and not show in test report.

EUT	OAW-AP1301	Date of Test	2020-11-26
Factor	BBHA 9120D	Temp. / Humidity	23.7°C/42%
Polarity	Vertical	Site / Test Engineer	AC1 / Jay Chiu
Test Mode	Transmit by 802.11n-HT20 at Channel 2412MHz	Test Voltage	120V/60Hz

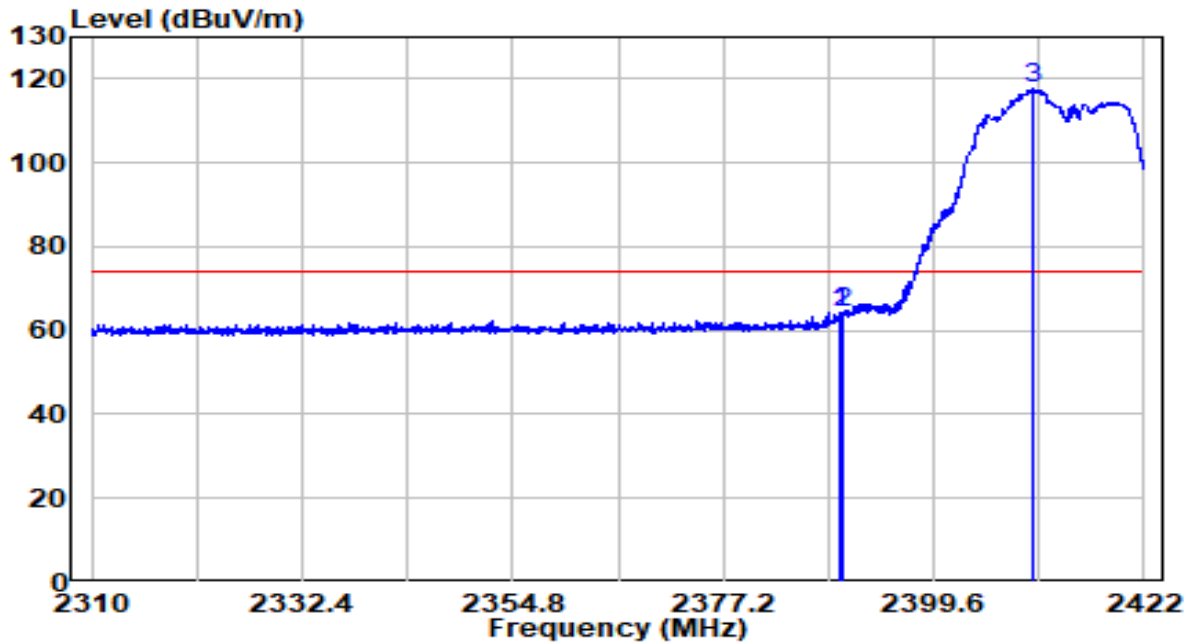

No	Frequency (MHz)	Reading (dBuV)	C.F (dB)	Measurement (dBuV/m)	Margin (dB)	Limit (dBuV/m)	Remark (QP/PK/AV)
1	2389.632	32.07	32.29	64.37	-9.63	74.00	Peak
2	2390.000	32.18	32.30	64.47	-9.53	74.00	Peak
3	* 2410.240	85.18	32.39	117.57	N/A	N/A	Peak

Note:

1. " \*", means this data is the worst emission level.
2. C.F (Correction Factor) = Antenna Factor (dB)+ Cable Loss (dB).
3. Measurement(dBuV/m) = Reading(dBuV) + C.F (Correction Factor).
4. The emission levels of other frequencies are very lower than the limit and not show in test report.

EUT	OAW-AP1301	Date of Test	2020-11-26
Factor	BBHA 9120D	Temp. / Humidity	23.7°C/42%
Polarity	Vertical	Site / Test Engineer	AC1 / Jay Chiu
Test Mode	Transmit by 802.11n-HT20 at Channel 2412MHz	Test Voltage	120V/60Hz

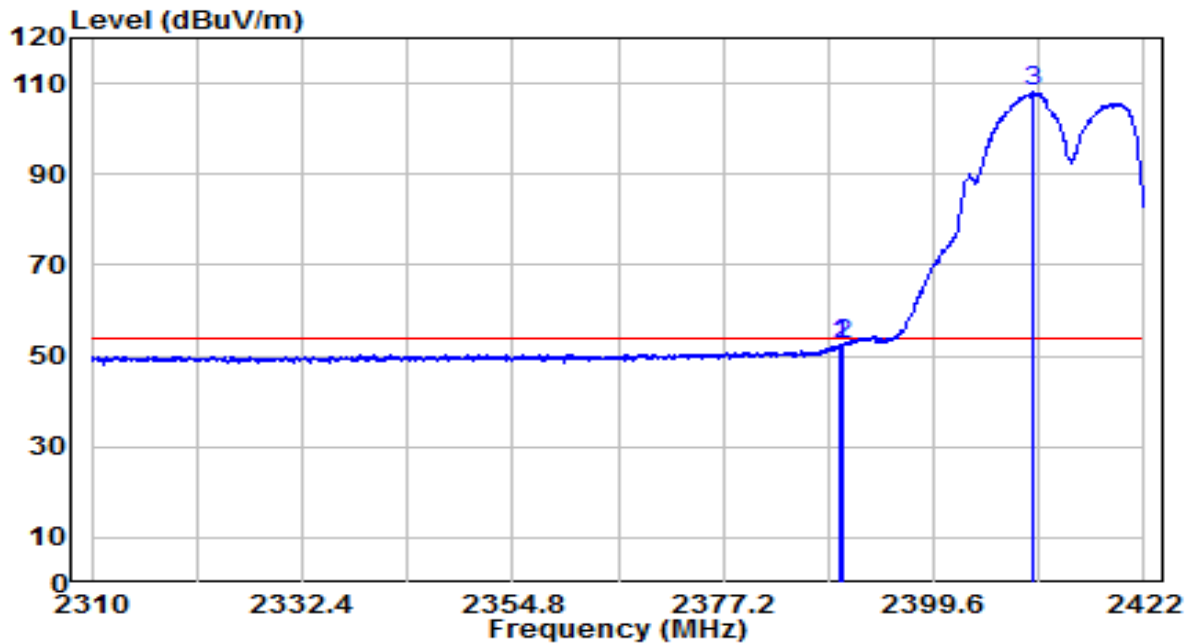

No	Frequency (MHz)	Reading (dBuV)	C.F (dB)	Measurement (dBuV/m)	Margin (dB)	Limit (dBuV/m)	Remark (QP/PK/AV)
1	2389.688	20.19	32.29	52.48	-1.52	54.00	Average
2	2390.000	20.21	32.30	52.51	-1.49	54.00	Average
3	* 2410.128	75.69	32.38	108.07	N/A	N/A	Average

Note:

1. " \*", means this data is the worst emission level.
2. C.F (Correction Factor) = Antenna Factor (dB)+ Cable Loss (dB).
3. Measurement(dBuV/m) = Reading(dBuV) + C.F (Correction Factor).
4. The emission levels of other frequencies are very lower than the limit and not show in test report.

EUT	OAW-AP1301	Date of Test	2020-12-01
Factor	BBHA 9120D	Temp. / Humidity	23.8°C/45%
Polarity	Vertical	Site / Test Engineer	AC1 / Jay Chiu
Test Mode	Transmit by 802.11n-HT20 at Channel 2417MHz	Test Voltage	120V/60Hz

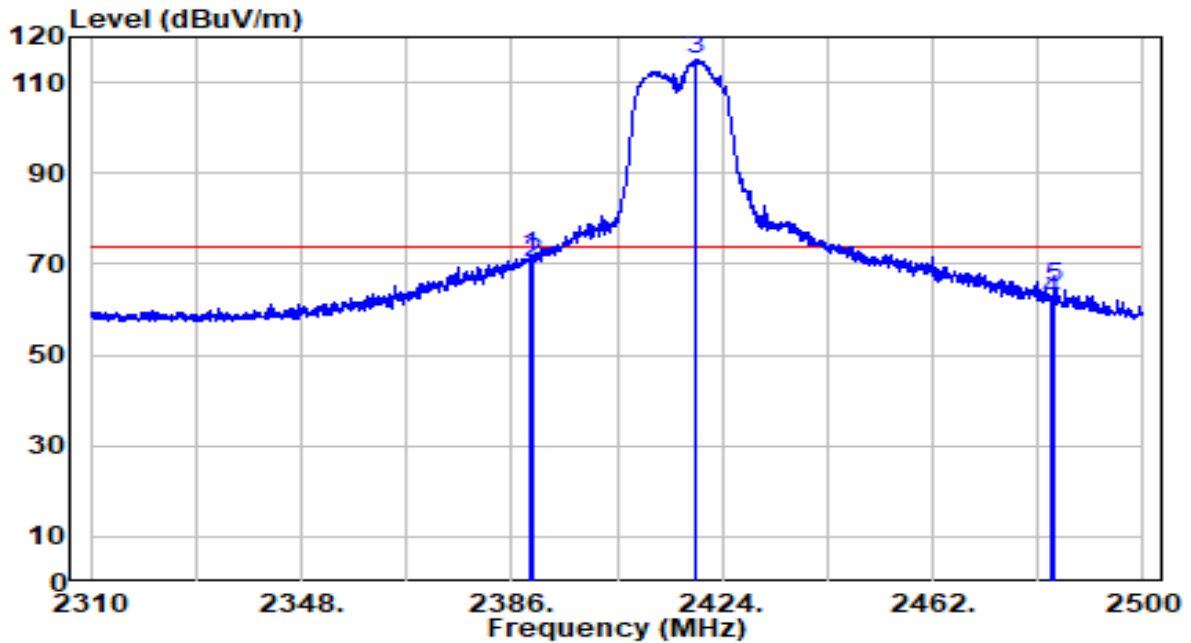

No	Frequency (MHz)	Reading (dBuV)	C.F (dB)	Measurement (dBuV/m)	Margin (dB)	Limit (dBuV/m)	Remark (QP/PK/AV)
1	2389.230	39.20	32.29	71.49	-2.51	74.00	Peak
2	2390.000	38.08	32.30	70.37	-3.63	74.00	Peak
3	* 2419.155	82.63	32.42	115.06	N/A	N/A	Peak
4	2483.500	29.53	32.71	62.24	-11.76	74.00	Peak
5	2484.135	31.96	32.71	64.67	-9.33	74.00	Peak

Note:

1. " \*", means this data is the worst emission level.
2. C.F (Correction Factor) = Antenna Factor (dB)+ Cable Loss (dB)– Preamplifier(dB).
3. Measurement(dBuV/m) = Reading(dBuV) + C.F (Correction Factor).
- 4.The emission levels of other frequencies are very lower than the limit and not show in test report.



EUT	OAW-AP1301	Date of Test	2020-12-01
Factor	BBHA 9120D	Temp. / Humidity	23.8°C/45%
Polarity	Vertical	Site / Test Engineer	AC1 / Jay Chiu
Test Mode	Transmit by 802.11n-HT20 at Channel 2417MHz	Test Voltage	120V/60Hz

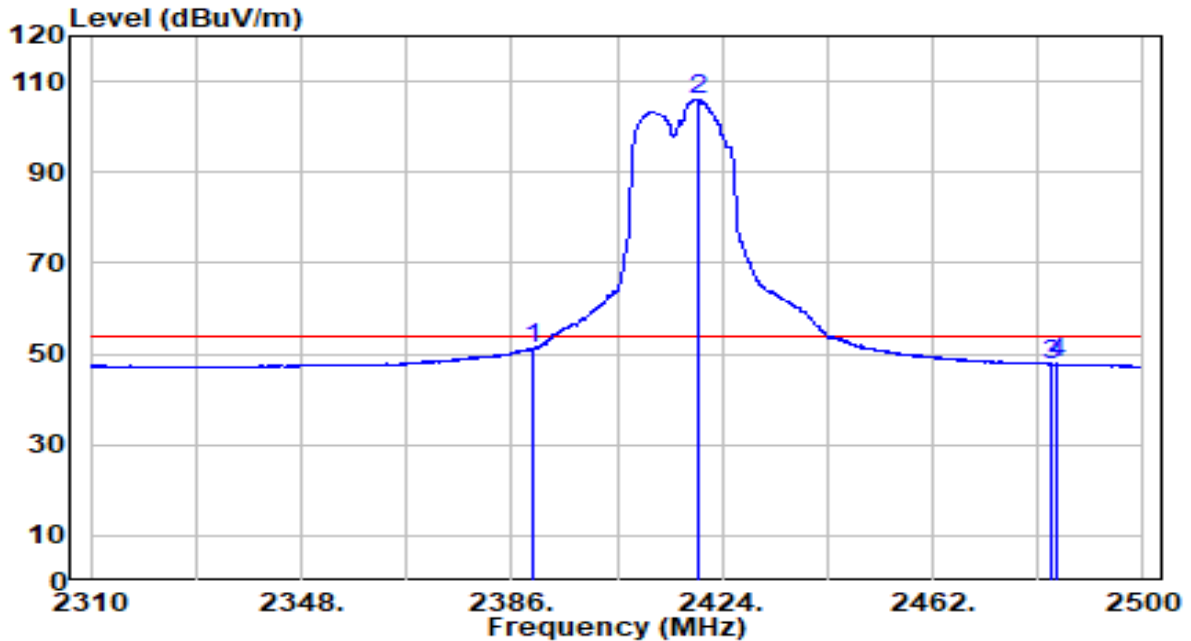

No	Frequency (MHz)	Reading (dBUV)	C.F (dB)	Measurement (dBUV/m)	Margin (dB)	Limit (dBUV/m)	Remark (QP/PK/AV)
1	2390.000	18.90	32.30	51.20	-2.80	54.00	Average
2	* 2419.725	73.42	32.43	105.85	N/A	N/A	Average
3	2483.500	14.95	32.71	47.66	-6.34	54.00	Average
4	2484.420	15.10	32.71	47.81	-6.19	54.00	Average

Note:

1. " \*", means this data is the worst emission level.
2. C.F (Correction Factor) = Antenna Factor (dB)+ Cable Loss (dB)– Preamplifier(dB).
3. Measurement(dBUV/m) = Reading(dBUV) + C.F (Correction Factor).
- 4.The emission levels of other frequencies are very lower than the limit and not show in test report.

EUT	OAW-AP1301	Date of Test	2020-11-26
Factor	BBHA 9120D	Temp. / Humidity	23.7°C/42%
Polarity	Horizontal	Site / Test Engineer	AC1 / Jay Chiu
Test Mode	Transmit by 802.11n-HT20 at Channel 2437MHz	Test Voltage	120V/60Hz

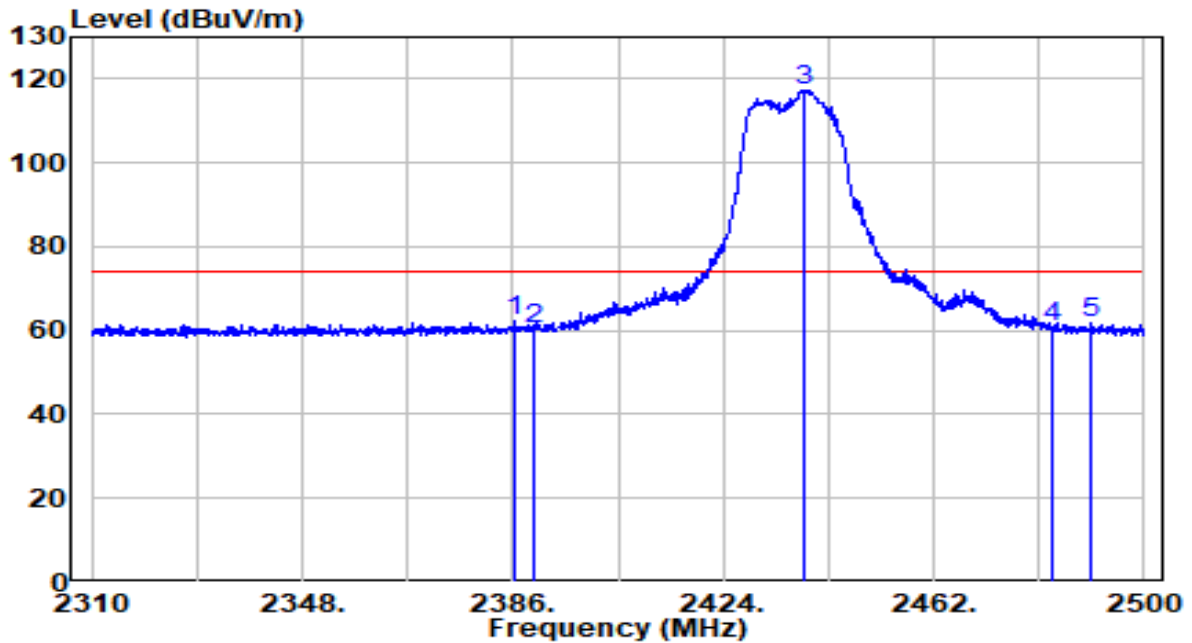

No	Frequency (MHz)	Reading (dBUV)	C.F (dB)	Measurement (dBUV/m)	Margin (dB)	Limit (dBUV/m)	Remark (QP/PK/AV)
1	2386.570	29.88	32.28	62.16	-11.84	74.00	Peak
2	2390.000	28.22	32.30	60.52	-13.48	74.00	Peak
3	* 2438.535	84.79	32.51	117.30	N/A	N/A	Peak
4	2483.500	28.27	32.71	60.98	-13.02	74.00	Peak
5	2490.500	28.97	32.74	61.71	-12.29	74.00	Peak

Note:

- "\*" means this data is the worst emission level.
- C.F (Correction Factor) = Antenna Factor (dB)+ Cable Loss (dB).
- Measurement(dBUV/m) = Reading(dBUV) + C.F (Correction Factor).
- The emission levels of other frequencies are very lower than the limit and not show in test report.

EUT	OAW-AP1301	Date of Test	2020-11-26
Factor	BBHA 9120D	Temp. / Humidity	23.7°C/42%
Polarity	Horizontal	Site / Test Engineer	AC1 / Jay Chiu
Test Mode	Transmit by 802.11n-HT20 at Channel 2437MHz	Test Voltage	120V/60Hz

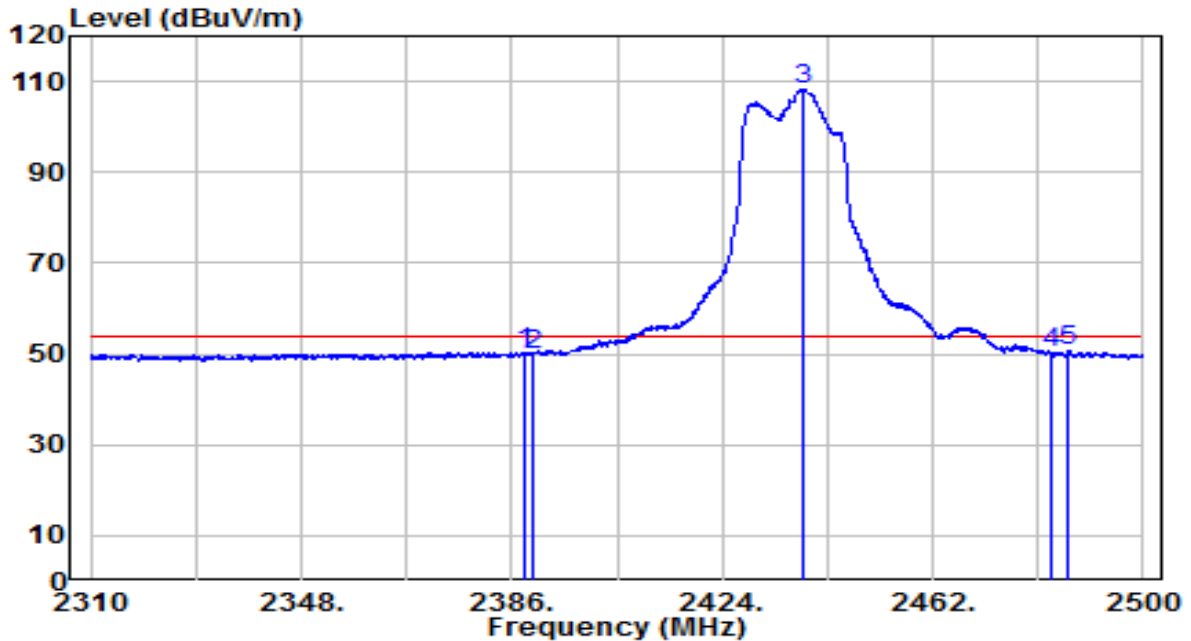

No	Frequency (MHz)	Reading (dBUV)	C.F (dB)	Measurement (dBUV/m)	Margin (dB)	Limit (dBUV/m)	Remark (QP/PK/AV)
1	2388.565	18.16	32.29	50.45	-3.55	54.00	Average
2	2390.000	17.45	32.30	49.74	-4.26	54.00	Average
3	* 2438.725	75.88	32.51	108.39	N/A	N/A	Average
4	2483.500	17.76	32.71	50.47	-3.53	54.00	Average
5	2486.320	17.83	32.72	50.55	-3.45	54.00	Average

Note:

1. " \*", means this data is the worst emission level.
2. C.F (Correction Factor) = Antenna Factor (dB)+ Cable Loss (dB).
3. Measurement(dBUV/m) = Reading(dBUV) + C.F (Correction Factor).
4. The emission levels of other frequencies are very lower than the limit and not show in test report.

EUT	OAW-AP1301	Date of Test	2020-11-26
Factor	BBHA 9120D	Temp. / Humidity	23.7°C/42%
Polarity	Vertical	Site / Test Engineer	AC1 / Jay Chiu
Test Mode	Transmit by 802.11n-HT20 at Channel 2437MHz	Test Voltage	120V/60Hz

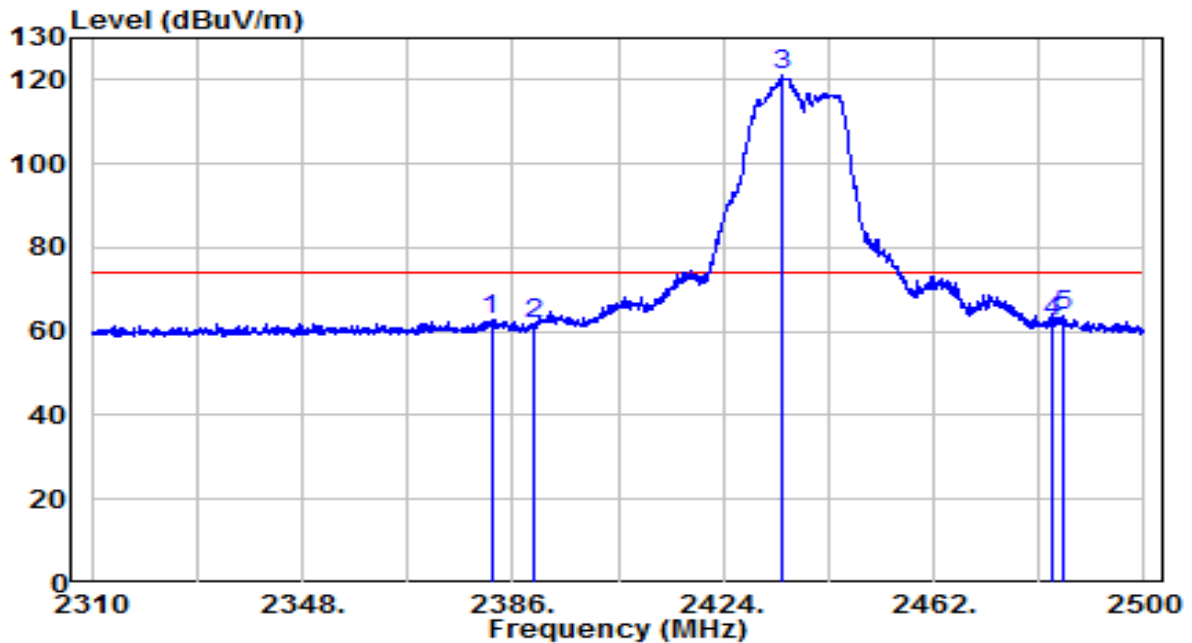

No	Frequency (MHz)	Reading (dBUV)	C.F (dB)	Measurement (dBUV/m)	Margin (dB)	Limit (dBUV/m)	Remark (QP/PK/AV)
1	2382.105	30.69	32.26	62.95	-11.05	74.00	Peak
2	2390.000	29.29	32.30	61.58	-12.42	74.00	Peak
3	* 2434.545	88.56	32.49	121.05	N/A	N/A	Peak
4	2483.500	29.75	32.71	62.45	-11.55	74.00	Peak
5	2485.370	30.86	32.72	63.58	-10.42	74.00	Peak

Note:

1. " \*", means this data is the worst emission level.
2. C.F (Correction Factor) = Antenna Factor (dB)+ Cable Loss (dB).
3. Measurement(dBUV/m) = Reading(dBUV) + C.F (Correction Factor).
4. The emission levels of other frequencies are very lower than the limit and not show in test report.

EUT	OAW-AP1301	Date of Test	2020-11-26
Factor	BBHA 9120D	Temp. / Humidity	23.7°C/42%
Polarity	Vertical	Site / Test Engineer	AC1 / Jay Chiu
Test Mode	Transmit by 802.11n-HT20 at Channel 2437MHz	Test Voltage	120V/60Hz

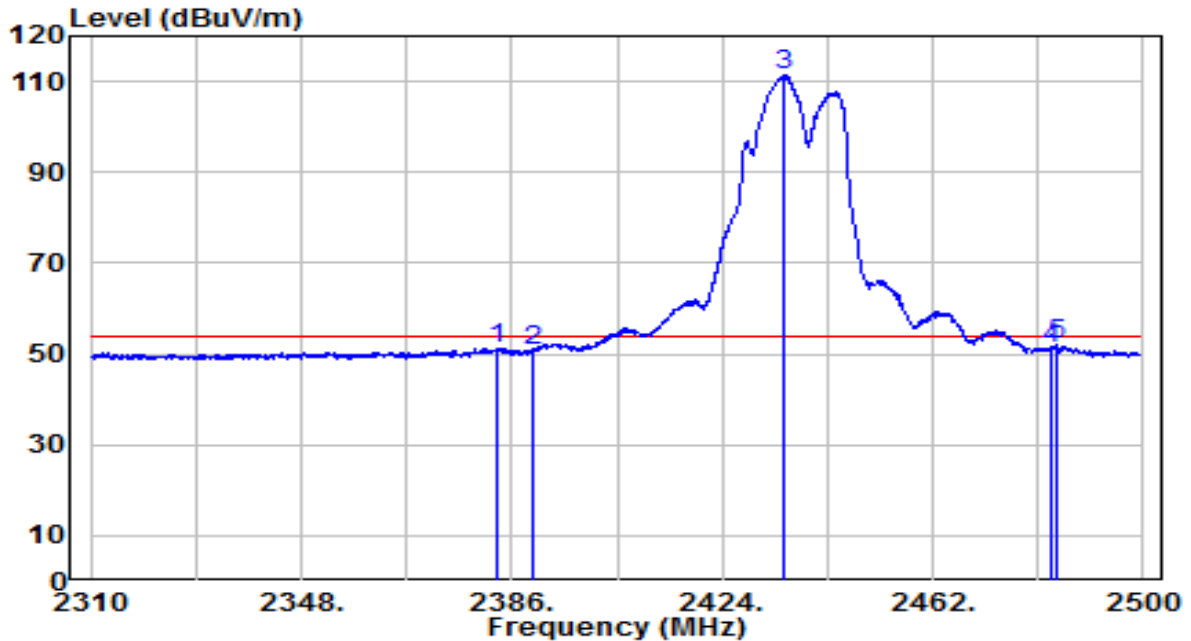

No	Frequency (MHz)	Reading (dBUV)	C.F (dB)	Measurement (dBUV/m)	Margin (dB)	Limit (dBUV/m)	Remark (QP/PK/AV)
1	2383.435	19.10	32.27	51.37	-2.63	54.00	Average
2	2390.000	18.37	32.30	50.66	-3.34	54.00	Average
3	* 2435.210	78.97	32.49	111.47	N/A	N/A	Average
4	2483.500	18.56	32.71	51.26	-2.74	54.00	Average
5	2484.515	19.19	32.71	51.90	-2.10	54.00	Average

Note:

1. " \*", means this data is the worst emission level.
2. C.F (Correction Factor) = Antenna Factor (dB)+ Cable Loss (dB).
3. Measurement(dBUV/m) = Reading(dBUV) + C.F (Correction Factor).
4. The emission levels of other frequencies are very lower than the limit and not show in test report.

EUT	OAW-AP1301	Date of Test	2020-12-18
Factor	BBHA 9120D	Temp. / Humidity	21.2°C/23%
Polarity	Vertical	Site / Test Engineer	AC1 / Jay Chiu
Test Mode	Transmit by 802.11n-HT20 at Channel 2457MHz	Test Voltage	120V/60Hz

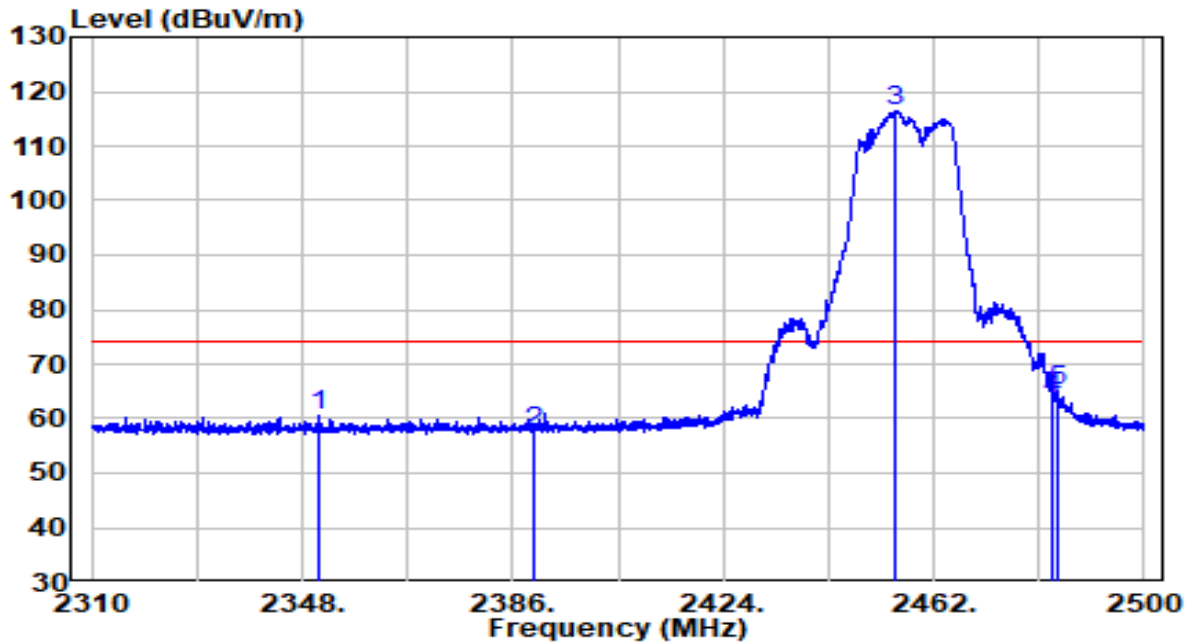

No	Frequency (MHz)	Reading (dBuV)	C.F (dB)	Measurement (dBuV/m)	Margin (dB)	Limit (dBuV/m)	Remark (QP/PK/AV)
1	2351.040	28.41	32.12	60.54	-13.46	74.00	Peak
2	2390.000	25.39	32.30	57.68	-16.32	74.00	Peak
3	* 2455.255	83.87	32.58	116.46	N/A	N/A	Peak
4	2483.500	30.85	32.71	63.55	-10.45	74.00	Peak
5	2484.230	32.36	32.71	65.07	-8.93	74.00	Peak

Note:

1. " \*", means this data is the worst emission level.
2. C.F (Correction Factor) = Antenna Factor (dB)+ Cable Loss (dB).
3. Measurement(dBuV/m) = Reading(dBuV) + C.F (Correction Factor).
4. The emission levels of other frequencies are very lower than the limit and not show in test report.

EUT	OAW-AP1301	Date of Test	2020-12-18
Factor	BBHA 9120D	Temp. / Humidity	21.2°C/23%
Polarity	Vertical	Site / Test Engineer	AC1 / Jay Chiu
Test Mode	Transmit by 802.11n-HT20 at Channel 2457MHz	Test Voltage	120V/60Hz

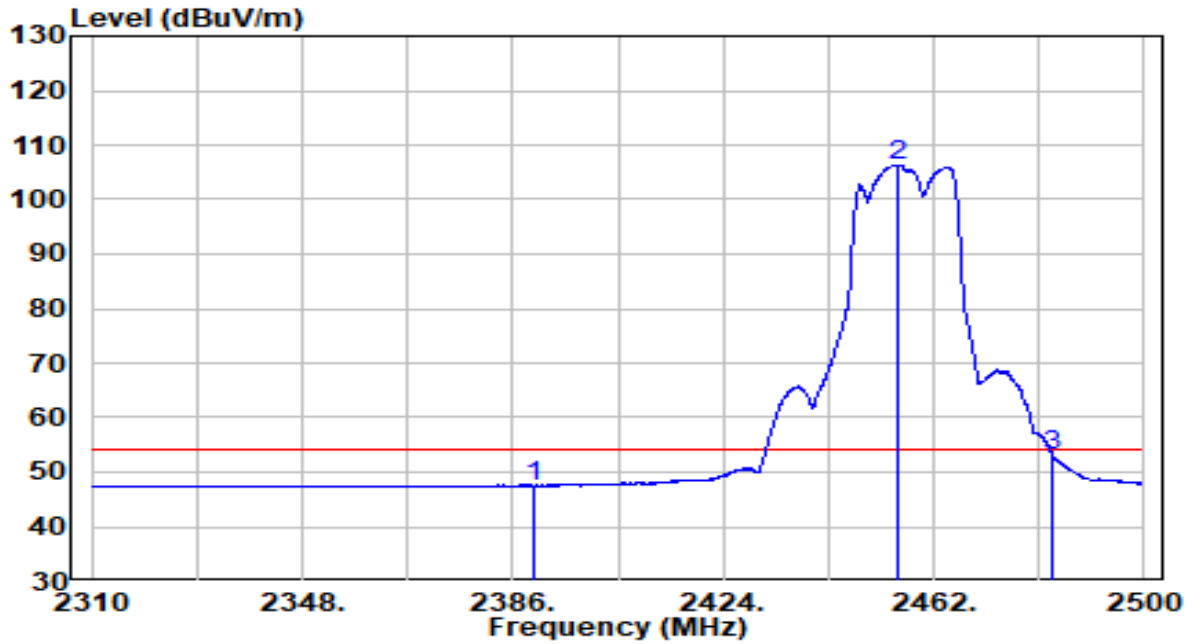

No	Frequency (MHz)	Reading (dBUV)	C.F (dB)	Measurement (dBUV/m)	Margin (dB)	Limit (dBUV/m)	Remark (QP/PK/AV)
1	2390.000	15.18	32.30	47.47	-6.53	54.00	Average
2	* 2455.540	73.78	32.58	106.37	N/A	N/A	Average
3	2483.500	20.28	32.71	52.99	-1.01	54.00	Average

Note:

1. " \*", means this data is the worst emission level.
2. C.F (Correction Factor) = Antenna Factor (dB)+ Cable Loss (dB).
3. Measurement(dBUV/m) = Reading(dBUV) + C.F (Correction Factor).
4. The emission levels of other frequencies are very lower than the limit and not show in test report.

EUT	OAW-AP1301	Date of Test	2020-11-26
Factor	BBHA 9120D	Temp. / Humidity	23.7°C/42%
Polarity	Horizontal	Site / Test Engineer	AC1 / Jay Chiu
Test Mode	Transmit by 802.11n-HT20 at Channel 2462MHz	Test Voltage	120V/60Hz

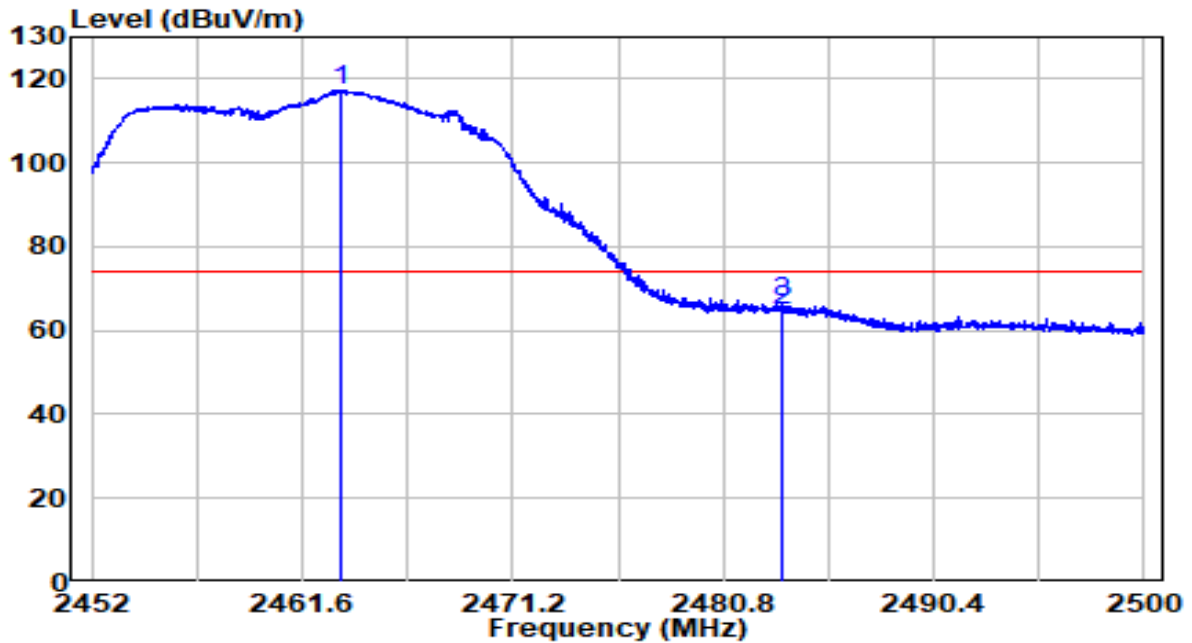

No	Frequency (MHz)	Reading (dBuV)	C.F (dB)	Measurement (dBuV/m)	Margin (dB)	Limit (dBuV/m)	Remark (QP/PK/AV)
1	* 2463.352	84.63	32.62	117.25	N/A	N/A	Peak
2	2483.500	32.06	32.71	64.77	-9.23	74.00	Peak
3	2483.536	33.77	32.71	66.48	-7.52	74.00	Peak

Note:

1. " \*", means this data is the worst emission level.
2. C.F (Correction Factor) = Antenna Factor (dB)+ Cable Loss (dB).
3. Measurement(dBuV/m) = Reading(dBuV) + C.F (Correction Factor).
4. The emission levels of other frequencies are very lower than the limit and not show in test report.



EUT	OAW-AP1301	Date of Test	2020-11-26
Factor	BBHA 9120D	Temp. / Humidity	23.7°C/42%
Polarity	Horizontal	Site / Test Engineer	AC1 / Jay Chiu
Test Mode	Transmit by 802.11n-HT20 at Channel 2462MHz	Test Voltage	120V/60Hz

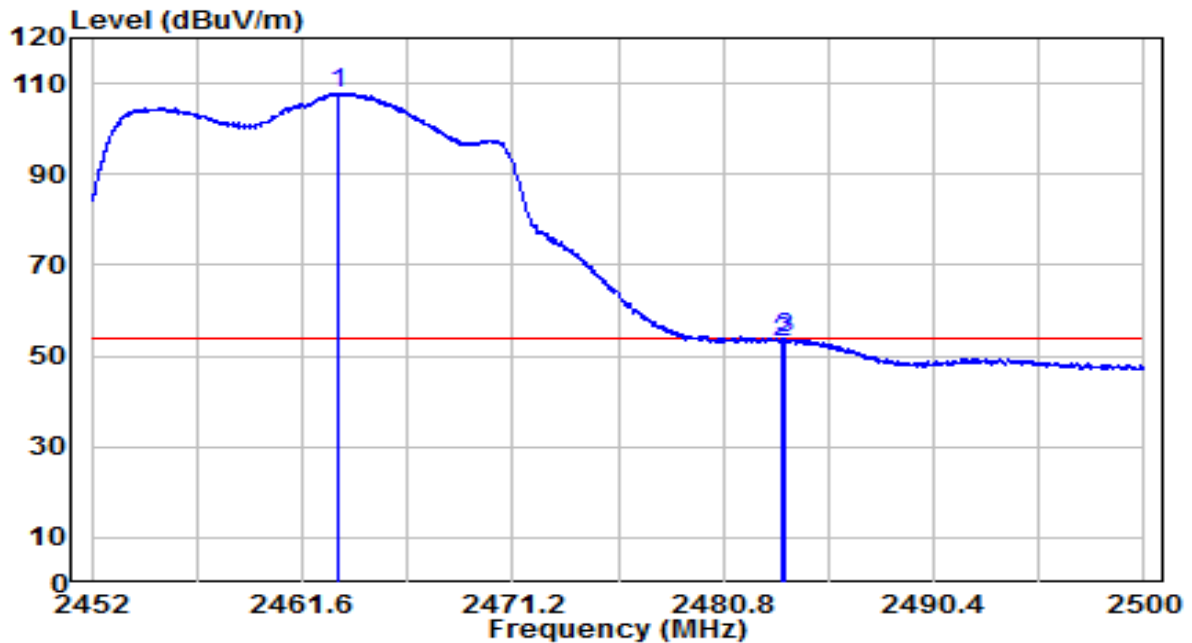

No	Frequency (MHz)	Reading (dBuV)	C.F (dB)	Measurement (dBuV/m)	Margin (dB)	Limit (dBuV/m)	Remark (QP/PK/AV)
1	* 2463.232	75.38	32.62	108.00	N/A	N/A	Average
2	2483.500	20.17	32.71	52.88	-1.12	54.00	Average
3	2483.608	20.97	32.71	53.68	-0.32	54.00	Average

Note:

1. " \*", means this data is the worst emission level.
2. C.F (Correction Factor) = Antenna Factor (dB)+ Cable Loss (dB).
3. Measurement(dBuV/m) = Reading(dBuV) + C.F (Correction Factor).
4. The emission levels of other frequencies are very lower than the limit and not show in test report.

EUT	OAW-AP1301	Date of Test	2020-11-26
Factor	BBHA 9120D	Temp. / Humidity	23.7°C/42%
Polarity	Vertical	Site / Test Engineer	AC1 / Jay Chiu
Test Mode	Transmit by 802.11n-HT20 at Channel 2462MHz	Test Voltage	120V/60Hz

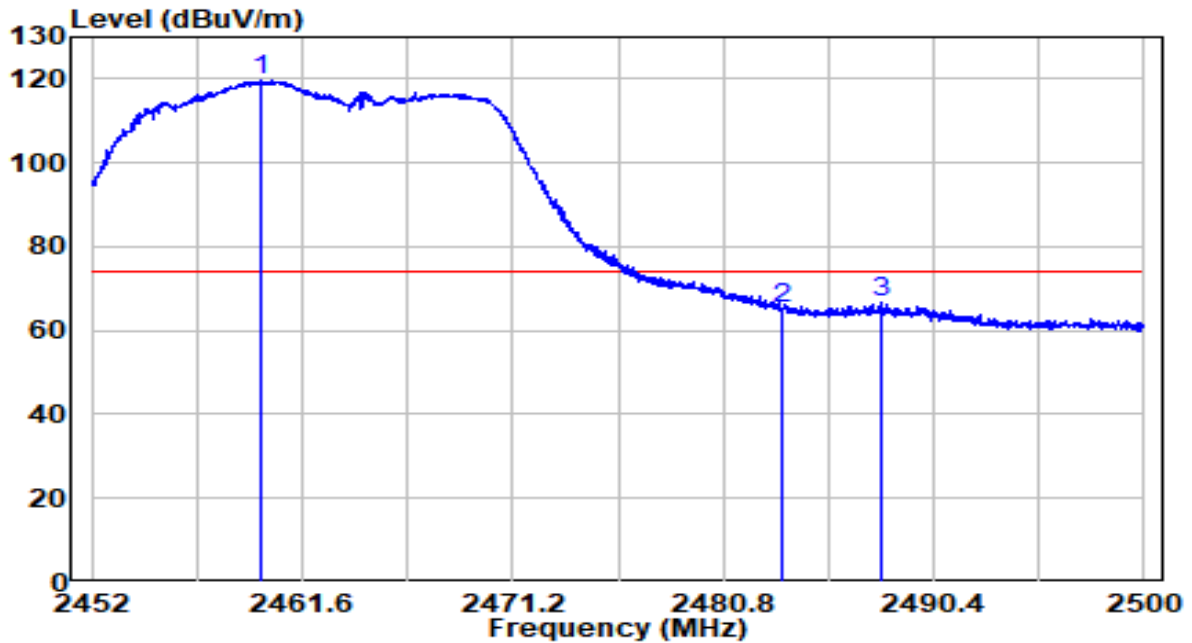

No	Frequency (MHz)	Reading (dBUV)	C.F (dB)	Measurement (dBUV/m)	Margin (dB)	Limit (dBUV/m)	Remark (QP/PK/AV)
1	* 2459.752	87.00	32.60	119.60	N/A	N/A	Peak
2	2483.500	32.37	32.71	65.08	-8.92	74.00	Peak
3	2488.000	33.95	32.73	66.68	-7.32	74.00	Peak

Note:

1. "\*" means this data is the worst emission level.
2. C.F (Correction Factor) = Antenna Factor (dB)+ Cable Loss (dB).
3. Measurement(dBUV/m) = Reading(dBUV) + C.F (Correction Factor).
4. The emission levels of other frequencies are very lower than the limit and not show in test report.

EUT	OAW-AP1301	Date of Test	2020-11-26
Factor	BBHA 9120D	Temp. / Humidity	23.7°C/42%
Polarity	Vertical	Site / Test Engineer	AC1 / Jay Chiu
Test Mode	Transmit by 802.11n-HT20 at Channel 2462MHz	Test Voltage	120V/60Hz

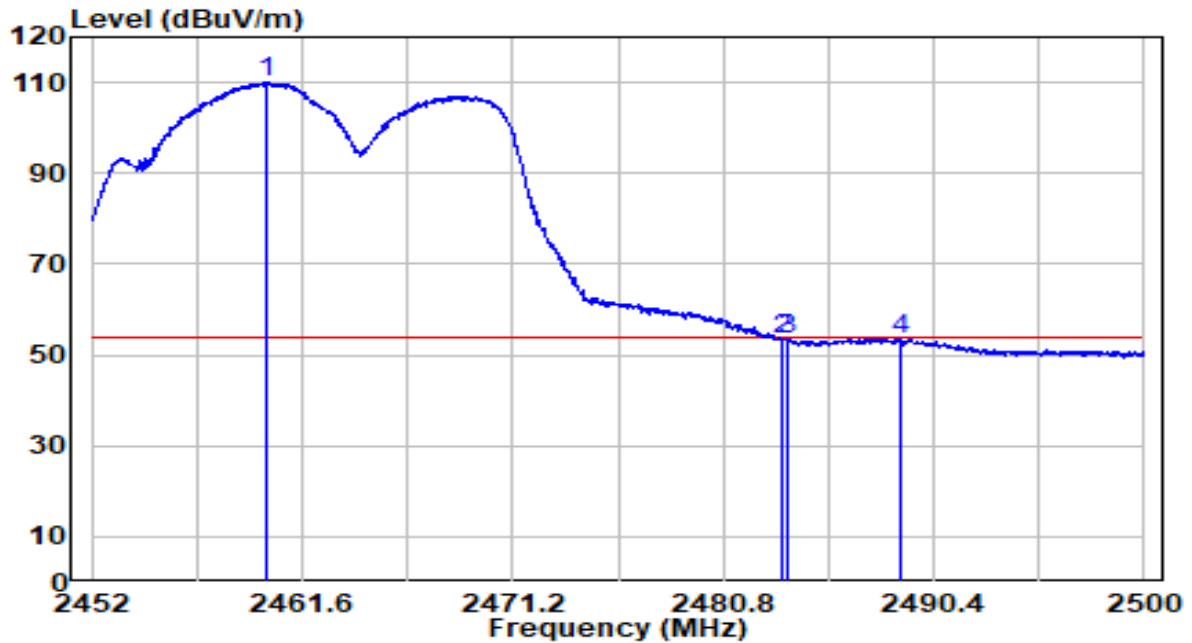

No	Frequency (MHz)	Reading (dBUV)	C.F (dB)	Measurement (dBUV/m)	Margin (dB)	Limit (dBUV/m)	Remark (QP/PK/AV)
1	* 2460.016	77.35	32.60	109.96	N/A	N/A	Average
2	2483.500	20.51	32.71	53.22	-0.78	54.00	Average
3	2483.680	20.90	32.71	53.61	-0.39	54.00	Average
4	2488.936	20.87	32.73	53.60	-0.40	54.00	Average

Note:

1. " \*", means this data is the worst emission level.
2. C.F (Correction Factor) = Antenna Factor (dB)+ Cable Loss (dB).
3. Measurement(dBUV/m) = Reading(dBUV) + C.F (Correction Factor).
4. The emission levels of other frequencies are very lower than the limit and not show in test report.

EUT	OAW-AP1301	Date of Test	2020-11-26
Factor	BBHA 9120D	Temp. / Humidity	23.7°C/42%
Polarity	Horizontal	Site / Test Engineer	AC1 / Jay Chiu
Test Mode	Transmit by 802.11n-HT40 at Channel 2422MHz	Test Voltage	120V/60Hz

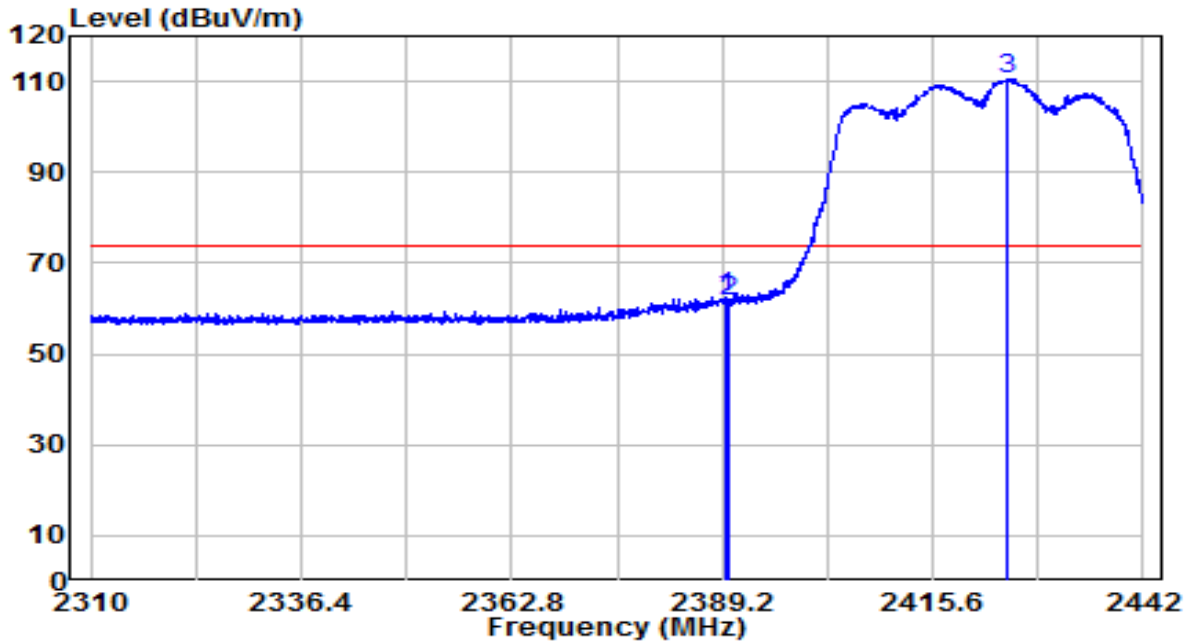

No	Frequency (MHz)	Reading (dBUV)	C.F (dB)	Measurement (dBUV/m)	Margin (dB)	Limit (dBUV/m)	Remark (QP/PK/AV)
1	2389.794	30.36	32.30	62.66	-11.34	74.00	Peak
2	2390.000	29.27	32.30	61.57	-12.43	74.00	Peak
3	* 2424.972	78.00	32.45	110.45	N/A	N/A	Peak

Note:

1. " \*", means this data is the worst emission level.
2. C.F (Correction Factor) = Antenna Factor (dB)+ Cable Loss (dB).
3. Measurement(dBUV/m) = Reading(dBUV) + C.F (Correction Factor).
4. The emission levels of other frequencies are very lower than the limit and not show in test report.

EUT	OAW-AP1301	Date of Test	2020-11-26
Factor	BBHA 9120D	Temp. / Humidity	23.7°C/42%
Polarity	Horizontal	Site / Test Engineer	AC1 / Jay Chiu
Test Mode	Transmit by 802.11n-HT40 at Channel 2422MHz	Test Voltage	120V/60Hz

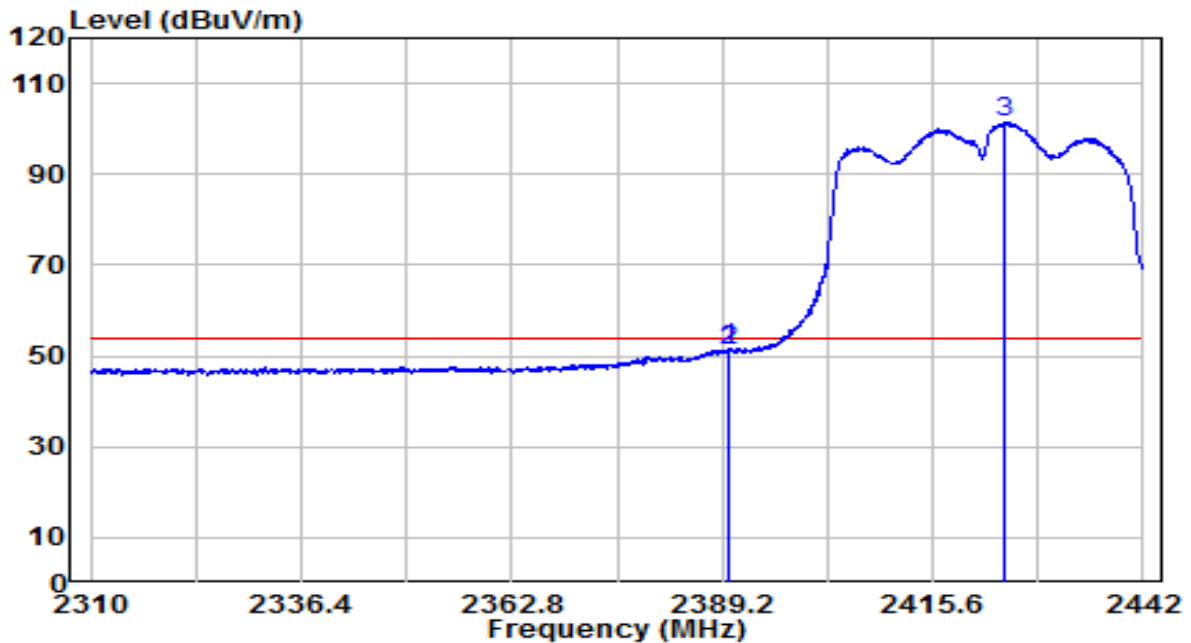

No	Frequency (MHz)	Reading (dBUV)	C.F (dB)	Measurement (dBUV/m)	Margin (dB)	Limit (dBUV/m)	Remark (QP/PK/AV)
1	2389.860	19.11	32.30	51.40	-2.60	54.00	Average
2	2390.000	18.76	32.30	51.06	-2.94	54.00	Average
3	* 2424.510	68.99	32.45	101.44	N/A	N/A	Average

Note:

1. " \*", means this data is the worst emission level.
2. C.F (Correction Factor) = Antenna Factor (dB)+ Cable Loss (dB).
3. Measurement(dBUV/m) = Reading(dBUV) + C.F (Correction Factor).
4. The emission levels of other frequencies are very lower than the limit and not show in test report.

EUT	OAW-AP1301	Date of Test	2020-11-26
Factor	BBHA 9120D	Temp. / Humidity	23.7°C/42%
Polarity	Vertical	Site / Test Engineer	AC1 / Jay Chiu
Test Mode	Transmit by 802.11n-HT40 at Channel 2422MHz	Test Voltage	120V/60Hz

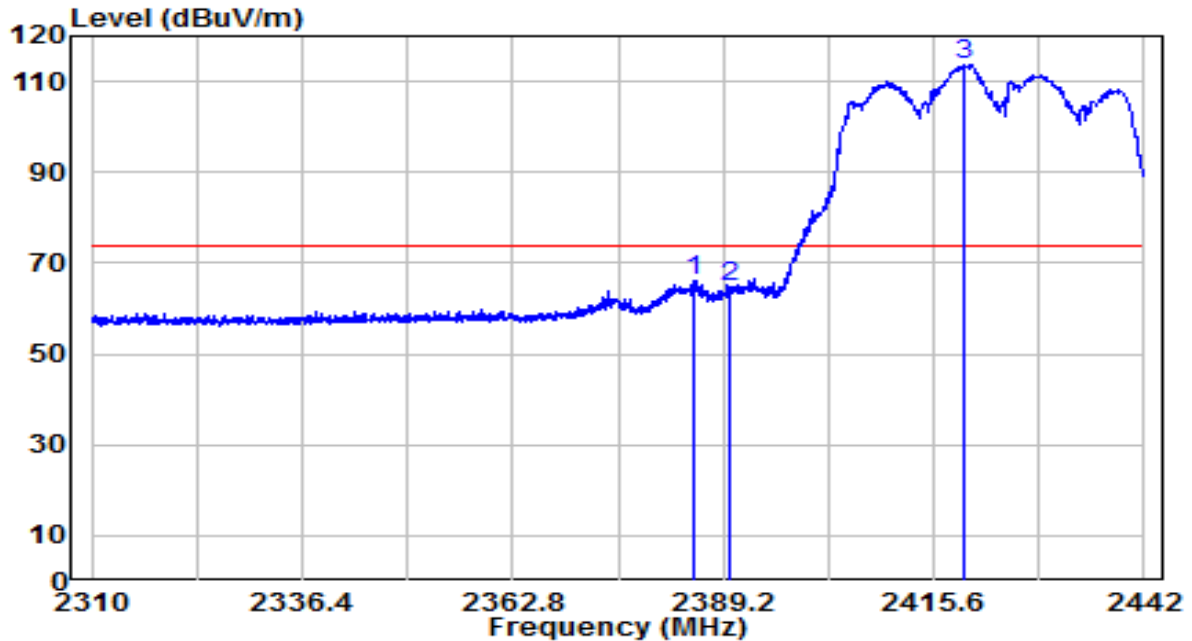

No	Frequency (MHz)	Reading (dBUV)	C.F (dB)	Measurement (dBUV/m)	Margin (dB)	Limit (dBUV/m)	Remark (QP/PK/AV)
1	2385.372	33.96	32.28	66.24	-7.76	74.00	Peak
2	2390.000	32.47	32.30	64.76	-9.24	74.00	Peak
3	* 2419.560	81.31	32.43	113.74	N/A	N/A	Peak

Note:

1. " \*", means this data is the worst emission level.
2. C.F (Correction Factor) = Antenna Factor (dB)+ Cable Loss (dB).
3. Measurement(dBUV/m) = Reading(dBUV) + C.F (Correction Factor).
4. The emission levels of other frequencies are very lower than the limit and not show in test report.

EUT	OAW-AP1301	Date of Test	2020-11-26
Factor	BBHA 9120D	Temp. / Humidity	23.7°C/42%
Polarity	Vertical	Site / Test Engineer	AC1 / Jay Chiu
Test Mode	Transmit by 802.11n-HT40 at Channel 2422MHz	Test Voltage	120V/60Hz

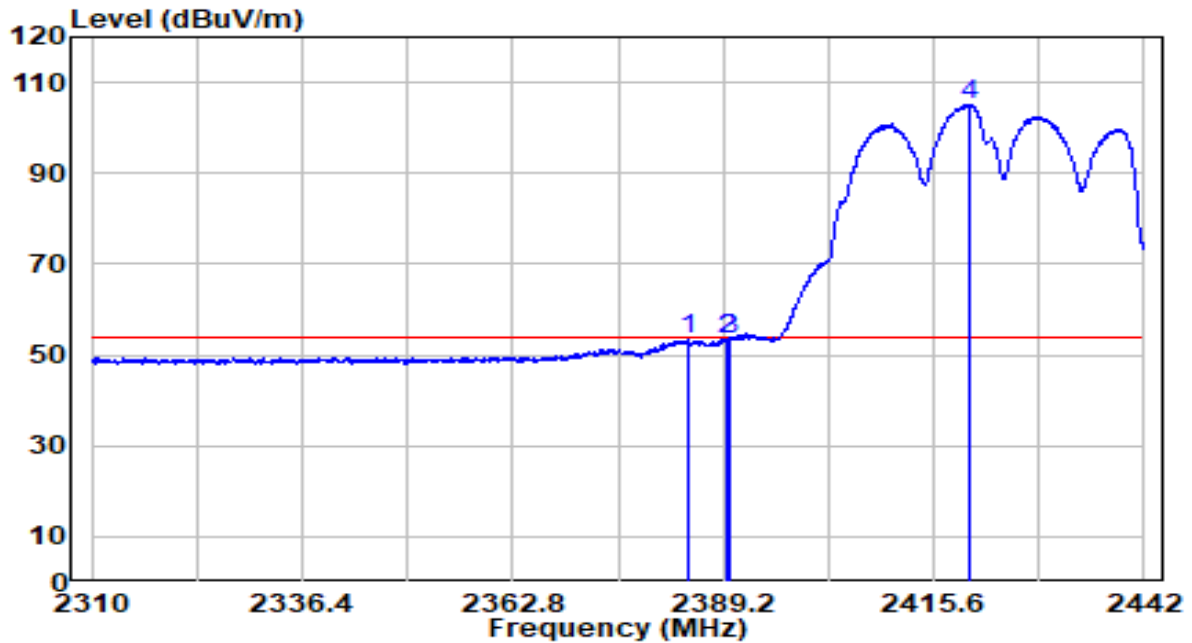

No	Frequency (MHz)	Reading (dBUV)	C.F (dB)	Measurement (dBUV/m)	Margin (dB)	Limit (dBUV/m)	Remark (QP/PK/AV)
1	2384.844	21.02	32.27	53.29	-0.71	54.00	Average
2	2389.596	21.35	32.29	53.64	-0.36	54.00	Average
3	2390.000	21.20	32.30	53.49	-0.51	54.00	Average
4	* 2420.088	72.78	32.43	105.21	N/A	N/A	Average

Note:

1. " \*", means this data is the worst emission level.
2. C.F (Correction Factor) = Antenna Factor (dB)+ Cable Loss (dB).
3. Measurement(dBUV/m) = Reading(dBUV) + C.F (Correction Factor).
4. The emission levels of other frequencies are very lower than the limit and not show in test report.

EUT	OAW-AP1301	Date of Test	2020-12-18
Factor	BBHA 9120D	Temp. / Humidity	21.2°C/23%
Polarity	Vertical	Site / Test Engineer	AC1 / Jay Chiu
Test Mode	Transmit by 802.11n-HT40 at Channel 2427MHz	Test Voltage	120V/60Hz

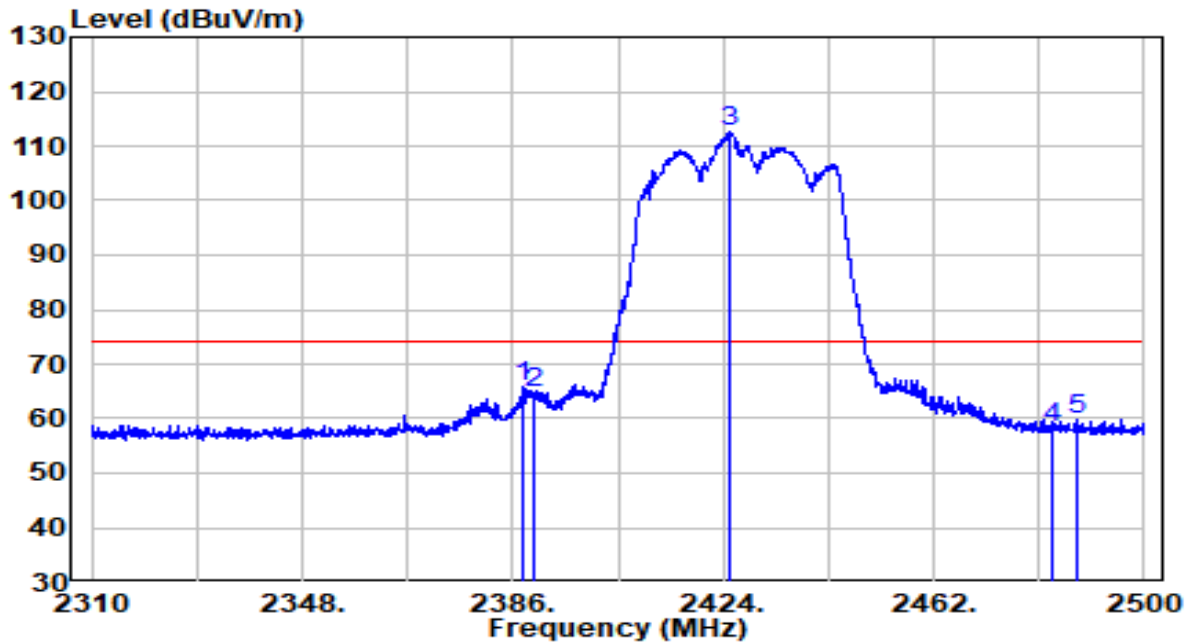

No	Frequency (MHz)	Reading (dBuV)	C.F (dB)	Measurement (dBuV/m)	Margin (dB)	Limit (dBuV/m)	Remark (QP/PK/AV)
1	2387.615	33.46	32.29	65.74	-8.26	74.00	Peak
2	2390.000	32.28	32.30	64.58	-9.42	74.00	Peak
3	* 2425.330	80.12	32.45	112.57	N/A	N/A	Peak
4	2483.500	25.54	32.71	58.25	-15.75	74.00	Peak
5	2487.745	27.25	32.73	59.98	-14.02	74.00	Peak

Note:

- "\*", means this data is the worst emission level.
- C.F (Correction Factor) = Antenna Factor (dB)+ Cable Loss (dB).
- Measurement(dBuV/m) = Reading(dBuV) + C.F (Correction Factor).
- The emission levels of other frequencies are very lower than the limit and not show in test report.



EUT	OAW-AP1301	Date of Test	2020-12-18
Factor	BBHA 9120D	Temp. / Humidity	21.2°C/23%
Polarity	Vertical	Site / Test Engineer	AC1 / Jay Chiu
Test Mode	Transmit by 802.11n-HT40 at Channel 2427MHz	Test Voltage	120V/60Hz

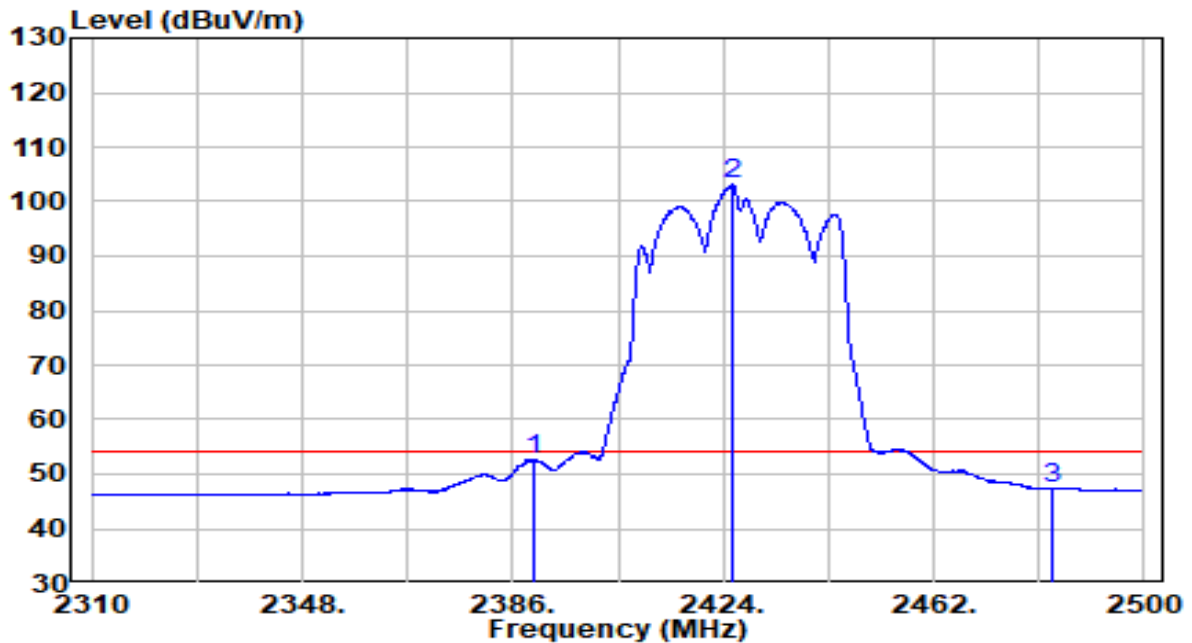

No	Frequency (MHz)	Reading (dBuV)	C.F (dB)	Measurement (dBuV/m)	Margin (dB)	Limit (dBuV/m)	Remark (QP/PK/AV)
1	2390.000	20.32	32.30	52.61	-1.39	54.00	Average
2	* 2425.710	70.60	32.45	103.05	N/A	N/A	Average
3	2483.500	14.68	32.71	47.39	-6.61	54.00	Average

Note:

1. " \*", means this data is the worst emission level.
2. C.F (Correction Factor) = Antenna Factor (dB)+ Cable Loss (dB).
3. Measurement(dBuV/m) = Reading(dBuV) + C.F (Correction Factor).
4. The emission levels of other frequencies are very lower than the limit and not show in test report.

EUT	OAW-AP1301	Date of Test	2020-11-26
Factor	BBHA 9120D	Temp. / Humidity	23.7°C/42%
Polarity	Horizontal	Site / Test Engineer	AC1 / Jay Chiu
Test Mode	Transmit by 802.11n-HT40 at Channel 2437MHz	Test Voltage	120V/60Hz

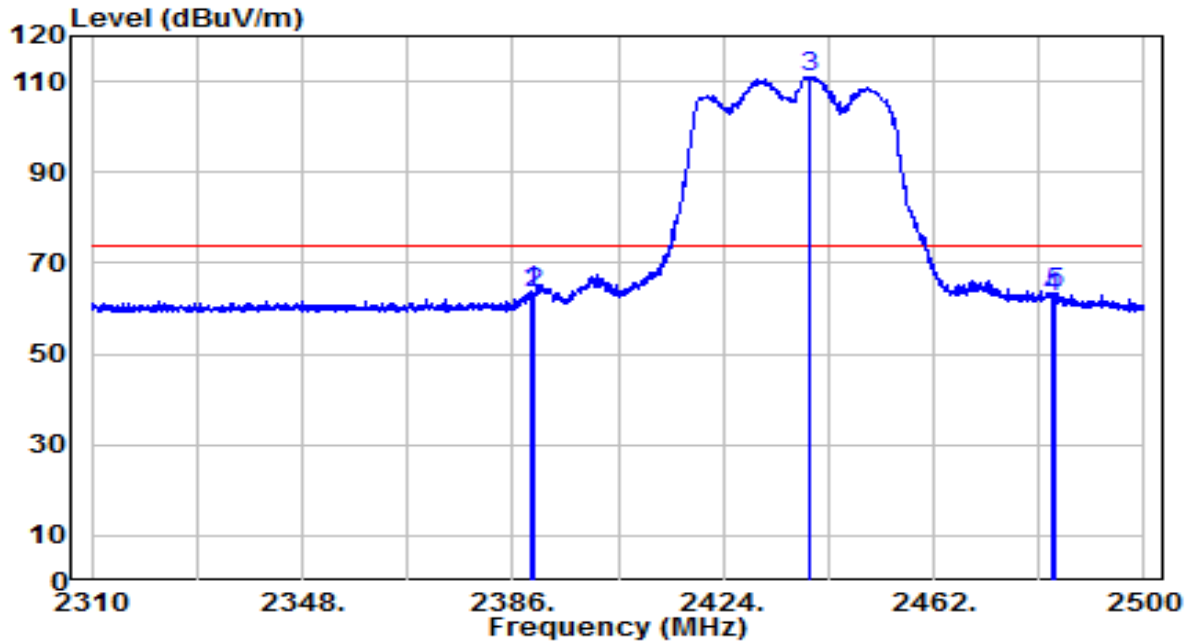

No	Frequency (MHz)	Reading (dBUV)	C.F (dB)	Measurement (dBUV/m)	Margin (dB)	Limit (dBUV/m)	Remark (QP/PK/AV)
1	2389.230	31.55	32.29	63.85	-10.15	74.00	Peak
2	2390.000	31.12	32.30	63.42	-10.58	74.00	Peak
3	* 2439.390	78.63	32.51	111.14	N/A	N/A	Peak
4	2483.500	29.76	32.71	62.47	-11.53	74.00	Peak
5	2483.755	30.67	32.71	63.38	-10.62	74.00	Peak

Note:

1. " \*", means this data is the worst emission level.
2. C.F (Correction Factor) = Antenna Factor (dB)+ Cable Loss (dB).
3. Measurement(dBUV/m) = Reading(dBUV) + C.F (Correction Factor).
4. The emission levels of other frequencies are very lower than the limit and not show in test report.

EUT	OAW-AP1301	Date of Test	2020-11-26
Factor	BBHA 9120D	Temp. / Humidity	23.7°C/42%
Polarity	Horizontal	Site / Test Engineer	AC1 / Jay Chiu
Test Mode	Transmit by 802.11n-HT40 at Channel 2437MHz	Test Voltage	120V/60Hz

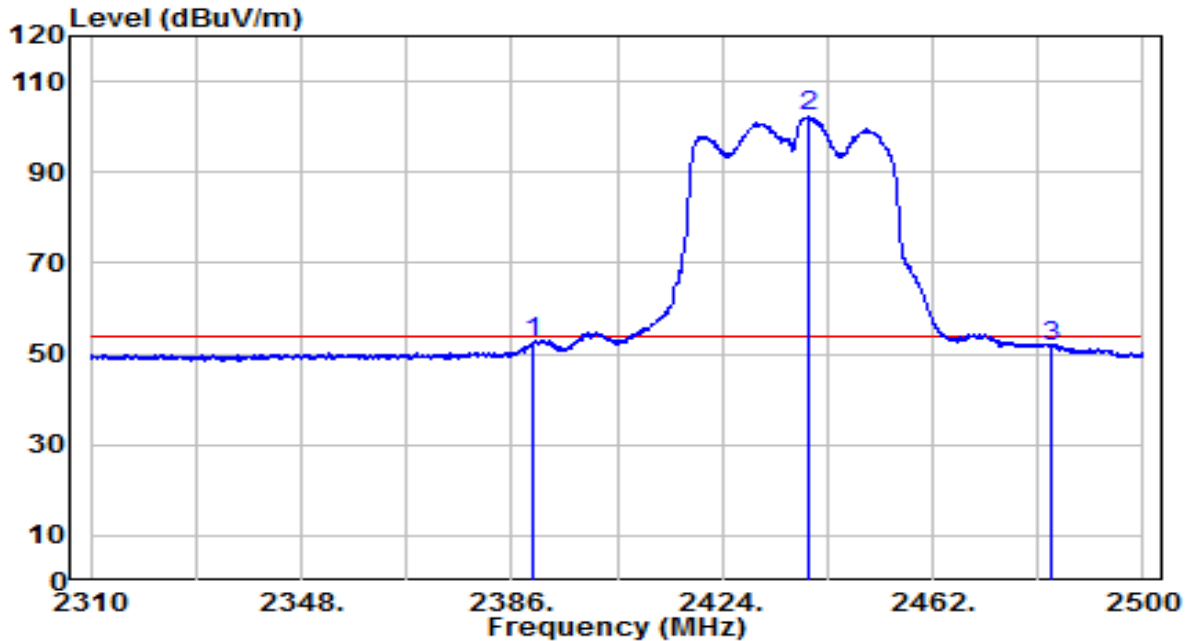

No	Frequency (MHz)	Reading (dBUV)	C.F (dB)	Measurement (dBUV/m)	Margin (dB)	Limit (dBUV/m)	Remark (QP/PK/AV)
1	2390.000	20.27	32.30	52.57	-1.43	54.00	Average
2	* 2439.580	69.62	32.51	102.13	N/A	N/A	Average
3	2483.500	18.90	32.71	51.61	-2.39	54.00	Average

Note:

1. " \*", means this data is the worst emission level.
2. C.F (Correction Factor) = Antenna Factor (dB)+ Cable Loss (dB).
3. Measurement(dBUV/m) = Reading(dBUV) + C.F (Correction Factor).
4. The emission levels of other frequencies are very lower than the limit and not show in test report.

EUT	OAW-AP1301	Date of Test	2020-11-26
Factor	BBHA 9120D	Temp. / Humidity	23.7°C/42%
Polarity	Vertical	Site / Test Engineer	AC1 / Jay Chiu
Test Mode	Transmit by 802.11n-HT40 at Channel 2437MHz	Test Voltage	120V/60Hz

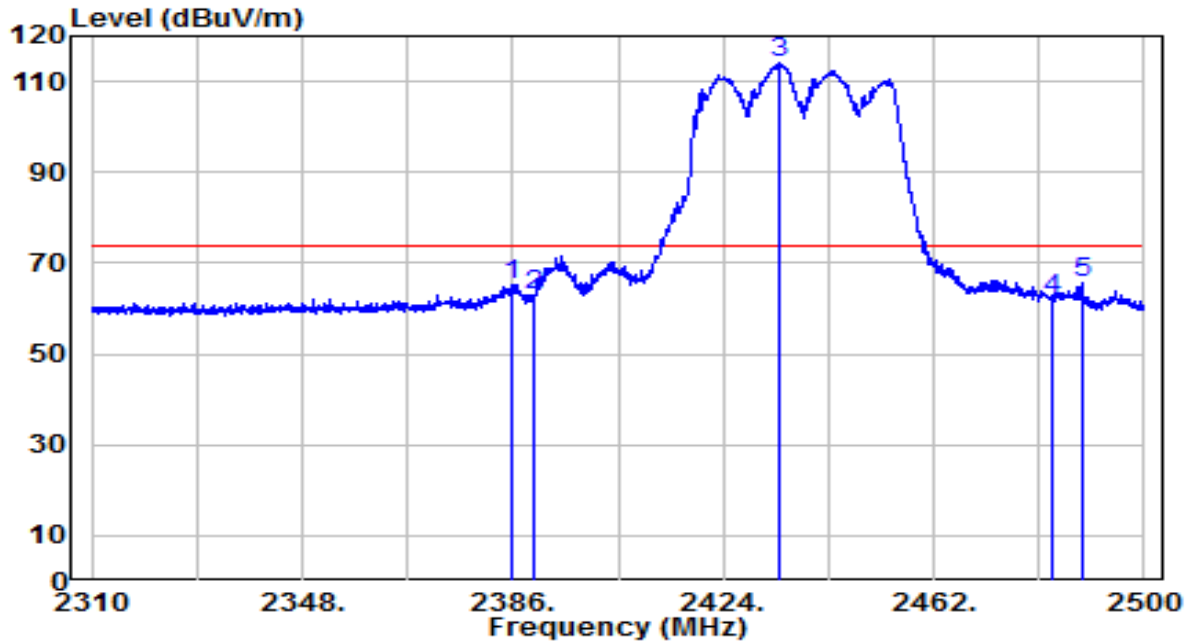

No	Frequency (MHz)	Reading (dBUV)	C.F (dB)	Measurement (dBUV/m)	Margin (dB)	Limit (dBUV/m)	Remark (QP/PK/AV)
1	2385.715	33.14	32.28	65.42	-8.58	74.00	Peak
2	2390.000	30.69	32.30	62.99	-11.01	74.00	Peak
3	* 2434.260	81.62	32.49	114.11	N/A	N/A	Peak
4	2483.500	29.19	32.71	61.90	-12.10	74.00	Peak
5	2488.790	32.80	32.73	65.53	-8.47	74.00	Peak

Note:

1. " \*", means this data is the worst emission level.
2. C.F (Correction Factor) = Antenna Factor (dB)+ Cable Loss (dB).
3. Measurement(dBUV/m) = Reading(dBUV) + C.F (Correction Factor).
4. The emission levels of other frequencies are very lower than the limit and not show in test report.

EUT	OAW-AP1301	Date of Test	2020-11-26
Factor	BBHA 9120D	Temp. / Humidity	23.7°C/42%
Polarity	Vertical	Site / Test Engineer	AC1 / Jay Chiu
Test Mode	Transmit by 802.11n-HT40 at Channel 2437MHz	Test Voltage	120V/60Hz

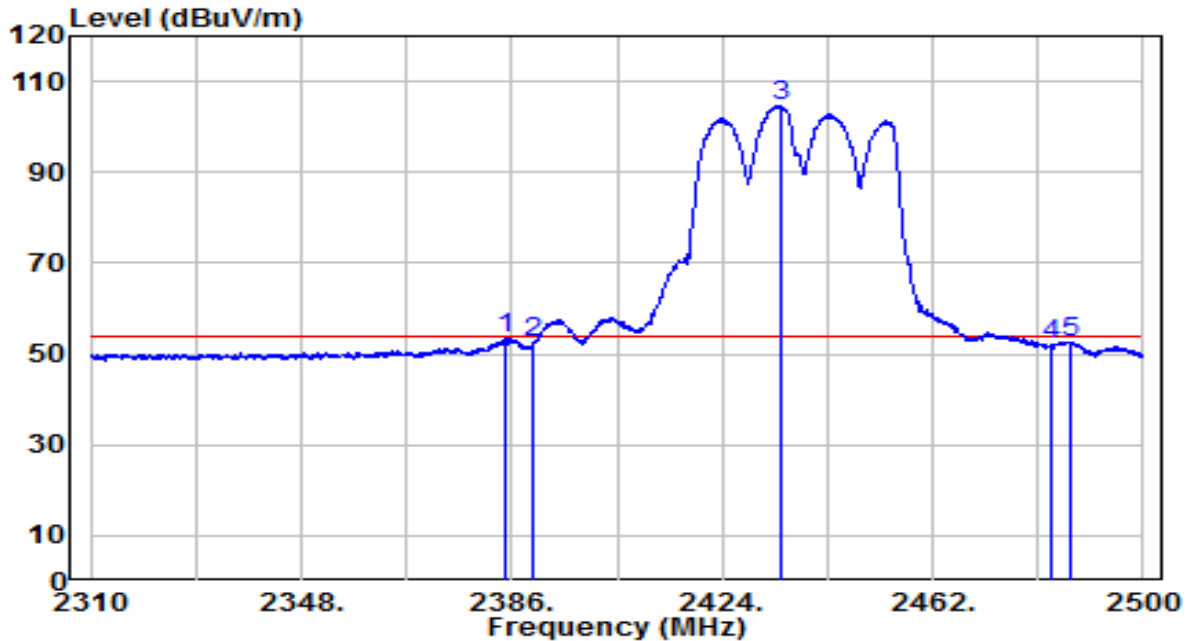

No	Frequency (MHz)	Reading (dBUV)	C.F (dB)	Measurement (dBUV/m)	Margin (dB)	Limit (dBUV/m)	Remark (QP/PK/AV)
1	2385.050	21.24	32.27	53.51	-0.49	54.00	Average
2	2390.000	20.36	32.30	52.65	-1.35	54.00	Average
3	* 2434.830	72.09	32.49	104.58	N/A	N/A	Average
4	2483.500	19.34	32.71	52.05	-1.95	54.00	Average
5	2486.985	20.03	32.72	52.75	-1.25	54.00	Average

Note:

1. " \*", means this data is the worst emission level.
2. C.F (Correction Factor) = Antenna Factor (dB)+ Cable Loss (dB).
3. Measurement(dBUV/m) = Reading(dBUV) + C.F (Correction Factor).
4. The emission levels of other frequencies are very lower than the limit and not show in test report.

EUT	OAW-AP1301	Date of Test	2020-12-18
Factor	BBHA 9120D	Temp. / Humidity	21.2°C/23%
Polarity	Vertical	Site / Test Engineer	AC1 / Jay Chiu
Test Mode	Transmit by 802.11n-HT40 at Channel 2447MHz	Test Voltage	120V/60Hz

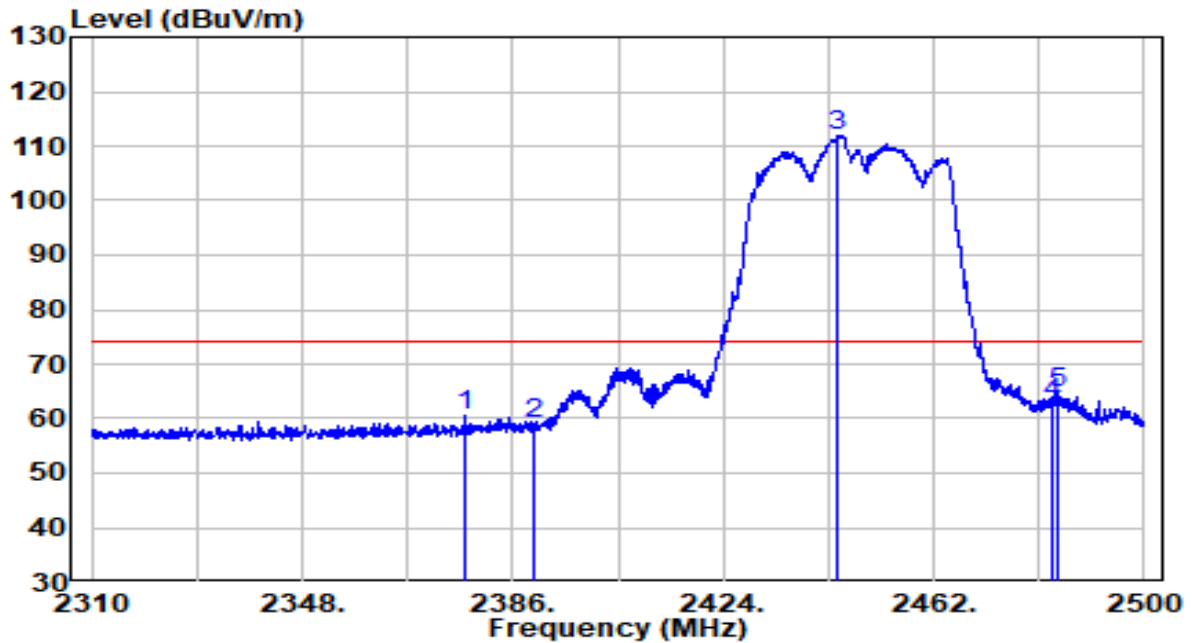

No	Frequency (MHz)	Reading (dBuV)	C.F (dB)	Measurement (dBuV/m)	Margin (dB)	Limit (dBuV/m)	Remark (QP/PK/AV)
1	2377.355	28.20	32.24	60.44	-13.56	74.00	Peak
2	2390.000	26.70	32.30	59.00	-15.00	74.00	Peak
3	* 2444.710	79.52	32.54	112.06	N/A	N/A	Peak
4	2483.500	30.15	32.71	62.86	-11.14	74.00	Peak
5	2484.420	32.14	32.71	64.85	-9.15	74.00	Peak

Note:

- "\*", means this data is the worst emission level.
- C.F (Correction Factor) = Antenna Factor (dB)+ Cable Loss (dB).
- Measurement(dBuV/m) = Reading(dBuV) + C.F (Correction Factor).
- The emission levels of other frequencies are very lower than the limit and not show in test report.

EUT	OAW-AP1301	Date of Test	2020-12-18
Factor	BBHA 9120D	Temp. / Humidity	21.2°C/23%
Polarity	Vertical	Site / Test Engineer	AC1 / Jay Chiu
Test Mode	Transmit by 802.11n-HT40 at Channel 2447MHz	Test Voltage	120V/60Hz

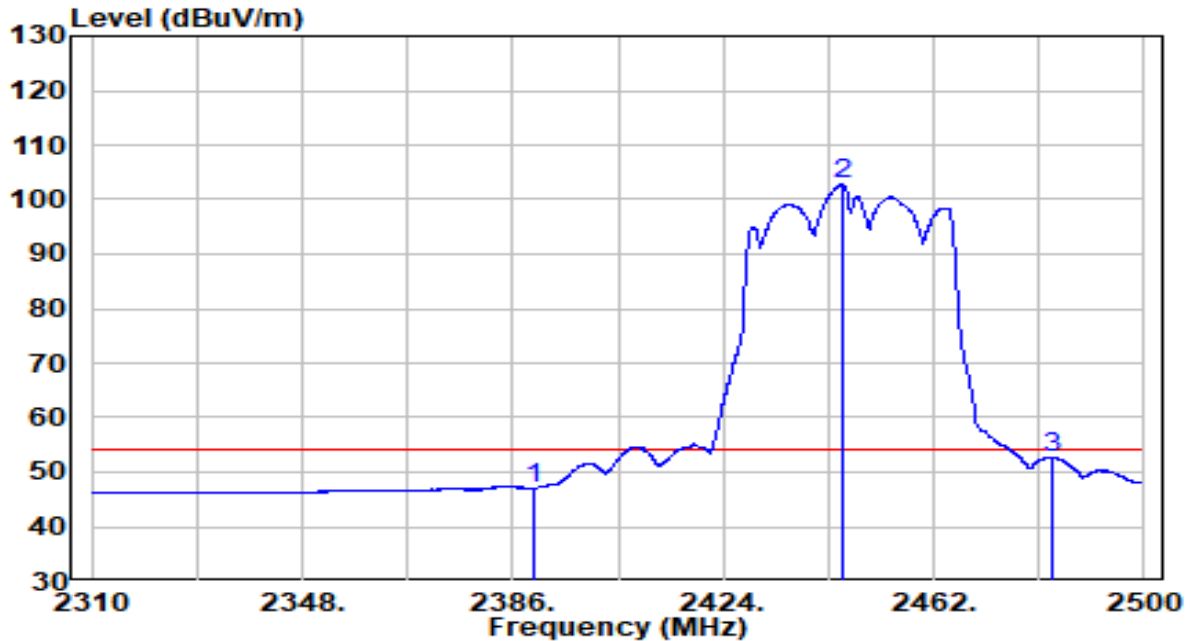

No	Frequency (MHz)	Reading (dBUV)	C.F (dB)	Measurement (dBUV/m)	Margin (dB)	Limit (dBUV/m)	Remark (QP/PK/AV)
1	2390.000	14.78	32.30	47.08	-6.92	54.00	Average
2	* 2445.470	70.35	32.54	102.89	N/A	N/A	Average
3	2483.500	19.86	32.71	52.57	-1.43	54.00	Average

Note:

1. " \*", means this data is the worst emission level.
2. C.F (Correction Factor) = Antenna Factor (dB)+ Cable Loss (dB).
3. Measurement(dBUV/m) = Reading(dBUV) + C.F (Correction Factor).
4. The emission levels of other frequencies are very lower than the limit and not show in test report.

EUT	OAW-AP1301	Date of Test	2020-11-26
Factor	BBHA 9120D	Temp. / Humidity	23.7°C/42%
Polarity	Horizontal	Site / Test Engineer	AC1 / Jay Chiu
Test Mode	Transmit by 802.11n-HT40 at Channel 2452MHz	Test Voltage	120V/60Hz

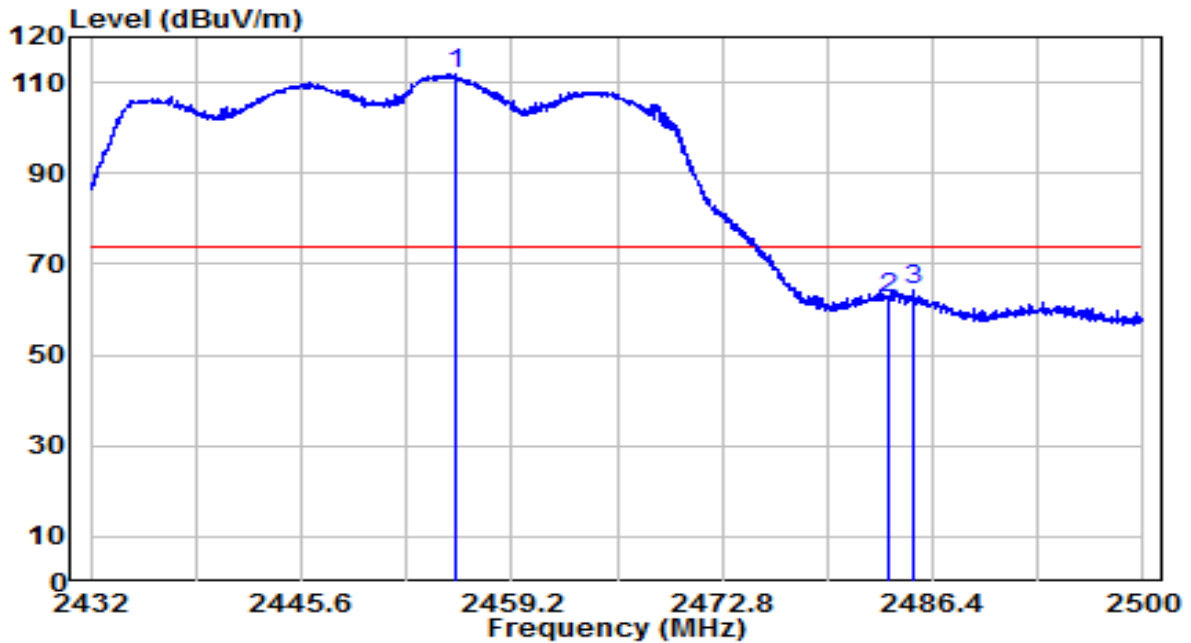

No	Frequency (MHz)	Reading (dBuV)	C.F (dB)	Measurement (dBuV/m)	Margin (dB)	Limit (dBuV/m)	Remark (QP/PK/AV)
1	* 2455.630	79.38	32.58	111.97	N/A	N/A	Peak
2	2483.500	29.60	32.71	62.31	-11.69	74.00	Peak
3	2485.108	31.55	32.71	64.26	-9.74	74.00	Peak

Note:

1. " \*", means this data is the worst emission level.
2. C.F (Correction Factor) = Antenna Factor (dB)+ Cable Loss (dB).
3. Measurement(dBuV/m) = Reading(dBuV) + C.F (Correction Factor).
4. The emission levels of other frequencies are very lower than the limit and not show in test report.



EUT	OAW-AP1301	Date of Test	2020-11-26
Factor	BBHA 9120D	Temp. / Humidity	23.7°C/42%
Polarity	Horizontal	Site / Test Engineer	AC1 / Jay Chiu
Test Mode	Transmit by 802.11n-HT40 at Channel 2452MHz	Test Voltage	120V/60Hz

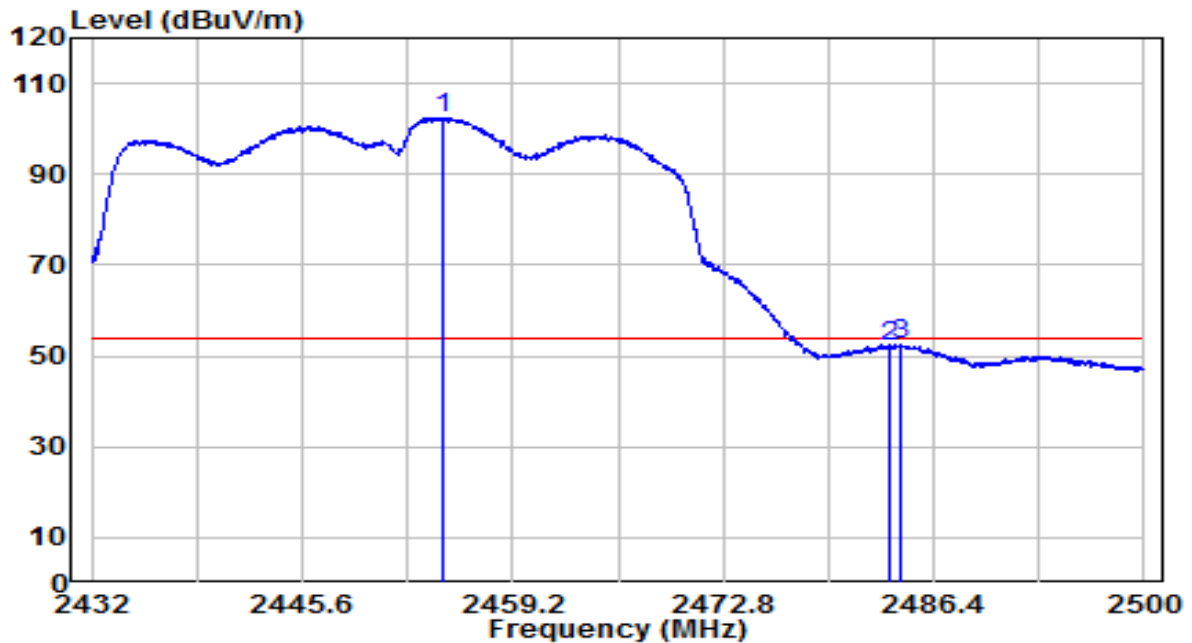

No	Frequency (MHz)	Reading (dBuV)	C.F (dB)	Measurement (dBuV/m)	Margin (dB)	Limit (dBuV/m)	Remark (QP/PK/AV)
1	* 2454.746	69.94	32.58	102.52	N/A	N/A	Average
2	2483.500	19.30	32.71	52.01	-1.99	54.00	Average
3	2484.190	19.85	32.71	52.56	-1.44	54.00	Average

Note:

1. " \*", means this data is the worst emission level.
2. C.F (Correction Factor) = Antenna Factor (dB)+ Cable Loss (dB).
3. Measurement(dBuV/m) = Reading(dBuV) + C.F (Correction Factor).
4. The emission levels of other frequencies are very lower than the limit and not show in test report.

EUT	OAW-AP1301	Date of Test	2020-11-26
Factor	BBHA 9120D	Temp. / Humidity	23.7°C/42%
Polarity	Vertical	Site / Test Engineer	AC1 / Jay Chiu
Test Mode	Transmit by 802.11n-HT40 at Channel 2452MHz	Test Voltage	120V/60Hz

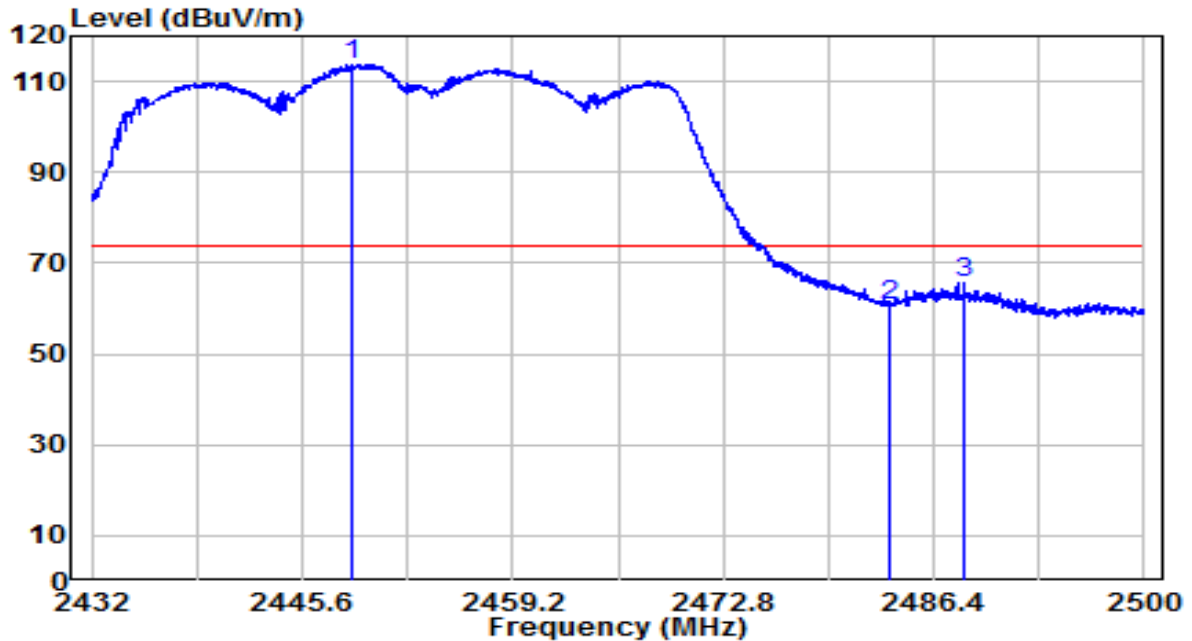

No	Frequency (MHz)	Reading (dBuV)	C.F (dB)	Measurement (dBuV/m)	Margin (dB)	Limit (dBuV/m)	Remark (QP/PK/AV)
1	* 2448.796	81.10	32.55	113.65	N/A	N/A	Peak
2	2483.500	28.03	32.71	60.73	-13.27	74.00	Peak
3	2488.372	33.02	32.73	65.75	-8.25	74.00	Peak

Note:

1. " \*", means this data is the worst emission level.
2. C.F (Correction Factor) = Antenna Factor (dB)+ Cable Loss (dB).
3. Measurement(dBuV/m) = Reading(dBuV) + C.F (Correction Factor).
4. The emission levels of other frequencies are very lower than the limit and not show in test report.

EUT	OAW-AP1301	Date of Test	2020-11-26
Factor	BBHA 9120D	Temp. / Humidity	23.7°C/42%
Polarity	Vertical	Site / Test Engineer	AC1 / Jay Chiu
Test Mode	Transmit by 802.11n-HT40 at Channel 2452MHz	Test Voltage	120V/60Hz

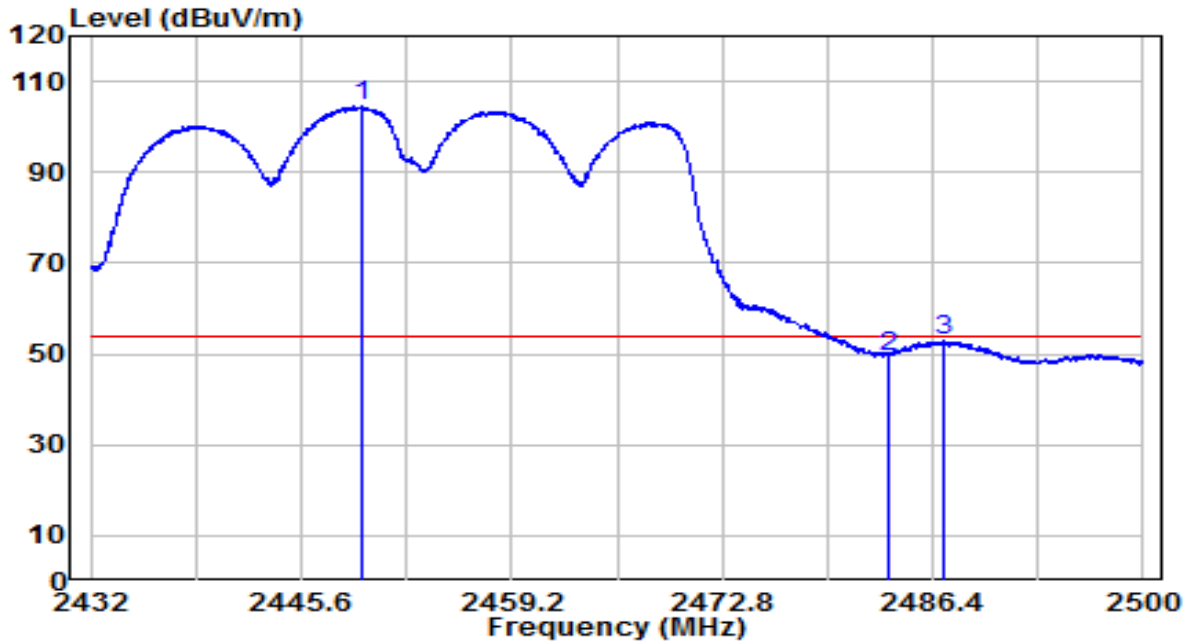

No	Frequency (MHz)	Reading (dBuV)	C.F (dB)	Measurement (dBuV/m)	Margin (dB)	Limit (dBuV/m)	Remark (QP/PK/AV)
1	*	71.92	32.56	104.48	N/A	N/A	Average
2		16.78	32.71	49.49	-4.51	54.00	Average
3		20.22	32.72	52.94	-1.06	54.00	Average

Note:

1. " \*", means this data is the worst emission level.
2. C.F (Correction Factor) = Antenna Factor (dB)+ Cable Loss (dB).
3. Measurement(dBuV/m) = Reading(dBuV) + C.F (Correction Factor).
4. The emission levels of other frequencies are very lower than the limit and not show in test report.

EUT	OAW-AP1301	Date of Test	2020-11-26
Factor	BBHA 9120D	Temp. / Humidity	23.7°C/42%
Polarity	Horizontal	Site / Test Engineer	AC1 / Jay Chiu
Test Mode	Transmit by VHT20 at Channel 2412MHz	Test Voltage	120V/60Hz

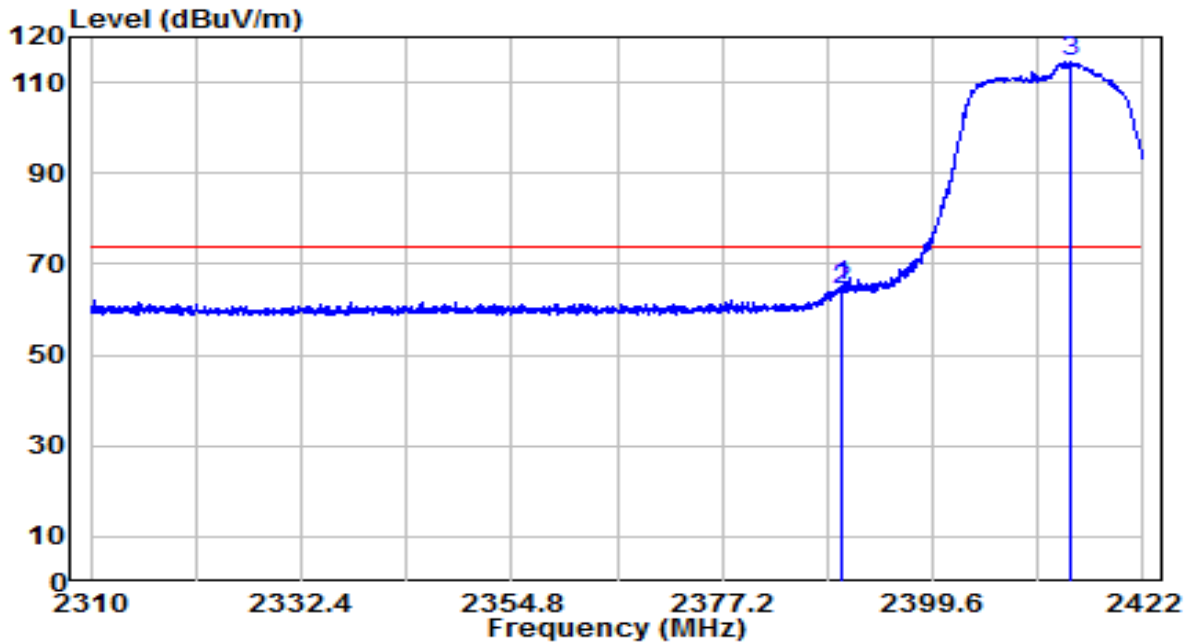

No	Frequency (MHz)	Reading (dBuV)	C.F (dB)	Measurement (dBuV/m)	Margin (dB)	Limit (dBuV/m)	Remark (QP/PK/AV)
1	2389.968	32.78	32.30	65.08	-8.92	74.00	Peak
2	2390.000	32.09	32.30	64.39	-9.61	74.00	Peak
3	* 2414.216	81.98	32.40	114.38	N/A	N/A	Peak

Note:

1. " \*", means this data is the worst emission level.
2. C.F (Correction Factor) = Antenna Factor (dB)+ Cable Loss (dB).
3. Measurement(dBuV/m) = Reading(dBuV) + C.F (Correction Factor).
4. The emission levels of other frequencies are very lower than the limit and not show in test report.

EUT	OAW-AP1301	Date of Test	2020-11-26
Factor	BBHA 9120D	Temp. / Humidity	23.7°C/42%
Polarity	Horizontal	Site / Test Engineer	AC1 / Jay Chiu
Test Mode	Transmit by VHT20 at Channel 2412MHz	Test Voltage	120V/60Hz

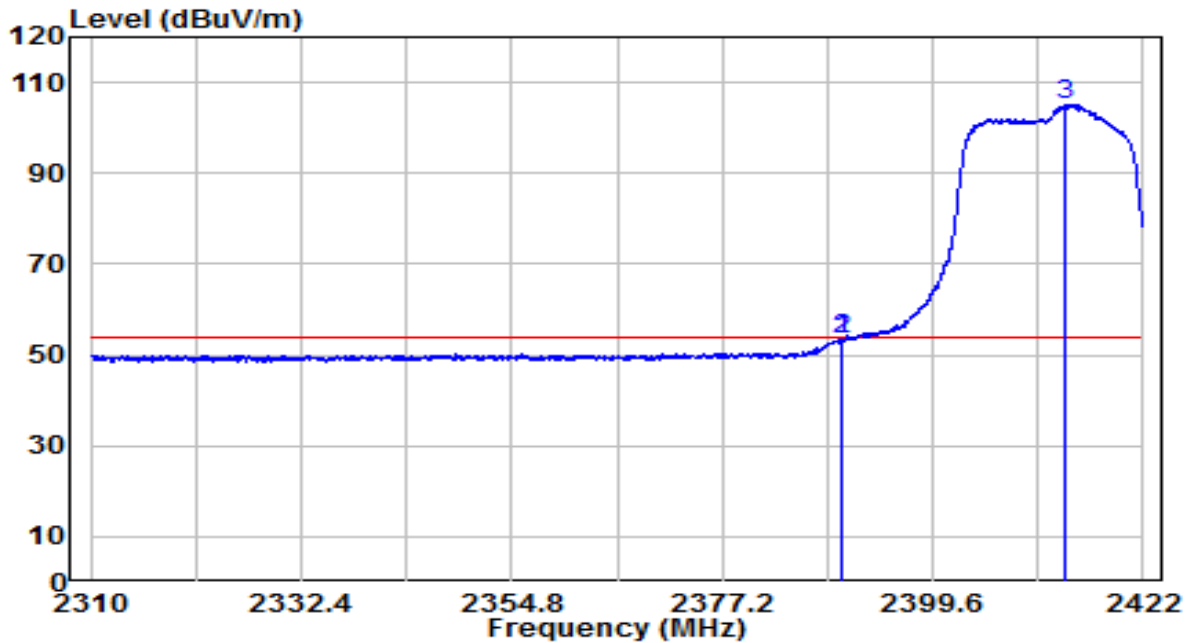

No	Frequency (MHz)	Reading (dBuV)	C.F (dB)	Measurement (dBuV/m)	Margin (dB)	Limit (dBuV/m)	Remark (QP/PK/AV)
1	2389.968	20.96	32.30	53.25	-0.75	54.00	Average
2	2390.000	20.92	32.30	53.22	-0.78	54.00	Average
3	* 2413.824	72.82	32.40	105.22	N/A	N/A	Average

Note:

1. " \*", means this data is the worst emission level.
2. C.F (Correction Factor) = Antenna Factor (dB)+ Cable Loss (dB).
3. Measurement(dBuV/m) = Reading(dBuV) + C.F (Correction Factor).
4. The emission levels of other frequencies are very lower than the limit and not show in test report.

EUT	OAW-AP1301	Date of Test	2020-11-26
Factor	BBHA 9120D	Temp. / Humidity	23.7°C/42%
Polarity	Vertical	Site / Test Engineer	AC1 / Jay Chiu
Test Mode	Transmit by VHT20 at Channel 2412MHz	Test Voltage	120V/60Hz

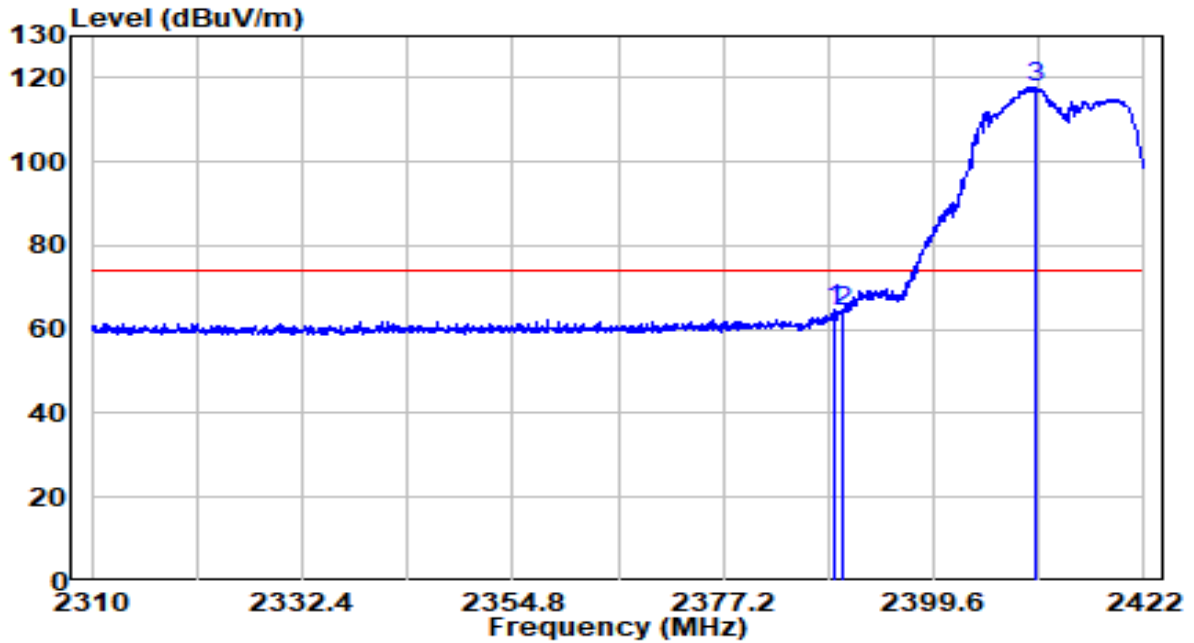

No	Frequency (MHz)	Reading (dBuV)	C.F (dB)	Measurement (dBuV/m)	Margin (dB)	Limit (dBuV/m)	Remark (QP/PK/AV)
1	2389.072	32.55	32.29	64.84	-9.16	74.00	Peak
2	2390.000	31.88	32.30	64.18	-9.82	74.00	Peak
3	* 2410.464	85.46	32.39	117.85	N/A	N/A	Peak

Note:

1. " \*", means this data is the worst emission level.
2. C.F (Correction Factor) = Antenna Factor (dB)+ Cable Loss (dB).
3. Measurement(dBuV/m) = Reading(dBuV) + C.F (Correction Factor).
4. The emission levels of other frequencies are very lower than the limit and not show in test report.

EUT	OAW-AP1301	Date of Test	2020-11-26
Factor	BBHA 9120D	Temp. / Humidity	23.7°C/42%
Polarity	Vertical	Site / Test Engineer	AC1 / Jay Chiu
Test Mode	Transmit by VHT20 at Channel 2412MHz	Test Voltage	120V/60Hz

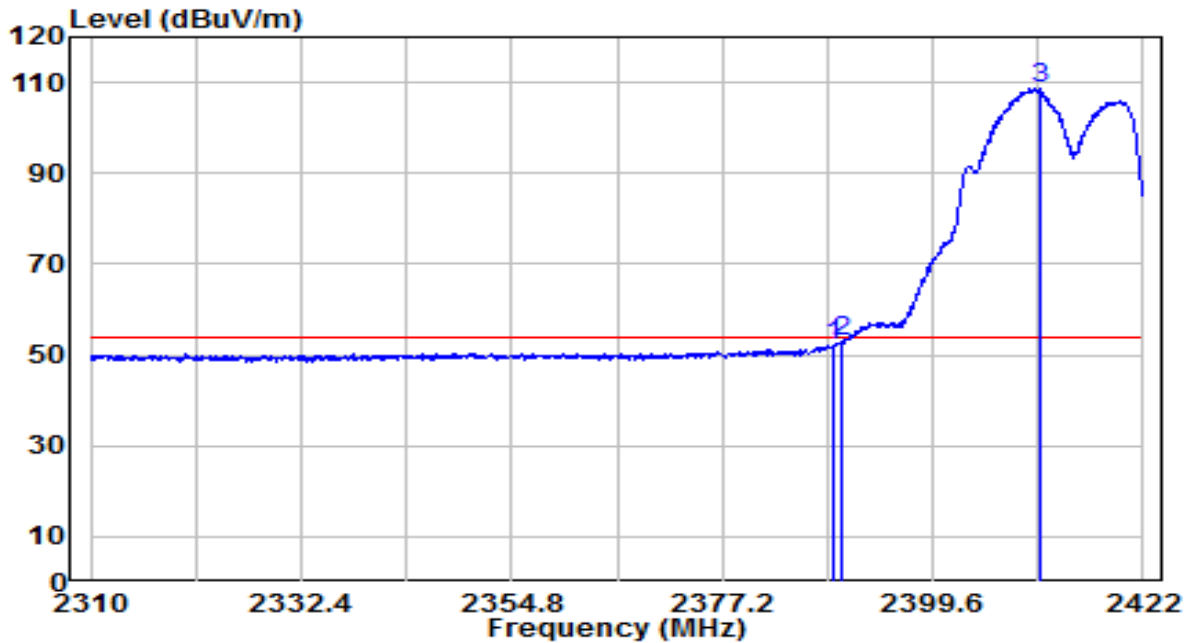

No	Frequency (MHz)	Reading (dBuV)	C.F (dB)	Measurement (dBuV/m)	Margin (dB)	Limit (dBuV/m)	Remark (QP/PK/AV)
1	2389.128	19.95	32.29	52.24	-1.76	54.00	Average
2	2390.000	20.85	32.30	53.15	-0.85	54.00	Average
3	* 2411.080	76.11	32.39	108.50	N/A	N/A	Average

Note:

1. " \*", means this data is the worst emission level.
2. C.F (Correction Factor) = Antenna Factor (dB)+ Cable Loss (dB).
3. Measurement(dBuV/m) = Reading(dBuV) + C.F (Correction Factor).
4. The emission levels of other frequencies are very lower than the limit and not show in test report.

EUT	OAW-AP1301	Date of Test	2020-12-01
Factor	BBHA 9120D	Temp. / Humidity	23.8°C/45%
Polarity	Vertical	Site / Test Engineer	AC1 / Jay Chiu
Test Mode	Transmit by VHT20 at Channel 2417MHz	Test Voltage	120V/60Hz

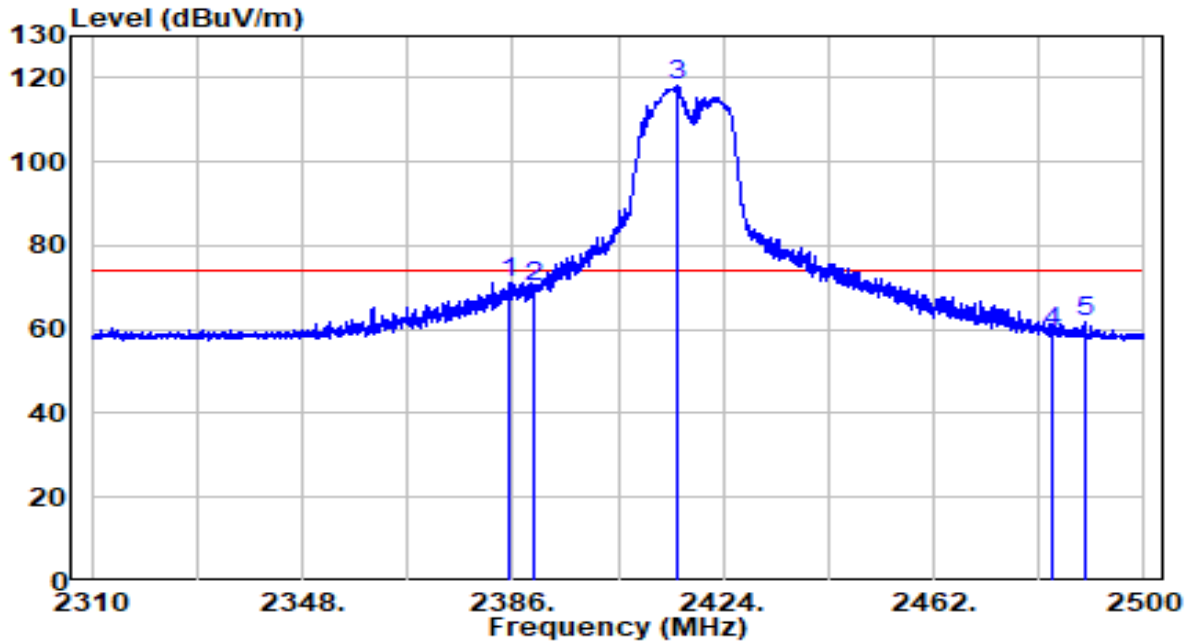

No	Frequency (MHz)	Reading (dBuV)	C.F (dB)	Measurement (dBuV/m)	Margin (dB)	Limit (dBuV/m)	Remark (QP/PK/AV)
1	2385.335	38.93	32.28	71.21	-2.79	74.00	Peak
2	2390.000	37.63	32.30	69.93	-4.07	74.00	Peak
3	* 2415.830	85.59	32.41	118.00	N/A	N/A	Peak
4	2483.500	26.60	32.71	59.31	-14.69	74.00	Peak
5	2489.455	28.91	32.73	61.65	-12.35	74.00	Peak

Note:

1. " \*", means this data is the worst emission level.
2. C.F (Correction Factor) = Antenna Factor (dB)+ Cable Loss (dB)- Preamplifier(dB).
3. Measurement(dBuV/m) = Reading(dBuV) + C.F (Correction Factor).
4. The emission levels of other frequencies are very lower than the limit and not show in test report.



EUT	OAW-AP1301	Date of Test	2020-12-01
Factor	BBHA 9120D	Temp. / Humidity	23.8°C/45%
Polarity	Vertical	Site / Test Engineer	AC1 / Jay Chiu
Test Mode	Transmit by VHT20 at Channel 2417MHz	Test Voltage	120V/60Hz

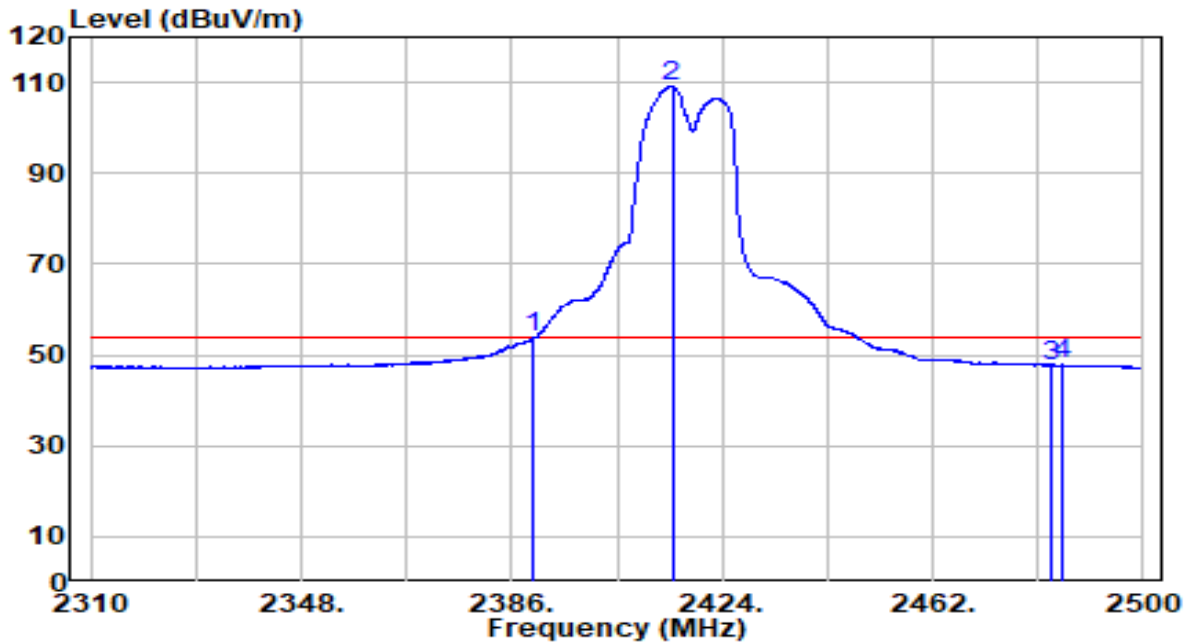

No	Frequency (MHz)	Reading (dBuV)	C.F (dB)	Measurement (dBuV/m)	Margin (dB)	Limit (dBuV/m)	Remark (QP/PK/AV)
1	2390.000	21.37	32.30	53.66	-0.34	54.00	Average
2	* 2414.975	76.67	32.41	109.08	N/A	N/A	Average
3	2483.500	15.03	32.71	47.74	-6.26	54.00	Average
4	2485.275	15.10	32.72	47.81	-6.19	54.00	Average

Note:

1. " \*", means this data is the worst emission level.
2. C.F (Correction Factor) = Antenna Factor (dB)+ Cable Loss (dB)– Preamplifier(dB).
3. Measurement(dBuV/m) = Reading(dBuV) + C.F (Correction Factor).
4. The emission levels of other frequencies are very lower than the limit and not show in test report.

EUT	OAW-AP1301	Date of Test	2020-11-26
Factor	BBHA 9120D	Temp. / Humidity	23.7°C/42%
Polarity	Horizontal	Site / Test Engineer	AC1 / Jay Chiu
Test Mode	Transmit by VHT20 at Channel 2437MHz	Test Voltage	120V/60Hz

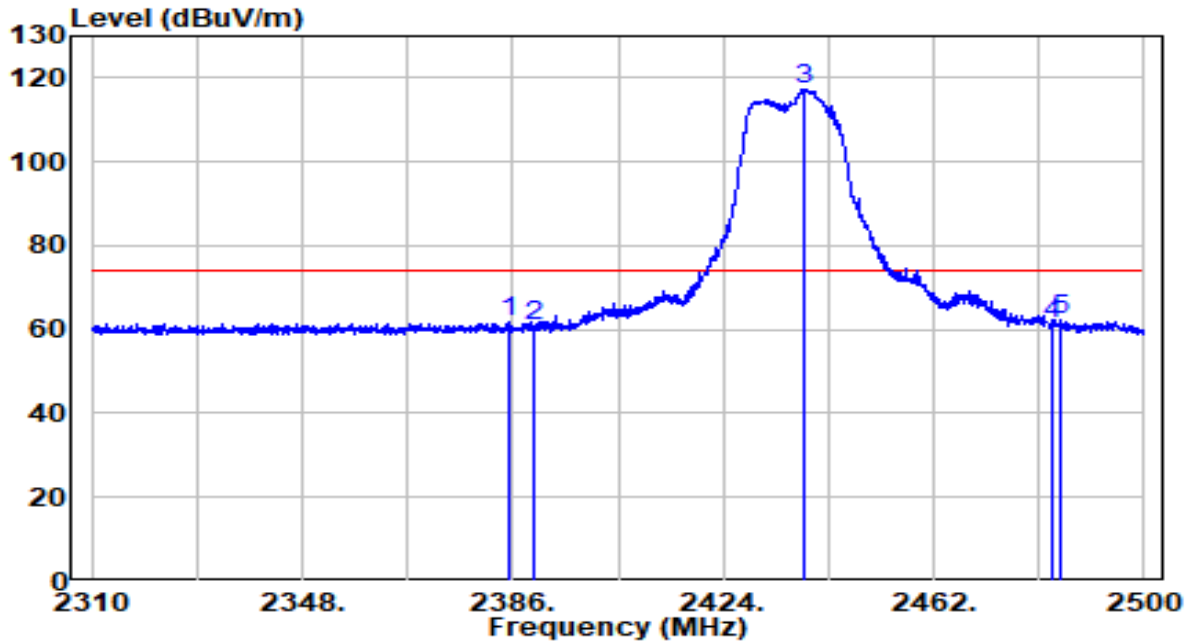

No	Frequency (MHz)	Reading (dBuV)	C.F (dB)	Measurement (dBuV/m)	Margin (dB)	Limit (dBuV/m)	Remark (QP/PK/AV)
1	2385.240	29.49	32.28	61.77	-12.23	74.00	Peak
2	2390.000	28.64	32.30	60.94	-13.06	74.00	Peak
3	* 2438.725	84.73	32.51	117.24	N/A	N/A	Peak
4	2483.500	28.59	32.71	61.30	-12.70	74.00	Peak
5	2485.085	29.75	32.71	62.47	-11.53	74.00	Peak

Note:

- "\*", means this data is the worst emission level.
- C.F (Correction Factor) = Antenna Factor (dB)+ Cable Loss (dB).
- Measurement(dBuV/m) = Reading(dBuV) + C.F (Correction Factor).
- The emission levels of other frequencies are very lower than the limit and not show in test report.

EUT	OAW-AP1301	Date of Test	2020-11-26
Factor	BBHA 9120D	Temp. / Humidity	23.7°C/42%
Polarity	Horizontal	Site / Test Engineer	AC1 / Jay Chiu
Test Mode	Transmit by VHT20 at Channel 2437MHz	Test Voltage	120V/60Hz

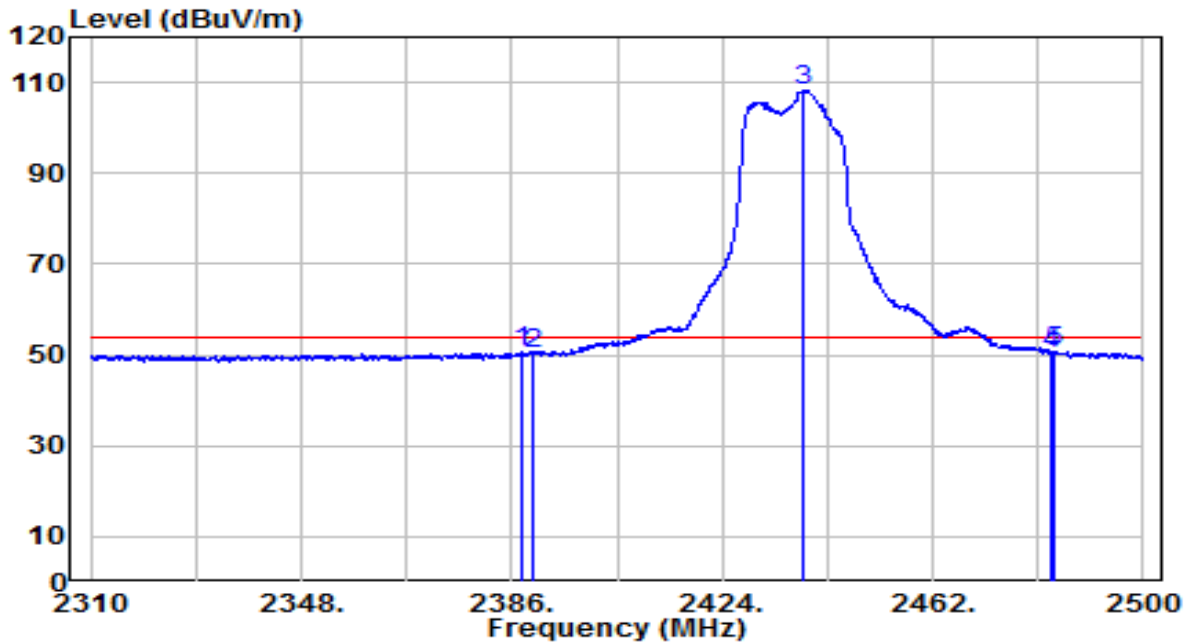

No	Frequency (MHz)	Reading (dBuV)	C.F (dB)	Measurement (dBuV/m)	Margin (dB)	Limit (dBuV/m)	Remark (QP/PK/AV)
1	2387.995	18.28	32.29	50.57	-3.43	54.00	Average
2	2390.000	17.88	32.30	50.18	-3.82	54.00	Average
3	* 2438.725	75.89	32.51	108.40	N/A	N/A	Average
4	2483.500	17.59	32.71	50.29	-3.71	54.00	Average
5	2483.850	18.12	32.71	50.83	-3.17	54.00	Average

Note:

- "\*", means this data is the worst emission level.
- C.F (Correction Factor) = Antenna Factor (dB)+ Cable Loss (dB).
- Measurement(dBuV/m) = Reading(dBuV) + C.F (Correction Factor).
- The emission levels of other frequencies are very lower than the limit and not show in test report.

EUT	OAW-AP1301	Date of Test	2020-11-26
Factor	BBHA 9120D	Temp. / Humidity	23.7°C/42%
Polarity	Vertical	Site / Test Engineer	AC1 / Jay Chiu
Test Mode	Transmit by VHT20 at Channel 2437MHz	Test Voltage	120V/60Hz

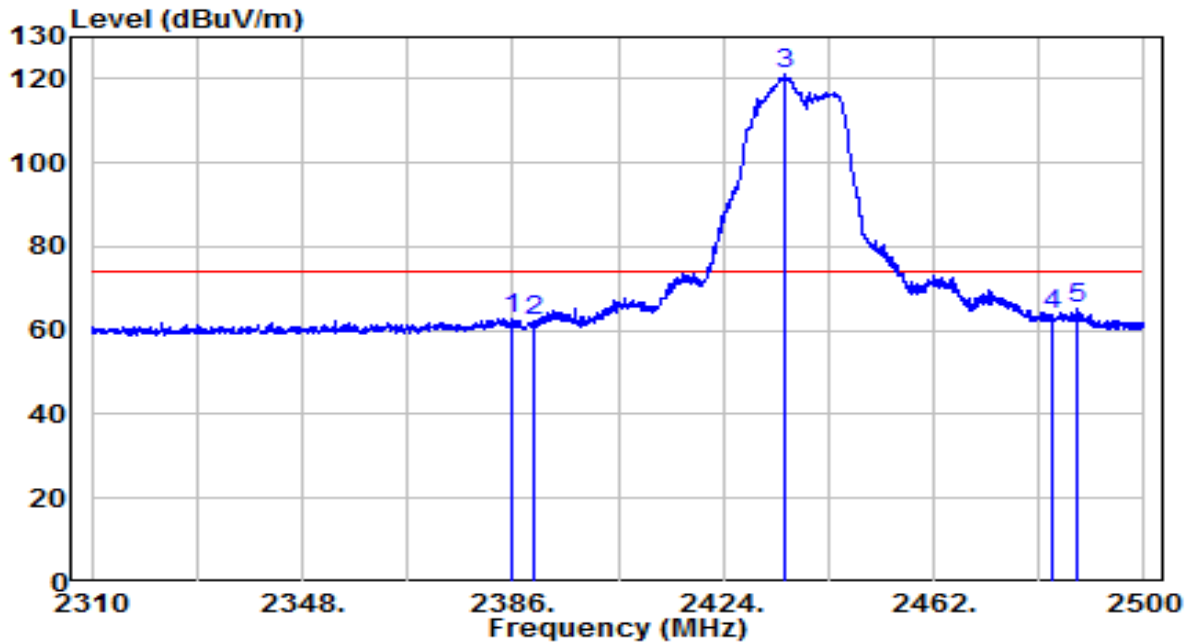

No	Frequency (MHz)	Reading (dBuV)	C.F (dB)	Measurement (dBuV/m)	Margin (dB)	Limit (dBuV/m)	Remark (QP/PK/AV)
1	2385.715	30.61	32.28	62.88	-11.12	74.00	Peak
2	2390.000	30.05	32.30	62.35	-11.65	74.00	Peak
3	* 2435.115	88.49	32.49	120.98	N/A	N/A	Peak
4	2483.500	31.04	32.71	63.75	-10.25	74.00	Peak
5	2488.030	32.35	32.73	65.08	-8.92	74.00	Peak

Note:

- "\*" means this data is the worst emission level.
- C.F (Correction Factor) = Antenna Factor (dB)+ Cable Loss (dB).
- Measurement(dBuV/m) = Reading(dBuV) + C.F (Correction Factor).
- The emission levels of other frequencies are very lower than the limit and not show in test report.

EUT	OAW-AP1301	Date of Test	2020-11-26
Factor	BBHA 9120D	Temp. / Humidity	23.7°C/42%
Polarity	Vertical	Site / Test Engineer	AC1 / Jay Chiu
Test Mode	Transmit by VHT20 at Channel 2437MHz	Test Voltage	120V/60Hz

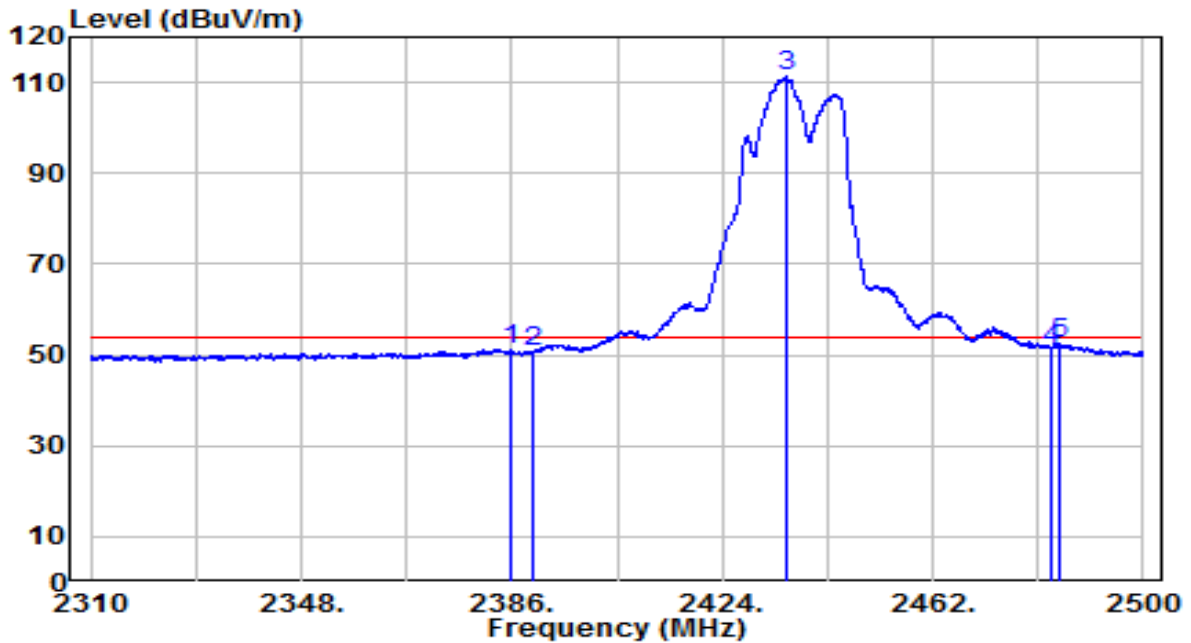

No	Frequency (MHz)	Reading (dBuV)	C.F (dB)	Measurement (dBuV/m)	Margin (dB)	Limit (dBuV/m)	Remark (QP/PK/AV)
1	2385.620	18.93	32.28	51.20	-2.80	54.00	Average
2	2390.000	18.60	32.30	50.90	-3.10	54.00	Average
3	* 2435.590	78.87	32.50	111.36	N/A	N/A	Average
4	2483.500	18.67	32.71	51.38	-2.62	54.00	Average
5	2484.705	19.90	32.71	52.61	-1.39	54.00	Average

Note:

- "\*", means this data is the worst emission level.
- C.F (Correction Factor) = Antenna Factor (dB)+ Cable Loss (dB).
- Measurement(dBuV/m) = Reading(dBuV) + C.F (Correction Factor).
- The emission levels of other frequencies are very lower than the limit and not show in test report.

EUT	OAW-AP1301	Date of Test	2020-12-01
Factor	BBHA 9120D	Temp. / Humidity	23.8°C/45%
Polarity	Vertical	Site / Test Engineer	AC1 / Jay Chiu
Test Mode	Transmit by VHT20 at Channel 2457MHz	Test Voltage	120V/60Hz

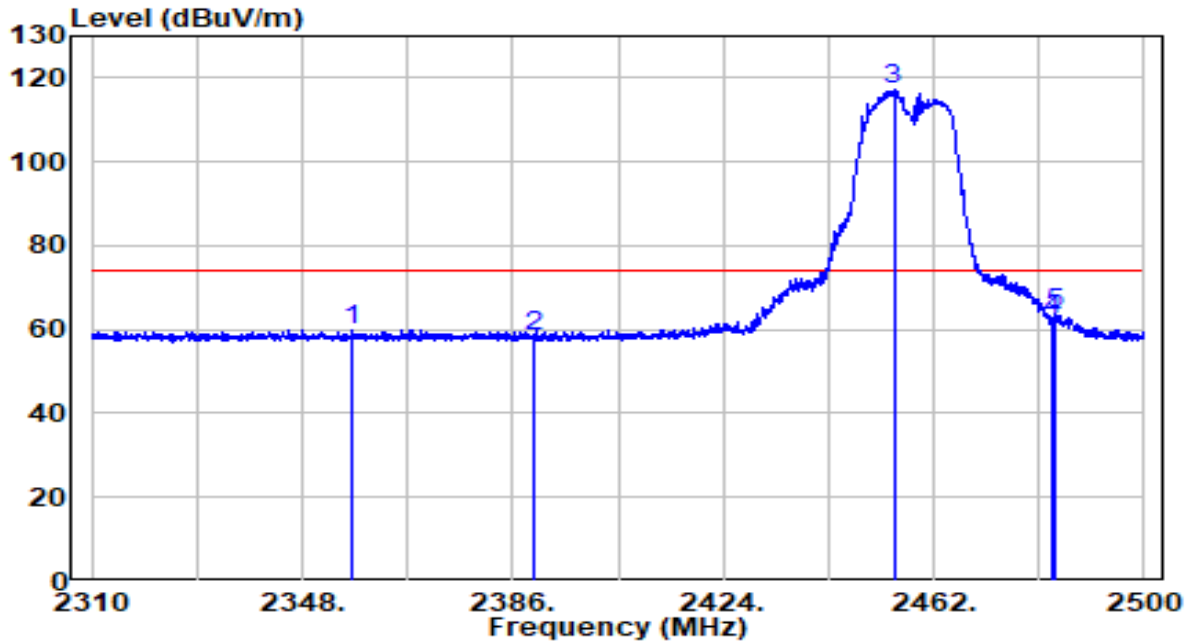

No	Frequency (MHz)	Reading (dBuV)	C.F (dB)	Measurement (dBuV/m)	Margin (dB)	Limit (dBuV/m)	Remark (QP/PK/AV)
1	2356.835	27.94	32.15	60.09	-13.91	74.00	Peak
2	2390.000	26.01	32.30	58.30	-15.70	74.00	Peak
3	* 2454.780	84.77	32.58	117.35	N/A	N/A	Peak
4	2483.500	29.43	32.71	62.14	-11.86	74.00	Peak
5	2483.755	30.98	32.71	63.69	-10.31	74.00	Peak

Note:

1. " \*", means this data is the worst emission level.
2. C.F (Correction Factor) = Antenna Factor (dB)+ Cable Loss (dB)- Preamplifier(dB).
3. Measurement(dBuV/m) = Reading(dBuV) + C.F (Correction Factor).
4. The emission levels of other frequencies are very lower than the limit and not show in test report.

EUT	OAW-AP1301	Date of Test	2020-12-01
Factor	BBHA 9120D	Temp. / Humidity	23.8°C/45%
Polarity	Vertical	Site / Test Engineer	AC1 / Jay Chiu
Test Mode	Transmit by VHT20 at Channel 2457MHz	Test Voltage	120V/60Hz

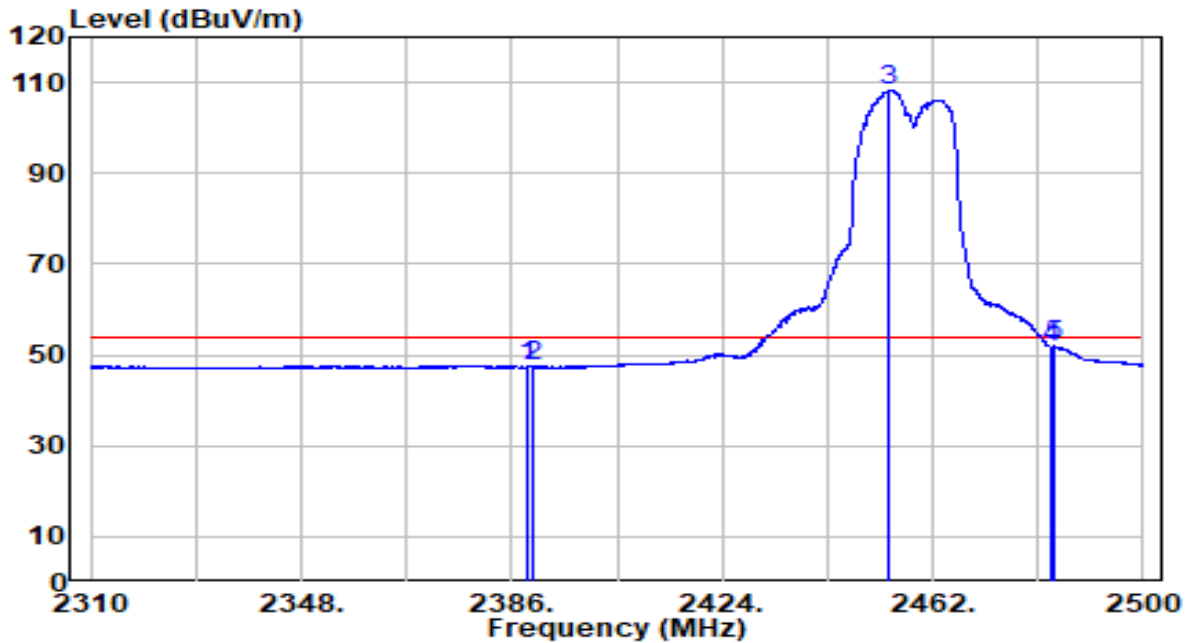

No	Frequency (MHz)	Reading (dBuV)	C.F (dB)	Measurement (dBuV/m)	Margin (dB)	Limit (dBuV/m)	Remark (QP/PK/AV)
1	2389.040	15.21	32.29	47.51	-6.49	54.00	Average
2	2390.000	15.07	32.30	47.37	-6.63	54.00	Average
3	* 2454.115	75.58	32.58	108.16	N/A	N/A	Average
4	2483.500	19.05	32.71	51.76	-2.24	54.00	Average
5	2483.755	19.30	32.71	52.01	-1.99	54.00	Average

Note:

- "\*", means this data is the worst emission level.
- C.F (Correction Factor) = Antenna Factor (dB)+ Cable Loss (dB)– Preamplifier(dB).
- Measurement(dBuV/m) = Reading(dBuV) + C.F (Correction Factor).
- The emission levels of other frequencies are very lower than the limit and not show in test report.

EUT	OAW-AP1301	Date of Test	2020-11-26
Factor	BBHA 9120D	Temp. / Humidity	23.7°C/42%
Polarity	Horizontal	Site / Test Engineer	AC1 / Jay Chiu
Test Mode	Transmit by VHT20 at Channel 2462MHz	Test Voltage	120V/60Hz

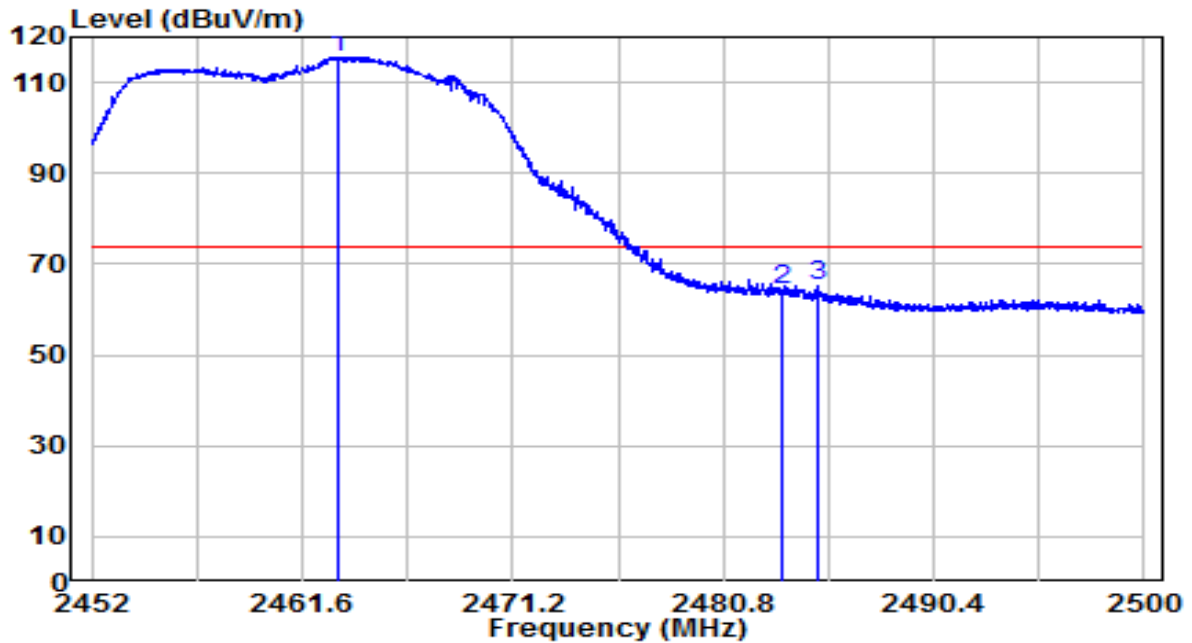

No	Frequency (MHz)	Reading (dBuV)	C.F (dB)	Measurement (dBuV/m)	Margin (dB)	Limit (dBuV/m)	Remark (QP/PK/AV)	
1	*	2463.208	83.06	32.62	115.68	N/A	N/A	Peak
2		2483.500	31.68	32.71	64.39	-9.61	74.00	Peak
3		2485.144	32.53	32.71	65.24	-8.76	74.00	Peak

Note:

1. " \*", means this data is the worst emission level.
2. C.F (Correction Factor) = Antenna Factor (dB)+ Cable Loss (dB).
3. Measurement(dBuV/m) = Reading(dBuV) + C.F (Correction Factor).
4. The emission levels of other frequencies are very lower than the limit and not show in test report.



EUT	OAW-AP1301	Date of Test	2020-11-26
Factor	BBHA 9120D	Temp. / Humidity	23.7°C/42%
Polarity	Horizontal	Site / Test Engineer	AC1 / Jay Chiu
Test Mode	Transmit by VHT20 at Channel 2462MHz	Test Voltage	120V/60Hz

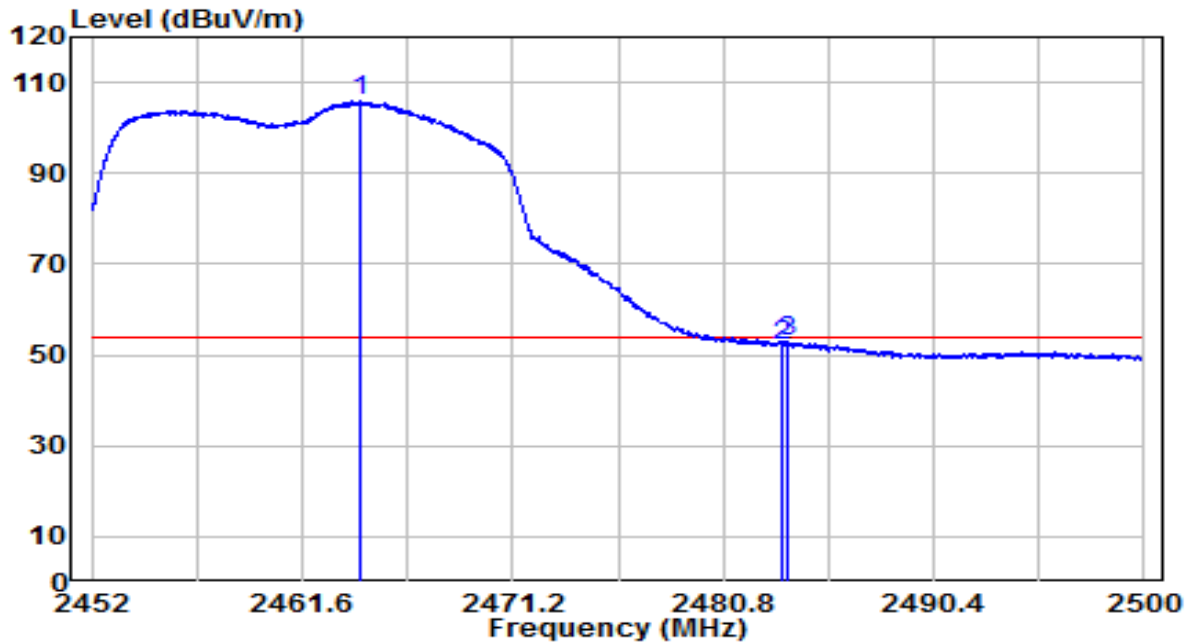

No	Frequency (MHz)	Reading (dBuV)	C.F (dB)	Measurement (dBuV/m)	Margin (dB)	Limit (dBuV/m)	Remark (QP/PK/AV)
1	* 2464.240	73.15	32.62	105.77	N/A	N/A	Average
2	2483.488	19.46	32.71	52.17	-1.83	54.00	Average
3	2483.776	20.21	32.71	52.92	-1.08	54.00	Average

Note:

1. " \*", means this data is the worst emission level.
2. C.F (Correction Factor) = Antenna Factor (dB)+ Cable Loss (dB).
3. Measurement(dBuV/m) = Reading(dBuV) + C.F (Correction Factor).
4. The emission levels of other frequencies are very lower than the limit and not show in test report.

EUT	OAW-AP1301	Date of Test	2020-11-26
Factor	BBHA 9120D	Temp. / Humidity	23.7°C/42%
Polarity	Vertical	Site / Test Engineer	AC1 / Jay Chiu
Test Mode	Transmit by VHT20 at Channel 2462MHz	Test Voltage	120V/60Hz

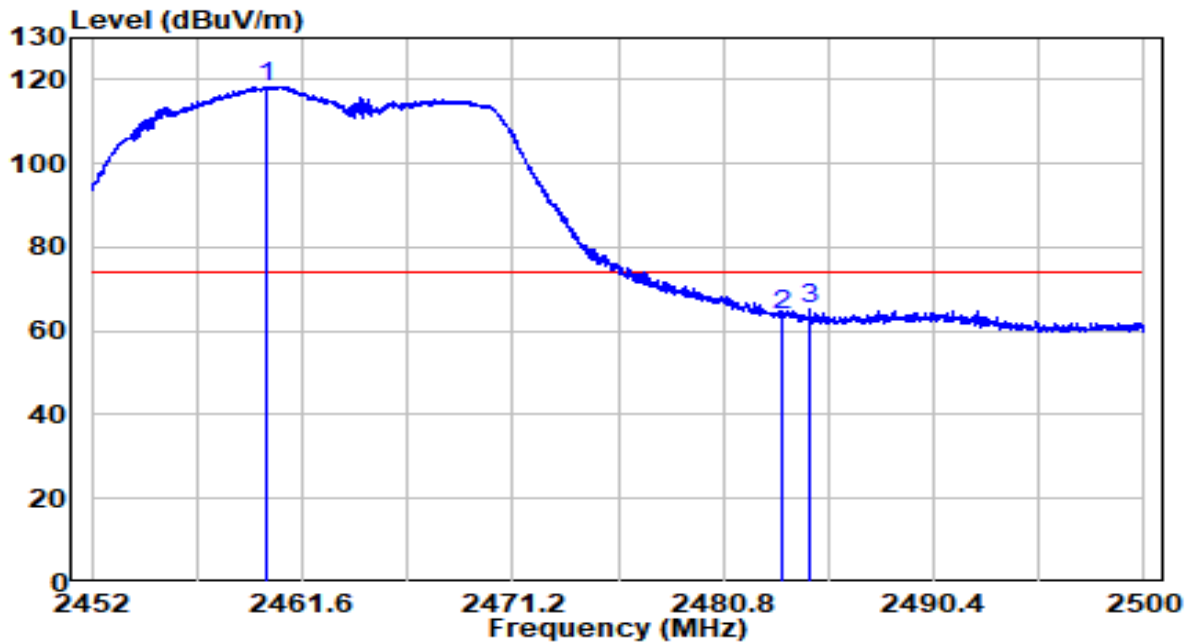

No	Frequency (MHz)	Reading (dBuV)	C.F (dB)	Measurement (dBuV/m)	Margin (dB)	Limit (dBuV/m)	Remark (QP/PK/AV)
1	* 2459.920	85.75	32.60	118.35	N/A	N/A	Peak
2	2483.500	30.93	32.71	63.64	-10.36	74.00	Peak
3	2484.712	32.36	32.71	65.07	-8.93	74.00	Peak

Note:

1. " \*", means this data is the worst emission level.
2. C.F (Correction Factor) = Antenna Factor (dB)+ Cable Loss (dB).
3. Measurement(dBuV/m) = Reading(dBuV) + C.F (Correction Factor).
4. The emission levels of other frequencies are very lower than the limit and not show in test report.

EUT	OAW-AP1301	Date of Test	2020-11-26
Factor	BBHA 9120D	Temp. / Humidity	23.7°C/42%
Polarity	Vertical	Site / Test Engineer	AC1 / Jay Chiu
Test Mode	Transmit by VHT20 at Channel 2462MHz	Test Voltage	120V/60Hz

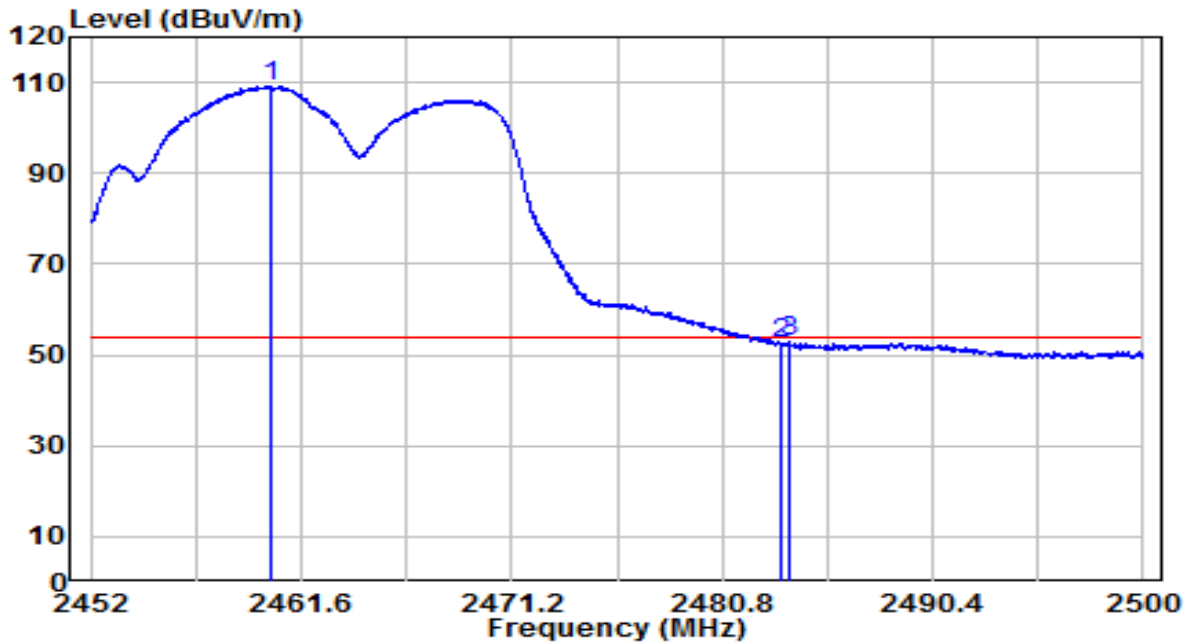

No	Frequency (MHz)	Reading (dBuV)	C.F (dB)	Measurement (dBuV/m)	Margin (dB)	Limit (dBuV/m)	Remark (QP/PK/AV)
1	* 2460.256	76.66	32.61	109.27	N/A	N/A	Average
2	2483.500	19.66	32.71	52.37	-1.63	54.00	Average
3	2483.824	20.25	32.71	52.96	-1.04	54.00	Average

Note:

1. " \*", means this data is the worst emission level.
2. C.F (Correction Factor) = Antenna Factor (dB)+ Cable Loss (dB).
3. Measurement(dBuV/m) = Reading(dBuV) + C.F (Correction Factor).
4. The emission levels of other frequencies are very lower than the limit and not show in test report.

EUT	OAW-AP1301	Date of Test	2020-11-26
Factor	BBHA 9120D	Temp. / Humidity	23.7°C/42%
Polarity	Horizontal	Site / Test Engineer	AC1 / Jay Chiu
Test Mode	Transmit by VHT40 at Channel 2422MHz	Test Voltage	120V/60Hz

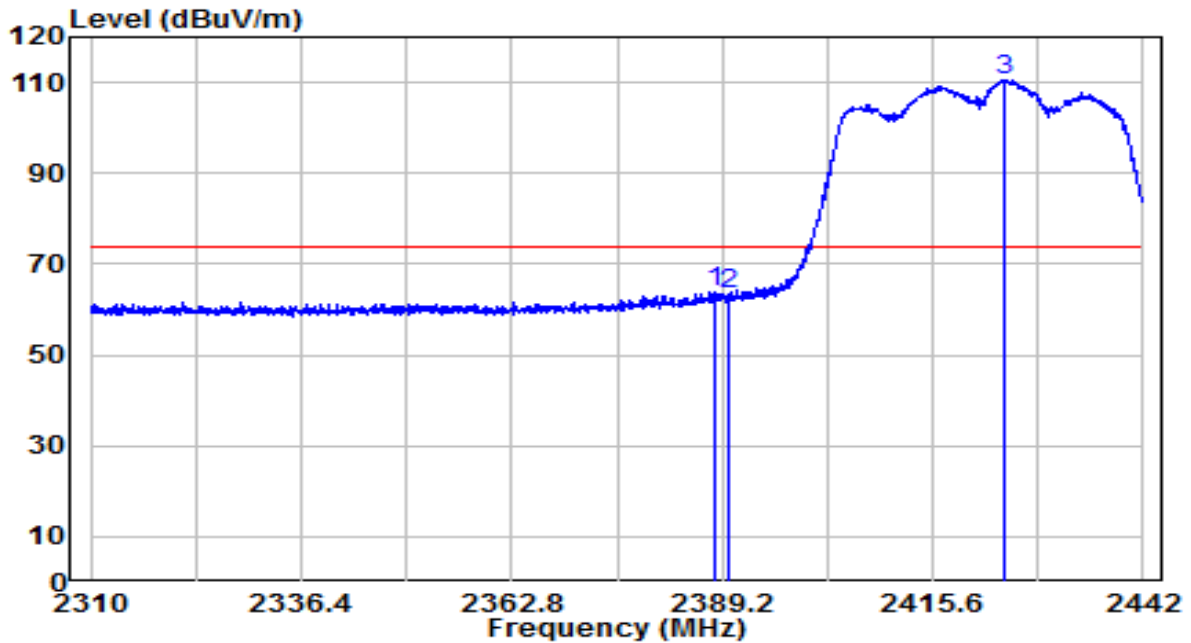

No	Frequency (MHz)	Reading (dBuV)	C.F (dB)	Measurement (dBuV/m)	Margin (dB)	Limit (dBuV/m)	Remark (QP/PK/AV)
1	2388.342	31.53	32.29	63.82	-10.18	74.00	Peak
2	2390.000	30.94	32.30	63.23	-10.77	74.00	Peak
3	* 2424.642	78.07	32.45	110.52	N/A	N/A	Peak

Note:

1. " \*", means this data is the worst emission level.
2. C.F (Correction Factor) = Antenna Factor (dB)+ Cable Loss (dB).
3. Measurement(dBuV/m) = Reading(dBuV) + C.F (Correction Factor).
4. The emission levels of other frequencies are very lower than the limit and not show in test report.

EUT	OAW-AP1301	Date of Test	2020-11-26
Factor	BBHA 9120D	Temp. / Humidity	23.7°C/42%
Polarity	Horizontal	Site / Test Engineer	AC1 / Jay Chiu
Test Mode	Transmit by VHT40 at Channel 2422MHz	Test Voltage	120V/60Hz

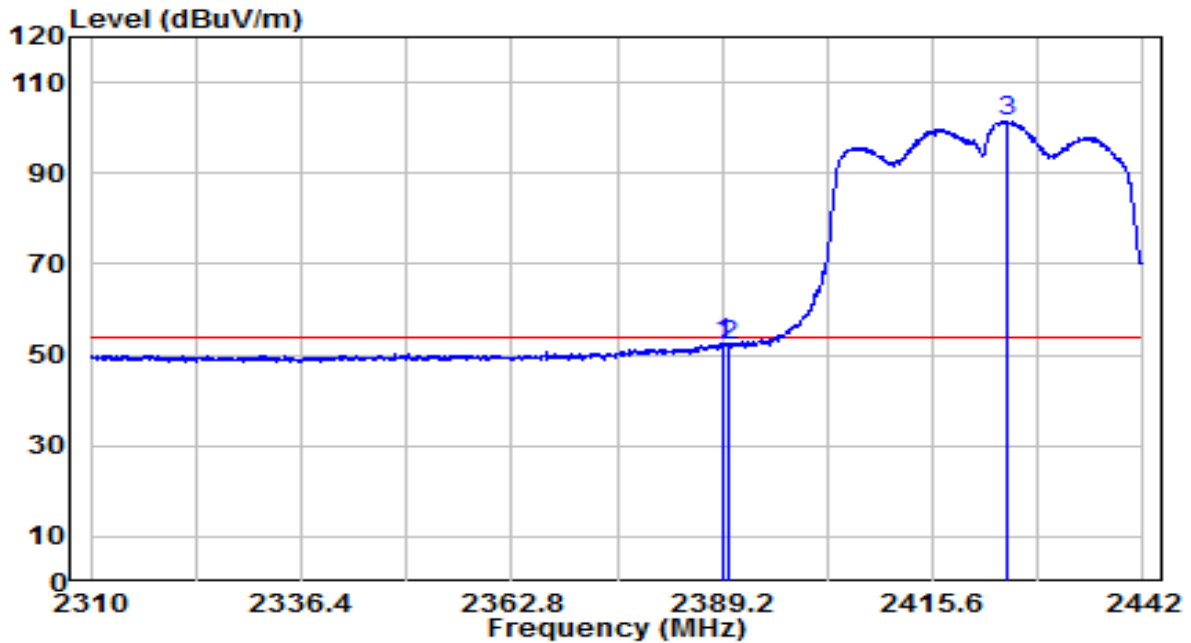

No	Frequency (MHz)	Reading (dBuV)	C.F (dB)	Measurement (dBuV/m)	Margin (dB)	Limit (dBuV/m)	Remark (QP/PK/AV)
1	2389.266	20.31	32.29	52.60	-1.40	54.00	Average
2	2390.000	19.82	32.30	52.12	-1.88	54.00	Average
3	* 2425.038	69.16	32.45	101.61	N/A	N/A	Average

Note:

1. " \*", means this data is the worst emission level.
2. C.F (Correction Factor) = Antenna Factor (dB)+ Cable Loss (dB).
3. Measurement(dBuV/m) = Reading(dBuV) + C.F (Correction Factor).
4. The emission levels of other frequencies are very lower than the limit and not show in test report.

EUT	OAW-AP1301	Date of Test	2020-11-26
Factor	BBHA 9120D	Temp. / Humidity	23.7°C/42%
Polarity	Vertical	Site / Test Engineer	AC1 / Jay Chiu
Test Mode	Transmit by VHT40 at Channel 2422MHz	Test Voltage	120V/60Hz

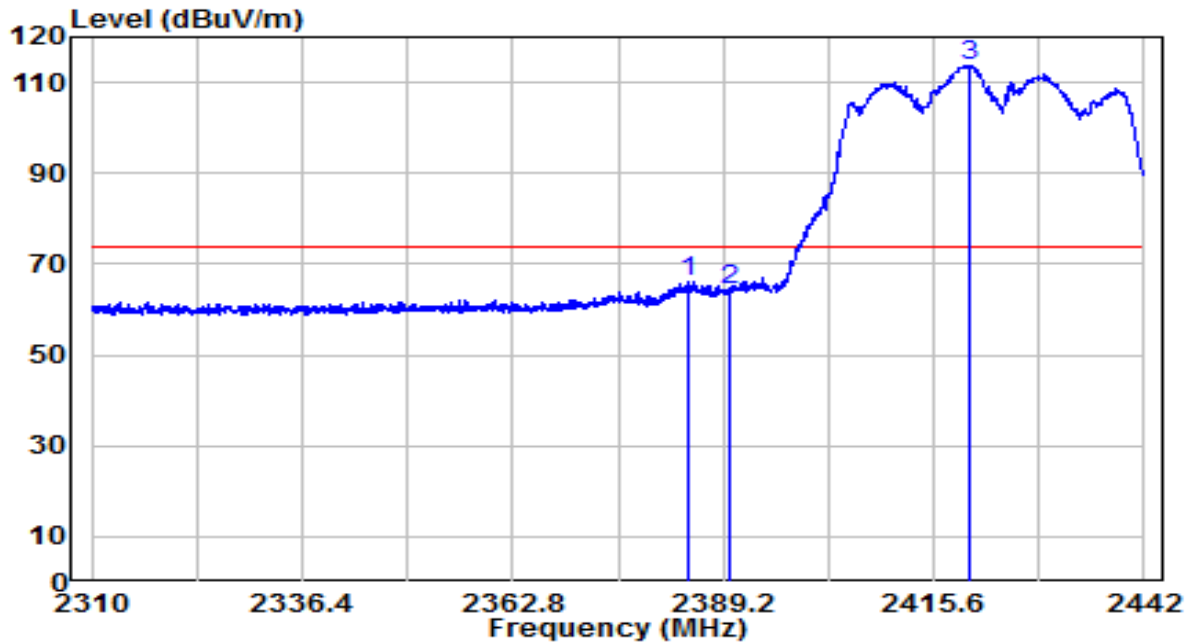

No	Frequency (MHz)	Reading (dBuV)	C.F (dB)	Measurement (dBuV/m)	Margin (dB)	Limit (dBuV/m)	Remark (QP/PK/AV)
1	2384.778	33.96	32.27	66.23	-7.77	74.00	Peak
2	2390.000	31.90	32.30	64.20	-9.80	74.00	Peak
3	* 2420.154	81.25	32.43	113.68	N/A	N/A	Peak

Note:

1. " \*", means this data is the worst emission level.
2. C.F (Correction Factor) = Antenna Factor (dB)+ Cable Loss (dB).
3. Measurement(dBuV/m) = Reading(dBuV) + C.F (Correction Factor).
4. The emission levels of other frequencies are very lower than the limit and not show in test report.

EUT	OAW-AP1301	Date of Test	2020-11-26
Factor	BBHA 9120D	Temp. / Humidity	23.7°C/42%
Polarity	Vertical	Site / Test Engineer	AC1 / Jay Chiu
Test Mode	Transmit by VHT40 at Channel 2422MHz	Test Voltage	120V/60Hz

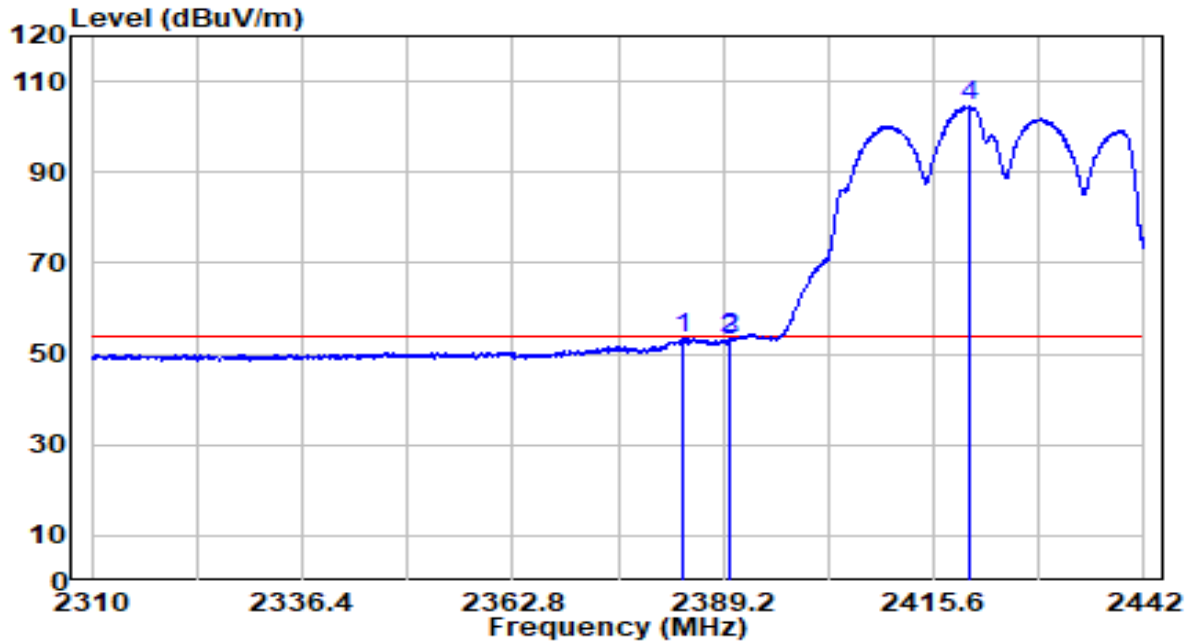

No	Frequency (MHz)	Reading (dBuV)	C.F (dB)	Measurement (dBuV/m)	Margin (dB)	Limit (dBuV/m)	Remark (QP/PK/AV)
1	2384.250	21.02	32.27	53.29	-0.71	54.00	Average
2	2389.860	21.26	32.30	53.55	-0.45	54.00	Average
3	2390.000	20.90	32.30	53.19	-0.81	54.00	Average
4	* 2420.220	72.13	32.43	104.56	N/A	N/A	Average

Note:

1. " \*", means this data is the worst emission level.
2. C.F (Correction Factor) = Antenna Factor (dB)+ Cable Loss (dB).
3. Measurement(dBuV/m) = Reading(dBuV) + C.F (Correction Factor).
4. The emission levels of other frequencies are very lower than the limit and not show in test report.

EUT	OAW-AP1301	Date of Test	2020-12-18
Factor	BBHA 9120D	Temp. / Humidity	21.2°C/23%
Polarity	Vertical	Site / Test Engineer	AC1 / Jay Chiu
Test Mode	Transmit by VHT40 at Channel 2427MHz	Test Voltage	120V/60Hz

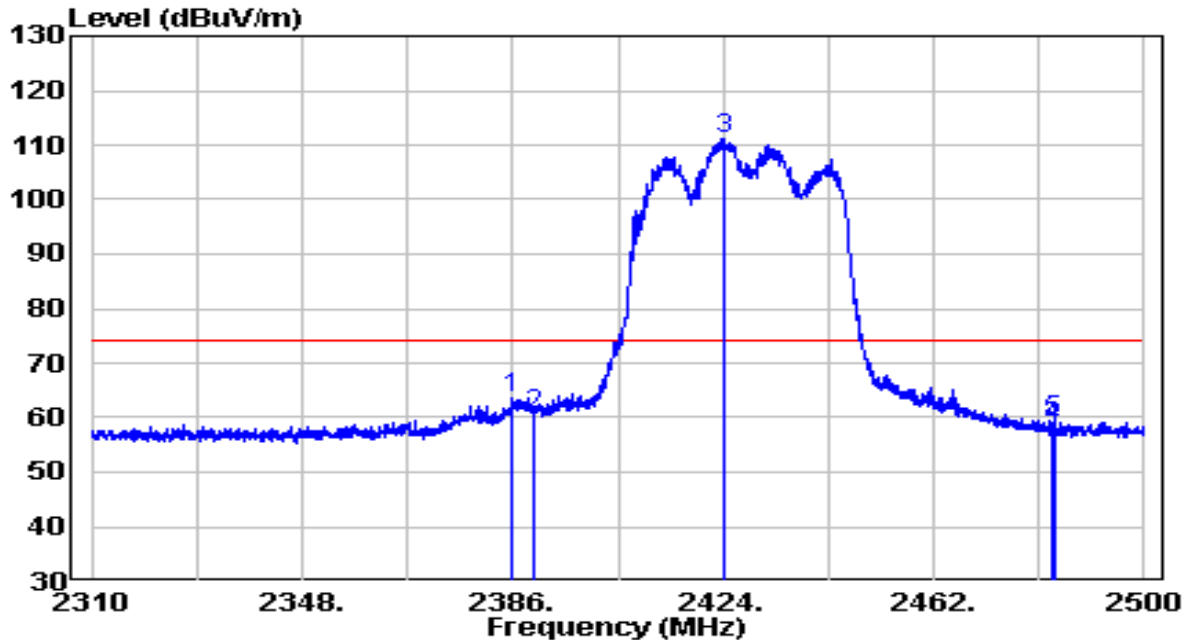

No	Frequency (MHz)	Reading (dBUV)	C.F (dB)	Measurement (dBUV/m)	Margin (dB)	Limit (dBUV/m)	Remark (QP/PK/AV)
1	2385.810	31.22	32.28	63.50	-10.50	74.00	Peak
2	2390.000	28.45	32.30	60.75	-13.25	74.00	Peak
3	* 2424.095	78.76	32.45	111.21	N/A	N/A	Peak
4	2483.500	25.51	32.71	58.22	-15.78	74.00	Peak
5	2483.660	26.66	32.71	59.37	-14.63	74.00	Peak

Note:

1. " \*", means this data is the worst emission level.
2. C.F (Correction Factor) = Antenna Factor (dB)+ Cable Loss (dB).
3. Measurement(dBUV/m) = Reading(dBUV) + C.F (Correction Factor).
4. The emission levels of other frequencies are very lower than the limit and not show in test report.



EUT	OAW-AP1301	Date of Test	2020-12-18
Factor	BBHA 9120D	Temp. / Humidity	21.2°C/23%
Polarity	Vertical	Site / Test Engineer	AC1 / Jay Chiu
Test Mode	Transmit by VHT40 at Channel 2427MHz	Test Voltage	120V/60Hz

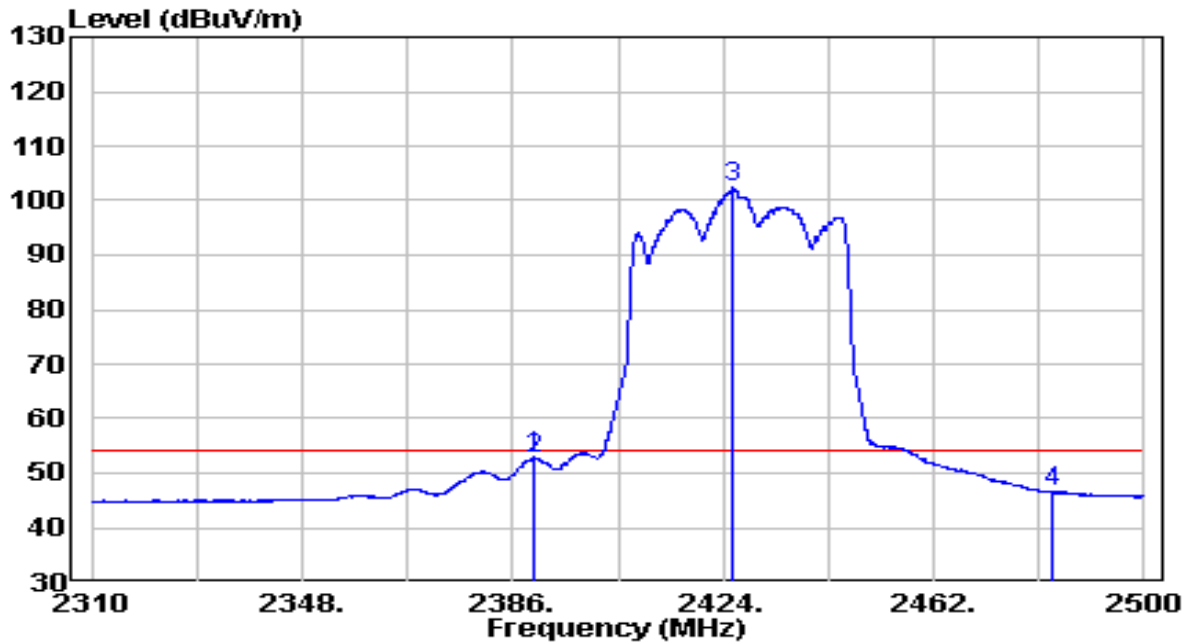

No	Frequency (MHz)	Reading (dBuV)	C.F (dB)	Measurement (dBuV/m)	Margin (dB)	Limit (dBuV/m)	Remark (QP/PK/AV)
1	2389.705	20.54	32.29	52.83	-1.17	54.00	Average
2	2390.000	20.40	32.30	52.70	-1.30	54.00	Average
3	* 2425.900	69.81	32.45	102.26	N/A	N/A	Average
4	2483.500	13.79	32.71	46.50	-7.50	54.00	Average

Note:

- "\*", means this data is the worst emission level.
- C.F (Correction Factor) = Antenna Factor (dB)+ Cable Loss (dB).
- Measurement(dBuV/m) = Reading(dBuV) + C.F (Correction Factor).
- The emission levels of other frequencies are very lower than the limit and not show in test report.

EUT	OAW-AP1301	Date of Test	2020-11-26
Factor	BBHA 9120D	Temp. / Humidity	23.7°C/42%
Polarity	Horizontal	Site / Test Engineer	AC1 / Jay Chiu
Test Mode	Transmit by VHT40 at Channel 2437MHz	Test Voltage	120V/60Hz

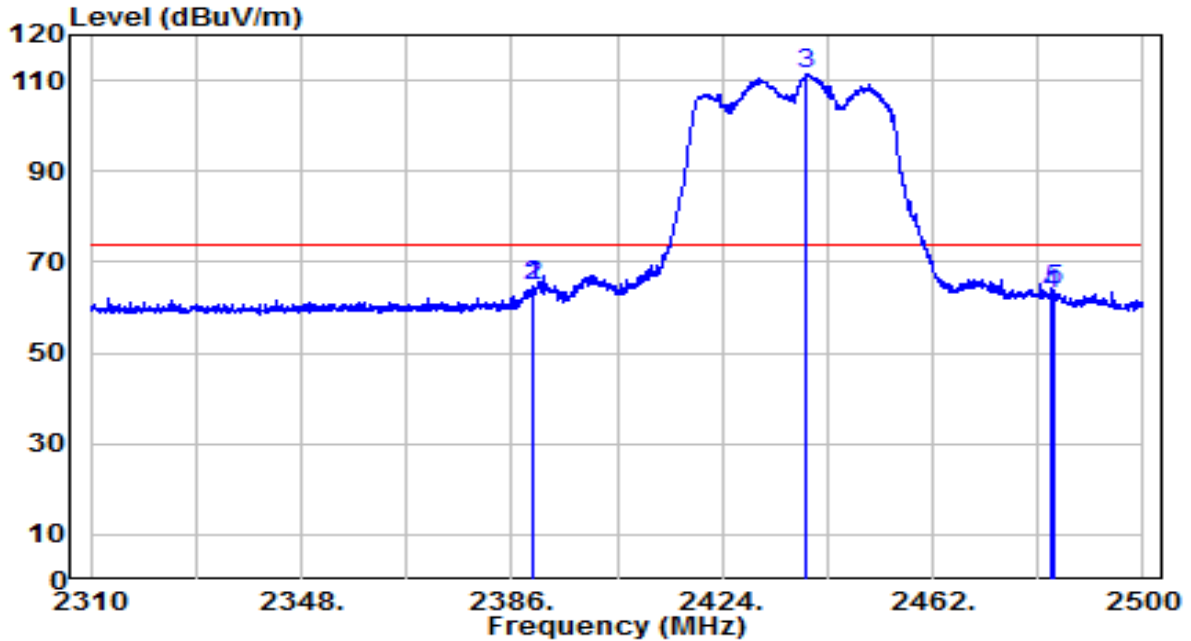

No	Frequency (MHz)	Reading (dBuV)	C.F (dB)	Measurement (dBuV/m)	Margin (dB)	Limit (dBuV/m)	Remark (QP/PK/AV)
1	2389.990	32.35	32.30	64.65	-9.35	74.00	Peak
2	2390.000	32.35	32.30	64.65	-9.35	74.00	Peak
3	* 2439.295	79.01	32.51	111.52	N/A	N/A	Peak
4	2483.500	30.26	32.71	62.96	-11.04	74.00	Peak
5	2483.755	31.05	32.71	63.76	-10.24	74.00	Peak

Note:

- "\*" means this data is the worst emission level.
- C.F (Correction Factor) = Antenna Factor (dB)+ Cable Loss (dB).
- Measurement(dBuV/m) = Reading(dBuV) + C.F (Correction Factor).
- The emission levels of other frequencies are very lower than the limit and not show in test report.

EUT	OAW-AP1301	Date of Test	2020-11-26
Factor	BBHA 9120D	Temp. / Humidity	23.7°C/42%
Polarity	Horizontal	Site / Test Engineer	AC1 / Jay Chiu
Test Mode	Transmit by VHT40 at Channel 2437MHz	Test Voltage	120V/60Hz

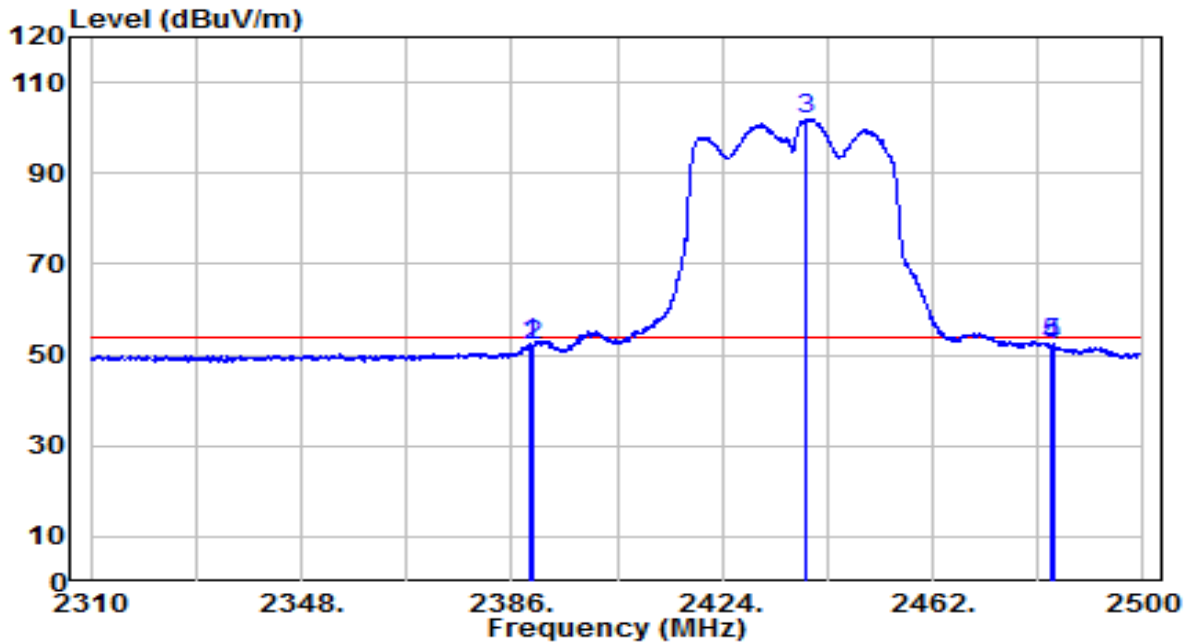

No	Frequency (MHz)	Reading (dBuV)	C.F (dB)	Measurement (dBuV/m)	Margin (dB)	Limit (dBuV/m)	Remark (QP/PK/AV)
1	2389.420	20.11	32.29	52.41	-1.59	54.00	Average
2	2390.000	19.78	32.30	52.07	-1.93	54.00	Average
3	* 2439.200	69.55	32.51	102.06	N/A	N/A	Average
4	2483.500	19.55	32.71	52.26	-1.74	54.00	Average
5	2483.660	19.63	32.71	52.34	-1.66	54.00	Average

Note:

- "\*", means this data is the worst emission level.
- C.F (Correction Factor) = Antenna Factor (dB)+ Cable Loss (dB).
- Measurement(dBuV/m) = Reading(dBuV) + C.F (Correction Factor).
- The emission levels of other frequencies are very lower than the limit and not show in test report.

EUT	OAW-AP1301	Date of Test	2020-11-26
Factor	BBHA 9120D	Temp. / Humidity	23.7°C/42%
Polarity	Vertical	Site / Test Engineer	AC1 / Jay Chiu
Test Mode	Transmit by VHT40 at Channel 2437MHz	Test Voltage	120V/60Hz

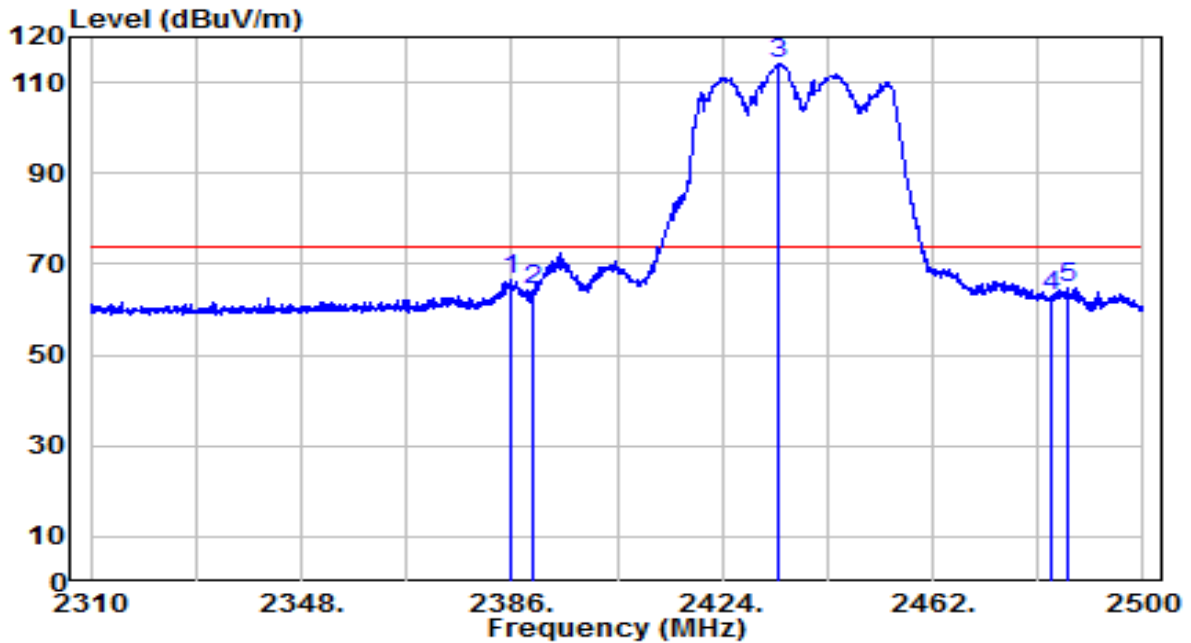

No	Frequency (MHz)	Reading (dBuV)	C.F (dB)	Measurement (dBuV/m)	Margin (dB)	Limit (dBuV/m)	Remark (QP/PK/AV)
1	2385.810	34.39	32.28	66.66	-7.34	74.00	Peak
2	2390.000	31.82	32.30	64.11	-9.89	74.00	Peak
3	* 2434.355	81.59	32.49	114.08	N/A	N/A	Peak
4	2483.500	30.20	32.71	62.90	-11.10	74.00	Peak
5	2486.415	32.05	32.72	64.77	-9.23	74.00	Peak

Note:

1. " \*", means this data is the worst emission level.
2. C.F (Correction Factor) = Antenna Factor (dB)+ Cable Loss (dB).
3. Measurement(dBuV/m) = Reading(dBuV) + C.F (Correction Factor).
4. The emission levels of other frequencies are very lower than the limit and not show in test report.

EUT	OAW-AP1301	Date of Test	2020-11-26
Factor	BBHA 9120D	Temp. / Humidity	23.7°C/42%
Polarity	Vertical	Site / Test Engineer	AC1 / Jay Chiu
Test Mode	Transmit by VHT40 at Channel 2437MHz	Test Voltage	120V/60Hz

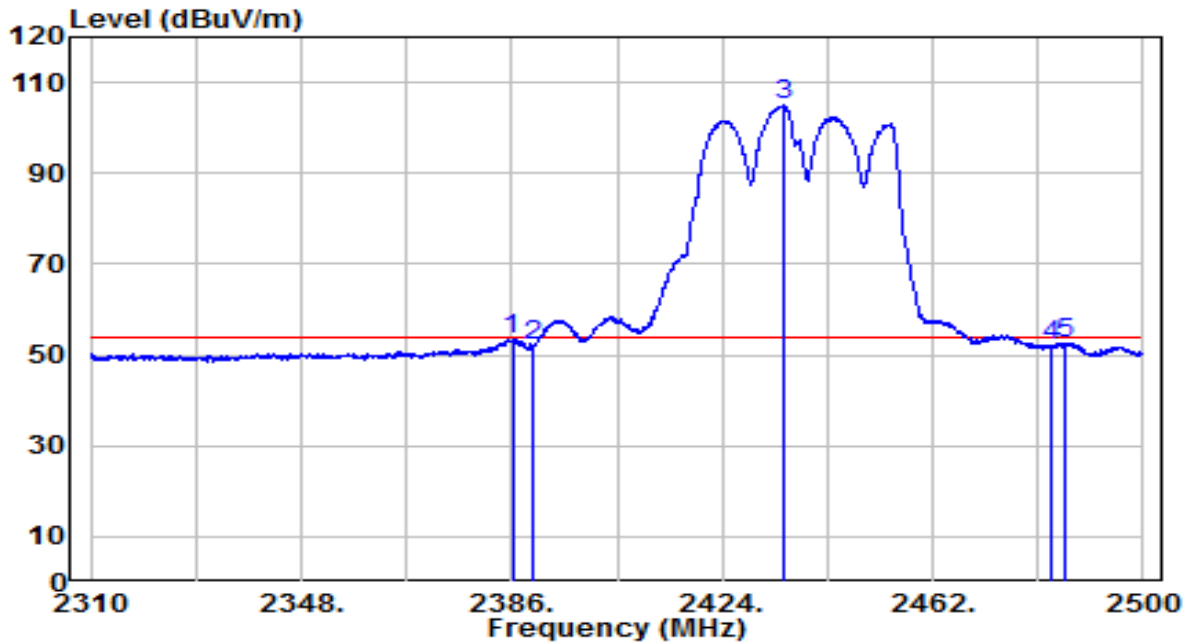

No	Frequency (MHz)	Reading (dBuV)	C.F (dB)	Measurement (dBuV/m)	Margin (dB)	Limit (dBuV/m)	Remark (QP/PK/AV)
1	2386.095	21.34	32.28	53.62	-0.38	54.00	Average
2	2390.000	19.56	32.30	51.86	-2.14	54.00	Average
3	* 2434.925	72.35	32.49	104.84	N/A	N/A	Average
4	2483.500	19.25	32.71	51.96	-2.04	54.00	Average
5	2486.035	20.03	32.72	52.74	-1.26	54.00	Average

Note:

- "\*", means this data is the worst emission level.
- C.F (Correction Factor) = Antenna Factor (dB)+ Cable Loss (dB).
- Measurement(dBuV/m) = Reading(dBuV) + C.F (Correction Factor).
- The emission levels of other frequencies are very lower than the limit and not show in test report.

EUT	OAW-AP1301	Date of Test	2020-12-18
Factor	BBHA 9120D	Temp. / Humidity	21.2°C/23%
Polarity	Vertical	Site / Test Engineer	AC1 / Jay Chiu
Test Mode	Transmit by VHT40 at Channel 2447MHz	Test Voltage	120V/60Hz

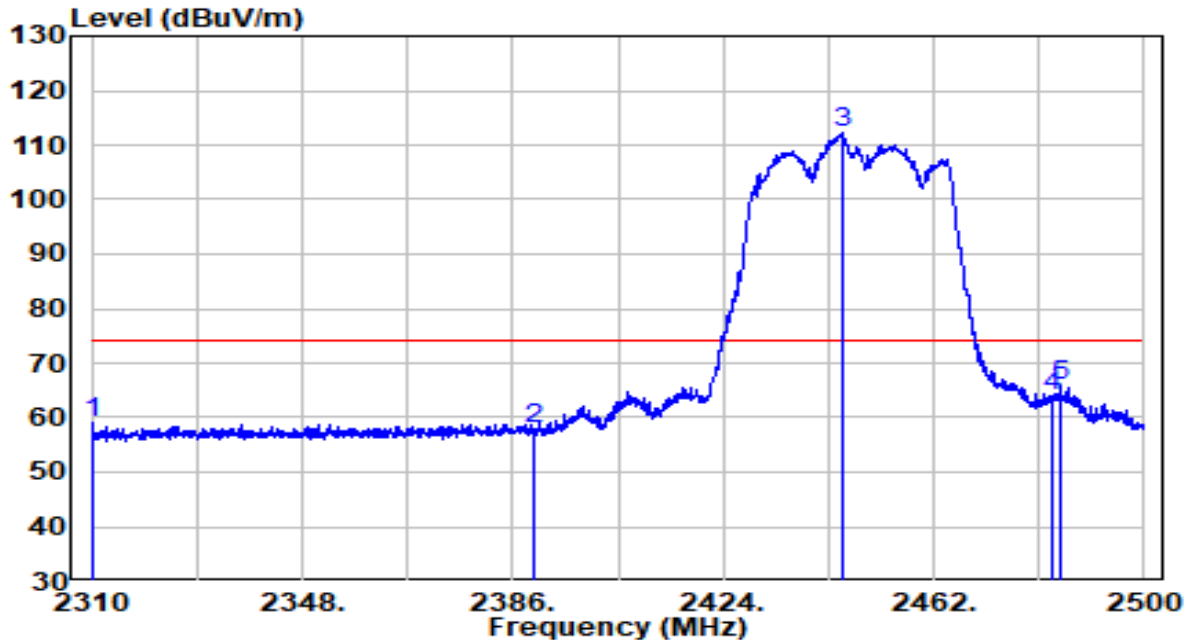

No	Frequency (MHz)	Reading (dBuV)	C.F (dB)	Measurement (dBuV/m)	Margin (dB)	Limit (dBuV/m)	Remark (QP/PK/AV)
1	2310.380	27.09	31.95	59.03	-14.97	74.00	Peak
2	2390.000	25.56	32.30	57.86	-16.14	74.00	Peak
3	* 2445.470	79.78	32.54	112.32	N/A	N/A	Peak
4	2483.500	31.42	32.71	64.13	-9.87	74.00	Peak
5	2484.990	33.27	32.71	65.99	-8.01	74.00	Peak

Note:

1. " \*", means this data is the worst emission level.
2. C.F (Correction Factor) = Antenna Factor (dB)+ Cable Loss (dB).
3. Measurement(dBuV/m) = Reading(dBuV) + C.F (Correction Factor).
4. The emission levels of other frequencies are very lower than the limit and not show in test report.

EUT	OAW-AP1301	Date of Test	2020-12-18
Factor	BBHA 9120D	Temp. / Humidity	21.2°C/23%
Polarity	Vertical	Site / Test Engineer	AC1 / Jay Chiu
Test Mode	Transmit by VHT40 at Channel 2447MHz	Test Voltage	120V/60Hz

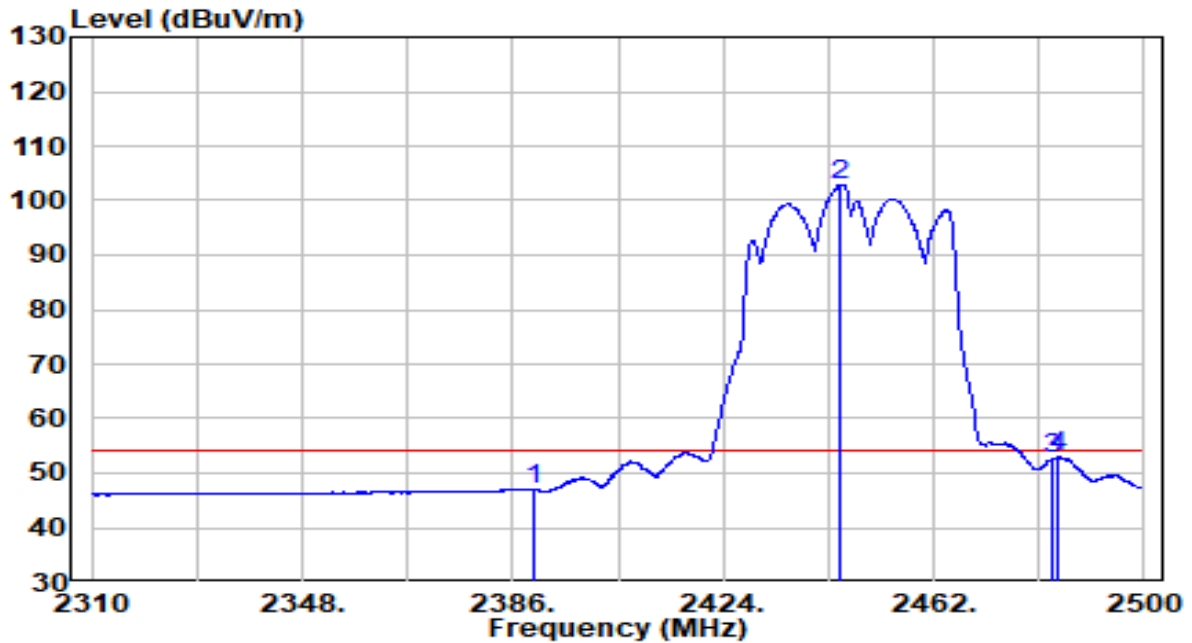

No	Frequency (MHz)	Reading (dBuV)	C.F (dB)	Measurement (dBuV/m)	Margin (dB)	Limit (dBuV/m)	Remark (QP/PK/AV)
1	2390.000	14.60	32.30	46.89	-7.11	54.00	Average
2	* 2445.280	70.42	32.54	102.96	N/A	N/A	Average
3	2483.500	19.76	32.71	52.47	-1.53	54.00	Average
4	2484.420	20.18	32.71	52.89	-1.11	54.00	Average

Note:

1. " \*", means this data is the worst emission level.
2. C.F (Correction Factor) = Antenna Factor (dB)+ Cable Loss (dB).
3. Measurement(dBuV/m) = Reading(dBuV) + C.F (Correction Factor).
4. The emission levels of other frequencies are very lower than the limit and not show in test report.

EUT	OAW-AP1301	Date of Test	2020-11-26
Factor	BBHA 9120D	Temp. / Humidity	23.7°C/42%
Polarity	Horizontal	Site / Test Engineer	AC1 / Jay Chiu
Test Mode	Transmit by VHT40 at Channel 2452MHz	Test Voltage	120V/60Hz

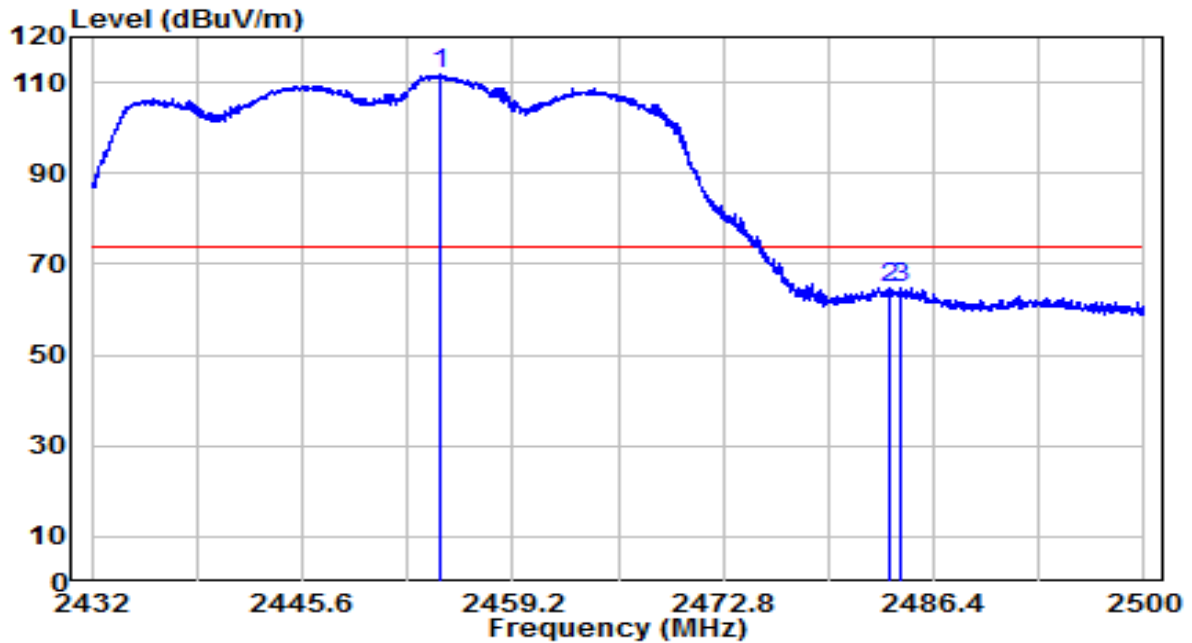

No	Frequency (MHz)	Reading (dBuV)	C.F (dB)	Measurement (dBuV/m)	Margin (dB)	Limit (dBuV/m)	Remark (QP/PK/AV)
1	* 2454.576	79.08	32.58	111.66	N/A	N/A	Peak
2	2483.500	31.94	32.71	64.65	-9.35	74.00	Peak
3	2484.292	32.14	32.71	64.85	-9.15	74.00	Peak

Note:

1. " \*", means this data is the worst emission level.
2. C.F (Correction Factor) = Antenna Factor (dB)+ Cable Loss (dB).
3. Measurement(dBuV/m) = Reading(dBuV) + C.F (Correction Factor).
4. The emission levels of other frequencies are very lower than the limit and not show in test report.



EUT	OAW-AP1301	Date of Test	2020-11-26
Factor	BBHA 9120D	Temp. / Humidity	23.7°C/42%
Polarity	Horizontal	Site / Test Engineer	AC1 / Jay Chiu
Test Mode	Transmit by VHT40 at Channel 2452MHz	Test Voltage	120V/60Hz

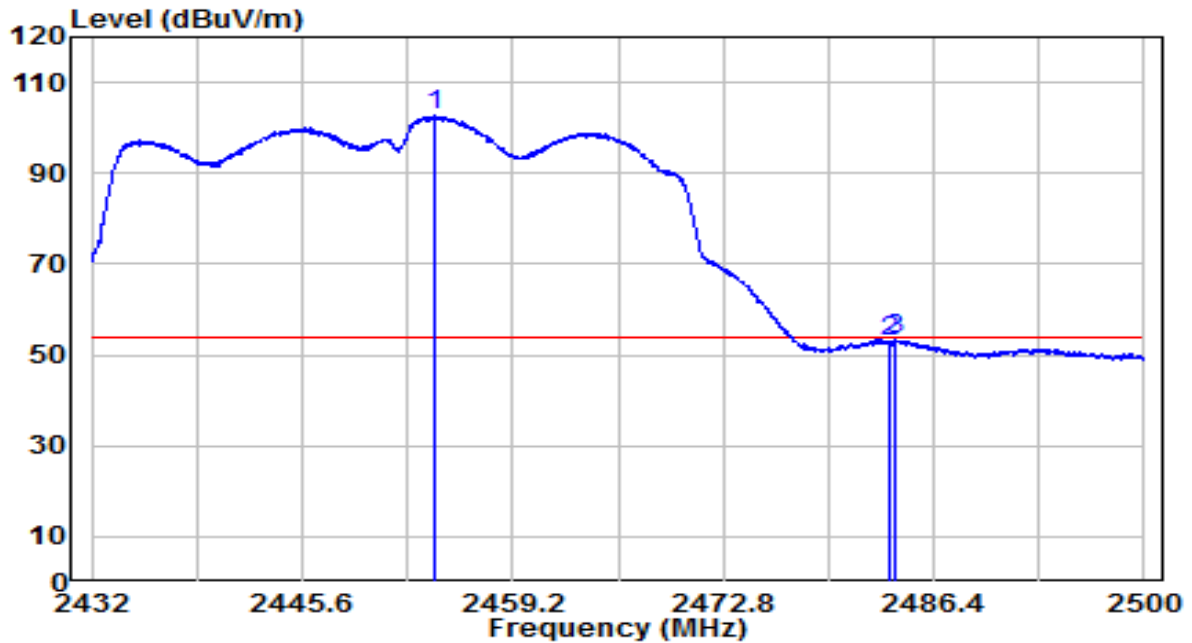

No	Frequency (MHz)	Reading (dBuV)	C.F (dB)	Measurement (dBuV/m)	Margin (dB)	Limit (dBuV/m)	Remark (QP/PK/AV)
1	* 2454.202	70.00	32.58	102.58	N/A	N/A	Average
2	2483.500	20.08	32.71	52.79	-1.21	54.00	Average
3	2483.918	20.61	32.71	53.32	-0.68	54.00	Average

Note:

1. " \*", means this data is the worst emission level.
2. C.F (Correction Factor) = Antenna Factor (dB)+ Cable Loss (dB).
3. Measurement(dBuV/m) = Reading(dBuV) + C.F (Correction Factor).
4. The emission levels of other frequencies are very lower than the limit and not show in test report.

EUT	OAW-AP1301	Date of Test	2020-11-26
Factor	BBHA 9120D	Temp. / Humidity	23.7°C/42%
Polarity	Vertical	Site / Test Engineer	AC1 / Jay Chiu
Test Mode	Transmit by VHT40 at Channel 2452MHz	Test Voltage	120V/60Hz

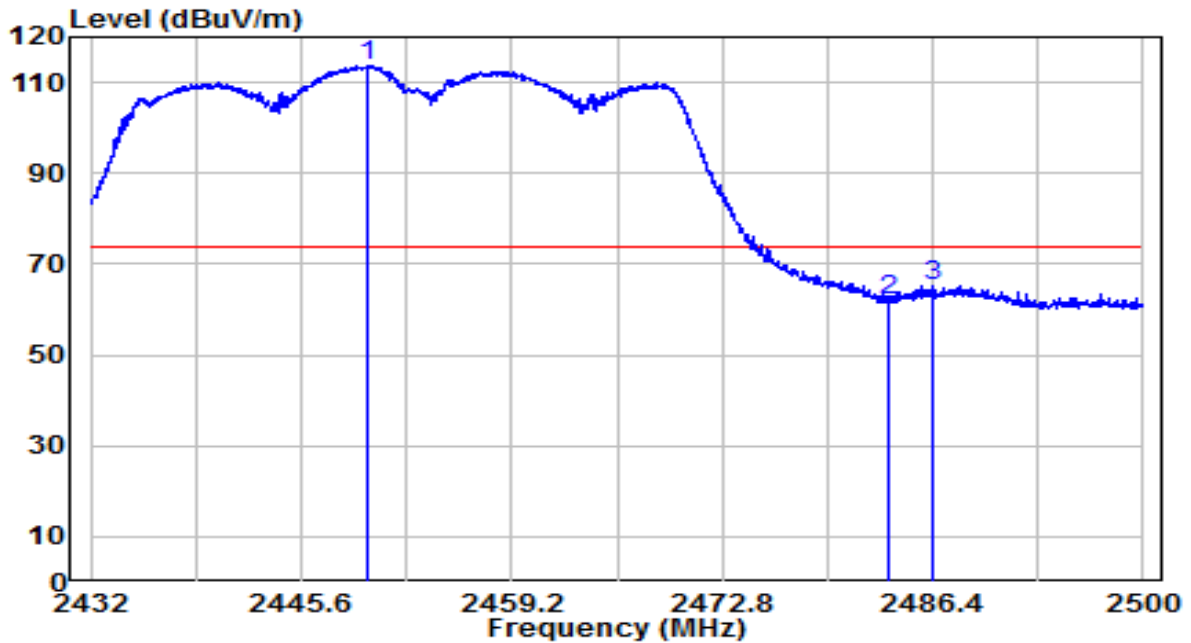

No	Frequency (MHz)	Reading (dBuV)	C.F (dB)	Measurement (dBuV/m)	Margin (dB)	Limit (dBuV/m)	Remark (QP/PK/AV)
1	* 2449.850	81.26	32.56	113.82	N/A	N/A	Peak
2	2483.500	29.51	32.71	62.22	-11.78	74.00	Peak
3	2486.332	32.67	32.72	65.39	-8.61	74.00	Peak

Note:

1. " \*", means this data is the worst emission level.
2. C.F (Correction Factor) = Antenna Factor (dB)+ Cable Loss (dB).
3. Measurement(dBuV/m) = Reading(dBuV) + C.F (Correction Factor).
- 4.The emission levels of other frequencies are very lower than the limit and not show in test report.

EUT	OAW-AP1301	Date of Test	2020-11-26
Factor	BBHA 9120D	Temp. / Humidity	23.7°C/42%
Polarity	Vertical	Site / Test Engineer	AC1 / Jay Chiu
Test Mode	Transmit by VHT40 at Channel 2452MHz	Test Voltage	120V/60Hz

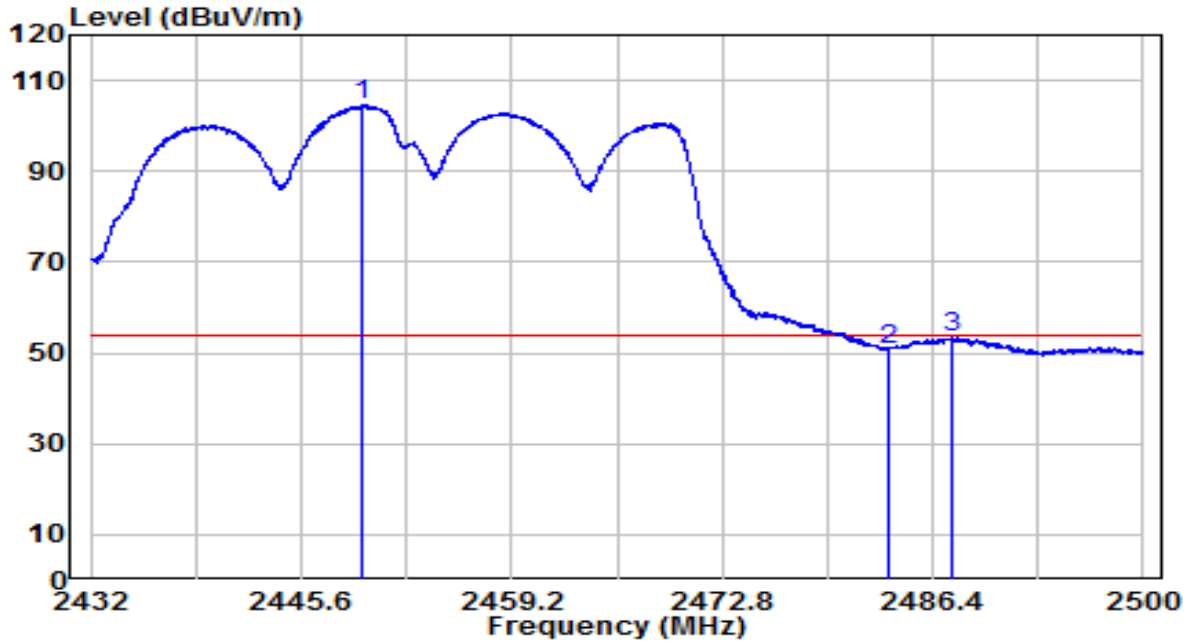

No	Frequency (MHz)	Reading (dBuV)	C.F (dB)	Measurement (dBuV/m)	Margin (dB)	Limit (dBuV/m)	Remark (QP/PK/AV)
1	* 2449.544	71.97	32.56	104.53	N/A	N/A	Average
2	2483.500	18.23	32.71	50.94	-3.06	54.00	Average
3	2487.692	20.66	32.73	53.38	-0.62	54.00	Average

Note:

1. " \*", means this data is the worst emission level.
2. C.F (Correction Factor) = Antenna Factor (dB)+ Cable Loss (dB).
3. Measurement(dBuV/m) = Reading(dBuV) + C.F (Correction Factor).
4. The emission levels of other frequencies are very lower than the limit and not show in test report.

EUT	OAW-AP1301	Date of Test	2020-11-26
Factor	BBHA 9120D	Temp. / Humidity	23.7°C/42%
Polarity	Horizontal	Site / Test Engineer	AC1 / Jay Chiu
Test Mode	Transmit by 802.11ax-HE20 at Channel 2412MHz	Test Voltage	120V/60Hz

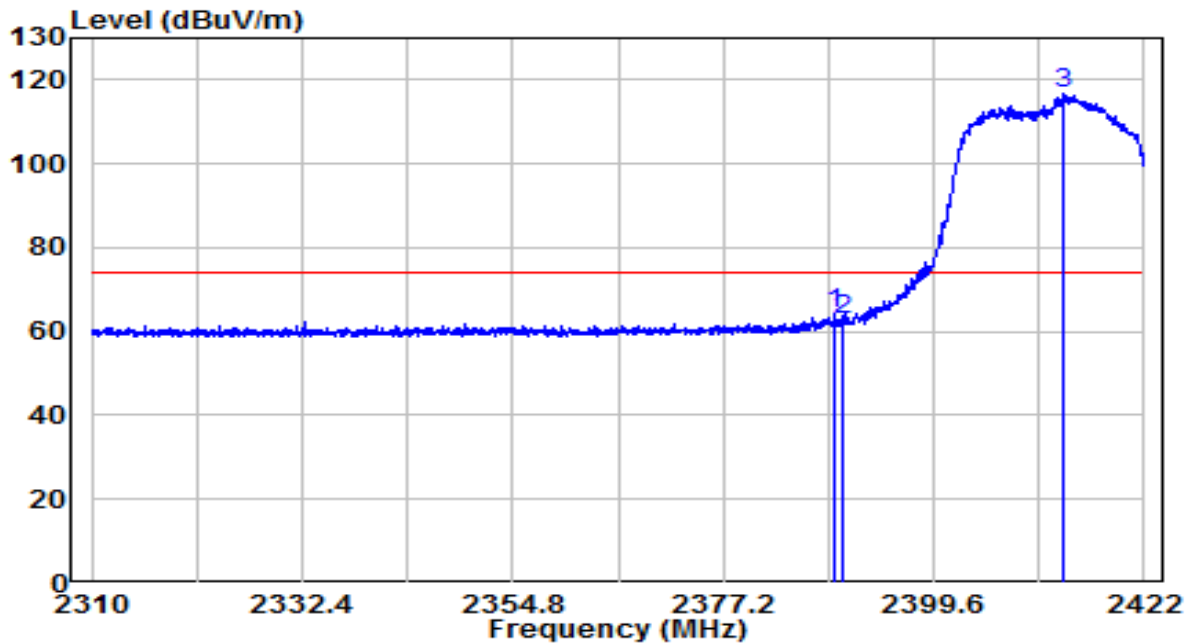

No	Frequency (MHz)	Reading (dBUV)	C.F (dB)	Measurement (dBUV/m)	Margin (dB)	Limit (dBUV/m)	Remark (QP/PK/AV)
1	2389.016	31.82	32.29	64.11	-9.89	74.00	Peak
2	2390.000	30.47	32.30	62.77	-11.23	74.00	Peak
3	* 2413.488	84.30	32.40	116.70	N/A	N/A	Peak

Note:

1. " \*", means this data is the worst emission level.
2. C.F (Correction Factor) = Antenna Factor (dB)+ Cable Loss (dB).
3. Measurement(dBUV/m) = Reading(dBUV) + C.F (Correction Factor).
4. The emission levels of other frequencies are very lower than the limit and not show in test report.

EUT	OAW-AP1301	Date of Test	2020-11-26
Factor	BBHA 9120D	Temp. / Humidity	23.7°C/42%
Polarity	Horizontal	Site / Test Engineer	AC1 / Jay Chiu
Test Mode	Transmit by 802.11ax-HE20 at Channel 2412MHz	Test Voltage	120V/60Hz

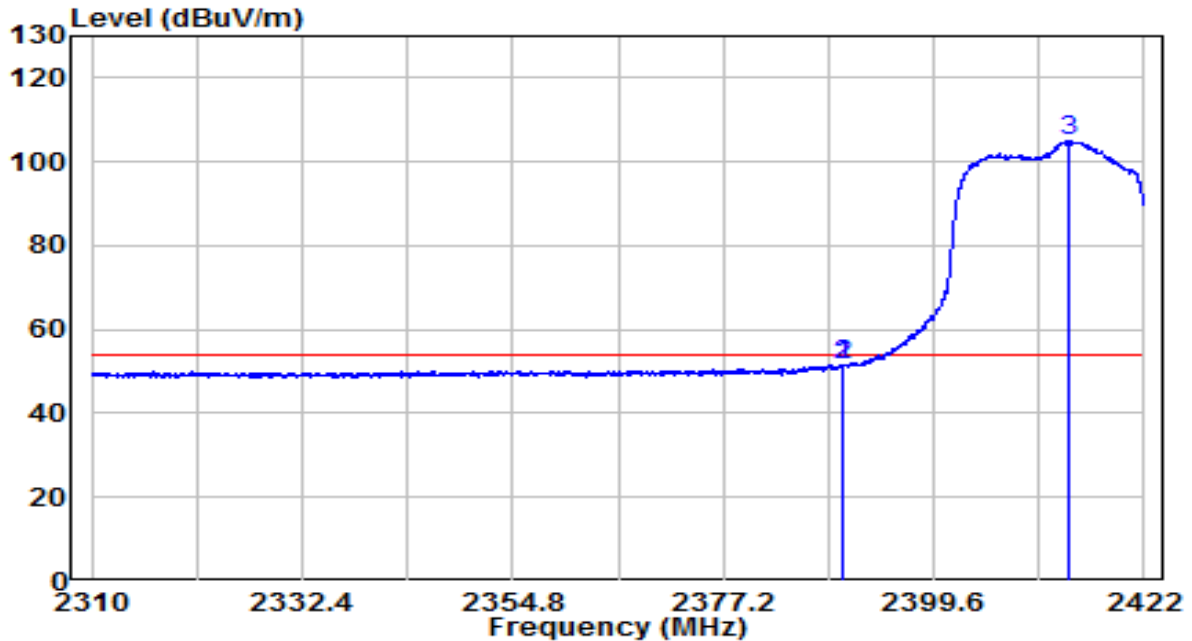

No	Frequency (MHz)	Reading (dBUV)	C.F (dB)	Measurement (dBUV/m)	Margin (dB)	Limit (dBUV/m)	Remark (QP/PK/AV)
1	2389.800	19.35	32.30	51.65	-2.35	54.00	Average
2	2390.000	19.04	32.30	51.34	-2.66	54.00	Average
3	* 2413.880	72.73	32.40	105.13	N/A	N/A	Average

Note:

1. " \*", means this data is the worst emission level.
2. C.F (Correction Factor) = Antenna Factor (dB)+ Cable Loss (dB).
3. Measurement(dBUV/m) = Reading(dBUV) + C.F (Correction Factor).
4. The emission levels of other frequencies are very lower than the limit and not show in test report.

EUT	OAW-AP1301	Date of Test	2020-11-26
Factor	BBHA 9120D	Temp. / Humidity	23.7°C/42%
Polarity	Vertical	Site / Test Engineer	AC1 / Jay Chiu
Test Mode	Transmit by 802.11ax-HE20 at Channel 2412MHz	Test Voltage	120V/60Hz

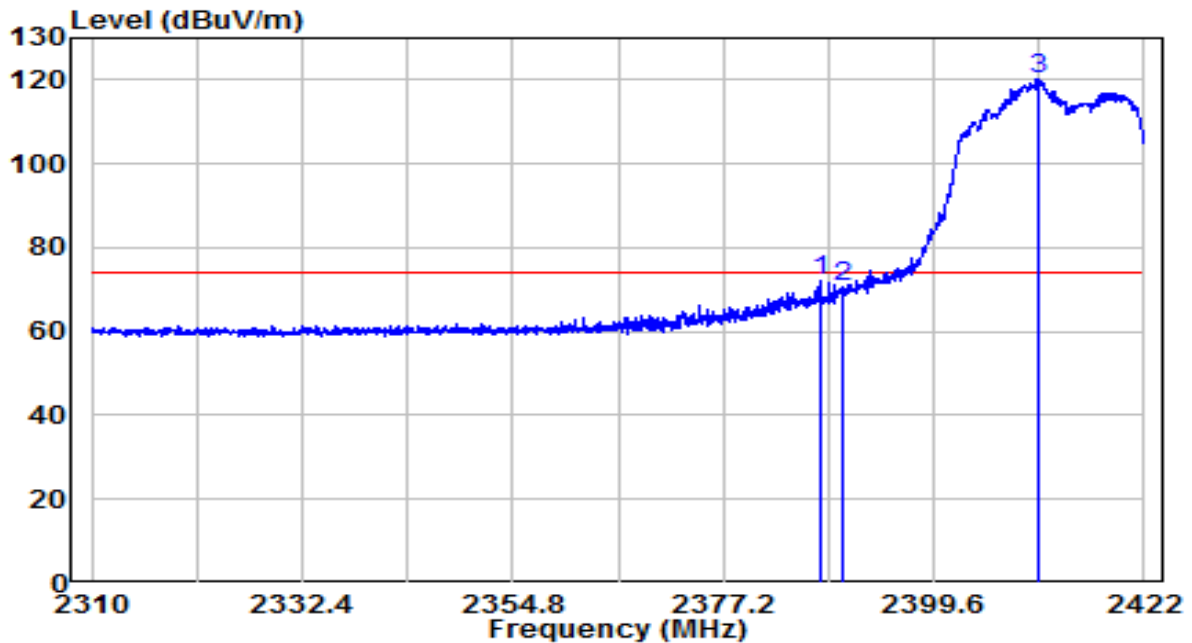

No	Frequency (MHz)	Reading (dBUV)	C.F (dB)	Measurement (dBUV/m)	Margin (dB)	Limit (dBUV/m)	Remark (QP/PK/AV)
1	2387.448	39.62	32.28	71.91	-2.09	74.00	Peak
2	2390.000	38.15	32.30	70.44	-3.56	74.00	Peak
3	* 2410.632	87.75	32.39	120.14	N/A	N/A	Peak

Note:

1. " \*", means this data is the worst emission level.
2. C.F (Correction Factor) = Antenna Factor (dB)+ Cable Loss (dB).
3. Measurement(dBUV/m) = Reading(dBUV) + C.F (Correction Factor).
4. The emission levels of other frequencies are very lower than the limit and not show in test report.

EUT	OAW-AP1301	Date of Test	2020-11-26
Factor	BBHA 9120D	Temp. / Humidity	23.7°C/42%
Polarity	Vertical	Site / Test Engineer	AC1 / Jay Chiu
Test Mode	Transmit by 802.11ax-HE20 at Channel 2412MHz	Test Voltage	120V/60Hz

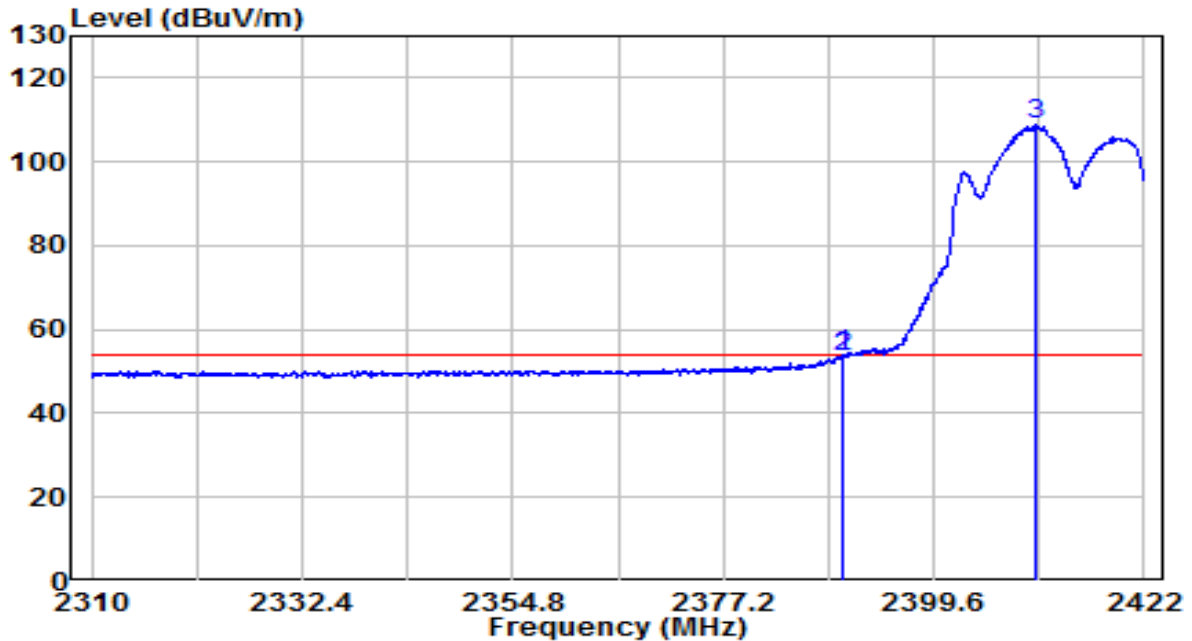

No	Frequency (MHz)	Reading (dBuV)	C.F (dB)	Measurement (dBuV/m)	Margin (dB)	Limit (dBuV/m)	Remark (QP/PK/AV)
1	2389.912	21.44	32.30	53.73	-0.27	54.00	Average
2	2390.000	21.28	32.30	53.58	-0.42	54.00	Average
3	* 2410.464	76.31	32.39	108.70	N/A	N/A	Average

Note:

1. " \*", means this data is the worst emission level.
2. C.F (Correction Factor) = Antenna Factor (dB)+ Cable Loss (dB).
3. Measurement(dBuV/m) = Reading(dBuV) + C.F (Correction Factor).
4. The emission levels of other frequencies are very lower than the limit and not show in test report.

EUT	OAW-AP1301	Date of Test	2020-12-18
Factor	BBHA 9120D	Temp. / Humidity	21.2°C/23%
Polarity	Vertical	Site / Test Engineer	AC1 / Jay Chiu
Test Mode	Transmit by 802.11ax-HE20 at Channel 2417MHz	Test Voltage	120V/60Hz

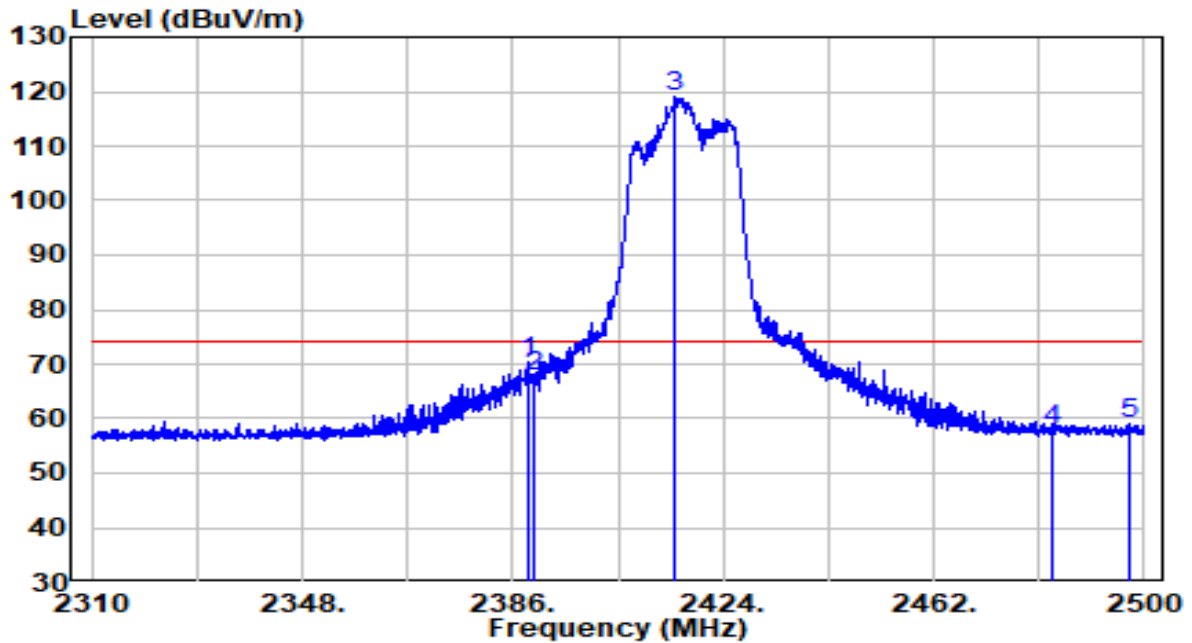

No	Frequency (MHz)	Reading (dBuV)	C.F (dB)	Measurement (dBuV/m)	Margin (dB)	Limit (dBuV/m)	Remark (QP/PK/AV)
1	2389.040	38.11	32.29	70.40	-3.60	74.00	Peak
2	2390.000	35.57	32.30	67.87	-6.13	74.00	Peak
3	* 2415.450	86.74	32.41	119.15	N/A	N/A	Peak
4	2483.500	25.11	32.71	57.82	-16.18	74.00	Peak
5	2497.435	26.13	32.77	58.90	-15.10	74.00	Peak

Note:

- "\*", means this data is the worst emission level.
- C.F (Correction Factor) = Antenna Factor (dB)+ Cable Loss (dB).
- Measurement(dBuV/m) = Reading(dBuV) + C.F (Correction Factor).
- The emission levels of other frequencies are very lower than the limit and not show in test report.



EUT	OAW-AP1301	Date of Test	2020-12-18
Factor	BBHA 9120D	Temp. / Humidity	21.2°C/23%
Polarity	Vertical	Site / Test Engineer	AC1 / Jay Chiu
Test Mode	Transmit by 802.11ax-HE20 at Channel 2417MHz	Test Voltage	120V/60Hz

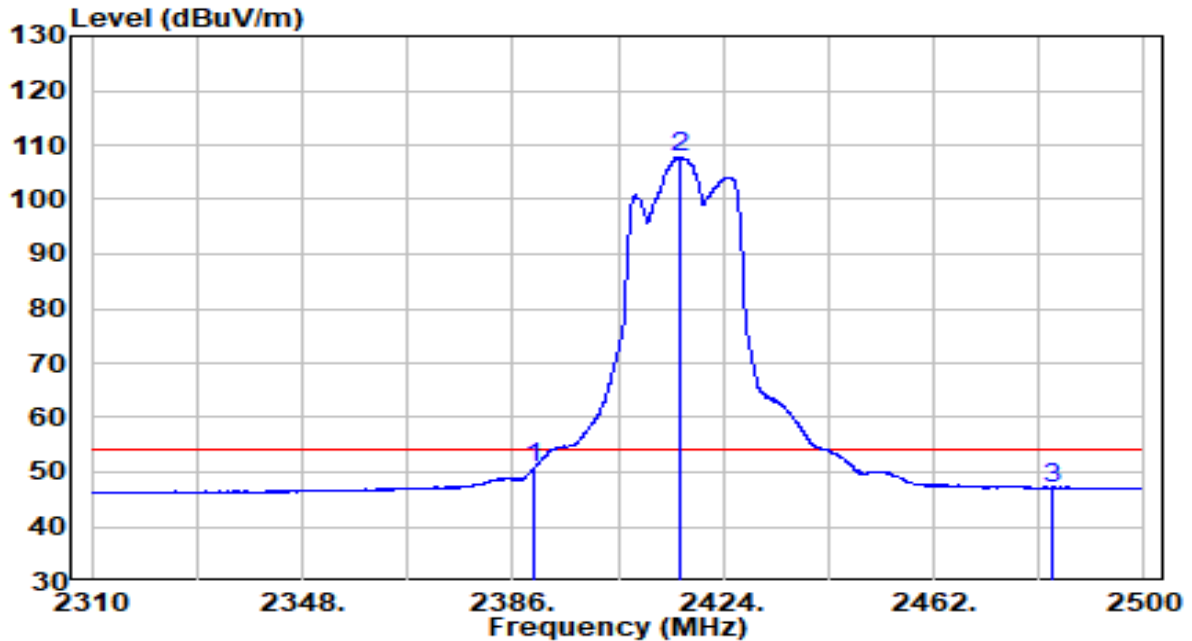

No	Frequency (MHz)	Reading (dBuV)	C.F (dB)	Measurement (dBuV/m)	Margin (dB)	Limit (dBuV/m)	Remark (QP/PK/AV)
1	2390.000	18.47	32.30	50.77	-3.23	54.00	Average
2	* 2416.210	75.40	32.41	107.81	N/A	N/A	Average
3	2483.500	14.43	32.71	47.14	-6.86	54.00	Average

Note:

1. " \*", means this data is the worst emission level.
2. C.F (Correction Factor) = Antenna Factor (dB)+ Cable Loss (dB).
3. Measurement(dBuV/m) = Reading(dBuV) + C.F (Correction Factor).
4. The emission levels of other frequencies are very lower than the limit and not show in test report.

EUT	OAW-AP1301	Date of Test	2020-11-26
Factor	BBHA 9120D	Temp. / Humidity	23.7°C/42%
Polarity	Horizontal	Site / Test Engineer	AC1 / Jay Chiu
Test Mode	Transmit by 802.11ax-HE20 at Channel 2437MHz	Test Voltage	120V/60Hz

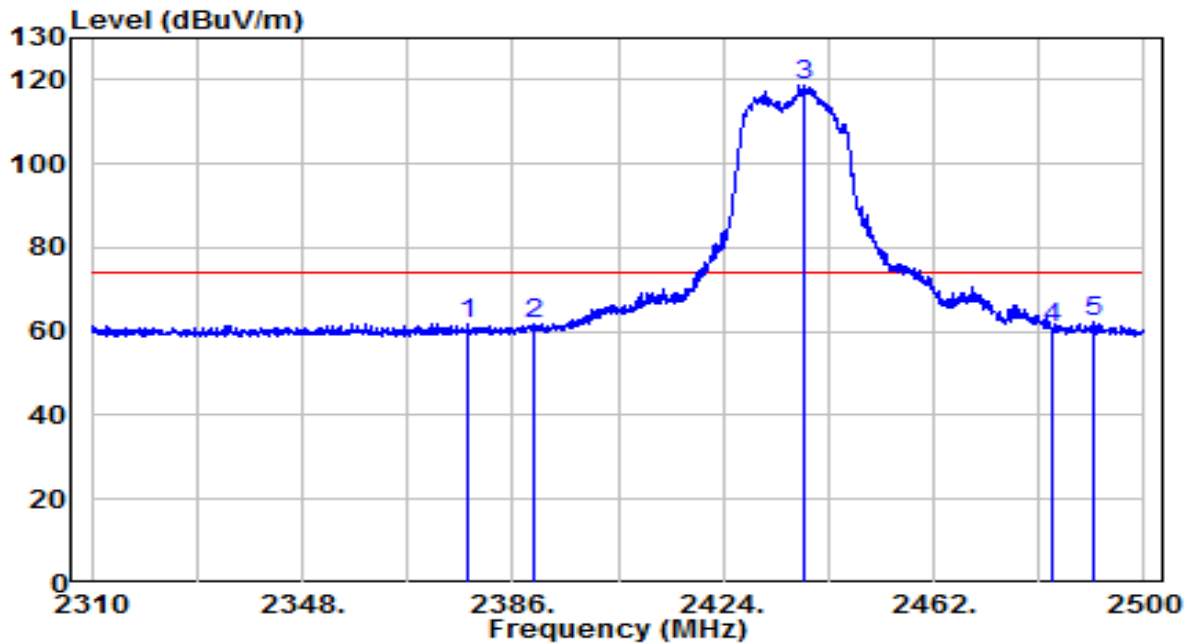

No	Frequency (MHz)	Reading (dBUV)	C.F (dB)	Measurement (dBUV/m)	Margin (dB)	Limit (dBUV/m)	Remark (QP/PK/AV)
1	2377.830	29.67	32.24	61.92	-12.08	74.00	Peak
2	2390.000	29.28	32.30	61.58	-12.42	74.00	Peak
3	* 2438.820	86.45	32.51	118.96	N/A	N/A	Peak
4	2483.500	28.00	32.71	60.71	-13.29	74.00	Peak
5	2490.975	29.66	32.74	62.40	-11.60	74.00	Peak

Note:

1. " \*", means this data is the worst emission level.
2. C.F (Correction Factor) = Antenna Factor (dB)+ Cable Loss (dB).
3. Measurement(dBUV/m) = Reading(dBUV) + C.F (Correction Factor).
4. The emission levels of other frequencies are very lower than the limit and not show in test report.

EUT	OAW-AP1301	Date of Test	2020-11-26
Factor	BBHA 9120D	Temp. / Humidity	23.7°C/42%
Polarity	Horizontal	Site / Test Engineer	AC1 / Jay Chiu
Test Mode	Transmit by 802.11ax-HE20 at Channel 2437MHz	Test Voltage	120V/60Hz

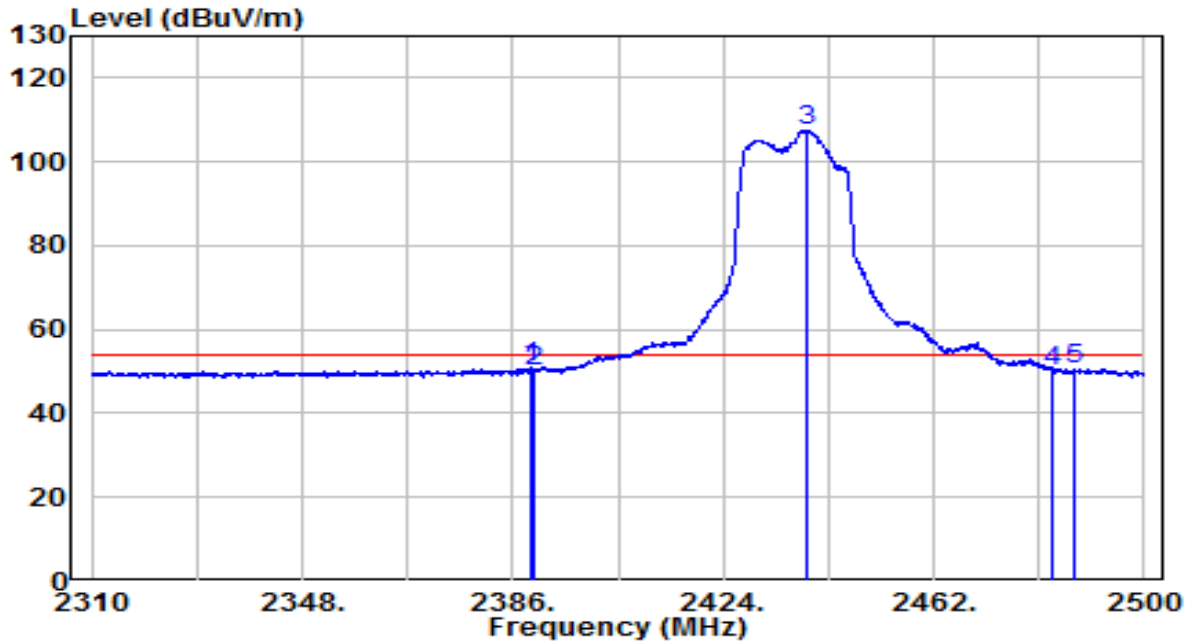

No	Frequency (MHz)	Reading (dBUV)	C.F (dB)	Measurement (dBUV/m)	Margin (dB)	Limit (dBUV/m)	Remark (QP/PK/AV)
1	2389.515	18.81	32.29	51.10	-2.90	54.00	Average
2	2390.000	17.55	32.30	49.84	-4.16	54.00	Average
3	* 2439.105	75.15	32.51	107.66	N/A	N/A	Average
4	2483.500	17.48	32.71	50.19	-3.81	54.00	Average
5	2487.460	17.98	32.72	50.70	-3.30	54.00	Average

Note:

1. " \*", means this data is the worst emission level.
2. C.F (Correction Factor) = Antenna Factor (dB)+ Cable Loss (dB).
3. Measurement(dBUV/m) = Reading(dBUV) + C.F (Correction Factor).
4. The emission levels of other frequencies are very lower than the limit and not show in test report.

EUT	OAW-AP1301	Date of Test	2020-11-26
Factor	BBHA 9120D	Temp. / Humidity	23.7°C/42%
Polarity	Vertical	Site / Test Engineer	AC1 / Jay Chiu
Test Mode	Transmit by 802.11ax-HE20 at Channel 2437MHz	Test Voltage	120V/60Hz

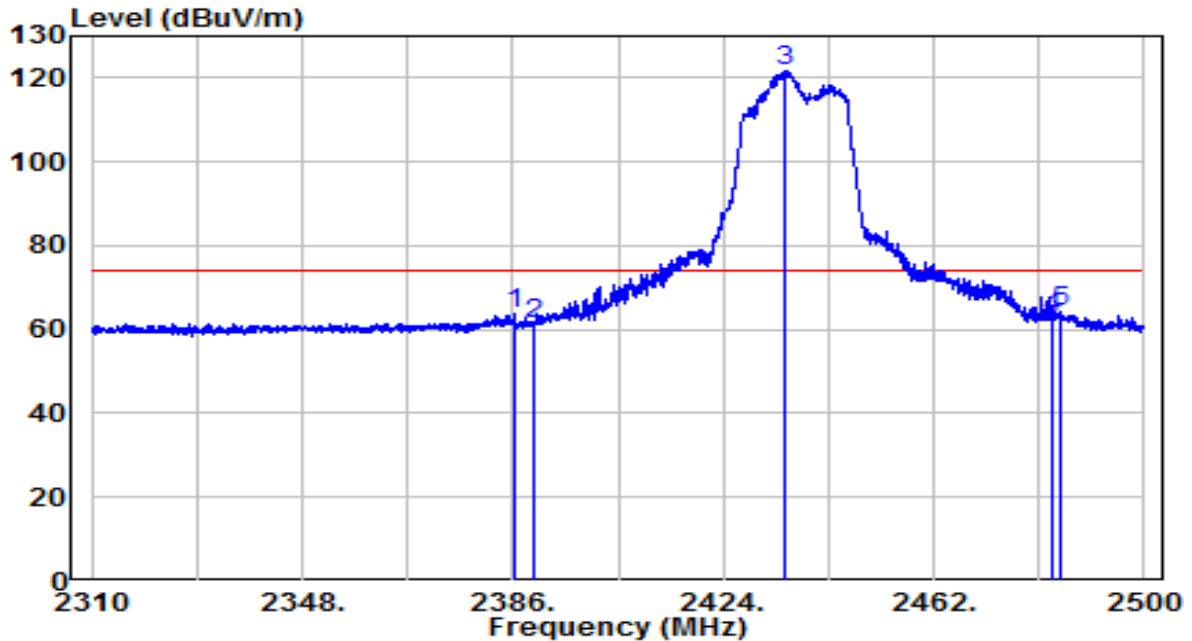

No	Frequency (MHz)	Reading (dBUV)	C.F (dB)	Measurement (dBUV/m)	Margin (dB)	Limit (dBUV/m)	Remark (QP/PK/AV)
1	2386.475	31.52	32.28	63.80	-10.20	74.00	Peak
2	2390.000	28.85	32.30	61.14	-12.86	74.00	Peak
3	* 2435.210	89.22	32.49	121.71	N/A	N/A	Peak
4	2483.500	30.18	32.71	62.89	-11.11	74.00	Peak
5	2484.705	31.79	32.71	64.50	-9.50	74.00	Peak

Note:

1. " \*", means this data is the worst emission level.
2. C.F (Correction Factor) = Antenna Factor (dB)+ Cable Loss (dB).
3. Measurement(dBUV/m) = Reading(dBUV) + C.F (Correction Factor).
4. The emission levels of other frequencies are very lower than the limit and not show in test report.

EUT	OAW-AP1301	Date of Test	2020-11-26
Factor	BBHA 9120D	Temp. / Humidity	23.7°C/42%
Polarity	Vertical	Site / Test Engineer	AC1 / Jay Chiu
Test Mode	Transmit by 802.11ax-HE20 at Channel 2437MHz	Test Voltage	120V/60Hz

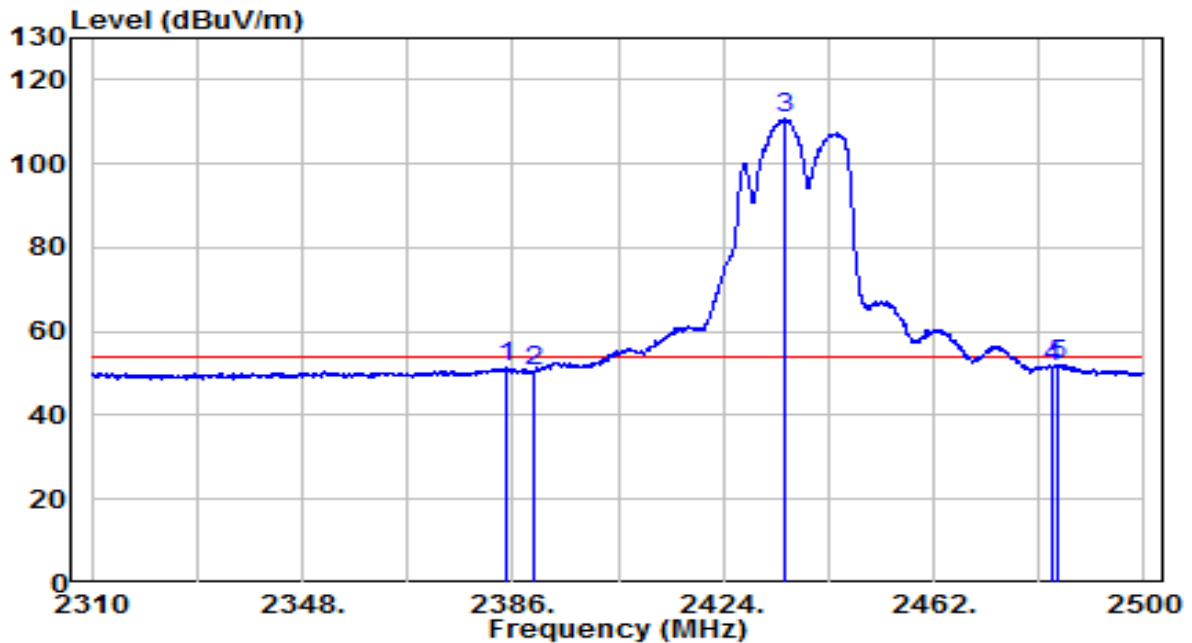

No	Frequency (MHz)	Reading (dBuV)	C.F (dB)	Measurement (dBuV/m)	Margin (dB)	Limit (dBuV/m)	Remark (QP/PK/AV)
1	2384.955	19.01	32.27	51.29	-2.71	54.00	Average
2	2390.000	18.37	32.30	50.67	-3.33	54.00	Average
3	* 2435.210	78.30	32.49	110.80	N/A	N/A	Average
4	2483.470	18.91	32.71	51.62	-2.38	54.00	Average
5	2484.230	19.35	32.71	52.06	-1.94	54.00	Average

Note:

1. " \*", means this data is the worst emission level.
2. C.F (Correction Factor) = Antenna Factor (dB)+ Cable Loss (dB).
3. Measurement(dBuV/m) = Reading(dBuV) + C.F (Correction Factor).
4. The emission levels of other frequencies are very lower than the limit and not show in test report.

EUT	OAW-AP1301	Date of Test	2020-12-01
Factor	BBHA 9120D	Temp. / Humidity	23.8°C/45%
Polarity	Vertical	Site / Test Engineer	AC1 / Jay Chiu
Test Mode	Transmit by 802.11ax-HE20 at Channel 2457MHz	Test Voltage	120V/60Hz

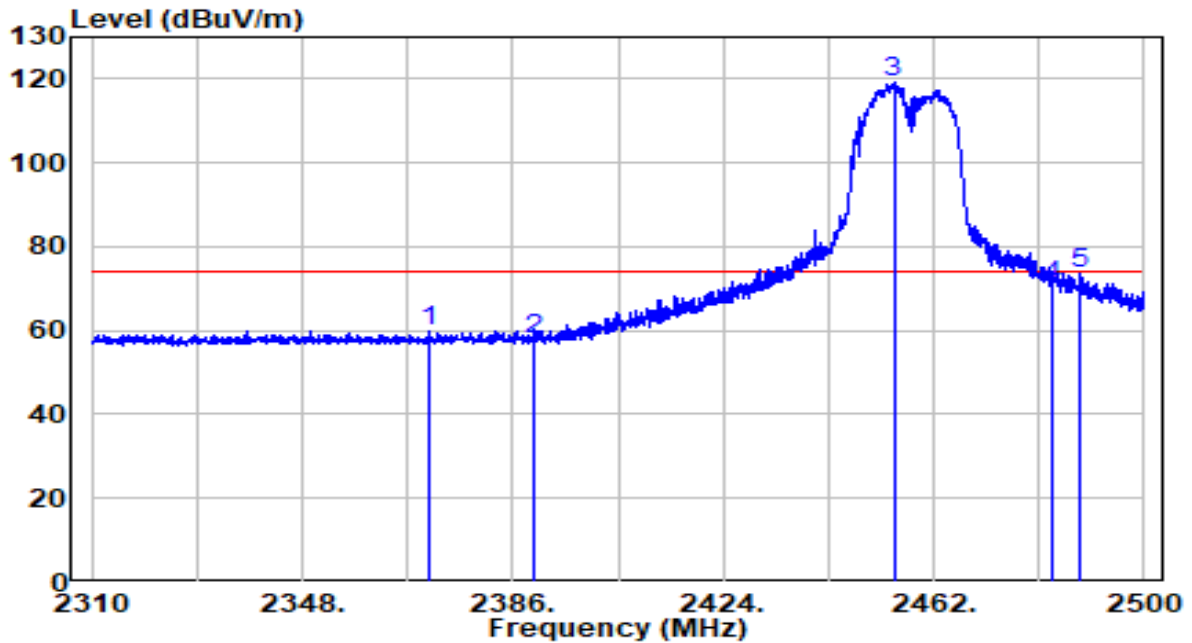

No	Frequency (MHz)	Reading (dBuV)	C.F (dB)	Measurement (dBuV/m)	Margin (dB)	Limit (dBuV/m)	Remark (QP/PK/AV)
1	2370.705	27.88	32.21	60.09	-13.91	74.00	Peak
2	2390.000	25.56	32.30	57.86	-16.14	74.00	Peak
3	* 2454.780	86.46	32.58	119.04	N/A	N/A	Peak
4	2483.500	37.94	32.71	70.64	-3.36	74.00	Peak
5	2488.505	40.84	32.73	73.57	-0.43	74.00	Peak

Note:

1. " \*", means this data is the worst emission level.
2. C.F (Correction Factor) = Antenna Factor (dB)+ Cable Loss (dB)- Preamplifier(dB).
3. Measurement(dBuV/m) = Reading(dBuV) + C.F (Correction Factor).
4. The emission levels of other frequencies are very lower than the limit and not show in test report.

EUT	OAW-AP1301	Date of Test	2020-12-01
Factor	BBHA 9120D	Temp. / Humidity	23.8°C/45%
Polarity	Vertical	Site / Test Engineer	AC1 / Jay Chiu
Test Mode	Transmit by 802.11ax-HE20 at Channel 2457MHz	Test Voltage	120V/60Hz

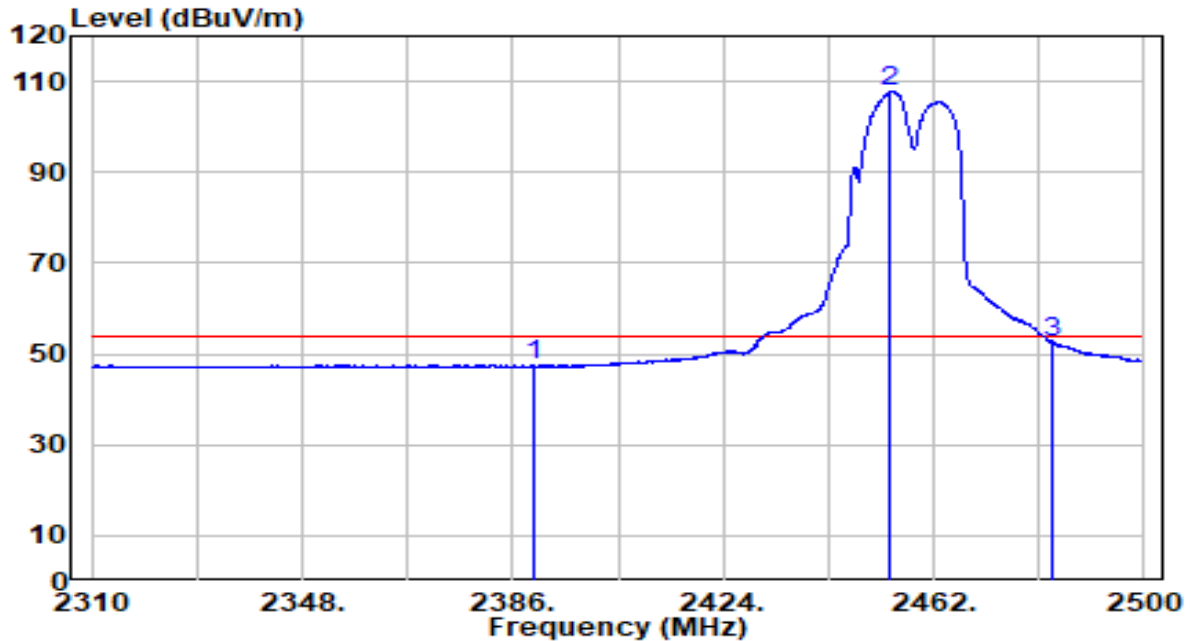

No	Frequency (MHz)	Reading (dBuV)	C.F (dB)	Measurement (dBuV/m)	Margin (dB)	Limit (dBuV/m)	Remark (QP/PK/AV)
1	2390.000	15.04	32.30	47.34	-6.66	54.00	Average
2	* 2454.115	75.03	32.58	107.61	N/A	N/A	Average
3	2483.500	19.67	32.71	52.38	-1.62	54.00	Average

Note:

1. " \*", means this data is the worst emission level.
2. C.F (Correction Factor) = Antenna Factor (dB)+ Cable Loss (dB)– Preamplifier(dB).
3. Measurement(dBuV/m) = Reading(dBuV) + C.F (Correction Factor).
- 4.The emission levels of other frequencies are very lower than the limit and not show in test report.

EUT	OAW-AP1301	Date of Test	2020-11-26
Factor	BBHA 9120D	Temp. / Humidity	23.7°C/42%
Polarity	Horizontal	Site / Test Engineer	AC1 / Jay Chiu
Test Mode	Transmit by 802.11ax-HE20 at Channel 2462MHz	Test Voltage	120V/60Hz

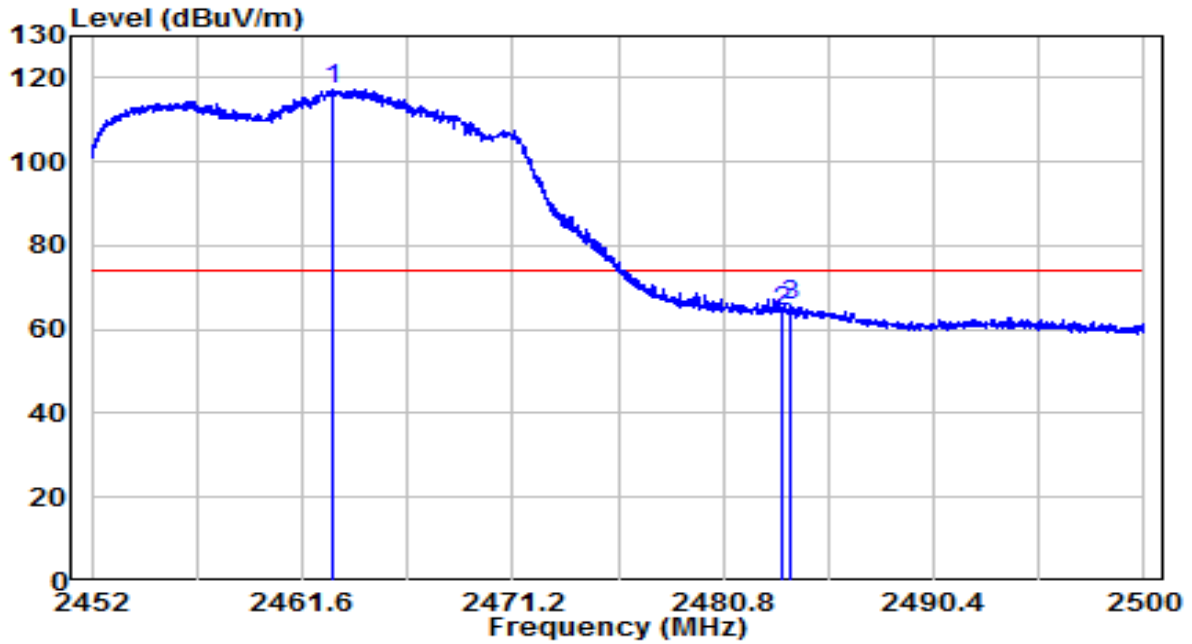

No	Frequency (MHz)	Reading (dBuV)	C.F (dB)	Measurement (dBuV/m)	Margin (dB)	Limit (dBuV/m)	Remark (QP/PK/AV)
1	* 2462.968	84.79	32.62	117.40	N/A	N/A	Peak
2	2483.500	31.38	32.71	64.09	-9.91	74.00	Peak
3	2483.896	33.12	32.71	65.82	-8.18	74.00	Peak

Note:

1. " \*", means this data is the worst emission level.
2. C.F (Correction Factor) = Antenna Factor (dB)+ Cable Loss (dB).
3. Measurement(dBuV/m) = Reading(dBuV) + C.F (Correction Factor).
4. The emission levels of other frequencies are very lower than the limit and not show in test report.



EUT	OAW-AP1301	Date of Test	2020-11-26
Factor	BBHA 9120D	Temp. / Humidity	23.7°C/42%
Polarity	Horizontal	Site / Test Engineer	AC1 / Jay Chiu
Test Mode	Transmit by 802.11ax-HE20 at Channel 2462MHz	Test Voltage	120V/60Hz

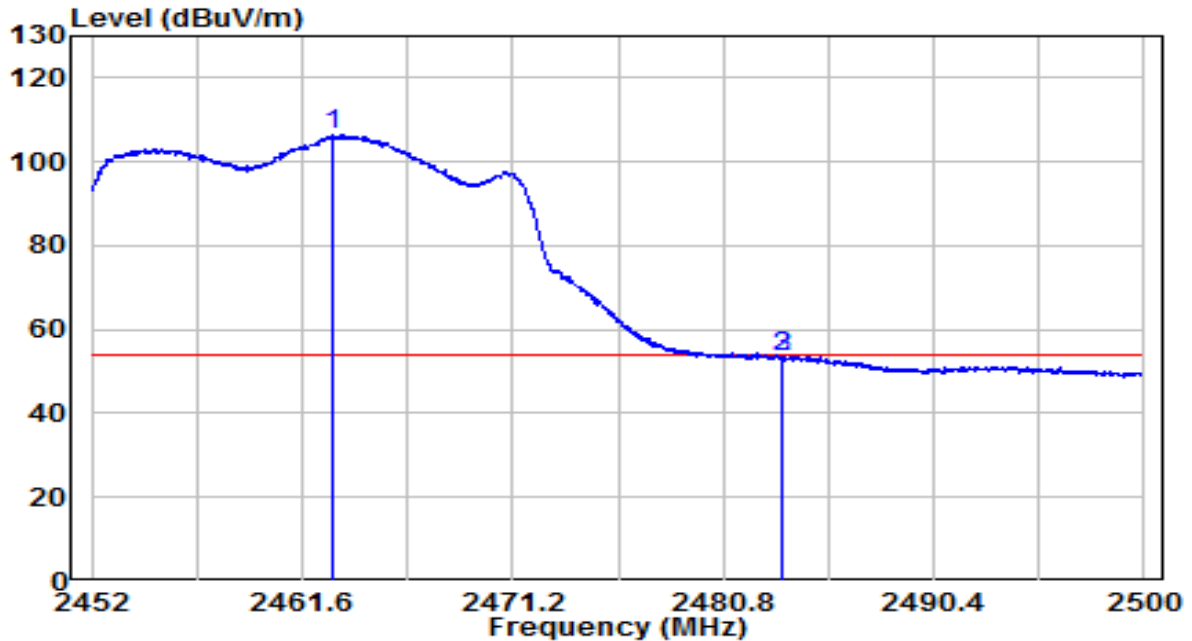

No	Frequency (MHz)	Reading (dBuV)	C.F (dB)	Measurement (dBuV/m)	Margin (dB)	Limit (dBuV/m)	Remark (QP/PK/AV)
1	* 2463.016	73.75	32.62	106.37	N/A	N/A	Average
2	2483.500	20.61	32.71	53.32	-0.68	54.00	Average
3	2483.512	20.99	32.71	53.69	-0.31	54.00	Average

Note:

1. " \*", means this data is the worst emission level.
2. C.F (Correction Factor) = Antenna Factor (dB)+ Cable Loss (dB).
3. Measurement(dBuV/m) = Reading(dBuV) + C.F (Correction Factor).
4. The emission levels of other frequencies are very lower than the limit and not show in test report.

EUT	OAW-AP1301	Date of Test	2020-11-26
Factor	BBHA 9120D	Temp. / Humidity	23.7°C/42%
Polarity	Vertical	Site / Test Engineer	AC1 / Jay Chiu
Test Mode	Transmit by 802.11ax-HE20 at Channel 2462MHz	Test Voltage	120V/60Hz

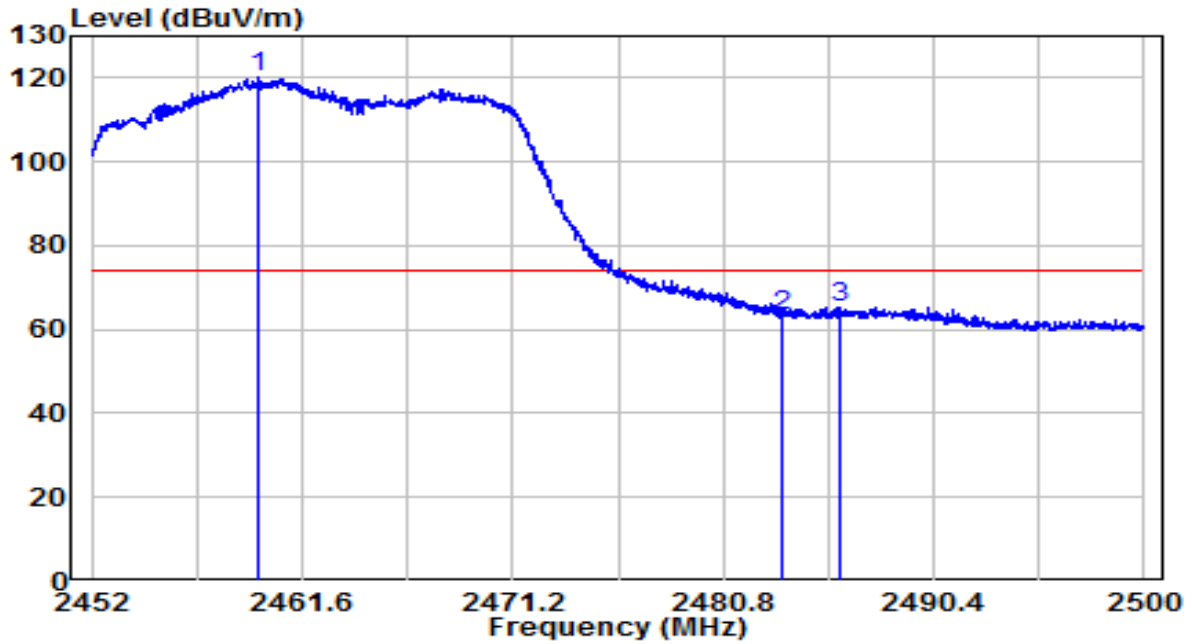

No	Frequency (MHz)	Reading (dBUV)	C.F (dB)	Measurement (dBUV/m)	Margin (dB)	Limit (dBUV/m)	Remark (QP/PK/AV)
1	* 2459.536	87.65	32.60	120.26	N/A	N/A	Peak
2	2483.500	30.76	32.71	63.47	-10.53	74.00	Peak
3	2486.080	32.61	32.72	65.33	-8.67	74.00	Peak

Note:

1. " \*", means this data is the worst emission level.
2. C.F (Correction Factor) = Antenna Factor (dB)+ Cable Loss (dB).
3. Measurement(dBUV/m) = Reading(dBUV) + C.F (Correction Factor).
4. The emission levels of other frequencies are very lower than the limit and not show in test report.

EUT	OAW-AP1301	Date of Test	2020-11-26
Factor	BBHA 9120D	Temp. / Humidity	23.7°C/42%
Polarity	Vertical	Site / Test Engineer	AC1 / Jay Chiu
Test Mode	Transmit by 802.11ax-HE20 at Channel 2462MHz	Test Voltage	120V/60Hz

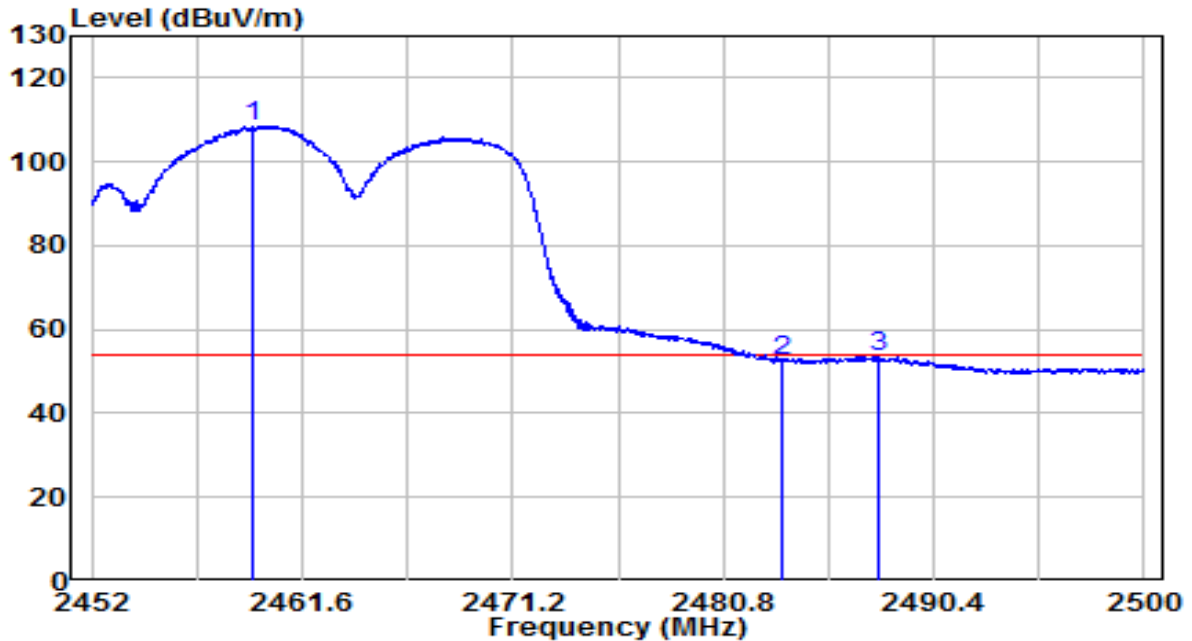

No	Frequency (MHz)	Reading (dBuV)	C.F (dB)	Measurement (dBuV/m)	Margin (dB)	Limit (dBuV/m)	Remark (QP/PK/AV)
1	* 2459.392	75.88	32.60	108.49	N/A	N/A	Average
2	2483.500	19.89	32.71	52.60	-1.40	54.00	Average
3	2487.832	20.74	32.73	53.47	-0.53	54.00	Average

Note:

1. " \*", means this data is the worst emission level.
2. C.F (Correction Factor) = Antenna Factor (dB)+ Cable Loss (dB).
3. Measurement(dBuV/m) = Reading(dBuV) + C.F (Correction Factor).
4. The emission levels of other frequencies are very lower than the limit and not show in test report.

EUT	OAW-AP1301	Date of Test	2020-11-26
Factor	BBHA 9120D	Temp. / Humidity	23.7°C/42%
Polarity	Horizontal	Site / Test Engineer	AC1 / Jay Chiu
Test Mode	Transmit by 802.11ax-HE40 at Channel 2422MHz	Test Voltage	120V/60Hz

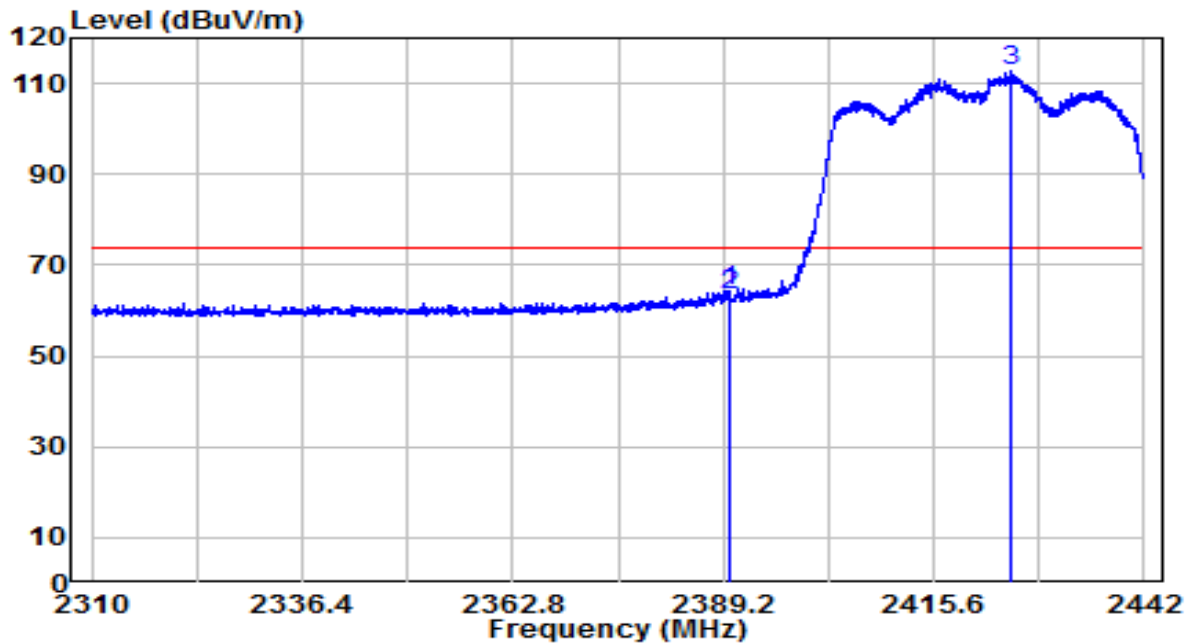

No	Frequency (MHz)	Reading (dBUV)	C.F (dB)	Measurement (dBUV/m)	Margin (dB)	Limit (dBUV/m)	Remark (QP/PK/AV)
1	2389.926	32.09	32.30	64.39	-9.61	74.00	Peak
2	2390.000	30.99	32.30	63.29	-10.71	74.00	Peak
3	* 2425.434	80.34	32.45	112.80	N/A	N/A	Peak

Note:

1. " \*", means this data is the worst emission level.
2. C.F (Correction Factor) = Antenna Factor (dB)+ Cable Loss (dB).
3. Measurement(dBUV/m) = Reading(dBUV) + C.F (Correction Factor).
4. The emission levels of other frequencies are very lower than the limit and not show in test report.

EUT	OAW-AP1301	Date of Test	2020-11-26
Factor	BBHA 9120D	Temp. / Humidity	23.7°C/42%
Polarity	Horizontal	Site / Test Engineer	AC1 / Jay Chiu
Test Mode	Transmit by 802.11ax-HE40 at Channel 2422MHz	Test Voltage	120V/60Hz

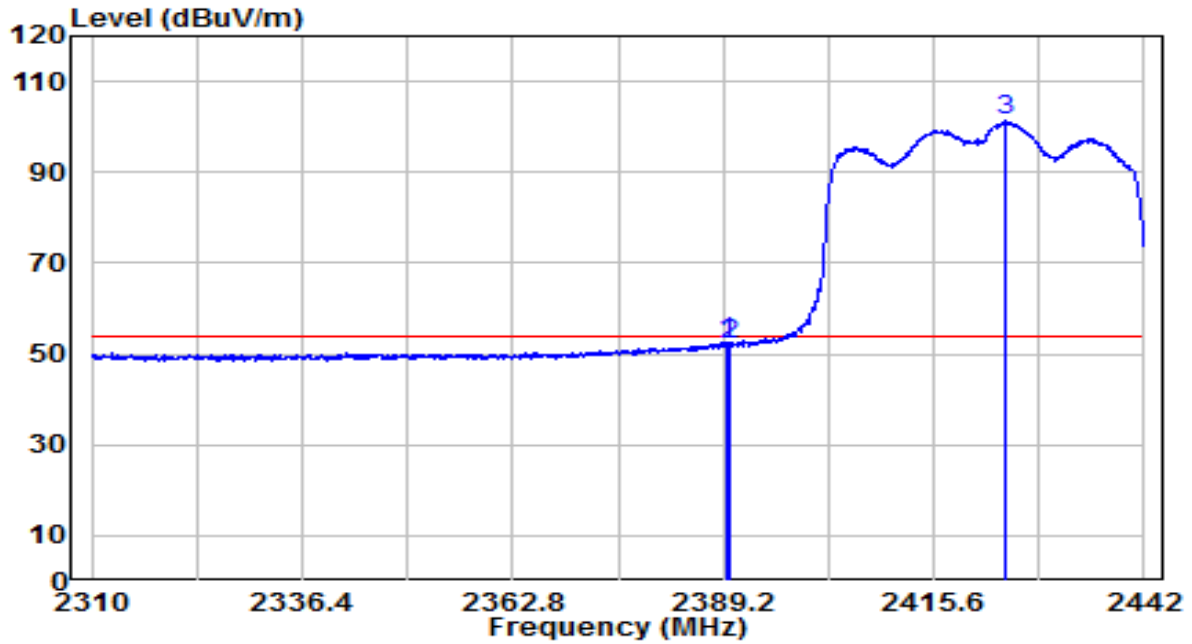

No	Frequency (MHz)	Reading (dBUV)	C.F (dB)	Measurement (dBUV/m)	Margin (dB)	Limit (dBUV/m)	Remark (QP/PK/AV)
1	2389.596	20.37	32.29	52.67	-1.33	54.00	Average
2	2390.000	19.58	32.30	51.87	-2.13	54.00	Average
3	* 2424.708	68.83	32.45	101.28	N/A	N/A	Average

Note:

1. " \*", means this data is the worst emission level.
2. C.F (Correction Factor) = Antenna Factor (dB)+ Cable Loss (dB).
3. Measurement(dBUV/m) = Reading(dBUV) + C.F (Correction Factor).
4. The emission levels of other frequencies are very lower than the limit and not show in test report.

EUT	OAW-AP1301	Date of Test	2020-11-26
Factor	BBHA 9120D	Temp. / Humidity	23.7°C/42%
Polarity	Vertical	Site / Test Engineer	AC1 / Jay Chiu
Test Mode	Transmit by 802.11ax-HE40 at Channel 2422MHz	Test Voltage	120V/60Hz

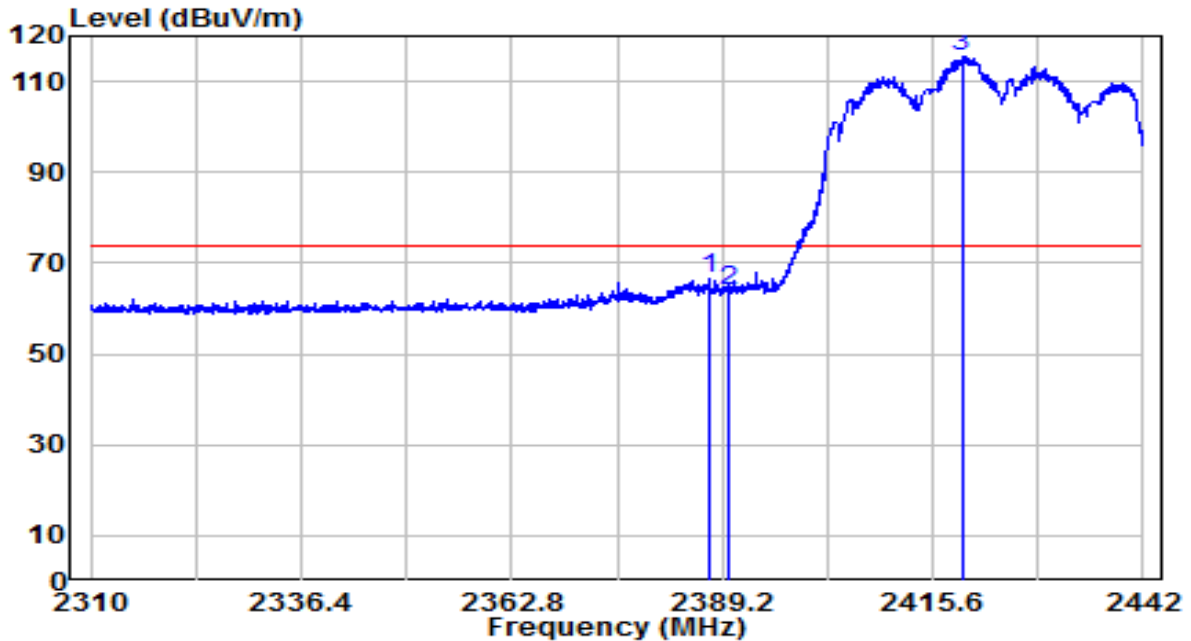

No	Frequency (MHz)	Reading (dBUV)	C.F (dB)	Measurement (dBUV/m)	Margin (dB)	Limit (dBUV/m)	Remark (QP/PK/AV)
1	2387.616	34.08	32.29	66.36	-7.64	74.00	Peak
2	2390.000	31.60	32.30	63.89	-10.11	74.00	Peak
3	* 2419.230	83.13	32.42	115.55	N/A	N/A	Peak

Note:

1. " \*", means this data is the worst emission level.
2. C.F (Correction Factor) = Antenna Factor (dB)+ Cable Loss (dB).
3. Measurement(dBUV/m) = Reading(dBUV) + C.F (Correction Factor).
- 4.The emission levels of other frequencies are very lower than the limit and not show in test report.

EUT	OAW-AP1301	Date of Test	2020-11-26
Factor	BBHA 9120D	Temp. / Humidity	23.7°C/42%
Polarity	Vertical	Site / Test Engineer	AC1 / Jay Chiu
Test Mode	Transmit by 802.11ax-HE40 at Channel 2422MHz	Test Voltage	120V/60Hz

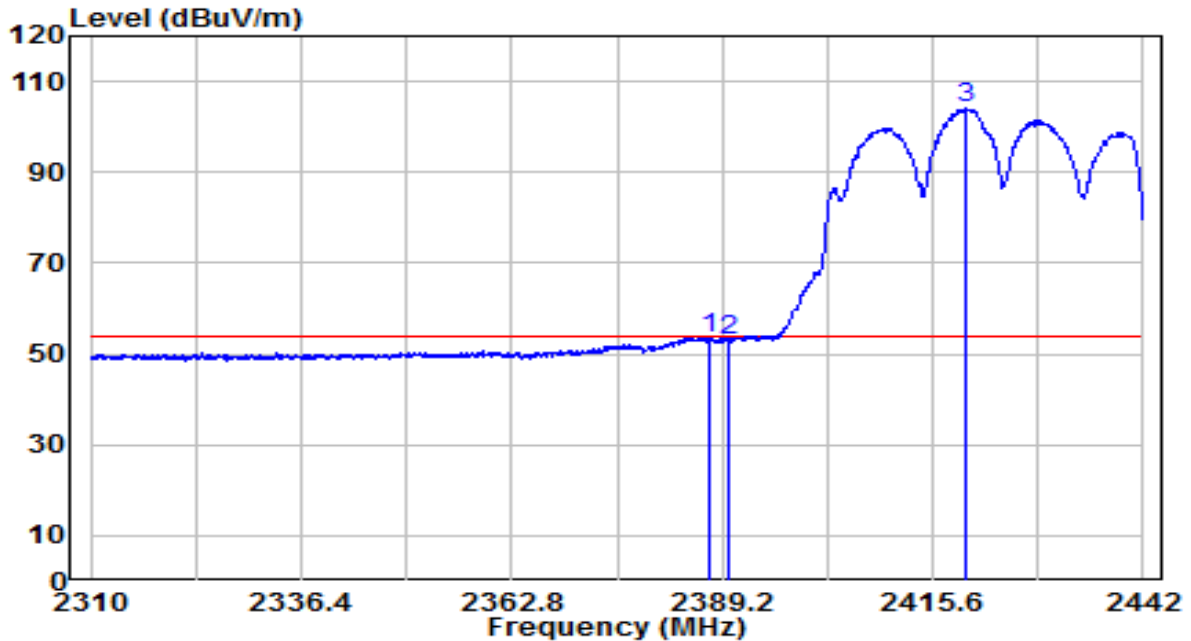

No	Frequency (MHz)	Reading (dBUV)	C.F (dB)	Measurement (dBUV/m)	Margin (dB)	Limit (dBUV/m)	Remark (QP/PK/AV)
1	2387.682	21.37	32.29	53.65	-0.35	54.00	Average
2	2390.000	20.65	32.30	52.94	-1.06	54.00	Average
3	* 2419.890	71.67	32.43	104.10	N/A	N/A	Average

Note:

1. " \*", means this data is the worst emission level.
2. C.F (Correction Factor) = Antenna Factor (dB)+ Cable Loss (dB).
3. Measurement(dBUV/m) = Reading(dBUV) + C.F (Correction Factor).
4. The emission levels of other frequencies are very lower than the limit and not show in test report.

EUT	OAW-AP1301	Date of Test	2020-12-18
Factor	BBHA 9120D	Temp. / Humidity	21.2°C/23%
Polarity	Vertical	Site / Test Engineer	AC1 / Jay Chiu
Test Mode	Transmit by 802.11ax-HE40 at Channel 2427MHz	Test Voltage	120V/60Hz

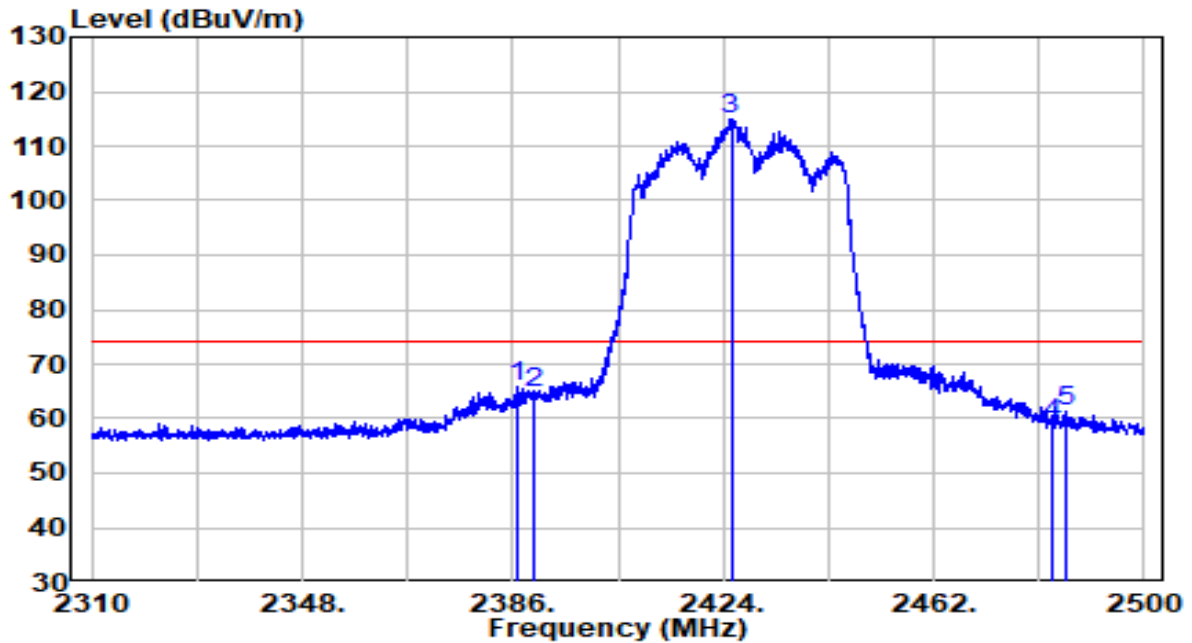

No	Frequency (MHz)	Reading (dBuV)	C.F (dB)	Measurement (dBuV/m)	Margin (dB)	Limit (dBuV/m)	Remark (QP/PK/AV)
1	2386.855	33.69	32.28	65.97	-8.03	74.00	Peak
2	2390.000	32.28	32.30	64.57	-9.43	74.00	Peak
3	* 2425.425	82.34	32.45	114.79	N/A	N/A	Peak
4	2483.500	26.29	32.71	58.99	-15.01	74.00	Peak
5	2485.845	28.73	32.72	61.45	-12.55	74.00	Peak

Note:

1. " \*", means this data is the worst emission level.
2. C.F (Correction Factor) = Antenna Factor (dB)+ Cable Loss (dB).
3. Measurement(dBuV/m) = Reading(dBuV) + C.F (Correction Factor).
4. The emission levels of other frequencies are very lower than the limit and not show in test report.



EUT	OAW-AP1301	Date of Test	2020-12-18
Factor	BBHA 9120D	Temp. / Humidity	21.2°C/23%
Polarity	Vertical	Site / Test Engineer	AC1 / Jay Chiu
Test Mode	Transmit by 802.11ax-HE40 at Channel 2427MHz	Test Voltage	120V/60Hz

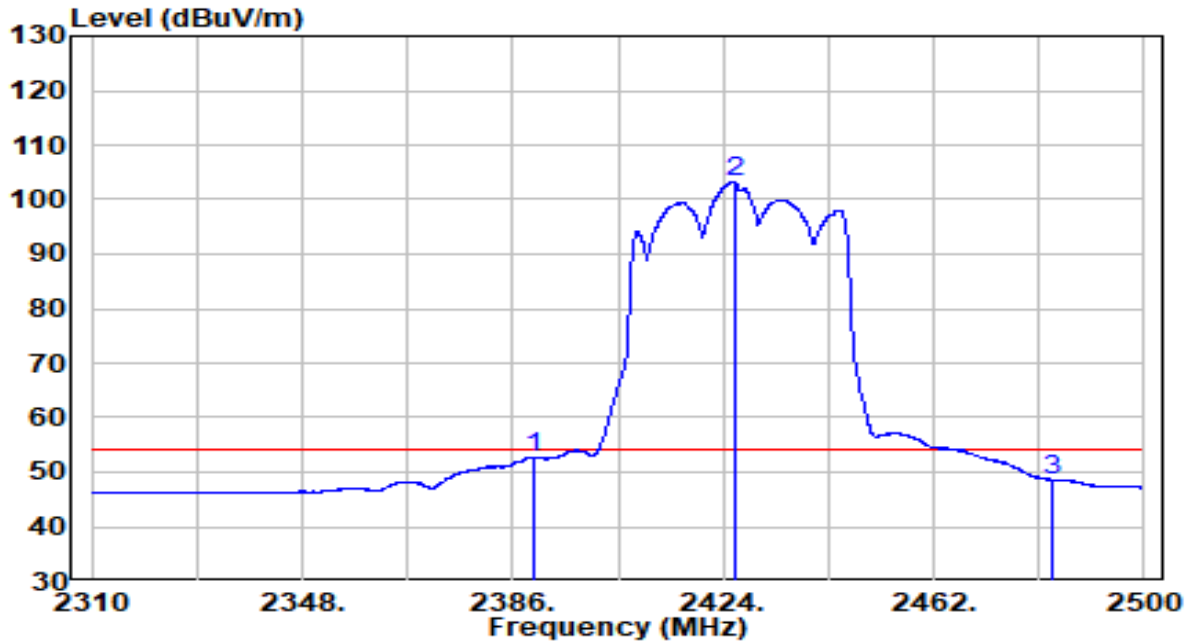

No	Frequency (MHz)	Reading (dBUV)	C.F (dB)	Measurement (dBUV/m)	Margin (dB)	Limit (dBUV/m)	Remark (QP/PK/AV)
1	2390.000	20.34	32.30	52.64	-1.36	54.00	Average
2	* 2426.090	70.91	32.45	103.37	N/A	N/A	Average
3	2483.500	15.91	32.71	48.61	-5.39	54.00	Average

Note:

1. " \*", means this data is the worst emission level.
2. C.F (Correction Factor) = Antenna Factor (dB)+ Cable Loss (dB).
3. Measurement(dBUV/m) = Reading(dBUV) + C.F (Correction Factor).
4. The emission levels of other frequencies are very lower than the limit and not show in test report.

EUT	OAW-AP1301	Date of Test	2020-11-26
Factor	BBHA 9120D	Temp. / Humidity	23.7°C/42%
Polarity	Horizontal	Site / Test Engineer	AC1 / Jay Chiu
Test Mode	Transmit by 802.11ax-HE40 at Channel 2437MHz	Test Voltage	120V/60Hz

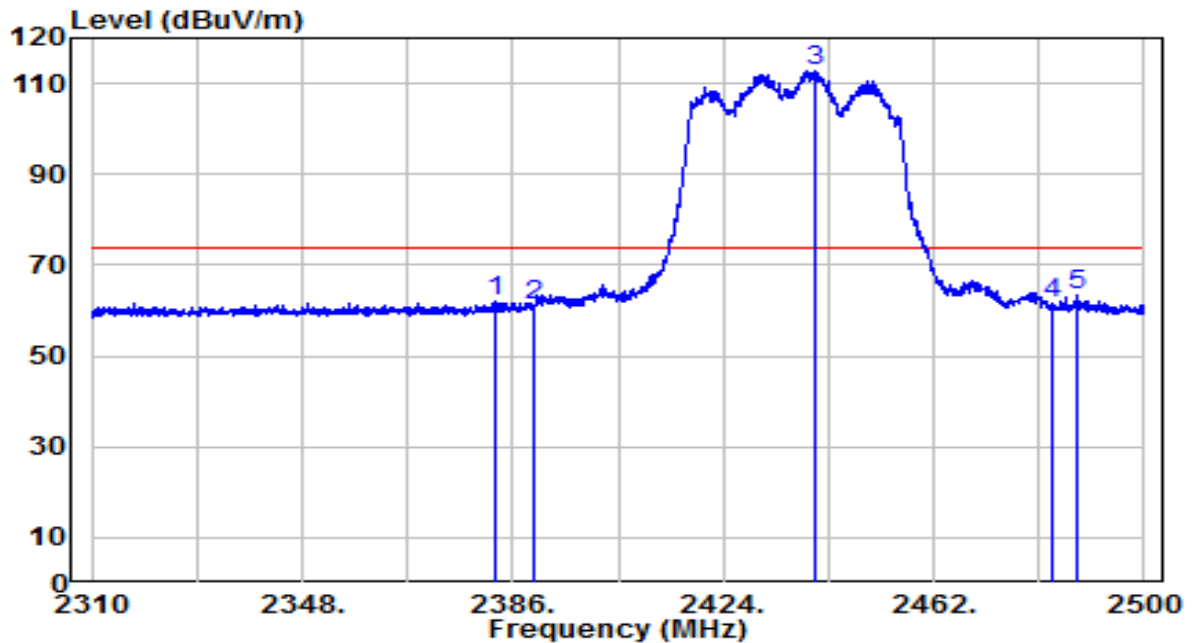

No	Frequency (MHz)	Reading (dBUV)	C.F (dB)	Measurement (dBUV/m)	Margin (dB)	Limit (dBUV/m)	Remark (QP/PK/AV)
1	2382.675	29.56	32.26	61.82	-12.18	74.00	Peak
2	2390.000	28.76	32.30	61.05	-12.95	74.00	Peak
3	* 2440.720	80.33	32.52	112.85	N/A	N/A	Peak
4	2483.500	28.67	32.71	61.38	-12.62	74.00	Peak
5	2487.840	30.68	32.73	63.41	-10.59	74.00	Peak

Note:

1. " \*", means this data is the worst emission level.
2. C.F (Correction Factor) = Antenna Factor (dB)+ Cable Loss (dB).
3. Measurement(dBUV/m) = Reading(dBUV) + C.F (Correction Factor).
4. The emission levels of other frequencies are very lower than the limit and not show in test report.

EUT	OAW-AP1301	Date of Test	2020-11-26
Factor	BBHA 9120D	Temp. / Humidity	23.7°C/42%
Polarity	Horizontal	Site / Test Engineer	AC1 / Jay Chiu
Test Mode	Transmit by 802.11ax-HE40 at Channel 2437MHz	Test Voltage	120V/60Hz

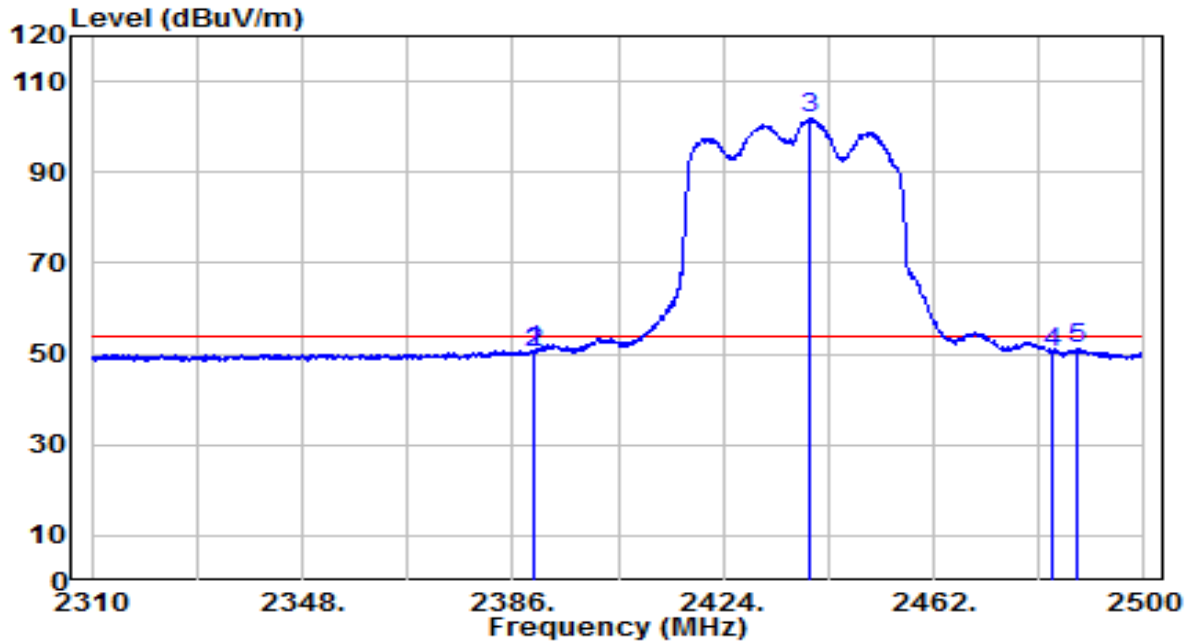

No	Frequency (MHz)	Reading (dBUV)	C.F (dB)	Measurement (dBUV/m)	Margin (dB)	Limit (dBUV/m)	Remark (QP/PK/AV)
1	2389.705	18.58	32.29	50.88	-3.12	54.00	Average
2	2390.000	17.99	32.30	50.29	-3.71	54.00	Average
3	* 2439.485	69.19	32.51	101.71	N/A	N/A	Average
4	2483.500	17.65	32.71	50.36	-3.64	54.00	Average
5	2487.650	18.34	32.73	51.07	-2.93	54.00	Average

Note:

1. " \*", means this data is the worst emission level.
2. C.F (Correction Factor) = Antenna Factor (dB)+ Cable Loss (dB).
3. Measurement(dBUV/m) = Reading(dBUV) + C.F (Correction Factor).
4. The emission levels of other frequencies are very lower than the limit and not show in test report.

EUT	OAW-AP1301	Date of Test	2020-11-26
Factor	BBHA 9120D	Temp. / Humidity	23.7°C/42%
Polarity	Vertical	Site / Test Engineer	AC1 / Jay Chiu
Test Mode	Transmit by 802.11ax-HE40 at Channel 2437MHz	Test Voltage	120V/60Hz

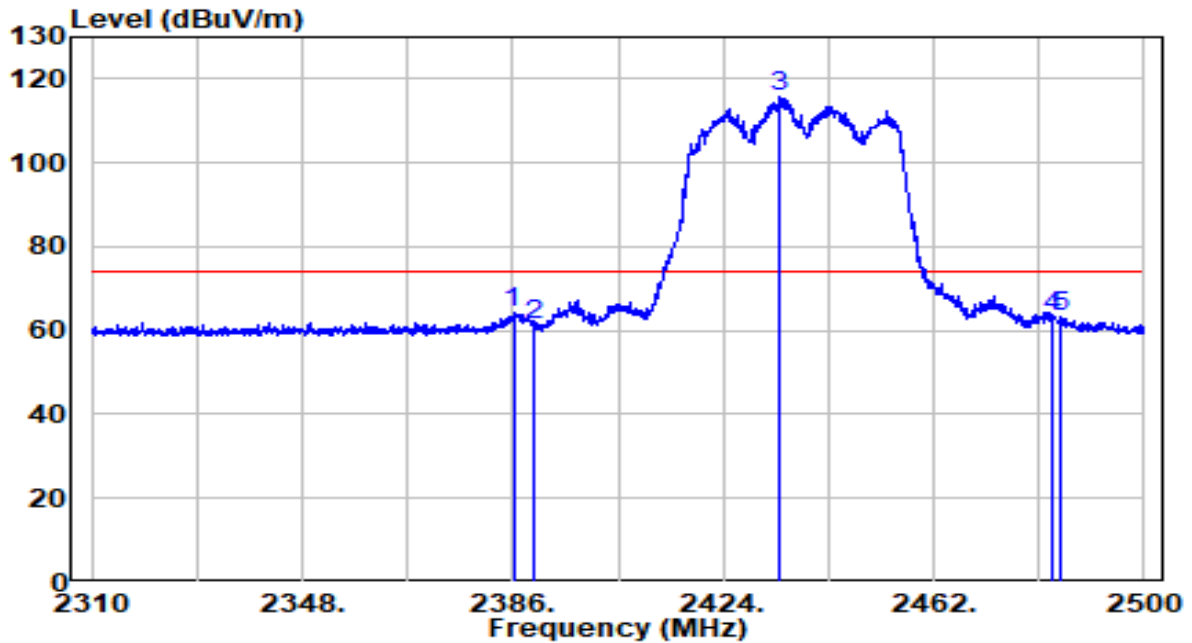

No	Frequency (MHz)	Reading (dBUV)	C.F (dB)	Measurement (dBUV/m)	Margin (dB)	Limit (dBUV/m)	Remark (QP/PK/AV)
1	2386.095	31.77	32.28	64.05	-9.95	74.00	Peak
2	2390.000	29.25	32.30	61.54	-12.46	74.00	Peak
3	* 2434.355	83.48	32.49	115.97	N/A	N/A	Peak
4	2483.500	30.70	32.71	63.41	-10.59	74.00	Peak
5	2484.895	30.51	32.71	63.23	-10.77	74.00	Peak

Note:

- "\*" means this data is the worst emission level.
- C.F (Correction Factor) = Antenna Factor (dB)+ Cable Loss (dB).
- Measurement(dBUV/m) = Reading(dBUV) + C.F (Correction Factor).
- The emission levels of other frequencies are very lower than the limit and not show in test report.

EUT	OAW-AP1301	Date of Test	2020-11-26
Factor	BBHA 9120D	Temp. / Humidity	23.7°C/42%
Polarity	Vertical	Site / Test Engineer	AC1 / Jay Chiu
Test Mode	Transmit by 802.11ax-HE40 at Channel 2437MHz	Test Voltage	120V/60Hz

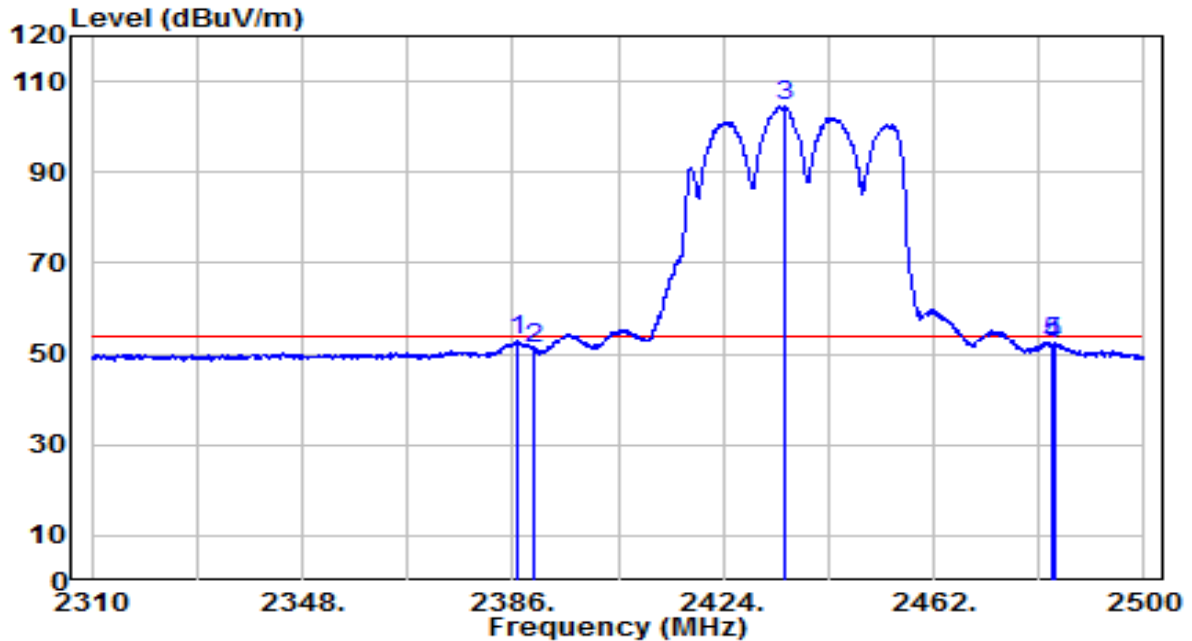

No	Frequency (MHz)	Reading (dBUV)	C.F (dB)	Measurement (dBUV/m)	Margin (dB)	Limit (dBUV/m)	Remark (QP/PK/AV)
1	2387.045	20.67	32.28	52.95	-1.05	54.00	Average
2	2390.000	19.00	32.30	51.30	-2.70	54.00	Average
3	* 2435.210	72.15	32.49	104.64	N/A	N/A	Average
4	2483.470	19.33	32.71	52.04	-1.96	54.00	Average
5	2483.660	19.60	32.71	52.31	-1.69	54.00	Average

Note:

1. " \*", means this data is the worst emission level.
2. C.F (Correction Factor) = Antenna Factor (dB)+ Cable Loss (dB).
3. Measurement(dBUV/m) = Reading(dBUV) + C.F (Correction Factor).
4. The emission levels of other frequencies are very lower than the limit and not show in test report.

EUT	OAW-AP1301	Date of Test	2020-12-18
Factor	BBHA 9120D	Temp. / Humidity	21.2°C/23%
Polarity	Vertical	Site / Test Engineer	AC1 / Jay Chiu
Test Mode	Transmit by 802.11ax-HE40 at Channel 2447MHz	Test Voltage	120V/60Hz

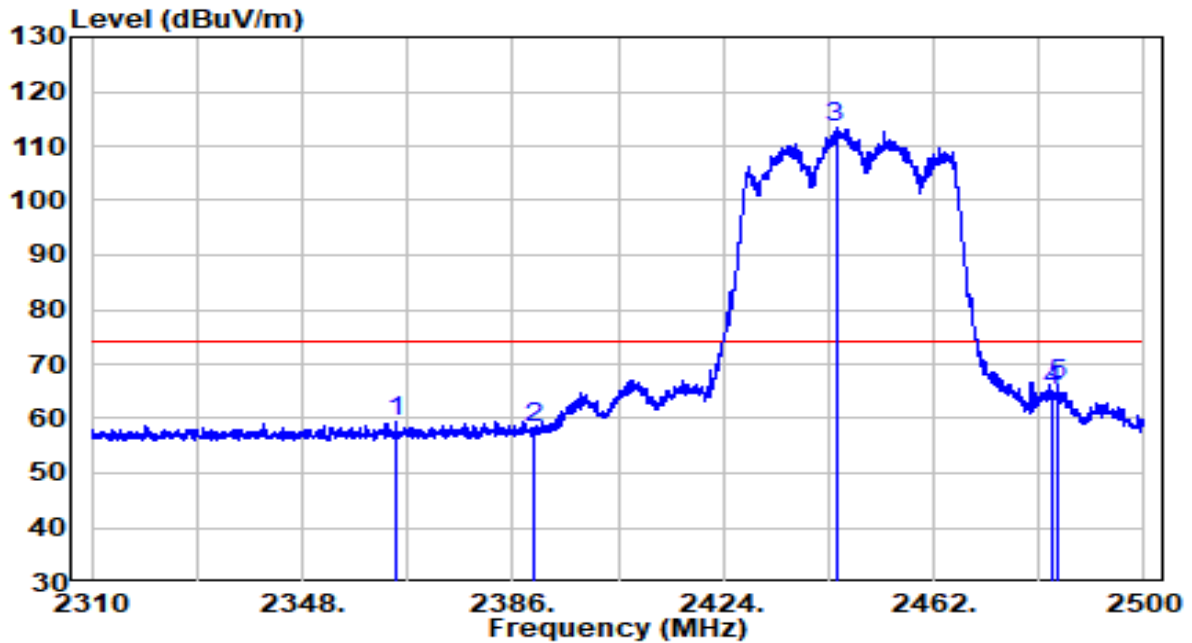

No	Frequency (MHz)	Reading (dBuV)	C.F (dB)	Measurement (dBuV/m)	Margin (dB)	Limit (dBuV/m)	Remark (QP/PK/AV)
1	2365.100	27.20	32.19	59.39	-14.61	74.00	Peak
2	2390.000	26.06	32.30	58.36	-15.64	74.00	Peak
3	* 2444.330	81.01	32.54	113.55	N/A	N/A	Peak
4	2483.500	32.25	32.71	64.95	-9.05	74.00	Peak
5	2484.610	33.69	32.71	66.41	-7.59	74.00	Peak

Note:

- "\*", means this data is the worst emission level.
- C.F (Correction Factor) = Antenna Factor (dB)+ Cable Loss (dB).
- Measurement(dBuV/m) = Reading(dBuV) + C.F (Correction Factor).
- The emission levels of other frequencies are very lower than the limit and not show in test report.

EUT	OAW-AP1301	Date of Test	2020-12-18
Factor	BBHA 9120D	Temp. / Humidity	21.2°C/23%
Polarity	Vertical	Site / Test Engineer	AC1 / Jay Chiu
Test Mode	Transmit by 802.11ax-HE40 at Channel 2447MHz	Test Voltage	120V/60Hz

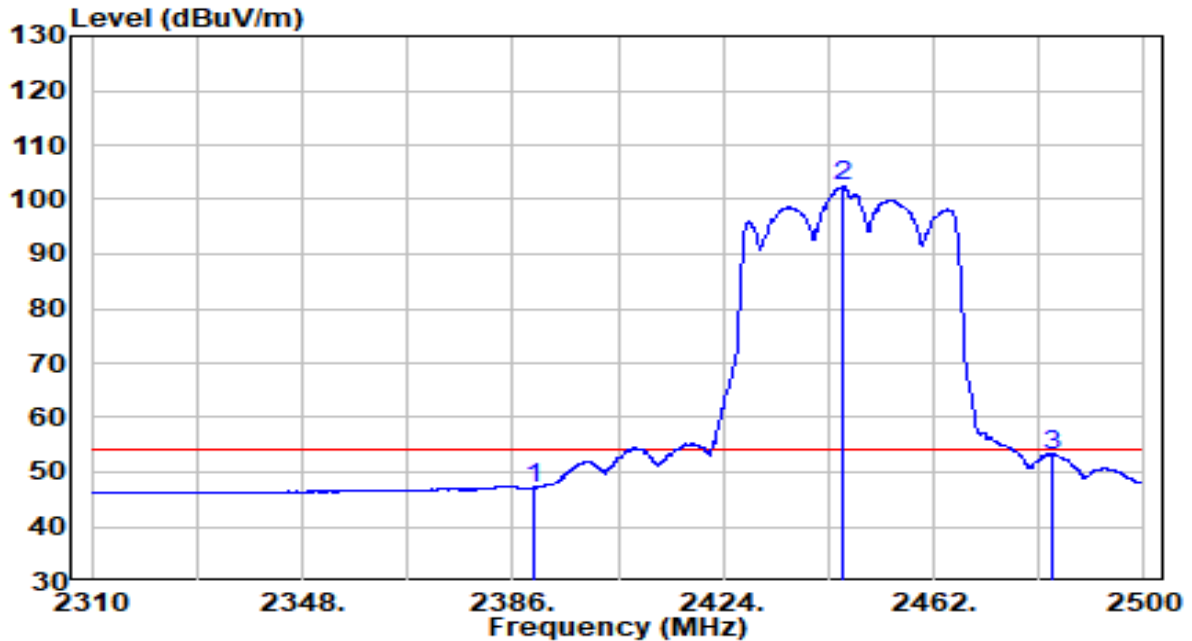

No	Frequency (MHz)	Reading (dBuV)	C.F (dB)	Measurement (dBuV/m)	Margin (dB)	Limit (dBuV/m)	Remark (QP/PK/AV)
1	2390.000	14.87	32.30	47.17	-6.83	54.00	Average
2	* 2445.565	69.85	32.54	102.39	N/A	N/A	Average
3	2483.470	20.44	32.71	53.15	-0.85	54.00	Average

Note:

1. " \*", means this data is the worst emission level.
2. C.F (Correction Factor) = Antenna Factor (dB)+ Cable Loss (dB).
3. Measurement(dBuV/m) = Reading(dBuV) + C.F (Correction Factor).
4. The emission levels of other frequencies are very lower than the limit and not show in test report.

EUT	OAW-AP1301	Date of Test	2020-11-26
Factor	BBHA 9120D	Temp. / Humidity	23.7°C/42%
Polarity	Horizontal	Site / Test Engineer	AC1 / Jay Chiu
Test Mode	Transmit by 802.11ax-HE40 at Channel 2452MHz	Test Voltage	120V/60Hz

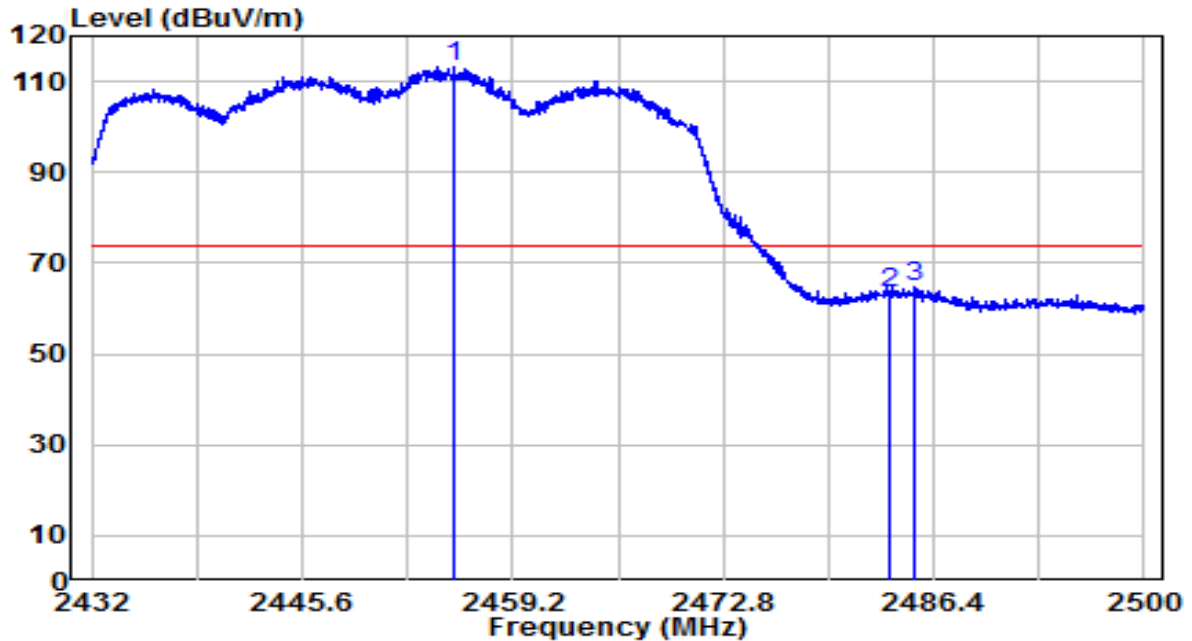

No	Frequency (MHz)	Reading (dBuV)	C.F (dB)	Measurement (dBuV/m)	Margin (dB)	Limit (dBuV/m)	Remark (QP/PK/AV)
1	*	80.71	32.58	113.30	N/A	N/A	Peak
2		30.51	32.71	63.21	-10.79	74.00	Peak
3		32.20	32.71	64.92	-9.08	74.00	Peak

Note:

1. " \*", means this data is the worst emission level.
2. C.F (Correction Factor) = Antenna Factor (dB)+ Cable Loss (dB).
3. Measurement(dBuV/m) = Reading(dBuV) + C.F (Correction Factor).
4. The emission levels of other frequencies are very lower than the limit and not show in test report.



EUT	OAW-AP1301	Date of Test	2020-11-26
Factor	BBHA 9120D	Temp. / Humidity	23.7°C/42%
Polarity	Horizontal	Site / Test Engineer	AC1 / Jay Chiu
Test Mode	Transmit by 802.11ax-HE40 at Channel 2452MHz	Test Voltage	120V/60Hz

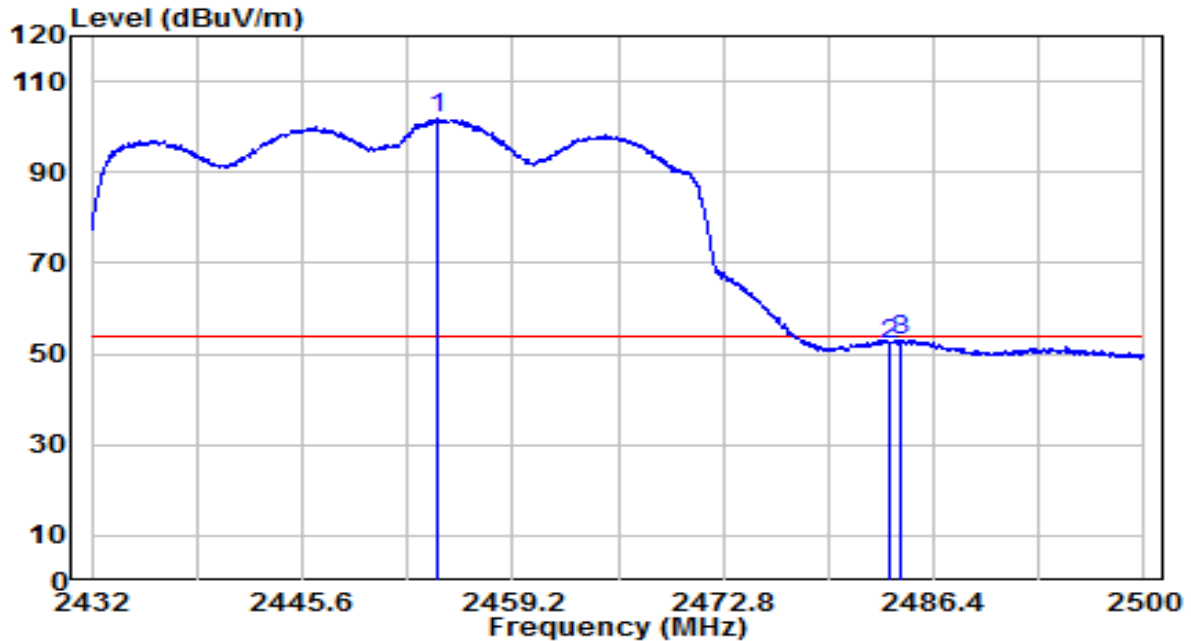

No	Frequency (MHz)	Reading (dBuV)	C.F (dB)	Measurement (dBuV/m)	Margin (dB)	Limit (dBuV/m)	Remark (QP/PK/AV)
1	* 2454.406	69.20	32.58	101.78	N/A	N/A	Average
2	2483.500	19.56	32.71	52.27	-1.73	54.00	Average
3	2484.326	20.37	32.71	53.08	-0.92	54.00	Average

Note:

1. " \*", means this data is the worst emission level.
2. C.F (Correction Factor) = Antenna Factor (dB)+ Cable Loss (dB).
3. Measurement(dBuV/m) = Reading(dBuV) + C.F (Correction Factor).
4. The emission levels of other frequencies are very lower than the limit and not show in test report.

EUT	OAW-AP1301	Date of Test	2020-11-26
Factor	BBHA 9120D	Temp. / Humidity	23.7°C/42%
Polarity	Vertical	Site / Test Engineer	AC1 / Jay Chiu
Test Mode	Transmit by 802.11ax-HE40 at Channel 2452MHz	Test Voltage	120V/60Hz

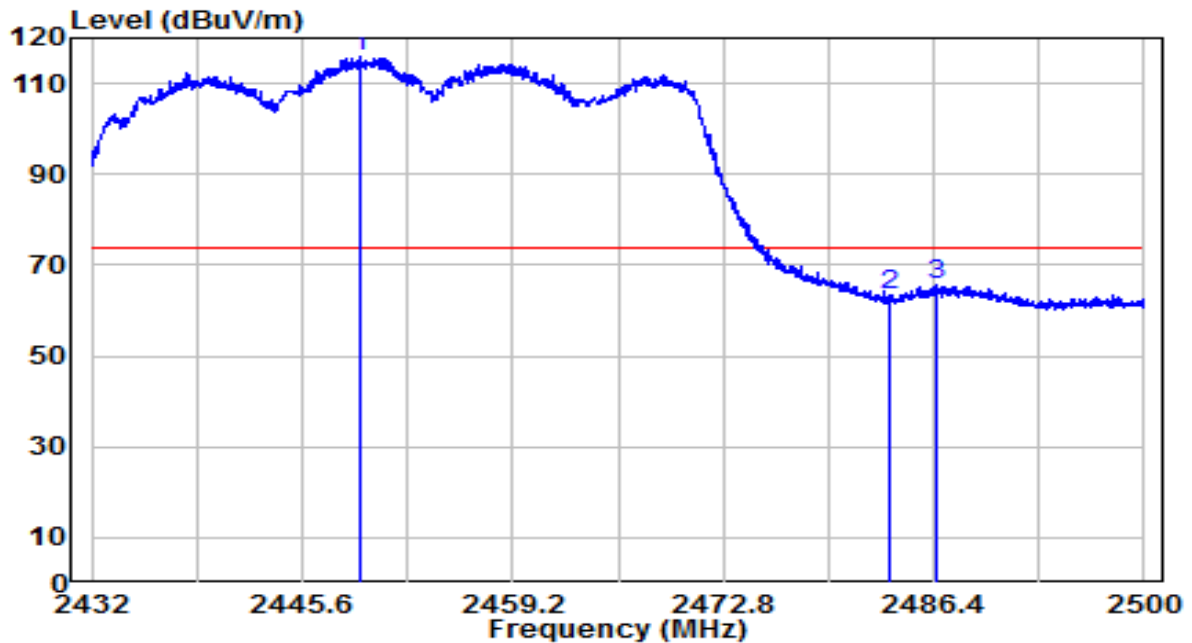

No	Frequency (MHz)	Reading (dBuV)	C.F (dB)	Measurement (dBuV/m)	Margin (dB)	Limit (dBuV/m)	Remark (QP/PK/AV)
1	*	83.37	32.56	115.93	N/A	N/A	Peak
2		30.59	32.71	63.29	-10.71	74.00	Peak
3		32.74	32.72	65.46	-8.54	74.00	Peak

Note:

1. " \*", means this data is the worst emission level.
2. C.F (Correction Factor) = Antenna Factor (dB)+ Cable Loss (dB).
3. Measurement(dBuV/m) = Reading(dBuV) + C.F (Correction Factor).
4. The emission levels of other frequencies are very lower than the limit and not show in test report.

EUT	OAW-AP1301	Date of Test	2020-11-26
Factor	BBHA 9120D	Temp. / Humidity	23.7°C/42%
Polarity	Vertical	Site / Test Engineer	AC1 / Jay Chiu
Test Mode	Transmit by 802.11ax-HE40 at Channel 2452MHz	Test Voltage	120V/60Hz

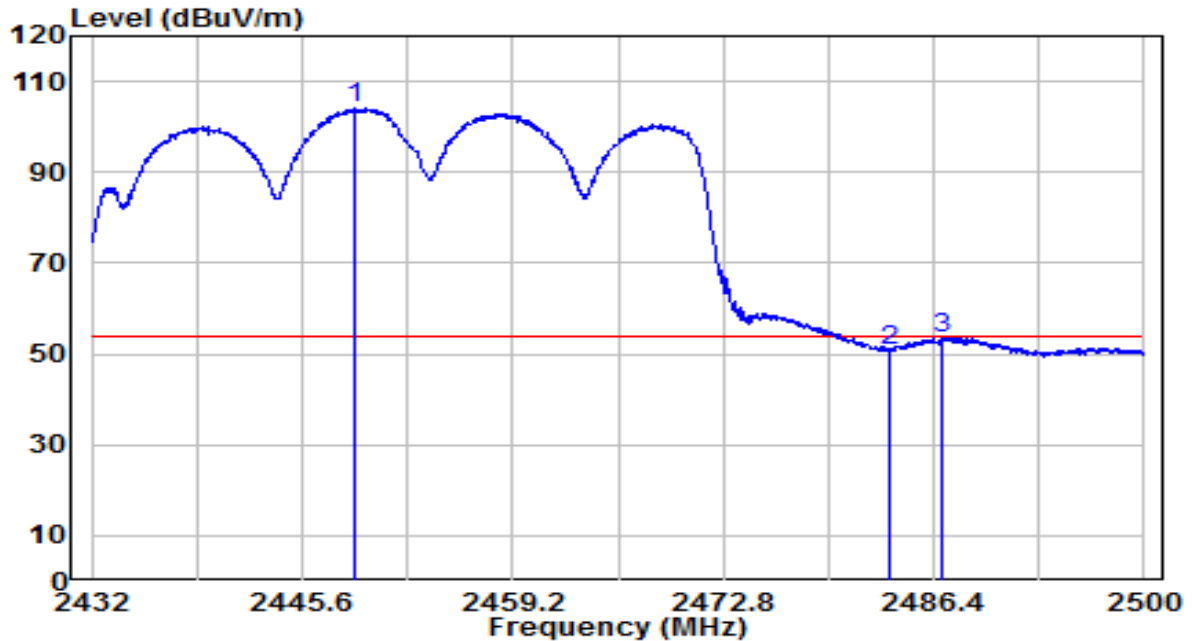

No	Frequency (MHz)	Reading (dBUV)	C.F (dB)	Measurement (dBUV/m)	Margin (dB)	Limit (dBUV/m)	Remark (QP/PK/AV)
1	* 2448.966	71.50	32.56	104.05	N/A	N/A	Average
2	2483.500	18.14	32.71	50.85	-3.15	54.00	Average
3	2487.012	20.86	32.72	53.59	-0.41	54.00	Average

Note:

1. " \*", means this data is the worst emission level.
2. C.F (Correction Factor) = Antenna Factor (dB)+ Cable Loss (dB).
3. Measurement(dBUV/m) = Reading(dBUV) + C.F (Correction Factor).
4. The emission levels of other frequencies are very lower than the limit and not show in test report.

## 6.8. AC Conducted Emissions Measurement

### 6.8.1. Test Limit

FCC Part 15 Subpart C Paragraph 15.207 Limits		
Frequency (MHz)	QP (dBuV)	AV (dBuV)
0.15 ~ 0.50	66 ~ 56	56 ~ 46
0.50 ~ 5.0	56	46
5.0 ~ 30	60	50

Note 1: The lower limit shall apply at the transition frequencies.

Note 2: The limit decreases linearly with the logarithm of the frequency in the range 0.15MHz to 0.5MHz.

### 6.8.2. Test Setup

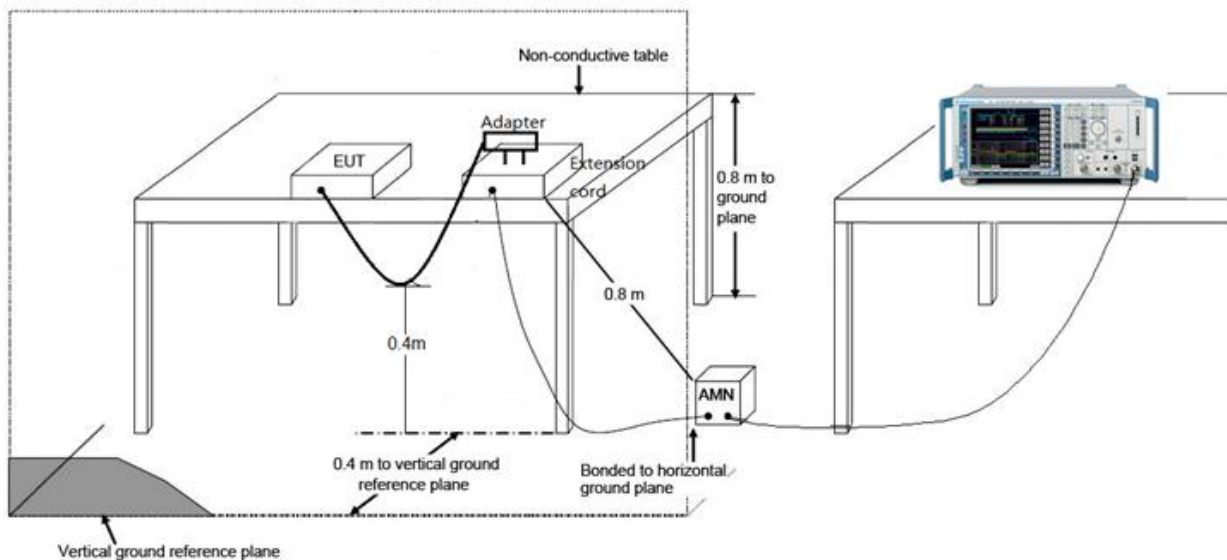

### 6.8.3. Test Result

EUT	OAW-AP1301	Date of Test	2020-11-30
Factor	CE_ENV216-L1 (Filter ON)	Temp. / Humidity	23.2°C /51.6%
Polarity	Line1	Site / Test Engineer	SR2 / Eric Lin
Test Mode	Transmit by 802.11b at channel 2412MHz	Test Voltage	120V/60Hz

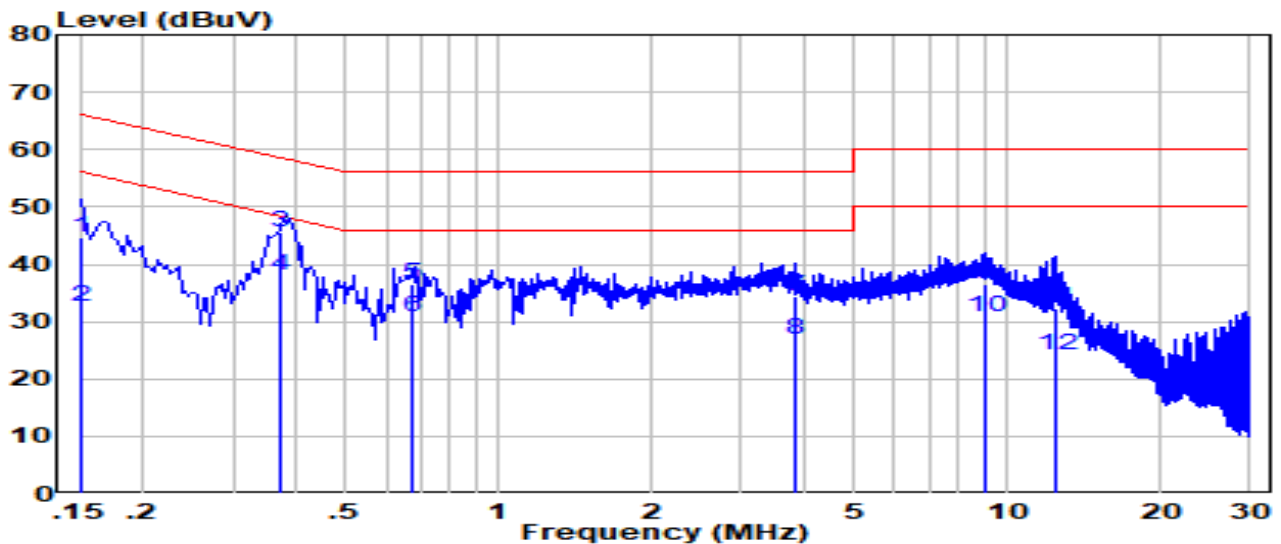

No	Frequency (MHz)	Reading (dBUV)	C.F (dB)	Measurement (dBUV/m)	Margin (dB)	Limit (dBUV/m)	Remark (QP/PK/AV)
1	*	35.05	9.61	44.66	-21.34	66.00	QP
2		22.95	9.61	32.56	-23.44	56.00	AV
3		35.92	9.62	45.54	-12.90	58.43	QP
4		28.32	9.62	37.94	-10.50	48.43	AV
5		26.76	9.64	36.40	-19.60	56.00	QP
6		21.16	9.64	30.80	-15.20	46.00	AV
7		24.61	9.72	34.33	-21.67	56.00	QP
8		17.11	9.72	26.83	-19.17	46.00	AV
9		26.63	9.85	36.49	-23.51	60.00	QP
10		21.03	9.85	30.89	-19.11	50.00	AV
11		22.41	9.90	32.32	-27.68	60.00	QP
12		14.11	9.90	24.02	-25.98	50.00	AV

Note:

1. " \*" , means this data is the worst emission level.
2. C.F (Correction Factor) = LISN Factor (dB)+ Cable Loss (dB).
3. Measurement(dBUV/m) = Reading(dBUV) + C.F (Correction Factor).

EUT	OAW-AP1301	Date of Test	2020-11-30
Factor	CE_ENV216-N (Filter ON)	Temp. / Humidity	23.2°C /51.6%
Polarity	Neutral	Site / Test Engineer	SR2 / Eric Lin
Test Mode	Transmit by 802.11b at channel 2412MHz	Test Voltage	120V/60Hz

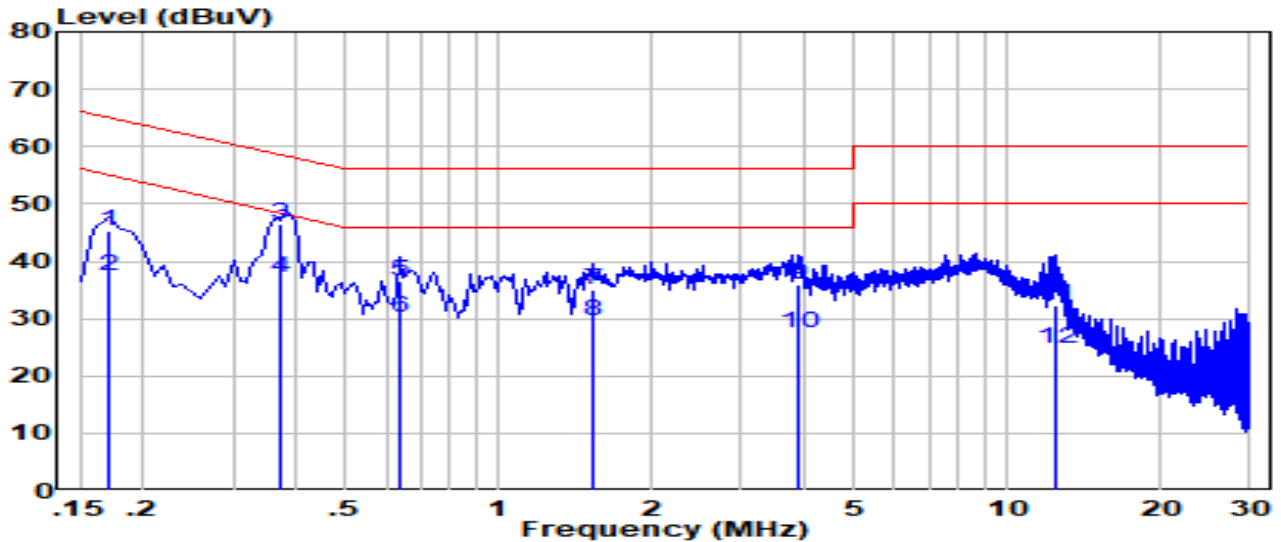

No	Frequency (MHz)	Reading (dBUV)	C.F (dB)	Measurement (dBUV/m)	Margin (dB)	Limit (dBUV/m)	Remark (QP/PK/AV)	
1	0.170	35.81	9.62	45.43	-19.53	64.96	QP	
2	0.170	27.81	9.62	37.43	-17.53	54.96	AV	
3	0.370	36.82	9.63	46.46	-12.04	58.50	QP	
4	*	0.370	27.52	9.63	37.16	-11.34	48.50	AV
5	0.640	26.92	9.65	36.57	-19.43	56.00	QP	
6	0.640	20.67	9.65	30.32	-15.68	46.00	AV	
7	1.530	25.27	9.68	34.95	-21.05	56.00	QP	
8	1.530	19.77	9.68	29.45	-16.55	46.00	AV	
9	3.860	26.23	9.73	35.96	-20.04	56.00	QP	
10	3.860	17.63	9.73	27.36	-18.64	46.00	AV	
11	12.410	22.46	9.93	32.39	-27.61	60.00	QP	
12	12.410	14.96	9.93	24.89	-25.11	50.00	AV	

Note:

1. " \*", means this data is the worst emission level.
2. C.F (Correction Factor) = LISN (dB)+ Cable Loss (dB).
3. Measurement(dBUV/m) = Reading(dBUV) + C.F (Correction Factor).

## 7. CONCLUSION

The data collected relate only the item(s) tested and show that the unit is compliance with Part 15C of the FCC rules.

————— The End —————

## **Appendix A - Test Setup Photograph**

Refer to "2010TW0002-UT" file.



## **Appendix B - EUT Photograph**

Refer to "2010TW0002-UE" file.