

MEASUREMENT REPORT

FCC Part 15B/ICES-003

Applicant: ALE USA Inc.
Address: 26801 West Agoura Road, Calabasas, CA 91301, United States
Product: OmniAccess Stellar
Model No.: OAW-AP1311, OAW-AP1301
Brand Name: Alcatel-Lucent Enterprise
FCC Rule Part(s): FCC Part 15 Subpart B: 2020 Class B
ISED Rule Part(s): ICES-003 Issue 7 Class B
Test Procedure(s): ANSI C63.4: 2014
Result: Complies
Test Date: September 02 ~ December 04, 2020

Reviewed By:

Oscar Shi

(Oscar Shi)

Approved By:

Robin Wu

(Robin Wu)



The test results relate only to the samples tested.

This equipment has been shown to be capable of compliance with the applicable technical standards as indicated in the measurement report and was tested in accordance with the measurement procedures specified in ANSI C63.4-2014. Test results reported herein relate only to the item(s) tested.

The test report shall not be reproduced except in full without the written approval of MRT Technology (Suzhou) Co., Ltd.

Revision History

Report No.	Version	Description	Issue Date	Note
2008RSU054-U2	Rev. 01	Initial Report	12-05-2020	Invalid
2008RSU054-U2	Rev.02	Add Mode 3&4 for OAW-AP1301	12-08-2020	Valid

CONTENTS

Description	Page
1. General Information.....	4
1.1. Applicant.....	4
1.2. Manufacturer	4
1.3. Testing Facility.....	4
2. PRODUCT INFORMATION	5
2.1. Equipment Description.....	5
2.2. Test Mode	5
2.3. Configuration of Tested System.....	6
2.4. Test System Details.....	8
2.5. Test Procedure	8
2.6. EMI Suppression Device(s)/Modifications	8
3. TEST EQUIPMENT CALIBRATION DATE	9
4. MEASUREMENT UNCERTAINTY.....	12
5. TEST RESULT	13
5.1. Summary	13
5.2. Conducted Emission Measurement	14
5.2.1. Test Limit	14
5.2.2. Test Setup.....	14
5.2.3. Test Result of Conducted Emissions.....	15
5.3. Radiated Emission Measurement	23
5.3.1. Test Limit	23
5.3.2. Test Setup.....	24
5.3.3. Test Result of Radiated Emissions.....	25
6. CONCLUSION.....	41
Appendix A - Test Setup Photograph	42
Appendix B - EUT Photograph.....	43

2. PRODUCT INFORMATION

2.1. Equipment Description

Product Name	OmniAccess Stellar
Model No.:	OAW-AP1311, OAW-AP1301
Brand Name	Alcatel-Lucent Enterprise
Wi-Fi Specification	802.11a/b/g/n/ac/ax
Operating Temperature:	0 ~ 50 °C
Power Type:	PoE input or AC adapter input (100 - 240VAC ~ 50/60Hz, 1.0A Output Power: 48VDC/0.66A)
Operating Environment:	Indoor Use

Note: PoE and AC adapter not sold with product.

2.2. Test Mode

Test Mode
Mode 1: Power EUT (OAW-AP1311) by AC Adapter & Communicate with Notebook by LAN Cable and Wi-Fi & Communicate with mobile phone by Wi-Fi and Bluetooth & USB Copy via command & RS485 PSE 12V Output.
Mode 2: Power EUT (OAW-AP1311) By PoE & Communicate with Notebook by LAN Cable and Wi-Fi & Communicate with mobile phone by Wi-Fi and Bluetooth & USB Copy via command & RS485 PSE 12V Output.
Mode 3: Power EUT (OAW-AP1301) by AC Adapter & Communicate with Notebook by LAN Cable and Wi-Fi & Communicate with mobile phone by Wi-Fi & USB Copy via command.
Mode 4: Power EUT (OAW-AP1301) By PoE & Communicate with Notebook by LAN Cable and Wi-Fi & Communicate with mobile phone by Wi-Fi & USB Copy via command.

2.3. Configuration of Tested System

This device was tested per the guidance ANSI C63.4:2014 was used to reference the appropriate EUT setup for radiated emissions testing and AC line conducted testing.

Connection Diagram (Mode 1)

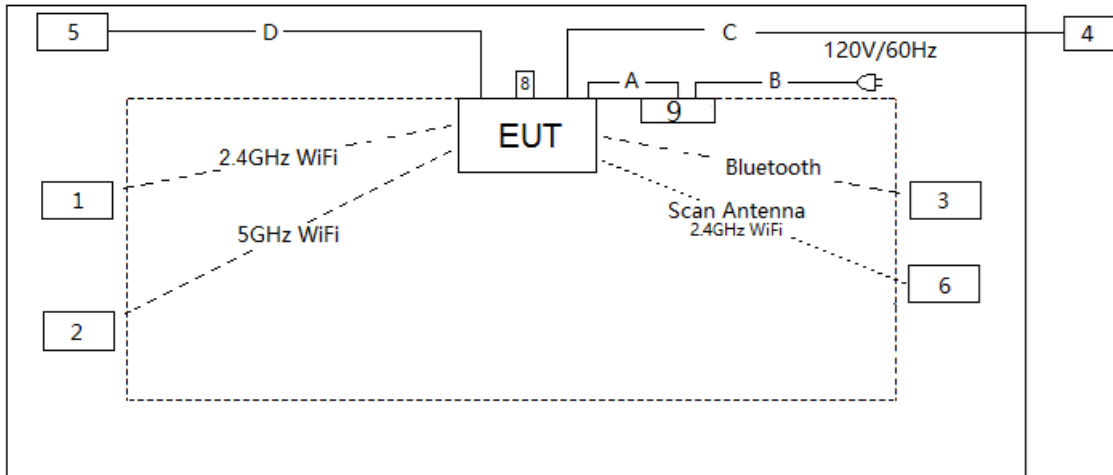

Connection Diagram (Mode 2)

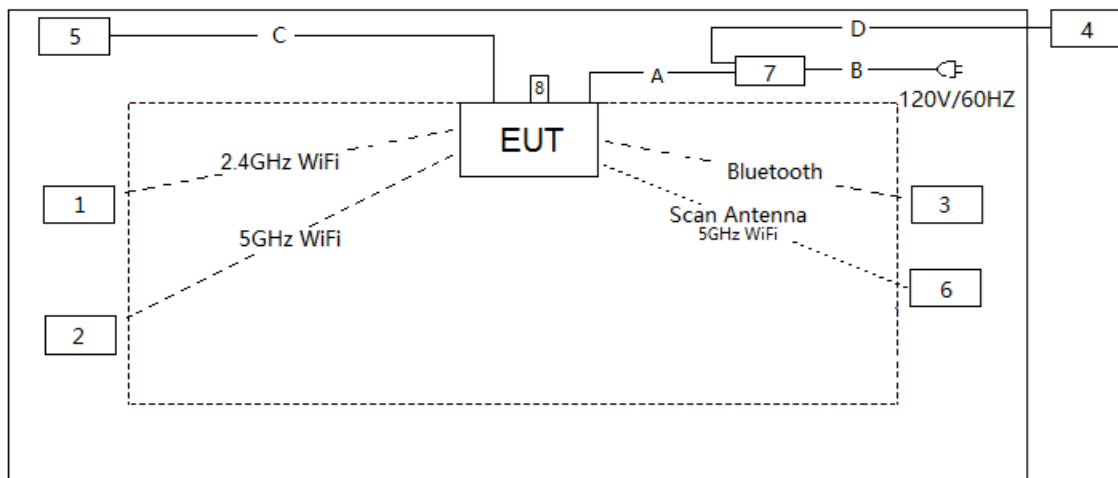

Connection Diagram (Mode 3)

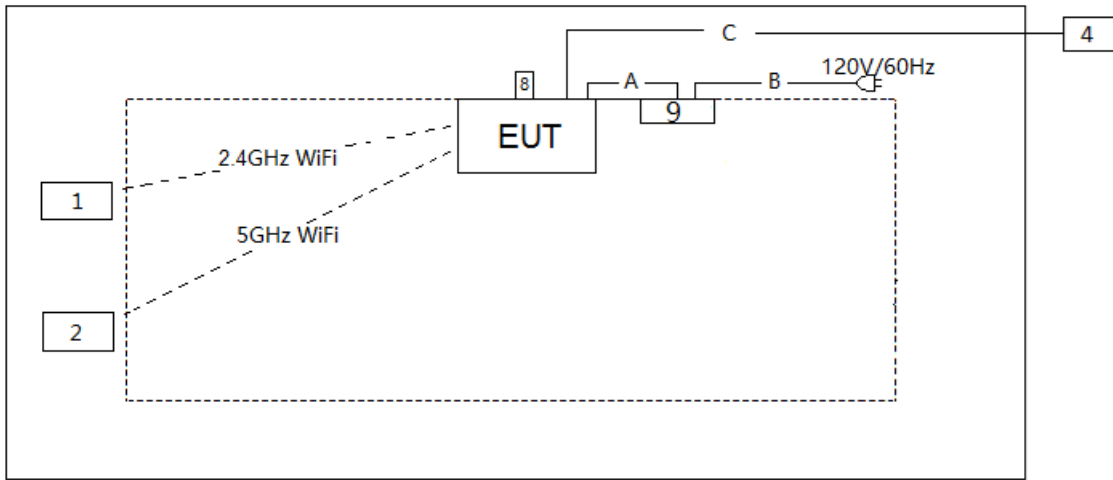

Connection Diagram (Mode 4)

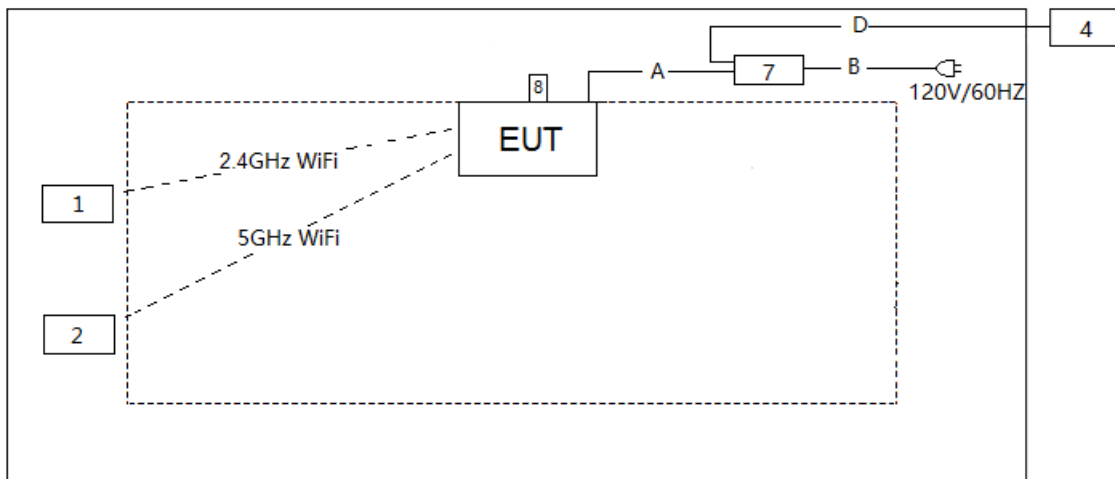

Cable Type		Cable Description
A	Power Cable	Non-Shielding, 1.5m
B	Power Cable	Non-Shielding, 1.5m
C	LAN Cable	Non-Shielding, >10m
D	LAN Cable	Non-Shielding, >10m

2.4. Test System Details

The types for all equipments, plus descriptions of all cables used in the tested system (including inserted cards) are:

Product	Manufacturer	Model No.	Serial No.	Power Cord
1 Notebook	Lenovo	E430c	MP-4CFX213/10	Non-Shielded, 1.8m
2 iPhone	Apple	ML7E2CH/A	C6KR9BR2GRY	N/A
3 Mobile Phone	OPPO	X9009	N/A	N/A
4 Notebook	ASUS	PRO45V	N/A	Non-Shielded, 1.8m
5 Notebook	Lenovo	E431	PF-10ZRN 13/12	Non-Shielded, 1.8m
6 Mobile Phone	HUAWEI	M836	N/A	N/A
7 PoE	Microsemi	PD-9001-25GR/AT/AC	C19456582000002321	Non-Shielded, 1.8m
8 USB Dongle	SanDisk	BL161025264V	N/A	N/A
9 AC Adapter	DELTA	ADP-30HR B	1WMD05S00T5	Non-Shielded, 1.8m

2.5. Test Procedure

1	Setup the EUT and simulators as shown on above.
2	<p>Mode 1: Power EUT (OAW-AP1311) by AC Adapter & Communicate with Notebook by LAN Cable and Wi-Fi & Communicate with mobile phone by Wi-Fi and Bluetooth & USB Copy via command & RS485 PSE 12V Output.</p> <p>Mode 2: Power EUT (OAW-AP1311) By PoE & Communicate with Notebook by LAN Cable and Wi-Fi & Communicate with mobile phone by Wi-Fi and Bluetooth & USB Copy via command & RS485 PSE 12V Output.</p> <p>Mode 3: Power EUT (OAW-AP1301) by AC Adapter & Communicate with Notebook by LAN Cable and Wi-Fi & Communicate with mobile phone by Wi-Fi & USB Copy via command.</p> <p>Mode 4: Power EUT (OAW-AP1301) By PoE & Communicate with Notebook by LAN Cable and Wi-Fi & Communicate with mobile phone by Wi-Fi & USB Copy via command.</p>
3	Begin to test.

2.6. EMI Suppression Device(s)/Modifications

No EMI suppression device(s) were added and/or no modifications were made during testing.

3. TEST EQUIPMENT CALIBRATION DATE

Conducted Emission – WZ-SR2

Instrument	Manufacturer	Type No.	Asset No.	Cali. Interval	Cali. Due Date
EMI Test Receiver	R&S	ESR3	MRTSUE06185	1 year	2021/01/18
Two-Line V-Network	R&S	ENV216	MRTSUE06002	1 year	2021/06/11
Four-Line V-Network	R&S	ENV432	MRTSUE06615	1 year	2021/11/10
Impedance Stabilization Network	TESEQ	ISN T200A	MRTSUE06004	1 year	2021/01/04
Impedance Stabilization Network	TESEQ	ISN T800	MRTSUE06005	1 year	2021/01/04
Impedance Stabilization Network	TESEQ	ISN T8-CAT6	MRTSUE06006	1 year	2021/01/04
V-Network	R&S	ESH3-Z6	MRTSUE06187	1 year	2021/04/14
V-Network	R&S	ESH3-Z6	MRTSUE06188	1 year	2021/04/14
RF Current Probe	R&S	EZ-17	MRTSUE06190	1 year	2021/04/14
Thermal Hygrometer	testo	608-H1	MRTSUE06404	1 year	2021/07/26

Conducted Emission - SIP-SR2

Instrument	Manufacturer	Type No.	Asset No.	Cali. Interval	Cali. Due Date
EMI Test Receiver	R&S	ESR3	MRTSUE06613	1 year	2021/07/02
Two-Line V-Network	R&S	ENV216	MRTSUE06003	1 year	2021/06/11
Four-Line V-Network	R&S	ENV432	MRTSUE06614	1 year	2021/11/10
Impedance Stabilization Network	R&S	ENY81	MRTSUE06608	1 year	2021/08/26
Impedance Stabilization Network	R&S	ENY81-CA6	MRTSUE06609	1 year	2021/08/26
V-Network	R&S	ESH3-Z6	MRTSUE06187	1 year	2021/04/14
V-Network	R&S	ESH3-Z6	MRTSUE06188	1 year	2021/04/14
RF Current Probe	R&S	EZ-17	MRTSUE06190	1 year	2021/04/14
Thermal Hygrometer	testo	608-H1	MRTSUE06621	1 year	2020/12/29

Radiated Emission – WZ-AC1

Instrument	Manufacturer	Type No.	Asset No.	Cali. Interval	Cali. Due Date
EMI Test Receiver	R&S	ESR7	MRTSUE06001	1 year	2021/01/18
EXA Signal Analyzer	Keysight	N9010B	MRTSUE06558	1 year	2021/07/23
Bilog Period Antenna	Schwarzbeck	VULB 9168	MRTSUE06172	1 year	2021/04/03
Horn Antenna	Schwarzbeck	BBHA 9120D	MRTSUE06023	1 year	2021/09/27
Microwave System Amplifier	Agilent	83017A	MRTSUE06076	1 year	2021/11/14
Thermal Hygrometer	testo	608-H1	MRTSUE06403	1 year	2021/07/26
Anechoic Chamber	TDK	Chamber-AC1	MRTSUE06212	1 year	2021/04/30

Radiated Emission – WZ-AC2

Instrument	Manufacturer	Type No.	Asset No.	Cali. Interval	Cali. Due Date
MXE EMI Receiver	Keysight	N9038A	MRTSUE06125	1 year	2021/07/02
Bilog Period Antenna	Schwarzbeck	VULB 9162	MRTSUE06022	1 year	2021/05/26
Broad-Band Horn Antenna	Schwarzbeck	BBHA 9120D	MRTSUE06171	1 year	2021/10/26
Broadband Coaxial Preamplifier	Schwarzbeck	BBV 9718	MRTSUE06176	1 year	2021/11/14
Thermal Hygrometer	Minggao	ETH529	MRTSUE06170	1 year	2021/12/08
Anechoic Chamber	RIKEN	Chamber-AC2	MRTSUE06213	1 year	2021/04/30

Radiated Emission - SIP-AC1

Instrument	Manufacturer	Type No.	Asset No.	Cali. Interval	Cali. Due Date
EMI Test Receiver	R&S	ESR3	MRTSUE06612	1 year	2021/07/02
EXA Signal Analyzer	Keysight	N9010B	MRTSUE06559	1 year	2021/07/23
Bilog Period Antenna	Schwarzbeck	VULB9168	MRTSUE06645	1 year	2021/12/08
Double Ridged Horn Antenna	R&S	HF907	MRTSUE06610	1 year	2021/08/30
Preamplifier	EMCI	EMC051845SE	MRTSUE06600	1 year	2021/11/12
Thermal Hygrometer	testo	608-H1	MRTSUE06620	1 year	2020/12/29
Anechoic Chamber	RIKEN	SIP-AC1	MRTSUE06554	1 year	2020/12/25

Radiated Emission - SIP-AC2

Instrument	Manufacturer	Type No.	Asset No.	Cali. Interval	Cali. Due Date
EMI Test Receiver	R&S	ESR3	MRTSUE06613	1 year	2021/07/02
MXA Signal Analyzer	Keysight	N9020B	MRTSUE06604	1 year	2021/09/26
Bilog Period Antenna	Schwarzbeck	VULB9168	MRTSUE06646	1 year	2021/08/30
Horn Antenna	Schwarzbeck	BBHA9120D	MRTSUE06648	1 year	2021/11/26
Preamplifier	EMCI	EMC051845SE	MRTSUE06644	1 year	2021/09/26
Thermal Hygrometer	testo	608-H1	MRTSUE06624	1 year	2020/12/29
Anechoic Chamber	RIKEN	SIP-AC2	MRTSUE06781	1 year	2020/12/25

Radiated Emission - SIP-AC3

Instrument	Manufacturer	Type No.	Asset No.	Cali. Interval	Cali. Due Date
EMI Test Receiver	R&S	ESR3	MRTSUE06612	1 year	2021/07/02
EXA Signal Analyzer	Keysight	N9010B	MRTSUE06559	1 year	2021/07/23
Bilog Period Antenna	Schwarzbeck	VULB9168	MRTSUE06647	1 year	2021/08/30
Double Ridged Horn Antenna	R&S	HF907	MRTSUE06611	1 year	2021/09/13
Preamplifier	EMCI	EMC012645SE	MRTSUE06642	1 year	2021/01/16
Thermal Hygrometer	testo	608-H1	MRTSUE06622	1 year	2020/12/29
Anechoic Chamber	RIKEN	SIP-AC3	MRTSUE06782	1 year	2020/12/25

Software	Version	Function
EMI Software	V3	EMI Test Software

4. MEASUREMENT UNCERTAINTY

Where relevant, the following test uncertainty levels have been estimated for tests performed on the EUT as specified in CISPR 16-4-2. This uncertainty represents an expanded uncertainty expressed at approximately the 95% confidence level using a coverage factor of $k = 2$.

Conducted Emission Measurement

The maximum measurement uncertainty is evaluated as:

9kHz~150kHz: 3.74dB

150kHz~30MHz: 3.44dB

Radiated Emission Measurement

The maximum measurement uncertainty is evaluated as:

Horizontal: 30MHz~300MHz: 5.04dB

300MHz~1GHz: 4.95dB

1GHz~6GHz: 6.40dB

Vertical: 30MHz~300MHz: 5.24dB

300MHz~1GHz: 6.03dB

1GHz~40GHz: 6.40dB

5. TEST RESULT

5.1. Summary

FCC Part Section(s)	ISED Part Section(s)	Test Description	Test Result
15.107	3.2.1	Conducted Emissions	Pass
15.109	3.2.2	Radiated Emissions	Pass

5.2. Conducted Emission Measurement

5.2.1. Test Limit

FCC Part 15.107 / ICES-003 Issue 7 Limit		
Frequency (MHz)	QP (dB μ V)	AV (dB μ V)
0.15 ~ 0.50	66 ~ 56	56 ~ 46
0.50 ~ 5.0	56	46
5.0 ~ 30	60	50

Note 1: The lower limit shall apply at the transition frequencies.

Note 2: The limit decreases linearly with the logarithm of the frequency in the range 0.15MHz to 0.5MHz.

5.2.2. Test Setup

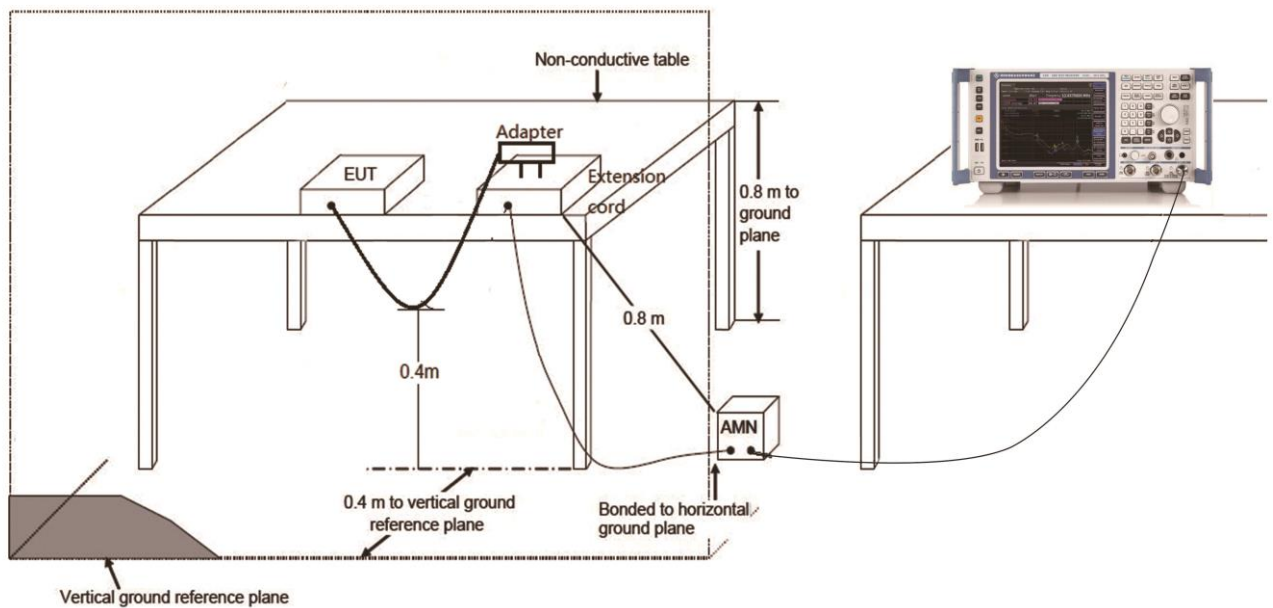

5.2.3. Test Result of Conducted Emissions

Site: WZ-SR2	Time: 2020/09/02
Limit: FCC_Part15.107_CE_AC Power _ Class B	Engineer: Linda Wei
Probe: ENV216_101683_Filter On	Polarity: Line
EUT: OAW-AP1311	Power: AC 120V/60Hz
Test Mode 1	

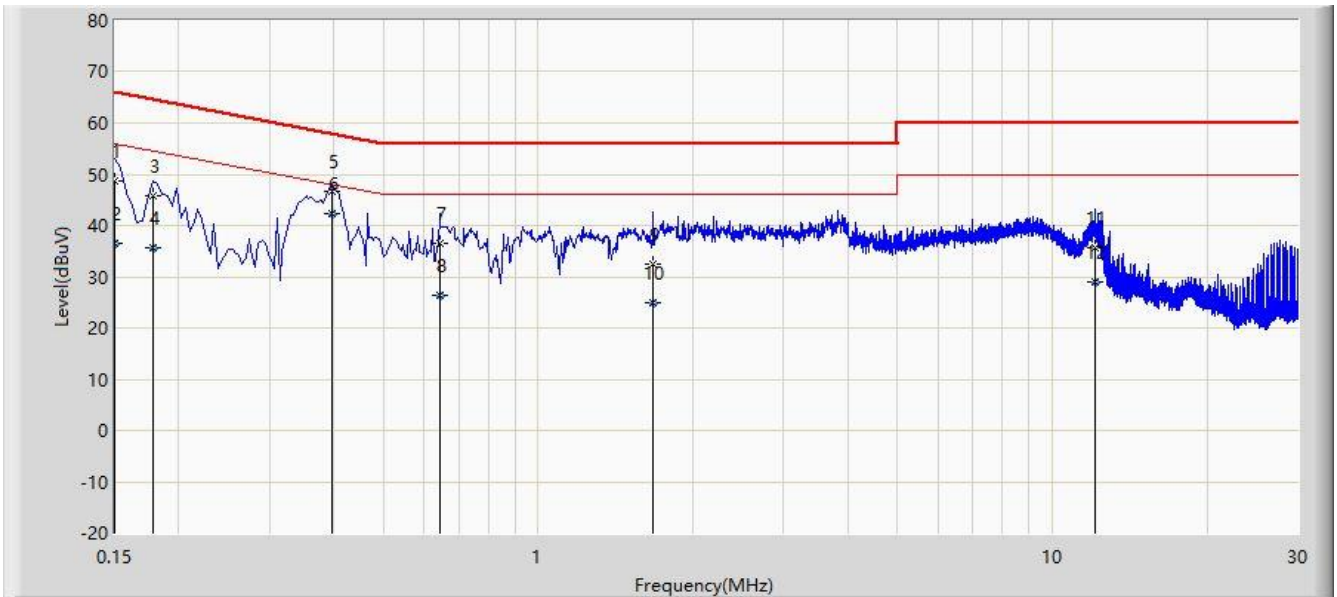

No	Flag	Mark	Frequency (MHz)	Measure Level (dBμV)	Reading Level (dBμV)	Margin (dB)	Limit (dBμV)	Factor	Type
1			0.150	48.675	39.062	-17.325	66.000	9.613	QP
2			0.150	36.663	27.050	-19.337	56.000	9.613	AV
3			0.178	45.795	36.167	-18.784	64.578	9.628	QP
4			0.178	35.722	26.094	-18.857	54.578	9.628	AV
5			0.398	46.787	37.109	-11.108	57.895	9.678	QP
6		*	0.398	42.412	32.735	-5.483	47.895	9.678	AV
7			0.642	36.460	26.744	-19.540	56.000	9.716	QP
8			0.642	26.250	16.533	-19.750	46.000	9.716	AV
9			1.674	32.584	22.826	-23.416	56.000	9.758	QP
10			1.674	24.906	15.148	-21.094	46.000	9.758	AV
11			12.142	35.590	25.488	-24.410	60.000	10.102	QP
12			12.142	28.936	18.834	-21.064	50.000	10.102	AV

Note: Measure Level (dBμV) = Reading Level (dBμV) + Factor (dB)

Factor (dB) = Cable Loss (dB) + LISN Factor (dB).

Site: WZ-SR2	Time: 2020/09/02
Limit: FCC_Part15.107_CE_AC Power _ Class B	Engineer: Linda Wei
Probe: ENV216_101683_Filter On	Polarity: Neutral
EUT: OAW-AP1311	Power: AC 120V/60Hz
Test Mode 1	

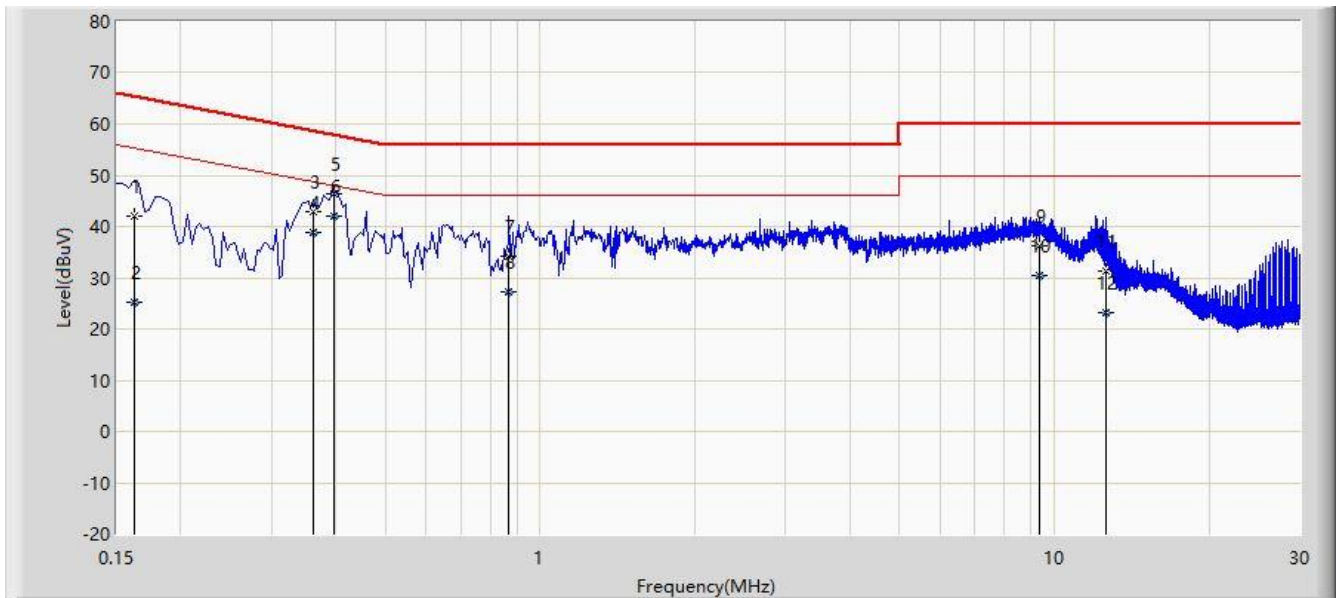

No	Flag	Mark	Frequency (MHz)	Measure Level (dBuV)	Reading Level (dBuV)	Margin (dB)	Limit (dBuV)	Factor	Type
1			0.162	42.145	32.536	-23.216	65.361	9.609	QP
2			0.162	25.120	15.511	-30.241	55.361	9.609	AV
3			0.362	42.803	33.142	-15.880	58.682	9.660	QP
4			0.362	38.851	29.191	-9.831	48.682	9.660	AV
5			0.398	46.391	36.723	-11.504	57.895	9.668	QP
6		*	0.398	42.081	32.413	-5.814	47.895	9.668	AV
7			0.870	34.162	24.432	-21.838	56.000	9.729	QP
8			0.870	27.107	17.378	-18.893	46.000	9.729	AV
9			9.350	36.253	26.223	-23.747	60.000	10.030	QP
10			9.350	30.554	20.524	-19.446	50.000	10.030	AV
11			12.634	31.373	21.252	-28.627	60.000	10.121	QP
12			12.634	23.175	13.054	-26.825	50.000	10.121	AV

Note: Measure Level (dB μ V) = Reading Level (dB μ V) + Factor (dB)

Factor (dB) = Cable Loss (dB) + LISN Factor (dB).

Site: WZ-SR2	Time: 2020/09/02
Limit: FCC_Part15.107_CE_AC Power _ Class B	Engineer: Linda Wei
Probe: ENV216_101683_Filter On	Polarity: Line
EUT: OAW-AP1311	Power: By PoE
Test Mode 2	

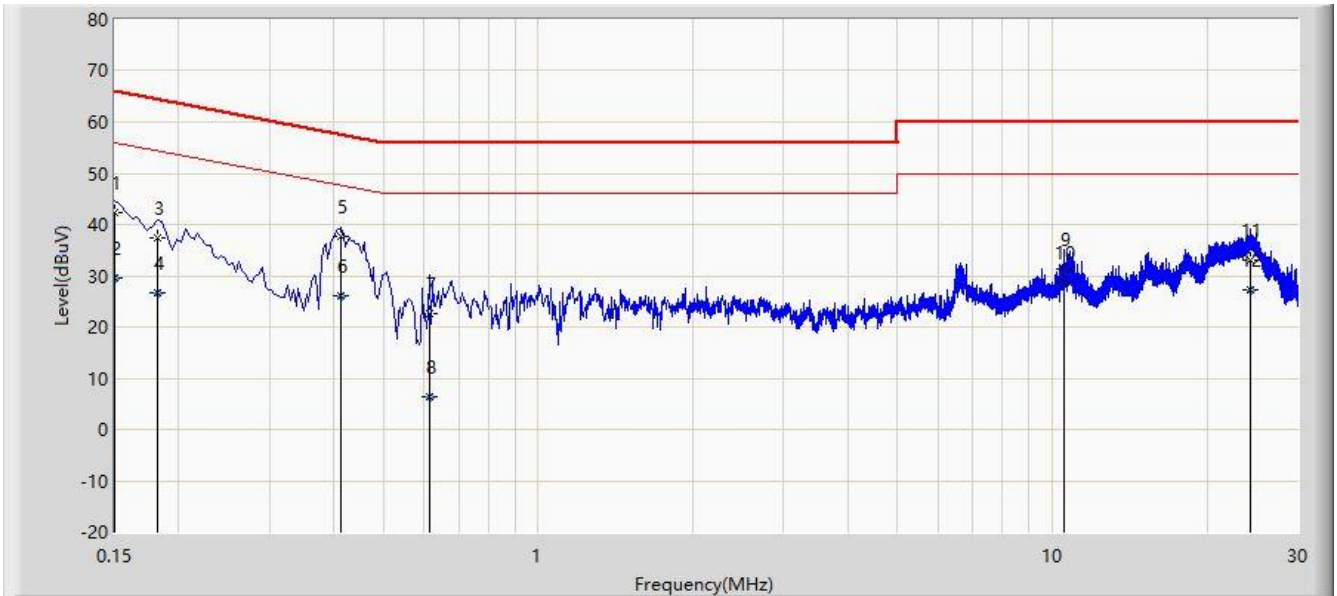

No	Flag	Mark	Frequency (MHz)	Measure Level (dBuV)	Reading Level (dBuV)	Margin (dB)	Limit (dBuV)	Factor	Type
1			0.150	42.449	32.836	-23.551	66.000	9.613	QP
2			0.150	29.549	19.935	-26.451	56.000	9.613	AV
3			0.182	37.470	27.841	-26.924	64.394	9.630	QP
4			0.182	26.591	16.961	-27.803	54.394	9.630	AV
5		*	0.414	37.549	27.869	-20.018	57.568	9.681	QP
6			0.414	25.998	16.317	-21.570	47.568	9.681	AV
7			0.614	22.550	12.838	-33.450	56.000	9.713	QP
8			0.614	6.282	-3.430	-39.718	46.000	9.713	AV
9			10.538	31.256	21.193	-28.744	60.000	10.063	QP
10			10.538	28.559	18.496	-21.441	50.000	10.063	AV
11			24.346	33.107	22.699	-26.893	60.000	10.408	QP
12			24.346	27.355	16.947	-22.645	50.000	10.408	AV

Note: Measure Level (dB μ V) = Reading Level (dB μ V) + Factor (dB)

Factor (dB) = Cable Loss (dB) + LISN Factor (dB).

Site: WZ-SR2	Time: 2020/09/02
Limit: FCC_Part15.107_CE_AC Power _ Class B	Engineer: Linda Wei
Probe: ENV216_101683_Filter On	Polarity: Neutral
EUT: OAW-AP1311	Power: By PoE
Test Mode 2	

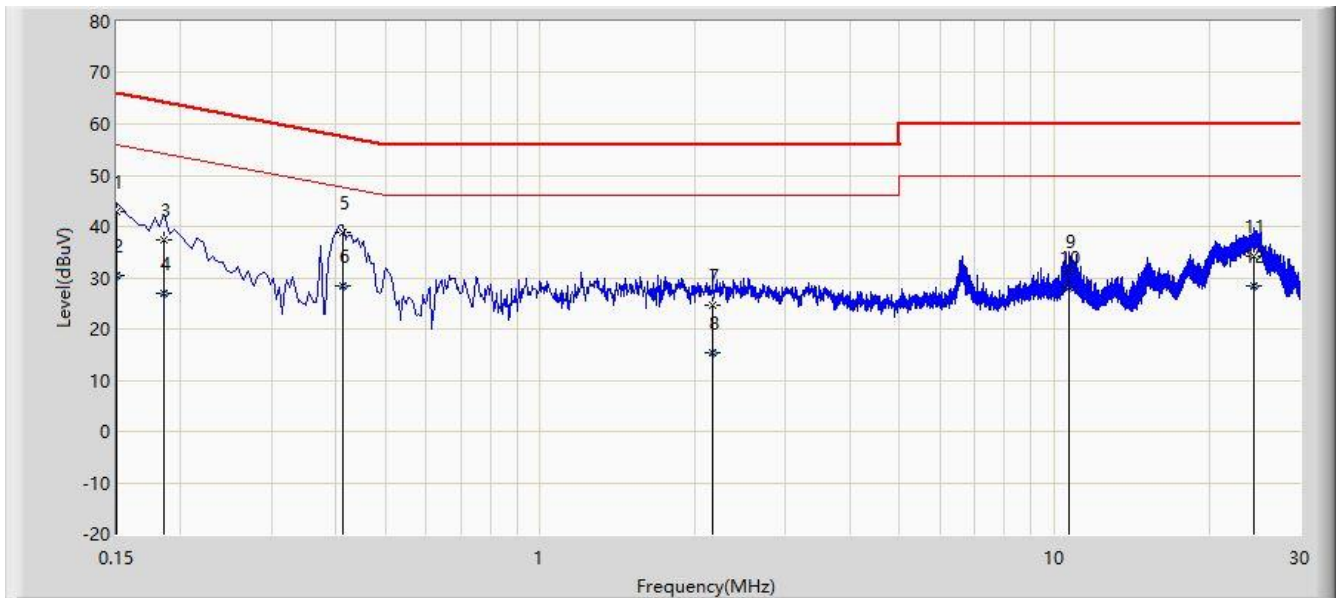

No	Flag	Mark	Frequency (MHz)	Measure Level (dBuV)	Reading Level (dBuV)	Margin (dB)	Limit (dBuV)	Factor	Type
1			0.150	42.890	33.287	-23.110	66.000	9.603	QP
2			0.150	30.360	20.757	-25.640	56.000	9.603	AV
3			0.186	37.463	27.841	-26.751	64.213	9.622	QP
4			0.186	26.840	17.219	-27.373	54.213	9.622	AV
5		*	0.414	38.756	29.085	-18.812	57.568	9.671	QP
6			0.414	28.428	18.757	-19.140	47.568	9.671	AV
7			2.162	24.623	14.857	-31.377	56.000	9.766	QP
8			2.162	15.498	5.732	-30.502	46.000	9.766	AV
9			10.646	31.190	21.125	-28.810	60.000	10.066	QP
10			10.646	28.226	18.160	-21.774	50.000	10.066	AV
11			24.438	34.270	23.846	-25.730	60.000	10.425	QP
12			24.438	28.352	17.927	-21.648	50.000	10.425	AV

Note: Measure Level (dBμV) = Reading Level (dBμV) + Factor (dB)

Factor (dB) = Cable Loss (dB) + LISN Factor (dB).

Site: SIP-SR2	Time: 2020/12/04
Limit: FCC_Part15.107_CE_AC Power _ Class B	Engineer: Kyrie Xie
Probe: ENV216_101684_Filter On	Polarity: Line
EUT: OAW-AP1301	Power: AC 120V/60Hz
Test Mode 3	

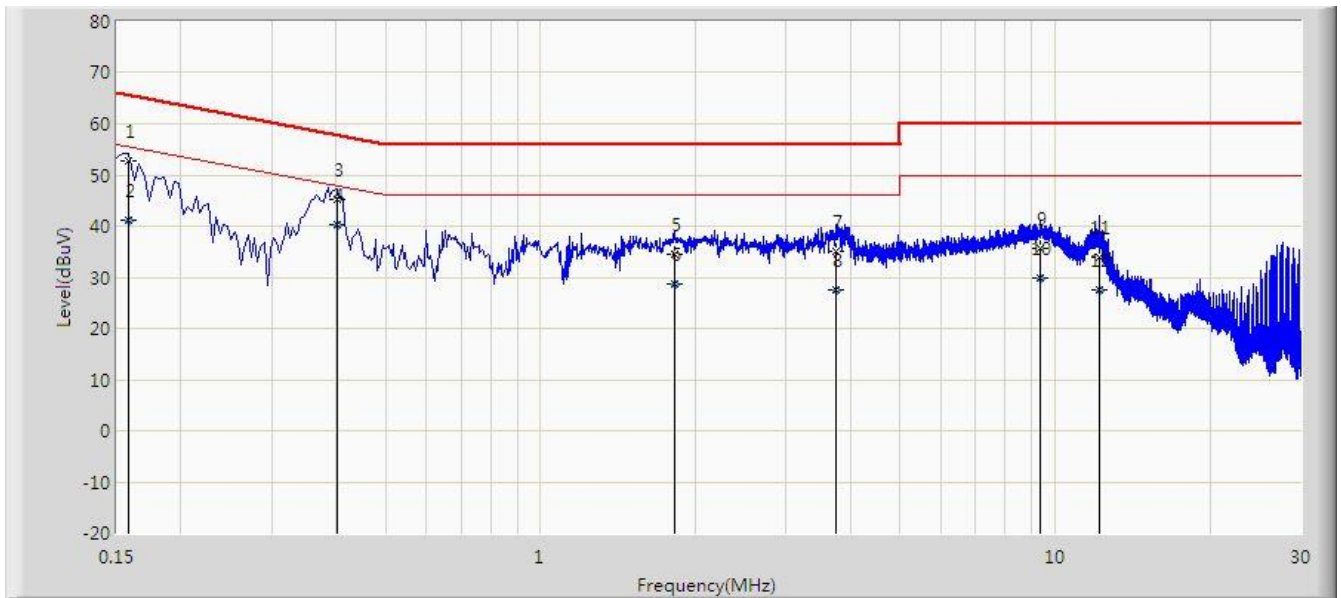

No	Flag	Mark	Frequency (MHz)	Measure Level (dBuV)	Reading Level (dBuV)	Margin (dB)	Limit (dBuV)	Factor (dB)	Type
1			0.158	52.675	42.394	-12.893	65.568	10.282	QP
2			0.158	41.217	30.936	-14.351	55.568	10.282	AV
3			0.402	45.217	35.117	-12.595	57.812	10.101	QP
4		*	0.402	40.323	30.223	-7.489	47.812	10.101	AV
5			1.818	34.422	24.485	-21.578	56.000	9.937	QP
6			1.818	28.630	18.693	-17.370	46.000	9.937	AV
7			3.758	35.148	25.263	-20.852	56.000	9.885	QP
8			3.758	27.650	17.764	-18.350	46.000	9.885	AV
9			9.366	35.707	25.770	-24.293	60.000	9.937	QP
10			9.366	29.984	20.048	-20.016	50.000	9.937	AV
11			12.190	33.959	23.971	-26.041	60.000	9.988	QP
12			12.190	27.402	17.414	-22.598	50.000	9.988	AV

Note: Measure Level (dBμV) = Reading Level (dBμV) + Factor (dB)

Factor (dB) = Cable Loss (dB) + LISN Factor (dB).

Site: SIP-SR2	Time: 2020/12/04
Limit: FCC_Part15.107_CE_AC Power _ Class B	Engineer: Kyrie Xie
Probe: ENV216_101684_Filter On	Polarity: Neutral
EUT: OAW-AP1301	Power: AC 120V/60Hz
Test Mode 3	

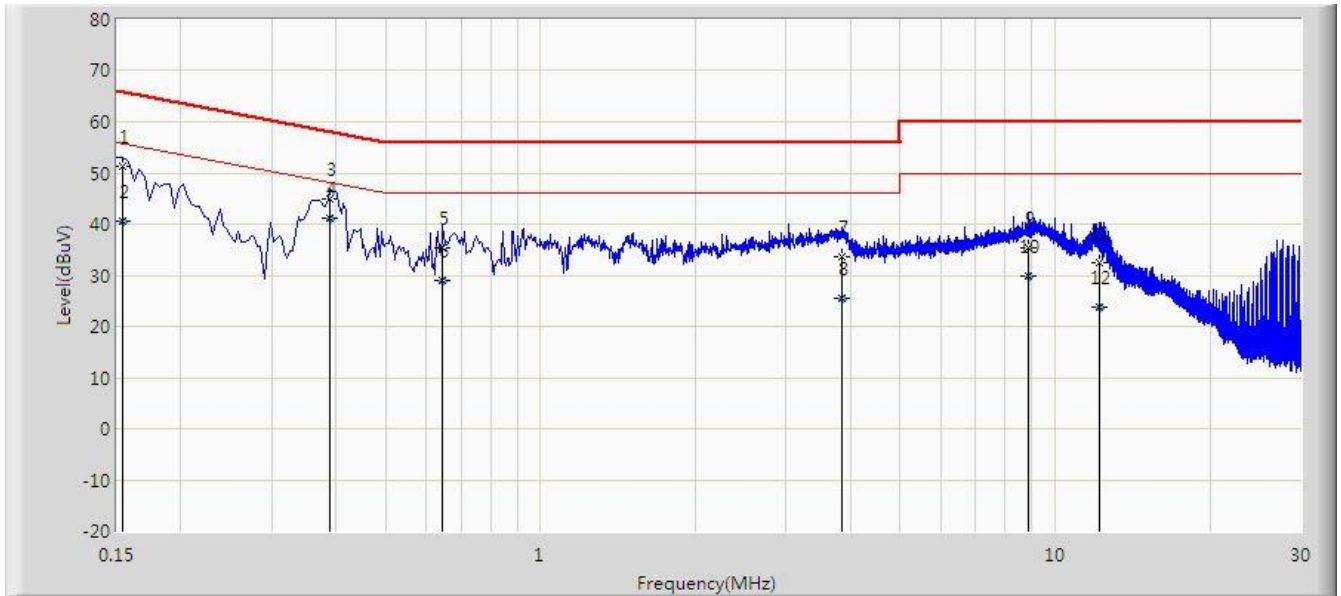

No	Flag	Mark	Frequency (MHz)	Measure Level (dBuV)	Reading Level (dBuV)	Margin (dB)	Limit (dBuV)	Factor (dB)	Type
1			0.154	51.397	40.678	-14.384	65.781	10.720	QP
2			0.154	40.604	29.884	-15.178	55.781	10.720	AV
3			0.390	45.017	34.900	-13.046	58.064	10.118	QP
4		*	0.390	41.017	30.900	-7.046	48.064	10.118	AV
5			0.646	35.439	25.303	-20.561	56.000	10.136	QP
6			0.646	29.027	18.891	-16.973	46.000	10.136	AV
7			3.842	33.589	23.682	-22.411	56.000	9.907	QP
8			3.842	25.576	15.669	-20.424	46.000	9.907	AV
9			8.862	35.452	25.498	-24.548	60.000	9.954	QP
10			8.862	29.822	19.867	-20.178	50.000	9.954	AV
11			12.226	32.536	22.527	-27.464	60.000	10.009	QP
12			12.226	23.783	13.774	-26.217	50.000	10.009	AV

Note: Measure Level (dB μ V) = Reading Level (dB μ V) + Factor (dB)

Factor (dB) = Cable Loss (dB) + LISN Factor (dB).

Site: SIP-SR2	Time: 2020/12/04
Limit: FCC_Part15.107_CE_AC Power _ Class B	Engineer: Kyrie Xie
Probe: ENV216_101684_Filter On	Polarity: Line
EUT: OAW-AP1301	Power: By PoE
Test Mode 4	

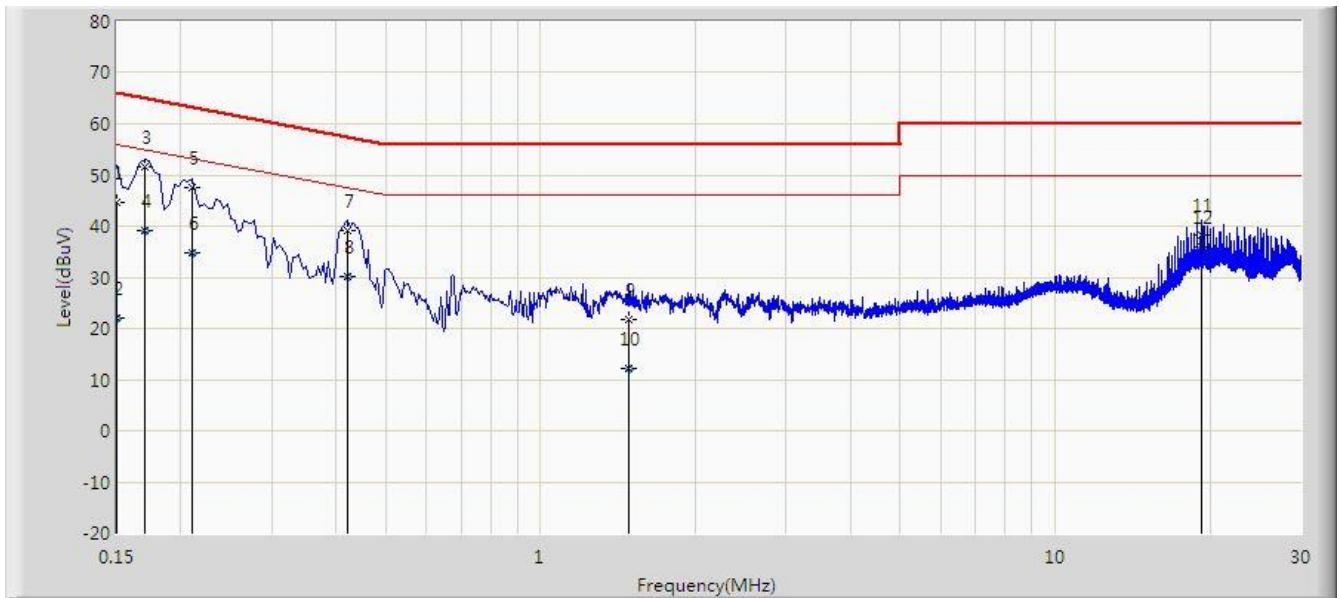

No	Flag	Mark	Frequency (MHz)	Measure Level (dBuV)	Reading Level (dBuV)	Margin (dB)	Limit (dBuV)	Factor (dB)	Type
1			0.150	44.730	33.605	-21.270	66.000	11.126	QP
2			0.150	21.904	10.778	-34.096	56.000	11.126	AV
3		*	0.170	51.584	41.530	-13.376	64.960	10.054	QP
4			0.170	39.001	28.947	-15.959	54.960	10.054	AV
5			0.210	47.533	37.575	-15.672	63.205	9.959	QP
6			0.210	34.846	24.887	-18.360	53.205	9.959	AV
7			0.422	39.020	28.908	-18.389	57.409	10.112	QP
8			0.422	30.220	20.108	-17.189	47.409	10.112	AV
9			1.482	21.835	11.892	-34.165	56.000	9.942	QP
10			1.482	12.046	2.104	-33.954	46.000	9.942	AV
11			19.310	38.148	28.079	-21.852	60.000	10.069	QP
12			19.310	35.926	25.857	-14.074	50.000	10.069	AV

Note: Measure Level (dBμV) = Reading Level (dBμV) + Factor (dB)

Factor (dB) = Cable Loss (dB) + LISN Factor (dB).

Site: SIP-SR2	Time: 2020/12/04
Limit: FCC_Part15.107_CE_AC Power _ Class B	Engineer: Kyrie Xie
Probe: ENV216_101684_Filter On	Polarity: Neutral
EUT: OAW-AP1301	Power: By PoE
Test Mode 4	

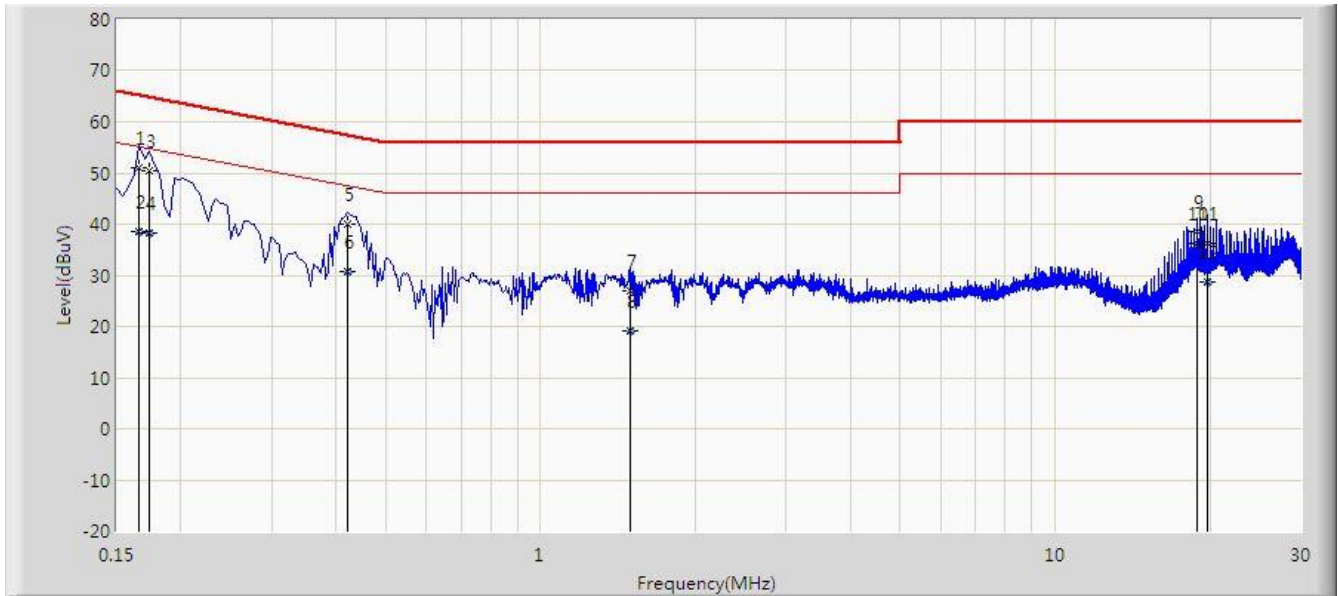

No	Flag	Mark	Frequency (MHz)	Measure Level (dBuV)	Reading Level (dBuV)	Margin (dB)	Limit (dBuV)	Factor (dB)	Type
1			0.166	50.917	40.843	-14.241	65.158	10.073	QP
2			0.166	38.472	28.398	-16.686	55.158	10.073	AV
3			0.174	50.325	40.267	-14.443	64.767	10.058	QP
4			0.174	38.132	28.074	-16.636	54.767	10.058	AV
5			0.422	39.960	29.823	-17.449	57.409	10.137	QP
6			0.422	30.797	20.660	-16.611	47.409	10.137	AV
7			1.490	26.888	16.932	-29.112	56.000	9.956	QP
8			1.490	19.255	9.298	-26.745	46.000	9.956	AV
9			18.814	38.554	28.439	-21.446	60.000	10.114	QP
10		*	18.814	36.265	26.150	-13.735	50.000	10.114	AV
11			19.806	36.198	26.068	-23.802	60.000	10.130	QP
12			19.806	28.767	18.638	-21.233	50.000	10.130	AV

Note: Measure Level (dBμV) = Reading Level (dBμV) + Factor (dB)

Factor (dB) = Cable Loss (dB) + LISN Factor (dB).

5.3. Radiated Emission Measurement

5.3.1. Test Limit

FCC Part 15.109 Limit		
Frequency (MHz)	Distance (m)	Level (dBµV/m)
30 - 88	3	40
88 - 216	3	43.5
216 - 960	3	46
Above 960	3	54

Note 1: The lower limit shall apply at the transition frequency.
 Note 2: Distance refers to the distance in meters between the measuring instrument antenna and the closed point of any part of the device or system.
 Note 3: E field strength (dBµV/m) = 20 log E field strength (uV/m)

ICES-003 Issue 7 Limit		
Frequency (MHz)	Distance (m)	Level (dBµV/m)
30 - 88	3	40
88 - 216	3	43.5
216 - 230	3	46
230 - 960	3	47
Above 960	3	54

Note 1: The lower limit shall apply at the transition frequency.
 Note 2: Distance refers to the distance in meters between the measuring instrument antenna and the closed point of any part of the device or system.
 Note 3: E field strength (dBµV/m) = 20 log E field strength (uV/m)

Note: Since FCC limit is stricter, so we choose FCC limit in the Radiated Emission testing.

5.3.2. Test Setup

Below 1GHz Test Setup:

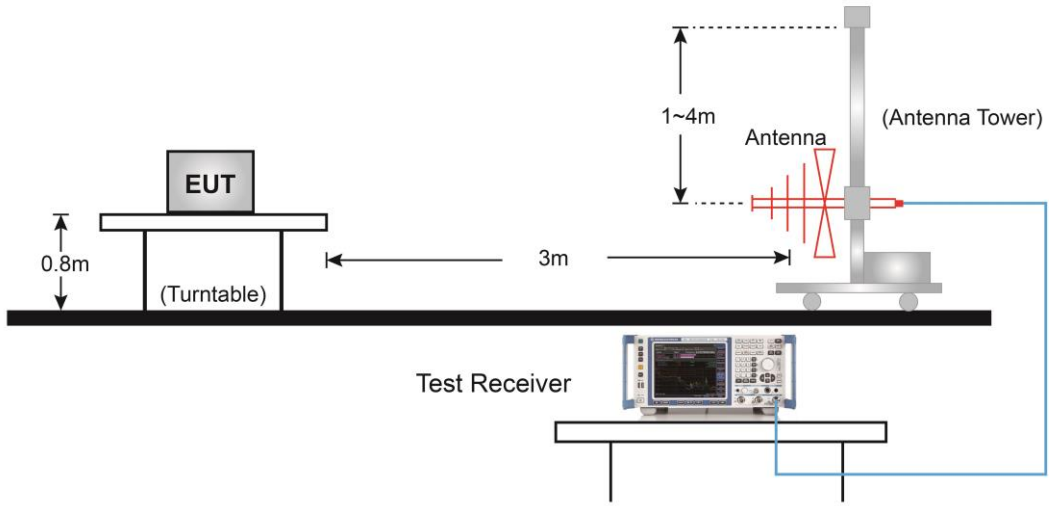

Above 1GHz Test Setup:

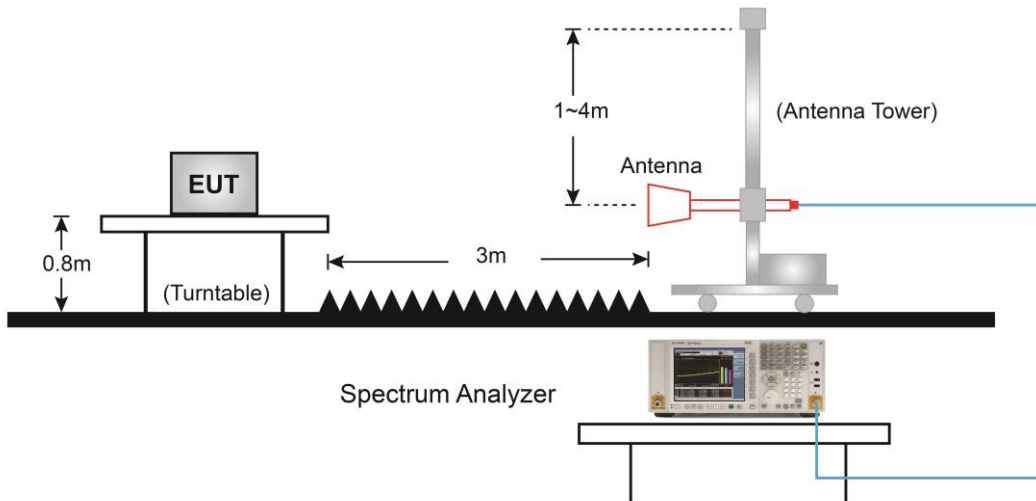

5.3.3. Test Result of Radiated Emissions

Site: WZ-AC1	Time: 2020/09/02
Limit: FCC_Part15.109_RE(3m) _Class B	Engineer: Buter Shi
Probe: AC1_VULB 9168 _30-1000MHz	Polarity: Horizontal
EUT: OAW-AP1311	Power: AC 120V/60Hz
Test Mode 1	

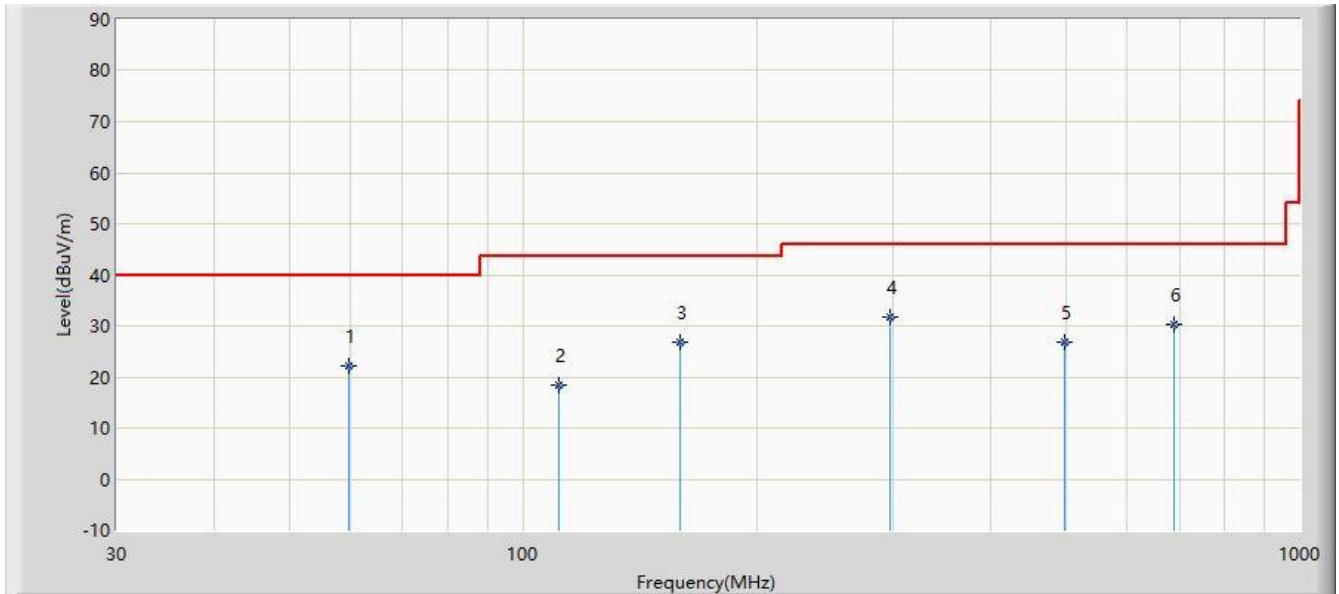

No	Flag	Mark	Frequency (MHz)	Measure Level (dBuV/m)	Reading Level (dBuV)	Margin (dB)	Limit (dBuV/m)	Factor (dB)	Type
1			59.620	22.095	4.520	-17.905	40.000	17.575	QP
2			111.110	18.398	3.240	-25.102	43.500	15.158	QP
3			159.360	26.852	8.650	-16.648	43.500	18.201	QP
4		*	296.540	31.784	13.210	-14.216	46.000	18.574	QP
5			498.510	26.799	3.240	-19.201	46.000	23.559	QP
6			688.630	30.286	3.260	-15.714	46.000	27.026	QP

Note: Measure Level (dBuV/m) = Reading Level (dBuV) + Factor (dB)

Factor (dB) = Cable Loss (dB) + Antenna Factor (dB/m)

Site: WZ-AC1	Time: 2020/09/02
Limit: FCC_Part15.109_RE(3m) _Class B	Engineer: Buter Shi
Probe: AC1_VULB 9168 _30-1000MHz	Polarity: Vertical
EUT: OAW-AP1311	Power: AC 120V/60Hz
Test Mode 1	

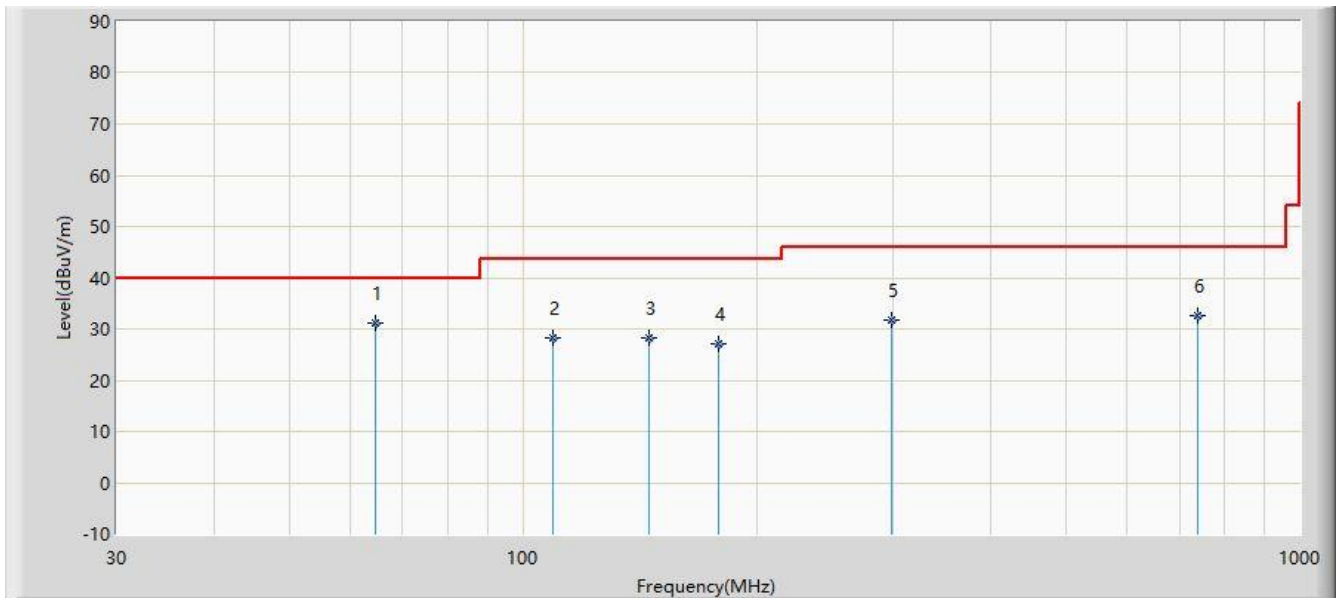

No	Flag	Mark	Frequency (MHz)	Measure Level (dBuV/m)	Reading Level (dBuV)	Margin (dB)	Limit (dBuV/m)	Factor (dB)	Type
1		*	64.490	31.029	14.090	-8.971	40.000	16.939	QP
2			109.440	28.187	13.240	-15.313	43.500	14.947	QP
3			145.240	28.303	10.260	-15.197	43.500	18.044	QP
4			178.650	27.050	10.240	-16.450	43.500	16.811	QP
5			297.630	31.839	13.240	-14.161	46.000	18.598	QP
6			740.150	32.619	4.360	-13.381	46.000	28.259	QP

Note: Measure Level (dB μ V/m) = Reading Level (dB μ V) + Factor (dB)

Factor (dB) = Cable Loss (dB) + Antenna Factor (dB/m)

Site: WZ-AC1	Time: 2020/09/02
Limit: FCC_Part15.109_RE(3m) _Class B	Engineer: Buter Shi
Probe: AC1_VULB 9168 _30-1000MHz	Polarity: Horizontal
EUT: OAW-AP1311	Power: By PoE
Test Mode 2	

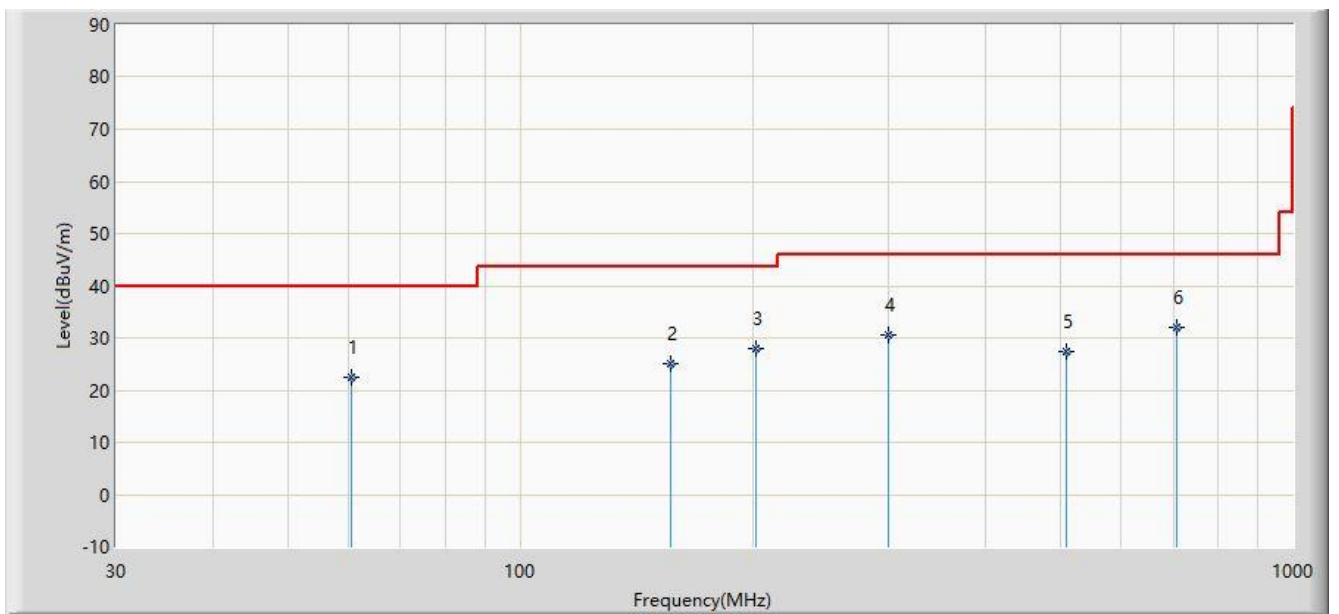

No	Flag	Mark	Frequency (MHz)	Measure Level (dBuV/m)	Reading Level (dBuV)	Margin (dB)	Limit (dBuV/m)	Factor (dB)	Type
1			60.520	22.353	4.910	-17.647	40.000	17.443	QP
2			156.480	25.104	6.820	-18.396	43.500	18.283	QP
3			202.350	28.086	13.260	-15.414	43.500	14.827	QP
4			300.210	30.512	11.840	-15.488	46.000	18.671	QP
5			508.684	27.272	3.520	-18.728	46.000	23.752	QP
6		*	706.540	31.940	4.520	-14.060	46.000	27.419	QP

Note: Measure Level (dBμV/m) = Reading Level (dBμV) + Factor (dB)

Factor (dB) = Cable Loss (dB) + Antenna Factor (dB/m)

Site: WZ-AC1	Time: 2020/09/02
Limit: FCC_Part15.109_RE(3m) _Class B	Engineer: Buter Shi
Probe: AC1_VULB 9168 _30-1000MHz	Polarity: Vertical
EUT: OAW-AP1311	Power: By PoE
Test Mode 2	

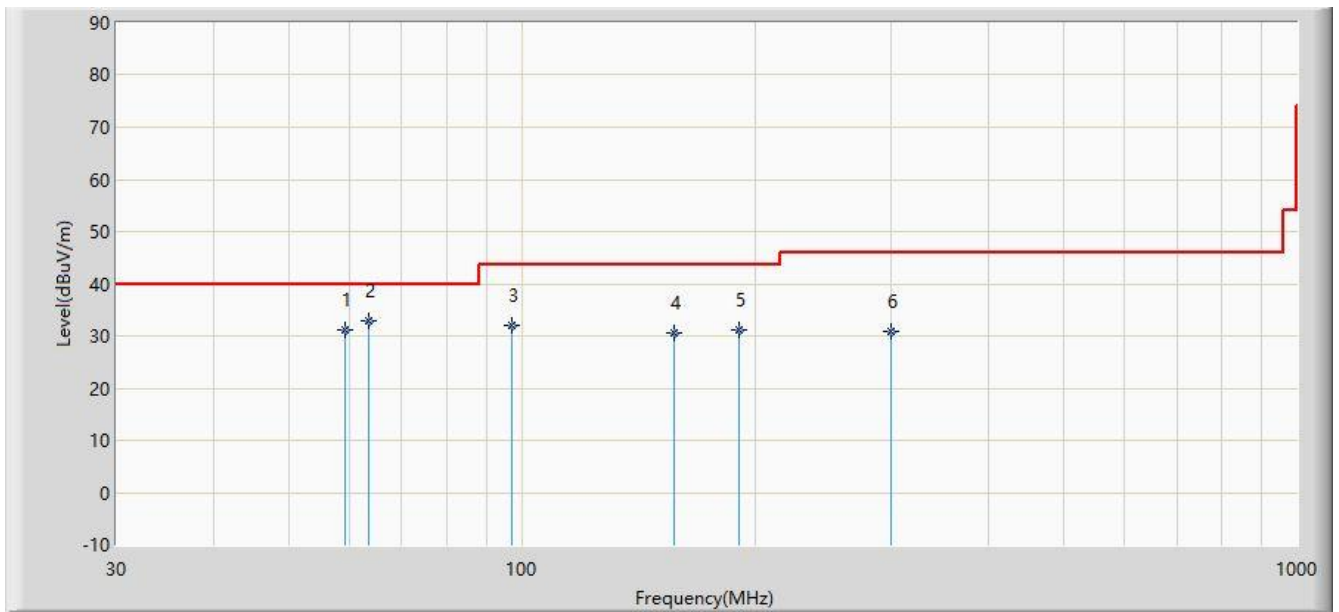

No	Flag	Mark	Frequency (MHz)	Measure Level (dBuV/m)	Reading Level (dBuV)	Margin (dB)	Limit (dBuV/m)	Factor (dB)	Type
1			59.260	31.257	13.620	-8.743	40.000	17.637	QP
2		*	63.540	32.826	15.720	-7.174	40.000	17.106	QP
3			96.950	31.905	18.950	-11.595	43.500	12.954	QP
4			157.540	30.592	12.320	-12.908	43.500	18.271	QP
5			191.040	31.168	15.640	-12.332	43.500	15.528	QP
6			300.140	30.990	12.320	-15.010	46.000	18.669	QP

Note: Measure Level (dB μ V/m) = Reading Level (dB μ V) + Factor (dB)

Factor (dB) = Cable Loss (dB) + Antenna Factor (dB/m)

Site: SIP-AC1	Time: 2020/12/04
Limit: FCC_Part15.109_RE(3m) _Class B	Engineer: White Wang
Probe: SIP-AC1_VULB 9168 _30-1000MHz-4dB	Polarity: Horizontal
EUT: OAW-AP1301	Power: AC 120V/60Hz
Test Mode 3	

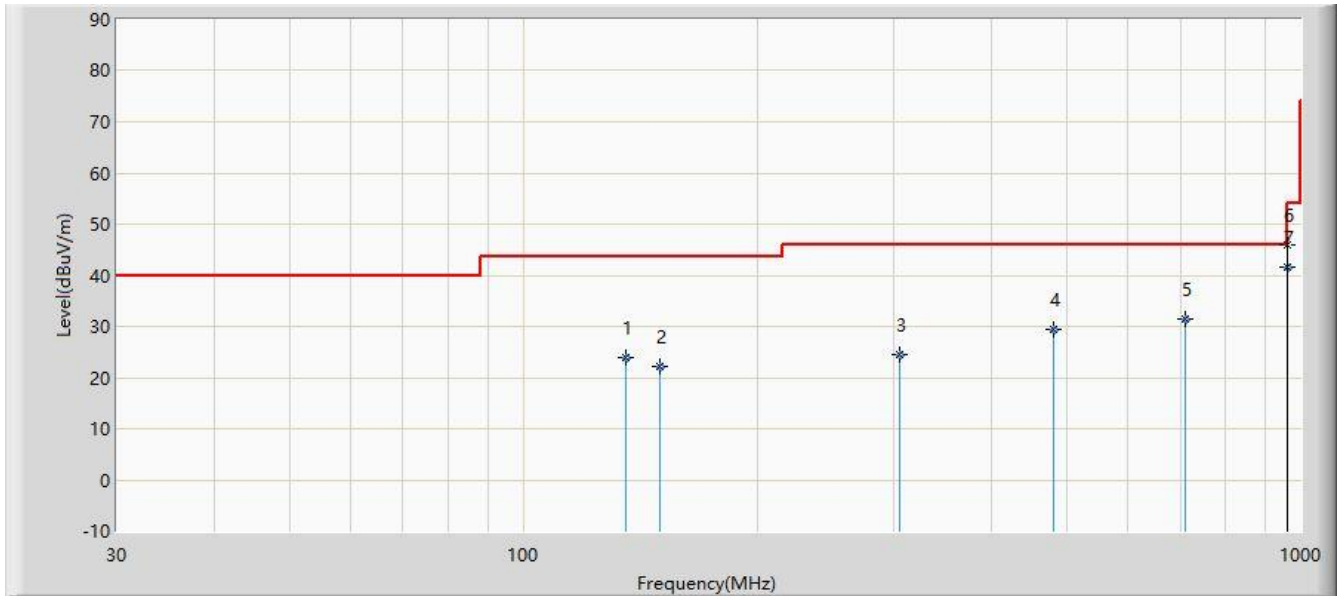

No	Flag	Mark	Frequency (MHz)	Measure Level (dBuV/m)	Reading Level (dBuV)	Margin (dB)	Limit (dBuV/m)	Factor (dB)	Type
1			135.245	23.964	7.100	-19.536	43.500	16.864	QP
2			149.795	22.175	4.300	-21.325	43.500	17.875	QP
3			304.510	24.392	6.200	-21.608	46.000	18.192	QP
4			480.080	29.542	7.300	-16.458	46.000	22.242	QP
5			710.940	31.423	5.100	-14.577	46.000	26.323	QP
6	*		960.230	41.714	12.400	-12.286	54.000	29.314	QP

Note: Measure Level (dB μ V/m) = Reading Level (dB μ V) + Factor (dB)

Factor (dB) = Cable Loss (dB) + Antenna Factor (dB/m)

Site: SIP-AC1	Time: 2020/12/04
Limit: FCC_Part15.109_RE(3m)_Class B	Engineer: White Wang
Probe: SIP-AC1_VULB 9168 _30-1000MHz-4dB	Polarity: Vertical
EUT: OAW-AP1301	Power: AC 120V/60Hz
Test Mode 3	

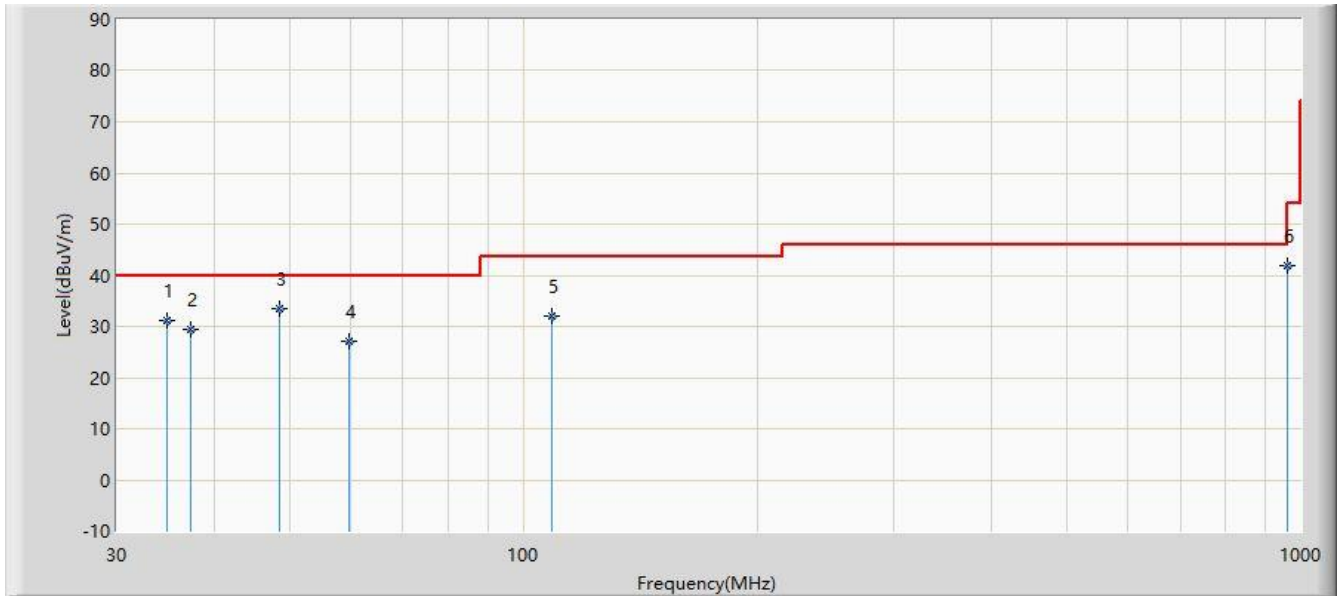

No	Flag	Mark	Frequency (MHz)	Measure Level (dBuV/m)	Reading Level (dBuV)	Margin (dB)	Limit (dBuV/m)	Factor (dB)	Type
1			34.850	31.040	14.300	-8.960	40.000	16.740	QP
2			37.275	29.291	12.300	-10.709	40.000	16.991	QP
3		*	48.590	33.341	15.600	-6.659	40.000	17.741	QP
4			59.585	27.003	9.700	-12.997	40.000	17.303	QP
5			109.055	32.078	17.500	-11.422	43.500	14.578	QP
6			960.230	41.914	12.600	-12.086	54.000	29.314	QP

Note: Measure Level (dB μ V/m) = Reading Level (dB μ V) + Factor (dB)

Factor (dB) = Cable Loss (dB) + Antenna Factor (dB/m)

Site: SIP-AC1	Time: 2020/12/04
Limit: FCC_Part15.109_RE(3m)_Class B	Engineer: White Wang
Probe: SIP-AC1_VULB 9168 _30-1000MHz-4dB	Polarity: Horizontal
EUT: OAW-AP1301	Power: By PoE
Test Mode 4	

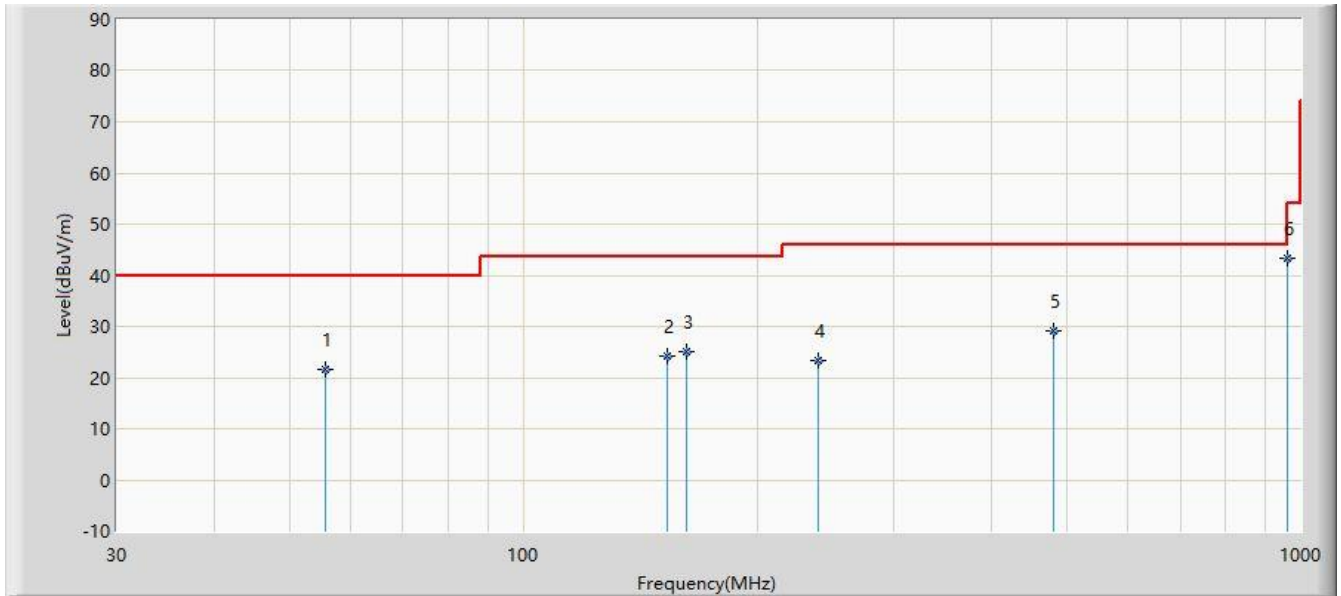

No	Flag	Mark	Frequency (MHz)	Measure Level (dBuV/m)	Reading Level (dBuV)	Margin (dB)	Limit (dBuV/m)	Factor (dB)	Type
1			55.705	21.487	3.900	-18.513	40.000	17.587	QP
2			153.190	24.125	6.200	-19.375	43.500	17.925	QP
3			161.920	24.970	7.300	-18.530	43.500	17.670	QP
4			240.055	23.427	7.500	-22.573	46.000	15.927	QP
5			480.080	29.042	6.800	-16.958	46.000	22.242	QP
6		*	960.100	43.312	14.000	-10.688	54.000	29.312	QP

Note: Measure Level (dB μ V/m) = Reading Level (dB μ V) + Factor (dB)

Factor (dB) = Cable Loss (dB) + Antenna Factor (dB/m)

Site: SIP-AC1	Time: 2020/12/04
Limit: FCC_Part15.109_RE(3m)_Class B	Engineer: White Wang
Probe: SIP-AC1_VULB 9168_30-1000MHz-4dB	Polarity: Vertical
EUT: OAW-AP1301	Power: By PoE
Test Mode 4	

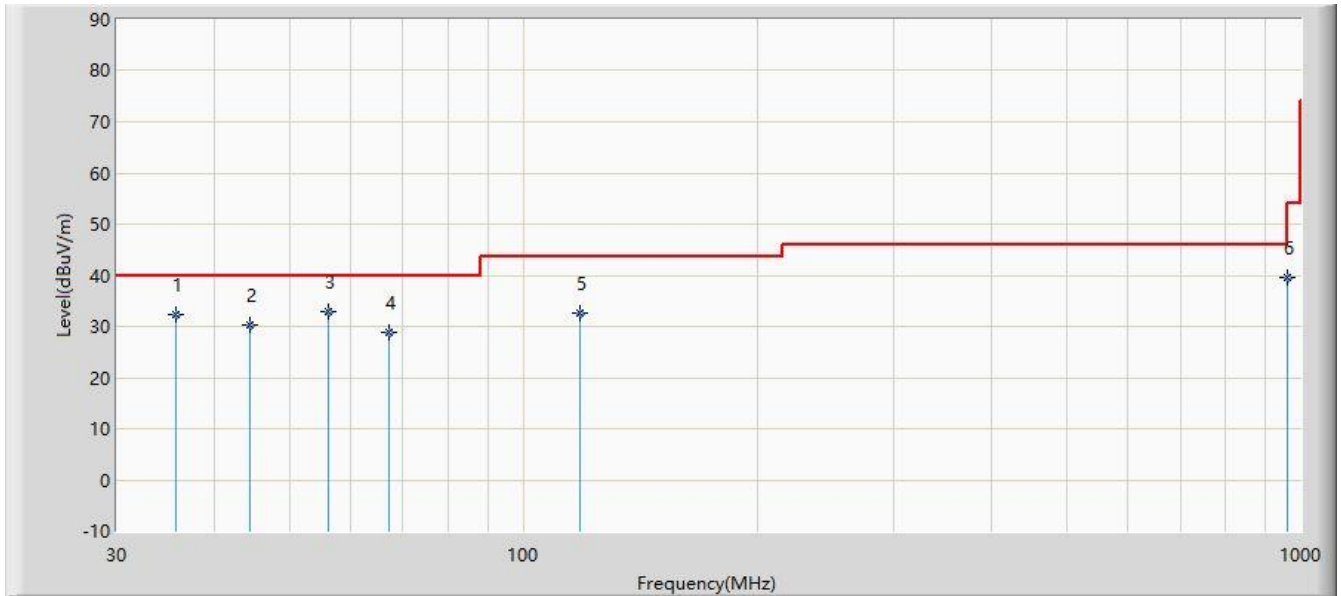

No	Flag	Mark	Frequency (MHz)	Measure Level (dBuV/m)	Reading Level (dBuV)	Margin (dB)	Limit (dBuV/m)	Factor (dB)	Type
1			35.820	32.289	15.400	-7.711	40.000	16.889	QP
2			44.550	30.195	12.600	-9.805	40.000	17.595	QP
3		*	56.202	32.944	15.400	-7.056	40.000	17.544	QP
4			67.301	28.719	12.600	-11.281	40.000	16.119	QP
5			118.270	32.665	17.300	-10.835	43.500	15.365	QP
6			960.715	39.515	10.200	-14.485	54.000	29.315	QP

Note: Measure Level (dB μ V/m) = Reading Level (dB μ V) + Factor (dB)

Factor (dB) = Cable Loss (dB) + Antenna Factor (dB/m)

Site: WZ-AC1	Time: 2020/09/02
Limit: FCC_Part15.109_RE(3m) _Class B	Engineer: Buter Shi
Probe: AC1_BBHA9120D_1-18GHz	Polarity: Horizontal
EUT: OAW-AP1311	Power: AC 120V/60Hz
Test Mode 1	

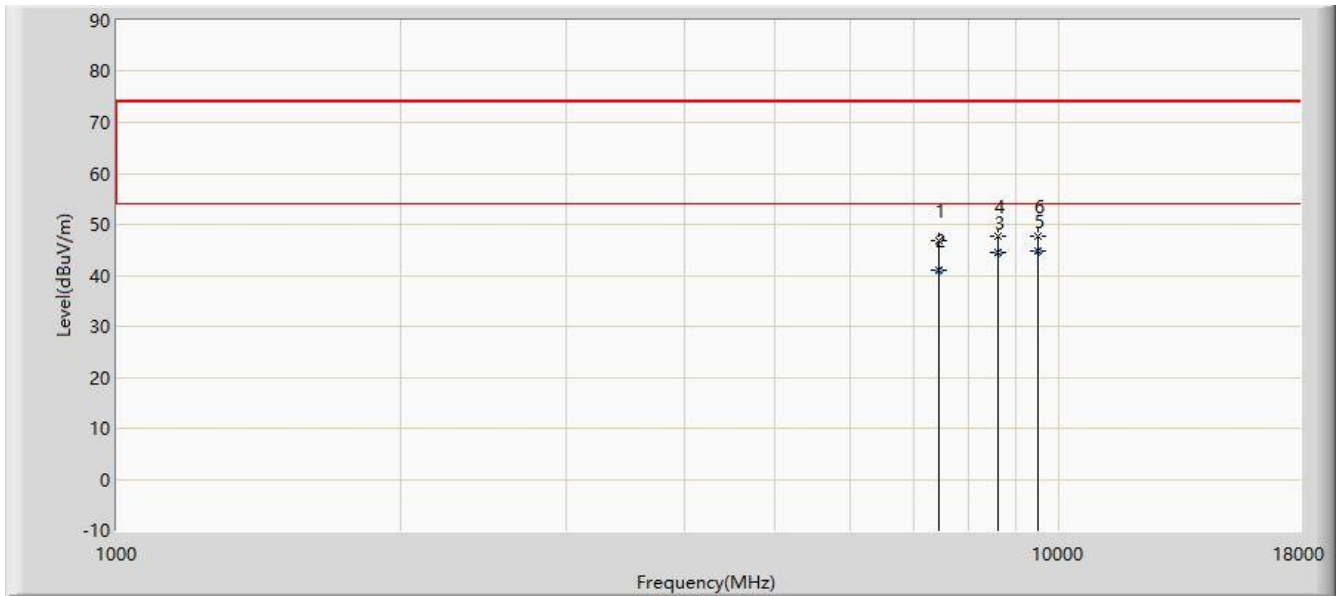

No	Flag	Mark	Frequency (MHz)	Measure Level (dBuV/m)	Reading Level (dBuV)	Margin (dB)	Limit (dBuV/m)	Factor (dB)	Type
1			7460.000	46.946	35.980	-27.054	74.000	10.966	PK
2			7462.500	41.118	30.160	-12.882	54.000	10.958	AV
3			8607.210	44.385	32.160	-9.615	54.000	12.225	AV
4			8607.500	47.711	35.479	-26.289	74.000	12.232	PK
5		*	9508.200	44.824	30.160	-9.176	54.000	14.664	AV
6			9508.500	47.659	32.991	-26.341	74.000	14.668	PK

Note 1: Measure Level (dB μ V/m) = Reading Level (dB μ V) + Factor (dB)

Factor (dB) = Cable Loss (dB) + Antenna Factor (dB/m) – PreAmplifier Gain (dB)

Note 2: The amplitude of radiated emissions (frequency range from 18GHz to 40GHz) is that proximity to ambient noise, which also are attenuated more than 20 dB below the permissible value. Therefore, the data is not presented in the report.

Site: WZ-AC1	Time: 2020/09/02
Limit: FCC_Part15.109_RE(3m) _Class B	Engineer: Buter Shi
Probe: AC1_BBHA9120D_1-18GHz	Polarity: Vertical
EUT: OAW-AP1311	Power: AC 120V/60Hz
Test Mode 1	

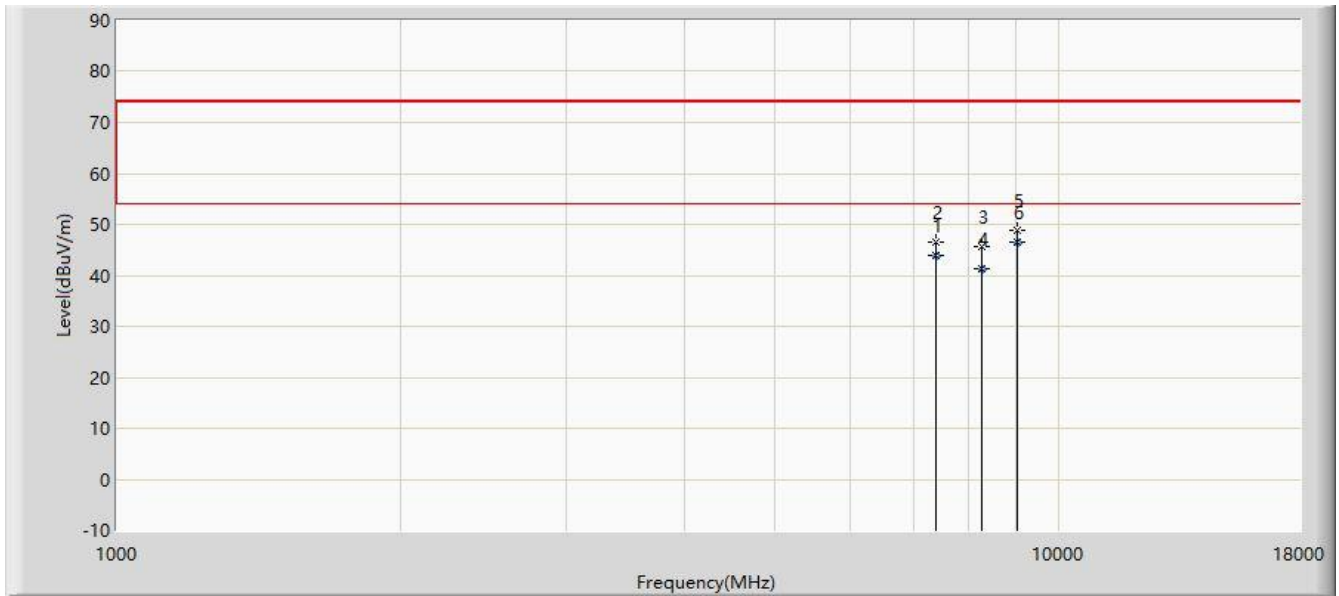

No	Flag	Mark	Frequency (MHz)	Measure Level (dBuV/m)	Reading Level (dBuV)	Margin (dB)	Limit (dBuV/m)	Factor (dB)	Type
1			7408.540	43.868	33.130	-10.132	54.000	10.738	AV
2			7409.000	46.429	35.691	-27.571	74.000	10.738	PK
3			8276.000	45.662	34.445	-28.338	74.000	11.217	PK
4			8278.900	41.384	30.180	-12.616	54.000	11.204	AV
5			9015.500	48.833	35.580	-25.167	74.000	13.253	PK
6		*	9016.590	46.500	33.240	-7.500	54.000	13.260	AV

Note 1: Measure Level (dB μ V/m) = Reading Level (dB μ V) + Factor (dB)

Factor (dB) = Cable Loss (dB) + Antenna Factor (dB/m) - PreAmplifier Gain (dB)

Note 2: The amplitude of radiated emissions (frequency range from 18GHz to 40GHz) is that proximity to ambient noise, which also are attenuated more than 20 dB below the permissible value. Therefore, the data is not presented in the report.

Site: WZ-AC1	Time: 2020/09/02
Limit: FCC_Part15.109_RE(3m) _Class B	Engineer: Buter Shi
Probe: AC1_BBHA9120D_1-18GHz	Polarity: Horizontal
EUT: OAW-AP1311	Power: By PoE
Test Mode 2	

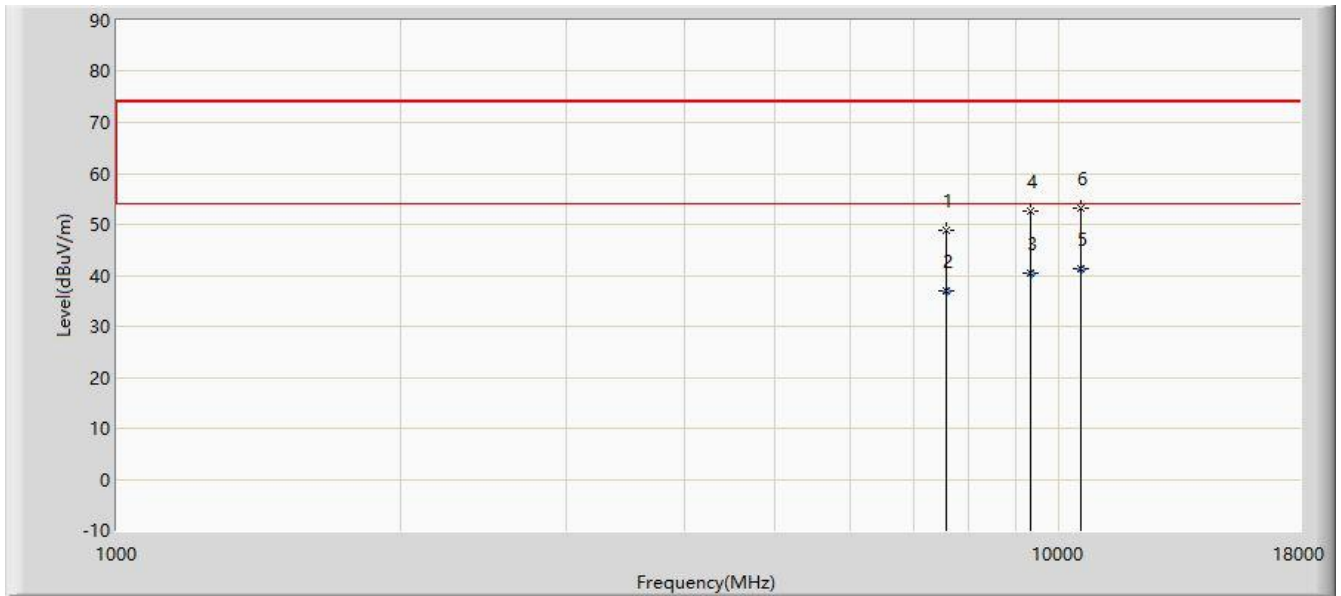

No	Flag	Mark	Frequency (MHz)	Measure Level (dBuV/m)	Reading Level (dBuV)	Margin (dB)	Limit (dBuV/m)	Factor (dB)	Type
1			7596.000	48.882	38.132	-25.118	74.000	10.750	PK
2			7596.400	36.870	26.120	-17.130	54.000	10.750	AV
3			9336.200	40.480	26.240	-13.520	54.000	14.240	AV
4			9338.500	52.518	38.241	-21.482	74.000	14.277	PK
5		*	10543.200	41.332	24.850	-12.668	54.000	16.482	AV
6			10545.500	53.246	36.779	-20.754	74.000	16.467	PK

Note 1: Measure Level (dB μ V/m) = Reading Level (dB μ V) + Factor (dB)

Factor (dB) = Cable Loss (dB) + Antenna Factor (dB/m) - PreAmplifier Gain (dB)

Note 2: The amplitude of radiated emissions (frequency range from 18GHz to 40GHz) is that proximity to ambient noise, which also are attenuated more than 20 dB below the permissible value. Therefore, the data is not presented in the report.

Site: WZ-AC1	Time: 2020/09/02
Limit: FCC_Part15.109_RE(3m) _Class B	Engineer: Buter Shi
Probe: AC1_BBHA9120D_1-18GHz	Polarity: Vertical
EUT: OAW-AP1311	Power: By PoE
Test Mode 2	

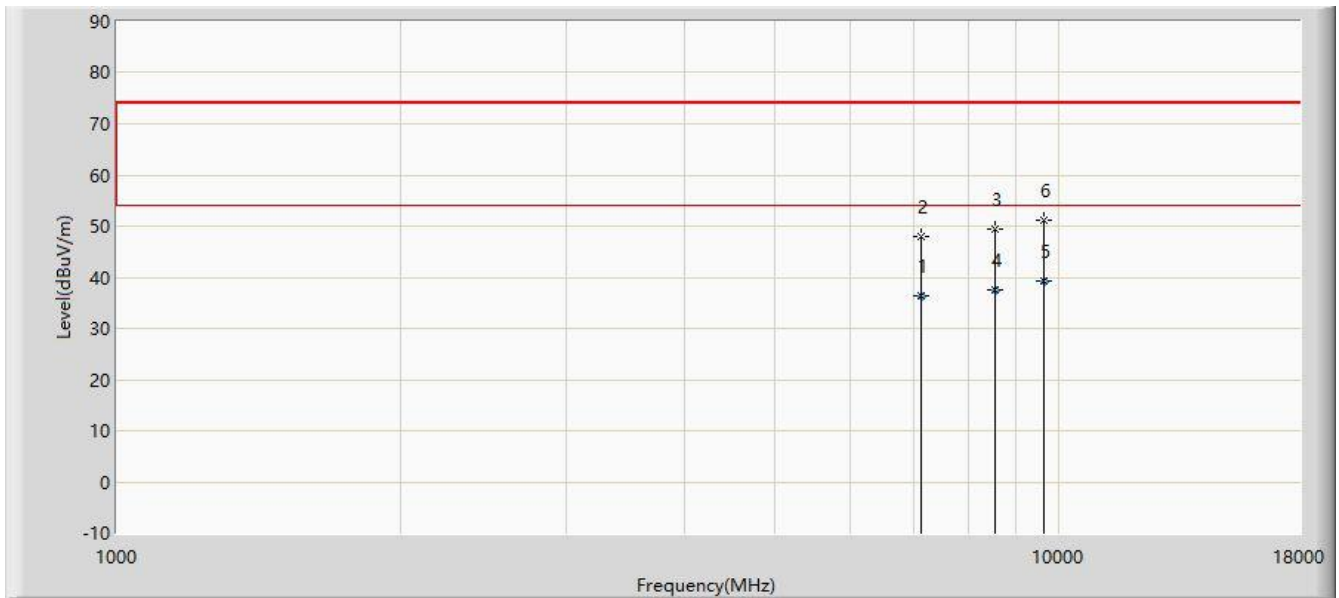

No	Flag	Mark	Frequency (MHz)	Measure Level (dBuV/m)	Reading Level (dBuV)	Margin (dB)	Limit (dBuV/m)	Factor (dB)	Type
1			7126.300	36.420	25.920	-17.580	54.000	10.500	AV
2			7128.500	47.934	37.446	-26.066	74.000	10.488	PK
3			8556.500	49.468	37.532	-24.532	74.000	11.937	PK
4			8565.200	37.591	25.540	-16.409	54.000	12.051	AV
5		*	9624.300	39.174	24.520	-14.826	54.000	14.654	AV
6			9627.500	51.084	36.459	-22.916	74.000	14.625	PK

Note 1: Measure Level (dBuV/m) = Reading Level (dBuV) + Factor (dB)

Factor (dB) = Cable Loss (dB) + Antenna Factor (dB/m) - PreAmplifier Gain (dB)

Note 2: The amplitude of radiated emissions (frequency range from 18GHz to 40GHz) is that proximity to ambient noise, which also are attenuated more than 20 dB below the permissible value. Therefore, the data is not presented in the report.

Site: SIP-AC3	Time: 2020/12/04
Limit: FCC_Part15.109_RE(3m)_Class B	Engineer: Stephen Dong
Probe: SIP-AC3_HF907_102861_1-18GHz	Polarity: Horizontal
EUT: OAW-AP1301	Power: AC 120V/60Hz
Test Mode 3	

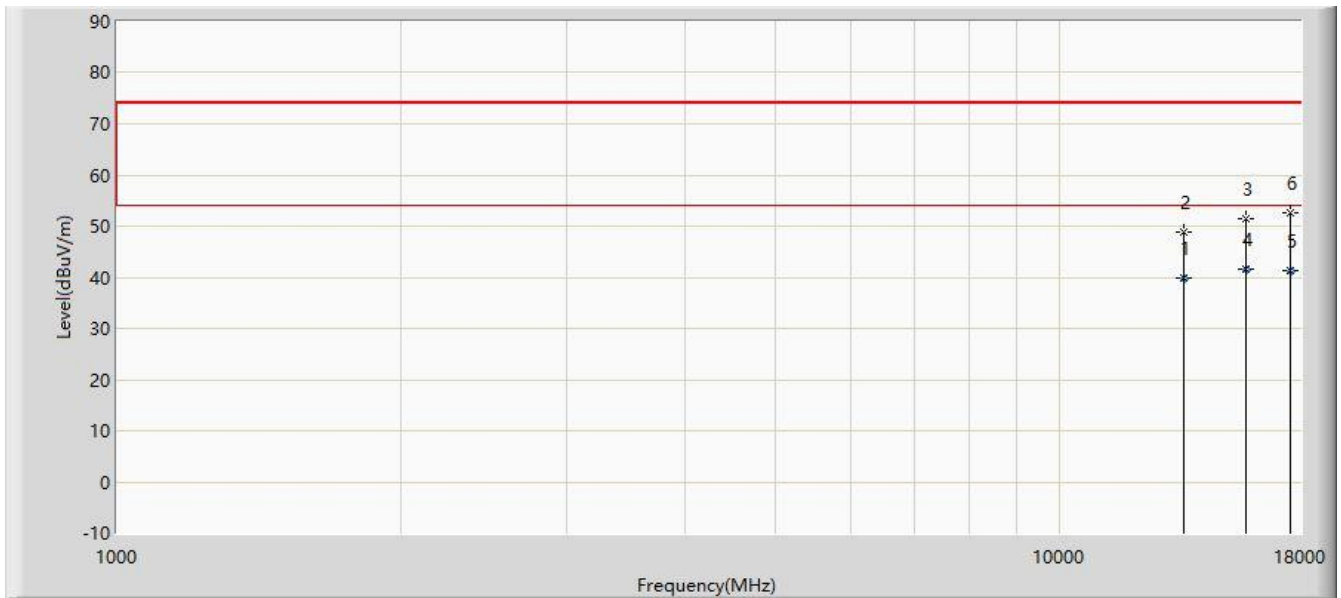

No	Flag	Mark	Frequency (MHz)	Measure Level (dBuV/m)	Reading Level (dBuV)	Margin (dB)	Limit (dBuV/m)	Factor (dB)	Type
1			13553.640	39.864	40.540	-14.136	54.000	-0.676	AV
2			13554.500	48.876	49.550	-25.124	74.000	-0.675	PK
3			15739.000	51.477	47.692	-22.523	74.000	3.785	PK
4		*	15740.356	41.712	37.946	-12.288	54.000	3.766	AV
5			17520.000	41.313	36.454	-12.687	54.000	4.859	AV
6			17524.000	52.645	47.740	-21.355	74.000	4.905	PK

Note 1: Measure Level (dB μ V/m) = Reading Level (dB μ V) + Factor (dB)

Factor (dB) = Cable Loss (dB) + Antenna Factor (dB/m) - PreAmplifier Gain (dB)

Note 2: The amplitude of radiated emissions (frequency range from 18GHz to 40GHz) is that proximity to ambient noise, which also are attenuated more than 20 dB below the permissible value. Therefore, the data is not presented in the report.

Site: SIP-AC3	Time: 2020/12/04
Limit: FCC_Part15.109_RE(3m)_Class B	Engineer: Stephen Dong
Probe: SIP-AC3_HF907_102861_1-18GHz	Polarity: Vertical
EUT: OAW-AP1301	Power: AC 120V/60Hz
Test Mode 3	

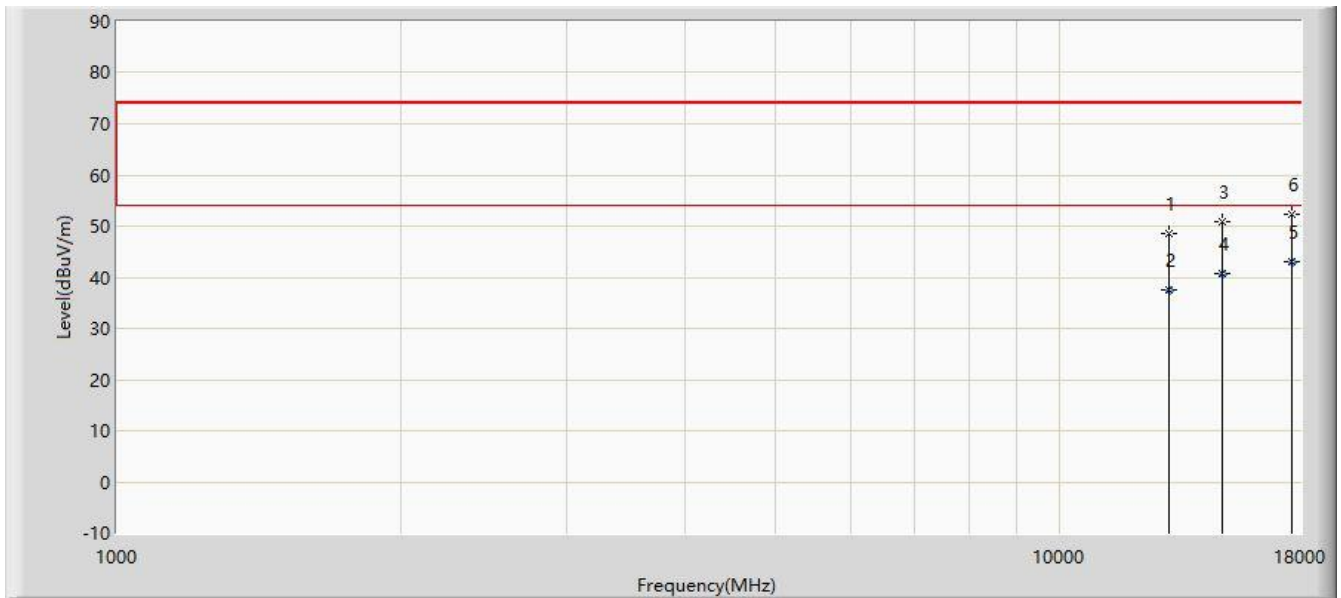

No	Flag	Mark	Frequency (MHz)	Measure Level (dBuV/m)	Reading Level (dBuV)	Margin (dB)	Limit (dBuV/m)	Factor (dB)	Type
1			13044.500	48.538	50.633	-25.462	74.000	-2.095	PK
2			13045.000	37.456	39.565	-16.544	54.000	-2.110	AV
3			14855.000	50.861	48.684	-23.139	74.000	2.177	PK
4			14861.740	40.793	38.545	-13.207	54.000	2.248	AV
5		*	17642.474	43.083	38.150	-10.917	54.000	4.933	AV
6			17643.000	52.387	47.447	-21.613	74.000	4.940	PK

Note 1: Measure Level (dB μ V/m) = Reading Level (dB μ V) + Factor (dB)

Factor (dB) = Cable Loss (dB) + Antenna Factor (dB/m) - PreAmplifier Gain (dB)

Note 2: The amplitude of radiated emissions (frequency range from 18GHz to 40GHz) is that proximity to ambient noise, which also are attenuated more than 20 dB below the permissible value. Therefore, the data is not presented in the report.

Site: SIP-AC3	Time: 2020/12/04
Limit: FCC_Part15.109_RE(3m) _Class B	Engineer: Stephen Dong
Probe: SIP-AC3_HF907_102861_1-18GHz	Polarity: Horizontal
EUT: OAW-AP1301	Power: By PoE
Test Mode 4	

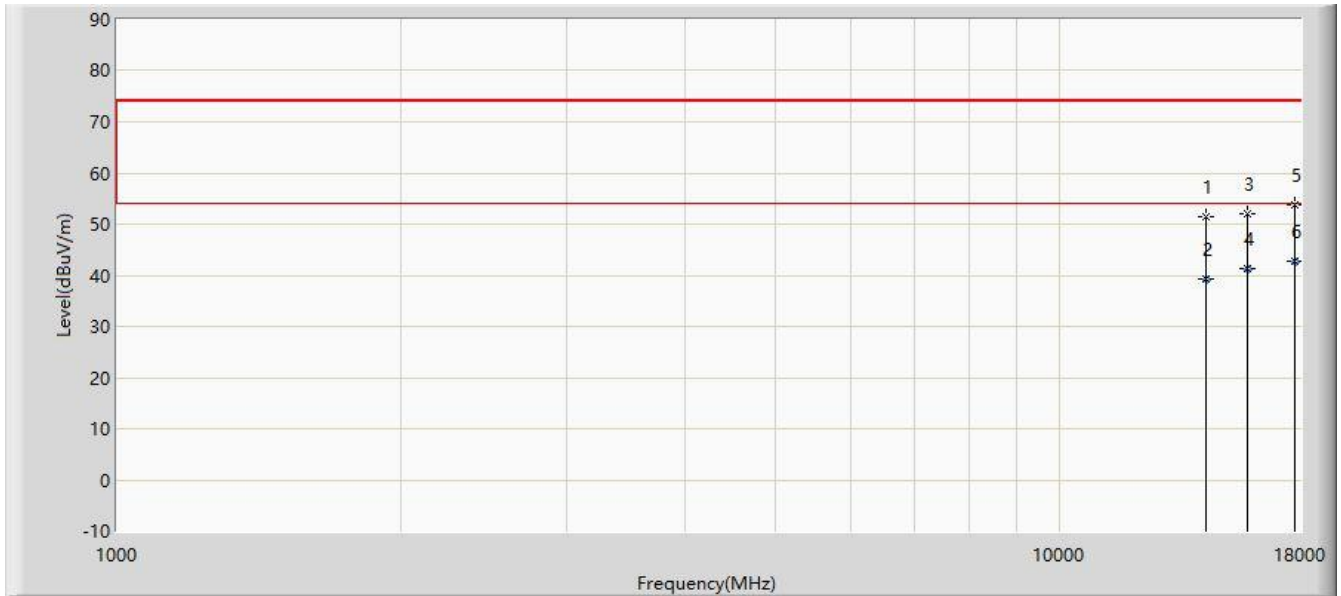

No	Flag	Mark	Frequency (MHz)	Measure Level (dBuV/m)	Reading Level (dBuV)	Margin (dB)	Limit (dBuV/m)	Factor (dB)	Type
1			14294.000	51.425	49.758	-22.575	74.000	1.667	PK
2			14296.298	39.287	37.641	-14.713	54.000	1.647	AV
3			15824.000	51.891	48.171	-22.109	74.000	3.720	PK
4			15824.960	41.184	37.455	-12.816	54.000	3.729	AV
5			17745.000	53.733	48.491	-20.267	74.000	5.242	PK
6		*	17748.650	42.647	37.365	-11.353	54.000	5.283	AV

Note 1: Measure Level (dB μ V/m) = Reading Level (dB μ V) + Factor (dB)

Factor (dB) = Cable Loss (dB) + Antenna Factor (dB/m) - PreAmplifier Gain (dB)

Note 2: The amplitude of radiated emissions (frequency range from 18GHz to 40GHz) is that proximity to ambient noise, which also are attenuated more than 20 dB below the permissible value. Therefore, the data is not presented in the report.

Site: SIP-AC3	Time: 2020/12/04
Limit: FCC_Part15.109_RE(3m) _Class B	Engineer: Stephen Dong
Probe: SIP-AC3_HF907_102861_1-18GHz	Polarity: Vertical
EUT: OAW-AP1301	Power: By PoE
Test Mode 4	

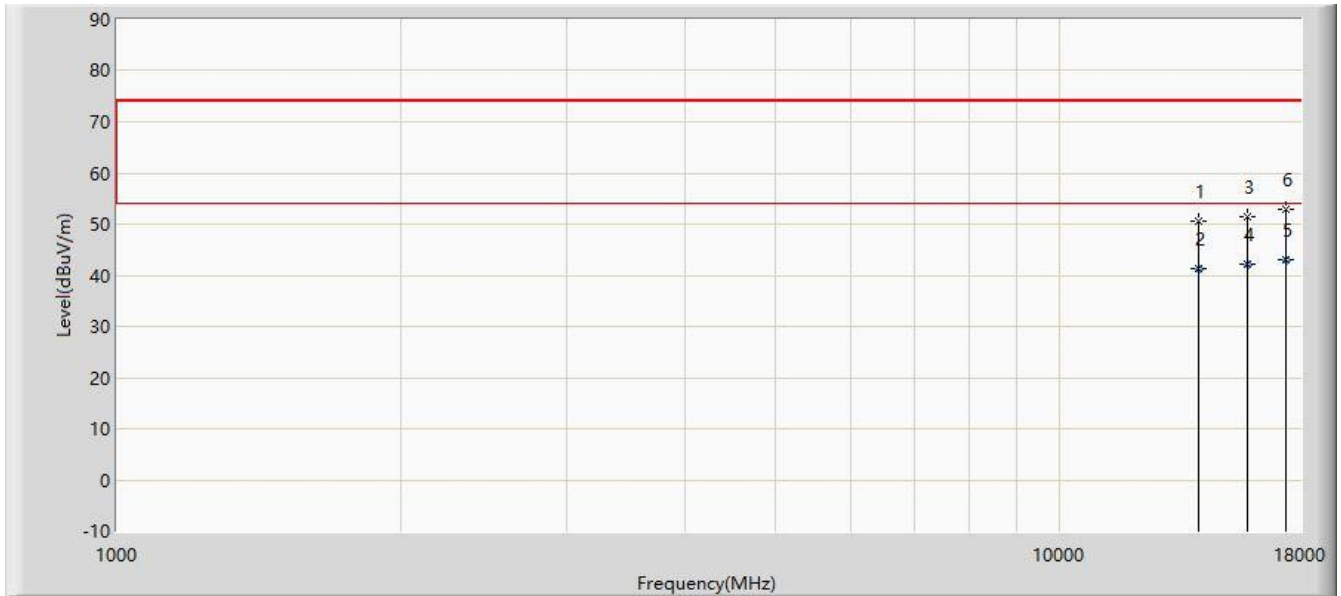

No	Flag	Mark	Frequency (MHz)	Measure Level (dBuV/m)	Reading Level (dBuV)	Margin (dB)	Limit (dBuV/m)	Factor (dB)	Type
1			14047.500	50.653	49.777	-23.347	74.000	0.876	PK
2			14050.500	41.437	40.540	-12.563	54.000	0.897	AV
3			15815.500	51.407	47.998	-22.593	74.000	3.410	PK
4			15820.000	42.030	38.456	-11.970	54.000	3.574	AV
5		*	17370.460	43.043	37.540	-10.957	54.000	5.503	AV
6			17371.000	53.000	47.465	-21.000	74.000	5.535	PK

Note 1: Measure Level (dB μ V/m) = Reading Level (dB μ V) + Factor (dB)

Factor (dB) = Cable Loss (dB) + Antenna Factor (dB/m) - PreAmplifier Gain (dB)

Note 2: The amplitude of radiated emissions (frequency range from 18GHz to 40GHz) is that proximity to ambient noise, which also are attenuated more than 20 dB below the permissible value. Therefore, the data is not presented in the report.

6. CONCLUSION

The data collected relate only the item(s) tested and show that this device has been tested to comply with the requirements specified in §15.107 / §15.109 of the FCC Rules and ICES-003 of ISED Rules.

————— The End —————

Appendix A - Test Setup Photograph

Refer to "2008RSU054-UT" file.

Appendix B - EUT Photograph

Refer to "2008RSU054-UE" file.