

FCC Test Report

Report No.: RF170918D05A

FCC ID: 2AI9TOAW-AP125X

Test Model: OAW-AP1251

Received Date: May 8, 2017

Test Date: May 12 ~ Oct. 12, 2017

Issued Date: Dec. 8, 2017

Applicant: ALE USA Inc.

Address: 26801 West Agoura Road, Calabasas, CA 91301

Issued By: Bureau Veritas Consumer Products Services (H.K.) Ltd., Taoyuan Branch

Lab Address: No. 47-2, 14th Ling, Chia Pau Vil., Lin Kou Dist., New Taipei City, Taiwan (R.O.C.)

**FCC Registration /
Designation Number:** 198487 / TW2021



This report is for your exclusive use. Any copying or replication of this report to or for any other person or entity, or use of our name or trademark, is permitted only with our prior written permission. This report sets forth our findings solely with respect to the test samples identified herein. The results set forth in this report are not indicative or representative of the quality or characteristics of the lot from which a test sample was taken or any similar or identical product unless specifically and expressly noted. Our report includes all of the tests requested by you and the results thereof based upon the information that you provided to us. You have 60 days from date of issuance of this report to notify us of any material error or omission caused by our negligence, provided, however, that such notice shall be in writing and shall specifically address the issue you wish to raise. A failure to raise such issue within the prescribed time shall constitute your unqualified acceptance of the completeness of this report, the tests conducted and the correctness of the report contents. Unless specific mention, the uncertainty of measurement has been explicitly taken into account to declare the compliance or non-compliance to the specification. The report must not be used by the client to claim product certification, approval, or endorsement by TAF or any government agencies.

Table of Contents

Release Control Record	4
1 Certificate of Conformity	5
2 Summary of Test Results	6
2.1 Measurement Uncertainty	6
2.2 Modification Record	6
3 General Information	7
3.1 General Description of EUT	7
3.2 Description of Test Modes	9
3.2.1 Test Mode Applicability and Tested Channel Detail	10
3.3 Duty Cycle of Test Signal	13
3.4 Description of Support Units	14
3.4.1 Configuration of System under Test	14
3.5 General Description of Applied Standard	15
4 Test Types and Results	16
4.1 Radiated Emission and Bandedge Measurement.....	16
4.1.1 Limits of Radiated Emission and Bandedge Measurement	16
4.1.2 Test Instruments	17
4.1.3 Test Procedure	18
4.1.4 Deviation from Test Standard	19
4.1.5 Test Setup.....	19
4.1.6 EUT Operating Condition	20
4.1.7 Test Results	21
4.2 Conducted Emission Measurement	59
4.2.1 Limits of Conducted Emission Measurement	59
4.2.2 Test Instruments	59
4.2.3 Test Procedure	60
4.2.4 Deviation from Test Standard	60
4.2.5 Test Setup.....	60
4.2.6 EUT Operating Condition	60
4.2.7 Test Results	61
4.3 Transmit Power Measurement	63
4.3.1 Limits of Transmit Power Measurement	63
4.3.2 Test Setup.....	64
4.3.3 Test Instruments	64
4.3.4 Test Procedure	65
4.3.5 Deviation from Test Standard	65
4.3.6 EUT Operating Condition	65
4.3.7 Test Result.....	66
4.4 Occupied Bandwidth Measurement	75
4.4.1 Test Setup.....	75
4.4.2 Test Instruments	75
4.4.3 Test Procedure	75
4.4.4 Test Results	76
4.5 Peak Power Spectral Density Measurement.....	78
4.5.1 Limits of Peak Power Spectral Density Measurement	78
4.5.2 Test Setup.....	78
4.5.3 Test Instruments	78
4.5.4 Test Procedure	78
4.5.5 Deviation from Test Standard	78
4.5.6 EUT Operating Condition	78
4.5.7 Test Results	79
4.6 Frequency Stability Measurement.....	82

4.6.1	Limits of Frequency Stability Measurement.....	82
4.6.2	Test Setup.....	82
4.6.3	Test Instruments	82
4.6.4	Test Procedure	82
4.6.5	Deviation from Test Standard	82
4.6.6	EUT Operating Condition	82
4.6.7	Test Results	83
5	Pictures of Test Arrangements.....	84
	Appendix – Information on the Testing Laboratories	85

Release Control Record

Issue No.	Description	Date Issued
RF170918D05A	Original release.	Dec. 8, 2017

1 Certificate of Conformity

Product: OmniAccess Stellar
Brand: Alcatel-Lucent Enterprise
Test Model: OAW-AP1251
Sample Status: Engineering sample
Applicant: ALE USA Inc.
Test Date: May 12 ~ Oct. 12, 2017
Standard: 47 CFR FCC Part 15, Subpart E (Section 15.407)
ANSI C63.10: 2013

The above equipment has been tested by **Bureau Veritas Consumer Products Services (H.K.) Ltd., Taoyuan Branch**, and found compliance with the requirement of the above standards. The test record, data evaluation & Equipment Under Test (EUT) configurations represented herein are true and accurate accounts of the measurements of the sample's EMC characteristics under the conditions specified in this report.

Prepared by : Annie Chang , **Date:** Dec. 8, 2017
Annie Chang / Senior Specialist

Approved by : Rex Lai , **Date:** Dec. 8, 2017
Rex Lai / Assistant Manager

2 Summary of Test Results

47 CFR FCC Part 15, Subpart E (Section 15.407)			
FCC Clause	Test Item	Result	Remarks
15.407(b)(6)	AC Power Conducted Emissions	Pass	Meet the requirement of limit. Minimum passing margin is -9.16dB at 0.52891MHz.
15.407(b) (1/2/3/4(i/ii)/6)	Radiated Emissions & Band Edge Measurement	Pass	Meet the requirement of limit. Minimum passing margin is -0.91dB at 5725.00MHz.
15.407(a)(1/2/3)	Max Average Transmit Power	Pass	Meet the requirement of limit.
---	Occupied Bandwidth Measurement	-	Reference only.
15.407(a)(1/2/3)	Peak Power Spectral Density	Pass	Meet the requirement of limit.
15.407(g)	Frequency Stability	Pass	Meet the requirement of limit.
15.203	Antenna Requirement	Pass	Antenna connector is MMCX not a standard connector.

2.1 Measurement Uncertainty

Where relevant, the following measurement uncertainty levels have been estimated for tests performed on the EUT as specified in CISPR 16-4-2:

Measurement	Frequency	Expanded Uncertainty (k=2) (\pm)
Conducted Emissions at mains ports	150kHz ~ 30MHz	2.77 dB
Radiated Emissions up to 1 GHz	9kHz ~ 30MHz	2.38 dB
	30MHz ~ 1000MHz	5.54 dB
Radiated Emissions above 1 GHz	1GHz ~ 6GHz	4.77 dB
	6GHz ~ 18GHz	5.48 dB

2.2 Modification Record

There were no modifications required for compliance.

3 General Information

3.1 General Description of EUT

Product	OmniAccess Stellar
Brand	Alcatel-Lucent Enterprise
Test Model	OAW-AP1251
Status of EUT	Engineering sample
Power Supply Rating	48Vdc from PoE
Modulation Type	64QAM, 16QAM, QPSK, BPSK 256QAM for OFDM in 11ac mode only.
Modulation Technology	OFDM
Transfer Rate	802.11a: 54/48/36/24/18/12/9/6Mbps 802.11n: up to 300Mbps 802.11ac: up to 867Mbps
Operating Frequency	5260 ~ 5320MHz, 5500 ~ 5700MHz
Number of Channel	5260 ~ 5320MHz: 4 for 802.11a, 802.11n (20MHz), 802.11ac (20MHz) 2 for 802.11n (40MHz), 802.11ac (40MHz) 1 for 802.11ac (80MHz) 5500 ~ 5700MHz 11 for 802.11a, 802.11n (20MHz), 802.11ac (20MHz) 5 for 802.11n (40MHz), 802.11ac (40MHz) 2 for 802.11ac (80MHz)
Output Power	5260 ~ 5320MHz: 39.005mW 5500 ~ 5700MHz: 193.703mW
Antenna Type	Refer to note as below
Antenna Connector	Refer to note as below
Accessory Device	N/A
Data Cable Supplied	N/A

Note:

1. This report is issued as a supplementary report to BV CPS report no. RF170918D05-1. The difference compared with original report is adding U-NII-2A, U-NII-2C band, therefore the EUT is re-tested in this report.
2. This report is prepared for FCC class II permissive change.
3. The EUT incorporates a MIMO function. Physically, the EUT provides 2 completed transmitters and 2 receivers.

Modulation Mode	TX FUNCTION
802.11a	2TX
802.11n (20MHz)	2TX
802.11n (40MHz)	2TX
802.11ac (20MHz)	2TX
802.11ac (40MHz)	2TX
802.11ac (80MHz)	2TX

* The modulation and bandwidth are similar for 802.11n mode for 20MHz / 40MHz and 802.11ac mode for 20MHz / 40MHz, therefore investigated worst case to representative mode in test report. (Final test mode refer section 3.2.1)

4. The antennas provided to the EUT, please refer to the following table:

Chain No.	Antenna Type	Antenna Gain (dBi)	Connector Type
Chain 0	Omni	6.62	MMCX
Chain 1	Omni	6.24	

5. The directional gain table:

Max. Gain (dBi)
9.44
Note:
(i) If transmit signals are <i>correlated</i> , then Directional gain = $10 \log[(10^{G_1/20} + 10^{G_2/20} + \dots + 10^{G_N/20})^2 / N_{ANT}]$ dBi [Note the “20”s in the denominator of each exponent and the square of the sum of terms; the object is to combine the signal levels coherently.]

6. The above EUT information is declared by manufacturer and for more detailed features description, please refer to the manufacturer's specifications or user's manual.

3.2 Description of Test Modes

FOR 5260 ~ 5320MHz

4 channels are provided for 802.11a, 802.11n (20MHz), 802.11ac (20MHz):

Channel	Frequency	Channel	Frequency
52	5260 MHz	60	5300 MHz
56	5280 MHz	64	5320 MHz

2 channels are provided for 802.11n (40MHz), 802.11ac (40MHz):

Channel	Frequency	Channel	Frequency
54	5270 MHz	62	5310 MHz

1 channel is provided for 802.11ac (80MHz):

Channel	Frequency
58	5290MHz

FOR 5500 ~ 5700MHz

11 channels are provided for 802.11a, 802.11n (20MHz), 802.11ac (20MHz):

Channel	Frequency	Channel	Frequency
100	5500 MHz	124	5620 MHz
104	5520 MHz	128	5640 MHz
108	5540 MHz	132	5660 MHz
112	5560 MHz	136	5680 MHz
116	5580 MHz	140	5700 MHz
120	5600 MHz		

5 channels are provided for 802.11n (40MHz), 802.11ac (40MHz):

Channel	Frequency	Channel	Frequency
102	5510 MHz	126	5630 MHz
110	5550 MHz	134	5670 MHz
118	5590 MHz		

2 channels are provided for 802.11ac (80MHz):

Channel	Frequency	Channel	Frequency
106	5530MHz	122	5610 MHz

3.2.1 Test Mode Applicability and Tested Channel Detail

EUT Configure Mode	Applicable To				Description
	RE≥1G	RE<1G	PLC	APCM	
-	√	√	√	√	-

Where **RE≥1G**: Radiated Emission above 1GHz **RE<1G**: Radiated Emission below 1GHz
PLC: Power Line Conducted Emission **APCM**: Antenna Port Conducted Measurement

NOTE: The EUT had been pre-tested on the positioned of each 3 axis. The worst case was found when positioned on **Y-plane**

Radiated Emission Test (Above 1GHz):

- Pre-Scan has been conducted to determine the worst-case mode from all possible combinations between available modulations, data rates and antenna ports (if EUT with antenna diversity architecture).
- Following channel(s) was (were) selected for the final test as listed below.

CDD Mode							
EUT Configure Mode	Mode	FREQ. Band (MHz)	Available Channel	Tested Channel	Modulation Technology	Modulation Type	Data Rate (Mbps)
-	802.11a	5260-5320	52 to 64	52, 60, 64	OFDM	BPSK	6
-	802.11ac (20MHz)		52 to 64	52, 60, 64	OFDM	BPSK	6.5
-	802.11ac (40MHz)		54 to 62	54, 62	OFDM	BPSK	13.5
-	802.11ac (80MHz)		58	58	OFDM	BPSK	29.3
-	802.11a	5500-5700	100 to 140	100, 116, 132, 140	OFDM	BPSK	6
-	802.11ac (20MHz)		100 to 140	100, 116, 132, 140	OFDM	BPSK	6.5
-	802.11ac (40MHz)		102 to 134	102, 110, 134	OFDM	BPSK	13.5
-	802.11ac (80MHz)		106 to 122	106, 122	OFDM	BPSK	29.3
Beamforming_NSS1 Mode							
EUT Configure Mode	Mode	FREQ. Band (MHz)	Available Channel	Tested Channel	Modulation Technology	Modulation Type	Data Rate (Mbps)
-	802.11ac (20MHz)	5260-5320	52 to 64	52, 60, 64	OFDM	BPSK	6.5
-	802.11ac (40MHz)		54 to 62	54, 62	OFDM	BPSK	13.5
-	802.11ac (80MHz)		58	58	OFDM	BPSK	29.3
-	802.11ac (20MHz)	5500-5700	100 to 140	100, 116, 132, 140	OFDM	BPSK	6.5
-	802.11ac (40MHz)		102 to 134	102, 110, 134	OFDM	BPSK	13.5
-	802.11ac (80MHz)		106 to 122	106, 122	OFDM	BPSK	29.3

Radiated Emission Test (Below 1GHz):

- Pre-Scan has been conducted to determine the worst-case mode from all possible combinations between available modulations, data rates and antenna ports (if EUT with antenna diversity architecture).
- Following channel(s) was (were) selected for the final test as listed below.

CDD Mode							
EUT Configure Mode	Mode	FREQ. Band (MHz)	Available Channel	Tested Channel	Modulation Technology	Modulation Type	Data Rate (Mbps)
-	802.11a	5260-5320	52 to 64	52	OFDM	BPSK	6
	802.11a	5500-5700	100 to 140		OFDM	BPSK	6

Power Line Conducted Emission Test:

- Pre-Scan has been conducted to determine the worst-case mode from all possible combinations between available modulations, data rates and antenna ports (if EUT with antenna diversity architecture).
- Following channel(s) was (were) selected for the final test as listed below.

CDD Mode							
EUT Configure Mode	Mode	FREQ. Band (MHz)	Available Channel	Tested Channel	Modulation Technology	Modulation Type	Data Rate (Mbps)
-	802.11a	5260-5320	52 to 64	52	OFDM	BPSK	6
	802.11a	5500-5700	100 to 140		OFDM	BPSK	6

Antenna Port Conducted Measurement:

- This item includes all test value of each mode, but only includes spectrum plot of worst value of each mode.
- Pre-Scan has been conducted to determine the worst-case mode from all possible combinations between available modulations, data rates and antenna ports (if EUT with antenna diversity architecture).
- Following channel(s) was (were) selected for the final test as listed below.
- The EUT was tested with CDD MODE & Beamforming_NSS1 MODE for Maximum Peak Output Power test. The worst case was found when the EUT was tested with CDD MODE. Therefore, other test items were tested with CDD MODE only.

CDD Mode							
EUT Configure Mode	Mode	FREQ. Band (MHz)	Available Channel	Tested Channel	Modulation Technology	Modulation Type	Data Rate (Mbps)
-	802.11a	5260-5320	52 to 64	52, 60, 64	OFDM	BPSK	6
-	802.11ac (20MHz)		52 to 64	52, 60, 64	OFDM	BPSK	6.5
-	802.11ac (40MHz)		54 to 62	54, 62	OFDM	BPSK	13.5
-	802.11ac (80MHz)		58	58	OFDM	BPSK	29.3
-	802.11a	5500-5700	100 to 140	100, 116, 132, 140	OFDM	BPSK	6
-	802.11ac (20MHz)		100 to 140	100, 116, 132, 140	OFDM	BPSK	6.5
-	802.11ac (40MHz)		102 to 134	102, 110, 134	OFDM	BPSK	13.5
-	802.11ac (80MHz)		106 to 122	106, 122	OFDM	BPSK	29.3
Beamforming_NSS1 Mode (Output Power Only)							
EUT Configure Mode	Mode	FREQ. Band (MHz)	Available Channel	Tested Channel	Modulation Technology	Modulation Type	Data Rate (Mbps)
-	802.11ac (20MHz)	5260-5320	52 to 64	52, 60, 64	OFDM	BPSK	6.5
-	802.11ac (40MHz)		54 to 62	54, 62	OFDM	BPSK	13.5
-	802.11ac (80MHz)		58	58	OFDM	BPSK	29.3
-	802.11ac (20MHz)	5500-5700	100 to 140	100, 116, 132, 140	OFDM	BPSK	6.5
-	802.11ac (40MHz)		102 to 134	102, 110, 134	OFDM	BPSK	13.5
-	802.11ac (80MHz)		106 to 122	106, 122	OFDM	BPSK	29.3

Test Condition:

Applicable To	Environmental Conditions	Input Power	Tested By
RE \geq 1G	20deg. C, 67%RH	120Vac, 60Hz	Ian Chang
RE<1G	24deg. C, 68%RH	120Vac, 60Hz	Ian Chang
PLC	26deg. C, 77%RH	120Vac, 60Hz	Ian Chang
APCM	25deg. C, 76%RH	120Vac, 60Hz	Saxon Lee

3.3 Duty Cycle of Test Signal

Duty cycle of test signal is > 98 %, duty factor is not required

Duty cycle of test signal is < 98 %, duty factor is required

802.11a: Duty cycle = 2.055/2.139 = 0.961, Duty factor = $10 * \log(1/0.961) = 0.17$

802.11ac (20MHz): Duty cycle = 98.2%

802.11ac (40MHz): Duty cycle = 2.385/2.510 = 0.950, Duty factor = $10 * \log(1/0.950) = 0.22$

802.11ac (80MHz): Duty cycle = 1.116/1.218 = 0.916, Duty factor = $10 * \log(1/0.916) = 0.38$



3.4 Description of Support Units

The EUT has been tested as an independent unit together with other necessary accessories or support units. The following support units or accessories were used to form a representative test configuration during the tests.

ID	Product	Brand	Model No.	Serial No.	FCC ID	Remarks
A.	Notebook PC	DELL	E6530	9331GV1	FCC DoC Approved	Provided by Lab
B.	PoE Adapter	Microsemi	PD-3501G/AC	N/A	N/A	Supplied by client
C.	Load	N/A	N/A	N/A	N/A	Provided by Lab

Note:

1. All power cords of the above support units are non-shielded (1.8m).
2. Items A~B acted as communication partners to transfer data.
3. The rating of support unit B was as follows:
AC I/P: 100-240V, 50/60Hz, 0.43A
DC O/P: 48V, 0.35A

ID	Descriptions	Qty.	Length (m)	Shielding (Yes/No)	Cores (Qty.)	Remarks
1.	LAN cable	1	1.2	N	0	Provided by Lab
2.	LAN cable	1	10	N	0	Provided by Lab
3.	LAN cable	1	1.8	N	0	Provided by Lab

Note: The core(s) is(are) originally attached to the cable(s).

3.4.1 Configuration of System under Test

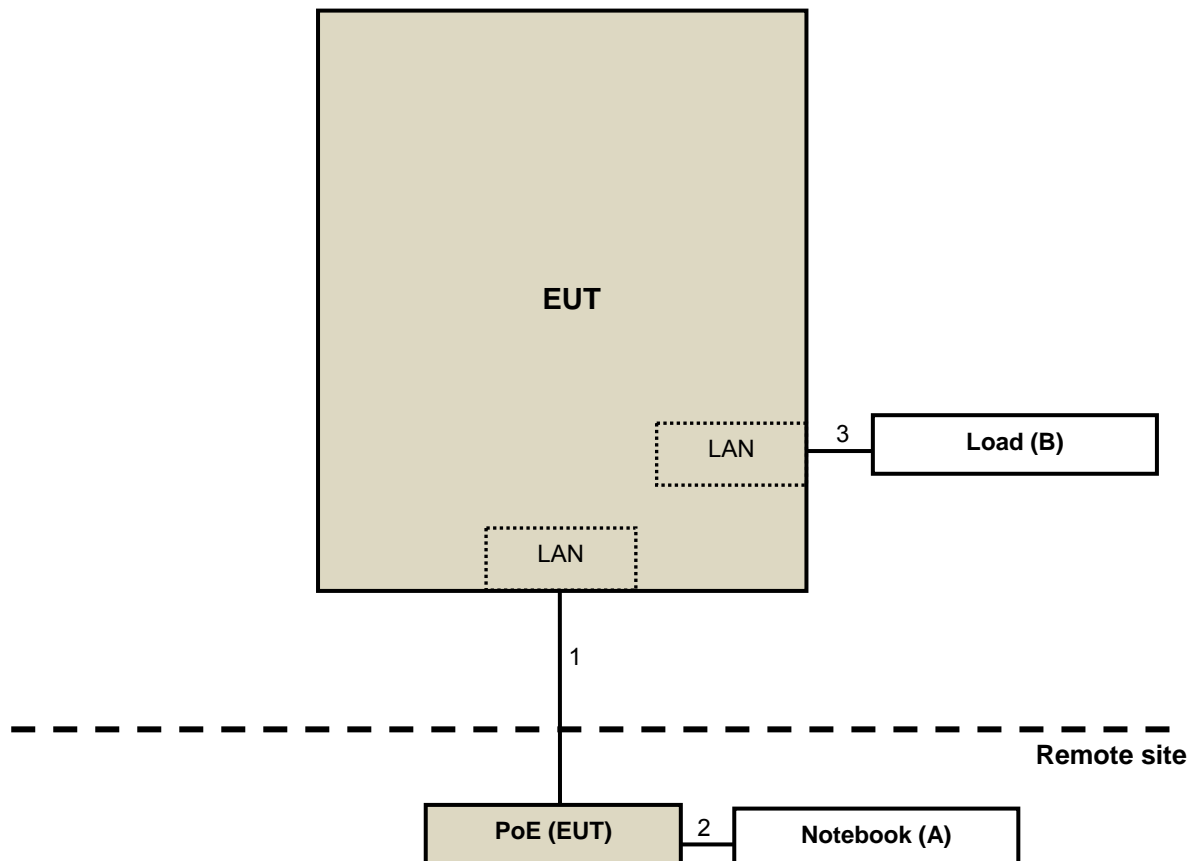

3.5 General Description of Applied Standard

The EUT is a RF Product. According to the specifications of the manufacturer, it must comply with the requirements of the following standards:

FCC Part 15, Subpart E (15.407)
KDB 789033 D02 General UNII Test Procedure New Rules v02r01
KDB 662911 D01 Multiple Transmitter Output v02r01
ANSI C63.10-2013

All test items have been performed and recorded as per the above standards.

4 Test Types and Results

4.1 Radiated Emission and Bandedge Measurement

4.1.1 Limits of Radiated Emission and Bandedge Measurement

Radiated emissions which fall in the restricted bands must comply with the radiated emission limits specified as below table.

Frequencies (MHz)	Field Strength (microvolts/meter)	Measurement Distance (meters)
0.009 ~ 0.490	2400/F(kHz)	300
0.490 ~ 1.705	24000/F(kHz)	30
1.705 ~ 30.0	30	30
30 ~ 88	100	3
88 ~ 216	150	3
216 ~ 960	200	3
Above 960	500	3

NOTE:

- The lower limit shall apply at the transition frequencies.
- Emission level (dBuV/m) = 20 log Emission level (uV/m).
- For frequencies above 1000MHz, the field strength limits are based on average detector, however, the peak field strength of any emission shall not exceed the maximum permitted average limits, specified above by more than 20dB under any condition of modulation.

Limits of unwanted emission out of the restricted bands

Applicable To		Limit	
789033 D02 General UNII Test Procedure New Rules v02r01		Field Strength at 3m	
		PK:74 (dBuV/m)	AV:54 (dBuV/m)
Frequency Band	Applicable To	EIRP Limit	Equivalent Field Strength at 3m
5150~5250 MHz	15.407(b)(1)	PK:-27 (dBm/MHz)	PK:68.2(dBuV/m)
5250~5350 MHz	15.407(b)(2)		
5470~5725 MHz	15.407(b)(3)		
5725~5850 MHz	<input type="checkbox"/> 15.407(b)(4)(i)	PK:-27 (dBm/MHz) ^{*1} PK:10 (dBm/MHz) ^{*2} PK:15.6 (dBm/MHz) ^{*3} PK:27 (dBm/MHz) ^{*4}	PK: 68.2(dBuV/m) ^{*1} PK:105.2 (dBuV/m) ^{*2} PK: 110.8(dBuV/m) ^{*3} PK:122.2 (dBuV/m) ^{*4}
	<input type="checkbox"/> 15.407(b)(4)(ii)	Emission limits in section 15.247(d)	
^{*1} beyond 75 MHz or more above of the band edge.		^{*2} below the band edge increasing linearly to 10 dBm/MHz at 25 MHz above.	
^{*3} below the band edge increasing linearly to a level of 15.6 dBm/MHz at 5 MHz above.		^{*4} from 5 MHz above or below the band edge increasing linearly to a level of 27 dBm/MHz at the band edge.	

Note:

The following formula is used to convert the equipment isotropic radiated power (eirp) to field strength:

$$E = \frac{1000000\sqrt{30P}}{3} \mu\text{V/m, where P is the eirp (Watts).}$$

4.1.2 Test Instruments

DESCRIPTION & MANUFACTURER	MODEL NO.	SERIAL NO.	CALIBRATED DATE	CALIBRATED UNTIL
HP Preamplifier	8447D	2432A03504	Feb. 21, 2017	Feb. 20, 2018
HP Preamplifier	8449B	3008A01201	Feb. 22, 2017	Feb. 21, 2018
MITEQ Preamplifier	AMF-6F-260400-33-8P	892164	Feb. 21, 2017	Feb. 20, 2018
Agilent TEST RECEIVER	N9038A	MY51210129	Feb. 8, 2017	Feb. 7, 2018
Schwarzbeck Antenna	VULB 9168	139	Dec. 13, 2016	Dec. 12, 2017
Schwarzbeck Horn Antenna	BBHA-9170	212	Dec. 30, 2016	Dec. 29, 2017
Schwarzbeck Horn Antenna	BBHA 9120-D1	D130	Dec. 27, 2016	Dec. 26, 2017
ADT. Turn Table	TT100	0306	NA	NA
ADT. Tower	AT100	0306	NA	NA
Software	Radiated_V7.6.15.9.5	NA	NA	NA
SUHNER RF cable With 4dB PAD	SF104	CABLE-CH6	Aug. 14, 2017	Aug. 13, 2018
SUHNER RF cable With 3dB PAD	SF102	Cable-CH8-3.6m	Aug. 14, 2017	Aug. 13, 2018
KEYSIGHT MIMO Powermeasurement Test set	U2021XA	U2021XA-001	May 25, 2016	May 24, 2017
			May 31, 2017	May 30, 2018
KEYSIGHT Spectrum Analyzer	N9030A	MY54490260	Jul. 26, 2016	Jul. 25, 2017
			Jul. 26, 2017	Jul. 25, 2018
Loop Antenna EMCI	LPA600	270	Aug. 20, 2015	Aug. 19, 2017
EMCO Horn Antenna	3115	00028257	Dec. 15, 2016	Dec. 14, 2017
Highpass filter Wainwright Instruments	WHK 3.1/18G-10SS	SN 8	NA	NA
ROHDE & SCHWARZ Spectrum Analyzer	FSV40	101042	Sep. 29, 2017	Sep. 28, 2018
Anritsu Power Sensor	MA2411B	0738404	Apr. 24, 2017	Apr. 23, 2018
Anritsu Power Meter	ML2495A	0842014	Apr. 24, 2017	Apr. 23, 2018
Temperature & Humidity Chamber	MHU-225AU	920409	May 25, 2017	May 24, 2018
DIGITAL POWER METER IDRC	CP-240	240515	Sep. 9, 2016	Sep. 8, 2017
			Sep. 8, 2017	Sep. 7, 2018
AC Power Source ExTech	CFW-105	E000603	Sep. 8, 2017	Sep. 7, 2018

- NOTE:**
1. The calibration interval of the above test instruments is 12/24 months. And the calibrations are traceable to NML/ROC and NIST/USA.
 2. The horn antenna and HP preamplifier (model: 8449B) are used only for the measurement of emission frequency above 1GHz if tested.
 3. The test was performed in Chamber No. 6.
 4. The Industry Canada Reference No. IC 7450E-6.
 5. The FCC Designation Number is TW2021.
 6. Tested Date: May 12 ~ Jul. 31, 2017

4.1.3 Test Procedure

For Radiated emission below 30MHz

- a. The EUT was placed on the top of a rotating table 0.8 meters above the ground at a 3 meter chamber room. The table was rotated 360 degrees to determine the position of the highest radiation.
- b. The EUT was set 3 meters away from the interference-receiving antenna, which was mounted on the top of a variable-height antenna tower.
- c. Both X and Y axes of the antenna are set to make the measurement.
- d. For each suspected emission, the EUT was arranged to its worst case and the rotatable table was turned from 0 degrees to 360 degrees to find the maximum reading.
- e. The test-receiver system was set to Quasi-Peak Detect Function and Specified Bandwidth with Maximum Hold Mode.

NOTE:

1. The resolution bandwidth and video bandwidth of test receiver/spectrum analyzer is 9kHz at frequency below 30MHz.

For Radiated emission above 30MHz

- a. The EUT was placed on the top of a rotating table 0.8 meters (for 30MHz ~ 1GHz) / 1.5 meters (for above 1GHz) above the ground at 3 meter chamber room for test. The table was rotated 360 degrees to determine the position of the highest radiation.
- b. The EUT was set 3 meters away from the interference-receiving antenna, which was mounted on the top of a variable-height antenna tower.
- c. The height of antenna is varied from one meter to four meters above the ground to determine the maximum value of the field strength. Both horizontal and vertical polarizations of the antenna are set to make the measurement.
- d. For each suspected emission, the EUT was arranged to its worst case and then the antenna was tuned to heights from 1 meter to 4 meters and the rotatable table was turned from 0 degrees to 360 degrees to find the maximum reading.
- e. The test-receiver system was set to quasi-peak detect function and specified bandwidth with maximum hold mode when the test frequency is below 1 GHz.
- f. The test-receiver system was set to peak and average detect function and specified bandwidth with maximum hold mode when the test frequency is above 1 GHz. If the peak reading value also meets average limit, measurement with the average detector is unnecessary.

Note:

1. The resolution bandwidth and video bandwidth of test receiver/spectrum analyzer is 120kHz for Quasi-peak detection (QP) at frequency below 1GHz.
2. The resolution bandwidth of test receiver/spectrum analyzer is 1 MHz and the video bandwidth is 3 MHz for Peak detection (PK) at frequency above 1GHz.
3. The resolution bandwidth of test receiver/spectrum analyzer is 1MHz and the video bandwidth is $\geq 1/T$ (Duty cycle < 98%) or 10Hz (Duty cycle $\geq 98\%$) for Average detection (AV) at frequency above 1GHz.
4. All modes of operation were investigated and the worst-case emissions are reported.

4.1.4 Deviation from Test Standard

No deviation.

4.1.5 Test Setup

For Radiated emission below 30MHz

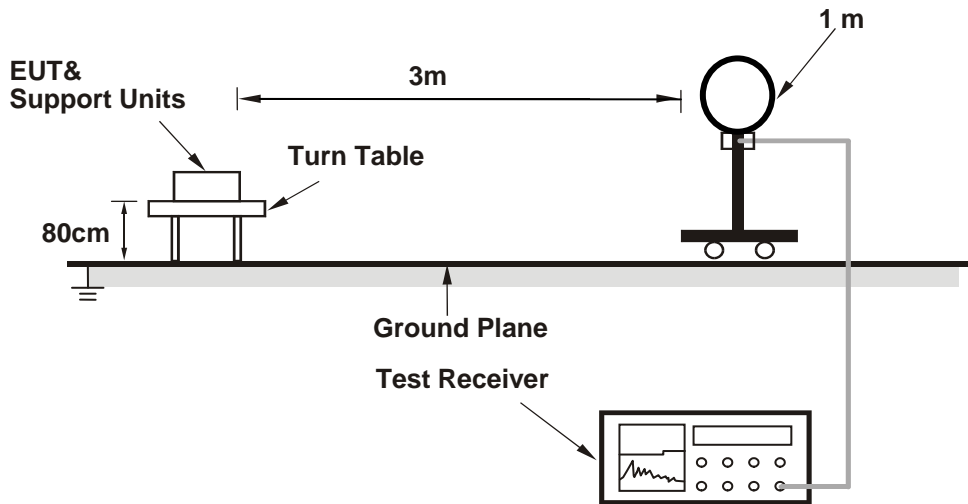

For Radiated emission 30MHz to 1GHz

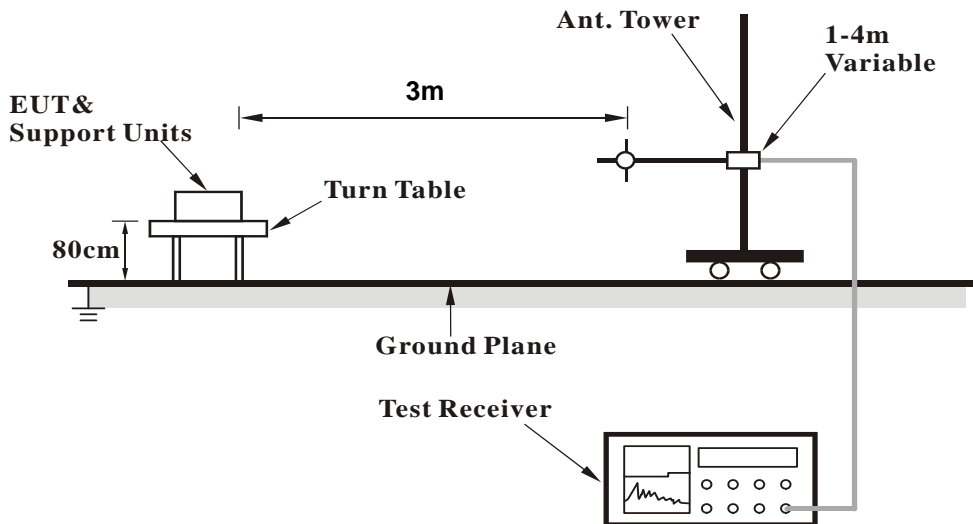

For Radiated emission above 1GHz

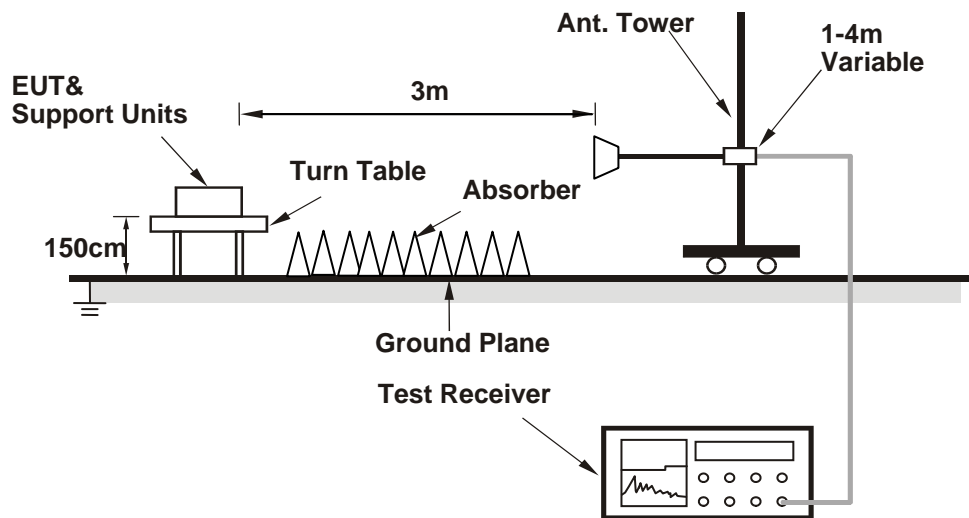

For the actual test configuration, please refer to the attached file (Test Setup Photo).

4.1.6 EUT Operating Condition

Set the EUT under transmission condition continuously at specific channel frequency.

4.1.7 Test Results

CDD MODE

Above 1GHz Data:

802.11a

CHANNEL	TX Channel 52	DETECTOR FUNCTION	Peak (PK)
FREQUENCY RANGE	1GHz ~ 40GHz		Average (AV)

ANTENNA POLARITY & TEST DISTANCE: HORIZONTAL AT 3 M

NO.	FREQ. (MHz)	EMISSION LEVEL (dBuV/m)	LIMIT (dBuV/m)	MARGIN (dB)	ANTENNA HEIGHT (m)	TABLE ANGLE (Degree)	RAW VALUE (dBuV)	CORRECTION FACTOR (dB/m)
1	5150.00	61.25 PK	74.00	-12.75	2.23 H	263	53.45	7.80
2	5150.00	46.28 AV	54.00	-7.72	2.23 H	263	38.48	7.80
3	*5260.00	115.32 PK			2.23 H	263	107.08	8.24
4	*5260.00	104.20 AV			2.23 H	263	95.96	8.24
5	#10520.00	59.75 PK	74.00	-14.25	1.68 H	251	40.65	19.10
6	#10520.00	45.75 AV	54.00	-8.25	1.68 H	251	26.65	19.10

ANTENNA POLARITY & TEST DISTANCE: VERTICAL AT 3 M

NO.	FREQ. (MHz)	EMISSION LEVEL (dBuV/m)	LIMIT (dBuV/m)	MARGIN (dB)	ANTENNA HEIGHT (m)	TABLE ANGLE (Degree)	RAW VALUE (dBuV)	CORRECTION FACTOR (dB/m)
1	5150.00	60.83 PK	74.00	-13.17	2.19 V	300	53.03	7.80
2	5150.00	45.67 AV	54.00	-8.33	2.19 V	300	37.87	7.80
3	*5260.00	109.80 PK			2.19 V	300	101.56	8.24
4	*5260.00	98.23 AV			2.19 V	300	89.99	8.24
5	#10520.00	58.74 PK	74.00	-15.26	1.74 V	118	39.64	19.10
6	#10520.00	44.74 AV	54.00	-9.26	1.74 V	118	25.64	19.10

REMARKS:

1. Emission Level(dBuV/m) = Raw Value(dBuV) + Correction Factor(dB/m)
2. Correction Factor(dB/m) = Antenna Factor(dB/m) + Cable Factor(dB) – Pre-Amplifier Factor(dB)
3. The other emission levels were very low against the limit.
4. Margin value = Emission Level – Limit value
5. " * ": Fundamental frequency.
6. " # ": The radiated frequency is out of the restricted band.

CHANNEL	TX Channel 60	DETECTOR FUNCTION	Peak (PK)
FREQUENCY RANGE	1GHz ~ 40GHz		Average (AV)

ANTENNA POLARITY & TEST DISTANCE: HORIZONTAL AT 3 M

NO.	FREQ. (MHz)	EMISSION LEVEL (dBuV/m)	LIMIT (dBuV/m)	MARGIN (dB)	ANTENNA HEIGHT (m)	TABLE ANGLE (Degree)	RAW VALUE (dBuV)	CORRECTION FACTOR (dB/m)
1	*5300.00	114.67 PK			2.30 H	263	106.30	8.37
2	*5300.00	103.86 AV			2.30 H	263	95.49	8.37
3	10600.00	60.00 PK	74.00	-14.00	1.86 H	199	40.65	19.35
4	10600.00	45.74 AV	54.00	-8.26	1.86 H	199	26.39	19.35

ANTENNA POLARITY & TEST DISTANCE: VERTICAL AT 3 M

NO.	FREQ. (MHz)	EMISSION LEVEL (dBuV/m)	LIMIT (dBuV/m)	MARGIN (dB)	ANTENNA HEIGHT (m)	TABLE ANGLE (Degree)	RAW VALUE (dBuV)	CORRECTION FACTOR (dB/m)
1	*5300.00	108.91 PK			2.23 V	294	100.54	8.37
2	*5300.00	97.01 AV			2.23 V	294	88.64	8.37
3	10600.00	58.69 PK	74.00	-15.31	2.03 V	162	39.34	19.35
4	10600.00	44.69 AV	54.00	-9.31	2.03 V	162	25.34	19.35

REMARKS:

1. Emission Level(dBuV/m) = Raw Value(dBuV) + Correction Factor(dB/m)
2. Correction Factor(dB/m) = Antenna Factor(dB/m) + Cable Factor(dB) – Pre-Amplifier Factor(dB)
3. The other emission levels were very low against the limit.
4. Margin value = Emission Level – Limit value
5. " * ": Fundamental frequency.

CHANNEL	TX Channel 64	DETECTOR FUNCTION	Peak (PK)
FREQUENCY RANGE	1GHz ~ 40GHz		Average (AV)

ANTENNA POLARITY & TEST DISTANCE: HORIZONTAL AT 3 M

NO.	FREQ. (MHz)	EMISSION LEVEL (dBuV/m)	LIMIT (dBuV/m)	MARGIN (dB)	ANTENNA HEIGHT (m)	TABLE ANGLE (Degree)	RAW VALUE (dBuV)	CORRECTION FACTOR (dB/m)
1	*5320.00	114.04 PK			2.27 H	263	105.58	8.46
2	*5320.00	102.85 AV			2.27 H	263	94.39	8.46
3	5350.00	63.90 PK	74.00	-10.10	2.27 H	263	55.32	8.58
4	5350.00	49.10 AV	54.00	-4.90	2.27 H	263	40.52	8.58
5	10640.00	60.05 PK	74.00	-13.95	1.42 H	215	40.64	19.41
6	10640.00	46.35 AV	54.00	-7.65	1.42 H	215	26.94	19.41

ANTENNA POLARITY & TEST DISTANCE: VERTICAL AT 3 M

NO.	FREQ. (MHz)	EMISSION LEVEL (dBuV/m)	LIMIT (dBuV/m)	MARGIN (dB)	ANTENNA HEIGHT (m)	TABLE ANGLE (Degree)	RAW VALUE (dBuV)	CORRECTION FACTOR (dB/m)
1	*5320.00	109.00 PK			2.16 V	295	100.54	8.46
2	*5320.00	96.59 AV			2.16 V	295	88.13	8.46
3	5350.00	61.74 PK	74.00	-12.26	2.16 V	295	53.16	8.58
4	5350.00	47.22 AV	54.00	-6.78	2.16 V	295	38.64	8.58
5	10640.00	58.62 PK	74.00	-15.38	1.18 V	341	39.21	19.41
6	10640.00	44.75 AV	54.00	-9.25	1.18 V	341	25.34	19.41

REMARKS:

1. Emission Level(dBuV/m) = Raw Value(dBuV) + Correction Factor(dB/m)
2. Correction Factor(dB/m) = Antenna Factor(dB/m) + Cable Factor(dB) – Pre-Amplifier Factor(dB)
3. The other emission levels were very low against the limit.
4. Margin value = Emission Level – Limit value
5. " * ": Fundamental frequency.

CHANNEL	TX Channel 100	DETECTOR FUNCTION	Peak (PK)
FREQUENCY RANGE	1GHz ~ 40GHz		Average (AV)

ANTENNA POLARITY & TEST DISTANCE: HORIZONTAL AT 3 M

NO.	FREQ. (MHz)	EMISSION LEVEL (dBuV/m)	LIMIT (dBuV/m)	MARGIN (dB)	ANTENNA HEIGHT (m)	TABLE ANGLE (Degree)	RAW VALUE (dBuV)	CORRECTION FACTOR (dB/m)
1	5460.00	61.00 PK	74.00	-13.00	2.31 H	261	51.91	9.09
2	5460.00	47.29 AV	54.00	-6.71	2.31 H	261	38.20	9.09
3	5470.00	64.72 PK	68.20	-3.48	2.31 H	261	55.58	9.14
4	*5500.00	113.21 PK			2.31 H	261	103.92	9.29
5	*5500.00	102.15 AV			2.31 H	261	92.86	9.29
6	11000.00	60.99 PK	74.00	-13.01	1.34 H	267	40.25	20.74
7	11000.00	47.10 AV	54.00	-6.90	1.34 H	267	26.36	20.74

ANTENNA POLARITY & TEST DISTANCE: VERTICAL AT 3 M

NO.	FREQ. (MHz)	EMISSION LEVEL (dBuV/m)	LIMIT (dBuV/m)	MARGIN (dB)	ANTENNA HEIGHT (m)	TABLE ANGLE (Degree)	RAW VALUE (dBuV)	CORRECTION FACTOR (dB/m)
1	5460.00	59.78 PK	74.00	-14.22	2.17 V	294	50.69	9.09
2	5460.00	46.77 AV	54.00	-7.23	2.17 V	294	37.68	9.09
3	5470.00	62.75 PK	68.20	-5.45	2.17 V	294	53.61	9.14
4	*5500.00	107.14 PK			2.17 V	294	97.85	9.29
5	*5500.00	95.98 AV			2.17 V	294	86.69	9.29
6	11000.00	60.08 PK	74.00	-13.92	1.88 V	241	39.34	20.74
7	11000.00	46.55 AV	54.00	-7.45	1.88 V	241	25.81	20.74

REMARKS:

1. Emission Level(dBuV/m) = Raw Value(dBuV) + Correction Factor(dB/m)
2. Correction Factor(dB/m) = Antenna Factor(dB/m) + Cable Factor(dB) – Pre-Amplifier Factor(dB)
3. The other emission levels were very low against the limit.
4. Margin value = Emission Level – Limit value
5. " * ": Fundamental frequency.

CHANNEL	TX Channel 116	DETECTOR FUNCTION	Peak (PK)
FREQUENCY RANGE	1GHz ~ 40GHz		Average (AV)

ANTENNA POLARITY & TEST DISTANCE: HORIZONTAL AT 3 M

NO.	FREQ. (MHz)	EMISSION LEVEL (dBuV/m)	LIMIT (dBuV/m)	MARGIN (dB)	ANTENNA HEIGHT (m)	TABLE ANGLE (Degree)	RAW VALUE (dBuV)	CORRECTION FACTOR (dB/m)
1	*5580.00	113.68 PK			2.15 H	263	104.35	9.33
2	*5580.00	102.65 AV			2.15 H	263	93.32	9.33
3	11160.00	60.43 PK	74.00	-13.57	2.30 H	22	40.16	20.27
4	11160.00	46.91 AV	54.00	-7.09	2.30 H	22	26.64	20.27

ANTENNA POLARITY & TEST DISTANCE: VERTICAL AT 3 M

NO.	FREQ. (MHz)	EMISSION LEVEL (dBuV/m)	LIMIT (dBuV/m)	MARGIN (dB)	ANTENNA HEIGHT (m)	TABLE ANGLE (Degree)	RAW VALUE (dBuV)	CORRECTION FACTOR (dB/m)
1	*5580.00	108.09 PK			2.10 V	289	98.76	9.33
2	*5580.00	97.02 AV			2.10 V	289	87.69	9.33
3	11160.00	60.02 PK	74.00	-13.98	1.78 V	46	39.75	20.27
4	11160.00	45.91 AV	54.00	-8.09	1.78 V	46	25.64	20.27

REMARKS:

1. Emission Level(dBuV/m) = Raw Value(dBuV) + Correction Factor(dB/m)
2. Correction Factor(dB/m) = Antenna Factor(dB/m) + Cable Factor(dB) – Pre-Amplifier Factor(dB)
3. The other emission levels were very low against the limit.
4. Margin value = Emission Level – Limit value
5. " * ": Fundamental frequency.

CHANNEL	TX Channel 132	DETECTOR FUNCTION	Peak (PK)
FREQUENCY RANGE	1GHz ~ 40GHz		Average (AV)

ANTENNA POLARITY & TEST DISTANCE: HORIZONTAL AT 3 M

NO.	FREQ. (MHz)	EMISSION LEVEL (dBuV/m)	LIMIT (dBuV/m)	MARGIN (dB)	ANTENNA HEIGHT (m)	TABLE ANGLE (Degree)	RAW VALUE (dBuV)	CORRECTION FACTOR (dB/m)
1	*5660.00	113.45 PK			2.10 H	263	104.09	9.36
2	*5660.00	103.07 AV			2.10 H	263	93.71	9.36
3	11320.00	60.56 PK	74.00	-13.44	1.53 H	332	40.47	20.09
4	11320.00	46.71 AV	54.00	-7.29	1.53 H	332	26.62	20.09

ANTENNA POLARITY & TEST DISTANCE: VERTICAL AT 3 M

NO.	FREQ. (MHz)	EMISSION LEVEL (dBuV/m)	LIMIT (dBuV/m)	MARGIN (dB)	ANTENNA HEIGHT (m)	TABLE ANGLE (Degree)	RAW VALUE (dBuV)	CORRECTION FACTOR (dB/m)
1	*5660.00	108.12 PK			2.20 V	287	98.76	9.36
2	*5660.00	96.59 AV			2.20 V	287	87.23	9.36
3	11320.00	59.48 PK	74.00	-14.52	1.88 V	119	39.39	20.09
4	11320.00	45.15 AV	54.00	-8.85	1.88 V	119	25.06	20.09

REMARKS:

1. Emission Level(dBuV/m) = Raw Value(dBuV) + Correction Factor(dB/m)
2. Correction Factor(dB/m) = Antenna Factor(dB/m) + Cable Factor(dB) – Pre-Amplifier Factor(dB)
3. The other emission levels were very low against the limit.
4. Margin value = Emission Level – Limit value
5. " * ": Fundamental frequency.

CHANNEL	TX Channel 140	DETECTOR FUNCTION	Peak (PK)
FREQUENCY RANGE	1GHz ~ 40GHz		Average (AV)

ANTENNA POLARITY & TEST DISTANCE: HORIZONTAL AT 3 M

NO.	FREQ. (MHz)	EMISSION LEVEL (dBuV/m)	LIMIT (dBuV/m)	MARGIN (dB)	ANTENNA HEIGHT (m)	TABLE ANGLE (Degree)	RAW VALUE (dBuV)	CORRECTION FACTOR (dB/m)
1	*5700.00	112.53 PK			2.10 H	263	103.16	9.37
2	*5700.00	101.52 AV			2.10 H	263	92.15	9.37
3	5725.00	67.29 PK	68.20	-0.91	2.10 H	263	57.91	9.38
4	11400.00	60.70 PK	74.00	-13.30	1.37 H	243	40.55	20.15
5	11400.00	47.04 AV	54.00	-6.96	1.37 H	243	26.89	20.15

ANTENNA POLARITY & TEST DISTANCE: VERTICAL AT 3 M

NO.	FREQ. (MHz)	EMISSION LEVEL (dBuV/m)	LIMIT (dBuV/m)	MARGIN (dB)	ANTENNA HEIGHT (m)	TABLE ANGLE (Degree)	RAW VALUE (dBuV)	CORRECTION FACTOR (dB/m)
1	*5700.00	107.26 PK			2.23 V	360	97.89	9.37
2	*5700.00	106.26 AV			2.23 V	360	96.89	9.37
3	5725.00	65.20 PK	68.20	-3.00	2.23 V	360	55.82	9.38
4	11400.00	59.50 PK	74.00	-14.50	1.54 V	85	39.35	20.15
5	11400.00	45.61 AV	54.00	-8.39	1.54 V	85	25.46	20.15

REMARKS:

1. Emission Level(dBuV/m) = Raw Value(dBuV) + Correction Factor(dB/m)
2. Correction Factor(dB/m) = Antenna Factor(dB/m) + Cable Factor(dB) – Pre-Amplifier Factor(dB)
3. The other emission levels were very low against the limit.
4. Margin value = Emission Level – Limit value
5. " * ": Fundamental frequency.

802.11ac (20MHz)

CHANNEL	TX Channel 52	DETECTOR FUNCTION	Peak (PK)
FREQUENCY RANGE	1GHz ~ 40GHz		Average (AV)

ANTENNA POLARITY & TEST DISTANCE: HORIZONTAL AT 3 M

NO.	FREQ. (MHz)	EMISSION LEVEL (dBuV/m)	LIMIT (dBuV/m)	MARGIN (dB)	ANTENNA HEIGHT (m)	TABLE ANGLE (Degree)	RAW VALUE (dBuV)	CORRECTION FACTOR (dB/m)
1	5150.00	59.43 PK	74.00	-14.57	2.22 H	264	51.63	7.80
2	5150.00	46.28 AV	54.00	-7.72	2.22 H	264	38.48	7.80
3	*5260.00	115.08 PK			2.22 H	264	106.84	8.24
4	*5260.00	102.39 AV			2.22 H	264	94.15	8.24
5	10520.00	59.74 PK	74.00	-14.26	1.97 H	184	40.64	19.10
6	10520.00	45.46 AV	54.00	-8.54	1.97 H	184	26.36	19.10

ANTENNA POLARITY & TEST DISTANCE: VERTICAL AT 3 M

NO.	FREQ. (MHz)	EMISSION LEVEL (dBuV/m)	LIMIT (dBuV/m)	MARGIN (dB)	ANTENNA HEIGHT (m)	TABLE ANGLE (Degree)	RAW VALUE (dBuV)	CORRECTION FACTOR (dB/m)
1	5150.00	58.91 PK	74.00	-15.09	1.97 V	299	51.11	7.80
2	5150.00	45.76 AV	54.00	-8.24	1.97 V	299	37.96	7.80
3	*5260.00	110.58 PK			1.97 V	299	102.34	8.24
4	*5260.00	98.93 AV			1.97 V	299	90.69	8.24
5	10520.00	58.42 PK	74.00	-15.58	1.55 V	132	39.32	19.10
6	10520.00	44.29 AV	54.00	-9.71	1.55 V	132	25.19	19.10

REMARKS:

1. Emission Level(dBuV/m) = Raw Value(dBuV) + Correction Factor(dB/m)
2. Correction Factor(dB/m) = Antenna Factor(dB/m) + Cable Factor(dB) – Pre-Amplifier Factor(dB)
3. The other emission levels were very low against the limit.
4. Margin value = Emission Level – Limit value
5. " * ": Fundamental frequency.

CHANNEL	TX Channel 60	DETECTOR FUNCTION	Peak (PK)
FREQUENCY RANGE	1GHz ~ 40GHz		Average (AV)

ANTENNA POLARITY & TEST DISTANCE: HORIZONTAL AT 3 M

NO.	FREQ. (MHz)	EMISSION LEVEL (dBuV/m)	LIMIT (dBuV/m)	MARGIN (dB)	ANTENNA HEIGHT (m)	TABLE ANGLE (Degree)	RAW VALUE (dBuV)	CORRECTION FACTOR (dB/m)
1	*5300.00	114.96 PK			2.29 H	263	106.59	8.37
2	*5300.00	102.02 AV			2.29 H	263	93.65	8.37
3	10600.00	59.71 PK	74.00	-14.29	1.45 H	320	40.36	19.35
4	10600.00	45.49 AV	54.00	-8.51	1.45 H	320	26.14	19.35

ANTENNA POLARITY & TEST DISTANCE: VERTICAL AT 3 M

NO.	FREQ. (MHz)	EMISSION LEVEL (dBuV/m)	LIMIT (dBuV/m)	MARGIN (dB)	ANTENNA HEIGHT (m)	TABLE ANGLE (Degree)	RAW VALUE (dBuV)	CORRECTION FACTOR (dB/m)
1	*5300.00	110.50 PK			1.99 V	182	102.13	8.37
2	*5300.00	99.40 AV			1.99 V	182	91.03	8.37
3	10600.00	58.99 PK	74.00	-15.01	1.65 V	117	39.64	19.35
4	10600.00	44.64 AV	54.00	-9.36	1.65 V	117	25.29	19.35

REMARKS:

1. Emission Level(dBuV/m) = Raw Value(dBuV) + Correction Factor(dB/m)
2. Correction Factor(dB/m) = Antenna Factor(dB/m) + Cable Factor(dB) – Pre-Amplifier Factor(dB)
3. The other emission levels were very low against the limit.
4. Margin value = Emission Level – Limit value
5. " * ": Fundamental frequency.

CHANNEL	TX Channel 64	DETECTOR FUNCTION	Peak (PK)
FREQUENCY RANGE	1GHz ~ 40GHz		Average (AV)

ANTENNA POLARITY & TEST DISTANCE: HORIZONTAL AT 3 M

NO.	FREQ. (MHz)	EMISSION LEVEL (dBuV/m)	LIMIT (dBuV/m)	MARGIN (dB)	ANTENNA HEIGHT (m)	TABLE ANGLE (Degree)	RAW VALUE (dBuV)	CORRECTION FACTOR (dB/m)
1	*5320.00	114.07 PK			2.29 H	264	105.61	8.46
2	*5320.00	100.91 AV			2.29 H	264	92.45	8.46
3	5350.00	62.21 PK	74.00	-11.79	2.29 H	264	53.63	8.58
4	5350.00	47.49 AV	54.00	-6.51	2.29 H	264	38.91	8.58
5	10640.00	59.92 PK	74.00	-14.08	1.58 H	269	40.51	19.41
6	10640.00	45.54 AV	54.00	-8.46	1.58 H	269	26.13	19.41

ANTENNA POLARITY & TEST DISTANCE: VERTICAL AT 3 M

NO.	FREQ. (MHz)	EMISSION LEVEL (dBuV/m)	LIMIT (dBuV/m)	MARGIN (dB)	ANTENNA HEIGHT (m)	TABLE ANGLE (Degree)	RAW VALUE (dBuV)	CORRECTION FACTOR (dB/m)
1	*5320.00	109.92 PK			1.89 V	299	101.46	8.46
2	*5320.00	98.15 AV			1.89 V	299	89.69	8.46
3	5350.00	59.84 PK	74.00	-14.16	1.89 V	299	51.26	8.58
4	5350.00	46.47 AV	54.00	-7.53	1.89 V	299	37.89	8.58
5	10640.00	58.72 PK	74.00	-15.28	1.19 V	264	39.31	19.41
6	10640.00	44.54 AV	54.00	-9.46	1.19 V	264	25.13	19.41

REMARKS:

1. Emission Level(dBuV/m) = Raw Value(dBuV) + Correction Factor(dB/m)
2. Correction Factor(dB/m) = Antenna Factor(dB/m) + Cable Factor(dB) – Pre-Amplifier Factor(dB)
3. The other emission levels were very low against the limit.
4. Margin value = Emission Level – Limit value
5. " * ": Fundamental frequency.

CHANNEL	TX Channel 100	DETECTOR FUNCTION	Peak (PK)
FREQUENCY RANGE	1GHz ~ 40GHz		Average (AV)

ANTENNA POLARITY & TEST DISTANCE: HORIZONTAL AT 3 M

NO.	FREQ. (MHz)	EMISSION LEVEL (dBuV/m)	LIMIT (dBuV/m)	MARGIN (dB)	ANTENNA HEIGHT (m)	TABLE ANGLE (Degree)	RAW VALUE (dBuV)	CORRECTION FACTOR (dB/m)
1	5460.00	61.63 PK	74.00	-12.37	2.54 H	264	52.54	9.09
2	5460.00	47.42 AV	54.00	-6.58	2.54 H	264	38.33	9.09
3	5470.00	62.89 PK	68.20	-5.31	2.54 H	264	53.75	9.14
4	*5500.00	113.01 PK			2.54 H	264	103.72	9.29
5	*5500.00	101.25 AV			2.54 H	264	91.96	9.29
6	11000.00	61.31 PK	74.00	-12.69	1.18 H	294	40.57	20.74
7	11000.00	47.68 AV	54.00	-6.32	1.18 H	294	26.94	20.74

ANTENNA POLARITY & TEST DISTANCE: VERTICAL AT 3 M

NO.	FREQ. (MHz)	EMISSION LEVEL (dBuV/m)	LIMIT (dBuV/m)	MARGIN (dB)	ANTENNA HEIGHT (m)	TABLE ANGLE (Degree)	RAW VALUE (dBuV)	CORRECTION FACTOR (dB/m)
1	5460.00	60.58 PK	74.00	-13.42	1.91 V	187	51.49	9.09
2	5460.00	46.97 AV	54.00	-7.03	1.91 V	187	37.88	9.09
3	5470.00	60.60 PK	68.20	-7.60	1.91 V	187	51.46	9.14
4	*5500.00	109.18 PK			1.91 V	187	99.89	9.29
5	*5500.00	96.75 AV			1.91 V	187	87.46	9.29
6	11000.00	59.99 PK	74.00	-14.01	2.20 V	219	39.25	20.74
7	11000.00	46.22 AV	54.00	-7.78	2.20 V	219	25.48	20.74

REMARKS:

1. Emission Level(dBuV/m) = Raw Value(dBuV) + Correction Factor(dB/m)
2. Correction Factor(dB/m) = Antenna Factor(dB/m) + Cable Factor(dB) – Pre-Amplifier Factor(dB)
3. The other emission levels were very low against the limit.
4. Margin value = Emission Level – Limit value
5. " * ": Fundamental frequency.

CHANNEL	TX Channel 116	DETECTOR FUNCTION	Peak (PK)
FREQUENCY RANGE	1GHz ~ 40GHz		Average (AV)

ANTENNA POLARITY & TEST DISTANCE: HORIZONTAL AT 3 M

NO.	FREQ. (MHz)	EMISSION LEVEL (dBuV/m)	LIMIT (dBuV/m)	MARGIN (dB)	ANTENNA HEIGHT (m)	TABLE ANGLE (Degree)	RAW VALUE (dBuV)	CORRECTION FACTOR (dB/m)
1	*5580.00	114.31 PK			2.00 H	264	104.98	9.33
2	*5580.00	101.74 AV			2.00 H	264	92.41	9.33
3	11160.00	60.79 PK	74.00	-13.21	1.72 H	341	40.52	20.27
4	11160.00	47.21 AV	54.00	-6.79	1.72 H	341	26.94	20.27

ANTENNA POLARITY & TEST DISTANCE: VERTICAL AT 3 M

NO.	FREQ. (MHz)	EMISSION LEVEL (dBuV/m)	LIMIT (dBuV/m)	MARGIN (dB)	ANTENNA HEIGHT (m)	TABLE ANGLE (Degree)	RAW VALUE (dBuV)	CORRECTION FACTOR (dB/m)
1	*5580.00	109.98 PK			1.94 V	196	100.65	9.33
2	*5580.00	97.98 AV			1.94 V	196	88.65	9.33
3	11160.00	59.92 PK	74.00	-14.08	1.59 V	85	39.65	20.27
4	11160.00	45.70 AV	54.00	-8.30	1.59 V	85	25.43	20.27

REMARKS:

1. Emission Level(dBuV/m) = Raw Value(dBuV) + Correction Factor(dB/m)
2. Correction Factor(dB/m) = Antenna Factor(dB/m) + Cable Factor(dB) – Pre-Amplifier Factor(dB)
3. The other emission levels were very low against the limit.
4. Margin value = Emission Level – Limit value
5. " * ": Fundamental frequency.

CHANNEL	TX Channel 132	DETECTOR FUNCTION	Peak (PK)
FREQUENCY RANGE	1GHz ~ 40GHz		Average (AV)

ANTENNA POLARITY & TEST DISTANCE: HORIZONTAL AT 3 M

NO.	FREQ. (MHz)	EMISSION LEVEL (dBuV/m)	LIMIT (dBuV/m)	MARGIN (dB)	ANTENNA HEIGHT (m)	TABLE ANGLE (Degree)	RAW VALUE (dBuV)	CORRECTION FACTOR (dB/m)
1	*5660.00	114.89 PK			2.02 H	265	105.53	9.36
2	*5660.00	102.00 AV			2.02 H	265	92.64	9.36
3	11320.00	60.60 PK	74.00	-13.40	1.39 H	224	40.51	20.09
4	11320.00	46.73 AV	54.00	-7.27	1.39 H	224	26.64	20.09

ANTENNA POLARITY & TEST DISTANCE: VERTICAL AT 3 M

NO.	FREQ. (MHz)	EMISSION LEVEL (dBuV/m)	LIMIT (dBuV/m)	MARGIN (dB)	ANTENNA HEIGHT (m)	TABLE ANGLE (Degree)	RAW VALUE (dBuV)	CORRECTION FACTOR (dB/m)
1	*5660.00	110.36 PK			1.88 V	193	101.00	9.36
2	*5660.00	97.70 AV			1.88 V	193	88.34	9.36
3	11320.00	59.43 PK	74.00	-14.57	1.82 V	109	39.34	20.09
4	11320.00	45.93 AV	54.00	-8.07	1.82 V	109	25.84	20.09

REMARKS:

1. Emission Level(dBuV/m) = Raw Value(dBuV) + Correction Factor(dB/m)
2. Correction Factor(dB/m) = Antenna Factor(dB/m) + Cable Factor(dB) – Pre-Amplifier Factor(dB)
3. The other emission levels were very low against the limit.
4. Margin value = Emission Level – Limit value
5. " * ": Fundamental frequency.

CHANNEL	TX Channel 140	DETECTOR FUNCTION	Peak (PK)
FREQUENCY RANGE	1GHz ~ 40GHz		Average (AV)

ANTENNA POLARITY & TEST DISTANCE: HORIZONTAL AT 3 M

NO.	FREQ. (MHz)	EMISSION LEVEL (dBuV/m)	LIMIT (dBuV/m)	MARGIN (dB)	ANTENNA HEIGHT (m)	TABLE ANGLE (Degree)	RAW VALUE (dBuV)	CORRECTION FACTOR (dB/m)
1	*5700.00	114.34 PK			2.19 H	261	104.97	9.37
2	*5700.00	101.36 AV			2.19 H	261	91.99	9.37
3	5725.00	66.99 PK	68.20	-1.21	2.19 H	261	57.61	9.38
4	11400.00	60.36 PK	74.00	-13.64	2.36 H	254	40.21	20.15
5	11400.00	46.50 AV	54.00	-7.50	2.36 H	254	26.35	20.15

ANTENNA POLARITY & TEST DISTANCE: VERTICAL AT 3 M

NO.	FREQ. (MHz)	EMISSION LEVEL (dBuV/m)	LIMIT (dBuV/m)	MARGIN (dB)	ANTENNA HEIGHT (m)	TABLE ANGLE (Degree)	RAW VALUE (dBuV)	CORRECTION FACTOR (dB/m)
1	*5700.00	110.05 PK			1.88 V	199	100.68	9.37
2	*5700.00	97.06 AV			1.88 V	199	87.69	9.37
3	5725.00	64.64 PK	68.20	-3.56	1.88 V	199	55.26	9.38
4	11400.00	59.49 PK	74.00	-14.51	1.87 V	194	39.34	20.15
5	11400.00	45.41 AV	54.00	-8.59	1.87 V	194	25.26	20.15

REMARKS:

1. Emission Level(dBuV/m) = Raw Value(dBuV) + Correction Factor(dB/m)
2. Correction Factor(dB/m) = Antenna Factor(dB/m) + Cable Factor(dB) – Pre-Amplifier Factor(dB)
3. The other emission levels were very low against the limit.
4. Margin value = Emission Level – Limit value
5. " * ": Fundamental frequency.

802.11ac (40MHz)

CHANNEL	TX Channel 54	DETECTOR FUNCTION	Peak (PK)
FREQUENCY RANGE	1GHz ~ 40GHz		Average (AV)

ANTENNA POLARITY & TEST DISTANCE: HORIZONTAL AT 3 M

NO.	FREQ. (MHz)	EMISSION LEVEL (dBuV/m)	LIMIT (dBuV/m)	MARGIN (dB)	ANTENNA HEIGHT (m)	TABLE ANGLE (Degree)	RAW VALUE (dBuV)	CORRECTION FACTOR (dB/m)
1	5150.00	59.96 PK	74.00	-14.04	2.21 H	263	52.16	7.80
2	5150.00	46.20 AV	54.00	-7.80	2.21 H	263	38.40	7.80
3	*5270.00	110.88 PK			2.21 H	263	102.61	8.27
4	*5270.00	100.19 AV			2.21 H	263	91.92	8.27
5	#10540.00	59.48 PK	74.00	-14.52	2.31 H	215	40.32	19.16
6	#10540.00	45.52 AV	54.00	-8.48	2.31 H	215	26.36	19.16

ANTENNA POLARITY & TEST DISTANCE: VERTICAL AT 3 M

NO.	FREQ. (MHz)	EMISSION LEVEL (dBuV/m)	LIMIT (dBuV/m)	MARGIN (dB)	ANTENNA HEIGHT (m)	TABLE ANGLE (Degree)	RAW VALUE (dBuV)	CORRECTION FACTOR (dB/m)
1	5150.00	59.64 PK	74.00	-14.36	2.33 V	269	51.84	7.80
2	5150.00	45.49 AV	54.00	-8.51	2.33 V	269	37.69	7.80
3	*5270.00	105.95 PK			2.33 V	269	97.68	8.27
4	*5270.00	95.23 AV			2.33 V	269	86.96	8.27
5	#10540.00	58.52 PK	74.00	-15.48	1.82 V	231	39.36	19.16
6	#10540.00	44.55 AV	54.00	-9.45	1.82 V	231	25.39	19.16

REMARKS:

1. Emission Level(dBuV/m) = Raw Value(dBuV) + Correction Factor(dB/m)
2. Correction Factor(dB/m) = Antenna Factor(dB/m) + Cable Factor(dB) – Pre-Amplifier Factor(dB)
3. The other emission levels were very low against the limit.
4. Margin value = Emission Level – Limit value
5. " * ": Fundamental frequency.
6. " # ": The radiated frequency is out of the restricted band.

CHANNEL	TX Channel 62	DETECTOR FUNCTION	Peak (PK)
FREQUENCY RANGE	1GHz ~ 40GHz		Average (AV)

ANTENNA POLARITY & TEST DISTANCE: HORIZONTAL AT 3 M

NO.	FREQ. (MHz)	EMISSION LEVEL (dBuV/m)	LIMIT (dBuV/m)	MARGIN (dB)	ANTENNA HEIGHT (m)	TABLE ANGLE (Degree)	RAW VALUE (dBuV)	CORRECTION FACTOR (dB/m)
1	*5310.00	109.72 PK			2.10 H	263	101.30	8.42
2	*5310.00	99.89 AV			2.10 H	263	91.47	8.42
3	5350.00	65.46 PK	74.00	-8.54	2.10 H	263	56.88	8.58
4	5350.00	51.11 AV	54.00	-2.89	2.10 H	263	42.53	8.58
5	10620.00	59.89 PK	74.00	-14.11	2.31 H	200	40.51	19.38
6	10620.00	45.89 AV	54.00	-8.11	2.31 H	200	26.51	19.38

ANTENNA POLARITY & TEST DISTANCE: VERTICAL AT 3 M

NO.	FREQ. (MHz)	EMISSION LEVEL (dBuV/m)	LIMIT (dBuV/m)	MARGIN (dB)	ANTENNA HEIGHT (m)	TABLE ANGLE (Degree)	RAW VALUE (dBuV)	CORRECTION FACTOR (dB/m)
1	*5310.00	105.31 PK			2.31 V	277	96.89	8.42
2	*5310.00	95.00 AV			2.31 V	277	86.58	8.42
3	5350.00	64.47 PK	74.00	-9.53	2.31 V	277	55.89	8.58
4	5350.00	49.60 AV	54.00	-4.40	2.31 V	277	41.02	8.58
5	10620.00	59.24 PK	74.00	-14.76	1.76 V	224	39.86	19.38
6	10620.00	44.74 AV	54.00	-9.26	1.76 V	224	25.36	19.38

REMARKS:

1. Emission Level(dBuV/m) = Raw Value(dBuV) + Correction Factor(dB/m)
2. Correction Factor(dB/m) = Antenna Factor(dB/m) + Cable Factor(dB) – Pre-Amplifier Factor(dB)
3. The other emission levels were very low against the limit.
4. Margin value = Emission Level – Limit value
5. " * ": Fundamental frequency.

CHANNEL	TX Channel 102	DETECTOR FUNCTION	Peak (PK)
FREQUENCY RANGE	1GHz ~ 40GHz		Average (AV)

ANTENNA POLARITY & TEST DISTANCE: HORIZONTAL AT 3 M

NO.	FREQ. (MHz)	EMISSION LEVEL (dBuV/m)	LIMIT (dBuV/m)	MARGIN (dB)	ANTENNA HEIGHT (m)	TABLE ANGLE (Degree)	RAW VALUE (dBuV)	CORRECTION FACTOR (dB/m)
1	5460.00	63.02 PK	74.00	-10.98	2.73 H	265	53.93	9.09
2	5460.00	48.49 AV	54.00	-5.51	2.73 H	265	39.40	9.09
3	5470.00	67.04 PK	68.2	-1.16	2.73 H	265	57.90	9.14
4	*5510.00	110.00 PK			2.73 H	265	100.70	9.30
5	*5510.00	99.90 AV			2.73 H	265	90.60	9.30
6	11020.00	61.26 PK	74.00	-12.74	1.54 H	241	40.56	20.70
7	11020.00	47.04 AV	54.00	-6.96	1.54 H	241	26.34	20.70

ANTENNA POLARITY & TEST DISTANCE: VERTICAL AT 3 M

NO.	FREQ. (MHz)	EMISSION LEVEL (dBuV/m)	LIMIT (dBuV/m)	MARGIN (dB)	ANTENNA HEIGHT (m)	TABLE ANGLE (Degree)	RAW VALUE (dBuV)	CORRECTION FACTOR (dB/m)
1	5460.00	60.35 PK	74.00	-13.65	1.52 V	298	51.26	9.09
2	5460.00	47.34 AV	54.00	-6.66	1.52 V	298	38.25	9.09
3	5470.00	65.08 PK	68.20	-3.12	1.52 V	298	55.94	9.14
4	*5510.00	104.99 PK			1.52 V	298	95.69	9.30
5	*5510.00	95.18 AV			1.52 V	298	85.88	9.30
6	11020.00	60.05 PK	74.00	-13.95	1.18 V	234	39.35	20.70
7	11020.00	45.79 AV	54.00	-8.21	1.18 V	234	25.09	20.70

REMARKS:

1. Emission Level(dBuV/m) = Raw Value(dBuV) + Correction Factor(dB/m)
2. Correction Factor(dB/m) = Antenna Factor(dB/m) + Cable Factor(dB) – Pre-Amplifier Factor(dB)
3. The other emission levels were very low against the limit.
4. Margin value = Emission Level – Limit value
5. " * ": Fundamental frequency.

CHANNEL	TX Channel 110	DETECTOR FUNCTION	Peak (PK)
FREQUENCY RANGE	1GHz ~ 40GHz		Average (AV)

ANTENNA POLARITY & TEST DISTANCE: HORIZONTAL AT 3 M

NO.	FREQ. (MHz)	EMISSION LEVEL (dBuV/m)	LIMIT (dBuV/m)	MARGIN (dB)	ANTENNA HEIGHT (m)	TABLE ANGLE (Degree)	RAW VALUE (dBuV)	CORRECTION FACTOR (dB/m)
1	*5550.00	109.66 PK			2.63 H	266	100.34	9.32
2	*5550.00	99.18 AV			2.63 H	266	89.86	9.32
3	11100.00	61.19 PK	74.00	-12.81	1.82 H	221	40.69	20.50
4	11100.00	46.82 AV	54.00	-7.18	1.82 H	221	26.32	20.50

ANTENNA POLARITY & TEST DISTANCE: VERTICAL AT 3 M

NO.	FREQ. (MHz)	EMISSION LEVEL (dBuV/m)	LIMIT (dBuV/m)	MARGIN (dB)	ANTENNA HEIGHT (m)	TABLE ANGLE (Degree)	RAW VALUE (dBuV)	CORRECTION FACTOR (dB/m)
1	*5550.00	104.98 PK			1.53 V	296	95.66	9.32
2	*5550.00	93.90 AV			1.53 V	296	84.58	9.32
3	11100.00	59.82 PK	74.00	-14.18	1.83 V	236	39.32	20.50
4	11100.00	46.14 AV	54.00	-7.86	1.83 V	236	25.64	20.50

REMARKS:

1. Emission Level(dBuV/m) = Raw Value(dBuV) + Correction Factor(dB/m)
2. Correction Factor(dB/m) = Antenna Factor(dB/m) + Cable Factor(dB) – Pre-Amplifier Factor(dB)
3. The other emission levels were very low against the limit.
4. Margin value = Emission Level – Limit value
5. " * ": Fundamental frequency.

CHANNEL	TX Channel 134	DETECTOR FUNCTION	Peak (PK)
FREQUENCY RANGE	1GHz ~ 40GHz		Average (AV)

ANTENNA POLARITY & TEST DISTANCE: HORIZONTAL AT 3 M

NO.	FREQ. (MHz)	EMISSION LEVEL (dBuV/m)	LIMIT (dBuV/m)	MARGIN (dB)	ANTENNA HEIGHT (m)	TABLE ANGLE (Degree)	RAW VALUE (dBuV)	CORRECTION FACTOR (dB/m)
1	*5670.00	110.23 PK			2.62 H	264	100.86	9.37
2	*5670.00	100.02 AV			2.62 H	264	90.65	9.37
3	5725.00	67.14 PK	68.20	-1.06	2.62 H	264	57.76	9.38
4	11340.00	61.05 PK	74.00	-12.95	1.45 H	209	40.94	20.11
5	11340.00	46.92 AV	54.00	-7.08	1.45 H	209	26.81	20.11

ANTENNA POLARITY & TEST DISTANCE: VERTICAL AT 3 M

NO.	FREQ. (MHz)	EMISSION LEVEL (dBuV/m)	LIMIT (dBuV/m)	MARGIN (dB)	ANTENNA HEIGHT (m)	TABLE ANGLE (Degree)	RAW VALUE (dBuV)	CORRECTION FACTOR (dB/m)
1	*5670.00	105.06 PK			1.52 V	294	95.69	9.37
2	*5670.00	95.22 AV			1.52 V	294	85.85	9.37
3	5725.00	64.64 PK	68.20	-3.56	1.52 V	194	55.26	9.38
4	11340.00	59.75 PK	74.00	-14.25	2.31 V	126	39.64	20.11
5	11340.00	45.72 AV	54.00	-8.28	2.31 V	126	25.61	20.11

REMARKS:

1. Emission Level(dBuV/m) = Raw Value(dBuV) + Correction Factor(dB/m)
2. Correction Factor(dB/m) = Antenna Factor(dB/m) + Cable Factor(dB) – Pre-Amplifier Factor(dB)
3. The other emission levels were very low against the limit.
4. Margin value = Emission Level – Limit value
5. " * ": Fundamental frequency.

802.11ac (80MHz)

CHANNEL	TX Channel 58	DETECTOR FUNCTION	Peak (PK)
FREQUENCY RANGE	1GHz ~ 40GHz		Average (AV)

ANTENNA POLARITY & TEST DISTANCE: HORIZONTAL AT 3 M

NO.	FREQ. (MHz)	EMISSION LEVEL (dBuV/m)	LIMIT (dBuV/m)	MARGIN (dB)	ANTENNA HEIGHT (m)	TABLE ANGLE (Degree)	RAW VALUE (dBuV)	CORRECTION FACTOR (dB/m)
1	5150.00	60.11 PK	74.00	-13.89	2.16 H	258	52.31	7.80
2	5150.00	44.81 AV	54.00	-9.19	2.16 H	258	37.01	7.80
3	*5290.00	105.85 PK			2.16 H	258	97.51	8.34
4	*5290.00	95.22 AV			2.16 H	258	86.88	8.34
5	5350.00	67.69 PK	74.00	-6.31	2.16 H	258	59.11	8.58
6	5350.00	52.85 AV	54.00	-1.15	2.16 H	258	44.27	8.58
7	10580.00	59.95 PK	74.00	-14.05	1.86 H	134	40.67	19.28
8	10580.00	45.61 AV	54.00	-8.39	1.86 H	134	26.33	19.28

ANTENNA POLARITY & TEST DISTANCE: VERTICAL AT 3 M

NO.	FREQ. (MHz)	EMISSION LEVEL (dBuV/m)	LIMIT (dBuV/m)	MARGIN (dB)	ANTENNA HEIGHT (m)	TABLE ANGLE (Degree)	RAW VALUE (dBuV)	CORRECTION FACTOR (dB/m)
1	5150.00	59.14 PK	74.00	-14.86	1.56 V	300	51.34	7.80
2	5150.00	44.79 AV	54.00	-9.21	1.56 V	300	36.99	7.80
3	*5290.00	99.92 PK			1.56 V	300	91.58	8.34
4	*5290.00	89.03 AV			1.56 V	300	80.69	8.34
5	5350.00	66.07 PK	74.00	-7.93	1.56 V	300	57.49	8.58
6	5350.00	49.94 AV	54.00	-4.06	1.56 V	300	41.36	8.58
7	10580.00	58.90 PK	74.00	-15.10	1.19 V	201	39.62	19.28
8	10580.00	44.64 AV	54.00	-9.36	1.19 V	201	25.36	19.28

REMARKS:

1. Emission Level(dBuV/m) = Raw Value(dBuV) + Correction Factor(dB/m)
2. Correction Factor(dB/m) = Antenna Factor(dB/m) + Cable Factor(dB) – Pre-Amplifier Factor(dB)
3. The other emission levels were very low against the limit.
4. Margin value = Emission Level – Limit value
5. " * ": Fundamental frequency.

CHANNEL	TX Channel 106	DETECTOR FUNCTION	Peak (PK)
FREQUENCY RANGE	1GHz ~ 40GHz		Average (AV)

ANTENNA POLARITY & TEST DISTANCE: HORIZONTAL AT 3 M

NO.	FREQ. (MHz)	EMISSION LEVEL (dBuV/m)	LIMIT (dBuV/m)	MARGIN (dB)	ANTENNA HEIGHT (m)	TABLE ANGLE (Degree)	RAW VALUE (dBuV)	CORRECTION FACTOR (dB/m)
1	5460.00	65.59 PK	74.00	-8.41	2.63 H	267	56.50	9.09
2	5460.00	50.97 AV	54.00	-3.03	2.63 H	267	41.88	9.09
3	5470.00	67.07 PK	68.20	-1.13	2.63 H	267	57.93	9.14
4	*5530.00	105.73 PK			2.63 H	267	96.42	9.31
5	*5530.00	95.52 AV			2.63 H	267	86.21	9.31
6	11060.00	61.25 PK	74.00	-12.75	1.43 H	154	40.65	20.60
7	11060.00	47.29 AV	54.00	-6.71	1.43 H	154	26.69	20.60

ANTENNA POLARITY & TEST DISTANCE: VERTICAL AT 3 M

NO.	FREQ. (MHz)	EMISSION LEVEL (dBuV/m)	LIMIT (dBuV/m)	MARGIN (dB)	ANTENNA HEIGHT (m)	TABLE ANGLE (Degree)	RAW VALUE (dBuV)	CORRECTION FACTOR (dB/m)
1	5460.00	63.43 PK	74.00	-10.57	1.52 V	303	54.34	9.09
2	5460.00	49.12 AV	54.00	-4.88	1.52 V	303	40.03	9.09
3	5470.00	64.40 PK	68.20	-3.80	1.52 V	303	55.26	9.14
4	*5530.00	100.16 PK			1.52 V	303	90.85	9.31
5	*5530.00	90.00 AV			1.52 V	303	80.69	9.31
6	11060.00	59.76 PK	74.00	-14.24	1.80 V	170	39.16	20.60
7	11060.00	45.91 AV	54.00	-8.09	1.80 V	170	25.31	20.60

REMARKS:

1. Emission Level(dBuV/m) = Raw Value(dBuV) + Correction Factor(dB/m)
2. Correction Factor(dB/m) = Antenna Factor(dB/m) + Cable Factor(dB) – Pre-Amplifier Factor(dB)
3. The other emission levels were very low against the limit.
4. Margin value = Emission Level – Limit value
5. " * ": Fundamental frequency.

CHANNEL	TX Channel 122	DETECTOR FUNCTION	Peak (PK)
FREQUENCY RANGE	1GHz ~ 40GHz		Average (AV)

ANTENNA POLARITY & TEST DISTANCE: HORIZONTAL AT 3 M

NO.	FREQ. (MHz)	EMISSION LEVEL (dBuV/m)	LIMIT (dBuV/m)	MARGIN (dB)	ANTENNA HEIGHT (m)	TABLE ANGLE (Degree)	RAW VALUE (dBuV)	CORRECTION FACTOR (dB/m)
1	*5610.00	105.64 PK			2.69 H	265	96.30	9.34
2	*5610.00	97.01 AV			2.69 H	265	87.67	9.34
3	5725.00	63.58 PK	68.20	-4.62	2.69 H	265	54.20	9.38
4	11220.00	60.63 PK	74.00	-13.37	1.87 H	149	40.51	20.12
5	11220.00	46.19 AV	54.00	-7.81	1.87 H	149	26.07	20.12

ANTENNA POLARITY & TEST DISTANCE: VERTICAL AT 3 M

NO.	FREQ. (MHz)	EMISSION LEVEL (dBuV/m)	LIMIT (dBuV/m)	MARGIN (dB)	ANTENNA HEIGHT (m)	TABLE ANGLE (Degree)	RAW VALUE (dBuV)	CORRECTION FACTOR (dB/m)
1	*5610.00	100.00 PK			1.51 V	301	90.66	9.34
2	*5610.00	90.62 AV			1.51 V	301	81.28	9.34
3	5725.00	63.01 PK	68.20	-5.19	1.51 V	301	53.63	9.38
4	11220.00	59.44 PK	74.00	-14.56	1.82 V	209	39.32	20.12
5	11220.00	45.28 AV	54.00	-8.72	1.82 V	209	25.16	20.12

REMARKS:

1. Emission Level(dBuV/m) = Raw Value(dBuV) + Correction Factor(dB/m)
2. Correction Factor(dB/m) = Antenna Factor(dB/m) + Cable Factor(dB) – Pre-Amplifier Factor(dB)
3. The other emission levels were very low against the limit.
4. Margin value = Emission Level – Limit value
5. " * ": Fundamental frequency.

Beamforming_NSS1 Mode

802.11ac (20MHz)

CHANNEL	TX Channel 52	DETECTOR FUNCTION	Peak (PK)
FREQUENCY RANGE	1GHz ~ 40GHz		Average (AV)

ANTENNA POLARITY & TEST DISTANCE: HORIZONTAL AT 3 M

NO.	FREQ. (MHz)	EMISSION LEVEL (dBuV/m)	LIMIT (dBuV/m)	MARGIN (dB)	ANTENNA HEIGHT (m)	TABLE ANGLE (Degree)	RAW VALUE (dBuV)	CORRECTION FACTOR (dB/m)
1	5150.00	56.21 PK	74.00	-17.79	1.70 H	49	53.16	3.05
2	5150.00	42.43 AV	54.00	-11.57	1.70 H	49	39.38	3.05
3	*5260.00	110.25 PK			1.70 H	49	106.84	3.41
4	*5260.00	97.02 AV			1.70 H	49	93.61	3.41
5	#10520.00	53.65 PK	74.00	-20.35	1.94 H	46	40.81	12.84
6	#10520.00	39.51 AV	54.00	-14.49	1.94 H	46	26.67	12.84

ANTENNA POLARITY & TEST DISTANCE: VERTICAL AT 3 M

NO.	FREQ. (MHz)	EMISSION LEVEL (dBuV/m)	LIMIT (dBuV/m)	MARGIN (dB)	ANTENNA HEIGHT (m)	TABLE ANGLE (Degree)	RAW VALUE (dBuV)	CORRECTION FACTOR (dB/m)
1	5150.00	55.59 PK	74.00	-18.41	1.48 V	15	52.54	3.05
2	5150.00	41.38 AV	54.00	-12.62	1.48 V	15	38.33	3.05
3	*5260.00	104.68 PK			1.48 V	15	101.27	3.41
4	*5260.00	91.87 AV			1.48 V	15	88.46	3.41
5	#10520.00	52.18 PK	74.00	-21.82	1.66 V	169	39.34	12.84
6	#10520.00	38.65 AV	54.00	-15.35	1.66 V	169	25.81	12.84

REMARKS:

1. Emission Level(dBuV/m) = Raw Value(dBuV) + Correction Factor(dB/m)
2. Correction Factor(dB/m) = Antenna Factor(dB/m) + Cable Factor(dB) – Pre-Amplifier Factor(dB)
3. The other emission levels were very low against the limit.
4. Margin value = Emission Level – Limit value
5. " * ": Fundamental frequency.
6. " # ": The radiated frequency is out of the restricted band.

CHANNEL	TX Channel 60	DETECTOR FUNCTION	Peak (PK)
FREQUENCY RANGE	1GHz ~ 40GHz		Average (AV)

ANTENNA POLARITY & TEST DISTANCE: HORIZONTAL AT 3 M

NO.	FREQ. (MHz)	EMISSION LEVEL (dBuV/m)	LIMIT (dBuV/m)	MARGIN (dB)	ANTENNA HEIGHT (m)	TABLE ANGLE (Degree)	RAW VALUE (dBuV)	CORRECTION FACTOR (dB/m)
1	*5300.00	110.01 PK			1.81 H	64	106.47	3.54
2	*5300.00	97.12 AV			1.81 H	64	93.58	3.54
3	10600.00	53.94 PK	74.00	-20.06	1.94 H	264	40.84	13.10
4	10600.00	39.49 AV	54.00	-14.51	1.94 H	264	26.39	13.10

ANTENNA POLARITY & TEST DISTANCE: VERTICAL AT 3 M

NO.	FREQ. (MHz)	EMISSION LEVEL (dBuV/m)	LIMIT (dBuV/m)	MARGIN (dB)	ANTENNA HEIGHT (m)	TABLE ANGLE (Degree)	RAW VALUE (dBuV)	CORRECTION FACTOR (dB/m)
1	*5300.00	104.95 PK			1.47 V	23	101.41	3.54
2	*5300.00	92.23 AV			1.47 V	23	88.69	3.54
3	10600.00	52.74 PK	74.00	-21.26	2.14 V	225	39.64	13.10
4	10600.00	38.26 AV	54.00	-15.74	2.14 V	225	25.16	13.10

REMARKS:

1. Emission Level(dBuV/m) = Raw Value(dBuV) + Correction Factor(dB/m)
2. Correction Factor(dB/m) = Antenna Factor(dB/m) + Cable Factor(dB) – Pre-Amplifier Factor(dB)
3. The other emission levels were very low against the limit.
4. Margin value = Emission Level – Limit value
5. " * ": Fundamental frequency.

CHANNEL	TX Channel 64	DETECTOR FUNCTION	Peak (PK)
FREQUENCY RANGE	1GHz ~ 40GHz		Average (AV)

ANTENNA POLARITY & TEST DISTANCE: HORIZONTAL AT 3 M

NO.	FREQ. (MHz)	EMISSION LEVEL (dBuV/m)	LIMIT (dBuV/m)	MARGIN (dB)	ANTENNA HEIGHT (m)	TABLE ANGLE (Degree)	RAW VALUE (dBuV)	CORRECTION FACTOR (dB/m)
1	*5320.00	110.75 PK			1.72 H	52	107.12	3.63
2	*5320.00	97.76 AV			1.72 H	52	94.13	3.63
3	5350.00	56.22 PK	74.00	-17.78	1.72 H	52	52.46	3.76
4	5350.00	42.42 AV	54.00	-11.58	1.72 H	52	38.66	3.76
5	10640.00	54.01 PK	74.00	-19.99	1.59 H	226	40.85	13.16
6	10640.00	39.91 AV	54.00	-14.09	1.59 H	226	26.75	13.16

ANTENNA POLARITY & TEST DISTANCE: VERTICAL AT 3 M

NO.	FREQ. (MHz)	EMISSION LEVEL (dBuV/m)	LIMIT (dBuV/m)	MARGIN (dB)	ANTENNA HEIGHT (m)	TABLE ANGLE (Degree)	RAW VALUE (dBuV)	CORRECTION FACTOR (dB/m)
1	*5320.00	104.85 PK			1.44 V	19	101.22	3.63
2	*5320.00	92.22 AV			1.44 V	19	88.59	3.63
3	5350.00	55.60 PK	74.00	-18.40	1.44 V	19	51.84	3.76
4	5350.00	41.25 AV	54.00	-12.75	1.44 V	19	37.49	3.76
5	10640.00	52.20 PK	74.00	-21.80	2.21 V	157	39.04	13.16
6	10640.00	38.34 AV	54.00	-15.66	2.21 V	157	25.18	13.16

REMARKS:

1. Emission Level(dBuV/m) = Raw Value(dBuV) + Correction Factor(dB/m)
2. Correction Factor(dB/m) = Antenna Factor(dB/m) + Cable Factor(dB) – Pre-Amplifier Factor(dB)
3. The other emission levels were very low against the limit.
4. Margin value = Emission Level – Limit value
5. " * ": Fundamental frequency.

CHANNEL	TX Channel 100	DETECTOR FUNCTION	Peak (PK)
FREQUENCY RANGE	1GHz ~ 40GHz		Average (AV)

ANTENNA POLARITY & TEST DISTANCE: HORIZONTAL AT 3 M

NO.	FREQ. (MHz)	EMISSION LEVEL (dBuV/m)	LIMIT (dBuV/m)	MARGIN (dB)	ANTENNA HEIGHT (m)	TABLE ANGLE (Degree)	RAW VALUE (dBuV)	CORRECTION FACTOR (dB/m)
1	5460.00	58.65 PK	74.00	-15.35	2.26 H	16	54.50	4.15
2	5460.00	42.67 AV	54.00	-11.33	2.26 H	16	38.52	4.15
3	5470.00	67.15 PK	68.20	-1.05	2.26 H	16	62.97	4.18
4	*5500.00	112.91 PK			2.26 H	16	108.64	4.27
5	*5500.00	100.74 AV			2.26 H	16	96.47	4.27
6	11000.00	55.15 PK	74.00	-18.85	1.68 H	236	40.94	14.21
7	11000.00	41.08 AV	54.00	-12.92	1.68 H	236	26.87	14.21

ANTENNA POLARITY & TEST DISTANCE: VERTICAL AT 3 M

NO.	FREQ. (MHz)	EMISSION LEVEL (dBuV/m)	LIMIT (dBuV/m)	MARGIN (dB)	ANTENNA HEIGHT (m)	TABLE ANGLE (Degree)	RAW VALUE (dBuV)	CORRECTION FACTOR (dB/m)
1	5460.00	57.41 PK	74.00	-16.59	1.87 V	96	53.26	4.15
2	5460.00	42.04 AV	54.00	-11.96	1.87 V	96	37.89	4.15
3	5470.00	63.12 PK	68.20	-5.08	1.87 V	96	58.94	4.18
4	*5500.00	107.42 PK			1.87 V	96	103.15	4.27
5	*5500.00	95.73 AV			1.87 V	96	91.46	4.27
6	11000.00	53.85 PK	74.00	-20.15	1.18 V	221	39.64	14.21
7	11000.00	40.02 AV	54.00	-13.98	1.18 V	221	25.81	14.21

REMARKS:

1. Emission Level(dBuV/m) = Raw Value(dBuV) + Correction Factor(dB/m)
2. Correction Factor(dB/m) = Antenna Factor(dB/m) + Cable Factor(dB) – Pre-Amplifier Factor(dB)
3. The other emission levels were very low against the limit.
4. Margin value = Emission Level – Limit value
5. " * ": Fundamental frequency.

CHANNEL	TX Channel 116	DETECTOR FUNCTION	Peak (PK)
FREQUENCY RANGE	1GHz ~ 40GHz		Average (AV)

ANTENNA POLARITY & TEST DISTANCE: HORIZONTAL AT 3 M

NO.	FREQ. (MHz)	EMISSION LEVEL (dBuV/m)	LIMIT (dBuV/m)	MARGIN (dB)	ANTENNA HEIGHT (m)	TABLE ANGLE (Degree)	RAW VALUE (dBuV)	CORRECTION FACTOR (dB/m)
1	*5580.00	113.58 PK			2.52 H	110	109.35	4.23
2	*5580.00	102.05 AV			2.52 H	110	97.82	4.23
3	11160.00	54.29 PK	74.00	-19.71	1.82 H	20	40.52	13.77
4	11160.00	40.44 AV	54.00	-13.56	1.82 H	20	26.67	13.77

ANTENNA POLARITY & TEST DISTANCE: VERTICAL AT 3 M

NO.	FREQ. (MHz)	EMISSION LEVEL (dBuV/m)	LIMIT (dBuV/m)	MARGIN (dB)	ANTENNA HEIGHT (m)	TABLE ANGLE (Degree)	RAW VALUE (dBuV)	CORRECTION FACTOR (dB/m)
1	*5580.00	109.07 PK			1.79 V	85	104.84	4.23
2	*5580.00	96.79 AV			1.79 V	85	92.56	4.23
3	11160.00	53.41 PK	74.00	-20.59	1.74 V	145	39.64	13.77
4	11160.00	38.95 AV	54.00	-15.05	1.74 V	145	25.18	13.77

REMARKS:

1. Emission Level(dBuV/m) = Raw Value(dBuV) + Correction Factor(dB/m)
2. Correction Factor(dB/m) = Antenna Factor(dB/m) + Cable Factor(dB) – Pre-Amplifier Factor(dB)
3. The other emission levels were very low against the limit.
4. Margin value = Emission Level – Limit value
5. " * ": Fundamental frequency.

CHANNEL	TX Channel 132	DETECTOR FUNCTION	Peak (PK)
FREQUENCY RANGE	1GHz ~ 40GHz		Average (AV)

ANTENNA POLARITY & TEST DISTANCE: HORIZONTAL AT 3 M

NO.	FREQ. (MHz)	EMISSION LEVEL (dBuV/m)	LIMIT (dBuV/m)	MARGIN (dB)	ANTENNA HEIGHT (m)	TABLE ANGLE (Degree)	RAW VALUE (dBuV)	CORRECTION FACTOR (dB/m)
1	*5660.00	113.64 PK			2.47 H	31	109.46	4.18
2	*5660.00	101.64 AV			2.47 H	31	97.46	4.18
3	11320.00	53.90 PK	74.00	-20.10	1.35 H	162	40.64	13.26
4	11320.00	39.75 AV	54.00	-14.25	1.35 H	162	26.49	13.26

ANTENNA POLARITY & TEST DISTANCE: VERTICAL AT 3 M

NO.	FREQ. (MHz)	EMISSION LEVEL (dBuV/m)	LIMIT (dBuV/m)	MARGIN (dB)	ANTENNA HEIGHT (m)	TABLE ANGLE (Degree)	RAW VALUE (dBuV)	CORRECTION FACTOR (dB/m)
1	*5660.00	108.96 PK			1.83 V	68	104.78	4.18
2	*5660.00	96.57 AV			1.83 V	68	92.39	4.18
3	11320.00	52.90 PK	74.00	-21.10	1.69 V	229	39.64	13.26
4	11320.00	39.11 AV	54.00	-14.89	1.69 V	229	25.85	13.26

REMARKS:

1. Emission Level(dBuV/m) = Raw Value(dBuV) + Correction Factor(dB/m)
2. Correction Factor(dB/m) = Antenna Factor(dB/m) + Cable Factor(dB) – Pre-Amplifier Factor(dB)
3. The other emission levels were very low against the limit.
4. Margin value = Emission Level – Limit value
5. " * ": Fundamental frequency.

CHANNEL	TX Channel 140	DETECTOR FUNCTION	Peak (PK)
FREQUENCY RANGE	1GHz ~ 40GHz		Average (AV)

ANTENNA POLARITY & TEST DISTANCE: HORIZONTAL AT 3 M

NO.	FREQ. (MHz)	EMISSION LEVEL (dBuV/m)	LIMIT (dBuV/m)	MARGIN (dB)	ANTENNA HEIGHT (m)	TABLE ANGLE (Degree)	RAW VALUE (dBuV)	CORRECTION FACTOR (dB/m)
1	*5700.00	108.88 PK			2.07 H	56	104.74	4.14
2	*5700.00	95.18 AV			2.07 H	56	91.04	4.14
3	5725.00	67.04 PK	68.20	-1.16	2.07 H	56	62.89	4.15
4	11400.00	53.72 PK	74.00	-20.28	1.88 H	228	40.69	13.03
5	11400.00	39.67 AV	54.00	-14.33	1.88 H	228	26.64	13.03

ANTENNA POLARITY & TEST DISTANCE: VERTICAL AT 3 M

NO.	FREQ. (MHz)	EMISSION LEVEL (dBuV/m)	LIMIT (dBuV/m)	MARGIN (dB)	ANTENNA HEIGHT (m)	TABLE ANGLE (Degree)	RAW VALUE (dBuV)	CORRECTION FACTOR (dB/m)
1	*5700.00	104.03 PK			1.75 V	69	99.89	4.14
2	*5700.00	90.50 AV			1.75 V	69	86.36	4.14
3	5725.00	63.83 PK	68.20	-4.37	1.75 V	69	59.68	4.15
4	11400.00	52.67 PK	74.00	-21.33	1.54 V	103	39.64	13.03
5	11400.00	38.53 AV	54.00	-15.47	1.54 V	103	25.50	13.03

REMARKS:

1. Emission Level(dBuV/m) = Raw Value(dBuV) + Correction Factor(dB/m)
2. Correction Factor(dB/m) = Antenna Factor(dB/m) + Cable Factor(dB) – Pre-Amplifier Factor(dB)
3. The other emission levels were very low against the limit.
4. Margin value = Emission Level – Limit value
5. " * ": Fundamental frequency.

802.11ac (40MHz)

CHANNEL	TX Channel 54	DETECTOR FUNCTION	Peak (PK)
FREQUENCY RANGE	1GHz ~ 40GHz		Average (AV)

ANTENNA POLARITY & TEST DISTANCE: HORIZONTAL AT 3 M

NO.	FREQ. (MHz)	EMISSION LEVEL (dBuV/m)	LIMIT (dBuV/m)	MARGIN (dB)	ANTENNA HEIGHT (m)	TABLE ANGLE (Degree)	RAW VALUE (dBuV)	CORRECTION FACTOR (dB/m)
1	5150.00	54.88 PK	74.00	-19.12	2.54 H	50	51.83	3.05
2	5150.00	41.18 AV	54.00	-12.82	2.54 H	50	38.13	3.05
3	*5270.00	107.20 PK			2.54 H	50	103.76	3.44
4	*5270.00	93.65 AV			2.54 H	50	90.21	3.44
5	#10540.00	53.75 PK	74.00	-20.25	1.64 H	228	40.84	12.91
6	#10540.00	39.36 AV	54.00	-14.64	1.64 H	228	26.45	12.91

ANTENNA POLARITY & TEST DISTANCE: VERTICAL AT 3 M

NO.	FREQ. (MHz)	EMISSION LEVEL (dBuV/m)	LIMIT (dBuV/m)	MARGIN (dB)	ANTENNA HEIGHT (m)	TABLE ANGLE (Degree)	RAW VALUE (dBuV)	CORRECTION FACTOR (dB/m)
1	5150.00	54.48 PK	74.00	-19.52	1.94 V	64	51.43	3.05
2	5150.00	40.20 AV	54.00	-13.80	1.94 V	64	37.15	3.05
3	*5270.00	102.23 PK			1.94 V	64	98.79	3.44
4	*5270.00	89.33 AV			1.94 V	64	85.89	3.44
5	#10540.00	52.27 PK	74.00	-21.73	1.67 V	114	39.36	12.91
6	#10540.00	38.82 AV	54.00	-15.18	1.67 V	114	25.91	12.91

REMARKS:

1. Emission Level(dBuV/m) = Raw Value(dBuV) + Correction Factor(dB/m)
2. Correction Factor(dB/m) = Antenna Factor(dB/m) + Cable Factor(dB) – Pre-Amplifier Factor(dB)
3. The other emission levels were very low against the limit.
4. Margin value = Emission Level – Limit value
5. " * ": Fundamental frequency.
6. " # ": The radiated frequency is out of the restricted band.

CHANNEL	TX Channel 62	DETECTOR FUNCTION	Peak (PK)
FREQUENCY RANGE	1GHz ~ 40GHz		Average (AV)

ANTENNA POLARITY & TEST DISTANCE: HORIZONTAL AT 3 M

NO.	FREQ. (MHz)	EMISSION LEVEL (dBuV/m)	LIMIT (dBuV/m)	MARGIN (dB)	ANTENNA HEIGHT (m)	TABLE ANGLE (Degree)	RAW VALUE (dBuV)	CORRECTION FACTOR (dB/m)
1	*5310.00	107.47 PK			2.48 H	46	103.88	3.59
2	*5310.00	94.45 AV			2.48 H	46	90.86	3.59
3	5350.00	55.92 PK	74.00	-18.08	2.48 H	46	52.16	3.76
4	5350.00	42.45 AV	54.00	-11.55	2.48 H	46	38.69	3.76
5	10620.00	53.72 PK	74.00	-20.28	1.87 H	187	40.59	13.13
6	10620.00	39.77 AV	54.00	-14.23	1.87 H	187	26.64	13.13

ANTENNA POLARITY & TEST DISTANCE: VERTICAL AT 3 M

NO.	FREQ. (MHz)	EMISSION LEVEL (dBuV/m)	LIMIT (dBuV/m)	MARGIN (dB)	ANTENNA HEIGHT (m)	TABLE ANGLE (Degree)	RAW VALUE (dBuV)	CORRECTION FACTOR (dB/m)
1	*5310.00	102.35 PK			1.89 V	52	98.76	3.59
2	*5310.00	88.81 AV			1.89 V	52	85.22	3.59
3	5350.00	55.22 PK	74.00	-18.78	1.89 V	52	51.46	3.76
4	5350.00	41.65 AV	54.00	-12.35	1.89 V	52	37.89	3.76
5	10620.00	52.77 PK	74.00	-21.23	2.39 V	258	39.64	13.13
6	10620.00	38.21 AV	54.00	-15.79	2.39 V	258	25.08	13.13

REMARKS:

1. Emission Level(dBuV/m) = Raw Value(dBuV) + Correction Factor(dB/m)
2. Correction Factor(dB/m) = Antenna Factor(dB/m) + Cable Factor(dB) – Pre-Amplifier Factor(dB)
3. The other emission levels were very low against the limit.
4. Margin value = Emission Level – Limit value
5. " * ": Fundamental frequency.

CHANNEL	TX Channel 102	DETECTOR FUNCTION	Peak (PK)
FREQUENCY RANGE	1GHz ~ 40GHz		Average (AV)

ANTENNA POLARITY & TEST DISTANCE: HORIZONTAL AT 3 M

NO.	FREQ. (MHz)	EMISSION LEVEL (dBuV/m)	LIMIT (dBuV/m)	MARGIN (dB)	ANTENNA HEIGHT (m)	TABLE ANGLE (Degree)	RAW VALUE (dBuV)	CORRECTION FACTOR (dB/m)
1	5460.00	64.52 PK	74.00	-9.48	2.26 H	17	60.37	4.15
2	5460.00	43.11 AV	54.00	-10.89	2.26 H	17	38.96	4.15
3	5470.00	67.12 PK	68.20	-1.08	2.26 H	17	62.94	4.18
4	*5510.00	112.91 PK			2.26 H	17	108.64	4.27
5	*5510.00	101.67 AV			2.26 H	17	97.40	4.27
6	11020.00	54.82 PK	74.00	-19.18	1.57 H	284	40.64	14.18
7	11020.00	40.79 AV	54.00	-13.21	1.57 H	284	26.61	14.18

ANTENNA POLARITY & TEST DISTANCE: VERTICAL AT 3 M

NO.	FREQ. (MHz)	EMISSION LEVEL (dBuV/m)	LIMIT (dBuV/m)	MARGIN (dB)	ANTENNA HEIGHT (m)	TABLE ANGLE (Degree)	RAW VALUE (dBuV)	CORRECTION FACTOR (dB/m)
1	5460.00	62.49 PK	74.00	-11.51	1.69 V	84	58.34	4.15
2	5460.00	42.11 AV	54.00	-11.89	1.69 V	84	37.96	4.15
3	5470.00	62.07 PK	68.20	-6.13	1.69 V	84	57.89	4.18
4	*5510.00	107.73 PK			1.69 V	84	103.46	4.27
5	*5510.00	96.91 AV			1.69 V	84	92.64	4.27
6	11020.00	53.61 PK	74.00	-20.39	2.19 V	103	39.43	14.18
7	11020.00	39.37 AV	54.00	-14.63	2.19 V	103	25.19	14.18

REMARKS:

1. Emission Level(dBuV/m) = Raw Value(dBuV) + Correction Factor(dB/m)
2. Correction Factor(dB/m) = Antenna Factor(dB/m) + Cable Factor(dB) – Pre-Amplifier Factor(dB)
3. The other emission levels were very low against the limit.
4. Margin value = Emission Level – Limit value
5. " * ": Fundamental frequency.

CHANNEL	TX Channel 110	DETECTOR FUNCTION	Peak (PK)
FREQUENCY RANGE	1GHz ~ 40GHz		Average (AV)

ANTENNA POLARITY & TEST DISTANCE: HORIZONTAL AT 3 M

NO.	FREQ. (MHz)	EMISSION LEVEL (dBuV/m)	LIMIT (dBuV/m)	MARGIN (dB)	ANTENNA HEIGHT (m)	TABLE ANGLE (Degree)	RAW VALUE (dBuV)	CORRECTION FACTOR (dB/m)
1	*5550.00	112.21 PK			2.33 H	56	107.96	4.25
2	*5550.00	100.11 AV			2.33 H	56	95.86	4.25
3	11100.00	54.55 PK	74.00	-19.45	1.87 H	301	40.51	14.04
4	11100.00	40.86 AV	54.00	-13.14	1.87 H	301	26.82	14.04

ANTENNA POLARITY & TEST DISTANCE: VERTICAL AT 3 M

NO.	FREQ. (MHz)	EMISSION LEVEL (dBuV/m)	LIMIT (dBuV/m)	MARGIN (dB)	ANTENNA HEIGHT (m)	TABLE ANGLE (Degree)	RAW VALUE (dBuV)	CORRECTION FACTOR (dB/m)
1	*5550.00	106.71 PK			1.62 V	109	102.46	4.25
2	*5550.00	94.91 AV			1.62 V	109	90.66	4.25
3	11100.00	53.38 PK	74.00	-20.62	2.95 V	228	39.34	14.04
4	11100.00	39.68 AV	54.00	-14.32	2.95 V	228	25.64	14.04

REMARKS:

1. Emission Level(dBuV/m) = Raw Value(dBuV) + Correction Factor(dB/m)
2. Correction Factor(dB/m) = Antenna Factor(dB/m) + Cable Factor(dB) – Pre-Amplifier Factor(dB)
3. The other emission levels were very low against the limit.
4. Margin value = Emission Level – Limit value
5. " * ": Fundamental frequency.

CHANNEL	TX Channel 134	DETECTOR FUNCTION	Peak (PK)
FREQUENCY RANGE	1GHz ~ 40GHz		Average (AV)

ANTENNA POLARITY & TEST DISTANCE: HORIZONTAL AT 3 M

NO.	FREQ. (MHz)	EMISSION LEVEL (dBuV/m)	LIMIT (dBuV/m)	MARGIN (dB)	ANTENNA HEIGHT (m)	TABLE ANGLE (Degree)	RAW VALUE (dBuV)	CORRECTION FACTOR (dB/m)
1	*5670.00	112.55 PK			2.26 H	57	108.38	4.17
2	*5670.00	98.09 AV			2.26 H	57	93.92	4.17
3	5725.00	66.36 PK	68.20	-1.84	2.26 H	57	62.21	4.15
4	11340.00	53.82 PK	74.00	-20.18	1.79 H	68	40.62	13.20
5	11340.00	40.16 AV	54.00	-13.84	1.79 H	68	26.96	13.20

ANTENNA POLARITY & TEST DISTANCE: VERTICAL AT 3 M

NO.	FREQ. (MHz)	EMISSION LEVEL (dBuV/m)	LIMIT (dBuV/m)	MARGIN (dB)	ANTENNA HEIGHT (m)	TABLE ANGLE (Degree)	RAW VALUE (dBuV)	CORRECTION FACTOR (dB/m)
1	*5670.00	107.33 PK			1.80 V	68	103.16	4.17
2	*5670.00	92.86 AV			1.80 V	68	88.69	4.17
3	5725.00	62.37 PK	68.20	-5.83	1.80 V	68	58.22	4.15
4	11340.00	52.61 PK	74.00	-21.39	1.87 V	44	39.41	13.20
5	11340.00	38.36 AV	54.00	-15.64	1.87 V	44	25.16	13.20

REMARKS:

1. Emission Level(dBuV/m) = Raw Value(dBuV) + Correction Factor(dB/m)
2. Correction Factor(dB/m) = Antenna Factor(dB/m) + Cable Factor(dB) – Pre-Amplifier Factor(dB)
3. The other emission levels were very low against the limit.
4. Margin value = Emission Level – Limit value
5. " * ": Fundamental frequency.

802.11ac (80MHz)

CHANNEL	TX Channel 58	DETECTOR FUNCTION	Peak (PK)
FREQUENCY RANGE	1GHz ~ 40GHz		Average (AV)

ANTENNA POLARITY & TEST DISTANCE: HORIZONTAL AT 3 M

NO.	FREQ. (MHz)	EMISSION LEVEL (dBuV/m)	LIMIT (dBuV/m)	MARGIN (dB)	ANTENNA HEIGHT (m)	TABLE ANGLE (Degree)	RAW VALUE (dBuV)	CORRECTION FACTOR (dB/m)
1	5150.00	55.38 PK	74.00	-18.62	2.45 H	50	52.33	3.05
2	5150.00	41.51 AV	54.00	-12.49	2.45 H	50	38.46	3.05
3	*5290.00	102.71 PK			2.45 H	50	99.20	3.51
4	*5290.00	89.94 AV			2.45 H	50	86.43	3.51
5	5350.00	60.06 PK	74.00	-13.94	2.45 H	50	56.30	3.76
6	5350.00	43.85 AV	54.00	-10.15	2.45 H	50	40.09	3.76
7	#10580.00	53.99 PK	74.00	-20.01	1.68 H	225	40.96	13.03
8	#10580.00	39.84 AV	54.00	-14.16	1.68 H	225	26.81	13.03

ANTENNA POLARITY & TEST DISTANCE: VERTICAL AT 3 M

NO.	FREQ. (MHz)	EMISSION LEVEL (dBuV/m)	LIMIT (dBuV/m)	MARGIN (dB)	ANTENNA HEIGHT (m)	TABLE ANGLE (Degree)	RAW VALUE (dBuV)	CORRECTION FACTOR (dB/m)
1	5150.00	54.54 PK	74.00	-19.46	1.84 V	92	51.49	3.05
2	5150.00	40.99 AV	54.00	-13.01	1.84 V	92	37.94	3.05
3	*5290.00	97.70 PK			1.84 V	92	94.19	3.51
4	*5290.00	84.97 AV			1.84 V	92	81.46	3.51
5	5350.00	59.22 PK	74.00	-14.78	1.84 V	92	55.46	3.76
6	5350.00	42.72 AV	54.00	-11.28	1.84 V	92	38.96	3.76
7	#10580.00	52.67 PK	74.00	-21.33	1.69 V	236	39.64	13.03
8	#10580.00	38.12 AV	54.00	-15.88	1.69 V	236	25.09	13.03

REMARKS:

1. Emission Level(dBuV/m) = Raw Value(dBuV) + Correction Factor(dB/m)
2. Correction Factor(dB/m) = Antenna Factor(dB/m) + Cable Factor(dB) – Pre-Amplifier Factor(dB)
3. The other emission levels were very low against the limit.
4. Margin value = Emission Level – Limit value
5. " * ": Fundamental frequency.
6. " # ": The radiated frequency is out of the restricted band.

CHANNEL	TX Channel 106	DETECTOR FUNCTION	Peak (PK)
FREQUENCY RANGE	1GHz ~ 40GHz		Average (AV)

ANTENNA POLARITY & TEST DISTANCE: HORIZONTAL AT 3 M

NO.	FREQ. (MHz)	EMISSION LEVEL (dBuV/m)	LIMIT (dBuV/m)	MARGIN (dB)	ANTENNA HEIGHT (m)	TABLE ANGLE (Degree)	RAW VALUE (dBuV)	CORRECTION FACTOR (dB/m)
1	5460.00	65.72 PK	74.00	-8.28	2.50 H	49	61.57	4.15
2	5460.00	43.97 AV	54.00	-10.03	2.50 H	49	39.82	4.15
3	5470.00	67.15 PK	68.20	-1.05	2.50 H	49	62.97	4.18
4	*5530.00	103.00 PK			2.50 H	49	98.74	4.26
5	*5530.00	90.66 AV			2.50 H	49	86.40	4.26
6	11060.00	54.76 PK	74.00	-19.24	2.14 H	154	40.64	14.12
7	11060.00	40.49 AV	54.00	-13.51	2.14 H	154	26.37	14.12

ANTENNA POLARITY & TEST DISTANCE: VERTICAL AT 3 M

NO.	FREQ. (MHz)	EMISSION LEVEL (dBuV/m)	LIMIT (dBuV/m)	MARGIN (dB)	ANTENNA HEIGHT (m)	TABLE ANGLE (Degree)	RAW VALUE (dBuV)	CORRECTION FACTOR (dB/m)
1	5460.00	60.51 PK	74.00	-13.49	1.77 V	96	56.36	4.15
2	5460.00	42.04 AV	54.00	-11.96	1.77 V	96	37.89	4.15
3	5470.00	62.43 PK	68.20	-5.77	1.77 V	96	58.25	4.18
4	*5530.00	97.70 PK			1.77 V	96	93.44	4.26
5	*5530.00	86.05 AV			1.77 V	96	81.79	4.26
6	11060.00	53.76 PK	74.00	-20.24	2.29 V	221	39.64	14.12
7	11060.00	39.30 AV	54.00	-14.70	2.29 V	221	25.18	14.12

REMARKS:

1. Emission Level(dBuV/m) = Raw Value(dBuV) + Correction Factor(dB/m)
2. Correction Factor(dB/m) = Antenna Factor(dB/m) + Cable Factor(dB) – Pre-Amplifier Factor(dB)
3. The other emission levels were very low against the limit.
4. Margin value = Emission Level – Limit value
5. " * ": Fundamental frequency.

CHANNEL	TX Channel 122	DETECTOR FUNCTION	Peak (PK)
FREQUENCY RANGE	1GHz ~ 40GHz		Average (AV)

ANTENNA POLARITY & TEST DISTANCE: HORIZONTAL AT 3 M

NO.	FREQ. (MHz)	EMISSION LEVEL (dBuV/m)	LIMIT (dBuV/m)	MARGIN (dB)	ANTENNA HEIGHT (m)	TABLE ANGLE (Degree)	RAW VALUE (dBuV)	CORRECTION FACTOR (dB/m)
1	*5610.00	107.88 PK			2.01 H	44	103.67	4.21
2	*5610.00	95.02 AV			2.01 H	44	90.81	4.21
3	5725.00	61.69 PK	68.20	-6.51	2.01 H	44	57.54	4.15
4	11220.00	53.72 PK	74.00	-20.28	1.96 H	336	40.18	13.54
5	11220.00	40.18 AV	54.00	-13.82	1.96 H	336	26.64	13.54

ANTENNA POLARITY & TEST DISTANCE: VERTICAL AT 3 M

NO.	FREQ. (MHz)	EMISSION LEVEL (dBuV/m)	LIMIT (dBuV/m)	MARGIN (dB)	ANTENNA HEIGHT (m)	TABLE ANGLE (Degree)	RAW VALUE (dBuV)	CORRECTION FACTOR (dB/m)
1	*5610.00	102.66 PK			1.72 V	100	98.45	4.21
2	*5610.00	89.47 AV			1.72 V	100	85.26	4.21
3	5725.00	59.40 PK	68.20	-8.8	1.72 V	100	55.25	4.15
4	11220.00	52.95 PK	74.00	-21.05	1.00 V	157	39.41	13.54
5	11220.00	38.70 AV	54.00	-15.30	1.00 V	157	25.16	13.54

REMARKS:

1. Emission Level(dBuV/m) = Raw Value(dBuV) + Correction Factor(dB/m)
2. Correction Factor(dB/m) = Antenna Factor(dB/m) + Cable Factor(dB) – Pre-Amplifier Factor(dB)
3. The other emission levels were very low against the limit.
4. Margin value = Emission Level – Limit value
5. " * ": Fundamental frequency.

Below 1GHz Data:

CDD Mode

802.11a

CHANNEL	TX Channel 52	DETECTOR FUNCTION	Quasi-Peak (QP)
FREQUENCY RANGE	9kHz ~ 1GHz		

ANTENNA POLARITY & TEST DISTANCE: HORIZONTAL AT 3 M

NO.	FREQ. (MHz)	EMISSION LEVEL (dBuV/m)	LIMIT (dBuV/m)	MARGIN (dB)	ANTENNA HEIGHT (m)	TABLE ANGLE (Degree)	RAW VALUE (dBuV)	CORRECTION FACTOR (dB/m)
1	34.51	31.58 QP	40.00	-8.42	1.93 H	51	42.32	-10.74
2	64.58	23.45 QP	40.00	-16.55	2.41 H	274	34.01	-10.56
3	106.05	24.81 QP	43.50	-18.69	1.92 H	138	37.90	-13.09
4	190.73	20.40 QP	43.50	-23.10	2.71 H	138	31.68	-11.28
5	214.45	19.65 QP	43.50	-23.85	1.16 H	321	30.87	-11.22
6	389.29	22.75 QP	46.00	-23.25	1.23 H	360	28.31	-5.56

ANTENNA POLARITY & TEST DISTANCE: VERTICAL AT 3 M

NO.	FREQ. (MHz)	EMISSION LEVEL (dBuV/m)	LIMIT (dBuV/m)	MARGIN (dB)	ANTENNA HEIGHT (m)	TABLE ANGLE (Degree)	RAW VALUE (dBuV)	CORRECTION FACTOR (dB/m)
1	34.93	37.62 QP	40.00	-2.38	1.33 V	327	48.27	-10.65
2	59.54	34.31 QP	40.00	-5.69	1.55 V	360	44.04	-9.73
3	105.81	28.68 QP	43.50	-14.82	1.80 V	212	41.80	-13.12
4	165.36	20.89 QP	43.50	-22.61	2.23 V	201	30.04	-9.15
5	221.14	21.39 QP	46.00	-24.61	1.42 V	185	32.70	-11.31
6	501.61	25.29 QP	46.00	-20.71	1.81 V	182	28.28	-2.99

REMARKS:

1. Emission Level(dBuV/m) = Raw Value(dBuV) + Correction Factor(dB/m)
2. Correction Factor(dB/m) = Antenna Factor(dB/m) + Cable Factor(dB) – Pre-Amplifier Factor(dB)
3. The other emission levels were very low against the limit.
4. Margin value = Emission Level – Limit value

4.2 Conducted Emission Measurement

4.2.1 Limits of Conducted Emission Measurement

Frequency (MHz)	Conducted Limit (dBuV)	
	Quasi-peak	Average
0.15 - 0.5	66 - 56	56 - 46
0.50 - 5.0	56	46
5.0 - 30.0	60	50

Note: 1. The lower limit shall apply at the transition frequencies.

2. The limit decreases in line with the logarithm of the frequency in the range of 0.15 to 0.50MHz.

4.2.2 Test Instruments

Description & Manufacturer	Model No.	Serial No.	Cal. Date	Cal. Due
ROHDE & SCHWARZ TEST RECEIVER	ESCS 30	100276	Apr. 10, 2017	Apr. 9, 2018
ROHDE & SCHWARZ Artificial Mains Network (for EUT)	ENV216	101196	Apr. 20, 2017	Apr. 19, 2018
LISN With Adapter (for EUT)	AD10	C10Ada-002	Apr. 20, 2017	Apr. 19, 2018
ROHDE & SCHWARZ Artificial Mains Network (for peripherals)	ESH3-Z5	100218	Nov. 23, 2016	Nov. 22, 2017
SCHWARZBECK Artificial Mains Network (For EUT)	NNLK8129	8129229	May 9, 2017	May 8, 2018
Software	Cond_V7.3.7.4	NA	NA	NA
RF cable (JYEBAO) With 10dB PAD	5D-FB	Cable-C10.01	Feb. 14, 2017	Feb. 13, 2018
SUHNER Terminator (For ROHDE & SCHWARZ LISN)	65BNC-5001	E1-01-299	Jan. 18, 2017	Jan. 17, 2018
ROHDE & SCHWARZ Artificial Mains Network (For TV EUT)	ESH3-Z5	100220	Nov. 8, 2016	Nov. 7, 2017
LISN With Adapter (for TV EUT)	100220	N/A	Nov. 8, 2016	Nov. 7, 2017

Notes: 1. The calibration interval of the above test instruments is 12 months and the calibrations are traceable to NML/ROC and NIST/USA.

2. The test was performed in Shielded Room No. 10.

3. The FCC Designation Number is TW2021.

4. Tested Date: May 16, 2017

4.2.3 Test Procedure

- The EUT was placed 0.4 meters from the conducting wall of the shielded room with EUT being connected to the power mains through a line impedance stabilization network (LISN). Other support units were connected to the power mains through another LISN. The two LISNs provide 50 ohm/ 50uH of coupling impedance for the measuring instrument.
- Both lines of the power mains connected to the EUT were checked for maximum conducted interference.
- The frequency range from 150kHz to 30MHz was searched. Emission levels under (Limit - 20dB) was not recorded.

NOTE: All modes of operation were investigated and the worst-case emissions are reported.

4.2.4 Deviation from Test Standard

No deviation.

4.2.5 Test Setup

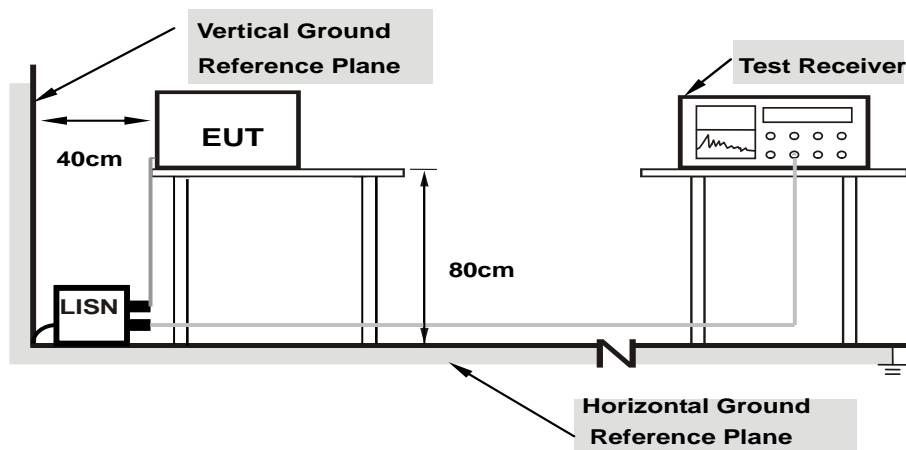

Note: 1.Support units were connected to second LISN.

For the actual test configuration, please refer to the attached file (Test Setup Photo).

4.2.6 EUT Operating Condition

Same as 4.1.6.

4.2.7 Test Results

CDD Mode

Phase	Line (L)	Detector Function	Quasi-Peak (QP) / Average (AV)
-------	----------	-------------------	--------------------------------

No	Freq. [MHz]	Corr.	Reading Value		Emission Level		Limit		Margin	
		Factor (dB)	[dB (uV)]		[dB (uV)]		[dB (uV)]		(dB)	
	Q.P.	AV.	Q.P.	AV.	Q.P.	AV.	Q.P.	AV.	Q.P.	AV.
1	0.15000	9.62	37.85	31.30	47.47	40.92	66.00	56.00	-18.53	-15.08
2	0.18906	9.62	32.50	25.65	42.12	35.27	64.08	54.08	-21.96	-18.81
3	0.52891	9.65	28.58	27.19	38.23	36.84	56.00	46.00	-17.77	-9.16
4	3.55859	9.82	19.78	13.16	29.60	22.98	56.00	46.00	-26.40	-23.02
5	9.86719	9.94	15.32	8.81	25.26	18.75	60.00	50.00	-34.74	-31.25
6	26.12109	10.10	24.89	19.05	34.99	29.15	60.00	50.00	-25.01	-20.85

REMARKS:

1. Q.P. and AV. are abbreviations of quasi-peak and average individually.
2. The emission levels of other frequencies were very low against the limit.
3. Margin value = Emission level - Limit value
4. Correction factor = Insertion loss + Cable loss
5. Emission Level = Correction Factor + Reading Value.

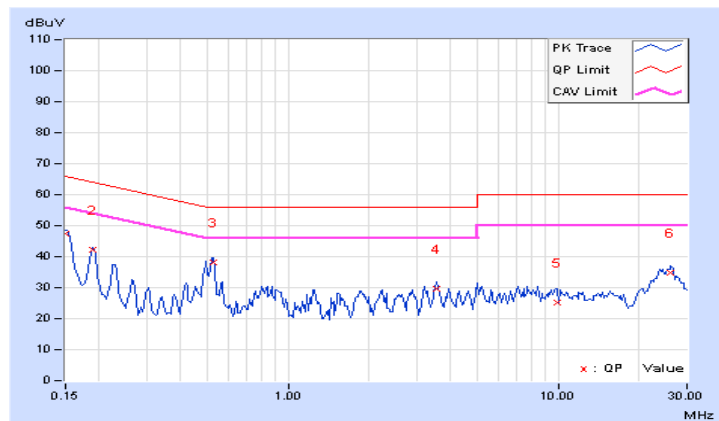

Phase	Neutral (N)	Detector Function	Quasi-Peak (QP) / Average (AV)
-------	-------------	-------------------	--------------------------------

No	Freq. [MHz]	Corr.	Reading Value		Emission Level		Limit		Margin	
		Factor	[dB (uV)]		[dB (uV)]		[dB (uV)]		(dB)	
		(dB)	Q.P.	AV.	Q.P.	AV.	Q.P.	AV.	Q.P.	AV.
1	0.15000	9.65	37.81	30.72	47.46	40.37	66.00	56.00	-18.54	-15.63
2	0.18906	9.64	32.47	25.23	42.11	34.87	64.08	54.08	-21.97	-19.21
3	0.52891	9.66	27.65	26.17	37.31	35.83	56.00	46.00	-18.69	-10.17
4	0.82578	9.68	15.29	10.08	24.97	19.76	56.00	46.00	-31.03	-26.24
5	3.56250	9.82	18.23	11.46	28.05	21.28	56.00	46.00	-27.95	-24.72
6	25.96875	10.32	23.91	18.25	34.23	28.57	60.00	50.00	-25.77	-21.43

REMARKS:

1. Q.P. and AV. are abbreviations of quasi-peak and average individually.
2. The emission levels of other frequencies were very low against the limit.
3. Margin value = Emission level - Limit value
4. Correction factor = Insertion loss + Cable loss
5. Emission Level = Correction Factor + Reading Value.

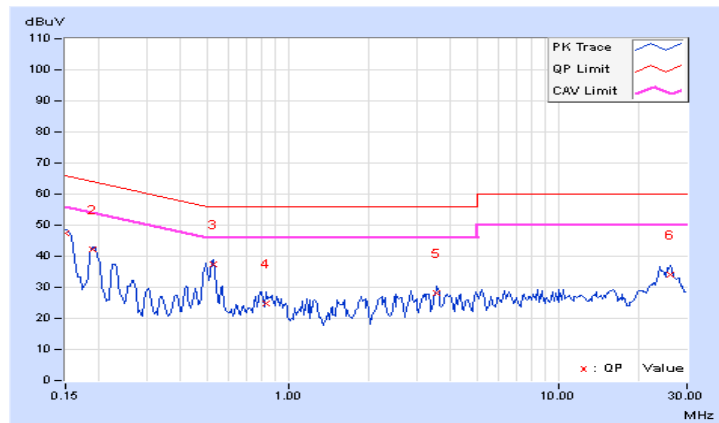

4.3 Transmit Power Measurement

4.3.1 Limits of Transmit Power Measurement

Operation Band	EUT Category		Limit
U-NII-1	---	Outdoor Access Point	1 Watt (30 dBm) (Max. e.i.r.p \leq 125mW(21 dBm) at any elevation angle above 30 degrees as measured from the horizon)
	---	Fixed point-to-point Access Point	1 Watt (30 dBm)
	---	Indoor Access Point	1 Watt (30 dBm)
	---	Mobile and Portable client device	250mW (24 dBm)
U-NII-2A	√		250mW (24 dBm) or 11 dBm+10 log B*
U-NII-2C	√		250mW (24 dBm) or 11 dBm+10 log B*
U-NII-3	---		1 Watt (30 dBm)

*B is the 26 dB emission bandwidth in megahertz

Per KDB 662911 Method of conducted output power measurement on IEEE 802.11 devices,

Array Gain = 0 dB (i.e., no array gain) for $N_{ANT} \leq 4$;

Array Gain = 0 dB (i.e., no array gain) for channel widths ≥ 40 MHz for any N_{ANT} ;

Array Gain = $5 \log(N_{ANT}/N_{SS})$ dB or 3 dB, whichever is less for 20-MHz channel widths with $N_{ANT} \geq 5$.

For power measurements on all other devices: Array Gain = $10 \log(N_{ANT}/N_{SS})$ dB.

4.3.2 Test Setup

For Power Output Measurement

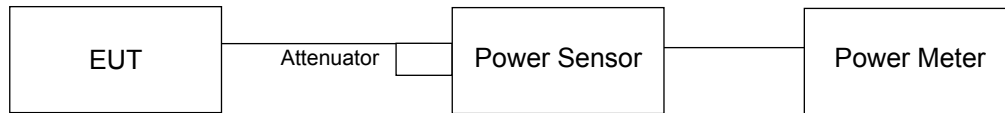

For 26dB Occupied Bandwidth

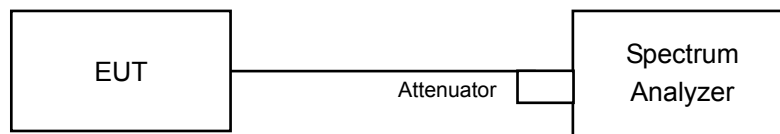

4.3.3 Test Instruments

Refer to section 4.1.2 to get information of above instrument.

4.3.4 Test Procedure

For Average Power Measurement

For 802.11a, 802.11ac (20MHz), 802.11ac (40MHz)

Method PM is used to perform output power measurement, trigger and gating function of wide band power meter is enabled to measure max output power of TX on burst. Duty factor is not added to measured value.

For 802.11ac (80MHz)

- 1) Set span to encompass the entire 26 dB EBW (or, alternatively, the entire 99% occupied bandwidth) of the signal.
- 2) Set sweep trigger to "free run".
- 3) Set RBW = 1 MHz.
- 4) Set VBW \geq 3 MHz
- 5) Number of points in sweep \geq 2 Span / RBW.
- 6) Sweep time \leq (number of points in sweep) * T
- 7) Using emission bandwidth to determine the frequency span for integration the channel bandwidth.
- 8) Detector = RMS.
- 9) Trace mode = max hold.
- 10) Allow max hold to run for at least 60 seconds, or longer as needed to allow the trace to stabilize.

For 26dB Occupied Bandwidth

- 1) Set RBW = approximately 1% of the emission bandwidth.
- 2) Set the VBW > RBW.
- 3) Detector = Peak.
- 4) Trace mode = max hold.
- 5) Measure the maximum width of the emission that is 26 dB down from the peak of the emission. Compare this with the RBW setting of the analyzer. Readjust RBW and repeat measurement as needed until the RBW/EBW ratio is approximately 1%.

4.3.5 Deviation from Test Standard

No deviation.

4.3.6 EUT Operating Condition

The software provided by client to enable the EUT under transmission condition continuously at lowest, middle and highest channel frequencies individually.

4.3.7 Test Result

CDD Mode

Power Output:

802.11a

Chan.	Chan. Freq. (MHz)	Maximum Conducted Power (dBm)		Total Power (mW)	Total Power (dBm)	Power Limit (dBm)	Pass/Fail
		Chain 0	Chain 1				
52	5260	12.67	13.12	39.005	15.91	23.38	PASS
60	5300	12.62	13.09	38.651	15.87	23.38	PASS
64	5320	12.54	13.22	38.936	15.90	23.38	PASS
100	5500	17.51	18.58	128.475	21.09	23.38	PASS
116	5580	17.48	18.56	127.755	21.06	23.38	PASS
132	5660	17.49	18.51	127.063	21.04	23.38	PASS
140	5700	17.55	18.61	129.496	21.12	23.38	PASS

NOTE: Gain = 6.62 dBi > 6dBi, so the power limit shall be reduced to $24 - (6.62 - 6) = 23.38\text{dBm}$.

Chain 0:

1. $11\text{dBm} + 10\log (19.23) = 23.84 < 24\text{dBm}$
2. $11\text{dBm} + 10\log (19.26) = 23.85 < 24\text{dBm}$
3. $11\text{dBm} + 10\log (19.17) = 23.83 < 24\text{dBm}$
4. $11\text{dBm} + 10\log (19.25) = 23.84 < 24\text{dBm}$
5. $11\text{dBm} + 10\log (19.24) = 23.84 < 24\text{dBm}$
6. $11\text{dBm} + 10\log (19.12) = 23.81 < 24\text{dBm}$
7. $11\text{dBm} + 10\log (19.31) = 23.86 < 24\text{dBm}$

Chain 1:

1. $11\text{dBm} + 10\log (19.22) = 23.84 < 24\text{dBm}$
2. $11\text{dBm} + 10\log (19.29) = 23.85 < 24\text{dBm}$
3. $11\text{dBm} + 10\log (19.22) = 23.84 < 24\text{dBm}$
4. $11\text{dBm} + 10\log (19.09) = 23.81 < 24\text{dBm}$
5. $11\text{dBm} + 10\log (19.20) = 23.83 < 24\text{dBm}$
6. $11\text{dBm} + 10\log (19.28) = 23.85 < 24\text{dBm}$
7. $11\text{dBm} + 10\log (19.38) = 23.87 < 24\text{dBm}$

802.11ac (20MHz)

Chan.	Chan. Freq. (MHz)	Maximum Conducted Power (dBm)		Total Power (mW)	Total Power (dBm)	Power Limit (dBm)	Pass/Fail
		Chain 0	Chain 1				
52	5260	12.52	13.18	38.662	15.87	23.38	PASS
60	5300	12.48	13.21	38.642	15.87	23.38	PASS
64	5320	12.51	13.24	38.910	15.90	23.38	PASS
100	5500	17.30	18.48	124.172	20.94	23.38	PASS
116	5580	17.28	18.50	124.251	20.94	23.38	PASS
132	5660	17.33	18.47	124.382	20.95	23.38	PASS
140	5700	17.26	18.44	123.034	20.90	23.38	PASS

NOTE: Gain = 6.62 dBi > 6dBi, so the power limit shall be reduced to $24 - (6.62 - 6) = 23.38\text{dBm}$.

Chain 0:

1. $11\text{dBm} + 10\log (20.32) = 24.08 > 24\text{dBm}$
2. $11\text{dBm} + 10\log (20.39) = 24.09 > 24\text{dBm}$
3. $11\text{dBm} + 10\log (20.32) = 24.08 > 24\text{dBm}$
4. $11\text{dBm} + 10\log (20.57) = 24.13 > 24\text{dBm}$
5. $11\text{dBm} + 10\log (20.37) = 24.09 > 24\text{dBm}$
6. $11\text{dBm} + 10\log (20.12) = 24.04 > 24\text{dBm}$
7. $11\text{dBm} + 10\log (20.33) = 24.08 > 24\text{dBm}$

Chain 1:

1. $11\text{dBm} + 10\log (20.31) = 24.08 > 24\text{dBm}$
2. $11\text{dBm} + 10\log (20.30) = 24.07 > 24\text{dBm}$
3. $11\text{dBm} + 10\log (20.36) = 24.09 > 24\text{dBm}$
4. $11\text{dBm} + 10\log (20.28) = 24.07 > 24\text{dBm}$
5. $11\text{dBm} + 10\log (20.21) = 24.06 > 24\text{dBm}$
6. $11\text{dBm} + 10\log (20.43) = 24.10 > 24\text{dBm}$
7. $11\text{dBm} + 10\log (20.47) = 24.11 > 24\text{dBm}$

802.11ac (40MHz)

Chan.	Chan. Freq. (MHz)	Maximum Conducted Power (dBm)		Total Power (mW)	Total Power (dBm)	Power Limit (dBm)	Pass/Fail
		Chain 0	Chain 1				
54	5270	12.54	13.12	38.459	15.85	23.38	PASS
62	5310	12.52	13.16	38.566	15.86	23.38	PASS
102	5510	19.31	20.35	193.703	22.87	23.38	PASS
110	5550	19.14	20.36	190.678	22.80	23.38	PASS
134	5670	19.12	20.34	189.801	22.78	23.38	PASS

NOTE: Gain = 6.62 dBi > 6dBi, so the power limit shall be reduced to $24 - (6.62 - 6) = 23.38\text{dBm}$.

Chain 0:

1. $11\text{dBm} + 10\log (39.79) = 27.00 > 24\text{dBm}$
2. $11\text{dBm} + 10\log (39.71) = 26.99 > 24\text{dBm}$
3. $11\text{dBm} + 10\log (39.88) = 27.01 > 24\text{dBm}$
4. $11\text{dBm} + 10\log (39.89) = 27.01 > 24\text{dBm}$
5. $11\text{dBm} + 10\log (39.98) = 27.02 > 24\text{dBm}$

Chain 1:

1. $11\text{dBm} + 10\log (39.96) = 27.02 > 24\text{dBm}$
2. $11\text{dBm} + 10\log (39.67) = 26.98 > 24\text{dBm}$
3. $11\text{dBm} + 10\log (39.89) = 27.01 > 24\text{dBm}$
4. $11\text{dBm} + 10\log (39.88) = 27.01 > 24\text{dBm}$
5. $11\text{dBm} + 10\log (39.98) = 27.02 > 24\text{dBm}$

802.11ac (80MHz)

Chan.	Chan. Freq. (MHz)	Maximum Conducted Power (dBm)		Total Power (mW)	Total Power (dBm)	Power Limit (dBm)	Pass/Fail
		Chain 0	Chain 1				
58	5290	12.48	13.11	38.165	15.82	23.38	PASS
106	5530	19.16	20.32	190.061	22.79	23.38	PASS
122	5610	19.15	20.35	190.617	22.80	23.38	PASS

NOTE: Gain = 6.62 dBi > 6dBi, so the power limit shall be reduced to 24-(6.62-6) = 23.38dBm.

Chain 0:

1. 11dBm + 10log (83.85) = 30.24 > 24dBm
2. 11dBm + 10log (83.95) = 30.24 > 24dBm
3. 11dBm + 10log (83.85) = 30.24 > 24dBm

Chain 1:

1. 11dBm + 10log (83.99) = 30.24 > 24dBm
2. 11dBm + 10log (83.78) = 30.23 > 24dBm
3. 11dBm + 10log (83.78) = 30.23 > 24dBm

EUT MAXIMUM CONDUCTED POWER

802.11a

FREQUENCY BAND (MHz)	MAX. POWER	
	OUTPUT POWER (mW)	OUTPUT POWER (dBm)
5250~5350	39.005	15.91
5470~5725	129.496	21.12

NOTE: Manufacturer provides Transmit Power Control description to meet this requirement.

802.11ac (20MHz)

FREQUENCY BAND (MHz)	MAX. POWER	
	OUTPUT POWER (mW)	OUTPUT POWER (dBm)
5250~5350	38.910	15.90
5470~5725	124.382	20.95

NOTE: Manufacturer provides Transmit Power Control description to meet this requirement.

802.11ac (40MHz)

FREQUENCY BAND (MHz)	MAX. POWER	
	OUTPUT POWER (mW)	OUTPUT POWER (dBm)
5250~5350	38.566	15.86
5470~5725	193.703	22.87

NOTE: Manufacturer provides Transmit Power Control description to meet this requirement.

802.11ac (80MHz)

FREQUENCY BAND (MHz)	MAX. POWER	
	OUTPUT POWER (mW)	OUTPUT POWER (dBm)
5250~5350	38.165	15.82
5470~5725	190.617	22.80

NOTE: Manufacturer provides Transmit Power Control description to meet this requirement.

Beamforming_NSS1 Mode

Power Output:

802.11ac (20MHz)

Chan.	Chan. Freq. (MHz)	Maximum Conducted Power (dBm)		Total Power (mW)	Total Power (dBm)	Power Limit (dBm)	Pass/Fail
		Chain 0	Chain 1				
52	5260	9.50	10.15	19.264	12.85	20.56	PASS
60	5300	9.48	10.17	19.271	12.85	20.56	PASS
64	5320	9.49	10.20	19.363	12.87	20.56	PASS
100	5500	15.94	17.25	92.352	19.65	20.56	PASS
116	5580	16.74	17.98	110.012	20.41	20.56	PASS
132	5660	16.77	17.94	109.764	20.40	20.56	PASS
140	5700	15.12	16.66	78.854	18.97	20.56	PASS

NOTE: Directional gain = $10 \log[(10^{G1/20} + 10^{G2/20} + \dots + 10^{GN/20})^2 / 2]$ = 9.44dBi > 6dBi, so the Power limit shall be reduced to $24 - (9.44 - 6) = 20.56$ dBm

Chain 0:

1. 11dBm + 10log (20.32) = 24.08 > 24dBm
2. 11dBm + 10log (20.39) = 24.09 > 24dBm
3. 11dBm + 10log (20.32) = 24.08 > 24dBm
4. 11dBm + 10log (20.57) = 24.13 > 24dBm
5. 11dBm + 10log (20.37) = 24.09 > 24dBm
6. 11dBm + 10log (20.12) = 24.04 > 24dBm
7. 11dBm + 10log (20.33) = 24.08 > 24dBm

Chain 1:

1. 11dBm + 10log (20.31) = 24.08 > 24dBm
2. 11dBm + 10log (20.30) = 24.07 > 24dBm
3. 11dBm + 10log (20.36) = 24.09 > 24dBm
4. 11dBm + 10log (20.28) = 24.07 > 24dBm
5. 11dBm + 10log (20.21) = 24.06 > 24dBm
6. 11dBm + 10log (20.43) = 24.10 > 24dBm
7. 11dBm + 10log (20.47) = 24.11 > 24dBm

802.11ac (40MHz)

Chan.	Chan. Freq. (MHz)	Maximum Conducted Power (dBm)		Total Power (mW)	Total Power (dBm)	Power Limit (dBm)	Pass/Fail
		Chain 0	Chain 1				
54	5270	9.52	10.13	19.258	12.85	20.56	PASS
62	5310	9.51	10.18	19.356	12.87	20.56	PASS
102	5510	15.01	16.32	74.551	18.72	20.56	PASS
110	5550	16.55	17.81	105.581	20.24	20.56	PASS
134	5670	16.59	17.84	106.418	20.27	20.56	PASS

NOTE: Directional gain = $10 \log\left[\frac{(10^{G1/20} + 10^{G2/20} + \dots + 10^{GN/20})^2}{2}\right] = 9.44\text{dBi} > 6\text{dBi}$, so the Power limit shall be reduced to $24 - (9.44 - 6) = 20.56\text{dBm}$

Chain 0:

1. $11\text{dBm} + 10\log(39.79) = 27.00 > 24\text{dBm}$
2. $11\text{dBm} + 10\log(39.71) = 26.99 > 24\text{dBm}$
3. $11\text{dBm} + 10\log(39.88) = 27.01 > 24\text{dBm}$
4. $11\text{dBm} + 10\log(39.89) = 27.01 > 24\text{dBm}$
5. $11\text{dBm} + 10\log(39.98) = 27.02 > 24\text{dBm}$

Chain 1:

1. $11\text{dBm} + 10\log(39.96) = 27.02 > 24\text{dBm}$
2. $11\text{dBm} + 10\log(39.67) = 26.98 > 24\text{dBm}$
3. $11\text{dBm} + 10\log(39.89) = 27.01 > 24\text{dBm}$
4. $11\text{dBm} + 10\log(39.88) = 27.01 > 24\text{dBm}$
5. $11\text{dBm} + 10\log(39.98) = 27.02 > 24\text{dBm}$

802.11ac (80MHz)

Chan.	Chan. Freq. (MHz)	Maximum Conducted Power (dBm)		Total Power (mW)	Total Power (dBm)	Power Limit (dBm)	Pass/Fail
		Chain 0	Chain 1				
58	5290	9.47	10.18	19.274	12.85	20.56	PASS
106	5530	14.20	15.28	60.032	17.78	20.56	PASS
122	5610	16.52	17.79	104.992	20.21	20.56	PASS

NOTE: Directional gain = $10 \log\left[\frac{(10^{G1/20} + 10^{G2/20} + \dots + 10^{GN/20})^2}{2}\right] = 9.44\text{dBi} > 6\text{dBi}$, so the Power limit shall be reduced to $24 - (9.44 - 6) = 20.56\text{dBm}$

Chain 0:

1. $11\text{dBm} + 10\log(83.85) = 30.24 > 24\text{dBm}$
2. $11\text{dBm} + 10\log(83.95) = 30.24 > 24\text{dBm}$
3. $11\text{dBm} + 10\log(83.85) = 30.24 > 24\text{dBm}$

Chain 1:

1. $11\text{dBm} + 10\log(83.99) = 30.24 > 24\text{dBm}$
2. $11\text{dBm} + 10\log(83.78) = 30.23 > 24\text{dBm}$
3. $11\text{dBm} + 10\log(83.78) = 30.23 > 24\text{dBm}$

EUT MAXIMUM CONDUCTED POWER

802.11ac (20MHz)

FREQUENCY BAND (MHz)	MAX. POWER	
	OUTPUT POWER (mW)	OUTPUT POWER (dBm)
5250~5350	19.363	12.87
5470~5725	110.012	20.41

NOTE: Manufacturer provides Transmit Power Control description to meet this requirement.

802.11ac (40MHz)

FREQUENCY BAND (MHz)	MAX. POWER	
	OUTPUT POWER (mW)	OUTPUT POWER (dBm)
5250~5350	19.356	12.87
5470~5725	106.418	20.27

NOTE: Manufacturer provides Transmit Power Control description to meet this requirement.

802.11ac (80MHz)

FREQUENCY BAND (MHz)	MAX. POWER	
	OUTPUT POWER (mW)	OUTPUT POWER (dBm)
5250~5350	19.274	12.85
5470~5725	104.992	20.21

NOTE: Manufacturer provides Transmit Power Control description to meet this requirement.

CDD Mode

26dB BANDWIDTH:

802.11a

Channel	Channel Frequency (MHz)	26dBc Bandwidth (MHz)		Pass/Fail
		Chain 0	Chain 1	
52	5260	19.23	19.22	Pass
60	5300	19.26	19.29	Pass
64	5320	19.17	19.22	Pass
100	5500	19.25	19.09	Pass
116	5580	19.24	19.20	Pass
132	5660	19.12	19.28	Pass
140	5700	19.31	19.38	Pass

802.11ac (20MHz)

Channel	Channel Frequency (MHz)	26dBc Bandwidth (MHz)		Pass/Fail
		Chain 0	Chain 1	
52	5260	20.32	20.31	Pass
60	5300	20.39	20.30	Pass
64	5320	20.32	20.36	Pass
100	5500	20.57	20.28	Pass
116	5580	20.37	20.21	Pass
132	5660	20.12	20.43	Pass
140	5700	20.33	20.47	Pass

802.11ac (40MHz)

Channel	Channel Frequency (MHz)	26dBc Bandwidth (MHz)		Pass/Fail
		Chain 0	Chain 1	
54	5270	39.79	39.96	Pass
62	5310	39.71	39.67	Pass
102	5510	39.88	39.89	Pass
110	5550	39.89	39.88	Pass
134	5670	39.98	39.98	Pass

802.11ac (80MHz)

Channel	Channel Frequency (MHz)	26dBc Bandwidth (MHz)		Pass/Fail
		Chain 0	Chain 1	
58	5290	83.85	83.99	Pass
106	5530	83.95	83.78	Pass
122	5610	83.85	83.78	Pass

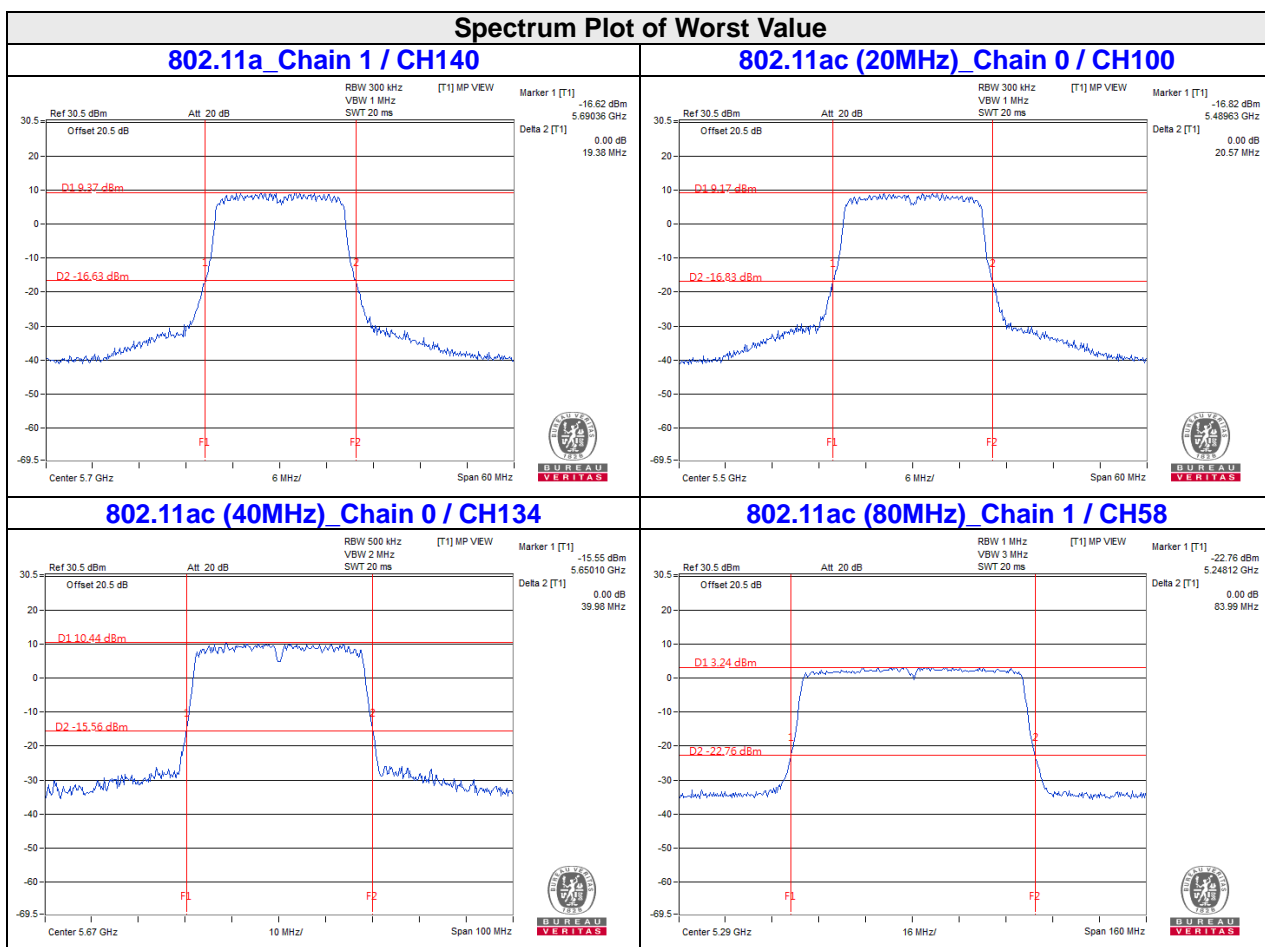

4.4 Occupied Bandwidth Measurement

4.4.1 Test Setup



4.4.2 Test Instruments

Refer to section 4.1.2 to get information of above instrument.

4.4.3 Test Procedure

The transmitter output was connected to the spectrum analyzer through an attenuator. The bandwidth of the fundamental frequency was measured by spectrum analyzer with resolution bandwidth in the range of 1% to 5% of the anticipated emission bandwidth, and a video bandwidth at least 3x the resolution bandwidth and set the detector to SAMPLE. The width of a frequency band such that, below the lower and above the upper frequency limits, the mean powers emitted are each equal to a specified percentage 0.5 %of the total mean power of a given emission.

4.4.4 Test Results

CDD Mode

802.11a

Channel	Channel Frequency (MHz)	Occupied Bandwidth (MHz)		Pass/Fail
		Chain 0	Chain 1	
52	5260	16.56	16.44	Pass
60	5300	16.44	16.56	Pass
64	5320	16.44	16.44	Pass
100	5500	16.44	16.44	Pass
116	5580	16.44	16.44	Pass
132	5660	16.44	16.44	Pass
140	5700	16.44	16.44	Pass

802.11ac (20MHz)

Channel	Channel Frequency (MHz)	Occupied Bandwidth (MHz)		Pass/Fail
		Chain 0	Chain 1	
52	5260	17.64	17.64	Pass
60	5300	17.64	17.64	Pass
64	5320	17.64	17.64	Pass
100	5500	17.64	17.64	Pass
116	5580	17.64	17.64	Pass
132	5660	17.64	17.64	Pass
140	5700	17.64	17.64	Pass

802.11ac (40MHz)

Channel	Channel Frequency (MHz)	Occupied Bandwidth (MHz)		Pass/Fail
		Chain 0	Chain 1	
54	5270	36.00	36.00	Pass
62	5310	36.00	36.00	Pass
102	5510	35.94	35.94	Pass
110	5550	35.94	35.94	Pass
134	5670	35.94	35.94	Pass

802.11ac (80MHz)

Channel	Channel Frequency (MHz)	Occupied Bandwidth (MHz)		Pass/Fail
		Chain 0	Chain 1	
58	5290	75.84	75.84	Pass
106	5530	75.65	75.65	Pass
122	5610	75.82	75.65	Pass

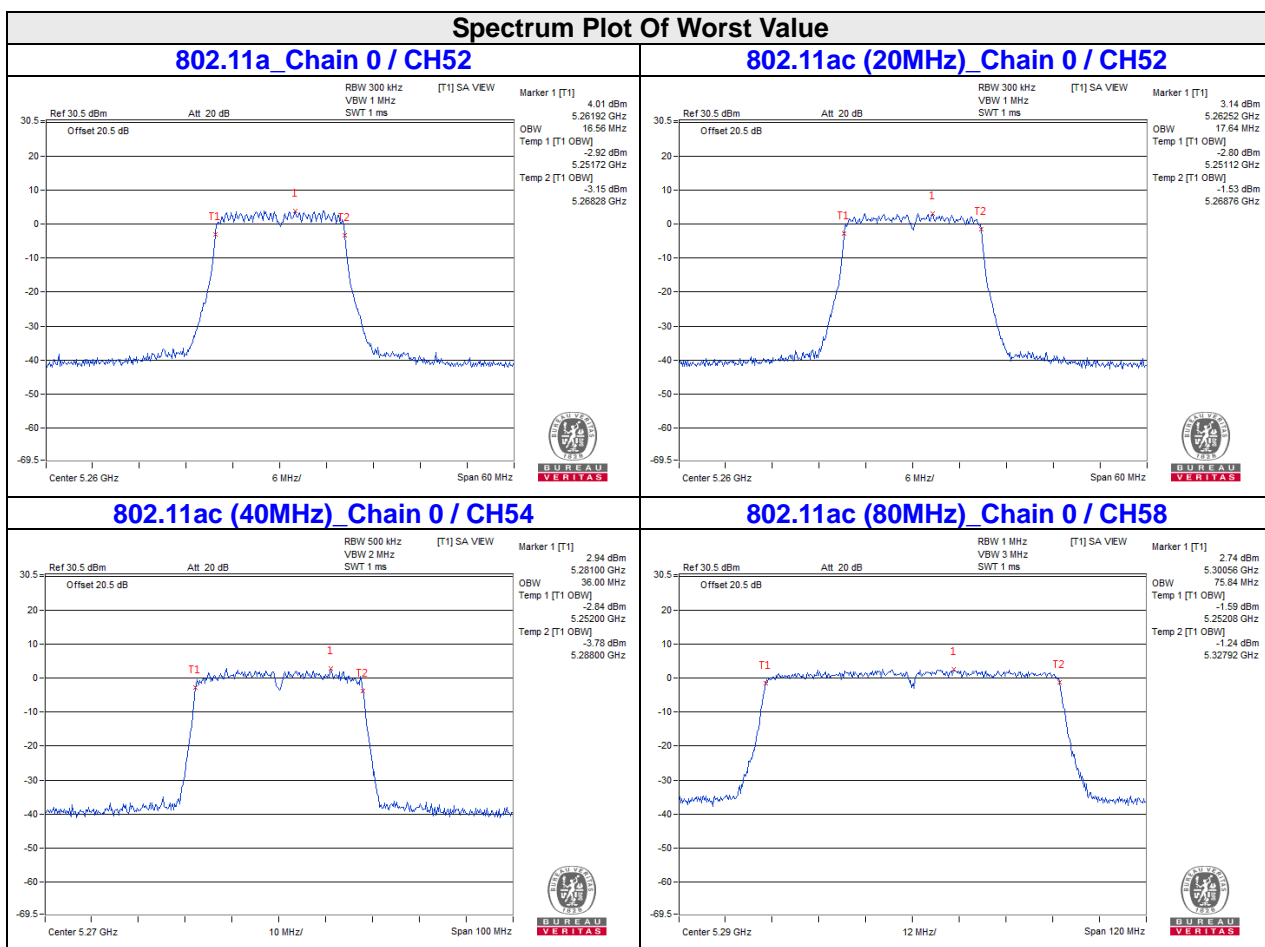

4.5 Peak Power Spectral Density Measurement

4.5.1 Limits of Peak Power Spectral Density Measurement

Operation Band	EUT Category		Limit
U-NII-1	---	Outdoor Access Point	17dBm/ MHz
	---	Fixed point-to-point Access Point	
	---	Indoor Access Point	
	---	Mobile and Portable client device	11dBm/ MHz
U-NII-2A	√		11dBm/ MHz
U-NII-2C	√		11dBm/ MHz
U-NII-3	---		30dBm/ 500kHz

4.5.2 Test Setup

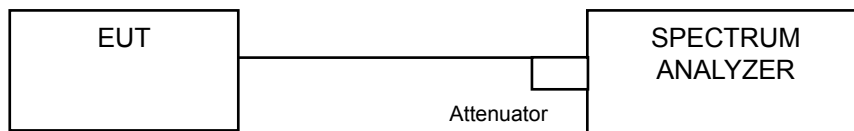

4.5.3 Test Instruments

Refer to section 4.1.2 to get information of above instrument.

4.5.4 Test Procedure

For U-NII-2A, U-NII-2C band:

Using method SA-1

- 1) Set span to encompass the entire emission bandwidth (EBW) of the signal.
- 2) Set RBW = 1 MHz, Set VBW ≥ 3 MHz, Detector = RMS
- 3) Sweep time = auto, trigger set to "free run".
- 4) Trace average at least 100 traces in power averaging mode.
- 5) Record the max value

4.5.5 Deviation from Test Standard

No deviation.

4.5.6 EUT Operating Condition

Same as Item 4.3.6.

4.5.7 Test Results

CDD Mode

802.11a

Chan.	Chan. Freq. (MHz)	PSD (dBm/MHz)		Duty Factor	Total Power Density (dBm/MHz)	MAX. Limit (dBm/MHz)	Pass / Fail
		Chain 0	Chain 1				
52	5260	-0.49	-0.51	0.17	2.68	7.56	Pass
60	5300	-0.68	-0.62	0.17	2.53	7.56	Pass
64	5320	-0.45	-0.43	0.17	2.74	7.56	Pass
100	5500	4.11	4.12	0.17	7.30	7.56	Pass
120	5600	4.09	4.14	0.17	7.30	7.56	Pass
132	5660	4.10	4.13	0.17	7.30	7.56	Pass
140	5700	4.15	4.15	0.17	7.33	7.56	Pass

- Note:**
- Method a) of power density measurement of KDB 662911 is using for calculating total power density. Total power density is summing entire spectra across corresponding frequency bins on the various outputs by computer.
 - Directional gain = $10 \log[(10^{G1/20} + 10^{G2/20} + \dots + 10^{GN/20})^2 / 2] = 9.44\text{dBi} > 6\text{dBi}$, so the PSD limit shall be reduced to $11 - (9.44 - 6) = 7.56\text{dBm}$
 - Refer to section 3.3 for duty cycle spectrum plot.

802.11ac (20MHz)

Chan.	Chan. Freq. (MHz)	PSD (dBm/MHz)		Total Power Density (dBm/MHz)	MAX. Limit (dBm/MHz)	Pass / Fail
		Chain 0	Chain 1			
52	5260	-1.21	-1.20	1.81	7.56	Pass
60	5300	-1.27	-1.25	1.75	7.56	Pass
64	5320	-1.04	-1.03	1.98	7.56	Pass
100	5500	4.32	4.34	7.34	7.56	Pass
120	5600	4.30	4.36	7.34	7.56	Pass
132	5660	4.31	4.36	7.35	7.56	Pass
140	5700	4.27	4.29	7.29	7.56	Pass

- Note:**
- Method a) of power density measurement of KDB 662911 is using for calculating total power density. Total power density is summing entire spectra across corresponding frequency bins on the various outputs by computer.
 - Directional gain = $10 \log[(10^{G1/20} + 10^{G2/20} + \dots + 10^{GN/20})^2 / 2] = 9.44\text{dBi} > 6\text{dBi}$, so the PSD limit shall be reduced to $11 - (9.44 - 6) = 7.56\text{dBm}$

802.11ac (40MHz)

Chan.	Chan. Freq. (MHz)	PSD (dBm/MHz)		Duty Factor	Total Power Density (dBm/MHz)	MAX. Limit (dBm/MHz)	Pass / Fail
		Chain 0	Chain 1				
54	5270	-3.83	-3.80	0.22	-0.58	7.56	Pass
62	5310	-3.81	-3.84	0.22	-0.59	7.56	Pass
102	5510	3.59	3.55	0.22	6.80	7.56	Pass
110	5550	3.55	3.58	0.22	6.80	7.56	Pass
134	5670	3.64	3.68	0.22	6.89	7.56	Pass

- Note:**
- Method a) of power density measurement of KDB 662911 is using for calculating total power density. Total power density is summing entire spectra across corresponding frequency bins on the various outputs by computer.
 - Directional gain = $10 \log[(10^{G1/20} + 10^{G2/20} + \dots + 10^{GN/20})^2 / 2] = 9.44\text{dBi} > 6\text{dBi}$, so the PSD limit shall be reduced to $11 - (9.44 - 6) = 7.56\text{dBm}$
 - Refer to section 3.3 for duty cycle spectrum plot.

802.11ac (80MHz)

Chan.	Chan. Freq. (MHz)	PSD (dBm/MHz)		Duty Factor	Total Power Density (dBm/MHz)	MAX. Limit (dBm/MHz)	Pass / Fail
		Chain 0	Chain 1				
58	5290	-7.54	-7.44	0.38	-4.10	7.56	Pass
106	5530	0.52	0.55	0.38	3.93	7.56	Pass
122	5610	0.58	0.54	0.38	3.95	7.56	Pass

- Note:**
- Method a) of power density measurement of KDB 662911 is using for calculating total power density. Total power density is summing entire spectra across corresponding frequency bins on the various outputs by computer.
 - Directional gain = $10 \log[(10^{G1/20} + 10^{G2/20} + \dots + 10^{GN/20})^2 / 2] = 9.44\text{dBi} > 6\text{dBi}$, so the PSD limit shall be reduced to $11 - (9.44 - 6) = 7.56\text{dBm}$
 - Refer to section 3.3 for duty cycle spectrum plot.

Spectrum Plot of Worst Value

802.11a_Chain 0 / CH140

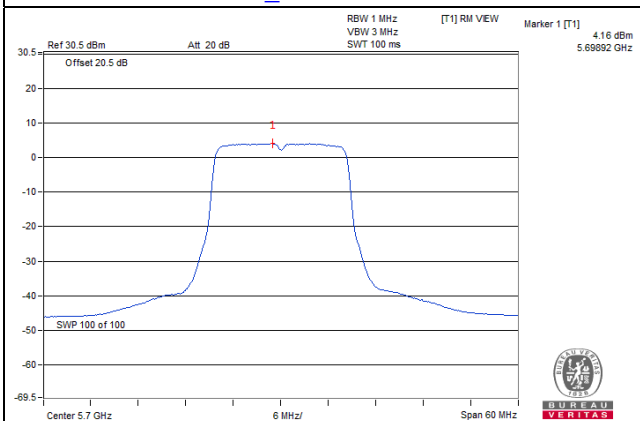

802.11ac (20MHz)_Chain 1 / CH120

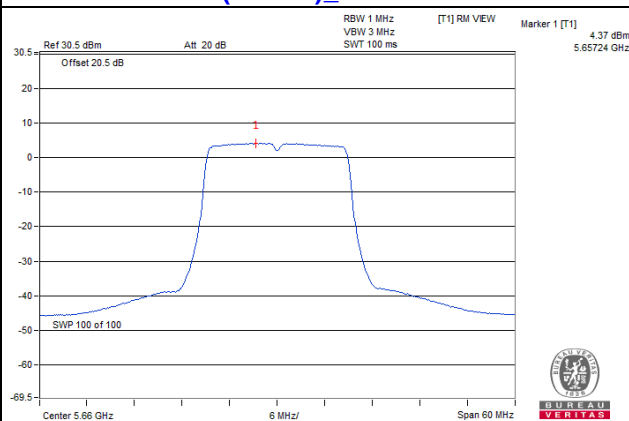

802.11ac (40MHz)_Chain 1 / CH134

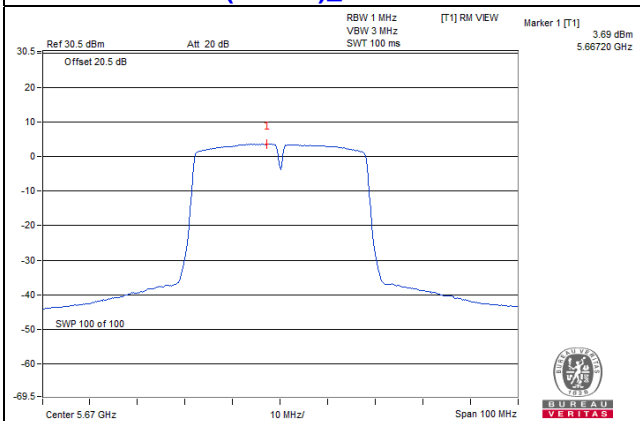

802.11ac (80MHz)_Chain 0 / CH122

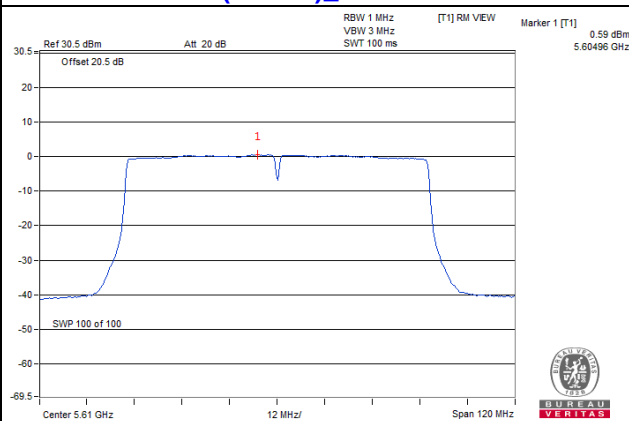

4.6 Frequency Stability Measurement

4.6.1 Limits of Frequency Stability Measurement

The frequency of the carrier signal shall be maintained within band of operation

4.6.2 Test Setup

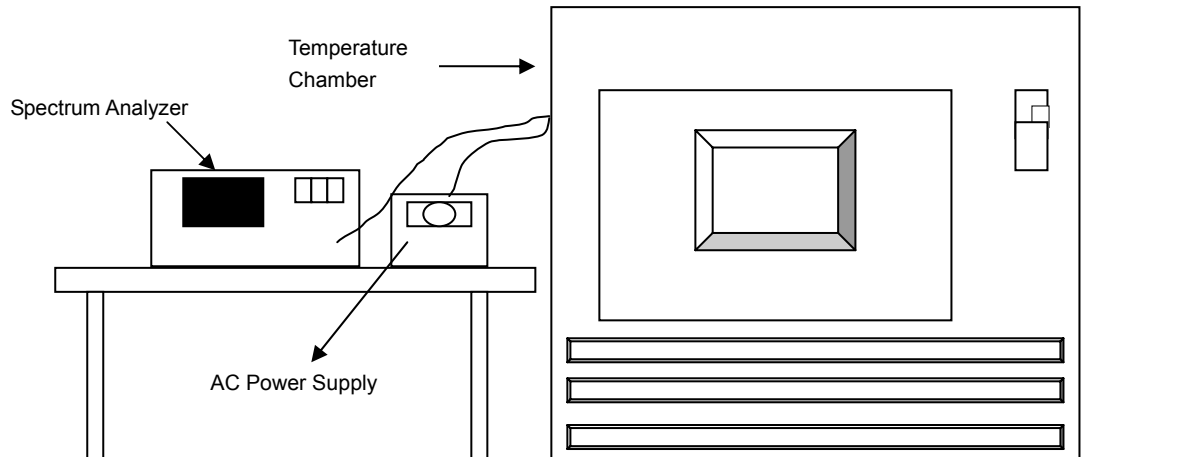

4.6.3 Test Instruments

Refer to section 4.1.2 to get information of above instrument.

4.6.4 Test Procedure

- The EUT was placed inside the environmental test chamber and powered by nominal AC voltage.
- Turn the EUT on and couple its output to a spectrum analyzer.
- Turn the EUT off and set the chamber to the highest temperature specified.
- Allow sufficient time (approximately 30 min) for the temperature of the chamber to stabilize, turn the EUT on and measure the operating frequency after 2, 5, and 10 Minutes.
- Repeat step 2 and 3 with the temperature chamber set to the lowest temperature.
- The test chamber was allowed to stabilize at +20 degree C for a minimum of 30 Minutes. The supply voltage was then adjusted on the EUT from 85% to 115% and the frequency record.

4.6.5 Deviation from Test Standard

No deviation.

4.6.6 EUT Operating Condition

Set the EUT transmit at un-modulation mode to test frequency stability.

4.6.7 Test Results

CDD Mode

Frequency Stability Versus Temp.									
Operating Frequency: 5260 MHz									
TEMP. (°C)	Power Supply (Vac)	0 Minute		2 Minute		5 Minute		10 Minute	
		Measured Frequency (MHz)	Pass/Fail	Measured Frequency (MHz)	Pass/Fail	Measured Frequency (MHz)	Pass/Fail	Measured Frequency (MHz)	Pass/Fail
50	120	5260.042969	Pass	5260.043329	Pass	5260.043051	Pass	5260.042921	Pass
40	120	5260.044069	Pass	5260.043695	Pass	5260.043446	Pass	5260.043793	Pass
30	120	5260.042171	Pass	5260.042054	Pass	5260.041742	Pass	5260.041993	Pass
20	120	5260.043492	Pass	5260.043469	Pass	5260.043158	Pass	5260.043363	Pass
10	120	5260.044012	Pass	5260.043995	Pass	5260.043747	Pass	5260.044133	Pass
0	120	5260.042766	Pass	5260.042496	Pass	5260.042786	Pass	5260.04272	Pass
-10	120	5260.043214	Pass	5260.043071	Pass	5260.042910	Pass	5260.043318	Pass
-20	120	5260.043323	Pass	5260.043395	Pass	5260.043533	Pass	5260.043245	Pass

Frequency Stability Versus Voltage									
Operating Frequency: 5260 MHz									
TEMP. (°C)	Power Supply (Vac)	0 Minute		2 Minute		5 Minute		10 Minute	
		Measured Frequency(MHz)	Pass/Fail	Measured Frequency(M Hz)	Pass/Fail	Measured Frequency(MHz)	Pass/Fail	Measured Frequency(M Hz)	Pass/Fail
20	138	5260.042488	Pass	5260.04241	Pass	5260.042569	Pass	5260.042451	Pass
	120	5260.043492	Pass	5260.043469	Pass	5260.043158	Pass	5260.043363	Pass
	102	5260.043171	Pass	5260.043003	Pass	5260.043166	Pass	5260.043072	Pass

5 Pictures of Test Arrangements

Please refer to the attached file (Test Setup Photo).

Appendix – Information on the Testing Laboratories

We, Bureau Veritas Consumer Products Services (H.K.) Ltd., Taoyuan Branch, were founded in 1988 to provide our best service in EMC, Radio, Telecom and Safety consultation. Our laboratories are accredited and approved according to ISO/IEC 17025.

If you have any comments, please feel free to contact us at the following:

Linko EMC/RF Lab

Tel: 886-2-26052180

Fax: 886-2-26051924

Hsin Chu EMC/RF/Telecom Lab

Tel: 886-3-6668565

Fax: 886-3-6668323

Hwa Ya EMC/RF/Safety Lab

Tel: 886-3-3183232

Fax: 886-3-3270892

Email: service.adt@tw.bureauveritas.com

Web Site: www.bureauveritas-adt.com

The address and road map of all our labs can be found in our web site also.

--- END ---