

## FCC Test Report

**Report No.:** RF170918D05-1

**FCC ID:** 2AI9TOAW-AP125X

**Test Model:** OAW-AP1251

**Received Date:** May 8, 2017

**Test Date:** May 9 ~ Sep. 20, 2017

**Issued Date:** Nov. 16, 2017

**Applicant:** ALE USA Inc.

**Address:** 26801 West Agoura Road, Calabasas, CA 91301

**Issued By:** Bureau Veritas Consumer Products Services (H.K.) Ltd., Taoyuan Branch

**Lab Address:** No. 47-2, 14th Ling, Chia Pau Vil., Lin Kou Dist., New Taipei City, Taiwan, R.O.C.

**FCC Registration /  
Designation Number:** 198487 / TW2021



This report is for your exclusive use. Any copying or replication of this report to or for any other person or entity, or use of our name or trademark, is permitted only with our prior written permission. This report sets forth our findings solely with respect to the test samples identified herein. The results set forth in this report are not indicative or representative of the quality or characteristics of the lot from which a test sample was taken or any similar or identical product unless specifically and expressly noted. Our report includes all of the tests requested by you and the results thereof based upon the information that you provided to us. You have 60 days from date of issuance of this report to notify us of any material error or omission caused by our negligence, provided, however, that such notice shall be in writing and shall specifically address the issue you wish to raise. A failure to raise such issue within the prescribed time shall constitute your unqualified acceptance of the completeness of this report, the tests conducted and the correctness of the report contents. Unless specific mention, the uncertainty of measurement has been explicitly taken into account to declare the compliance or non-compliance to the specification. The report must not be used by the client to claim product certification, approval, or endorsement by TAF or any government agencies.

## Table of Contents

<b>Release Control Record</b> .....	<b>4</b>
<b>1 Certificate of Conformity</b> .....	<b>5</b>
<b>2 Summary of Test Results</b> .....	<b>6</b>
2.1 Measurement Uncertainty .....	6
2.2 Modification Record .....	6
<b>3 General Information</b> .....	<b>7</b>
3.1 General Description of EUT .....	7
3.2 Description of Test Modes .....	9
3.2.1 Test Mode Applicability and Tested Channel Detail .....	10
3.3 Duty Cycle of Test Signal .....	13
3.4 Description of Support Units .....	14
3.4.1 Configuration of System under Test .....	14
3.5 General Description of Applied Standard .....	15
<b>4 Test Types and Results</b> .....	<b>16</b>
4.1 Radiated Emission and Bandedge Measurement.....	16
4.1.1 Limits of Radiated Emission and Bandedge Measurement .....	16
4.1.2 Test Instruments .....	17
4.1.3 Test Procedure .....	18
4.1.4 Deviation from Test Standard .....	18
4.1.5 Test Setup.....	19
4.1.6 EUT Operating Condition .....	20
4.1.7 Test Results .....	21
4.2 Conducted Emission Measurement .....	52
4.2.1 Limits of Conducted Emission Measurement .....	52
4.2.2 Test Instruments .....	52
4.2.3 Test Procedure .....	53
4.2.4 Deviation from Test Standard .....	53
4.2.5 Test Setup.....	53
4.2.6 EUT Operating Condition .....	53
4.2.7 Test Results .....	54
4.3 Transmit Power Measurement .....	56
4.3.1 Limits of Transmit Power Measurement .....	56
4.3.2 Test Setup.....	56
4.3.3 Test Instruments .....	56
4.3.4 Test Procedure .....	57
4.3.5 Deviation from Test Standard .....	57
4.3.6 EUT Operating Condition .....	57
4.3.7 Test Result.....	58
4.4 Occupied Bandwidth Measurement .....	64
4.4.1 Test Setup.....	64
4.4.2 Test Instruments .....	64
4.4.3 Test Procedure .....	64
4.4.4 Test Results .....	65
4.5 Peak Power Spectral Density Measurement.....	67
4.5.1 Limits of Peak Power Spectral Density Measurement .....	67
4.5.2 Test Setup.....	67
4.5.3 Test Instruments .....	67
4.5.4 Test Procedure .....	68
4.5.5 Deviation from Test Standard .....	68
4.5.6 EUT Operating Condition .....	68
4.5.7 Test Results .....	69
4.6 Frequency Stability Measurement.....	74

4.6.1	Limits of Frequency Stability Measurement.....	74
4.6.2	Test Setup.....	74
4.6.3	Test Instruments .....	74
4.6.4	Test Procedure .....	74
4.6.5	Deviation from Test Standard .....	74
4.6.6	EUT Operating Condition .....	74
4.6.7	Test Results .....	75
4.7	6dB Bandwidth Measurement.....	76
4.7.1	Limits of 6dB Bandwidth Measurement.....	76
4.7.2	Test Setup.....	76
4.7.3	Test Instruments .....	76
4.7.4	Test Procedure .....	76
4.7.5	Deviation from Test Standard .....	76
4.7.6	EUT Operating Condition .....	76
4.7.7	Test Results .....	77
<b>5</b>	<b>Pictures of Test Arrangements.....</b>	<b>79</b>
	<b>Annex A- Radiated Out of Band Emission (OOBE) Measurement (For U-NII-3 band).....</b>	<b>80</b>
	<b>Appendix – Information on the Testing Laboratories .....</b>	<b>85</b>

### Release Control Record

Issue No.	Description	Date Issued
RF170918D05-1	Original release.	Nov. 16, 2017

## 1 Certificate of Conformity

**Product:** OmniAccess Stellar  
**Brand:** Alcatel-Lucent Enterprise  
**Test Model:** OAW-AP1251  
**Sample Status:** Engineering sample  
**Applicant:** ALE USA Inc.  
**Test Date:** May 9 ~ Sep. 20, 2017  
**Standard:** 47 CFR FCC Part 15, Subpart E (Section 15.407)  
ANSI C63.10: 2013

The above equipment has been tested by **Bureau Veritas Consumer Products Services (H.K.) Ltd., Taoyuan Branch**, and found compliance with the requirement of the above standards. The test record, data evaluation & Equipment Under Test (EUT) configurations represented herein are true and accurate accounts of the measurements of the sample's EMC characteristics under the conditions specified in this report.

**Prepared by :** Annie Chang , **Date:** Nov. 16, 2017  
Annie Chang / Senior Specialist

**Approved by :** Rex Lai , **Date:** Nov. 16, 2017  
Rex Lai / Assistant Manager

## 2 Summary of Test Results

47 CFR FCC Part 15, Subpart E (Section 15.407)			
FCC Clause	Test Item	Result	Remarks
15.407(b)(6)	AC Power Conducted Emissions	Pass	Meet the requirement of limit. Minimum passing margin is -9.16dB at 0.52891MHz.
15.407(b)(1/2/3/4(i/ii)/6)	Radiated Emissions & Band Edge Measurement*	Pass	Meet the requirement of limit. Minimum passing margin is -0.97dB at 5150.00MHz.
15.407(a)(1/2/3)	Max Average Transmit Power	Pass	Meet the requirement of limit.
---	Occupied Bandwidth Measurement	-	Reference only.
15.407(a)(1/2/3)	Peak Power Spectral Density	Pass	Meet the requirement of limit.
15.407(e)	6dB bandwidth	Pass	Meet the requirement of limit. (U-NII-3 Band only)
15.407(g)	Frequency Stability	Pass	Meet the requirement of limit.
15.203	Antenna Requirement	Pass	Antenna connector is MMCX not a standard connector.

\*For U-NII-3 band compliance with rule part 15.407(b)(4)(i), the OOB test plots were recorded in Annex A.

### 2.1 Measurement Uncertainty

Where relevant, the following measurement uncertainty levels have been estimated for tests performed on the EUT as specified in CISPR 16-4-2:

Measurement	Frequency	Expanded Uncertainty (k=2) ( $\pm$ )
Conducted Emissions at mains ports	150kHz ~ 30MHz	2.77 dB
Radiated Emissions up to 1 GHz	9kHz ~ 30MHz	2.38 dB
	30MHz ~ 1000MHz	5.54 dB
Radiated Emissions above 1 GHz	Above 1GHz	5.48 dB

### 2.2 Modification Record

There were no modifications required for compliance.

### 3 General Information

#### 3.1 General Description of EUT

Product	OmniAccess Stellar
Brand	Alcatel-Lucent Enterprise
Test Model	OAW-AP1251
Status of EUT	Engineering sample
Power Supply Rating	48Vdc from PoE
Modulation Type	64QAM, 16QAM, QPSK, BPSK 256QAM for OFDM in 11ac mode only.
Modulation Technology	OFDM
Transfer Rate	802.11a: 54/48/36/24/18/12/9/6Mbps 802.11n: up to 300Mbps 802.11ac: up to 867Mbps
Operating Frequency	5180 ~ 5240MHz 5745 ~ 5825MHz
Number of Channel	<b>5180 ~ 5240MHz</b> 4 for 802.11a, 802.11n (20MHz), 802.11ac (20MHz) 2 for 802.11n (40MHz), 802.11ac (40MHz) 1 for 802.11ac (80MHz) <b>5745 ~ 5825MHz</b> 5 for 802.11a, 802.11n (20MHz) 802.11ac (20MHz) 2 for 802.11n (40MHz) 802.11ac (40MHz) 1 for 802.11ac (80MHz)
Output Power	<b>5180 ~ 5240MHz:</b> 24.401mW <b>5745 ~ 5825MHz:</b> 422.528mW
Antenna Type	Refer to note as below
Antenna Connector	Refer to note as below
Accessory Device	N/A
Data Cable Supplied	N/A

Note:

- The EUT incorporates a MIMO function. Physically, the EUT provides 2 completed transmitters and 2 receivers.

Modulation Mode	TX FUNCTION
802.11a	2TX
802.11n (20MHz)	2TX
802.11n (40MHz)	2TX
802.11ac (20MHz)	2TX
802.11ac (40MHz)	2TX
802.11ac (80MHz)	2TX

\* The modulation and bandwidth are similar for 802.11n mode for 20MHz / 40MHz and 802.11ac mode for 20MHz / 40MHz, therefore investigated worst case to representative mode in test report. (Final test mode refer section 3.2.1)

2. The antennas provided to the EUT, please refer to the following table:

Frequency Band (MHz)	Chain No.	Antenna Type	Antenna Gain (dBi)	Connector Type
5180-5240	Chain 0	Omni	6.97	MMCX
	Chain 1	Omni	6.97	
5745-5825	Chain 0	Omni	6.62	
	Chain 1	Omni	6.24	

3. The directional gain table:

Frequency Band (MHz)	Max. Gain (dBi)
5180-5240	9.98
5745-5825	9.44

Note:

(i) If transmit signals are *correlated*, then

Directional gain =  $10 \log[(10^{G_1/20} + 10^{G_2/20} + \dots + 10^{G_N/20})^2 / N_{ANT}]$  dBi [Note the “20”s in the denominator of each exponent and the square of the sum of terms; the object is to combine the signal levels coherently.]

4. The above EUT information is declared by manufacturer and for more detailed features description, please refer to the manufacturer's specifications or user's manual.



### 3.2 Description of Test Modes

#### FOR 5180 ~ 5240MHz

4 channels are provided for 802.11a, 802.11n (20MHz), 802.11ac (20MHz):

Channel	Frequency	Channel	Frequency
36	5180 MHz	44	5220 MHz
40	5200 MHz	48	5240 MHz

2 channels are provided for 802.11n (40MHz), 802.11ac (40MHz):

Channel	Frequency	Channel	Frequency
38	5190 MHz	46	5230 MHz

1 channel is provided for 802.11ac (80MHz):

Channel	Frequency
42	5210MHz

#### FOR 5745 ~ 5825MHz:

5 channels are provided for 802.11a, 802.11n (20MHz), 802.11ac (20MHz):

Channel	Frequency	Channel	Frequency
149	5745MHz	161	5805MHz
153	5765MHz	165	5825MHz
157	5785MHz		

2 channels are provided for 802.11n (40MHz), 802.11ac (40MHz):

Channel	Frequency	Channel	Frequency
151	5755MHz	159	5795MHz

1 channel is provided for 802.11ac (80MHz):

Channel	Frequency
155	5775MHz

### 3.2.1 Test Mode Applicability and Tested Channel Detail

EUT Configure Mode	Applicable To				Description
	RE≥1G	RE<1G	PLC	APCM	
-	√	√	√	√	-

Where **RE≥1G**: Radiated Emission above 1GHz      **RE<1G**: Radiated Emission below 1GHz  
**PLC**: Power Line Conducted Emission      **APCM**: Antenna Port Conducted Measurement

**NOTE**: The EUT had been pre-tested on the positioned of each 3 axis. The worst case was found when positioned on **Y-plane**

#### **Radiated Emission Test (Above 1GHz):**

- Pre-Scan has been conducted to determine the worst-case mode from all possible combinations between available modulations, data rates and antenna ports (if EUT with antenna diversity architecture).
- Following channel(s) was (were) selected for the final test as listed below.

CDD Mode							
EUT Configure Mode	Mode	FREQ. Band (MHz)	Available Channel	Tested Channel	Modulation Technology	Modulation Type	Data Rate (Mbps)
-	802.11a	5180-5240	36 to 48	36, 40, 48	OFDM	BPSK	6
-	802.11ac (20MHz)		36 to 48	36, 40, 48	OFDM	BPSK	6.5
-	802.11ac (40MHz)		38 to 46	38, 46	OFDM	BPSK	13.5
-	802.11ac (80MHz)		42	42	OFDM	BPSK	29.3
-	802.11a	5745-5825	149 to 165	149, 157, 165	OFDM	BPSK	6
-	802.11ac (20MHz)		149 to 165	149, 157, 165	OFDM	BPSK	6.5
-	802.11ac (40MHz)		151 to 159	151, 159	OFDM	BPSK	13.5
-	802.11ac (80MHz)		155	155	OFDM	BPSK	29.3
Beamforming_NSS1 Mode							
EUT Configure Mode	Mode	FREQ. Band (MHz)	Available Channel	Tested Channel	Modulation Technology	Modulation Type	Data Rate (Mbps)
-	802.11ac (20MHz)	5180-5240	36 to 48	36, 40, 48	OFDM	BPSK	6.5
-	802.11ac (40MHz)		38 to 46	38, 46	OFDM	BPSK	13.5
-	802.11ac (80MHz)		42	42	OFDM	BPSK	29.3
-	802.11ac (20MHz)	5745-5825	149 to 165	149, 157, 165	OFDM	BPSK	6.5
-	802.11ac (40MHz)		151 to 159	151, 159	OFDM	BPSK	13.5
-	802.11ac (80MHz)		155	155	OFDM	BPSK	29.3

**Radiated Emission Test (Below 1GHz):**

- Pre-Scan has been conducted to determine the worst-case mode from all possible combinations between available modulations, data rates and antenna ports (if EUT with antenna diversity architecture).
- Following channel(s) was (were) selected for the final test as listed below.

<b>CDD Mode</b>							
<b>EUT Configure Mode</b>	<b>Mode</b>	<b>FREQ. Band (MHz)</b>	<b>Available Channel</b>	<b>Tested Channel</b>	<b>Modulation Technology</b>	<b>Modulation Type</b>	<b>Data Rate (Mbps)</b>
-	802.11a	5180-5240	36 to 48	40	OFDM	BPSK	6
	802.11a	5745-5825	149 to 165		OFDM	BPSK	6

**Power Line Conducted Emission Test:**

- Pre-Scan has been conducted to determine the worst-case mode from all possible combinations between available modulations, data rates and antenna ports (if EUT with antenna diversity architecture).
- Following channel(s) was (were) selected for the final test as listed below.

<b>CDD Mode</b>							
<b>EUT Configure Mode</b>	<b>Mode</b>	<b>FREQ. Band (MHz)</b>	<b>Available Channel</b>	<b>Tested Channel</b>	<b>Modulation Technology</b>	<b>Modulation Type</b>	<b>Data Rate (Mbps)</b>
-	802.11a	5180-5240	36 to 48	40	OFDM	BPSK	6
	802.11a	5745-5825	149 to 165		OFDM	BPSK	6

### Antenna Port Conducted Measurement:

- This item includes all test value of each mode, but only includes spectrum plot of worst value of each mode.
- Pre-Scan has been conducted to determine the worst-case mode from all possible combinations between available modulations, data rates and antenna ports (if EUT with antenna diversity architecture).
- Following channel(s) was (were) selected for the final test as listed below.

<b>CDD Mode</b>							
EUT Configure Mode	Mode	FREQ. Band (MHz)	Available Channel	Tested Channel	Modulation Technology	Modulation Type	Data Rate (Mbps)
-	802.11a	5180-5240	36 to 48	36, 40, 48	OFDM	BPSK	6
-	802.11ac (20MHz)		36 to 48	36, 40, 48	OFDM	BPSK	6.5
-	802.11ac (40MHz)		38 to 46	38, 46	OFDM	BPSK	13.5
-	802.11ac (80MHz)		42	42	OFDM	BPSK	29.3
-	802.11a	5745-5825	149 to 165	149, 157, 165	OFDM	BPSK	6
-	802.11ac (20MHz)		149 to 165	149, 157, 165	OFDM	BPSK	6.5
-	802.11ac (40MHz)		151 to 159	151, 159	OFDM	BPSK	13.5
-	802.11ac (80MHz)		155	155	OFDM	BPSK	29.3
<b>Beamforming_NSS1 Mode (Output Power Only)</b>							
EUT Configure Mode	Mode	FREQ. Band (MHz)	Available Channel	Tested Channel	Modulation Technology	Modulation Type	Data Rate (Mbps)
-	802.11ac (20MHz)	5180-5240	36 to 48	36, 40, 48	OFDM	BPSK	6.5
-	802.11ac (40MHz)		38 to 46	38, 46	OFDM	BPSK	13.5
-	802.11ac (80MHz)		42	42	OFDM	BPSK	29.3
-	802.11ac (20MHz)	5745-5825	149 to 165	149, 157, 165	OFDM	BPSK	6.5
-	802.11ac (40MHz)		151 to 159	151, 159	OFDM	BPSK	13.5
-	802.11ac (80MHz)		155	155	OFDM	BPSK	29.3

### Test Condition:

Applicable To	Environmental Conditions	Input Power	Tested By
RE $\geq$ 1G	20deg. C, 67%RH	120Vac, 60Hz	Ian Chang
RE<1G	24deg. C, 68%RH	120Vac, 60Hz	Ian Chang
PLC	26deg. C, 77%RH	120Vac, 60Hz	Ian Chang
APCM	25deg. C, 76%RH	120Vac, 60Hz	Saxon Lee

### 3.3 Duty Cycle of Test Signal

Duty cycle of test signal is > 98 %, duty factor is not required

Duty cycle of test signal is < 98 %, duty factor is required

**802.11a:** Duty cycle = 2.055/2.139 = 0.961, Duty factor =  $10 * \log(1/0.961) = 0.17$

**802.11ac (20MHz):** Duty cycle = 98.2%

**802.11ac (40MHz):** Duty cycle = 2.385/2.510 = 0.950, Duty factor =  $10 * \log(1/0.950) = 0.22$

**802.11ac (80MHz):** Duty cycle = 1.116/1.218 = 0.916, Duty factor =  $10 * \log(1/0.916) = 0.38$

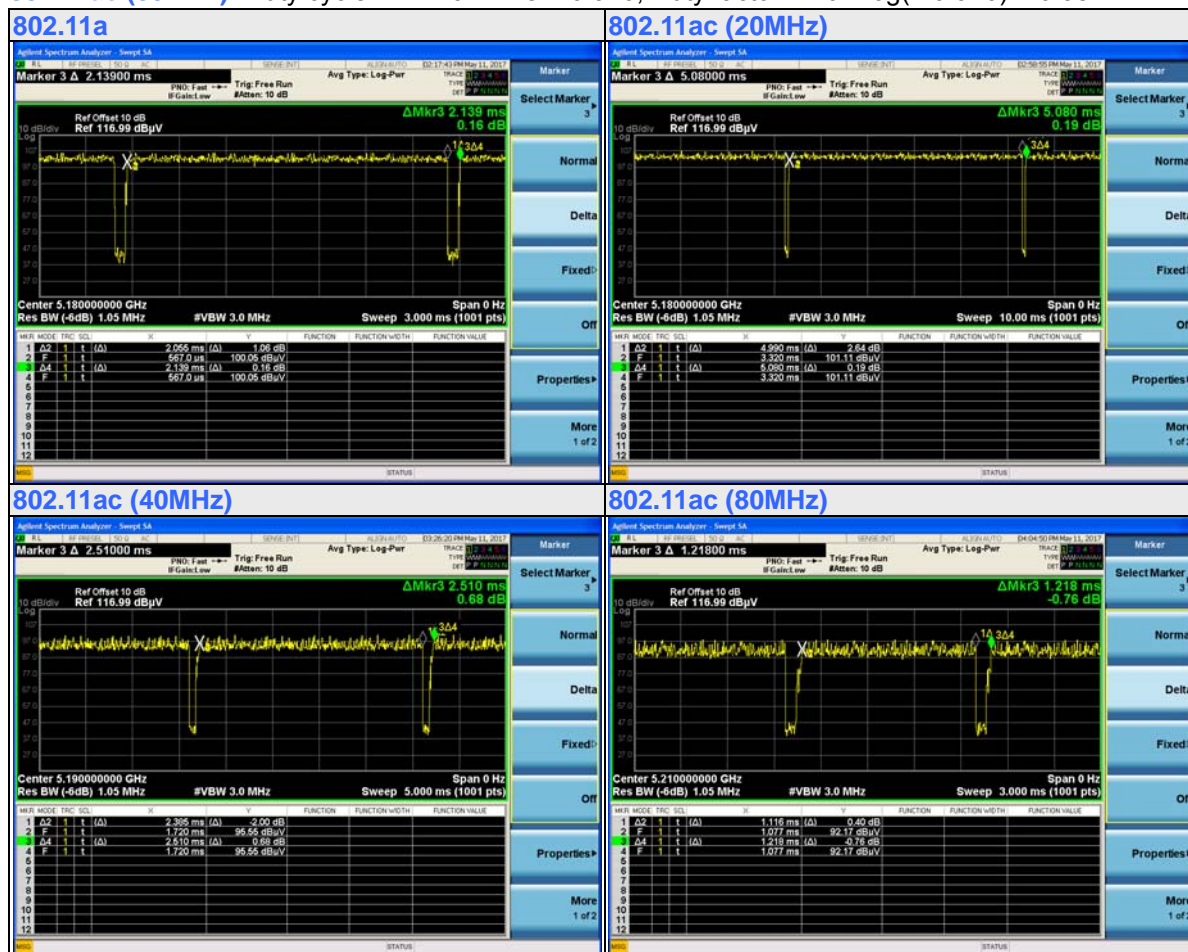

### 3.4 Description of Support Units

The EUT has been tested as an independent unit together with other necessary accessories or support units. The following support units or accessories were used to form a representative test configuration during the tests.

ID	Product	Brand	Model No.	Serial No.	FCC ID	Remarks
A.	Notebook PC	DELL	E6530	9331GV1	FCC DoC Approved	Provided by Lab
B.	PoE Adapter	Microsemi	PD-3501G/AC	N/A	N/A	Supplied by client
C.	Load	N/A	N/A	N/A	N/A	Provided by Lab

Note:

1. All power cords of the above support units are non-shielded (1.8m).
2. Items A~B acted as communication partners to transfer data.
3. The rating of support unit B was as follows:  
AC I/P: 100-240V, 50/60Hz, 0.43A  
DC O/P: 48V, 0.35A

ID	Descriptions	Qty.	Length (m)	Shielding (Yes/No)	Cores (Qty.)	Remarks
1.	LAN cable	1	1.2	N	0	Provided by Lab
2.	LAN cable	1	10	N	0	Provided by Lab
3.	LAN cable	1	1.8	N	0	Provided by Lab

Note: The core(s) is(are) originally attached to the cable(s).

#### 3.4.1 Configuration of System under Test

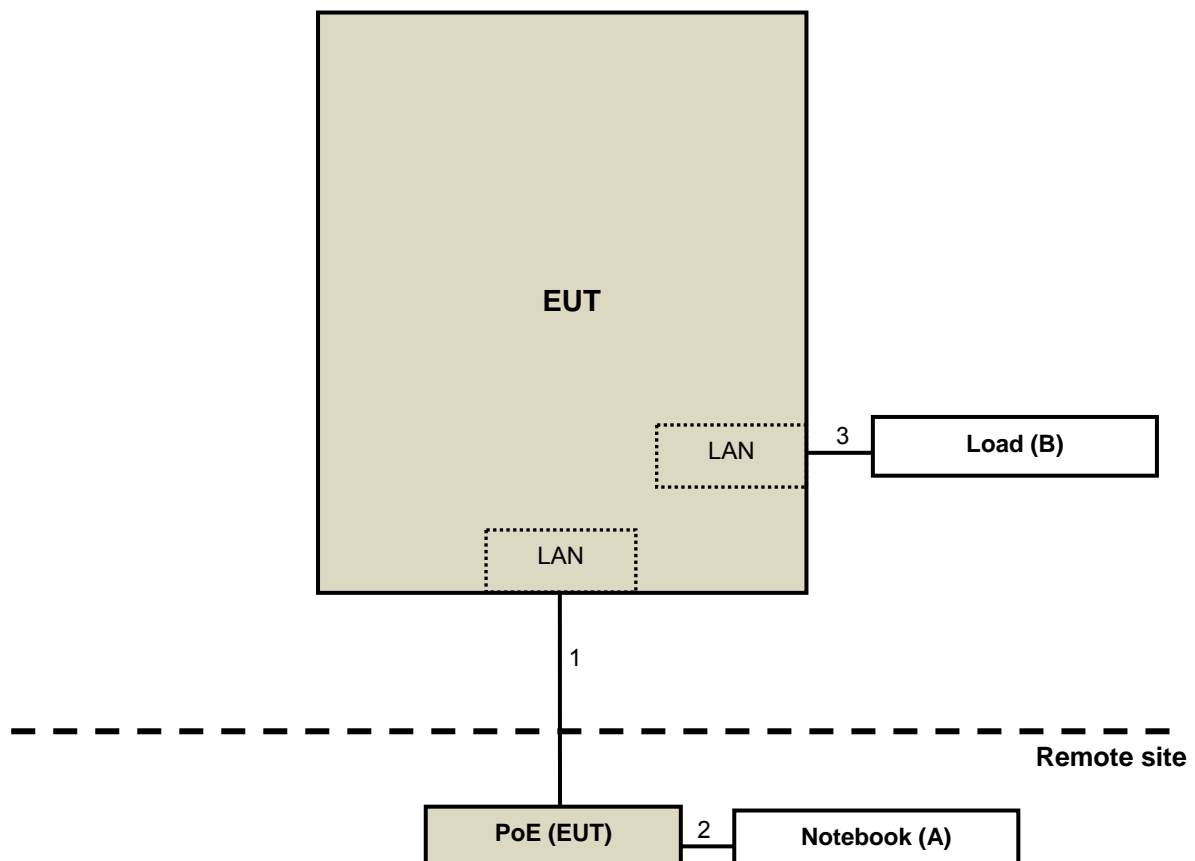

### 3.5 General Description of Applied Standard

The EUT is a RF Product. According to the specifications of the manufacturer, it must comply with the requirements of the following standards:

**FCC Part 15, Subpart E (15.407)**  
**KDB 789033 D02 General UNII Test Procedure New Rules v04**  
**KDB 662911 D01 Multiple Transmitter Output v02r01**  
**ANSI C63.10-2013**

All test items have been performed and recorded as per the above standards.

## 4 Test Types and Results

### 4.1 Radiated Emission and Bandedge Measurement

#### 4.1.1 Limits of Radiated Emission and Bandedge Measurement

Radiated emissions which fall in the restricted bands must comply with the radiated emission limits specified as below table.

Frequencies (MHz)	Field Strength (microvolts/meter)	Measurement Distance (meters)
0.009 ~ 0.490	2400/F(kHz)	300
0.490 ~ 1.705	24000/F(kHz)	30
1.705 ~ 30.0	30	30
30 ~ 88	100	3
88 ~ 216	150	3
216 ~ 960	200	3
Above 960	500	3

**NOTE:**

1. The lower limit shall apply at the transition frequencies.
2. Emission level (dBuV/m) = 20 log Emission level (uV/m).
3. For frequencies above 1000MHz, the field strength limits are based on average detector, however, the peak field strength of any emission shall not exceed the maximum permitted average limits, specified above by more than 20dB under any condition of modulation.

Limits of unwanted emission out of the restricted bands

Applicable To		Limit	
789033 D02 General UNII Test Procedure New Rules v01r03		Field Strength at 3m	
		PK:74 (dBµV/m)	AV:54 (dBµV/m)
Frequency Band	Applicable To	EIRP Limit	Equivalent Field Strength at 3m
5150~5250 MHz	15.407(b)(1)	PK:-27 (dBm/MHz)	PK:68.2(dBµV/m)
5250~5350 MHz	15.407(b)(2)		
5470~5725 MHz	15.407(b)(3)		
5725~5850 MHz	<input checked="" type="checkbox"/> 15.407(b)(4)(i)	PK:-27 (dBm/MHz) <sup>*1</sup> PK:10 (dBm/MHz) <sup>*2</sup> PK:15.6 (dBm/MHz) <sup>*3</sup> PK:27 (dBm/MHz) <sup>*4</sup>	PK: 68.2(dBµV/m) <sup>*1</sup> PK:105.2 (dBµV/m) <sup>*2</sup> PK: 110.8(dBµV/m) <sup>*3</sup> PK:122.2 (dBµV/m) <sup>*4</sup>
	<input type="checkbox"/> 15.407(b)(4)(ii)	Emission limits in section 15.247(d)	
<sup>*1</sup> beyond 75 MHz or more above of the band edge. <sup>*3</sup> below the band edge increasing linearly to a level of 15.6 dBm/MHz at 5 MHz above.		<sup>*2</sup> below the band edge increasing linearly to 10 dBm/MHz at 25 MHz above. <sup>*4</sup> from 5 MHz above or below the band edge increasing linearly to a level of 27 dBm/MHz at the band edge.	

**Note:**

The following formula is used to convert the equipment isotropic radiated power (eirp) to field strength:

$$E = \frac{1000000\sqrt{30P}}{3} \mu\text{V/m, where P is the eirp (Watts).}$$



## 4.1.2 Test Instruments

DESCRIPTION & MANUFACTURER	MODEL NO.	SERIAL NO.	CALIBRATED DATE	CALIBRATED UNTIL
HP Preamplifier	8447D	2432A03504	Feb. 21, 2017	Feb. 20, 2018
HP Preamplifier	8449B	3008A01201	Feb. 22, 2017	Feb. 21, 2018
MITEQ Preamplifier	AMF-6F-260400-33-8P	892164	Feb. 21, 2017	Feb. 20, 2018
Agilent TEST RECEIVER	N9038A	MY51210129	Feb. 08, 2017	Feb. 07, 2018
Schwarzbeck Antenna	VULB 9168	139	Dec. 13, 2016	Dec. 12, 2017
Schwarzbeck Horn Antenna	BBHA-9170	212	Dec. 30, 2016	Dec. 29, 2017
Schwarzbeck Horn Antenna	BBHA 9120-D1	D130	Dec. 27, 2016	Dec. 26, 2017
ADT. Turn Table	TT100	0306	NA	NA
ADT. Tower	AT100	0306	NA	NA
Software	Radiated_V7.6.15.9.5	NA	NA	NA
SUHNER RF cable With 4dB PAD	SF104	CABLE-CH6	Aug. 15, 2016	Aug. 14, 2017
			Aug. 14, 2017	Aug. 13, 2018
SUHNER RF cable With 3dB PAD	SF102	Cable-CH8-3.6m	Aug. 15, 2016	Aug. 14, 2017
			Aug. 14, 2017	Aug. 13, 2018
KEYSIGHT MIMO Powermeasurement Test set	U2021XA	U2021XA-001	May 25, 2016	May 24, 2017
			May 31, 2017	May 30, 2018
KEYSIGHT Spectrum Analyzer	N9030A	MY54490260	Jul. 26, 2016	Jul. 25, 2017
			Jul. 26, 2017	Jul. 25, 2018
Loop Antenna TESEQ	HLA 6121	45745	May 20, 2016	May 19, 2017
			May 19, 2017	May 18, 2018
EMCO Horn Antenna	3115	00028257	Dec. 15, 2016	Dec. 14, 2017
Highpass filter Wainwright Instruments	WHK 3.1/18G-10SS	SN 8	NA	NA
ROHDE & SCHWARZ Spectrum Analyzer	FSV40	101042	Sep. 30, 2016	Sep. 29, 2017
Anritsu Power Sensor	MA2411B	0738404	Apr. 24, 2017	Apr. 23, 2018
Anritsu Power Meter	ML2495A	0842014	Apr. 24, 2017	Apr. 23, 2018

- NOTE:**
1. The calibration interval of the above test instruments is 12/24 months. And the calibrations are traceable to NML/ROC and NIST/USA.
  2. The horn antenna and HP preamplifier (model: 8449B) are used only for the measurement of emission frequency above 1GHz if tested.
  3. The test was performed in Chamber No. 6.
  4. The Industry Canada Reference No. IC 7450E-6.

#### 4.1.3 Test Procedure

##### **For Radiated emission below 30MHz**

- a. The EUT was placed on the top of a rotating table 0.8 meters above the ground at a 3 meter chamber room. The table was rotated 360 degrees to determine the position of the highest radiation.
- b. The EUT was set 3 meters away from the interference-receiving antenna, which was mounted on the top of a variable-height antenna tower.
- c. Both X and Y axes of the antenna are set to make the measurement.
- d. For each suspected emission, the EUT was arranged to its worst case and the rotatable table was turned from 0 degrees to 360 degrees to find the maximum reading.
- e. The test-receiver system was set to Quasi-Peak Detect Function and Specified Bandwidth with Maximum Hold Mode.

##### **NOTE:**

1. The resolution bandwidth and video bandwidth of test receiver/spectrum analyzer is 9kHz at frequency below 30MHz.

##### **For Radiated emission above 30MHz**

- a. The EUT was placed on the top of a rotating table 0.8 meters (for 30MHz ~ 1GHz) / 1.5 meters (for above 1GHz) above the ground at 3 meter chamber room for test. The table was rotated 360 degrees to determine the position of the highest radiation.
- b. The EUT was set 3 meters away from the interference-receiving antenna, which was mounted on the top of a variable-height antenna tower.
- c. The height of antenna is varied from one meter to four meters above the ground to determine the maximum value of the field strength. Both horizontal and vertical polarizations of the antenna are set to make the measurement.
- d. For each suspected emission, the EUT was arranged to its worst case and then the antenna was tuned to heights from 1 meter to 4 meters and the rotatable table was turned from 0 degrees to 360 degrees to find the maximum reading.
- e. The test-receiver system was set to quasi-peak detect function and specified bandwidth with maximum hold mode when the test frequency is below 1 GHz.
- f. The test-receiver system was set to peak and average detect function and specified bandwidth with maximum hold mode when the test frequency is above 1 GHz. If the peak reading value also meets average limit, measurement with the average detector is unnecessary.

##### **Note:**

1. The resolution bandwidth and video bandwidth of test receiver/spectrum analyzer is 120kHz for Quasi-peak detection (QP) at frequency below 1GHz.
2. The resolution bandwidth of test receiver/spectrum analyzer is 1 MHz and the video bandwidth is 3 MHz for Peak detection (PK) at frequency above 1GHz.
3. The resolution bandwidth of test receiver/spectrum analyzer is 1MHz and the video bandwidth is  $\geq 1/T$  (Duty cycle < 98%) or 10Hz (Duty cycle  $\geq 98\%$ ) for Average detection (AV) at frequency above 1GHz.
4. All modes of operation were investigated and the worst-case emissions are reported.

#### 4.1.4 Deviation from Test Standard

No deviation.

#### 4.1.5 Test Setup

##### For Radiated emission below 30MHz

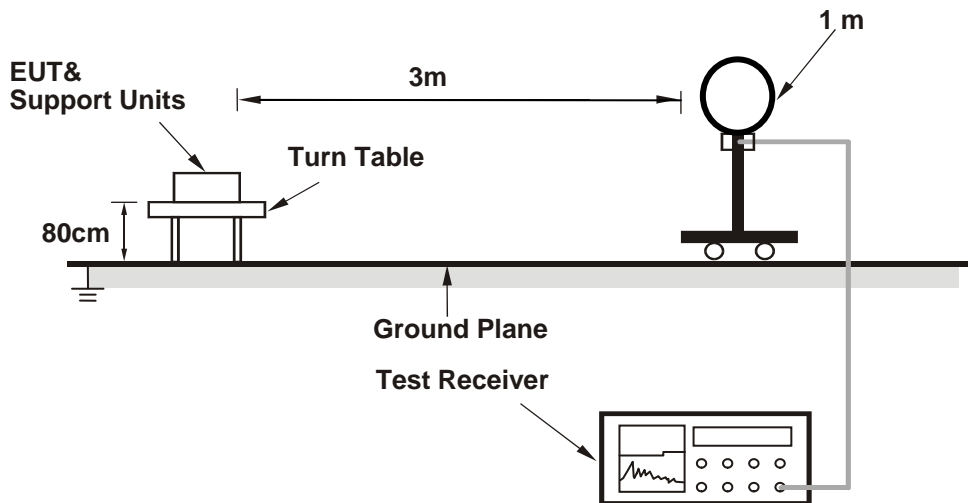

##### For Radiated emission 30MHz to 1GHz

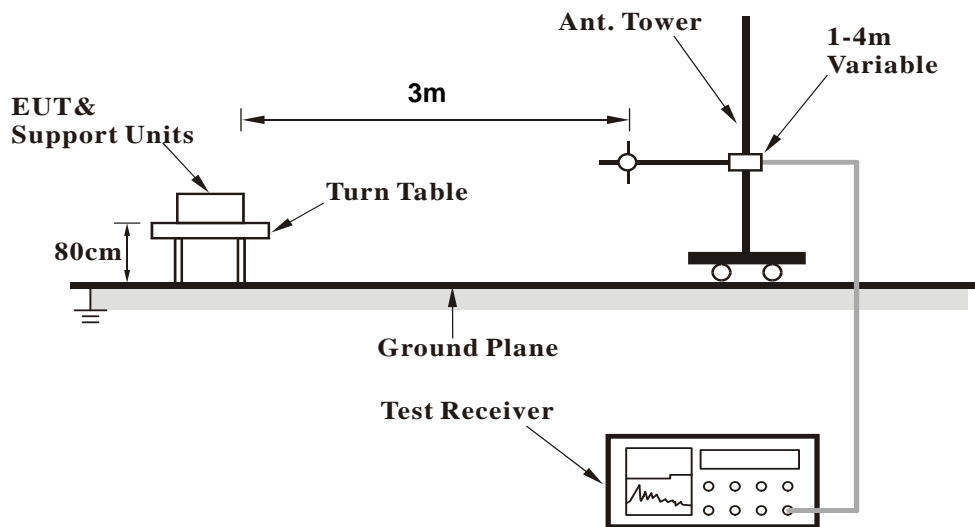

**For Radiated emission above 1GHz**

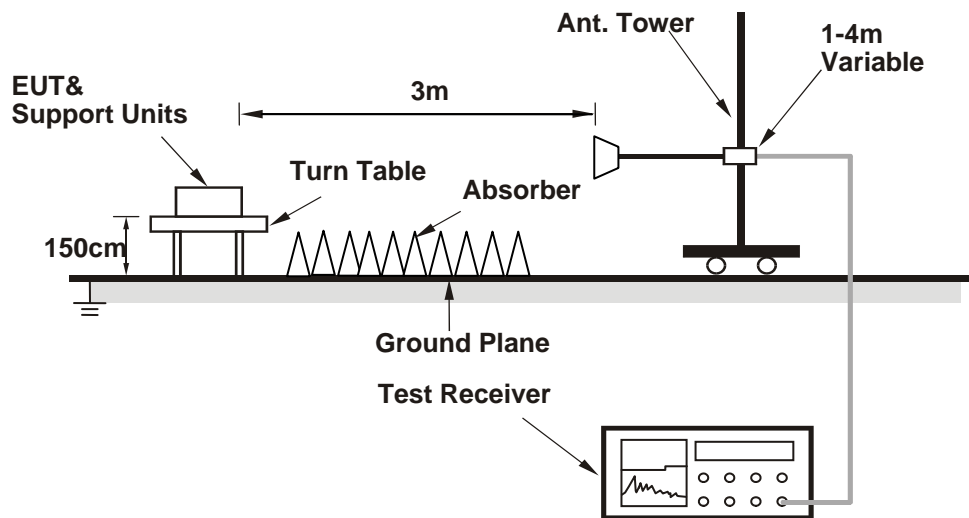

For the actual test configuration, please refer to the attached file (Test Setup Photo).

**4.1.6 EUT Operating Condition**

Set the EUT under transmission condition continuously at specific channel frequency.

#### 4.1.7 Test Results

##### Above 1GHz Data:

##### CDD Mode

##### 802.11a

<b>CHANNEL</b>	TX Channel 36	<b>DETECTOR FUNCTION</b>	Peak (PK)
<b>FREQUENCY RANGE</b>	1GHz ~ 40GHz		Average (AV)

#### ANTENNA POLARITY & TEST DISTANCE: HORIZONTAL AT 3 M

NO.	FREQ. (MHz)	EMISSION LEVEL (dBuV/m)	LIMIT (dBuV/m)	MARGIN (dB)	ANTENNA HEIGHT (m)	TABLE ANGLE (Degree)	RAW VALUE (dBuV)	CORRECTION FACTOR (dB/m)
1	5150.00	71.16 PK	74.00	-2.84	2.34 H	265	63.36	7.80
2	5150.00	52.70 AV	54.00	-1.30	2.34 H	265	44.90	7.80
3	*5180.00	116.94 PK			2.34 H	265	109.01	7.93
4	*5180.00	105.50 AV			2.34 H	265	97.57	7.93
5	#10360.00	58.62 PK	74.00	-15.38	1.78 H	236	40.15	18.47
6	#10360.00	45.21 AV	54.00	-8.79	1.78 H	236	26.74	18.47

#### ANTENNA POLARITY & TEST DISTANCE: VERTICAL AT 3 M

NO.	FREQ. (MHz)	EMISSION LEVEL (dBuV/m)	LIMIT (dBuV/m)	MARGIN (dB)	ANTENNA HEIGHT (m)	TABLE ANGLE (Degree)	RAW VALUE (dBuV)	CORRECTION FACTOR (dB/m)
1	5150.00	66.20 PK	74.00	-7.80	2.15 V	294	58.40	7.80
2	5150.00	49.59 AV	54.00	-4.41	2.15 V	294	41.79	7.80
3	*5180.00	111.68 PK			2.15 V	294	103.75	7.93
4	*5180.00	101.52 AV			2.15 V	294	93.59	7.93
5	#10360.00	58.09 PK	74.00	-15.91	2.32 V	201	39.62	18.47
6	#10360.00	43.78 AV	54.00	-10.22	2.32 V	201	25.31	18.47

#### REMARKS:

1. Emission Level(dBuV/m) = Raw Value(dBuV) + Correction Factor(dB/m)
2. Correction Factor(dB/m) = Antenna Factor(dB/m) + Cable Factor(dB) – Pre-Amplifier Factor(dB)
3. The other emission levels were very low against the limit.
4. Margin value = Emission Level – Limit value
5. " \* ": Fundamental frequency.
6. " # ": The radiated frequency is out of the restricted band.

<b>CHANNEL</b>	TX Channel 40	<b>DETECTOR FUNCTION</b>	Peak (PK)
<b>FREQUENCY RANGE</b>	1GHz ~ 40GHz		Average (AV)

**ANTENNA POLARITY & TEST DISTANCE: HORIZONTAL AT 3 M**

NO.	FREQ. (MHz)	EMISSION LEVEL (dBuV/m)	LIMIT (dBuV/m)	MARGIN (dB)	ANTENNA HEIGHT (m)	TABLE ANGLE (Degree)	RAW VALUE (dBuV)	CORRECTION FACTOR (dB/m)
1	*5200.00	118.97 PK			2.45 H	264	110.95	8.02
2	*5200.00	107.55 AV			2.45 H	264	99.53	8.02
3	#10400.00	59.24 PK	74.00	-14.76	1.69 H	218	40.60	18.64
4	#10400.00	44.96 AV	54.00	-9.04	1.69 H	218	26.32	18.64

**ANTENNA POLARITY & TEST DISTANCE: VERTICAL AT 3 M**

NO.	FREQ. (MHz)	EMISSION LEVEL (dBuV/m)	LIMIT (dBuV/m)	MARGIN (dB)	ANTENNA HEIGHT (m)	TABLE ANGLE (Degree)	RAW VALUE (dBuV)	CORRECTION FACTOR (dB/m)
1	*5200.00	112.27 PK			2.13 V	303	104.25	8.02
2	*5200.00	101.70 AV			2.13 V	303	93.68	8.02
3	#10400.00	58.29 PK	74.00	-15.71	1.64 V	248	39.65	18.64
4	#10400.00	44.28 AV	54.00	-9.72	1.64 V	248	25.64	18.64

**REMARKS:**

1. Emission Level(dBuV/m) = Raw Value(dBuV) + Correction Factor(dB/m)
2. Correction Factor(dB/m) = Antenna Factor(dB/m) + Cable Factor(dB) – Pre-Amplifier Factor(dB)
3. The other emission levels were very low against the limit.
4. Margin value = Emission Level – Limit value
5. " \* ": Fundamental frequency.
6. " # ": The radiated frequency is out of the restricted band.

<b>CHANNEL</b>	TX Channel 48	<b>DETECTOR FUNCTION</b>	Peak (PK)
<b>FREQUENCY RANGE</b>	1GHz ~ 40GHz		Average (AV)

**ANTENNA POLARITY & TEST DISTANCE: HORIZONTAL AT 3 M**

NO.	FREQ. (MHz)	EMISSION LEVEL (dBuV/m)	LIMIT (dBuV/m)	MARGIN (dB)	ANTENNA HEIGHT (m)	TABLE ANGLE (Degree)	RAW VALUE (dBuV)	CORRECTION FACTOR (dB/m)
1	*5240.00	118.70 PK			2.16 H	263	110.55	8.15
2	*5240.00	107.40 AV			2.16 H	263	99.25	8.15
3	5350.00	60.42 PK	74.00	-13.58	2.16 H	263	51.84	8.58
4	5350.00	46.15 AV	54.00	-7.85	2.16 H	263	37.57	8.58
5	#10480.00	59.24 PK	74.00	-14.76	2.15 H	134	40.28	18.96
6	#10480.00	45.60 AV	54.00	-8.40	2.15 H	134	26.64	18.96

**ANTENNA POLARITY & TEST DISTANCE: VERTICAL AT 3 M**

NO.	FREQ. (MHz)	EMISSION LEVEL (dBuV/m)	LIMIT (dBuV/m)	MARGIN (dB)	ANTENNA HEIGHT (m)	TABLE ANGLE (Degree)	RAW VALUE (dBuV)	CORRECTION FACTOR (dB/m)
1	*5240.00	112.66 PK			2.16 V	291	104.51	8.15
2	*5240.00	101.83 AV			2.16 V	291	93.68	8.15
3	5350.00	59.27 PK	74.00	-14.73	2.16 V	291	50.69	8.58
4	5350.00	45.54 AV	54.00	-8.46	2.16 V	291	36.96	8.58
5	#10480.00	58.38 PK	74.00	-15.62	1.66 V	12	39.42	18.96
6	#10480.00	44.65 AV	54.00	-9.35	1.66 V	12	25.69	18.96

**REMARKS:**

1. Emission Level(dBuV/m) = Raw Value(dBuV) + Correction Factor(dB/m)
2. Correction Factor(dB/m) = Antenna Factor(dB/m) + Cable Factor(dB) – Pre-Amplifier Factor(dB)
3. The other emission levels were very low against the limit.
4. Margin value = Emission Level – Limit value
5. " \* ": Fundamental frequency.
6. " # ": The radiated frequency is out of the restricted band.

<b>CHANNEL</b>	TX Channel 149	<b>DETECTOR FUNCTION</b>	Peak (PK)
<b>FREQUENCY RANGE</b>	1GHz ~ 40GHz		Average (AV)

**ANTENNA POLARITY & TEST DISTANCE: HORIZONTAL AT 3 M**

NO.	FREQ. (MHz)	EMISSION LEVEL (dBuV/m)	LIMIT (dBuV/m)	MARGIN (dB)	ANTENNA HEIGHT (m)	TABLE ANGLE (Degree)	RAW VALUE (dBuV)	CORRECTION FACTOR (dB/m)
1	#5576.14	60.28 PK	68.20	-7.92	2.51 H	264	50.94	9.34
2	*5745.00	114.90 PK			2.51 H	264	105.51	9.39
3	*5745.00	104.81 AV			2.51 H	264	95.42	9.39
4	#5959.69	60.15 PK	68.20	-8.05	2.51 H	264	50.27	9.88
5	11490.00	60.24 PK	74.00	-13.76	1.47 H	214	40.15	20.09
6	11490.00	46.93 AV	54.00	-7.07	1.47 H	214	26.84	20.09

**ANTENNA POLARITY & TEST DISTANCE: VERTICAL AT 3 M**

NO.	FREQ. (MHz)	EMISSION LEVEL (dBuV/m)	LIMIT (dBuV/m)	MARGIN (dB)	ANTENNA HEIGHT (m)	TABLE ANGLE (Degree)	RAW VALUE (dBuV)	CORRECTION FACTOR (dB/m)
1	#5593.66	59.64 PK	68.20	-8.56	2.43 V	258	50.30	9.34
2	*5745.00	109.08 PK			2.43 V	258	99.69	9.39
3	*5745.00	98.73 AV			2.43 V	258	89.34	9.39
4	#5932.99	59.52 PK	68.20	-8.68	2.43 V	258	49.74	9.78
5	11490.00	59.74 PK	74.00	-14.26	2.41 V	316	39.65	20.09
6	11490.00	45.17 AV	54.00	-8.83	2.41 V	316	25.08	20.09

**REMARKS:**

1. Emission Level(dBuV/m) = Raw Value(dBuV) + Correction Factor(dB/m)
2. Correction Factor(dB/m) = Antenna Factor(dB/m) + Cable Factor(dB) – Pre-Amplifier Factor(dB)
3. The other emission levels were very low against the limit.
4. Margin value = Emission Level – Limit value
5. " \* ": Fundamental frequency.
6. " # ": The radiated frequency is out of the restricted band.



<b>CHANNEL</b>	TX Channel 157	<b>DETECTOR FUNCTION</b>	Peak (PK)
<b>FREQUENCY RANGE</b>	1GHz ~ 40GHz		Average (AV)

**ANTENNA POLARITY & TEST DISTANCE: HORIZONTAL AT 3 M**

NO.	FREQ. (MHz)	EMISSION LEVEL (dBuV/m)	LIMIT (dBuV/m)	MARGIN (dB)	ANTENNA HEIGHT (m)	TABLE ANGLE (Degree)	RAW VALUE (dBuV)	CORRECTION FACTOR (dB/m)
1	#5623.35	60.26 PK	68.20	-7.94	2.54 H	267	50.91	9.35
2	*5785.00	115.39 PK			2.54 H	267	105.98	9.41
3	*5785.00	104.70 AV			2.54 H	267	95.29	9.41
4	#5943.63	59.75 PK	68.20	-8.45	2.54 H	267	49.94	9.81
5	11570.00	60.77 PK	74.00	-13.23	1.33 H	51	40.48	20.29
6	11570.00	46.63 AV	54.00	-7.37	1.33 H	51	26.34	20.29

**ANTENNA POLARITY & TEST DISTANCE: VERTICAL AT 3 M**

NO.	FREQ. (MHz)	EMISSION LEVEL (dBuV/m)	LIMIT (dBuV/m)	MARGIN (dB)	ANTENNA HEIGHT (m)	TABLE ANGLE (Degree)	RAW VALUE (dBuV)	CORRECTION FACTOR (dB/m)
1	#5602.23	59.35 PK	68.20	-8.85	2.16 V	306	50.01	9.34
2	*5785.00	110.05 PK			2.16 V	306	100.64	9.41
3	*5785.00	99.99 AV			2.16 V	306	90.58	9.41
4	#5989.34	60.47 PK	68.20	-7.73	2.16 V	306	50.48	9.99
5	11570.00	60.13 PK	74.00	-13.87	1.69 V	278	39.84	20.29
6	11570.00	45.90 AV	54.00	-8.10	1.69 V	278	25.61	20.29

**REMARKS:**

1. Emission Level(dBuV/m) = Raw Value(dBuV) + Correction Factor(dB/m)
2. Correction Factor(dB/m) = Antenna Factor(dB/m) + Cable Factor(dB) – Pre-Amplifier Factor(dB)
3. The other emission levels were very low against the limit.
4. Margin value = Emission Level – Limit value
5. " \* ": Fundamental frequency.
6. " # ": The radiated frequency is out of the restricted band.

<b>CHANNEL</b>	TX Channel 165	<b>DETECTOR FUNCTION</b>	Peak (PK)
<b>FREQUENCY RANGE</b>	1GHz ~ 40GHz		Average (AV)

**ANTENNA POLARITY & TEST DISTANCE: HORIZONTAL AT 3 M**

NO.	FREQ. (MHz)	EMISSION LEVEL (dBuV/m)	LIMIT (dBuV/m)	MARGIN (dB)	ANTENNA HEIGHT (m)	TABLE ANGLE (Degree)	RAW VALUE (dBuV)	CORRECTION FACTOR (dB/m)
1	#5603.77	59.50 PK	68.20	-8.70	2.42 H	267	50.15	9.35
2	*5825.00	115.37 PK			2.42 H	267	105.90	9.47
3	*5825.00	105.14 AV			2.42 H	267	95.67	9.47
4	#5947.12	59.80 PK	68.20	-8.40	2.42 H	267	49.96	9.84
5	11650.00	60.45 PK	74.00	-13.55	1.23 H	200	40.13	20.32
6	11650.00	46.63 AV	54.00	-7.37	1.23 H	200	26.31	20.32

**ANTENNA POLARITY & TEST DISTANCE: VERTICAL AT 3 M**

NO.	FREQ. (MHz)	EMISSION LEVEL (dBuV/m)	LIMIT (dBuV/m)	MARGIN (dB)	ANTENNA HEIGHT (m)	TABLE ANGLE (Degree)	RAW VALUE (dBuV)	CORRECTION FACTOR (dB/m)
1	#5641.15	60.19 PK	68.20	-8.01	2.12 V	299	50.83	9.36
2	*5825.00	110.16 PK			2.12 V	299	100.69	9.47
3	*5825.00	100.36 AV			2.12 V	299	90.89	9.47
4	#5988.35	59.48 PK	68.20	-8.72	2.12 V	299	49.49	9.99
5	11650.00	60.01 PK	74.00	-13.99	1.82 V	199	39.69	20.32
6	11650.00	45.62 AV	54.00	-8.38	1.82 V	199	25.30	20.32

**REMARKS:**

1. Emission Level(dBuV/m) = Raw Value(dBuV) + Correction Factor(dB/m)
2. Correction Factor(dB/m) = Antenna Factor(dB/m) + Cable Factor(dB) – Pre-Amplifier Factor(dB)
3. The other emission levels were very low against the limit.
4. Margin value = Emission Level – Limit value
5. " \* ": Fundamental frequency.
6. " # ": The radiated frequency is out of the restricted band.

**802.11ac (20MHz)**

<b>CHANNEL</b>	TX Channel 36	<b>DETECTOR FUNCTION</b>	Peak (PK)
<b>FREQUENCY RANGE</b>	1GHz ~ 40GHz		Average (AV)

**ANTENNA POLARITY & TEST DISTANCE: HORIZONTAL AT 3 M**

NO.	FREQ. (MHz)	EMISSION LEVEL (dBuV/m)	LIMIT (dBuV/m)	MARGIN (dB)	ANTENNA HEIGHT (m)	TABLE ANGLE (Degree)	RAW VALUE (dBuV)	CORRECTION FACTOR (dB/m)
1	5150.00	71.81 PK	74.00	-2.19	2.35 H	264	64.01	7.80
2	5150.00	52.84 AV	54.00	-1.16	2.35 H	264	45.04	7.80
3	*5180.00	118.37 PK			2.35 H	264	110.44	7.93
4	*5180.00	105.71 AV			2.35 H	264	97.78	7.93
5	#10360.00	58.79 PK	74.00	-15.21	1.84 H	145	40.32	18.47
6	#10360.00	45.31 AV	54.00	-8.69	1.84 H	145	26.84	18.47

**ANTENNA POLARITY & TEST DISTANCE: VERTICAL AT 3 M**

NO.	FREQ. (MHz)	EMISSION LEVEL (dBuV/m)	LIMIT (dBuV/m)	MARGIN (dB)	ANTENNA HEIGHT (m)	TABLE ANGLE (Degree)	RAW VALUE (dBuV)	CORRECTION FACTOR (dB/m)
1	5150.00	69.72 PK	74.00	-4.28	1.94 V	174	61.92	7.80
2	5150.00	52.47 AV	54.00	-1.53	1.94 V	174	44.67	7.80
3	*5180.00	113.22 PK			1.94 V	274	105.29	7.93
4	*5180.00	101.13 AV			1.94 V	274	93.20	7.93
5	#10360.00	57.87 PK	74.00	-16.13	2.95 V	251	39.40	18.47
6	#10360.00	44.16 AV	54.00	-9.84	2.95 V	251	25.69	18.47

**REMARKS:**

1. Emission Level(dBuV/m) = Raw Value(dBuV) + Correction Factor(dB/m)
2. Correction Factor(dB/m) = Antenna Factor(dB/m) + Cable Factor(dB) – Pre-Amplifier Factor(dB)
3. The other emission levels were very low against the limit.
4. Margin value = Emission Level – Limit value
5. " \* ": Fundamental frequency.
6. " # ": The radiated frequency is out of the restricted band.

<b>CHANNEL</b>	TX Channel 40	<b>DETECTOR FUNCTION</b>	Peak (PK)
<b>FREQUENCY RANGE</b>	1GHz ~ 40GHz		Average (AV)

**ANTENNA POLARITY & TEST DISTANCE: HORIZONTAL AT 3 M**

NO.	FREQ. (MHz)	EMISSION LEVEL (dBuV/m)	LIMIT (dBuV/m)	MARGIN (dB)	ANTENNA HEIGHT (m)	TABLE ANGLE (Degree)	RAW VALUE (dBuV)	CORRECTION FACTOR (dB/m)
1	*5200.00	117.35 PK			1.92 H	249	109.33	8.02
2	*5200.00	104.55 AV			1.92 H	249	96.53	8.02
3	#10400.00	59.29 PK	74.00	-14.71	1.76 H	145	40.65	18.64
4	#10400.00	45.06 AV	54.00	-8.94	1.76 H	145	26.42	18.64

**ANTENNA POLARITY & TEST DISTANCE: VERTICAL AT 3 M**

NO.	FREQ. (MHz)	EMISSION LEVEL (dBuV/m)	LIMIT (dBuV/m)	MARGIN (dB)	ANTENNA HEIGHT (m)	TABLE ANGLE (Degree)	RAW VALUE (dBuV)	CORRECTION FACTOR (dB/m)
1	*5200.00	113.16 PK			1.89 V	187	105.14	8.02
2	*5200.00	101.36 AV			1.89 V	187	93.34	8.02
3	#10400.00	58.07 PK	74.00	-15.93	2.33 V	167	39.43	18.64
4	#10400.00	44.45 AV	54.00	-9.55	2.33 V	167	25.81	18.64

**REMARKS:**

1. Emission Level(dBuV/m) = Raw Value(dBuV) + Correction Factor(dB/m)
2. Correction Factor(dB/m) = Antenna Factor(dB/m) + Cable Factor(dB) – Pre-Amplifier Factor(dB)
3. The other emission levels were very low against the limit.
4. Margin value = Emission Level – Limit value
5. " \* ": Fundamental frequency.
6. " # ": The radiated frequency is out of the restricted band.

<b>CHANNEL</b>	TX Channel 48	<b>DETECTOR FUNCTION</b>	Peak (PK)
<b>FREQUENCY RANGE</b>	1GHz ~ 40GHz		Average (AV)

**ANTENNA POLARITY & TEST DISTANCE: HORIZONTAL AT 3 M**

NO.	FREQ. (MHz)	EMISSION LEVEL (dBuV/m)	LIMIT (dBuV/m)	MARGIN (dB)	ANTENNA HEIGHT (m)	TABLE ANGLE (Degree)	RAW VALUE (dBuV)	CORRECTION FACTOR (dB/m)
1	*5240.00	118.36 PK			2.52 H	263	110.21	8.15
2	*5240.00	105.49 AV			2.52 H	263	97.34	8.15
3	5350.00	60.43 PK	74.00	-13.57	2.52 H	263	51.85	8.58
4	5350.00	45.89 AV	54.00	-8.11	2.52 H	263	37.31	8.58
5	#10480.00	59.23 PK	74.00	-14.77	1.23 H	46	40.27	18.96
6	#10480.00	45.30 AV	54.00	-8.70	1.23 H	46	26.34	18.96

**ANTENNA POLARITY & TEST DISTANCE: VERTICAL AT 3 M**

NO.	FREQ. (MHz)	EMISSION LEVEL (dBuV/m)	LIMIT (dBuV/m)	MARGIN (dB)	ANTENNA HEIGHT (m)	TABLE ANGLE (Degree)	RAW VALUE (dBuV)	CORRECTION FACTOR (dB/m)
1	*5240.00	114.47 PK			1.97 V	189	106.32	8.15
2	*5240.00	101.36 AV			1.97 V	189	93.21	8.15
3	5350.00	59.04 PK	74.00	-14.96	1.97 V	189	50.46	8.58
4	5350.00	45.28 AV	54.00	-8.72	1.97 V	189	36.70	8.58
5	#10480.00	58.60 PK	74.00	-15.40	2.19 V	54	39.64	18.96
6	#10480.00	44.35 AV	54.00	-9.65	2.19 V	54	25.39	18.96

**REMARKS:**

1. Emission Level(dBuV/m) = Raw Value(dBuV) + Correction Factor(dB/m)
2. Correction Factor(dB/m) = Antenna Factor(dB/m) + Cable Factor(dB) – Pre-Amplifier Factor(dB)
3. The other emission levels were very low against the limit.
4. Margin value = Emission Level – Limit value
5. " \* ": Fundamental frequency.
6. " # ": The radiated frequency is out of the restricted band.

<b>CHANNEL</b>	TX Channel 149	<b>DETECTOR FUNCTION</b>	Peak (PK)
<b>FREQUENCY RANGE</b>	1GHz ~ 40GHz		Average (AV)

**ANTENNA POLARITY & TEST DISTANCE: HORIZONTAL AT 3 M**

NO.	FREQ. (MHz)	EMISSION LEVEL (dBuV/m)	LIMIT (dBuV/m)	MARGIN (dB)	ANTENNA HEIGHT (m)	TABLE ANGLE (Degree)	RAW VALUE (dBuV)	CORRECTION FACTOR (dB/m)
1	#5598.47	60.58 PK	68.20	-7.62	2.44 H	261	51.24	9.34
2	*5745.00	116.34 PK			2.44 H	261	106.95	9.39
3	*5745.00	103.90 AV			2.44 H	261	94.51	9.39
4	#5961.09	60.27 PK	68.20	-7.93	2.44 H	261	50.38	9.89
5	11490.00	60.60 PK	74.00	-13.40	1.47 H	185	40.51	20.09
6	11490.00	46.37 AV	54.00	-7.63	1.47 H	185	26.28	20.09

**ANTENNA POLARITY & TEST DISTANCE: VERTICAL AT 3 M**

NO.	FREQ. (MHz)	EMISSION LEVEL (dBuV/m)	LIMIT (dBuV/m)	MARGIN (dB)	ANTENNA HEIGHT (m)	TABLE ANGLE (Degree)	RAW VALUE (dBuV)	CORRECTION FACTOR (dB/m)
1	#5595.73	59.93 PK	68.20	-8.27	1.93 V	179	50.59	9.34
2	*5745.00	111.70 PK			1.93 V	193	102.31	9.39
3	*5745.00	99.02 AV			1.93 V	193	89.63	9.39
4	#5930.39	59.41 PK	68.20	-8.79	1.93 V	179	49.64	9.77
5	11490.00	59.41 PK	74.00	-14.59	1.30 V	184	39.32	20.09
6	11490.00	45.18 AV	54.00	-8.82	1.30 V	184	25.09	20.09

**REMARKS:**

1. Emission Level(dBuV/m) = Raw Value(dBuV) + Correction Factor(dB/m)
2. Correction Factor(dB/m) = Antenna Factor(dB/m) + Cable Factor(dB) – Pre-Amplifier Factor(dB)
3. The other emission levels were very low against the limit.
4. Margin value = Emission Level – Limit value
5. " \* ": Fundamental frequency.
6. " # ": The radiated frequency is out of the restricted band.

<b>CHANNEL</b>	TX Channel 157	<b>DETECTOR FUNCTION</b>	Peak (PK)
<b>FREQUENCY RANGE</b>	1GHz ~ 40GHz		Average (AV)

**ANTENNA POLARITY & TEST DISTANCE: HORIZONTAL AT 3 M**

NO.	FREQ. (MHz)	EMISSION LEVEL (dBuV/m)	LIMIT (dBuV/m)	MARGIN (dB)	ANTENNA HEIGHT (m)	TABLE ANGLE (Degree)	RAW VALUE (dBuV)	CORRECTION FACTOR (dB/m)
1	#5628.85	60.02 PK	68.20	-8.18	2.44 H	264	50.67	9.35
2	*5785.00	115.30 PK			2.44 H	264	105.89	9.41
3	*5785.00	103.72 AV			2.44 H	264	94.31	9.41
4	#5979.07	59.88 PK	68.20	-8.32	2.44 H	264	49.93	9.95
5	11570.00	60.29 PK	74.00	-13.71	1.23 H	232	40.00	20.29
6	11570.00	46.30 AV	54.00	-7.70	1.23 H	232	26.01	20.29

**ANTENNA POLARITY & TEST DISTANCE: VERTICAL AT 3 M**

NO.	FREQ. (MHz)	EMISSION LEVEL (dBuV/m)	LIMIT (dBuV/m)	MARGIN (dB)	ANTENNA HEIGHT (m)	TABLE ANGLE (Degree)	RAW VALUE (dBuV)	CORRECTION FACTOR (dB/m)
1	#5619.98	60.23 PK	68.20	-7.97	1.93 V	175	50.88	9.35
2	*5785.00	109.73 PK			1.93 V	175	100.32	9.41
3	*5785.00	98.77 AV			1.93 V	175	89.36	9.41
4	#5978.53	59.15 PK	68.20	-9.05	1.93 V	175	49.20	9.95
5	11570.00	59.55 PK	74.00	-14.45	2.06 V	104	39.26	20.29
6	11570.00	45.93 AV	54.00	-8.07	2.06 V	104	25.64	20.29

**REMARKS:**

1. Emission Level(dBuV/m) = Raw Value(dBuV) + Correction Factor(dB/m)
2. Correction Factor(dB/m) = Antenna Factor(dB/m) + Cable Factor(dB) – Pre-Amplifier Factor(dB)
3. The other emission levels were very low against the limit.
4. Margin value = Emission Level – Limit value
5. " \* ": Fundamental frequency.
6. " # ": The radiated frequency is out of the restricted band.

<b>CHANNEL</b>	TX Channel 165	<b>DETECTOR FUNCTION</b>	Peak (PK)
<b>FREQUENCY RANGE</b>	1GHz ~ 40GHz		Average (AV)

**ANTENNA POLARITY & TEST DISTANCE: HORIZONTAL AT 3 M**

NO.	FREQ. (MHz)	EMISSION LEVEL (dBuV/m)	LIMIT (dBuV/m)	MARGIN (dB)	ANTENNA HEIGHT (m)	TABLE ANGLE (Degree)	RAW VALUE (dBuV)	CORRECTION FACTOR (dB/m)
1	#5617.71	59.88 PK	68.20	-8.32	2.64 H	264	50.53	9.35
2	*5825.00	115.23 PK			2.64 H	264	105.76	9.47
3	*5825.00	103.74 AV			2.64 H	264	94.27	9.47
4	#6004.12	60.61 PK	68.20	-7.59	2.64 H	264	50.56	10.05
5	11650.00	60.84 PK	74.00	-13.16	1.02 H	298	40.52	20.32
6	11650.00	46.65 AV	54.00	-7.35	1.02 H	298	26.33	20.32

**ANTENNA POLARITY & TEST DISTANCE: VERTICAL AT 3 M**

NO.	FREQ. (MHz)	EMISSION LEVEL (dBuV/m)	LIMIT (dBuV/m)	MARGIN (dB)	ANTENNA HEIGHT (m)	TABLE ANGLE (Degree)	RAW VALUE (dBuV)	CORRECTION FACTOR (dB/m)
1	#5618.83	59.00 PK	68.20	-9.20	1.92 V	180	49.65	9.35
2	*5825.00	109.68 PK			1.92 V	180	100.21	9.47
3	*5825.00	99.36 AV			1.92 V	180	89.89	9.47
4	#5940.94	59.61 PK	68.20	-8.59	1.92 V	180	49.80	9.81
5	11650.00	59.35 PK	74.00	-14.65	1.88 V	281	39.03	20.32
6	11650.00	45.94 AV	54.00	-8.06	1.88 V	281	25.62	20.32

**REMARKS:**

1. Emission Level(dBuV/m) = Raw Value(dBuV) + Correction Factor(dB/m)
2. Correction Factor(dB/m) = Antenna Factor(dB/m) + Cable Factor(dB) – Pre-Amplifier Factor(dB)
3. The other emission levels were very low against the limit.
4. Margin value = Emission Level – Limit value
5. " \* ": Fundamental frequency.
6. " # ": The radiated frequency is out of the restricted band.



802.11ac (40MHz)

<b>CHANNEL</b>	TX Channel 38	<b>DETECTOR FUNCTION</b>	Peak (PK)
<b>FREQUENCY RANGE</b>	1GHz ~ 40GHz		Average (AV)

**ANTENNA POLARITY & TEST DISTANCE: HORIZONTAL AT 3 M**

NO.	FREQ. (MHz)	EMISSION LEVEL (dBuV/m)	LIMIT (dBuV/m)	MARGIN (dB)	ANTENNA HEIGHT (m)	TABLE ANGLE (Degree)	RAW VALUE (dBuV)	CORRECTION FACTOR (dB/m)
1	5150.00	67.75 PK	74.00	-6.25	2.34 H	264	59.95	7.80
2	<b>5150.00</b>	<b>53.03 AV</b>	<b>54.00</b>	<b>-0.97</b>	<b>2.34 H</b>	<b>264</b>	<b>45.23</b>	<b>7.80</b>
3	*5190.00	109.86 PK			2.34 H	264	101.89	7.97
4	*5190.00	100.46 AV			2.34 H	264	92.49	7.97
5	#10380.00	58.91 PK	74.00	-15.09	1.87 H	241	40.35	18.56
6	#10380.00	45.54 AV	54.00	-8.46	1.87 H	241	26.98	18.56

**ANTENNA POLARITY & TEST DISTANCE: VERTICAL AT 3 M**

NO.	FREQ. (MHz)	EMISSION LEVEL (dBuV/m)	LIMIT (dBuV/m)	MARGIN (dB)	ANTENNA HEIGHT (m)	TABLE ANGLE (Degree)	RAW VALUE (dBuV)	CORRECTION FACTOR (dB/m)
1	5150.00	65.04 PK	74.00	-8.96	1.48 V	297	57.24	7.80
2	5150.00	50.12 AV	54.00	-3.88	1.48 V	297	42.32	7.80
3	*5190.00	104.70 PK			1.48 V	297	96.73	7.97
4	*5190.00	95.22 AV			1.48 V	297	87.25	7.97
5	#10380.00	57.80 PK	74.00	-16.20	2.28 V	74	39.24	18.56
6	#10380.00	43.64 AV	54.00	-10.36	2.28 V	74	25.08	18.56

**REMARKS:**

1. Emission Level(dBuV/m) = Raw Value(dBuV) + Correction Factor(dB/m)
2. Correction Factor(dB/m) = Antenna Factor(dB/m) + Cable Factor(dB) – Pre-Amplifier Factor(dB)
3. The other emission levels were very low against the limit.
4. Margin value = Emission Level – Limit value
5. " \* ": Fundamental frequency.
6. " # ": The radiated frequency is out of the restricted band.

<b>CHANNEL</b>	TX Channel 46	<b>DETECTOR FUNCTION</b>	Peak (PK)
<b>FREQUENCY RANGE</b>	1GHz ~ 40GHz		Average (AV)

**ANTENNA POLARITY & TEST DISTANCE: HORIZONTAL AT 3 M**

NO.	FREQ. (MHz)	EMISSION LEVEL (dBuV/m)	LIMIT (dBuV/m)	MARGIN (dB)	ANTENNA HEIGHT (m)	TABLE ANGLE (Degree)	RAW VALUE (dBuV)	CORRECTION FACTOR (dB/m)
1	*5230.00	113.53 PK			2.31 H	266	105.41	8.12
2	*5230.00	103.51 AV			2.31 H	266	95.39	8.12
3	5350.00	59.88 PK	74.00	-14.12	2.31 H	266	51.30	8.58
4	5350.00	46.07 AV	54.00	-7.93	2.31 H	266	37.49	8.58
5	#10460.00	59.55 PK	74.00	-14.45	2.51 H	64	40.68	18.87
6	#10460.00	18.87 AV	54.00	-35.13	2.51 H	64	0.00	18.87

**ANTENNA POLARITY & TEST DISTANCE: VERTICAL AT 3 M**

NO.	FREQ. (MHz)	EMISSION LEVEL (dBuV/m)	LIMIT (dBuV/m)	MARGIN (dB)	ANTENNA HEIGHT (m)	TABLE ANGLE (Degree)	RAW VALUE (dBuV)	CORRECTION FACTOR (dB/m)
1	*5230.00	108.46 PK			1.52 V	300	100.34	8.12
2	*5230.00	98.70 AV			1.52 V	300	90.58	8.12
3	5350.00	58.72 PK	74.00	-15.28	1.52 V	300	50.14	8.58
4	5350.00	44.92 AV	54.00	-9.08	1.52 V	300	36.34	8.58
5	#10460.00	58.21 PK	74.00	-15.79	1.18 V	236	39.34	18.87
6	#10460.00	43.96 AV	54.00	-10.04	1.18 V	236	25.09	18.87

**REMARKS:**

1. Emission Level(dBuV/m) = Raw Value(dBuV) + Correction Factor(dB/m)
2. Correction Factor(dB/m) = Antenna Factor(dB/m) + Cable Factor(dB) – Pre-Amplifier Factor(dB)
3. The other emission levels were very low against the limit.
4. Margin value = Emission Level – Limit value
5. " \* ": Fundamental frequency.
6. " # ": The radiated frequency is out of the restricted band.

<b>CHANNEL</b>	TX Channel 151	<b>DETECTOR FUNCTION</b>	Peak (PK)
<b>FREQUENCY RANGE</b>	1GHz ~ 40GHz		Average (AV)

**ANTENNA POLARITY & TEST DISTANCE: HORIZONTAL AT 3 M**

NO.	FREQ. (MHz)	EMISSION LEVEL (dBuV/m)	LIMIT (dBuV/m)	MARGIN (dB)	ANTENNA HEIGHT (m)	TABLE ANGLE (Degree)	RAW VALUE (dBuV)	CORRECTION FACTOR (dB/m)
1	#5585.93	60.82 PK	68.20	-7.38	2.28 H	265	51.49	9.33
2	*5755.00	112.28 PK			2.28 H	265	102.88	9.40
3	*5755.00	102.62 AV			2.28 H	265	93.22	9.40
4	#5954.46	59.66 PK	68.20	-8.54	2.28 H	265	49.81	9.85
5	11510.00	60.73 PK	74.00	-13.27	2.36 H	284	40.62	20.11
6	11510.00	46.50 AV	54.00	-7.50	2.36 H	284	26.39	20.11

**ANTENNA POLARITY & TEST DISTANCE: VERTICAL AT 3 M**

NO.	FREQ. (MHz)	EMISSION LEVEL (dBuV/m)	LIMIT (dBuV/m)	MARGIN (dB)	ANTENNA HEIGHT (m)	TABLE ANGLE (Degree)	RAW VALUE (dBuV)	CORRECTION FACTOR (dB/m)
1	#5640.42	60.55 PK	68.20	-7.65	1.47 V	301	51.19	9.36
2	*5755.00	106.65 PK			1.47 V	301	97.25	9.40
3	*5755.00	98.09 AV			1.47 V	301	88.69	9.40
4	#5956.87	59.24 PK	68.20	-8.96	1.47 V	301	49.36	9.88
5	11510.00	59.45 PK	74.00	-14.55	2.00 V	241	39.34	20.11
6	11510.00	45.39 AV	54.00	-8.61	2.00 V	241	25.28	20.11

**REMARKS:**

1. Emission Level(dBuV/m) = Raw Value(dBuV) + Correction Factor(dB/m)
2. Correction Factor(dB/m) = Antenna Factor(dB/m) + Cable Factor(dB) – Pre-Amplifier Factor(dB)
3. The other emission levels were very low against the limit.
4. Margin value = Emission Level – Limit value
5. " \* ": Fundamental frequency.
6. " # ": The radiated frequency is out of the restricted band.

<b>CHANNEL</b>	TX Channel 159	<b>DETECTOR FUNCTION</b>	Peak (PK)
<b>FREQUENCY RANGE</b>	1GHz ~ 40GHz		Average (AV)

**ANTENNA POLARITY & TEST DISTANCE: HORIZONTAL AT 3 M**

NO.	FREQ. (MHz)	EMISSION LEVEL (dBuV/m)	LIMIT (dBuV/m)	MARGIN (dB)	ANTENNA HEIGHT (m)	TABLE ANGLE (Degree)	RAW VALUE (dBuV)	CORRECTION FACTOR (dB/m)
1	#5614.27	60.25 PK	68.20	-7.95	1.73 H	264	50.90	9.35
2	*5795.00	113.50 PK			1.73 H	264	104.08	9.42
3	*5795.00	103.78 AV			1.73 H	264	94.36	9.42
4	#5966.04	59.49 PK	68.20	-8.71	1.73 H	264	49.59	9.90
5	11590.00	60.85 PK	74.00	-13.15	2.03 H	261	40.51	20.34
6	11590.00	46.59 AV	54.00	-7.41	2.03 H	261	26.25	20.34

**ANTENNA POLARITY & TEST DISTANCE: VERTICAL AT 3 M**

NO.	FREQ. (MHz)	EMISSION LEVEL (dBuV/m)	LIMIT (dBuV/m)	MARGIN (dB)	ANTENNA HEIGHT (m)	TABLE ANGLE (Degree)	RAW VALUE (dBuV)	CORRECTION FACTOR (dB/m)
1	#5626.58	59.20 PK	68.20	-9.00	1.59 V	310	49.85	9.35
2	*5795.00	109.07 PK			1.59 V	310	99.65	9.42
3	*5795.00	99.08 AV			1.59 V	310	89.66	9.42
4	#5997.39	59.23 PK	68.20	-8.97	1.59 V	310	49.21	10.02
5	11590.00	60.16 PK	74.00	-13.84	1.63 V	251	39.82	20.34
6	11590.00	45.95 AV	54.00	-8.05	1.63 V	251	25.61	20.34

**REMARKS:**

1. Emission Level(dBuV/m) = Raw Value(dBuV) + Correction Factor(dB/m)
2. Correction Factor(dB/m) = Antenna Factor(dB/m) + Cable Factor(dB) – Pre-Amplifier Factor(dB)
3. The other emission levels were very low against the limit.
4. Margin value = Emission Level – Limit value
5. " \* ": Fundamental frequency.
6. " # ": The radiated frequency is out of the restricted band.

802.11ac (80MHz)

<b>CHANNEL</b>	TX Channel 42	<b>DETECTOR FUNCTION</b>	Peak (PK)
<b>FREQUENCY RANGE</b>	1GHz ~ 40GHz		Average (AV)

**ANTENNA POLARITY & TEST DISTANCE: HORIZONTAL AT 3 M**

NO.	FREQ. (MHz)	EMISSION LEVEL (dBuV/m)	LIMIT (dBuV/m)	MARGIN (dB)	ANTENNA HEIGHT (m)	TABLE ANGLE (Degree)	RAW VALUE (dBuV)	CORRECTION FACTOR (dB/m)
1	5150.00	67.73 PK	74.00	-6.27	2.34 H	263	59.93	7.80
2	5150.00	52.88 AV	54.00	-1.12	2.34 H	263	45.08	7.80
3	*5210.00	106.42 PK			2.34 H	263	98.37	8.05
4	*5210.00	96.11 AV			2.34 H	263	88.06	8.05
5	5350.00	60.65 PK	74.00	-13.35	2.34 H	263	52.07	8.58
6	5350.00	46.57 AV	54.00	-7.43	2.34 H	263	37.99	8.58
7	#10420.00	58.91 PK	74.00	-15.09	1.82 H	216	40.19	18.72
8	#10420.00	44.81 AV	54.00	-9.19	1.82 H	216	26.09	18.72

**ANTENNA POLARITY & TEST DISTANCE: VERTICAL AT 3 M**

NO.	FREQ. (MHz)	EMISSION LEVEL (dBuV/m)	LIMIT (dBuV/m)	MARGIN (dB)	ANTENNA HEIGHT (m)	TABLE ANGLE (Degree)	RAW VALUE (dBuV)	CORRECTION FACTOR (dB/m)
1	5150.00	64.52 PK	74.00	-9.48	1.49 V	298	56.72	7.80
2	5150.00	51.12 AV	54.00	-2.88	1.49 V	298	43.32	7.80
3	*5210.00	100.79 PK			1.49 V	298	92.74	8.05
4	*5210.00	90.38 AV			1.49 V	298	82.33	8.05
5	5350.00	60.02 PK	74.00	-13.98	1.49 V	298	51.44	8.58
6	5350.00	46.02 AV	54.00	-7.98	1.49 V	298	37.44	8.58
7	#10420.00	58.36 PK	74.00	-15.64	1.91 V	182	39.64	18.72
8	#10420.00	44.06 AV	54.00	-9.94	1.91 V	182	25.34	18.72

**REMARKS:**

1. Emission Level(dBuV/m) = Raw Value(dBuV) + Correction Factor(dB/m)
2. Correction Factor(dB/m) = Antenna Factor(dB/m) + Cable Factor(dB) – Pre-Amplifier Factor(dB)
3. The other emission levels were very low against the limit.
4. Margin value = Emission Level – Limit value
5. " \* ": Fundamental frequency.
6. " # ": The radiated frequency is out of the restricted band.

<b>CHANNEL</b>	TX Channel 155	<b>DETECTOR FUNCTION</b>	Peak (PK)
<b>FREQUENCY RANGE</b>	1GHz ~ 40GHz		Average (AV)

**ANTENNA POLARITY & TEST DISTANCE: HORIZONTAL AT 3 M**

NO.	FREQ. (MHz)	EMISSION LEVEL (dBuV/m)	LIMIT (dBuV/m)	MARGIN (dB)	ANTENNA HEIGHT (m)	TABLE ANGLE (Degree)	RAW VALUE (dBuV)	CORRECTION FACTOR (dB/m)
1	#5629.74	67.08 PK	68.20	-1.12	1.77 H	265	57.73	9.35
2	*5775.00	107.68 PK			1.77 H	265	98.27	9.41
3	*5775.00	97.62 AV			1.77 H	265	88.21	9.41
4	#5932.90	63.19 PK	68.20	-5.01	1.77 H	265	53.41	9.78
5	11550.00	60.55 PK	74.00	-13.45	2.05 H	122	40.33	20.22
6	11550.00	46.77 AV	54.00	-7.23	2.05 H	122	26.55	20.22

**ANTENNA POLARITY & TEST DISTANCE: VERTICAL AT 3 M**

NO.	FREQ. (MHz)	EMISSION LEVEL (dBuV/m)	LIMIT (dBuV/m)	MARGIN (dB)	ANTENNA HEIGHT (m)	TABLE ANGLE (Degree)	RAW VALUE (dBuV)	CORRECTION FACTOR (dB/m)
1	#5642.09	63.09 PK	68.20	-5.11	1.55 V	306	53.74	9.35
2	*5775.00	103.06 PK			1.55 V	306	93.65	9.41
3	*5775.00	92.97 AV			1.55 V	306	83.56	9.41
4	#5991.68	61.78 PK	68.20	-6.42	1.55 V	306	51.79	9.99
5	11550.00	60.06 PK	74.00	-13.94	2.28 V	169	39.84	20.22
6	11550.00	45.31 AV	54.00	-8.69	2.28 V	169	25.09	20.22

**REMARKS:**

1. Emission Level(dBuV/m) = Raw Value(dBuV) + Correction Factor(dB/m)
2. Correction Factor(dB/m) = Antenna Factor(dB/m) + Cable Factor(dB) – Pre-Amplifier Factor(dB)
3. The other emission levels were very low against the limit.
4. Margin value = Emission Level – Limit value
5. " \* ": Fundamental frequency.
6. " # ": The radiated frequency is out of the restricted band.

**Beamforming\_NSS1 Mode**

**802.11ac (20MHz)**

<b>CHANNEL</b>	TX Channel 36	<b>DETECTOR FUNCTION</b>	Peak (PK)
<b>FREQUENCY RANGE</b>	1GHz ~ 40GHz		Average (AV)

**ANTENNA POLARITY & TEST DISTANCE: HORIZONTAL AT 3 M**

NO.	FREQ. (MHz)	EMISSION LEVEL (dBuV/m)	LIMIT (dBuV/m)	MARGIN (dB)	ANTENNA HEIGHT (m)	TABLE ANGLE (Degree)	RAW VALUE (dBuV)	CORRECTION FACTOR (dB/m)
1	5150.00	65.95 PK	74.00	-8.05	1.87 H	337	60.01	5.94
2	5150.00	47.18 AV	54.00	-6.82	1.87 H	337	41.24	5.94
3	*5180.00	116.38 PK			1.87 H	337	110.35	6.03
4	*5180.00	103.33 AV			1.87 H	337	97.30	6.03
5	11360.00	57.76 PK	74.00	-16.24	1.84 H	245	40.58	17.18
6	11360.00	43.52 AV	54.00	-10.48	1.84 H	245	26.34	17.18

**ANTENNA POLARITY & TEST DISTANCE: VERTICAL AT 3 M**

NO.	FREQ. (MHz)	EMISSION LEVEL (dBuV/m)	LIMIT (dBuV/m)	MARGIN (dB)	ANTENNA HEIGHT (m)	TABLE ANGLE (Degree)	RAW VALUE (dBuV)	CORRECTION FACTOR (dB/m)
1	5150.00	63.36 PK	74.00	-10.64	2.06 V	352	57.42	5.94
2	5150.00	46.10 AV	54.00	-7.90	2.06 V	352	40.16	5.94
3	*5180.00	113.49 PK			2.06 V	352	107.46	6.03
4	*5180.00	100.61 AV			2.06 V	352	94.58	6.03
5	11360.00	56.86 PK	74.00	-17.14	1.87 V	226	39.68	17.18
6	11360.00	42.26 AV	54.00	-11.74	1.87 V	226	25.08	17.18

**REMARKS:**

1. Emission Level(dBuV/m) = Raw Value(dBuV) + Correction Factor(dB/m)
2. Correction Factor(dB/m) = Antenna Factor(dB/m) + Cable Factor(dB) – Pre-Amplifier Factor(dB)
3. The other emission levels were very low against the limit.
4. Margin value = Emission Level – Limit value
5. " \* ": Fundamental frequency.

<b>CHANNEL</b>	TX Channel 40	<b>DETECTOR FUNCTION</b>	Peak (PK)
<b>FREQUENCY RANGE</b>	1GHz ~ 40GHz		Average (AV)

**ANTENNA POLARITY & TEST DISTANCE: HORIZONTAL AT 3 M**

NO.	FREQ. (MHz)	EMISSION LEVEL (dBuV/m)	LIMIT (dBuV/m)	MARGIN (dB)	ANTENNA HEIGHT (m)	TABLE ANGLE (Degree)	RAW VALUE (dBuV)	CORRECTION FACTOR (dB/m)
1	*5200.00	117.71 PK			1.83 H	337	111.60	6.11
2	*5200.00	104.66 AV			1.83 H	337	98.55	6.11
3	#10400.00	57.00 PK	74.00	-17.00	1.63 H	228	40.74	16.26
4	#10400.00	42.78 AV	54.00	-11.22	1.63 H	228	26.52	16.26

**ANTENNA POLARITY & TEST DISTANCE: VERTICAL AT 3 M**

NO.	FREQ. (MHz)	EMISSION LEVEL (dBuV/m)	LIMIT (dBuV/m)	MARGIN (dB)	ANTENNA HEIGHT (m)	TABLE ANGLE (Degree)	RAW VALUE (dBuV)	CORRECTION FACTOR (dB/m)
1	*5200.00	115.00 PK			2.13 V	346	108.89	6.11
2	*5200.00	101.80 AV			2.13 V	346	95.69	6.11
3	#10400.00	55.84 PK	74.00	-18.16	1.85 V	293	39.58	16.26
4	#10400.00	42.07 AV	54.00	-11.93	1.85 V	293	25.81	16.26

**REMARKS:**

1. Emission Level(dBuV/m) = Raw Value(dBuV) + Correction Factor(dB/m)
2. Correction Factor(dB/m) = Antenna Factor(dB/m) + Cable Factor(dB) – Pre-Amplifier Factor(dB)
3. The other emission levels were very low against the limit.
4. Margin value = Emission Level – Limit value
5. " \* ": Fundamental frequency.
6. " # ": The radiated frequency is out of the restricted band.



<b>CHANNEL</b>	TX Channel 48	<b>DETECTOR FUNCTION</b>	Peak (PK)
<b>FREQUENCY RANGE</b>	1GHz ~ 40GHz		Average (AV)

**ANTENNA POLARITY & TEST DISTANCE: HORIZONTAL AT 3 M**

NO.	FREQ. (MHz)	EMISSION LEVEL (dBuV/m)	LIMIT (dBuV/m)	MARGIN (dB)	ANTENNA HEIGHT (m)	TABLE ANGLE (Degree)	RAW VALUE (dBuV)	CORRECTION FACTOR (dB/m)
1	*5240.00	119.30 PK			2.25 H	347	113.03	6.27
2	*5240.00	105.52 AV			2.25 H	347	99.25	6.27
3	5350.00	58.49 PK	74.00	-15.51	2.25 H	347	51.74	6.75
4	5350.00	44.44 AV	54.00	-9.56	2.25 H	347	37.69	6.75
5	#10480.00	57.01 PK	74.00	-16.99	2.36 H	124	40.54	16.47
6	#10480.00	42.81 AV	54.00	-11.19	2.36 H	124	26.34	16.47

**ANTENNA POLARITY & TEST DISTANCE: VERTICAL AT 3 M**

NO.	FREQ. (MHz)	EMISSION LEVEL (dBuV/m)	LIMIT (dBuV/m)	MARGIN (dB)	ANTENNA HEIGHT (m)	TABLE ANGLE (Degree)	RAW VALUE (dBuV)	CORRECTION FACTOR (dB/m)
1	*5240.00	116.14 PK			1.84 V	353	109.87	6.27
2	*5240.00	102.65 AV			1.84 V	353	96.38	6.27
3	5350.00	57.52 PK	74.00	-16.48	1.84 V	353	50.77	6.75
4	5350.00	43.36 AV	54.00	-10.64	1.84 V	353	36.61	6.75
5	#10480.00	56.11 PK	74.00	-17.89	1.42 V	228	39.64	16.47
6	#10480.00	41.81 AV	54.00	-12.19	1.42 V	228	25.34	16.47

**REMARKS:**

1. Emission Level(dBuV/m) = Raw Value(dBuV) + Correction Factor(dB/m)
2. Correction Factor(dB/m) = Antenna Factor(dB/m) + Cable Factor(dB) – Pre-Amplifier Factor(dB)
3. The other emission levels were very low against the limit.
4. Margin value = Emission Level – Limit value
5. " \* ": Fundamental frequency.
6. " # ": The radiated frequency is out of the restricted band.

<b>CHANNEL</b>	TX Channel 149	<b>DETECTOR FUNCTION</b>	Peak (PK)
<b>FREQUENCY RANGE</b>	1GHz ~ 40GHz		Average (AV)

**ANTENNA POLARITY & TEST DISTANCE: HORIZONTAL AT 3 M**

NO.	FREQ. (MHz)	EMISSION LEVEL (dBuV/m)	LIMIT (dBuV/m)	MARGIN (dB)	ANTENNA HEIGHT (m)	TABLE ANGLE (Degree)	RAW VALUE (dBuV)	CORRECTION FACTOR (dB/m)
1	#5625.06	62.32 PK	68.20	-5.88	1.97 H	348	54.96	7.36
2	*5745.00	117.97 PK			1.97 H	348	110.58	7.39
3	*5745.00	105.24 AV			1.97 H	348	97.85	7.39
4	#5942.67	61.98 PK	68.20	-6.22	1.97 H	348	54.10	7.88
5	11490.00	58.04 PK	74.00	-15.96	1.25 H	202	40.84	17.20
6	11490.00	43.76 AV	54.00	-10.24	1.25 H	202	26.56	17.20

**ANTENNA POLARITY & TEST DISTANCE: VERTICAL AT 3 M**

NO.	FREQ. (MHz)	EMISSION LEVEL (dBuV/m)	LIMIT (dBuV/m)	MARGIN (dB)	ANTENNA HEIGHT (m)	TABLE ANGLE (Degree)	RAW VALUE (dBuV)	CORRECTION FACTOR (dB/m)
1	#5634.13	62.97 PK	68.20	-5.23	2.16 V	320	55.60	7.37
2	*5745.00	114.24 PK			3.16 V	320	106.85	7.39
3	*5745.00	101.04 AV			3.16 V	320	93.65	7.39
4	#5964.94	62.07 PK	68.20	-6.13	3.16 V	320	54.09	7.98
5	11490.00	56.87 PK	74.00	-17.13	1.57 V	221	39.67	17.20
6	11490.00	42.33 AV	54.00	-11.67	1.57 V	221	25.13	17.20

**REMARKS:**

1. Emission Level(dBuV/m) = Raw Value(dBuV) + Correction Factor(dB/m)
2. Correction Factor(dB/m) = Antenna Factor(dB/m) + Cable Factor(dB) – Pre-Amplifier Factor(dB)
3. The other emission levels were very low against the limit.
4. Margin value = Emission Level – Limit value
5. " \* ": Fundamental frequency.
6. " # ": The radiated frequency is out of the restricted band.

<b>CHANNEL</b>	TX Channel 157	<b>DETECTOR FUNCTION</b>	Peak (PK)
<b>FREQUENCY RANGE</b>	1GHz ~ 40GHz		Average (AV)

**ANTENNA POLARITY & TEST DISTANCE: HORIZONTAL AT 3 M**

NO.	FREQ. (MHz)	EMISSION LEVEL (dBuV/m)	LIMIT (dBuV/m)	MARGIN (dB)	ANTENNA HEIGHT (m)	TABLE ANGLE (Degree)	RAW VALUE (dBuV)	CORRECTION FACTOR (dB/m)
1	#5642.65	62.61 PK	68.20	-5.59	2.05 H	354	55.26	7.35
2	*5785.00	118.27 PK			2.05 H	354	110.84	7.43
3	*5785.00	104.85 AV			2.05 H	354	97.42	7.43
4	#5976.60	63.00 PK	68.20	-5.20	2.05 H	354	54.97	8.03
5	11570.00	58.20 PK	74.00	-15.80	2.25 H	285	40.94	17.26
6	11570.00	44.07 AV	54.00	-9.93	2.25 H	285	26.81	17.26

**ANTENNA POLARITY & TEST DISTANCE: VERTICAL AT 3 M**

NO.	FREQ. (MHz)	EMISSION LEVEL (dBuV/m)	LIMIT (dBuV/m)	MARGIN (dB)	ANTENNA HEIGHT (m)	TABLE ANGLE (Degree)	RAW VALUE (dBuV)	CORRECTION FACTOR (dB/m)
1	#5635.19	61.98 PK	68.20	-6.22	2.26 V	342	54.62	7.36
2	*5785.00	112.68 PK			2.26 V	342	105.25	7.43
3	*5785.00	99.77 AV			2.26 V	342	92.34	7.43
4	#5939.08	62.77 PK	68.20	-5.43	2.26 V	342	54.90	7.87
5	11570.00	57.10 PK	74.00	-16.90	1.88 V	259	39.84	17.26
6	11570.00	42.42 AV	54.00	-11.58	1.88 V	259	25.16	17.26

**REMARKS:**

1. Emission Level(dBuV/m) = Raw Value(dBuV) + Correction Factor(dB/m)
2. Correction Factor(dB/m) = Antenna Factor(dB/m) + Cable Factor(dB) – Pre-Amplifier Factor(dB)
3. The other emission levels were very low against the limit.
4. Margin value = Emission Level – Limit value
5. " \* ": Fundamental frequency.
6. " # ": The radiated frequency is out of the restricted band.

<b>CHANNEL</b>	TX Channel 165	<b>DETECTOR FUNCTION</b>	Peak (PK)
<b>FREQUENCY RANGE</b>	1GHz ~ 40GHz		Average (AV)

**ANTENNA POLARITY & TEST DISTANCE: HORIZONTAL AT 3 M**

NO.	FREQ. (MHz)	EMISSION LEVEL (dBuV/m)	LIMIT (dBuV/m)	MARGIN (dB)	ANTENNA HEIGHT (m)	TABLE ANGLE (Degree)	RAW VALUE (dBuV)	CORRECTION FACTOR (dB/m)
1	#5649.57	62.29 PK	68.20	-5.91	2.03 H	354	54.93	7.36
2	*5825.00	117.65 PK			2.03 H	354	110.14	7.51
3	*5825.00	104.36 AV			2.03 H	354	96.85	7.51
4	#5987.72	62.50 PK	68.20	-5.70	2.03 H	354	54.42	8.08
5	11650.00	57.38 PK	74.00	-16.62	1.75 H	104	40.15	17.23
6	11650.00	43.87 AV	54.00	-10.13	1.75 H	104	26.64	17.23

**ANTENNA POLARITY & TEST DISTANCE: VERTICAL AT 3 M**

NO.	FREQ. (MHz)	EMISSION LEVEL (dBuV/m)	LIMIT (dBuV/m)	MARGIN (dB)	ANTENNA HEIGHT (m)	TABLE ANGLE (Degree)	RAW VALUE (dBuV)	CORRECTION FACTOR (dB/m)
1	#5626.72	61.66 PK	68.20	-6.54	2.23 V	333	54.30	7.36
2	*5825.00	112.85 PK			2.33 V	333	105.34	7.51
3	*5825.00	99.83 AV			2.33 V	333	92.32	7.51
4	#5981.07	62.65 PK	68.20	-5.55	2.23 V	333	54.61	8.04
5	11650.00	56.48 PK	74.00	-17.52	1.28 V	314	39.25	17.23
6	11650.00	42.49 AV	54.00	-11.51	1.28 V	314	25.26	17.23

**REMARKS:**

1. Emission Level(dBuV/m) = Raw Value(dBuV) + Correction Factor(dB/m)
2. Correction Factor(dB/m) = Antenna Factor(dB/m) + Cable Factor(dB) – Pre-Amplifier Factor(dB)
3. The other emission levels were very low against the limit.
4. Margin value = Emission Level – Limit value
5. " \* ": Fundamental frequency.
6. " # ": The radiated frequency is out of the restricted band.

**802.11ac (40MHz)**

<b>CHANNEL</b>	TX Channel 38	<b>DETECTOR FUNCTION</b>	Peak (PK)
<b>FREQUENCY RANGE</b>	1GHz ~ 40GHz		Average (AV)

**ANTENNA POLARITY & TEST DISTANCE: HORIZONTAL AT 3 M**

NO.	FREQ. (MHz)	EMISSION LEVEL (dBuV/m)	LIMIT (dBuV/m)	MARGIN (dB)	ANTENNA HEIGHT (m)	TABLE ANGLE (Degree)	RAW VALUE (dBuV)	CORRECTION FACTOR (dB/m)
1	5150.00	70.94 PK	74.00	-3.06	1.87 H	339	65.00	5.94
2	5150.00	51.08 AV	54.00	-2.92	1.87 H	339	45.14	5.94
3	*5190.00	117.16 PK			1.87 H	339	111.09	6.07
4	*5190.00	102.17 AV			1.87 H	339	96.10	6.07
5	#10380.00	57.04 PK	74.00	-16.96	1.36 H	264	40.85	16.19
6	#10380.00	43.04 AV	54.00	-10.96	1.36 H	264	26.85	16.19

**ANTENNA POLARITY & TEST DISTANCE: VERTICAL AT 3 M**

NO.	FREQ. (MHz)	EMISSION LEVEL (dBuV/m)	LIMIT (dBuV/m)	MARGIN (dB)	ANTENNA HEIGHT (m)	TABLE ANGLE (Degree)	RAW VALUE (dBuV)	CORRECTION FACTOR (dB/m)
1	5150.00	66.15 PK	74.00	-7.85	2.09 V	356	60.21	5.94
2	5150.00	48.26 AV	54.00	-5.74	2.09 V	356	42.32	5.94
3	*5190.00	113.52 PK			2.09 V	356	107.45	6.07
4	*5190.00	98.65 AV			2.09 V	356	92.58	6.07
5	#10380.00	55.79 PK	74.00	-18.21	2.34 V	186	39.60	16.19
6	#10380.00	42.03 AV	54.00	-11.97	2.34 V	186	25.84	16.19

**REMARKS:**

1. Emission Level(dBuV/m) = Raw Value(dBuV) + Correction Factor(dB/m)
2. Correction Factor(dB/m) = Antenna Factor(dB/m) + Cable Factor(dB) – Pre-Amplifier Factor(dB)
3. The other emission levels were very low against the limit.
4. Margin value = Emission Level – Limit value
5. " \* ": Fundamental frequency.
6. " # ": The radiated frequency is out of the restricted band.

<b>CHANNEL</b>	TX Channel 46	<b>DETECTOR FUNCTION</b>	Peak (PK)
<b>FREQUENCY RANGE</b>	1GHz ~ 40GHz		Average (AV)

**ANTENNA POLARITY & TEST DISTANCE: HORIZONTAL AT 3 M**

NO.	FREQ. (MHz)	EMISSION LEVEL (dBuV/m)	LIMIT (dBuV/m)	MARGIN (dB)	ANTENNA HEIGHT (m)	TABLE ANGLE (Degree)	RAW VALUE (dBuV)	CORRECTION FACTOR (dB/m)
1	*5230.00	116.12 PK			1.86 H	334	109.89	6.23
2	*5230.00	101.69 AV			1.86 H	334	95.46	6.23
3	5350.00	58.71 PK	74.00	-15.29	1.86 H	334	51.96	6.75
4	5350.00	44.27 AV	54.00	-9.73	1.86 H	334	37.52	6.75
5	#10460.00	57.25 PK	74.00	-16.75	1.91 H	205	40.84	16.41
6	#10460.00	42.57 AV	54.00	-11.43	1.91 H	205	26.16	16.41

**ANTENNA POLARITY & TEST DISTANCE: VERTICAL AT 3 M**

NO.	FREQ. (MHz)	EMISSION LEVEL (dBuV/m)	LIMIT (dBuV/m)	MARGIN (dB)	ANTENNA HEIGHT (m)	TABLE ANGLE (Degree)	RAW VALUE (dBuV)	CORRECTION FACTOR (dB/m)
1	*5230.00	111.64 PK			2.16 V	331	105.41	6.23
2	*5230.00	97.86 AV			2.16 V	331	91.63	6.23
3	5350.00	56.89 PK	74.00	-17.11	2.16 V	331	50.14	6.75
4	5350.00	43.18 AV	54.00	-10.82	2.16 V	331	36.43	6.75
5	#10360.00	55.24 PK	74.00	-18.76	1.64 V	283	39.14	16.10
6	#10360.00	41.36 AV	54.00	-12.64	1.64 V	283	25.26	16.10

**REMARKS:**

1. Emission Level(dBuV/m) = Raw Value(dBuV) + Correction Factor(dB/m)
2. Correction Factor(dB/m) = Antenna Factor(dB/m) + Cable Factor(dB) – Pre-Amplifier Factor(dB)
3. The other emission levels were very low against the limit.
4. Margin value = Emission Level – Limit value
5. " \* ": Fundamental frequency.
6. " # ": The radiated frequency is out of the restricted band.

<b>CHANNEL</b>	TX Channel 151	<b>DETECTOR FUNCTION</b>	Peak (PK)
<b>FREQUENCY RANGE</b>	1GHz ~ 40GHz		Average (AV)

**ANTENNA POLARITY & TEST DISTANCE: HORIZONTAL AT 3 M**

NO.	FREQ. (MHz)	EMISSION LEVEL (dBuV/m)	LIMIT (dBuV/m)	MARGIN (dB)	ANTENNA HEIGHT (m)	TABLE ANGLE (Degree)	RAW VALUE (dBuV)	CORRECTION FACTOR (dB/m)
1	#5639.19	63.37 PK	68.20	-4.83	1.57 H	351	56.01	7.36
2	*5755.00	117.85 PK			1.57 H	351	110.45	7.40
3	*5755.00	105.25 AV			1.57 H	351	97.85	7.40
4	#5961.86	63.63 PK	68.20	-4.57	1.57 H	351	55.66	7.97
5	11510.00	57.91 PK	74.00	-16.09	1.36 H	64	40.71	17.20
6	11510.00	43.47 AV	54.00	-10.53	1.36 H	64	26.27	17.20

**ANTENNA POLARITY & TEST DISTANCE: VERTICAL AT 3 M**

NO.	FREQ. (MHz)	EMISSION LEVEL (dBuV/m)	LIMIT (dBuV/m)	MARGIN (dB)	ANTENNA HEIGHT (m)	TABLE ANGLE (Degree)	RAW VALUE (dBuV)	CORRECTION FACTOR (dB/m)
1	#5642.14	62.75 PK	68.20	-5.45	2.16 V	342	55.40	7.35
2	*5755.00	113.62 PK			2.16 V	342	106.22	7.40
3	*5755.00	100.96 AV			2.16 V	342	93.56	7.40
4	#5981.35	63.42 PK	68.20	-4.78	2.16 V	342	55.37	8.05
5	11510.00	56.36 PK	74.00	-17.64	2.71 V	125	39.16	17.20
6	11510.00	42.28 AV	54.00	-11.72	2.71 V	125	25.08	17.20

**REMARKS:**

1. Emission Level(dBuV/m) = Raw Value(dBuV) + Correction Factor(dB/m)
2. Correction Factor(dB/m) = Antenna Factor(dB/m) + Cable Factor(dB) – Pre-Amplifier Factor(dB)
3. The other emission levels were very low against the limit.
4. Margin value = Emission Level – Limit value
5. " \* ": Fundamental frequency.
6. " # ": The radiated frequency is out of the restricted band.

<b>CHANNEL</b>	TX Channel 159	<b>DETECTOR FUNCTION</b>	Peak (PK)
<b>FREQUENCY RANGE</b>	1GHz ~ 40GHz		Average (AV)

**ANTENNA POLARITY & TEST DISTANCE: HORIZONTAL AT 3 M**

NO.	FREQ. (MHz)	EMISSION LEVEL (dBuV/m)	LIMIT (dBuV/m)	MARGIN (dB)	ANTENNA HEIGHT (m)	TABLE ANGLE (Degree)	RAW VALUE (dBuV)	CORRECTION FACTOR (dB/m)
1	#5614.55	62.60 PK	68.20	-5.60	2.06 H	352	55.23	7.37
2	*5795.00	118.58 PK			2.06 H	352	111.13	7.45
3	*5795.00	104.59 AV			2.06 H	352	97.14	7.45
4	#5948.32	63.07 PK	68.20	-5.13	2.06 H	352	55.16	7.91
5	11590.00	57.50 PK	74.00	-16.50	1.81 H	230	40.23	17.27
6	11590.00	43.61 AV	54.00	-10.39	1.81 H	230	26.34	17.27

**ANTENNA POLARITY & TEST DISTANCE: VERTICAL AT 3 M**

NO.	FREQ. (MHz)	EMISSION LEVEL (dBuV/m)	LIMIT (dBuV/m)	MARGIN (dB)	ANTENNA HEIGHT (m)	TABLE ANGLE (Degree)	RAW VALUE (dBuV)	CORRECTION FACTOR (dB/m)
1	#5616.68	62.68 PK	68.20	-5.52	2.21 V	332	55.32	7.36
2	*5795.00	113.86 PK			2.21 V	332	106.41	7.45
3	*5795.00	100.70 AV			2.21 V	332	93.25	7.45
4	#5933.30	62.89 PK	68.20	-5.31	2.21 V	332	55.04	7.85
5	11590.00	57.01 PK	74.00	-16.99	1.86 V	151	39.74	17.27
6	11590.00	42.91 AV	54.00	-11.09	1.86 V	151	25.64	17.27

**REMARKS:**

1. Emission Level(dBuV/m) = Raw Value(dBuV) + Correction Factor(dB/m)
2. Correction Factor(dB/m) = Antenna Factor(dB/m) + Cable Factor(dB) – Pre-Amplifier Factor(dB)
3. The other emission levels were very low against the limit.
4. Margin value = Emission Level – Limit value
5. " \* ": Fundamental frequency.
6. " # ": The radiated frequency is out of the restricted band.



802.11ac (80MHz)

<b>CHANNEL</b>	TX Channel 42	<b>DETECTOR FUNCTION</b>	Peak (PK)
<b>FREQUENCY RANGE</b>	1GHz ~ 40GHz		Average (AV)

**ANTENNA POLARITY & TEST DISTANCE: HORIZONTAL AT 3 M**

NO.	FREQ. (MHz)	EMISSION LEVEL (dBuV/m)	LIMIT (dBuV/m)	MARGIN (dB)	ANTENNA HEIGHT (m)	TABLE ANGLE (Degree)	RAW VALUE (dBuV)	CORRECTION FACTOR (dB/m)
1	5150.00	72.29 PK	74.00	-1.71	1.88 H	336	66.35	5.94
2	5150.00	52.51 AV	54.00	-1.49	1.88 H	336	46.57	5.94
3	*5210.00	112.44 PK			1.88 H	336	106.29	6.15
4	*5210.00	99.51 AV			1.88 H	336	93.36	6.15
5	5350.00	62.71 PK	74.00	-11.29	1.88 H	336	55.96	6.75
6	5350.00	46.36 AV	54.00	-7.64	1.88 H	336	39.61	6.75
7	#10420.00	56.74 PK	74.00	-17.26	1.64 H	251	40.43	16.31
8	#10420.00	42.67 AV	54.00	-11.33	1.64 H	251	26.36	16.31

**ANTENNA POLARITY & TEST DISTANCE: VERTICAL AT 3 M**

NO.	FREQ. (MHz)	EMISSION LEVEL (dBuV/m)	LIMIT (dBuV/m)	MARGIN (dB)	ANTENNA HEIGHT (m)	TABLE ANGLE (Degree)	RAW VALUE (dBuV)	CORRECTION FACTOR (dB/m)
1	5150.00	68.48 PK	74.00	-5.52	2.11 V	347	62.54	5.94
2	5150.00	47.63 AV	54.00	-6.37	2.11 V	347	41.69	5.94
3	*5210.00	108.30 PK			2.11 V	347	102.15	6.15
4	*5210.00	96.04 AV			2.11 V	347	89.89	6.15
5	5350.00	60.91 PK	74.00	-13.09	2.11 V	347	54.16	6.75
6	5350.00	44.64 AV	54.00	-9.36	2.11 V	347	37.89	6.75
7	#10420.00	55.62 PK	74.00	-18.38	1.44 V	211	39.31	16.31
8	#10420.00	41.47 AV	54.00	-12.53	1.44 V	211	25.16	16.31

**REMARKS:**

1. Emission Level(dBuV/m) = Raw Value(dBuV) + Correction Factor(dB/m)
2. Correction Factor(dB/m) = Antenna Factor(dB/m) + Cable Factor(dB) – Pre-Amplifier Factor(dB)
3. The other emission levels were very low against the limit.
4. Margin value = Emission Level – Limit value
5. " \* ": Fundamental frequency.
6. " # ": The radiated frequency is out of the restricted band.

<b>CHANNEL</b>	TX Channel 155	<b>DETECTOR FUNCTION</b>	Peak (PK)
<b>FREQUENCY RANGE</b>	1GHz ~ 40GHz		Average (AV)

**ANTENNA POLARITY & TEST DISTANCE: HORIZONTAL AT 3 M**

NO.	FREQ. (MHz)	EMISSION LEVEL (dBuV/m)	LIMIT (dBuV/m)	MARGIN (dB)	ANTENNA HEIGHT (m)	TABLE ANGLE (Degree)	RAW VALUE (dBuV)	CORRECTION FACTOR (dB/m)
1	#5648.19	65.97 PK	68.20	-2.23	1.95 H	336	58.61	7.36
2	*5775.00	117.27 PK			1.95 H	336	109.85	7.42
3	*5775.00	102.67 AV			1.95 H	336	95.25	7.42
4	#5930.75	64.20 PK	68.20	-4.00	1.95 H	336	56.36	7.84
5	11550.00	58.08 PK	74.00	-15.92	1.52 H	130	40.84	17.24
6	11550.00	43.79 AV	54.00	-10.21	1.52 H	130	26.55	17.24

**ANTENNA POLARITY & TEST DISTANCE: VERTICAL AT 3 M**

NO.	FREQ. (MHz)	EMISSION LEVEL (dBuV/m)	LIMIT (dBuV/m)	MARGIN (dB)	ANTENNA HEIGHT (m)	TABLE ANGLE (Degree)	RAW VALUE (dBuV)	CORRECTION FACTOR (dB/m)
1	#5649.20	64.74 PK	68.20	-3.46	2.17 V	315	57.38	7.36
2	*5775.00	112.66 PK			2.17 V	315	105.24	7.42
3	*5775.00	98.86 AV			2.17 V	315	91.44	7.42
4	#5929.30	63.36 PK	68.20	-4.84	2.17 V	315	55.54	7.82
5	11550.00	56.65 PK	74.00	-17.35	1.45 V	214	39.41	17.24
6	11550.00	42.58 AV	54.00	-11.42	1.45 V	214	25.34	17.24

**REMARKS:**

1. Emission Level(dBuV/m) = Raw Value(dBuV) + Correction Factor(dB/m)
2. Correction Factor(dB/m) = Antenna Factor(dB/m) + Cable Factor(dB) – Pre-Amplifier Factor(dB)
3. The other emission levels were very low against the limit.
4. Margin value = Emission Level – Limit value
5. " \* ": Fundamental frequency.
6. " # ": The radiated frequency is out of the restricted band.

**BELOW 1GHz WORST-CASE DATA:**
**CDD Mode**
**802.11a**

<b>CHANNEL</b>	TX Channel 40	<b>DETECTOR FUNCTION</b>	Quasi-Peak (QP)
<b>FREQUENCY RANGE</b>	9kHz ~ 1GHz		

**ANTENNA POLARITY & TEST DISTANCE: HORIZONTAL AT 3 M**

NO.	FREQ. (MHz)	EMISSION LEVEL (dBuV/m)	LIMIT (dBuV/m)	MARGIN (dB)	ANTENNA HEIGHT (m)	TABLE ANGLE (Degree)	RAW VALUE (dBuV)	CORRECTION FACTOR (dB/m)
1	34.51	31.58 QP	40.00	-8.42	1.93 H	51	42.32	-10.74
2	64.58	23.45 QP	40.00	-16.55	2.41 H	274	34.01	-10.56
3	106.05	24.81 QP	43.50	-18.69	1.92 H	138	37.90	-13.09
4	190.73	20.40 QP	43.50	-23.10	2.71 H	138	31.68	-11.28
5	214.45	19.65 QP	43.50	-23.85	1.16 H	321	30.87	-11.22
6	389.29	22.75 QP	46.00	-23.25	1.23 H	360	28.31	-5.56

**ANTENNA POLARITY & TEST DISTANCE: VERTICAL AT 3 M**

NO.	FREQ. (MHz)	EMISSION LEVEL (dBuV/m)	LIMIT (dBuV/m)	MARGIN (dB)	ANTENNA HEIGHT (m)	TABLE ANGLE (Degree)	RAW VALUE (dBuV)	CORRECTION FACTOR (dB/m)
1	34.93	37.62 QP	40.00	-2.38	1.33 V	327	48.27	-10.65
2	59.54	34.31 QP	40.00	-5.69	1.55 V	360	44.04	-9.73
3	105.81	28.68 QP	43.50	-14.82	1.80 V	212	41.80	-13.12
4	165.36	20.89 QP	43.50	-22.61	2.23 V	201	30.04	-9.15
5	221.14	21.39 QP	46.00	-24.61	1.42 V	185	32.70	-11.31
6	501.61	25.29 QP	46.00	-20.71	1.81 V	182	28.28	-2.99

**REMARKS:**

1. Emission Level(dBuV/m) = Raw Value(dBuV) + Correction Factor(dB/m)
2. Correction Factor(dB/m) = Antenna Factor(dB/m) + Cable Factor(dB) – Pre-Amplifier Factor(dB)
3. The other emission levels were very low against the limit.
4. Margin value = Emission Level – Limit value

## 4.2 Conducted Emission Measurement

### 4.2.1 Limits of Conducted Emission Measurement

Frequency (MHz)	Conducted Limit (dBuV)	
	Quasi-peak	Average
0.15 - 0.5	66 - 56	56 - 46
0.50 - 5.0	56	46
5.0 - 30.0	60	50

Note: 1. The lower limit shall apply at the transition frequencies.

2. The limit decreases in line with the logarithm of the frequency in the range of 0.15 to 0.50MHz.

### 4.2.2 Test Instruments

Description & Manufacturer	Model No.	Serial No.	Cal. Date	Cal. Due
ROHDE & SCHWARZ TEST RECEIVER	ESCS 30	100276	Apr. 10, 2017	Apr. 9, 2018
ROHDE & SCHWARZ Artificial Mains Network (for EUT)	ENV216	101196	Apr. 20, 2017	Apr. 19, 2018
LISN With Adapter (for EUT)	AD10	C10Ada-002	Apr. 20, 2017	Apr. 19, 2018
ROHDE & SCHWARZ Artificial Mains Network (for peripherals)	ESH3-Z5	100218	Nov. 23, 2016	Nov. 22, 2017
SCHWARZBECK Artificial Mains Network (For EUT)	NNLK8129	8129229	May 9, 2017	May 8, 2018
Software	Cond_V7.3.7.4	NA	NA	NA
RF cable (JYEBAO) With 10dB PAD	5D-FB	Cable-C10.01	Feb. 14, 2017	Feb. 13, 2018
SUHNTER Terminator (For ROHDE & SCHWARZ LISN)	65BNC-5001	E1-01-299	Jan. 18, 2017	Jan. 17, 2018
ROHDE & SCHWARZ Artificial Mains Network (For TV EUT)	ESH3-Z5	100220	Nov. 8, 2016	Nov. 7, 2017
LISN With Adapter (for TV EUT)	100220	N/A	Nov. 8, 2016	Nov. 7, 2017

Notes: 1. The calibration interval of the above test instruments is 12 months and the calibrations are traceable to NML/ROC and NIST/USA.

2. The test was performed in Shielded Room No. 10.

3. Tested Date: May 16, 2017

#### 4.2.3 Test Procedure

- The EUT was placed 0.4 meters from the conducting wall of the shielded room with EUT being connected to the power mains through a line impedance stabilization network (LISN). Other support units were connected to the power mains through another LISN. The two LISNs provide 50 ohm/ 50uH of coupling impedance for the measuring instrument.
- Both lines of the power mains connected to the EUT were checked for maximum conducted interference.
- The frequency range from 150kHz to 30MHz was searched. Emission levels under (Limit - 20dB) was not recorded.

**NOTE:** All modes of operation were investigated and the worst-case emissions are reported.

#### 4.2.4 Deviation from Test Standard

No deviation.

#### 4.2.5 Test Setup

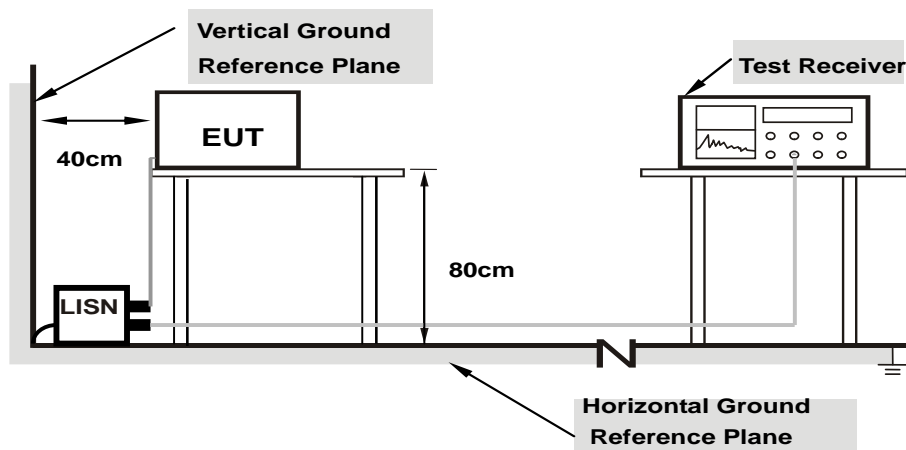

**Note: 1.Support units were connected to second LISN.**

For the actual test configuration, please refer to the attached file (Test Setup Photo).

#### 4.2.6 EUT Operating Condition

Same as item 4.1.6.

#### 4.2.7 Test Results

##### CDD Mode

Phase	Line (L)	Detector Function	Quasi-Peak (QP) / Average (AV)
-------	----------	-------------------	--------------------------------

No	Freq. [MHz]	Corr.	Reading Value		Emission Level		Limit		Margin	
		Factor	[dB (uV)]		[dB (uV)]		[dB (uV)]		(dB)	
		(dB)	Q.P.	AV.	Q.P.	AV.	Q.P.	AV.	Q.P.	AV.
1	0.15000	9.62	37.85	31.30	47.47	40.92	66.00	56.00	-18.53	-15.08
2	0.18906	9.62	32.50	25.65	42.12	35.27	64.08	54.08	-21.96	-18.81
<b>3</b>	<b>0.52891</b>	<b>9.65</b>	<b>28.58</b>	<b>27.19</b>	<b>38.23</b>	<b>36.84</b>	<b>56.00</b>	<b>46.00</b>	<b>-17.77</b>	<b>-9.16</b>
4	3.55859	9.82	19.78	13.16	29.60	22.98	56.00	46.00	-26.40	-23.02
5	9.86719	9.94	15.32	8.81	25.26	18.75	60.00	50.00	-34.74	-31.25
6	26.12109	10.10	24.89	19.05	34.99	29.15	60.00	50.00	-25.01	-20.85

##### REMARKS:

1. Q.P. and AV. are abbreviations of quasi-peak and average individually.
2. The emission levels of other frequencies were very low against the limit.
3. Margin value = Emission level - Limit value
4. Correction factor = Insertion loss + Cable loss
5. Emission Level = Correction Factor + Reading Value.

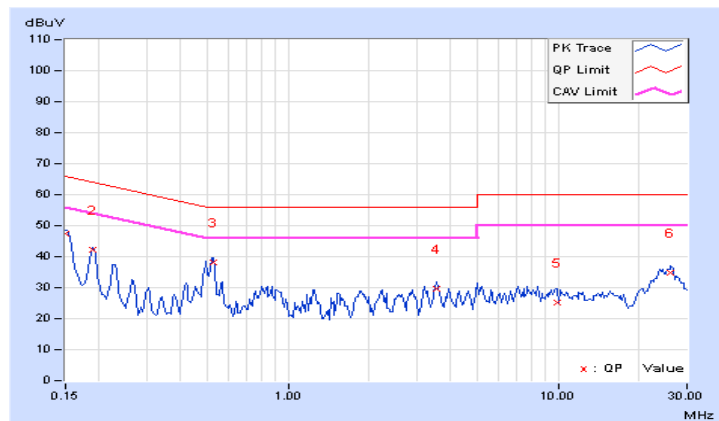

Phase	Neutral (N)	Detector Function	Quasi-Peak (QP) / Average (AV)
-------	-------------	-------------------	--------------------------------

No	Freq. [MHz]	Corr.	Reading Value		Emission Level		Limit		Margin	
		Factor	[dB (uV)]		[dB (uV)]		[dB (uV)]		(dB)	
		(dB)	Q.P.	AV.	Q.P.	AV.	Q.P.	AV.	Q.P.	AV.
1	0.15000	9.65	37.81	30.72	47.46	40.37	66.00	56.00	-18.54	-15.63
2	0.18906	9.64	32.47	25.23	42.11	34.87	64.08	54.08	-21.97	-19.21
3	0.52891	9.66	27.65	26.17	37.31	35.83	56.00	46.00	-18.69	-10.17
4	0.82578	9.68	15.29	10.08	24.97	19.76	56.00	46.00	-31.03	-26.24
5	3.56250	9.82	18.23	11.46	28.05	21.28	56.00	46.00	-27.95	-24.72
6	25.96875	10.32	23.91	18.25	34.23	28.57	60.00	50.00	-25.77	-21.43

**REMARKS:**

1. Q.P. and AV. are abbreviations of quasi-peak and average individually.
2. The emission levels of other frequencies were very low against the limit.
3. Margin value = Emission level - Limit value
4. Correction factor = Insertion loss + Cable loss
5. Emission Level = Correction Factor + Reading Value.

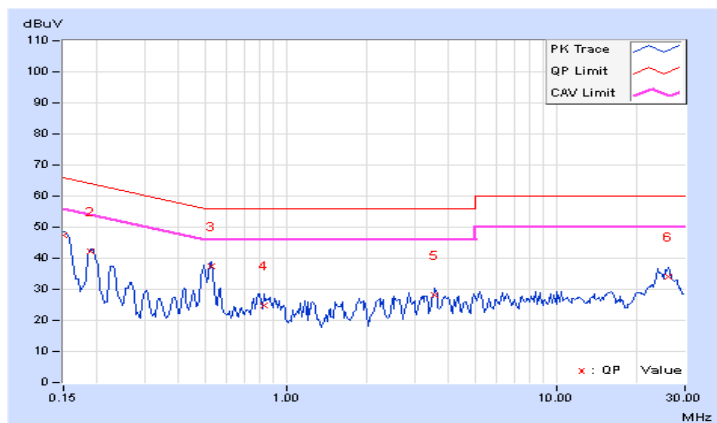

### 4.3 Transmit Power Measurement

#### 4.3.1 Limits of Transmit Power Measurement

Operation Band	EUT Category		Limit
U-NII-1	√	Outdoor Access Point	1 Watt (30 dBm) (Max. e.i.r.p ≤ 125mW(21 dBm) at any elevation angle above 30 degrees as measured from the horizon)
		Fixed point-to-point Access Point	1 Watt (30 dBm)
		Indoor Access Point	1 Watt (30 dBm)
		Mobile and Portable client device	250mW (24 dBm)
U-NII-2A	---		250mW (24 dBm) or 11 dBm+10 log B*
U-NII-2C	---		250mW (24 dBm) or 11 dBm+10 log B*
U-NII-3	√		1 Watt (30 dBm)

\*B is the 26 dB emission bandwidth in megahertz

Per KDB 662911 Method of conducted output power measurement on IEEE 802.11 devices,

Array Gain = 0 dB (i.e., no array gain) for  $N_{ANT} \leq 4$ ;

Array Gain = 0 dB (i.e., no array gain) for channel widths  $\geq 40$  MHz for any  $N_{ANT}$ ;

Array Gain =  $5 \log(N_{ANT}/N_{SS})$  dB or 3 dB, whichever is less for 20-MHz channel widths with  $N_{ANT} \geq 5$ .

For power measurements on all other devices: Array Gain =  $10 \log(N_{ANT}/N_{SS})$  dB.

#### 4.3.2 Test Setup

##### FOR POWER OUTPUT MEASUREMENT

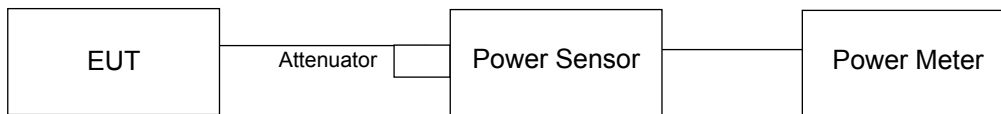

##### FOR 26dB OCCUPIED BANDWIDTH

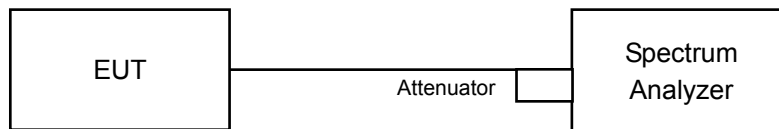

#### 4.3.3 Test Instruments

Refer to section 4.1.2 to get information of above instrument.



#### 4.3.4 Test Procedure

##### For Average Power Measurement

###### For 802.11a, 802.11ac (20MHz), 802.11ac (40MHz)

Method PM is used to perform output power measurement, trigger and gating function of wide band power meter is enabled to measure max output power of TX on burst. Duty factor is not added to measured value.

###### For 802.11ac (80MHz)

- 1) Set span to encompass the entire 26 dB EBW (or, alternatively, the entire 99% occupied bandwidth) of the signal.
- 2) Set sweep trigger to "free run".
- 3) Set RBW = 1 MHz.
- 4) Set VBW  $\geq$  3 MHz
- 5) Number of points in sweep  $\geq$  2 Span / RBW.
- 6) Sweep time  $\leq$  (number of points in sweep) \* T
- 7) Using emission bandwidth to determine the frequency span for integration the channel bandwidth.
- 8) Detector = RMS.
- 9) Trace mode = max hold.
- 10) Allow max hold to run for at least 60 seconds, or longer as needed to allow the trace to stabilize.

###### For 26dB Occupied Bandwidth

- 1) Set RBW = approximately 1% of the emission bandwidth.
- 2) Set the VBW > RBW.
- 3) Detector = Peak.
- 4) Trace mode = max hold.
- 5) Measure the maximum width of the emission that is 26 dB down from the peak of the emission. Compare this with the RBW setting of the analyzer. Readjust RBW and repeat measurement as needed until the RBW/EBW ratio is approximately 1%.

#### 4.3.5 Deviation from Test Standard

No deviation.

#### 4.3.6 EUT Operating Condition

The software provided by client to enable the EUT under transmission condition continuously at lowest, middle and highest channel frequencies individually.

#### 4.3.7 Test Result

#### Power Output:

#### CDD Mode

#### For U-NII-1 Band (Outdoor Access Point)

#### 802.11a

Chan.	Freq. (MHz)	Conducted Power (dBm)		Total Power (mW)	Total Power (dBm)	Power Limit (dBm)	Gain (dBi)	EIRP (dBm)	EIRP limit (dBm)	Pass / Fail
		Chain 0	Chain 1							
36	5180	10.59	10.87	23.673	13.74	29.03	6.97	20.71	21.00	Pass
40	5200	10.60	10.89	23.756	13.76	29.03	6.97	20.73	21.00	Pass
48	5240	10.63	10.97	24.064	13.81	29.03	6.97	20.78	21.00	Pass

Gain = 6.97 dBi > 6dBi, so the power limit shall be reduced to  $30 - (6.97 - 6) = 29.03$  dBm.

Gain = 6.97dBi (above 30 degrees from the horizon),

EIRP = conducted power + (6.97dBi) + array gain = (0 dB (i.e., no array gain) for  $N_{ANT} \leq 4$ ).

#### 802.11ac (20MHz)

Chan.	Freq. (MHz)	Conducted Power (dBm)		Total Power (mW)	Total Power (dBm)	Power Limit (dBm)	Gain (dBi)	EIRP (dBm)	EIRP limit (dBm)	Pass / Fail
		Chain 0	Chain 1							
36	5180	10.63	10.96	24.035	13.81	29.03	6.97	20.78	21.00	Pass
40	5200	10.68	10.99	24.255	13.85	29.03	6.97	20.82	21.00	Pass
48	5240	10.69	11.01	24.340	13.86	29.03	6.97	20.83	21.00	Pass

Gain = 6.97 dBi > 6dBi, so the power limit shall be reduced to  $30 - (6.97 - 6) = 29.03$  dBm.

Gain = 6.97dBi (above 30 degrees from the horizon),

EIRP = conducted power + (6.97dBi) + array gain = (0 dB (i.e., no array gain) for  $N_{ANT} \leq 4$ ).

#### 802.11ac (40MHz)

Chan.	Freq. (MHz)	Conducted Power (dBm)		Total Power (mW)	Total Power (dBm)	Power Limit (dBm)	Gain (dBi)	EIRP (dBm)	EIRP limit (dBm)	Pass / Fail
		Chain 0	Chain 1							
38	5190	10.65	10.97	24.117	13.82	29.03	6.97	20.79	21.00	Pass
46	5230	10.68	11.04	<b>24.401</b>	13.87	29.03	6.97	20.84	21.00	Pass

Gain = 6.97 dBi > 6dBi, so the power limit shall be reduced to  $30 - (6.97 - 6) = 29.03$  dBm.

Gain = 6.97dBi (above 30 degrees from the horizon),

EIRP = conducted power + (6.97dBi) + array gain = (0 dB (i.e., no array gain) for  $N_{ANT} \leq 4$ ).

#### 802.11ac (80MHz)

Chan.	Freq. (MHz)	Conducted Power (dBm)		Total Power (mW)	Total Power (dBm)	Power Limit (dBm)	Gain (dBi)	EIRP (dBm)	EIRP limit (dBm)	Pass / Fail
		Chain 0	Chain 1							
42	5210	10.51	11.10	24.128	13.83	29.03	6.97	20.80	21.00	Pass

Gain = 6.97 dBi > 6dBi, so the power limit shall be reduced to  $30 - (6.97 - 6) = 29.03$  dBm.

Gain = 6.97dBi (above 30 degrees from the horizon),

EIRP = conducted power + (6.97dBi) + array gain = (0 dB (i.e., no array gain) for  $N_{ANT} \leq 4$ ).

### For U-NII-3 Band

#### 802.11a

Channel	Frequency (MHz)	Maximum Conducted Power (dBm)		Total Power (mW)	Total Power (dBm)	Power Limit (dBm)	Pass / Fail
		Chain 0	Chain 1				
149	5745	22.69	23.87	429.561	26.33	29.38	Pass
157	5785	22.87	23.96	<b>442.528</b>	26.46	29.38	Pass
165	5825	22.86	23.95	441.510	26.45	29.38	Pass

Gain = 6.62 dBi > 6dBi, so the power limit shall be reduced to  $30 - (6.62 - 6) = 29.38$ dBm.

#### 802.11ac (20MHz)

Channel	Frequency (MHz)	Maximum Conducted Power (dBm)		Total Power (mW)	Total Power (dBm)	Power Limit (dBm)	Pass / Fail
		Chain 0	Chain 1				
149	5745	22.54	24.00	430.662	26.34	29.38	Pass
157	5785	22.62	24.01	434.578	26.38	29.38	Pass
165	5825	22.71	24.05	440.735	26.44	29.38	Pass

Gain = 6.62 dBi > 6dBi, so the power limit shall be reduced to  $30 - (6.62 - 6) = 29.38$ dBm.

#### 802.11ac (40MHz)

Channel	Frequency (MHz)	Maximum Conducted Power (dBm)		Total Power (mW)	Total Power (dBm)	Power Limit (dBm)	Pass / Fail
		Chain 0	Chain 1				
151	5755	22.36	23.58	400.221	26.02	29.38	Pass
159	5795	22.45	23.62	405.936	26.08	29.38	Pass

Gain = 6.62 dBi > 6dBi, so the power limit shall be reduced to  $30 - (6.62 - 6) = 29.38$ dBm.

#### 802.11ac (80MHz)

Channel	Frequency (MHz)	Maximum Conducted Power (dBm)		Total Power (mW)	Total Power (dBm)	Power Limit (dBm)	Pass / Fail
		Chain 0	Chain 1				
155	5775	20.55	21.51	255.080	24.07	29.38	Pass

Gain = 6.62 dBi > 6dBi, so the power limit shall be reduced to  $30 - (6.62 - 6) = 29.38$ dBm.

## Beamforming Mode

### For U-NII-1 Band (Outdoor Access Point)

#### 802.11ac (20MHz)

Chan.	Freq. (MHz)	Conducted Power (dBm)		Total Power (mW)	Total Power (dBm)	Power Limit (dBm)	Gain (dBi)	EIRP (dBm)	EIRP limit (dBm)	Pass / Fail
		Chain 0	Chain 1							
36	5180	7.59	7.94	11.964	10.78	26.02	9.98	20.76	21.00	Pass
40	5200	7.65	7.95	12.058	10.81	26.02	9.98	20.79	21.00	Pass
48	5240	7.67	7.99	12.143	10.84	26.02	9.98	20.82	21.00	Pass

Directional gain =  $10 \log[(10^{G1/20} + 10^{G2/20} + \dots + 10^{GN/20})^2 / 2] = 9.98\text{dBi} > 6\text{dBi}$ , so the Conducted Power limit shall be reduced to  $30 - (9.98 - 6) = 26.02\text{dBm}$   
 Gain = 6.97dBi (above 30 degrees from the horizon),  
 EIRP = conducted power + Directional gain

#### 802.11ac (40MHz)

Chan.	Freq. (MHz)	Conducted Power (dBm)		Total Power (mW)	Total Power (dBm)	Power Limit (dBm)	Gain (dBi)	EIRP (dBm)	EIRP limit (dBm)	Pass / Fail
		Chain 0	Chain 1							
38	5190	7.65	7.95	12.058	10.81	26.02	9.98	20.79	21.00	Pass
46	5230	7.69	8.00	12.185	10.86	26.02	9.98	20.84	21.00	Pass

Directional gain =  $10 \log[(10^{G1/20} + 10^{G2/20} + \dots + 10^{GN/20})^2 / 2] = 9.98\text{dBi} > 6\text{dBi}$ , so the Conducted Power limit shall be reduced to  $30 - (9.98 - 6) = 26.02\text{dBm}$   
 Gain = 6.97dBi (above 30 degrees from the horizon),  
 EIRP = conducted power + Directional gain

#### 802.11ac (80MHz)

Chan.	Freq. (MHz)	Conducted Power (dBm)		Total Power (mW)	Total Power (dBm)	Power Limit (dBm)	Gain (dBi)	EIRP (dBm)	EIRP limit (dBm)	Pass / Fail
		Chain 0	Chain 1							
42	5210	7.58	8.07	12.14	10.84	26.02	9.98	20.82	21.00	Pass

Directional gain =  $10 \log[(10^{G1/20} + 10^{G2/20} + \dots + 10^{GN/20})^2 / 2] = 9.98\text{dBi} > 6\text{dBi}$ , so the Conducted Power limit shall be reduced to  $30 - (9.98 - 6) = 26.02\text{dBm}$   
 Gain = 6.97dBi (above 30 degrees from the horizon),  
 EIRP = conducted power + Directional gain

### For U-NII-3 Band

#### 802.11ac (20MHz)

Chan.	Freq. (MHz)	Conducted Power (dBm)		Total Power (mW)	Total Power (dBm)	Power Limit (dBm)	Pass / Fail
		Chain 0	Chain 1				
149	5745	18.52	19.98	170.662	22.32	26.56	Pass
157	5785	18.61	19.98	172.152	22.36	26.56	Pass
165	5825	18.69	20.00	173.961	22.40	26.56	Pass

Directional gain =  $10 \log[(10^{G1/20} + 10^{G2/20} + \dots + 10^{GN/20})^2 / 2]$  = 9.44dBi >6dBi, so the Conducted Power limit shall be reduced to  $30-(9.44-6) = 26.56$ dBm

#### 802.11ac (40MHz)

Chan.	Freq. (MHz)	Conducted Power (dBm)		Total Power (mW)	Total Power (dBm)	Power Limit (dBm)	Pass / Fail
		Chain 0	Chain 1				
151	5755	18.33	19.56	158.442	22.00	26.56	Pass
159	5795	18.46	19.61	161.557	22.08	26.56	Pass

Directional gain =  $10 \log[(10^{G1/20} + 10^{G2/20} + \dots + 10^{GN/20})^2 / 2]$  = 9.44dBi >6dBi, so the Conducted Power limit shall be reduced to  $30-(9.44-6) = 26.56$ dBm

#### 802.11ac (80MHz)

Chan.	Freq. (MHz)	Conducted Power (dBm)		Total Power (mW)	Total Power (dBm)	Power Limit (dBm)	Pass / Fail
		Chain 0	Chain 1				
155	5775	18.42	19.54	159.452	22.03	26.56	Pass

Directional gain =  $10 \log[(10^{G1/20} + 10^{G2/20} + \dots + 10^{GN/20})^2 / 2]$  = 9.44dBi >6dBi, so the Conducted Power limit shall be reduced to  $30-(9.44-6) = 26.56$ dBm

**26dB Bandwidth:**

**CDD Mode**

**802.11a**

Channel	Frequency (MHz)	26dBc Bandwidth (MHz)		Pass / Fail
		Chain 0	Chain 1	
36	5180	19.34	19.00	Pass
40	5200	19.20	19.28	Pass
48	5240	19.15	19.32	Pass

**802.11ac (20MHz)**

Channel	Frequency (MHz)	26dBc Bandwidth (MHz)		Pass / Fail
		Chain 0	Chain 1	
36	5180	20.35	20.35	Pass
40	5200	20.56	20.54	Pass
48	5240	20.53	20.38	Pass

**802.11ac (40MHz)**

Channel	Frequency (MHz)	26dBc Bandwidth (MHz)		Pass / Fail
		Chain 0	Chain 1	
38	5190	39.81	39.67	Pass
46	5230	39.70	39.59	Pass

**802.11ac (80MHz)**

Channel	Frequency (MHz)	26dBc Bandwidth (MHz)		Pass / Fail
		Chain 0	Chain 1	
42	5210	84.30	83.78	Pass

Spectrum Plot of Worst Value

802.11a / Chain 0: CH36

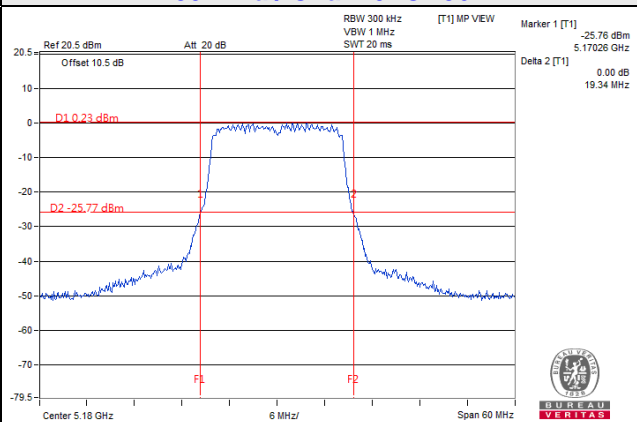

802.11ac (20MHz) / Chain 0: CH40

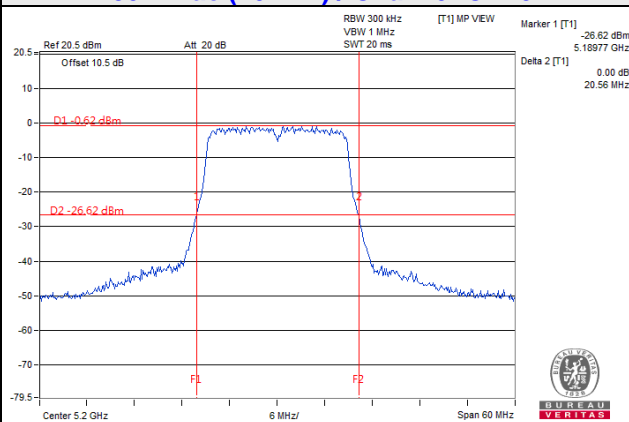

802.11ac (40MHz) / Chain 0: CH38

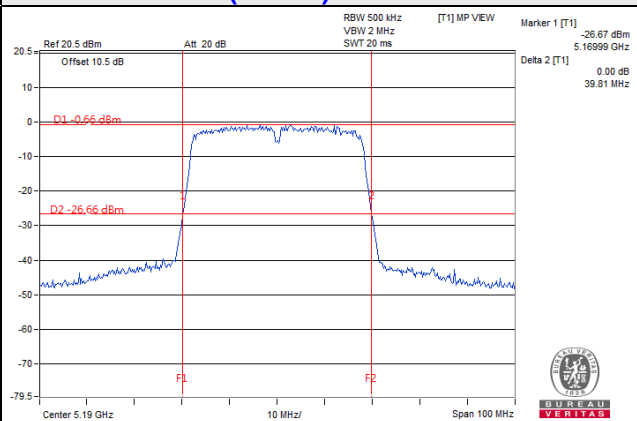

802.11ac (80MHz) / Chain 0: CH42

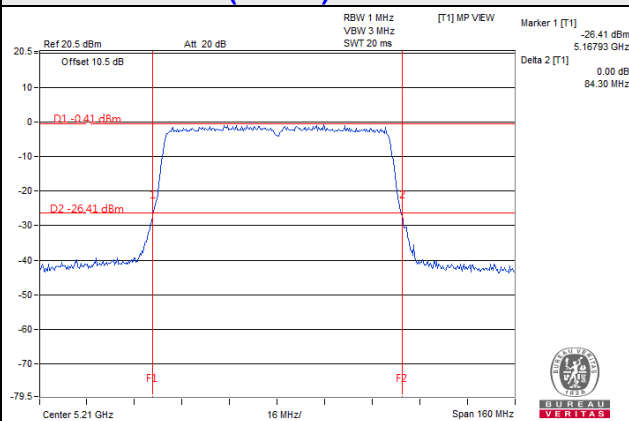

## 4.4 Occupied Bandwidth Measurement

### 4.4.1 Test Setup

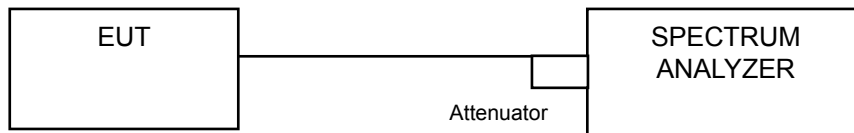

### 4.4.2 Test Instruments

Refer to section 4.1.2 to get information of above instrument.

### 4.4.3 Test Procedure

The transmitter output was connected to the spectrum analyzer through an attenuator. The bandwidth of the fundamental frequency was measured by spectrum analyzer with resolution bandwidth in the range of 1% to 5% of the anticipated emission bandwidth, and a video bandwidth at least 3x the resolution bandwidth and set the detector to SAMPLE. The width of a frequency band such that, below the lower and above the upper frequency limits, the mean powers emitted are each equal to a specified percentage 0.5 %of the total mean power of a given emission.



#### 4.4.4 Test Results

##### CDD Mode

##### 802.11a

Channel	Channel Frequency (MHz)	Occupied Bandwidth (Mhz)		Pass / Fail
		Chain 0	Chain 1	
36	5180	16.44	16.44	Pass
40	5200	16.44	16.44	Pass
48	5240	16.44	16.44	Pass
149	5745	16.52	16.60	Pass
157	5785	16.60	16.60	Pass
165	5825	16.70	16.60	Pass

##### 802.11ac (20MHz)

Channel	Channel Frequency (MHz)	Occupied Bandwidth (Mhz)		Pass / Fail
		Chain 0	Chain 1	
36	5180	17.64	17.64	Pass
40	5200	17.64	17.64	Pass
48	5240	17.64	17.64	Pass
149	5745	17.73	17.70	Pass
157	5785	17.80	17.80	Pass
165	5825	17.80	17.80	Pass

##### 802.11ac (40MHz)

Channel	Channel Frequency (MHz)	Occupied Bandwidth (Mhz)		Pass / Fail
		Chain 0	Chain 1	
38	5190	36.00	36.00	Pass
46	5230	36.20	36.00	Pass
151	5755	36.08	36.00	Pass
159	5795	36.16	36.16	Pass

##### 802.11ac (80MHz)

Channel	Channel Frequency (MHz)	Occupied Bandwidth (Mhz)		Pass / Fail
		Chain 0	Chain 1	
42	5210	75.84	75.84	Pass
155	5775	75.68	75.88	Pass

**Spectrum Plot of Worst Value**

**802.11a / Chain 0: CH165**

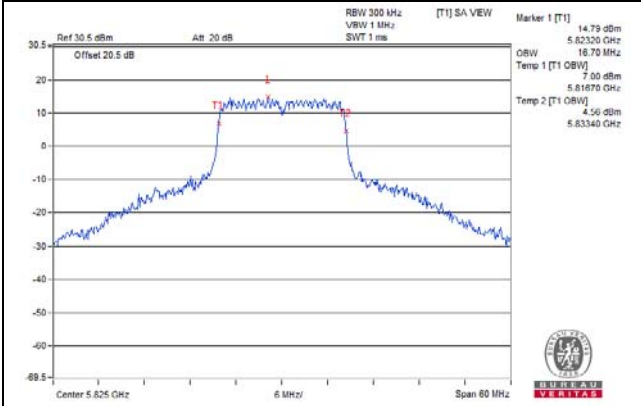

**802.11ac (20MHz) / Chain 0: CH157**

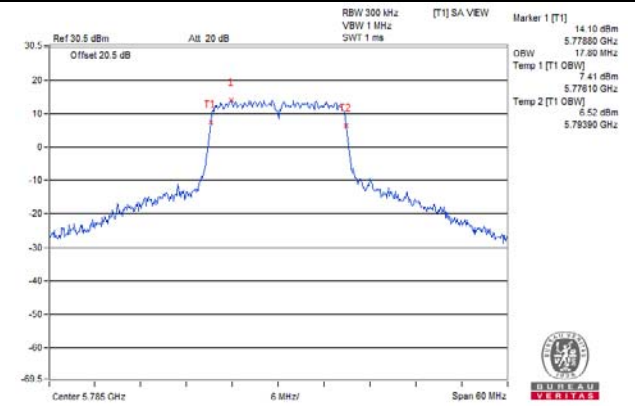

**802.11ac (40MHz) / Chain 0: CH46**

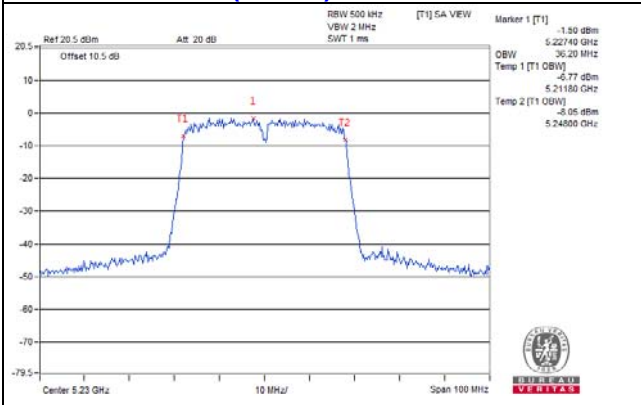

**802.11ac (80MHz) / Chain 1: CH155**

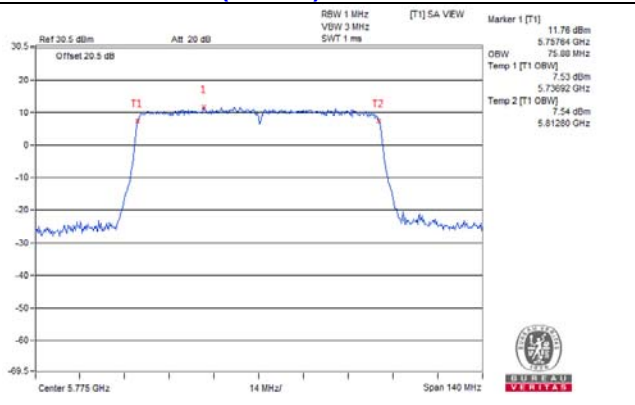

**802.11a\_CH 48\_ 5240 (MHz)**

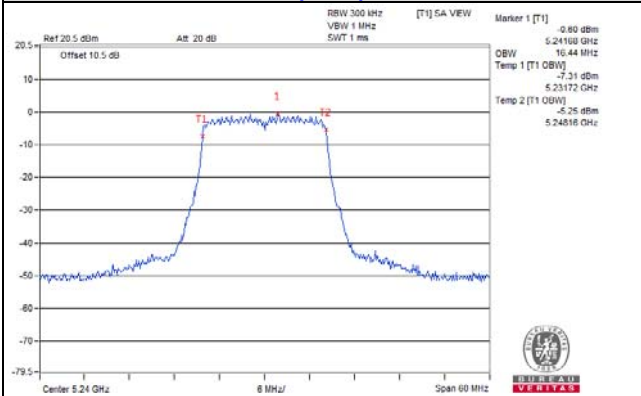

**802.11ac (20MHz)\_ CH 48\_ 5240 (MHz)**

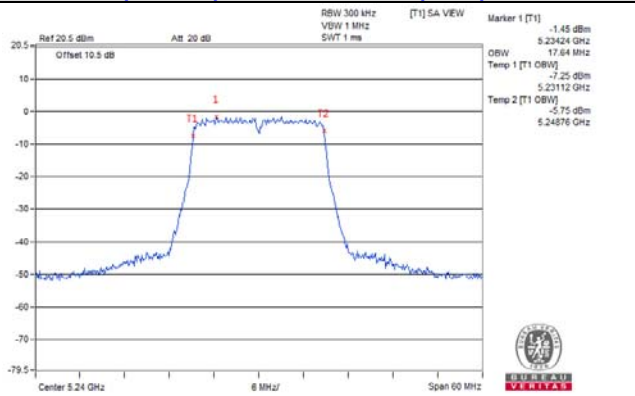

**802.11ac (40MHz)\_ CH46\_ 5230 (MHz)**

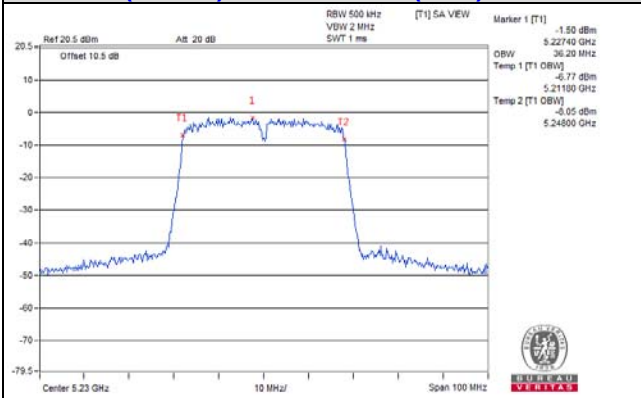

**802.11ac (80MHz)\_ CH 42\_ 5210 (MHz)**

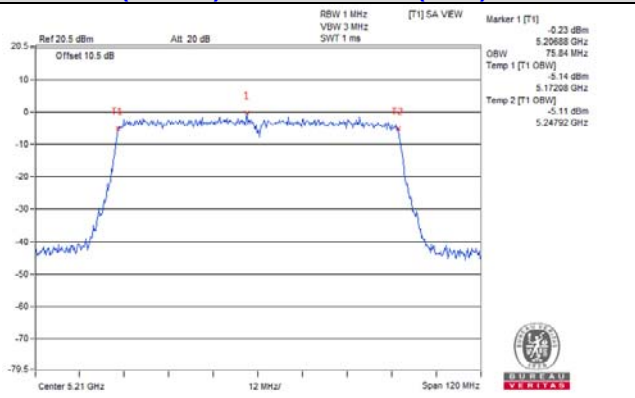

## 4.5 Peak Power Spectral Density Measurement

### 4.5.1 Limits of Peak Power Spectral Density Measurement

Operation Band	EUT Category		Limit
U-NII-1	√	Outdoor Access Point	17dBm/ MHz
		Fixed point-to-point Access Point	
		Indoor Access Point	
		Mobile and Portable client device	11dBm/ MHz
U-NII-2A	---		11dBm/ MHz
U-NII-2C	---		11dBm/ MHz
U-NII-3	√		30dBm/ 500kHz

### 4.5.2 Test Setup

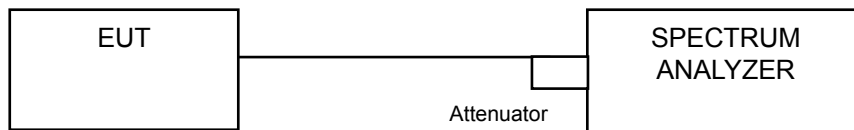

### 4.5.3 Test Instruments

Refer to section 4.1.2 to get information of above instrument.

#### 4.5.4 Test Procedure

##### **For U-NII-1 band:**

###### Using method SA-1

- 1) Set span to encompass the entire emission bandwidth (EBW) of the signal.
- 2) Set RBW = 1 MHz, Set VBW  $\geq$  3 MHz, Detector = RMS
- 3) Sweep time = auto, trigger set to "free run".
- 4) Trace average at least 100 traces in power averaging mode.
- 5) Record the max value

###### Using method SA-2

- 1) Set span to encompass the entire emission bandwidth (EBW) of the signal.
- 2) Set RBW = 1 MHz, Set VBW  $\geq$  3 MHz, Detector = RMS
- 3) Sweep time = auto, trigger set to "free run".
- 4) Trace average at least 100 traces in power averaging mode.
- 5) Record the max value and add  $10 \log (1/\text{duty cycle})$

##### **※For U-NII-3:**

- 1) Set span to encompass the entire emission bandwidth (EBW) of the signal.
- 2) Set RBW = 500 kHz, Set VBW  $\geq$  1 RBW, Detector = RMS
- 3) Sweep time = auto, trigger set to "free run".
- 4) Trace average at least 100 traces in power averaging mode.
- 5) Record the max value and add  $10 \log (1/\text{duty cycle})$

#### 4.5.5 Deviation from Test Standard

No deviation.

#### 4.5.6 EUT Operating Condition

Same as Item 4.3.6.

#### 4.5.7 Test Results

#### CDD Mode For U-NII-1 band 802.11a

Chan.	Chan. Freq. (MHz)	PSD (dBm)		Duty Factor	Total PSD with Duty Factor (dBm/MHz)	MAX. Limit (dBm/MHz)	Pass / Fail
		Chain 0	Chain 1				
36	5180	-5.24	-5.28	0.17	-2.08	13.02	Pass
40	5200	-5.30	-5.36	0.17	-2.15	13.02	Pass
48	5240	-5.61	-5.62	0.17	-2.43	13.02	Pass

**NOTE:**

- Method 1 of power density measurement of KDB 662911 is using for calculating total power density. Total power density is summing entire spectra across corresponding frequency bins on the various outputs by computer.
- Directional gain =  $10 \log[(10^{G1/20} + 10^{G2/20} + \dots + 10^{GN/20})^2 / 2] = 9.98\text{dBi} > 6\text{dBi}$ , so the PSD limit shall be reduced to  $17 - (9.98 - 6) = 13.02\text{dBm}$
- Refer to section 3.3 for duty cycle spectrum plot.

#### 802.11ac (20MHz)

Chan.	Chan. Freq. (MHz)	PSD (dBm)		Total PSD (dBm/MHz)	MAX. Limit (dBm/MHz)	Pass / Fail
		Chain 0	Chain 1			
36	5180	-5.41	-5.38	-2.39	13.02	Pass
40	5200	-5.61	-5.58	-2.58	13.02	Pass
48	5240	-5.93	-5.95	-2.93	13.02	Pass

**NOTE:**

- Method 1 of power density measurement of KDB 662911 is using for calculating total power density. Total power density is summing entire spectra across corresponding frequency bins on the various outputs by computer.
- Directional gain =  $10 \log[(10^{G1/20} + 10^{G2/20} + \dots + 10^{GN/20})^2 / 2] = 9.98\text{dBi} > 6\text{dBi}$ , so the PSD limit shall be reduced to  $17 - (9.98 - 6) = 13.02\text{dBm}$

#### 802.11ac (40MHz)

Chan.	Chan. Freq. (MHz)	PSD (dBm)		Duty Factor	Total PSD with Duty Factor (dBm/MHz)	MAX. Limit (dBm/MHz)	Pass / Fail
		Chain 0	Chain 1				
38	5190	-8.19	-8.15	0.22	-4.94	13.02	Pass
46	5230	-8.48	-8.51	0.22	-5.26	13.02	Pass

**NOTE:**

- Method 1 of power density measurement of KDB 662911 is using for calculating total power density. Total power density is summing entire spectra across corresponding frequency bins on the various outputs by computer.
- Directional gain =  $10 \log[(10^{G1/20} + 10^{G2/20} + \dots + 10^{GN/20})^2 / 2] = 9.98\text{dBi} > 6\text{dBi}$ , so the PSD limit shall be reduced to  $17 - (9.98 - 6) = 13.02\text{dBm}$
- Refer to section 3.3 for duty cycle spectrum plot.

### 802.11ac (80MHz)

Chan.	Chan. Freq. (MHz)	PSD (dBm)		Duty Factor	Total PSD with Duty Factor (dBm/MHz)	MAX. Limit (dBm/MHz)	Pass / Fail
		Chain 0	Chain 1				
42	5210	-11.96	-12.07	0.38	-8.62	13.02	Pass

**NOTE:**

- Method 1 of power density measurement of KDB 662911 is using for calculating total power density. Total power density is summing entire spectra across corresponding frequency bins on the various outputs by computer.
- Directional gain =  $10 \log[(10^{G1/20} + 10^{G2/20} + \dots + 10^{GN/20})^2 / 2] = 9.98\text{dBi} > 6\text{dBi}$ , so the PSD limit shall be reduced to  $17 - (9.98 - 6) = 13.02\text{dBm}$
- Refer to section 3.3 for duty cycle spectrum plot.

#### Spectrum Plot of Worst Value

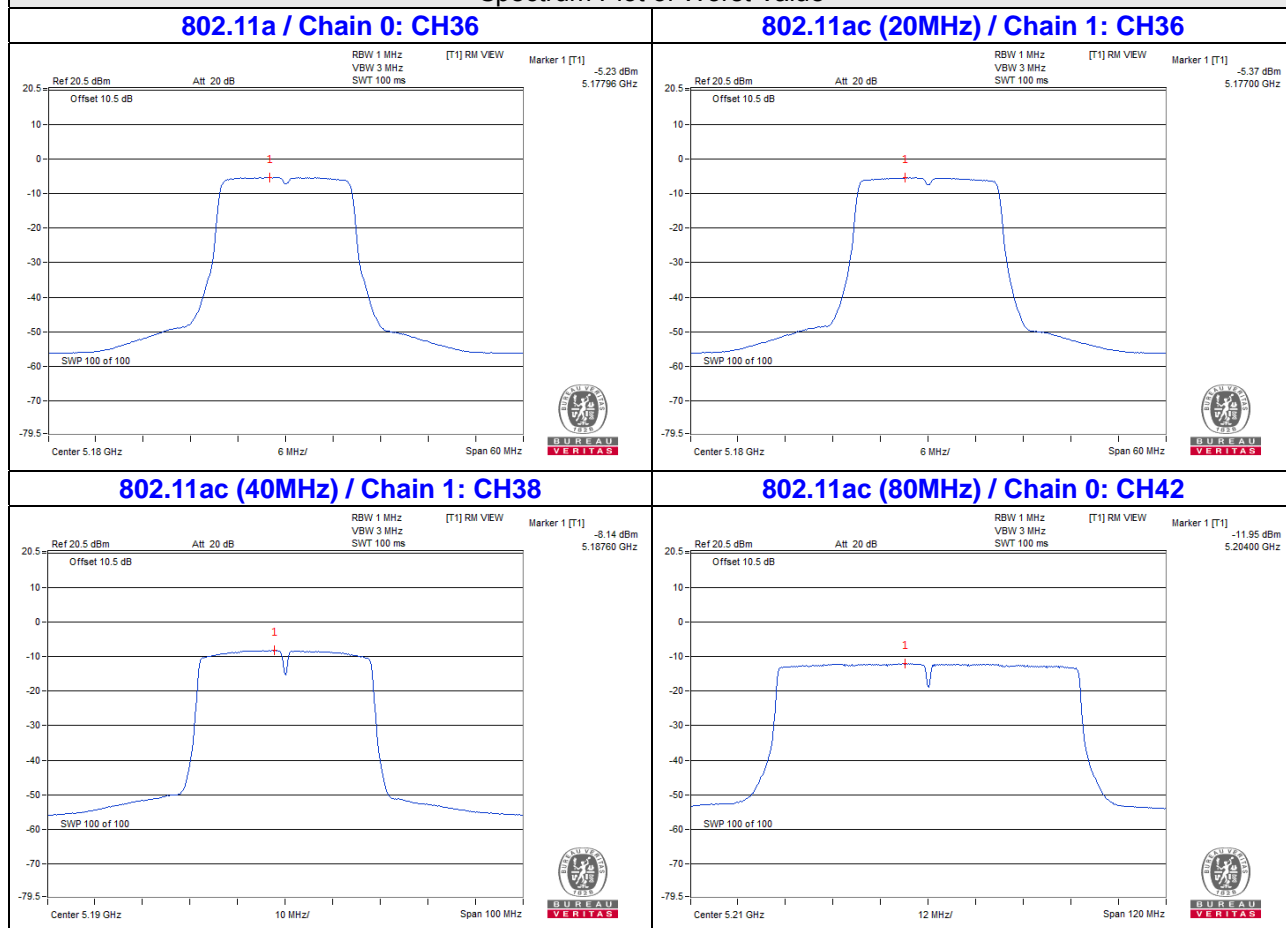

**CDD Mode**  
**For U-NII-3:**  
**802.11a**

TX chain	Channel	Freq. (MHz)	PSD (dBm/500kHz)	10 log (N=2) dB	Duty Factor	Total PSD (dBm/500kHz)	Limit (dBm/500kHz)	Pass /Fail
0	149	5745	18.23	3.01	0.17	21.41	26.56	Pass
	157	5785	18.32	3.01	0.17	21.50	26.56	Pass
	165	5825	18.44	3.01	0.17	21.62	26.56	Pass
1	149	5745	18.29	3.01	0.17	21.47	26.56	Pass
	157	5785	18.33	3.01	0.17	21.51	26.56	Pass
	165	5825	18.56	3.01	0.17	21.74	26.56	Pass

**NOTE:**

- Method 1 of power density measurement of KDB 662911 is using for calculating total power density. Total power density is summing entire spectra across corresponding frequency bins on the various outputs by computer.
- Directional gain =  $10 \log[(10^{G1/20} + 10^{G2/20} + \dots + 10^{GN/20})^2 / 2]$  = 9.44dBi >6dBi, so the PSD limit shall be reduced to  $30-(9.44-6) = 26.56$ dBm
- Refer to section 3.3 for duty cycle spectrum plot.

**802.11ac (20MHz)**

TX chain	Channel	Freq. (MHz)	PSD (dBm/500kHz)	10 log (N=2) dB	Total PSD (dBm/500kHz)	Limit (dBm/500kHz)	Pass /Fail
0	149	5745	17.46	3.01	20.47	26.56	Pass
	157	5785	17.60	3.01	20.61	26.56	Pass
	165	5825	17.54	3.01	20.55	26.56	Pass
1	149	5745	17.58	3.01	20.59	26.56	Pass
	157	5785	17.60	3.01	20.61	26.56	Pass
	165	5825	17.43	3.01	20.44	26.56	Pass

**NOTE:**

- Method 1 of power density measurement of KDB 662911 is using for calculating total power density. Total power density is summing entire spectra across corresponding frequency bins on the various outputs by computer.
- Directional gain =  $10 \log[(10^{G1/20} + 10^{G2/20} + \dots + 10^{GN/20})^2 / 2]$  = 9.44dBi >6dBi, so the PSD limit shall be reduced to  $30-(9.44-6) = 26.56$ dBm
- Refer to section 3.3 for duty cycle spectrum plot.

### 802.11ac (40MHz)

TX chain	Channel	Freq. (MHz)	PSD (dBm/500kHz)	10 log (N=2) dB	Duty Factor	Total PSD (dBm/500kHz)	Limit (dBm/500kHz)	Pass /Fail
0	151	5755	13.58	3.01	0.22	16.81	26.56	Pass
	159	5795	13.66	3.01	0.22	16.89	26.56	Pass
1	151	5755	13.51	3.01	0.22	16.74	26.56	Pass
	159	5795	13.60	3.01	0.22	16.83	26.56	Pass

#### NOTE:

- Method 1 of power density measurement of KDB 662911 is using for calculating total power density. Total power density is summing entire spectra across corresponding frequency bins on the various outputs by computer.
- Directional gain =  $10 \log[(10^{G1/20} + 10^{G2/20} + \dots + 10^{GN/20})^2 / 2]$  = 9.44dBi >6dBi, so the PSD limit shall be reduced to  $30-(9.44-6) = 26.56\text{dBm}$
- Refer to section 3.3 for duty cycle spectrum plot.

### 802.11ac (80MHz)

TX chain	Channel	Freq. (MHz)	PSD (dBm/500kHz)	10 log (N=2) dB	Duty Factor	Total PSD (dBm/500kHz)	Limit (dBm/500kHz)	Pass /Fail
0	155	5775	9.60	3.01	0.38	12.99	26.56	Pass
1	155	5775	9.54	3.01	0.38	12.93	26.56	Pass

#### NOTE:

- Method 1 of power density measurement of KDB 662911 is using for calculating total power density. Total power density is summing entire spectra across corresponding frequency bins on the various outputs by computer.
- Directional gain =  $10 \log[(10^{G1/20} + 10^{G2/20} + \dots + 10^{GN/20})^2 / 2]$  = 9.44dBi >6dBi, so the PSD limit shall be reduced to  $30-(9.44-6) = 26.56\text{dBm}$
- Refer to section 3.3 for duty cycle spectrum plot.



**Spectrum Plot of Worst Value**

**802.11a / Chain 1: CH165**

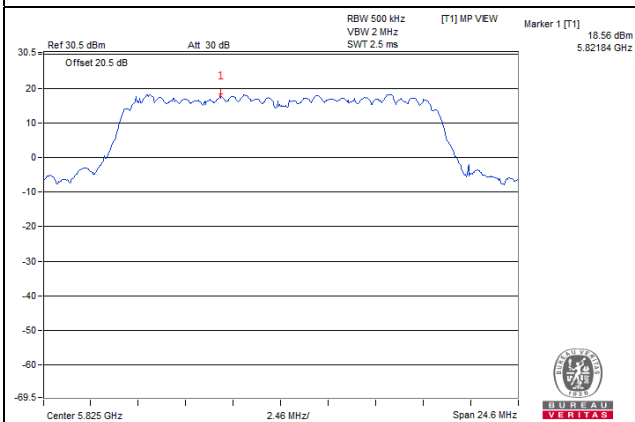

**802.11ac (20MHz) / Chain 0: CH157**

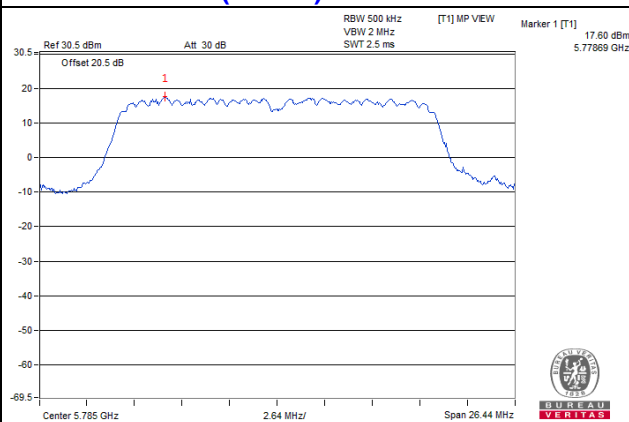

**802.11ac (40MHz) / Chain 0: CH159**

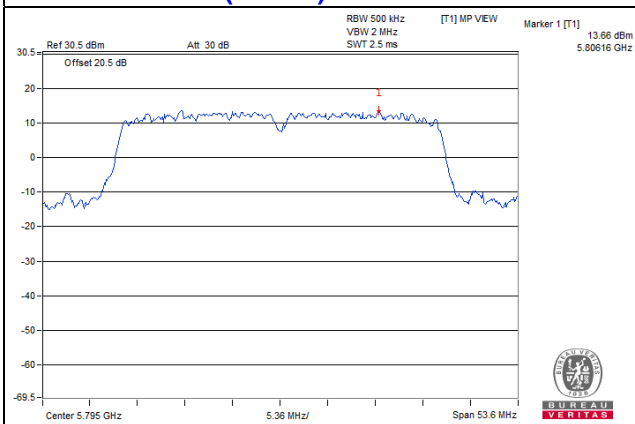

**802.11ac (80MHz) / Chain 0: CH155**

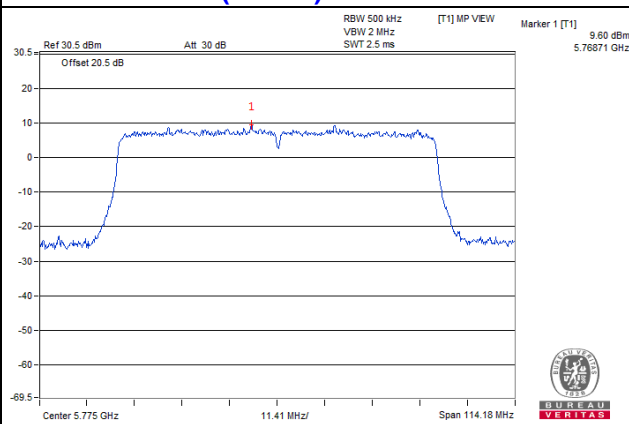

## 4.6 Frequency Stability Measurement

### 4.6.1 Limits of Frequency Stability Measurement

The frequency of the carrier signal shall be maintained within band of operation

### 4.6.2 Test Setup

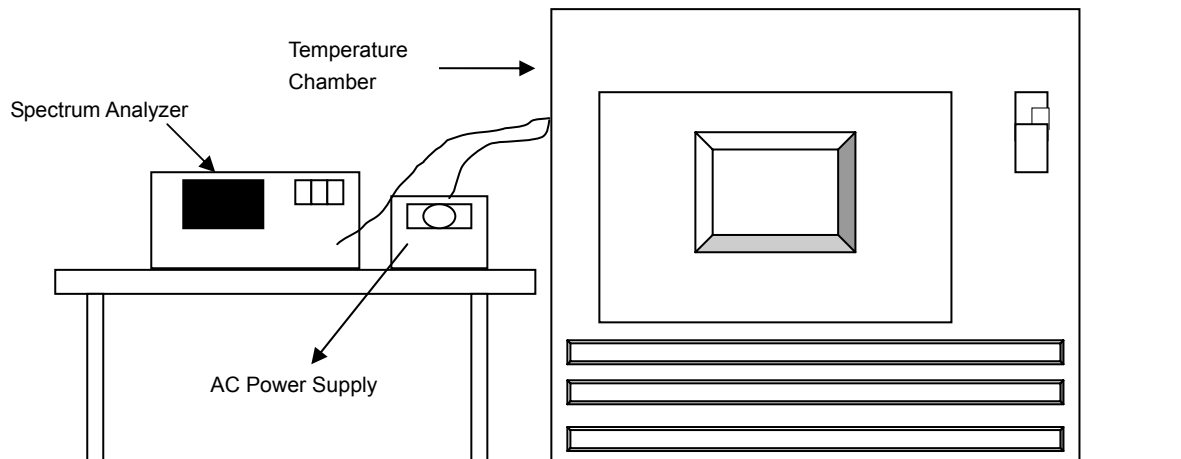

### 4.6.3 Test Instruments

Refer to section 4.1.2 to get information of above instrument.

### 4.6.4 Test Procedure

- The EUT was placed inside the environmental test chamber and powered by nominal AC voltage.
- Turn the EUT on and couple its output to a spectrum analyzer.
- Turn the EUT off and set the chamber to the highest temperature specified.
- Allow sufficient time (approximately 30 min) for the temperature of the chamber to stabilize, turn the EUT on and measure the operating frequency after 2, 5, and 10 Minutes.
- Repeat step 2 and 3 with the temperature chamber set to the lowest temperature.
- The test chamber was allowed to stabilize at +20 degree C for a minimum of 30 Minutes. The supply voltage was then adjusted on the EUT from 85% to 115% and the frequency record.

### 4.6.5 Deviation from Test Standard

No deviation.

### 4.6.6 EUT Operating Condition

Set the EUT transmit at un-modulation mode to test frequency stability.

## 4.6.7 Test Results

Frequency Stability Versus Temp.									
Operating Frequency: 5180 MHz									
TEMP. (°C)	Power Supply (Vac)	0 Minute		2 Minute		5 Minute		10 Minute	
		Measured Frequency (MHz)	Pass/Fail	Measured Frequency (MHz)	Pass/Fail	Measured Frequency (MHz)	Pass/Fail	Measured Frequency (MHz)	Pass/Fail
50	120	5180.041782	Pass	5180.042092	Pass	5180.042032	Pass	5180.041942	Pass
40	120	5180.043371	Pass	5180.043227	Pass	5180.043309	Pass	5180.04336	Pass
30	120	5180.04348	Pass	5180.043392	Pass	5180.043522	Pass	5180.043514	Pass
20	120	5180.04243	Pass	5180.042651	Pass	5180.042475	Pass	5180.042391	Pass
10	120	5180.042736	Pass	5180.042881	Pass	5180.042896	Pass	5180.04288	Pass
0	120	5180.043228	Pass	5180.043304	Pass	5180.043202	Pass	5180.043371	Pass
-10	120	5180.043278	Pass	5180.042996	Pass	5180.042802	Pass	5180.043046	Pass
-20	120	5180.0434	Pass	5180.043364	Pass	5180.043480	Pass	5180.043552	Pass

Frequency Stability Versus Voltage									
Operating Frequency: 5180 MHz									
TEMP. (°C)	Power Supply (Vac)	0 Minute		2 Minute		5 Minute		10 Minute	
		Measured Frequency (MHz)	Pass/Fail	Measured Frequency (MHz)	Pass/Fail	Measured Frequency (MHz)	Pass/Fail	Measured Frequency (MHz)	Pass/Fail
20	138	5180.043229	Pass	5180.043505	Pass	5180.043477	Pass	5180.043356	Pass
	120	5180.04243	Pass	5180.042651	Pass	5180.042475	Pass	5180.042391	Pass
	102	5180.043227	Pass	5180.043244	Pass	5180.043137	Pass	5180.043318	Pass

## 4.7 6dB Bandwidth Measurement

### 4.7.1 Limits of 6dB Bandwidth Measurement

The minimum of 6dB Bandwidth Measurement is 0.5MHz.

### 4.7.2 Test Setup

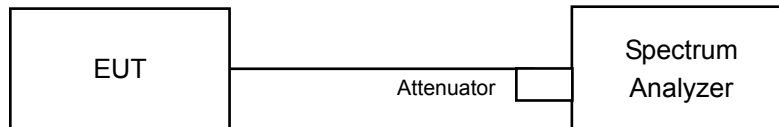

### 4.7.3 Test Instruments

Refer to section 4.1.2 to get information of above instrument.

### 4.7.4 Test Procedure

#### MEASUREMENT PROCEDURE REF

- a. Set resolution bandwidth (RBW) = 100kHz
- b. Set the video bandwidth (VBW)  $\geq 3 \times$  RBW, Detector = Peak.
- c. Trace mode = max hold.
- d. Sweep = auto couple.
- e. Measure the maximum width of the emission that is constrained by the frequencies associated with the two amplitude points (upper and lower) that are attenuated by 6 dB relative to the maximum level measured in the fundamental emission

### 4.7.5 Deviation from Test Standard

No deviation.

### 4.7.6 EUT Operating Condition

The software provided by client to enable the EUT under transmission condition continuously at lowest, middle and highest channel frequencies individually.

## 4.7.7 Test Results

**CDD Mode**
**802.11a**

Channel	Frequency (MHz)	6dB Bandwidth (MHz)		Minimum Limit (MHz)	Pass / Fail
		Chain 0	Chain 1		
149	5745	16.39	16.40	0.5	Pass
157	5785	16.40	16.40	0.5	Pass
165	5825	16.40	16.40	0.5	Pass

**802.11ac (20MHz)**

Channel	Frequency (MHz)	6dB Bandwidth (MHz)		Minimum Limit (MHz)	Pass / Fail
		Chain 0	Chain 1		
149	5745	17.62	17.61	0.5	Pass
157	5785	17.63	17.63	0.5	Pass
165	5825	17.63	17.62	0.5	Pass

**802.11ac (40MHz)**

Channel	Frequency (MHz)	6dB Bandwidth (MHz)		Minimum Limit (MHz)	Pass / Fail
		Chain 0	Chain 1		
151	5755	35.46	35.39	0.5	Pass
159	5795	35.73	35.26	0.5	Pass

**802.11ac (80MHz)**

Channel	Frequency (MHz)	6dB Bandwidth (MHz)		Minimum Limit (MHz)	Pass / Fail
		Chain 0	Chain 1		
155	5775	76.12	76.27	0.5	Pass

Spectrum Plot of Worst Value

802.11a / Chain 0: CH157

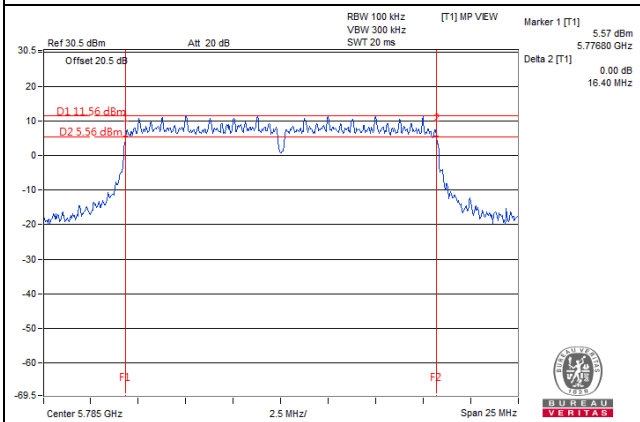

802.11ac (20MHz) / Chain 0: CH157

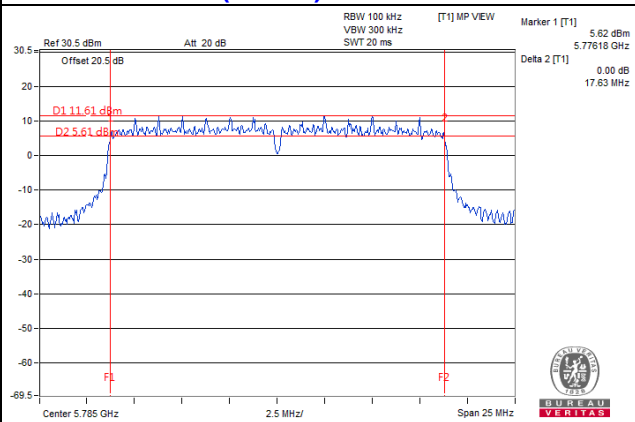

802.11ac (40MHz) / Chain 0: CH159

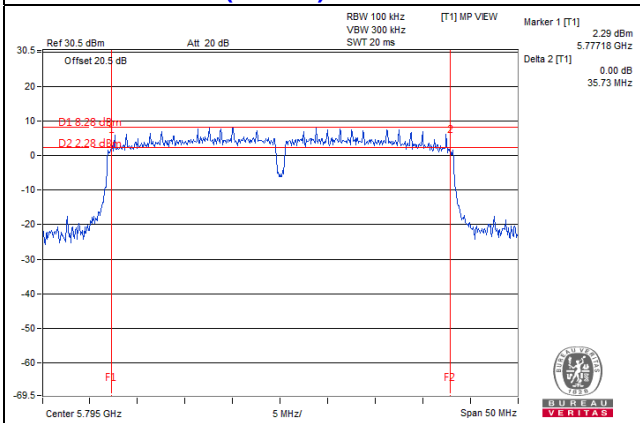

802.11ac (80MHz) / Chain 1: CH155

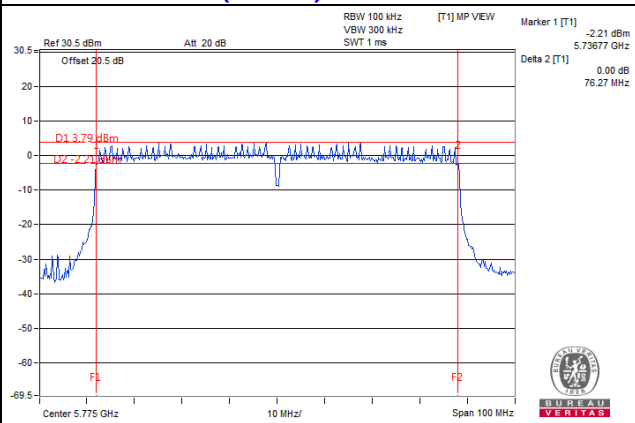

## 5 Pictures of Test Arrangements

Please refer to the attached file (Test Setup Photo).

### Annex A- Radiated Out of Band Emission (OOBE) Measurement (For U-NII-3 band)

**CDD Mode**

**802.11a**

**CH149**

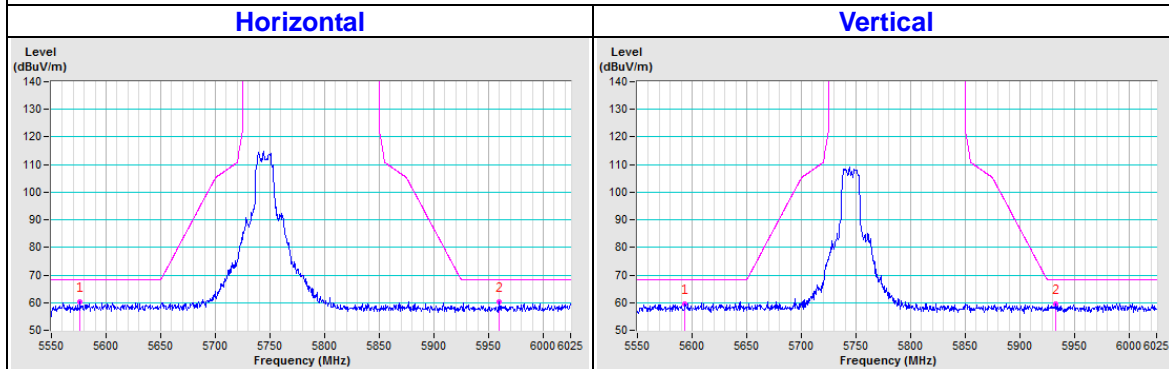

**CH157**

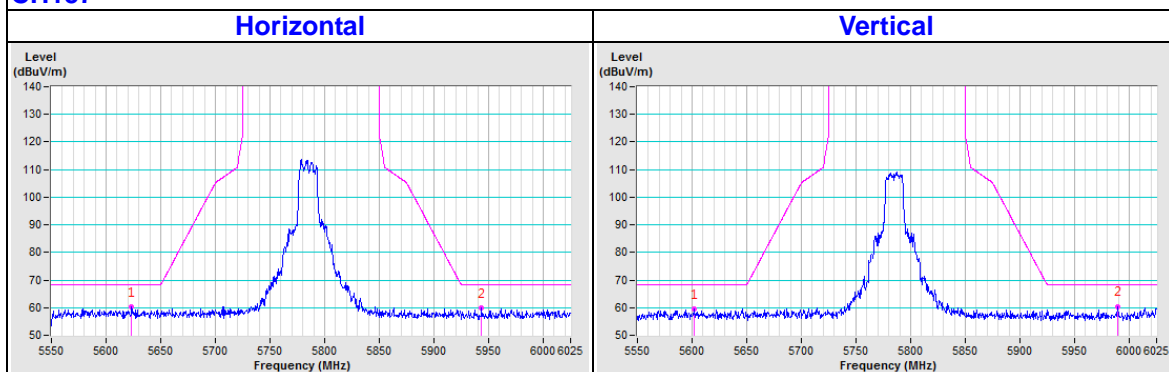

**CH165**

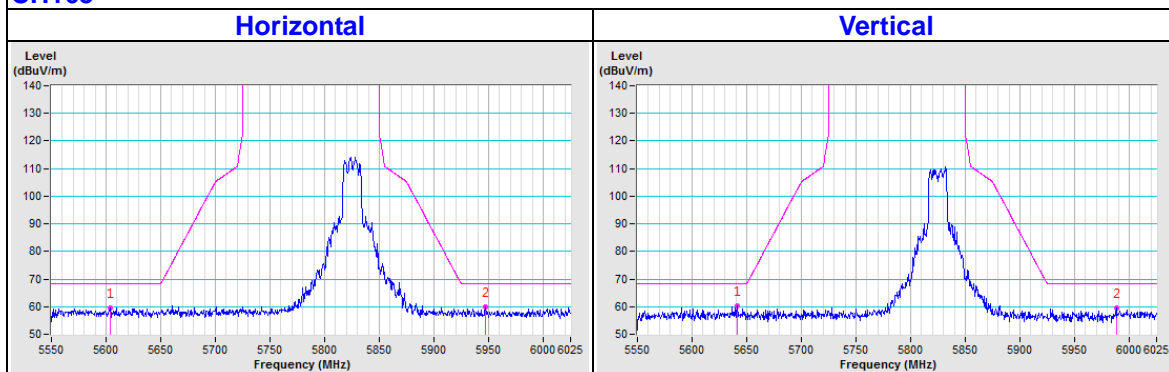



### 802.11ac (20MHz)

#### CH149

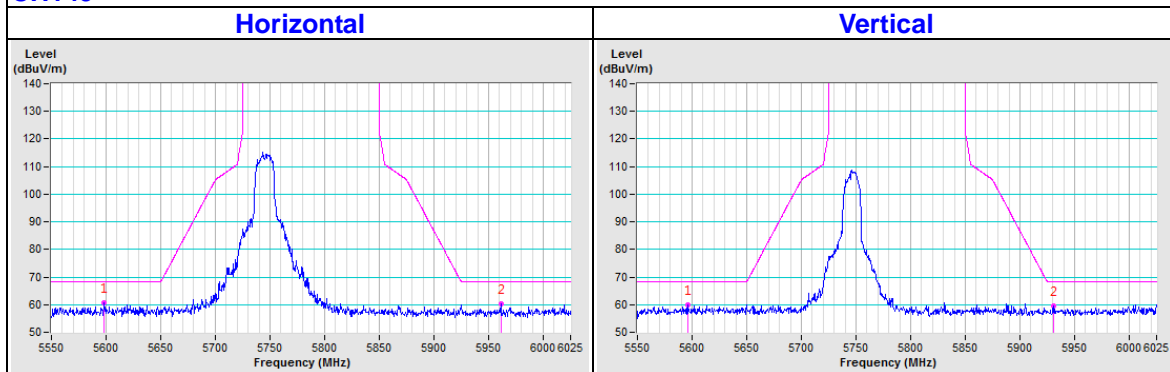

#### CH157

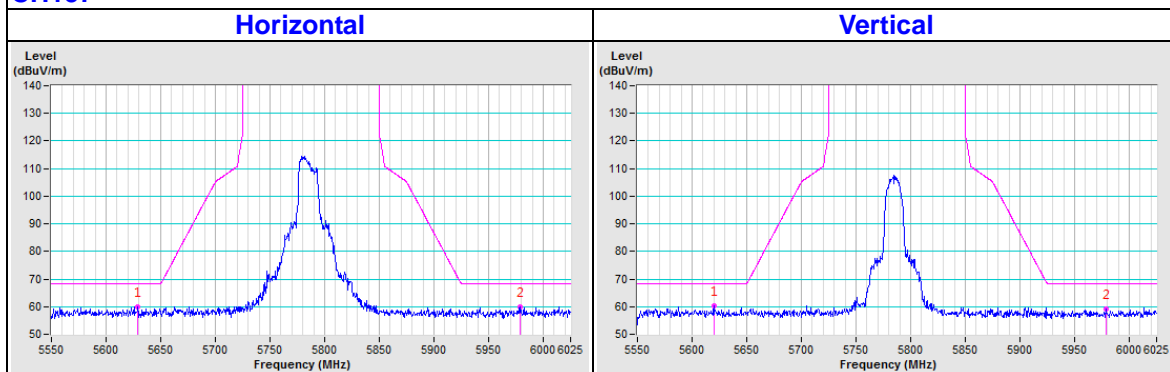

#### CH165

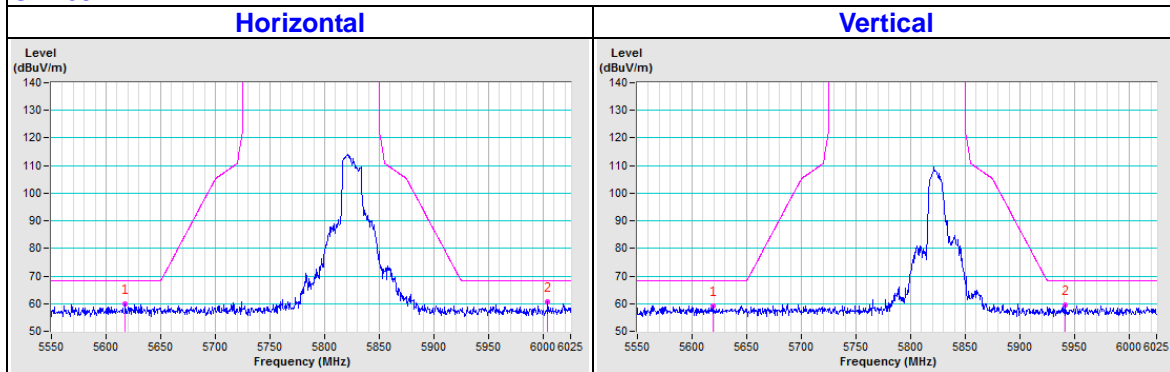

### 802.11ac (40MHz)

#### CH151

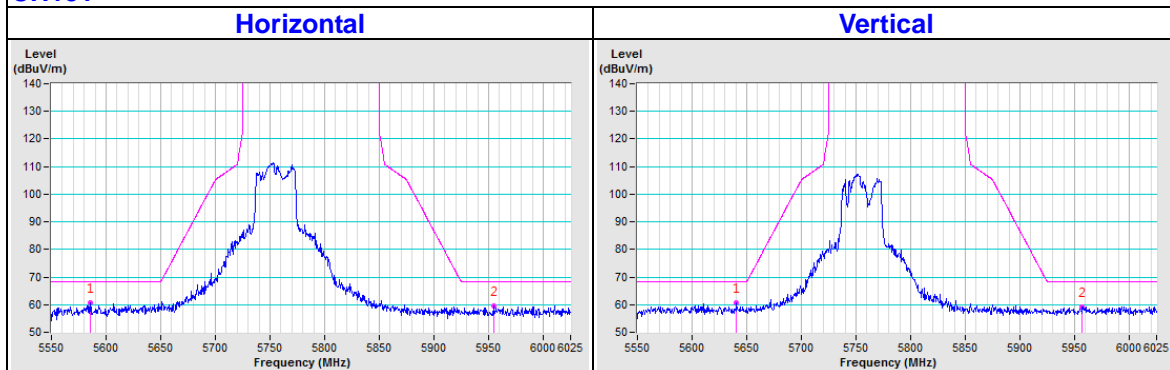

#### CH159

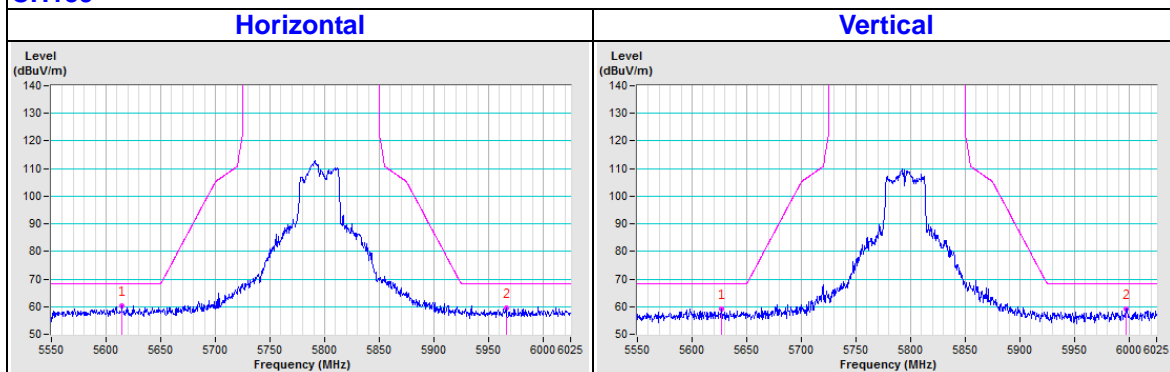

### 802.11ac (80MHz)

#### CH155

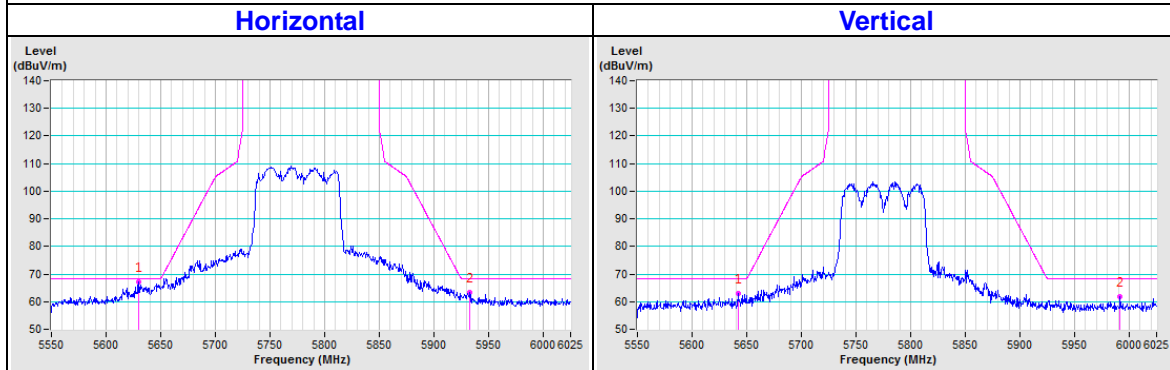

### Beamforming\_NSS1 Mode

802.11ac (20MHz)

CH149

Horizontal

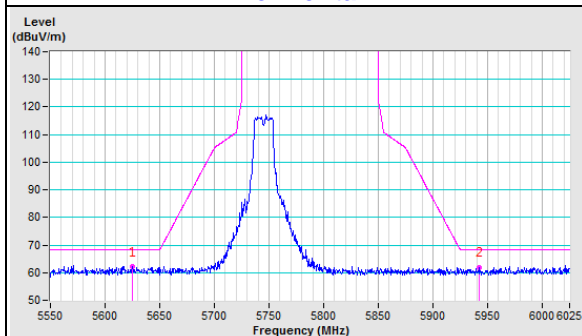

Vertical

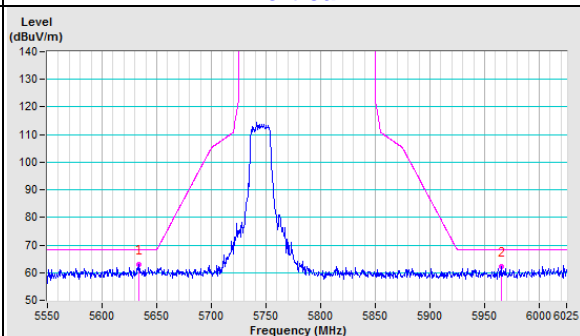

CH157

Horizontal

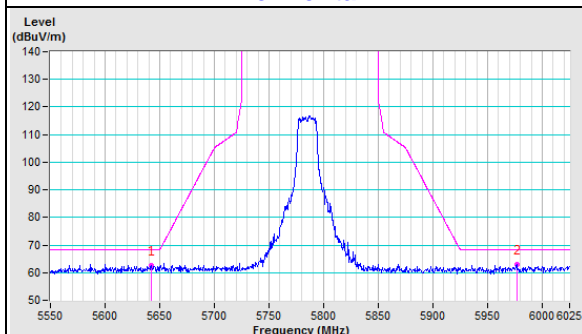

Vertical

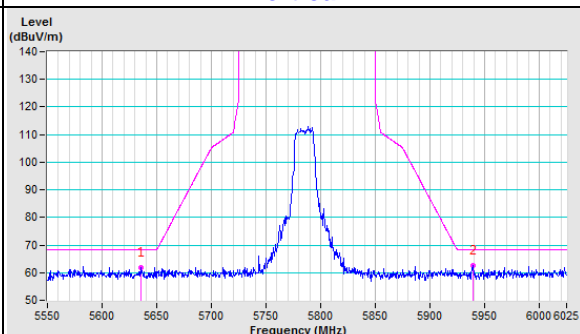

CH165

Horizontal

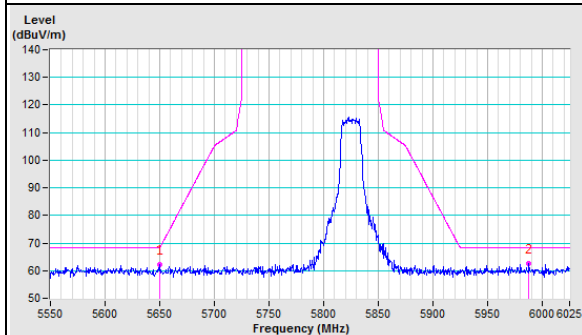

Vertical

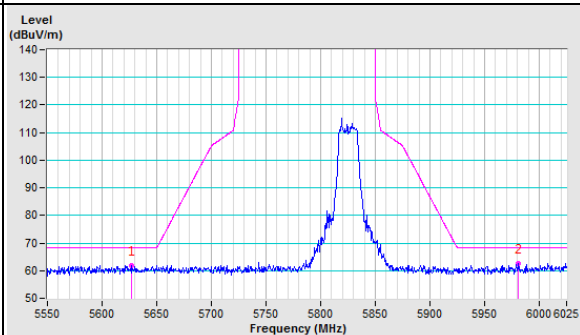

802.11ac (40MHz)

CH151

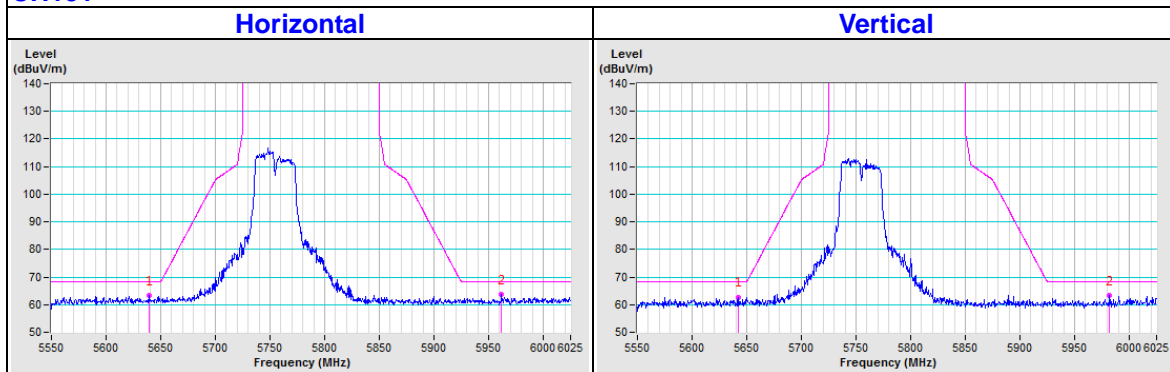

CH159

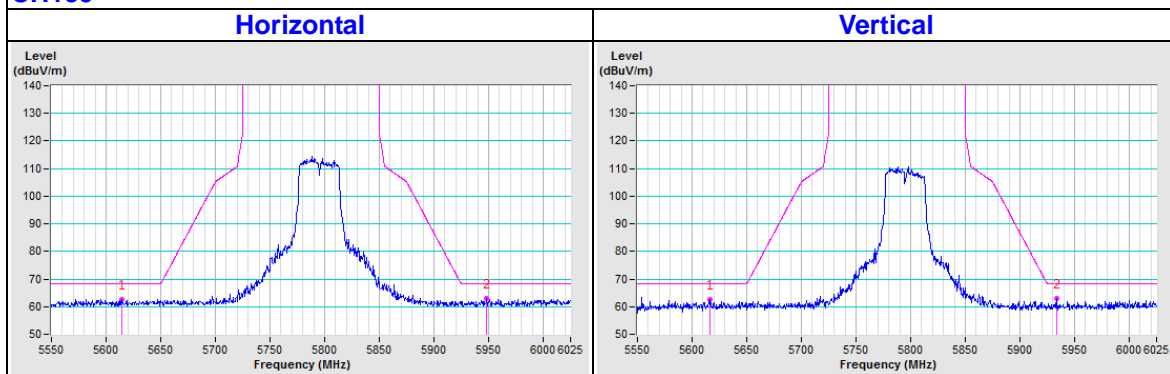

802.11ac (80MHz)

CH155

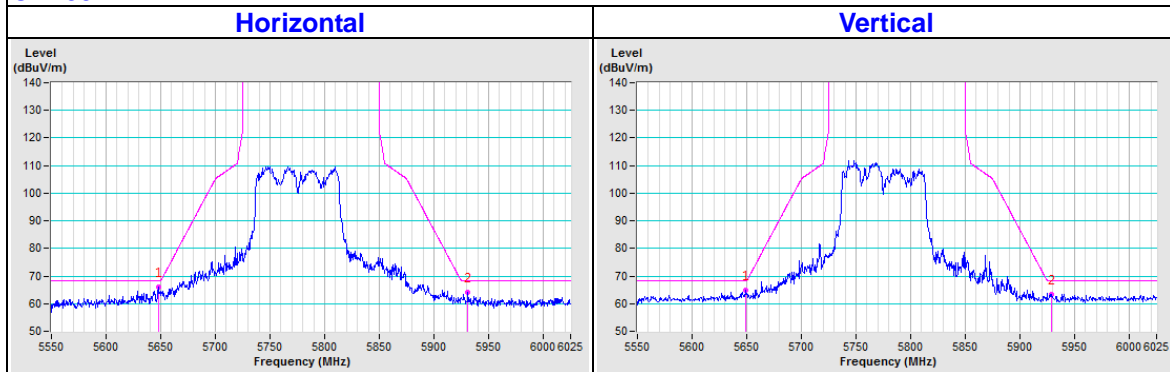

## Appendix – Information on the Testing Laboratories

We, Bureau Veritas Consumer Products Services (H.K.) Ltd., Taoyuan Branch, were founded in 1988 to provide our best service in EMC, Radio, Telecom and Safety consultation. Our laboratories are accredited and approved according to ISO/IEC 17025.

If you have any comments, please feel free to contact us at the following:

**Linko EMC/RF Lab**

Tel: 886-2-26052180

Fax: 886-2-26051924

**Hsin Chu EMC/RF/Telecom Lab**

Tel: 886-3-6668565

Fax: 886-3-6668323

**Hwa Ya EMC/RF/Safety Lab**

Tel: 886-3-3183232

Fax: 886-3-3270892

**Email:** [service.adt@tw.bureauveritas.com](mailto:service.adt@tw.bureauveritas.com)

**Web Site:** [www.bureauveritas-adt.com](http://www.bureauveritas-adt.com)

The address and road map of all our labs can be found in our web site also.

--- END ---