

Alcatel-Lucent Enterprise OmniAccess Stellar AP1251 Installation Guide

060492-10 Rev. A



enterprise.alcatel-lucent.com
Alcatel-Lucent and the Alcatel-Lucent Enterprise logo are trademarks of Alcatel-Lucent. To view other trademarks used by affiliated companies of ALE, visit: enterprise.alcatel-lucent.com/trademarks. All other trademarks are the property of their respective owners. The information presented is subject to ALE without notice. Neither ALE Holding nor any of its affiliates assumes any responsibility for inaccuracies contained herein. (2017)

1. Introduction

The high performance and rugged OAW-AP1251 supports IP67 standard for harsh outdoor environments, such as exposure to high and low temperatures, persistent moisture and precipitation, and electrical interfaces include industrial strength surge protection. The OAW-AP1251 supports a maximum concurrent data rate of 1.267Gbps (867Mbps in 5GHz and 400Mbps in 2.4GHz), and dual Gigabit Ethernet links, integrated omni-directional antennas, it is ideal for medium density outdoor environments.

1.1. Package Contents

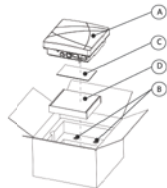

- A. OAW-AP1251 - Outdoor Access Point (AP)
B. Cable Gland x 2 pcs
C. Documents:
1) Installation Guide (this document)
2) Quick Start Guide
3) User Guide Info Card
4) Regulatory Compliance and Safety Information
D. Outdoor AP mounting kit package, which contains the following items

Table 1

Item	Description	Graphics	Qty
D1	Mounting bracket (D1)		1
D2	Mounting bracket (D2)		1

Item	Description	Graphics	Qty
D3	Mounting bracket (D3)		1
D4	Spacing tube		1
D5	Screw bolt M8 x 65		1
D6	Screw bolt M8 x 25		1
D7	Screw bolt M6 x 12		3
D8	Spring washer Ø8		2
D9	Spring washer Ø6		3
D10	Screw nut M8		2
D11	Locknut M8		2
D12	Hose clamp (102-152mm)		2
D13	Expansion bolt M6x60		4

NOTES :

- Component dimensions are in metric.
- The weatherproof caps for Ethernet and Console are connected to the AP, not loose in the package.
- Do not open or remove the Protective vents
- Inform your supplier if there are any incorrect, missing, or damaged parts. If possible, retain the cartons, including the original packing material. Use these materials to repack and return the unit to the supplier if needed.

1.2. Hardware Overview

- OAW-AP1251 Front View



Figure 2

- OAW-AP1251 Rear View

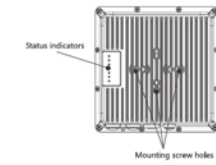

Figure 3

- OAW-AP1251 Bottom View

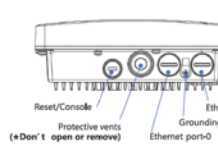

Figure 4

1.3. Pre-Installation Checklist

Before installing your OAW-AP1251, be sure that you have the materials and tools listed below :

- IEEE 802.3af compliant PoE source.
- Gigabit Ethernet cable of required length and RJ45 connector.
- Grounding wire #8AWG of required length.
- Tools:

- Ratchet wrench
- Hexagon sockets
- Screwdriver
- Rotary hammer
- Percussion bit Ø8
- Ratchet crimping pliers for non-insulated terminal
- Crimping too for RJ45 modular plug
- Ethernet cable tester
- Heat shrinkable tube
- Heat gun

1.4. Deployment Process Overview

The deployment of an Access Point typically consists of the following stages:

- WLAN Planning—The administrator determines how many APs will be needed for their wireless network strategy and where they will be deployed.
- AP Installation—Each AP can be physically installed at proper location. Each location should be as close as possible to the center of the intended coverage area and should be free from obstructions or obvious sources of interference.
- AP Configuration—The administrator defines the operational behavior for each AP, such as RF characteristics and security features.

NOTES:

- Installing the Outdoor Access Point requires professional training. The AP must be professionally installed by a qualified engineer familiar with WLAN system.
- For AP configuration information, please refer to the User Guide.

2. Installing the AP

2.1. Using the Mounting Kits

2.1.1. Assembling Access Point(A) with Mounting bracket(D1), to get Subassembly (E1)

2.1.1.1. Materials Preparation

Table 2

Item	Description	Graphics	Qty
A	Access Point OAW-AP1251		1
D1	Mounting bracket (D1)		1
D7	Screw bolt M6 x 12		3
D9	Spring washer Ø6		3

2.1.1.2. Assembly Processes

Step-1. Connecting the AP(A) with Mounting bracket(D1)

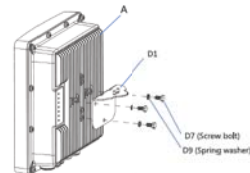

Step-2. Get Subassembly(E1)

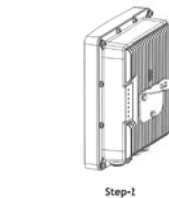

Note :

- Must use a proper Ratchet wrench to tighten the Screw bolt(D7)

2.1.2. Assembling Mounting bracket(D2) with bracket(D3), to get Subassembly(E2)

2.1.2.1. Materials Preparation

Table 3

Item	Description	Graphics	Qty
D2	Mounting bracket(D2)		1
D3	Mounting bracket(D3)		1
D4	Spacing tube		1
D5	Screw bolt M8 x 65		1
D8	Spring washer Ø8		1
D10	Screw nut M8		1
D11	Locknut M8		1

2.1.2.2. Assembly Processes

Step-3. Insert the Mounting bracket (D2) into bracket (D3), and align Mounting bolt hole(A) with Mounting bolt hole(B).

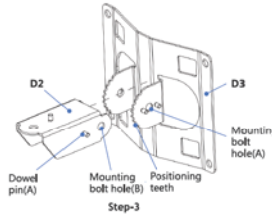

Step-4. To get a required installation angle of pitch, adjusting the Dowel pin(A) on Bracket(D2) to match up with the Positioning teeth of Mounting bracket(D3)

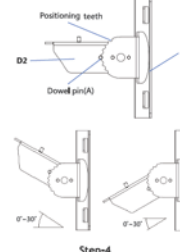

Step-5. Insert the Spacing tube (D4) into bracket (D2), align the hole of the tube (D4) with the Mounting bolt hole (B) of bracket (D2).

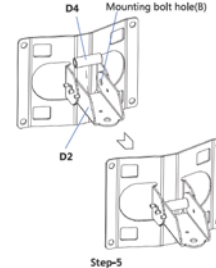

Step-6. From the side of bracket (D3), where Dowel pin (B) stands, put the Screw bolt (D5) through the Mounting bolt hole(A) and stick out at the other side. Make sure the Screw bolt goes through Mounting bracket(D3), bracket(D2) and Spacing tube(D4) in sequence. Then put a Spring washer (D8) and a Screw nut (D10) on it in sequence. Finally, tighten the Screw nut (D10) with ratchet wrench.

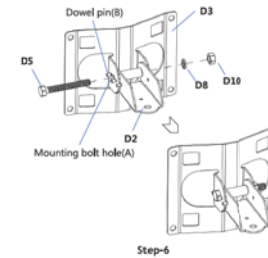

Step-7. To prevent the screw nut from loosening and for better reliability, put a Locknut(D11) on the end of the Screw bolt(D5). Then tighten it up with ratchet wrench.

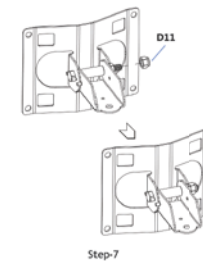

Note :

- Must use a proper Ratchet wrench to tighten the Screw nut(D10) and the Locknut(D11)

Step-8. Get Subassembly (E2)

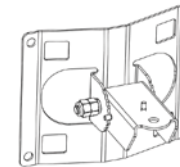

2.1.3. Assembling Subassembly(E1) with Subassembly(E2), to get Final-Assembly (F)

2.1.3.1. Materials Preparation

Table 4

Item	Description	Graphics	Qty
E1	Subassembly (E1)		1
E2	Subassembly (E2)		1
D6	Screw bolt M8 x 25		1
D8	Spring washer Ø8		1
D10	Screw nut M8		1

Item	Description	Graphics	Qty
D11	Locknut M8		1

2.1.3.2. Assembly Processes

Step-9. Overlap Subassembly (E1) to Subassembly (E2), align the Mounting bolt hole(C) with Mounting bolt hole(D).

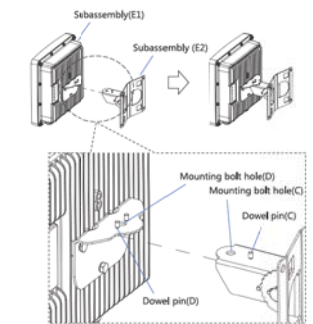

Step-10. To get a required horizontal angle, adjusting the Dowel pin(C) on Bracket(D2) to match up with the Positioning teeth of Bracket (D1).

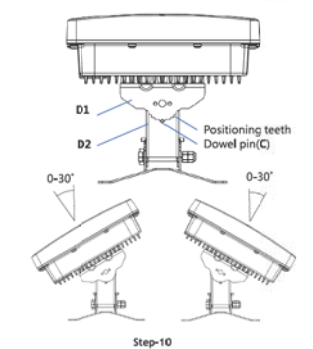

Step-11. From the side of Bracket (D1), where Dowel pin (B) stands, put the Screw bolt (D6) through the Mounting bolt hole(D) and stick out at the other side. Make sure the Screw bolt goes through Mounting bracket(D1) and bracket(D2). Then put a Spring washer (D8) and a Screw nut (D10) on it in sequence. Finally, tighten the Screw nut (D10) with ratchet wrench.

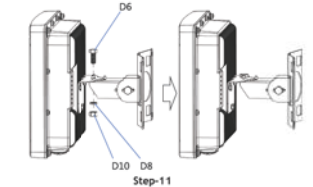

Step-12. To prevent the screw nut from loosening and for better reliability, put a Locknut (D11) on the end of the Screw bolt(D6). Then tighten it up with ratchet wrench

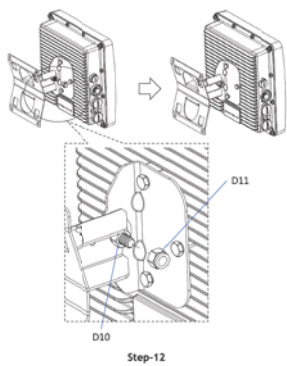

Step-12

- Note :
- Must use a proper Ratchet wrench to tighten the Screw nut(D10) and the Locknut(D11)

Step-13. Final assembly (F)

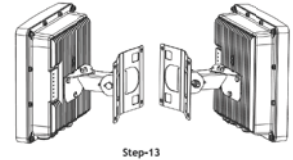

Step-13

2.2. Mounting the AP to a Pole or a Wall

The OmniAccess Stellar AP1251 is for outdoor deployment, it can be mounted to a pole or a wall by using the accessories in the mounting kit package.

2.2.1. Pole Mounting

2.2.1.1. Materials Preparation

Table 5

Item	Description	Graphics	Qty
F	Final assembly (F)		1
D12	Hose clamp		2

2.2.1.2. Mounting Processes

Step-14. Threading the Hose clamps(D12) through the square mounting holes in bracket (D3) separately. The direction of the screw head on the hose clamp should be determined before you thread.

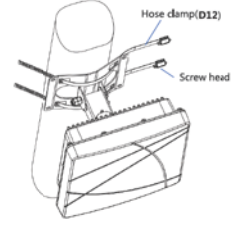

Step-14

Step-15. Mounting to a pole

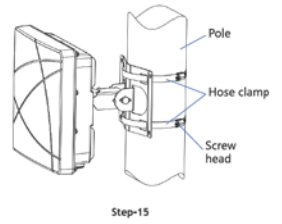

Step-15

Caution :

- Use caution to prevent hand injury!
- For safety, the stencil area in steel belt of the hose clamps(D12) should avoid overlapping the edge of square mounting holes on bracket (D3).

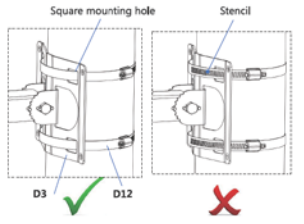

2.2.2. Wall Mounting

2.2.2.1. Materials Preparation

Table 6

Item	Description	Graphics	Qty
F	Final assembly (F)		1
D13	Expansion bolt M6 x 60		4

2.2.2.2. Mounting Processes

Step-16. Draw four center marks on the wall where is planned to mount the outdoor AP. And then drill four Ø8x45 mm holes on the wall for expansion bolts.

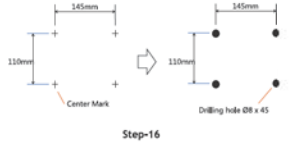

Step-16

Step-17. Insert 4 Expansion bolts(D13) into the holes on the wall separately. Make sure that the end of the expansion tube should be coplanar to wall surface.

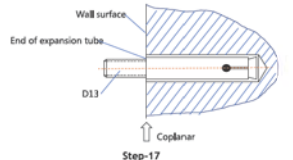

Step-17

Step-18. Put the 4 expansion bolts through the 4 mounting holes in bracket(D3). Then put a flat washer, a spring washer and a screw nut on each expansion bolt in sequence. Finally, tighten the 4 screw nuts with ratchet wrench.

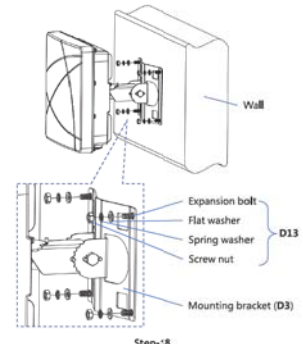

Step-18

2.3. Grounding the AP

Never forget to protect the AP by installing grounding wire. The grounding must be completed before powering up the AP.

2.3.1. Grounding Preparation

Step-19. Unscrew the O-Terminal from the AP and keep it with the Assembled bolt.

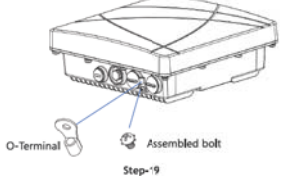

Step-19

2.3.2. Crimping the Grounding wire

Step-20. Peel the cover of one end of the grounding wire and place the bare grounding wire into the O-Terminal, and press firmly with the crimping pliers. A heat shrinkable tube is suggested to cover the connection.

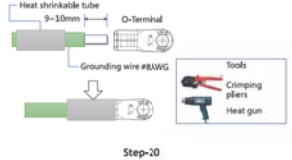

Step-20

2.3.3. Connecting the Grounding Wire

Step-21. Fasten the O-Terminal to the grounding hole on the AP with the Assembled bolt. Consider the pole mounting circumstances, an example is shown in figure (Step-21).

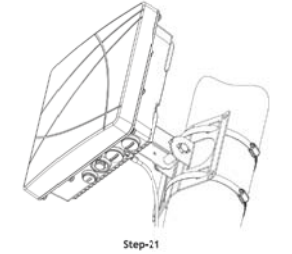

Step-21

2.4. Connecting the Ethernet Cable

To connect the Ethernet cable to the AP, perform the following steps using the Cable glands(B) that ship with your AP.

2.4.1. The Cable Gland(B)

The Cable gland(B) is composed of 5 elements, which are Sealing nut(B1), Clamping ring(B2), Seals(B3), Gland body(B4) and O-ring(B5)

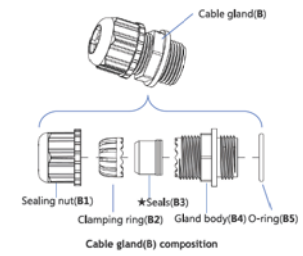

★ The Seals(B3) inside the Cable gland(B) by factory default is applicable for cables with 4-6mm diameter. In the cable gland kit, another seal is provided for use with cable with 6-10mm diameter.



2.4.2. Crimping the Ethernet cable

Step-22. The following figure shows the process of crimping an Ethernet cable.

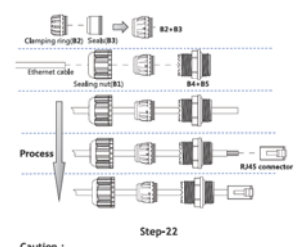

Step-22

Caution :

- Do not peel the cover of the Ethernet cable or attach the RJ45 connector to the cable before sliding the Cable gland(B) over the cable.
- Failure to use the included Ethernet cable glands can lead to product issues.

2.4.3. Remove the Weatherproof Cap

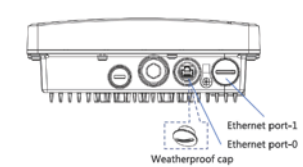

Note :

- Keep the weatherproof caps on the AP tightly while not using the related ports.

2.4.4. Connecting the cable

Step-23. Connect the Uplink Ethernet cable, which will be powered up and was crimped in Step-22, to either Ethernet Port-0 or Ethernet Port-1. And then, screw the Gland body(B4+B5) onto the Ethernet port with proper wrench.

Step-24. Connect the Seals with Clamping ring(B2+B3) to the Gland body(B4), and then screw the Sealing nut(B1) onto the Gland body(B4) and tighten it firmly.

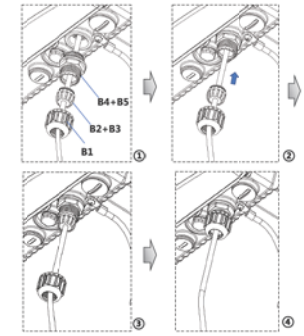

Step-23 & Step-24

Caution :

- Do not screw the Sealing nut(B1) onto the Gland body(B4) before connecting the RJ45 connector to the Ethernet port.
- Must use a proper wrench to tighten the Gland body.

2.5. Powering up the AP by PoE Source

Step-25. The OAW-AP1251 supports IEEE 802.3af Compliant PoE source, accepting 48V DC(Nominal). A PoE injector as an example is shown in the following figure.

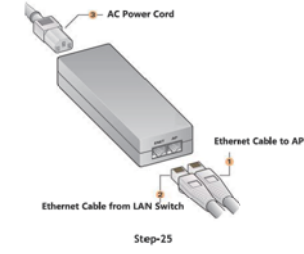

Step-25

3. Product Specifications

3.1. Dimensions/weight

- Single AP excluding packing box and accessories: 243mm (W) x 243mm (D) x 85mm (H) / 2230g.

3.2. Interfaces

3.2.1. Ports List

Table 7

Item Name	Description
=ENET0	1x10/100/1000Base-T auto-sensing (RJ-45) port, Power over Ethernet (PoE)
=ENET1	1x 10/100/1000Base-T auto-sensing (RJ-45) port , Power over Ethernet (PoE)
+Console Port	1x management console port (Micro-USB)
+Reset Button	Factory reset, for more information, refer to datasheet.

- Either ENET0 or ENET1 supports PoE source. If both ports are connected to PoE source, the PoE function will only be activated in the first connected port.
- Unscrew the smaller weatherproof cap on the left side in Bottom View of AP, you can see the Micro-USB console port and the reset button as shown in the following figure.

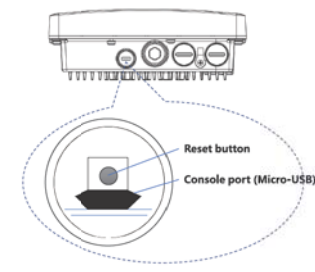

3.2.2. Ethernet Port Pin-outs

The Ethernet Ports of the OAW-AP1251 have RJ-45 female connectors with pin-outs shown in Table 8.

Table 8

Ethernet Port / RJ45 Female	Pin	Signal Name	Function
	1	BI_DA+	Bi-directional pair +A, PoE Negative
	2	BI_DA-	Bi-directional pair -A, PoE Negative
	3	BI_DB+	Bi-directional pair +B, PoE Positive
	4	BI_DC+	Bi-directional pair +C, PoE Positive
	5	BI_DC-	Bi-directional pair -C, PoE Positive
	6	BI_DB-	Bi-directional pair -B, PoE Positive
	7	BI_DD+	Bi-directional pair +D, PoE Negative
	8	BI_DD-	Bi-directional pair -D, PoE Negative

3.3. Power

- Maximum (worst case) power consumption: <11.8W (802.3af PoE)

3.4. Environmental

- Protective level of enclosure: IP67
- Operating Temperature: -40°C to 65°C Humidity: 5% to 95% non-condensing
- Storage and transportation Temperature: -40°C to 85°C

For additional specifications on this product, please refer to the Data Sheet.

Contacting Alcatel-Lucent Enterprise

Website Support	
Main Site	http://enterprise.alcatel-lucent.com
Support Site	http://support.esd.alcatel-lucent.com
Telephone Support	
North America	1-800-995-2696
Latin America	1-877-919-9526
Europe	+800 00200100 (Toll Free) or +1(650)385-2193
Asia Pacific	+65 6240 8484
Other Region	1-818-878-4507