

FCC Test Report

Report No.: RF170918D11A-2

FCC ID: 2AI9TOAW-AP123X

Test Model: OAW-AP1231, OAW-AP1232

Received Date: Jul. 20, 2017

Test Date: Sep. 13 ~ Oct. 27, 2017

Issued Date: Mar. 22, 2018

Applicant: ALE USA Inc.

Address: 26801 West Agoura Road, Calabasas, CA 91301

Issued By: Bureau Veritas Consumer Products Services (H.K.) Ltd., Taoyuan Branch

Lab Address: No. 47-2, 14th Ling, Chia Pau Vil., Lin Kou Dist., New Taipei City, Taiwan (R.O.C.)

**FCC Registration /
Designation Number:** 198487 / TW2021



This report is for your exclusive use. Any copying or replication of this report to or for any other person or entity, or use of our name or trademark, is permitted only with our prior written permission. This report sets forth our findings solely with respect to the test samples identified herein. The results set forth in this report are not indicative or representative of the quality or characteristics of the lot from which a test sample was taken or any similar or identical product unless specifically and expressly noted. Our report includes all of the tests requested by you and the results thereof based upon the information that you provided to us. You have 60 days from date of issuance of this report to notify us of any material error or omission caused by our negligence, provided, however, that such notice shall be in writing and shall specifically address the issue you wish to raise. A failure to raise such issue within the prescribed time shall constitute your unqualified acceptance of the completeness of this report, the tests conducted and the correctness of the report contents. Unless specific mention, the uncertainty of measurement has been explicitly taken into account to declare the compliance or non-compliance to the specification. The report must not be used by the client to claim product certification, approval, or endorsement by TAF or any government agencies.

Table of Contents

Release Control Record	4
1 Certificate of Conformity	5
2 Summary of Test Results	6
2.1 Measurement Uncertainty	6
2.2 Modification Record	6
3 General Information	7
3.1 General Description of EUT	7
3.2 Description of Test Modes	10
3.2.1 Test Mode Applicability and Tested Channel Detail	11
3.3 Duty Cycle of Test Signal	13
3.4 Description of Support Units	14
3.4.1 Configuration of System under Test	14
3.5 General Description of Applied Standard	15
4 Test Types and Results	16
4.1 Radiated Emission and Bandedge Measurement.....	16
4.1.1 Limits of Radiated Emission and Bandedge Measurement	16
4.1.2 Test Instruments	17
4.1.3 Test Procedure	18
4.1.4 Deviation from Test Standard	19
4.1.5 Test Setup.....	19
4.1.6 EUT Operating Condition	20
4.1.7 Test Results	21
4.2 Conducted Emission Measurement	97
4.2.1 Limits of Conducted Emission Measurement	97
4.2.2 Test Instruments	97
4.2.3 Test Procedure	98
4.2.4 Deviation from Test Standard	98
4.2.5 Test Setup.....	98
4.2.6 EUT Operating Condition	98
4.2.7 Test Results	99
4.3 Transmit Power Measurement	101
4.3.1 Limits of Transmit Power Measurement	101
4.3.2 Test Setup.....	102
4.3.3 Test Instruments	102
4.3.4 Test Procedure	103
4.3.5 Deviation from Test Standard	103
4.3.6 EUT Operating Condition	103
4.3.7 Test Result.....	104
4.4 Occupied Bandwidth Measurement	120
4.4.1 Test Setup.....	120
4.4.2 Test Instruments	120
4.4.3 Test Procedure	120
4.4.4 Test Results	121
4.5 Peak Power Spectral Density Measurement.....	125
4.5.1 Limits of Peak Power Spectral Density Measurement	125
4.5.2 Test Setup.....	125
4.5.3 Test Instruments	125
4.5.4 Test Procedure	125
4.5.5 Deviation from Test Standard	125
4.5.6 EUT Operating Condition	125
4.5.7 Test Results	126
4.6 Frequency Stability Measurement.....	132

4.6.1	Limits of Frequency Stability Measurement.....	132
4.6.2	Test Setup.....	132
4.6.3	Test Instruments	132
4.6.4	Test Procedure	132
4.6.5	Deviation from Test Standard	132
4.6.6	EUT Operating Condition	132
4.6.7	Test Results	133
5	Pictures of Test Arrangements.....	134
	Appendix – Information on the Testing Laboratories	135

Release Control Record

Issue No.	Description	Date Issued
RF170918D11A-2	Original release.	Mar. 22, 2018

1 Certificate of Conformity

Product: OmniAccess Stellar

Brand: Alcatel-Lucent Enterprise

Test Model: OAW-AP1231, OAW-AP1232

Sample Status: Engineering sample

Applicant: ALE USA Inc.

Test Date: Sep. 13 ~ Oct. 27, 2017

Standard: 47 CFR FCC Part 15, Subpart E (Section 15.407)
ANSI C63.10: 2013

The above equipment has been tested by **Bureau Veritas Consumer Products Services (H.K.) Ltd., Taoyuan Branch**, and found compliance with the requirement of the above standards. The test record, data evaluation & Equipment Under Test (EUT) configurations represented herein are true and accurate accounts of the measurements of the sample's RF characteristics under the conditions specified in this report.

Prepared by :



Date:

Mar. 22, 2018

Jessica Cheng / Senior Specialist

Approved by :



Date:

Mar. 22, 2018

Rex Lai / Associate Technical Manager

2 Summary of Test Results

47 CFR FCC Part 15, Subpart E (Section 15.407)			
FCC Clause	Test Item	Result	Remarks
15.407(b)(6)	AC Power Conducted Emissions	Pass	Meet the requirement of limit. Minimum passing margin is -2.31dB at 0.35703MHz.
15.407(b) (1/2/3/4(i/ii)/6)	Radiated Emissions & Band Edge Measurement	Pass	Meet the requirement of limit. Minimum passing margin is -1.01dB at 5725.00MHz.
15.407(a)(1/2/3)	Max Average Transmit Power	Pass	Meet the requirement of limit.
---	Occupied Bandwidth Measurement	-	Reference only.
15.407(a)(1/2/3)	Peak Power Spectral Density	Pass	Meet the requirement of limit.
15.407(g)	Frequency Stability	Pass	Meet the requirement of limit.
15.203	Antenna Requirement	Pass	Antenna connector is R-SMA or I-PEX not a standard connector.

2.1 Measurement Uncertainty

Where relevant, the following measurement uncertainty levels have been estimated for tests performed on the EUT as specified in CISPR 16-4-2:

Measurement	Frequency	Expanded Uncertainty (k=2) (±)
Conducted Emissions at mains ports	150kHz ~ 30MHz	2.77 dB
Radiated Emissions up to 1 GHz	9kHz ~ 30MHz	2.38 dB
	30MHz ~ 1000MHz	5.54 dB
Radiated Emissions above 1 GHz	1GHz ~ 6GHz	4.77 dB
	6GHz ~ 18GHz	5.48 dB

2.2 Modification Record

There were no modifications required for compliance.

3 General Information

3.1 General Description of EUT

Product	OmniAccess Stellar
Brand	Alcatel-Lucent Enterprise
Test Model	OAW-AP1231, OAW-AP1232
Model Difference	Refer to note as below
Status of EUT	Engineering sample
Power Supply Rating	48Vdc from Adapter or 55Vdc from PoE
Modulation Type	64QAM, 16QAM, QPSK, BPSK 256QAM for OFDM in 11ac mode only.
Modulation Technology	OFDM
Transfer Rate	802.11a: 54/48/36/24/18/12/9/6Mbps 802.11n: up to 800Mbps 802.11ac: up to 1733Mbps
Operating Frequency	5260 ~ 5320MHz, 5500 ~ 5700MHz
Number of Channel	5260 ~ 5320MHz: 4 for 802.11a, 802.11n (20MHz), 802.11ac (20MHz) 2 for 802.11n (40MHz), 802.11ac (40MHz) 1 for 802.11ac (80MHz) 5500 ~ 5700MHz 11 for 802.11a, 802.11n (20MHz), 802.11ac (20MHz) 5 for 802.11n (40MHz), 802.11ac (40MHz) 2 for 802.11ac (80MHz)
Output Power	5260 ~ 5320MHz: 69.004mW 5500 ~ 5700MHz: 214.089mW
Antenna Type	Refer to note as below
Antenna Connector	Refer to note as below
Accessory Device	N/A
Data Cable Supplied	N/A

Note:

1. This report is issued as a supplementary report to BV CPS report no. RF170918D11-2. The difference compared with original report is adding U-NII-2A, U-NII-2C band, therefore the EUT is re-tested in this report.
2. This report is prepared for FCC class II permissive change.
3. All models are listed as below.

Brand	Model	Difference
Alcatel-Lucent Enterprise	OAW-AP1231	Internal PIFA antenna for Bluetooth function, and internal PIFA antenna for WLAN function
	OAW-AP1232	Internal PIFA antenna for Bluetooth function, and external Dipole antenna for WLAN function

4. The EUT incorporates a MIMO function. Physically, the EUT provides four completed transmitters and four receivers.

Modulation Mode	TX FUNCTION
802.11a	4TX
802.11n (20MHz)	4TX
802.11n (40MHz)	4TX
802.11ac (20MHz)	4TX
802.11ac (40MHz)	4TX
802.11ac (80MHz)	4TX

* The modulation and bandwidth are similar for 802.11n mode for 20MHz / 40MHz and 802.11ac mode for 20MHz / 40MHz, therefore investigated worst case to representative mode in test report. (Final test mode refer section 3.2.1)

5. For Radiated test, the EUT was pre-tested with the following modes:

- ✧ Operating Mode, Powered from Adapter
- ✧ Operating Mode, Powered from PoE

The worst emission level was found when the EUT tested under **Operating Mode, Powered from Adapter**, therefore, only its test data was recorded in this report.

6. For Conducted test, the EUT was pre-tested with the following modes:

- ✧ Operating Mode, Model: OAW-AP1231, Powered from Adapter
- ✧ Operating Mode, Model: OAW-AP1232, Powered from Adapter
- ✧ Operating Mode, Model: OAW-AP1231, Powered from PoE
- ✧ Operating Mode, Model: OAW-AP1232, Powered from PoE

The worst emission level was found when the EUT tested under **Operating Mode, Model: OAW-AP1231, Powered from Adapter**, therefore, only its test data was recorded in this report.

7. The antennas provided to the EUT, please refer to the following table:

Model of EUT	Antenna	Frequency	Chain No.	Antenna Type	Antenna Gain (dBi)	Connector Type
OAW-AP1231	Internal	5GHz	Chain 0	PIFA	4.46	I-PEX
			Chain 1	PIFA	4.22	I-PEX
			Chain 2	PIFA	4.17	I-PEX
			Chain 3	PIFA	*4.47	I-PEX
			Chain 4	PIFA	4.41	I-PEX
			Chain 5	PIFA	4.30	I-PEX
			Chain 6	PIFA	4.43	I-PEX
			Chain 7	PIFA	4.13	I-PEX
OAW-AP1232	External	5GHz	Chain 0	Dipole	6	R-SMA
			Chain 1	Dipole	6	R-SMA
			Chain 2	Dipole	6	R-SMA
			Chain 3	Dipole	6	R-SMA
			Chain 4	Dipole	6	R-SMA
			Chain 5	Dipole	6	R-SMA
			Chain 6	Dipole	6	R-SMA
			Chain 7	Dipole	6	R-SMA

* As client's request, the 4.47dBi of Internal max. gain is chosen for final tests since it has the maximum gain among Internal antennas.

8. The directional gain table:

Antenna	Max. Gain (dBi)
Internal	10.49
External	12.02

Note:

(i) If transmit signals are *correlated*, then

Directional gain = $10 \log[(10^{G_1/20} + 10^{G_2/20} + \dots + 10^{G_N/20})^2 / N_{ANT}]$ dBi [Note the “20”s in the denominator of each exponent and the square of the sum of terms; the object is to combine the signal levels coherently.]

9. The above EUT information is declared by manufacturer and for more detailed features description, please refer to the manufacturer's specifications or user's manual.

3.2 Description of Test Modes

FOR 5260 ~ 5320MHz

4 channels are provided for 802.11a, 802.11n (20MHz), 802.11ac (20MHz):

Channel	Frequency	Channel	Frequency
52	5260 MHz	60	5300 MHz
56	5280 MHz	64	5320 MHz

2 channels are provided for 802.11n (40MHz), 802.11ac (40MHz):

Channel	Frequency	Channel	Frequency
54	5270 MHz	62	5310 MHz

1 channel is provided for 802.11ac (80MHz):

Channel	Frequency
58	5290MHz

FOR 5500 ~ 5700MHz

11 channels are provided for 802.11a, 802.11n (20MHz), 802.11ac (20MHz):

Channel	Frequency	Channel	Frequency
100	5500 MHz	124	5620 MHz
104	5520 MHz	128	5640 MHz
108	5540 MHz	132	5660 MHz
112	5560 MHz	136	5680 MHz
116	5580 MHz	140	5700 MHz
120	5600 MHz		

5 channels are provided for 802.11n (40MHz), 802.11ac (40MHz):

Channel	Frequency	Channel	Frequency
102	5510 MHz	126	5630 MHz
110	5550 MHz	134	5670 MHz
118	5590 MHz		

2 channels are provided for 802.11ac (80MHz):

Channel	Frequency	Channel	Frequency
106	5530MHz	122	5610 MHz

3.2.1 Test Mode Applicability and Tested Channel Detail

EUT Configure Mode	Applicable To				Description
	RE≥1G	RE<1G	PLC	APCM	
A	√	√	√	√	Model: OAW-AP1231 (Int. antenna), Powered from Adapter
B	√	√	-	√	Model: OAW-AP1232 (Ext. antenna), Powered from Adapter

Where **RE≥1G**: Radiated Emission above 1GHz **RE<1G**: Radiated Emission below 1GHz
PLC: Power Line Conducted Emission **APCM**: Antenna Port Conducted Measurement

NOTE:

The EUT had been pre-tested on the positioned of each 3 axis. The worst case was found when positioned on **Y-plane**. (Mode A)
The EUT had been pre-tested on the positioned of each 3 axis. The worst case was found when positioned on **X-plane**. (Mode B)

Radiated Emission Test (Above 1GHz):

- Pre-Scan has been conducted to determine the worst-case mode from all possible combinations between available modulations, data rates and antenna ports (if EUT with antenna diversity architecture).
- Following channel(s) was (were) selected for the final test as listed below.

CDD Mode							
EUT Configure Mode	Mode	FREQ. Band (MHz)	Available Channel	Tested Channel	Modulation Technology	Modulation Type	Data Rate (Mbps)
A & B	802.11a	5260-5320	52 to 64	52, 60, 64	OFDM	BPSK	6
A & B	802.11ac (20MHz)		52 to 64	52, 60, 64	OFDM	BPSK	6.5
A & B	802.11ac (40MHz)		54 to 62	54, 62	OFDM	BPSK	13.5
A & B	802.11ac (80MHz)		58	58	OFDM	BPSK	29.3
A & B	802.11a	5500-5700	100 to 140	100, 116, 132, 140	OFDM	BPSK	6
A & B	802.11ac (20MHz)		100 to 140	100, 116, 132, 140	OFDM	BPSK	6.5
A & B	802.11ac (40MHz)		102 to 134	102, 110, 134	OFDM	BPSK	13.5
A & B	802.11ac (80MHz)		106 to 122	106, 122	OFDM	BPSK	29.3

Radiated Emission Test (Below 1GHz):

- Pre-Scan has been conducted to determine the worst-case mode from all possible combinations between available modulations, data rates and antenna ports (if EUT with antenna diversity architecture).
- Following channel(s) was (were) selected for the final test as listed below.

CDD Mode							
EUT Configure Mode	Mode	FREQ. Band (MHz)	Available Channel	Tested Channel	Modulation Technology	Modulation Type	Data Rate (Mbps)
A & B	802.11a	5260-5320	52 to 64	52	OFDM	BPSK	6
	802.11a	5500-5700	100 to 140		OFDM	BPSK	6

Power Line Conducted Emission Test:

- Pre-Scan has been conducted to determine the worst-case mode from all possible combinations between available modulations, data rates and antenna ports (if EUT with antenna diversity architecture).
- Following channel(s) was (were) selected for the final test as listed below.

CDD Mode							
EUT Configure Mode	Mode	FREQ. Band (MHz)	Available Channel	Tested Channel	Modulation Technology	Modulation Type	Data Rate (Mbps)
A	802.11a	5260-5320	52 to 64	52	OFDM	BPSK	6
	802.11a	5500-5700	100 to 140		OFDM	BPSK	6

Antenna Port Conducted Measurement:

- This item includes all test value of each mode, but only includes spectrum plot of worst value of each mode.
- Pre-Scan has been conducted to determine the worst-case mode from all possible combinations between available modulations, data rates and antenna ports (if EUT with antenna diversity architecture).
- Following channel(s) was (were) selected for the final test as listed below.
- The EUT was tested with CDD MODE & Beamforming_NSS1 MODE for Maximum Peak Output Power test. The worst case was found when the EUT was tested with CDD MODE. Therefore, other test items were tested with CDD MODE only.

CDD Mode							
EUT Configure Mode	Mode	FREQ. Band (MHz)	Available Channel	Tested Channel	Modulation Technology	Modulation Type	Data Rate (Mbps)
A & B	802.11a	5260-5320	52 to 64	52, 60, 64	OFDM	BPSK	6
A & B	802.11ac (20MHz)		52 to 64	52, 60, 64	OFDM	BPSK	6.5
A & B	802.11ac (40MHz)		54 to 62	54, 62	OFDM	BPSK	13.5
A & B	802.11ac (80MHz)		58	58	OFDM	BPSK	29.3
A & B	802.11a	5500-5700	100 to 140	100, 116, 132, 140	OFDM	BPSK	6
A & B	802.11ac (20MHz)		100 to 140	100, 116, 132, 140	OFDM	BPSK	6.5
A & B	802.11ac (40MHz)		102 to 134	102, 110, 134	OFDM	BPSK	13.5
A & B	802.11ac (80MHz)		106 to 122	106, 122	OFDM	BPSK	29.3
Beamforming_NSS1 Mode (Output Power Only)							
EUT Configure Mode	Mode	FREQ. Band (MHz)	Available Channel	Tested Channel	Modulation Technology	Modulation Type	Data Rate (Mbps)
A & B	802.11ac (20MHz)	5260-5320	52 to 64	52, 60, 64	OFDM	BPSK	6.5
A & B	802.11ac (40MHz)		54 to 62	54, 62	OFDM	BPSK	13.5
A & B	802.11ac (80MHz)		58	58	OFDM	BPSK	29.3
A & B	802.11ac (20MHz)	5500-5700	100 to 140	100, 116, 132, 140	OFDM	BPSK	6.5
A & B	802.11ac (40MHz)		102 to 134	102, 110, 134	OFDM	BPSK	13.5
A & B	802.11ac (80MHz)		106 to 122	106, 122	OFDM	BPSK	29.3

Test Condition:

Applicable To	Environmental Conditions	Input Power	Tested By
RE≥1G	32deg. C, 66%RH	120Vac, 60Hz	Ian Chang
RE<1G	32deg. C, 66%RH	120Vac, 60Hz	Ian Chang
PLC	27deg. C, 73%RH	120Vac, 60Hz	Ian Chang
APCM	25deg. C, 76%RH	120Vac, 60Hz	Saxon Lee

3.3 Duty Cycle of Test Signal

If duty cycle of test signal is > 98%, duty factor is not required.

If duty cycle of test signal is < 98%, duty factor shall be considered.

802.11a: Duty cycle = 2/2.09 = 0.957, Duty factor = 10 * log(1/0.957) = 0.19

802.11n (20MHz): Duty cycle of test signal is 98.2 %.

802.11n (40MHz): Duty cycle = 2.265/2.485 = 0.952, Duty factor = 10 * log(1/0.952) = 0.21

802.11ac (80MHz): Duty cycle = 1.116/1.2 = 0.93, Duty factor = 10 * log(1/0.93) = 0.32

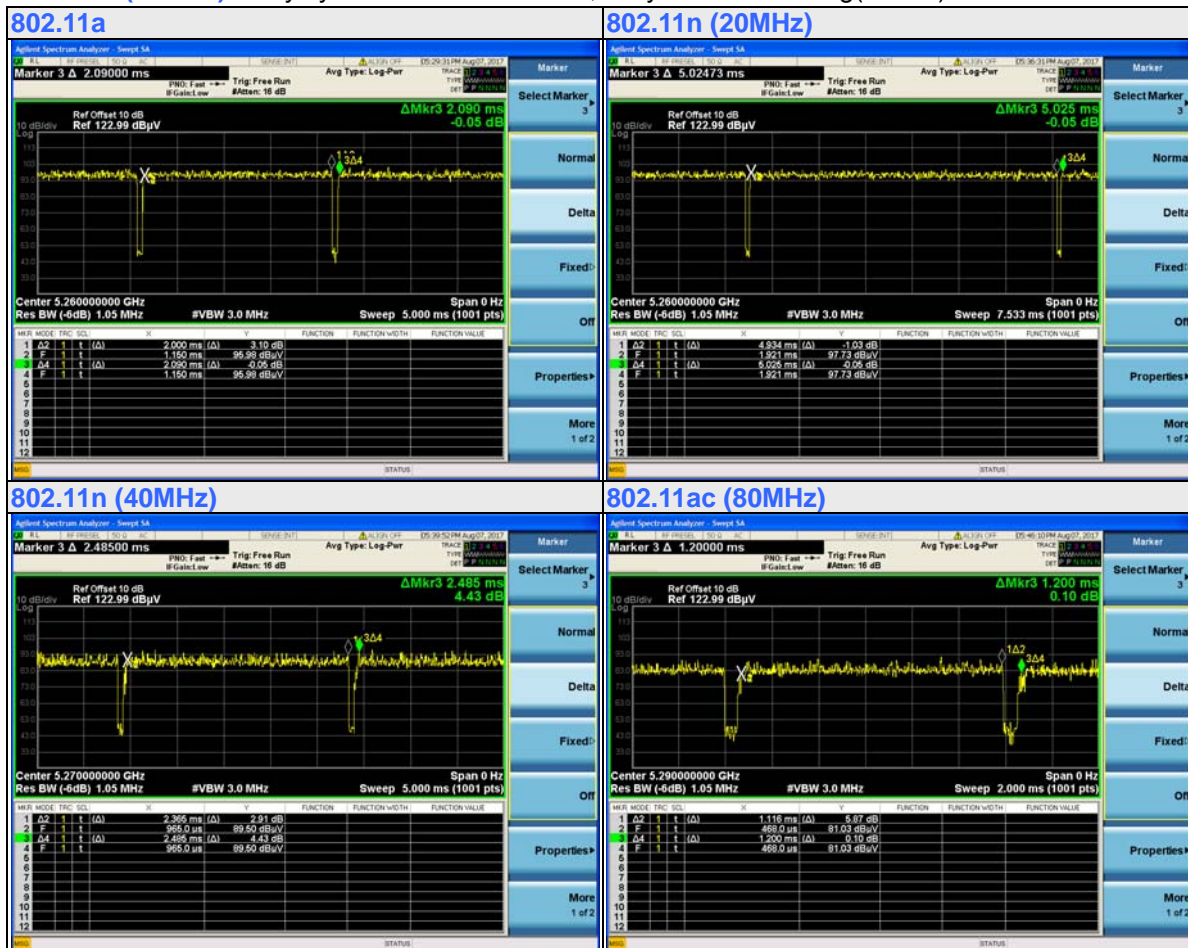

3.4 Description of Support Units

The EUT has been tested as an independent unit together with other necessary accessories or support units. The following support units or accessories were used to form a representative test configuration during the tests.

ID	Product	Brand	Model No.	Serial No.	FCC ID	Remarks
A.	Adapter	APD	WB-18D12R	N/A	N/A	Supplied by client
B.	NOTEBOOK PC	DELL	PP27L	8SNZ12S	FCC DoC Approved	Provided by Lab

Note:

1. All power cords of the above support units are non-shielded (1.8m).
2. Item B acted as communication partners to transfer data.

ID	Descriptions	Qty.	Length (m)	Shielding (Yes/No)	Cores (Qty.)	Remarks
1.	DC cable	1	1.5	N	0	Supplied by client
2.	LAN cable	1	10	N	0	Provided by Lab
3.	AC cable	1	1.8	N	0	Provided by Lab

Note: The core(s) is(are) originally attached to the cable(s).

3.4.1 Configuration of System under Test

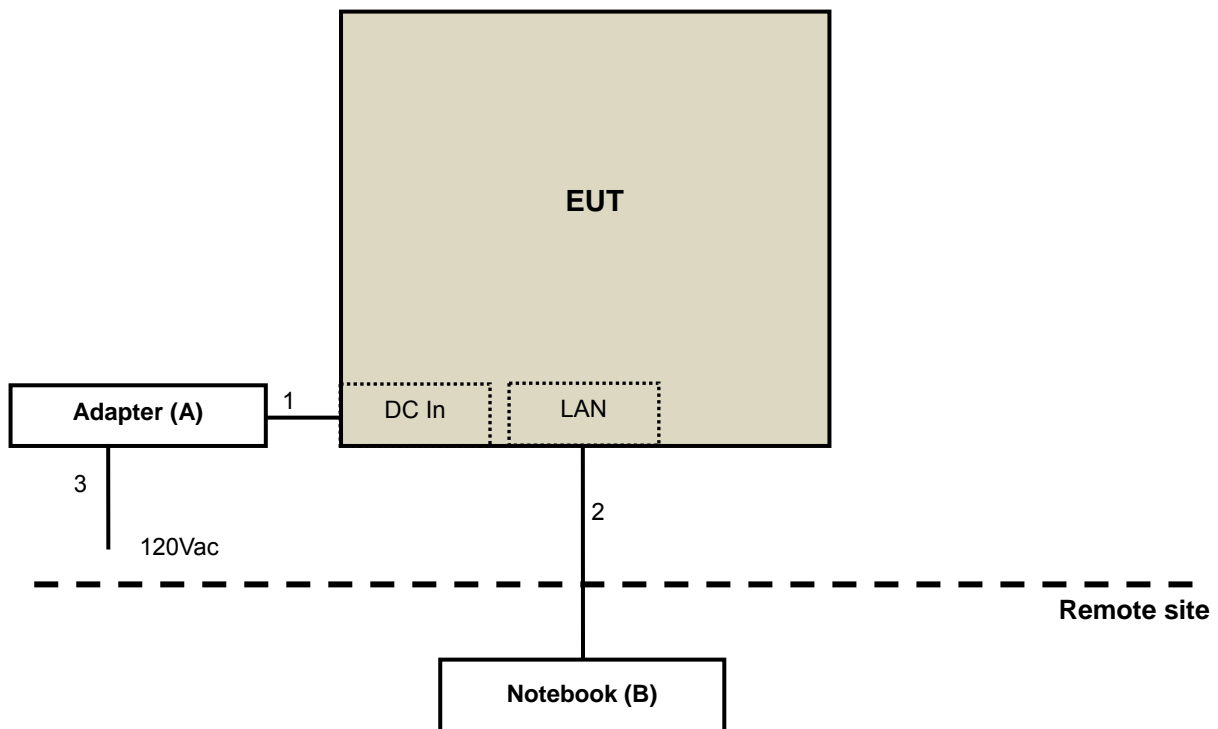

3.5 General Description of Applied Standard

The EUT is a RF Product. According to the specifications of the manufacturer, it must comply with the requirements of the following standards:

FCC Part 15, Subpart E (15.407)
KDB 789033 D02 General UNII Test Procedure New Rules v02r01
KDB 662911 D01 Multiple Transmitter Output v02r01
ANSI C63.10-2013

All test items have been performed and recorded as per the above standards.

4 Test Types and Results

4.1 Radiated Emission and Bandedge Measurement

4.1.1 Limits of Radiated Emission and Bandedge Measurement

Radiated emissions which fall in the restricted bands must comply with the radiated emission limits specified as below table.

Frequencies (MHz)	Field Strength (microvolts/meter)	Measurement Distance (meters)
0.009 ~ 0.490	2400/F(kHz)	300
0.490 ~ 1.705	24000/F(kHz)	30
1.705 ~ 30.0	30	30
30 ~ 88	100	3
88 ~ 216	150	3
216 ~ 960	200	3
Above 960	500	3

NOTE:

- The lower limit shall apply at the transition frequencies.
- Emission level (dBuV/m) = 20 log Emission level (uV/m).
- For frequencies above 1000MHz, the field strength limits are based on average detector, however, the peak field strength of any emission shall not exceed the maximum permitted average limits, specified above by more than 20dB under any condition of modulation.

Limits of unwanted emission out of the restricted bands

Applicable To		Limit	
789033 D02 General UNII Test Procedure New Rules v02r01		Field Strength at 3m	
		PK:74 (dBuV/m)	AV:54 (dBuV/m)
Frequency Band	Applicable To	EIRP Limit	Equivalent Field Strength at 3m
5150~5250 MHz	15.407(b)(1)	PK:-27 (dBm/MHz)	PK:68.2(dBuV/m)
5250~5350 MHz	15.407(b)(2)		
5470~5725 MHz	15.407(b)(3)		
5725~5850 MHz	<input type="checkbox"/> 15.407(b)(4)(i)	PK:-27 (dBm/MHz) ^{*1} PK:10 (dBm/MHz) ^{*2} PK:15.6 (dBm/MHz) ^{*3} PK:27 (dBm/MHz) ^{*4}	PK: 68.2(dBuV/m) ^{*1} PK:105.2 (dBuV/m) ^{*2} PK: 110.8(dBuV/m) ^{*3} PK:122.2 (dBuV/m) ^{*4}
	<input type="checkbox"/> 15.407(b)(4)(ii)	Emission limits in section 15.247(d)	
^{*1} beyond 75 MHz or more above of the band edge.		^{*2} below the band edge increasing linearly to 10 dBm/MHz at 25 MHz above.	
^{*3} below the band edge increasing linearly to a level of 15.6 dBm/MHz at 5 MHz above.		^{*4} from 5 MHz above or below the band edge increasing linearly to a level of 27 dBm/MHz at the band edge.	

Note:

The following formula is used to convert the equipment isotropic radiated power (eirp) to field strength:

$$E = \frac{1000000\sqrt{30P}}{3} \mu\text{V/m, where P is the eirp (Watts).}$$

4.1.2 Test Instruments

DESCRIPTION & MANUFACTURER	MODEL NO.	SERIAL NO.	CALIBRATED DATE	CALIBRATED UNTIL
HP Preamplifier	8447D	2432A03504	Feb. 21, 2017	Feb. 20, 2018
HP Preamplifier	8449B	3008A01201	Feb. 22, 2017	Feb. 21, 2018
MITEQ Preamplifier	AMF-6F-260400-33-8P	892164	Feb. 21, 2017	Feb. 20, 2018
Agilent TEST RECEIVER	N9038A	MY51210129	Feb. 08, 2017	Feb. 07, 2018
Schwarzbeck Antenna	VULB 9168	139	Dec. 13, 2016	Dec. 12, 2017
Schwarzbeck Horn Antenna	BBHA-9170	212	Dec. 30, 2016	Dec. 29, 2017
Schwarzbeck Horn Antenna	BBHA 9120-D1	D130	Dec. 27, 2016	Dec. 26, 2017
ADT. Turn Table	TT100	0306	NA	NA
ADT. Tower	AT100	0306	NA	NA
Software	Radiated_V7.6.15.9.5	NA	NA	NA
SUHNER RF cable With 4dB PAD	SF104	CABLE-CH6	Aug. 14, 2017	Aug. 13, 2018
SUHNER RF cable With 3dB PAD	SF102	Cable-CH8-3.6m	Aug. 14, 2017	Aug. 13, 2018
KEYSIGHT MIMO Powermeasurement Test set	U2021XA	U2021XA-001	May 31, 2017	May 30, 2018
KEYSIGHT Spectrum Analyzer	N9030A	MY54490260	Jul. 26, 2017	Jul. 25, 2018
Loop Antenna EMCI	LPA600	270	Aug. 11, 2017	Aug. 10, 2019
EMCO Horn Antenna	3115	00028257	Dec. 15, 2016	Dec. 14, 2017
Highpass filter Wainwright Instruments	WHK 3.1/18G-10SS	SN 8	NA	NA
ROHDE & SCHWARZ Spectrum Analyzer	FSV40	101042	Sep. 30, 2016	Sep. 29, 2017
			Sep. 29, 2017	Sep. 28, 2018
Anritsu Power Sensor	MA2411B	0738404	Apr. 24, 2017	Apr. 23, 2018
Anritsu Power Meter	ML2495A	0842014	Apr. 24, 2017	Apr. 23, 2018
Temperature & Humidity Chamber	MHU-225AU	920409	May 25, 2017	May 24, 2018
DIGITAL POWER METER IDRC	CP-240	240515	Sep. 8, 2017	Sep. 7, 2018
AC Power Source ExTech	CFW-105	E000603	Sep. 8, 2017	Sep. 7, 2018

- NOTE:** 1. The calibration interval of the above test instruments is 12/24 months. And the calibrations are traceable to NML/ROC and NIST/USA.
2. The horn antenna and HP preamplifier (model: 8449B) are used only for the measurement of emission frequency above 1GHz if tested.
3. The test was performed in Chamber No. 6.
4. The Industry Canada Reference No. IC 7450E-6.
5. The FCC Site Registration No. is 447212.
6. Tested Date: Sep. 13 ~ Oct. 27, 2017

4.1.3 Test Procedure

For Radiated emission below 30MHz

- a. The EUT was placed on the top of a rotating table 0.8 meters above the ground at a 3 meter chamber room. The table was rotated 360 degrees to determine the position of the highest radiation.
- b. The EUT was set 3 meters away from the interference-receiving antenna, which was mounted on the top of a variable-height antenna tower.
- c. Both X and Y axes of the antenna are set to make the measurement.
- d. For each suspected emission, the EUT was arranged to its worst case and the rotatable table was turned from 0 degrees to 360 degrees to find the maximum reading.
- e. The test-receiver system was set to Quasi-Peak Detect Function and Specified Bandwidth with Maximum Hold Mode.

NOTE:

1. The resolution bandwidth and video bandwidth of test receiver/spectrum analyzer is 9kHz at frequency below 30MHz.

For Radiated emission above 30MHz

- a. The EUT was placed on the top of a rotating table 0.8 meters (for 30MHz ~ 1GHz) / 1.5 meters (for above 1GHz) above the ground at 3 meter chamber room for test. The table was rotated 360 degrees to determine the position of the highest radiation.
- b. The EUT was set 3 meters away from the interference-receiving antenna, which was mounted on the top of a variable-height antenna tower.
- c. The height of antenna is varied from one meter to four meters above the ground to determine the maximum value of the field strength. Both horizontal and vertical polarizations of the antenna are set to make the measurement.
- d. For each suspected emission, the EUT was arranged to its worst case and then the antenna was tuned to heights from 1 meter to 4 meters and the rotatable table was turned from 0 degrees to 360 degrees to find the maximum reading.
- e. The test-receiver system was set to quasi-peak detect function and specified bandwidth with maximum hold mode when the test frequency is below 1 GHz.
- f. The test-receiver system was set to peak and average detect function and specified bandwidth with maximum hold mode when the test frequency is above 1 GHz. If the peak reading value also meets average limit, measurement with the average detector is unnecessary.

Note:

1. The resolution bandwidth and video bandwidth of test receiver/spectrum analyzer is 120kHz for Quasi-peak detection (QP) at frequency below 1GHz.
2. The resolution bandwidth of test receiver/spectrum analyzer is 1 MHz and the video bandwidth is 3 MHz for Peak detection (PK) at frequency above 1GHz.
3. The resolution bandwidth of test receiver/spectrum analyzer is 1MHz and the video bandwidth is $\geq 1/T$ (Duty cycle < 98%) or 10Hz (Duty cycle $\geq 98\%$) for Average detection (AV) at frequency above 1GHz.
4. All modes of operation were investigated and the worst-case emissions are reported.

4.1.4 Deviation from Test Standard

No deviation.

4.1.5 Test Setup

For Radiated emission below 30MHz

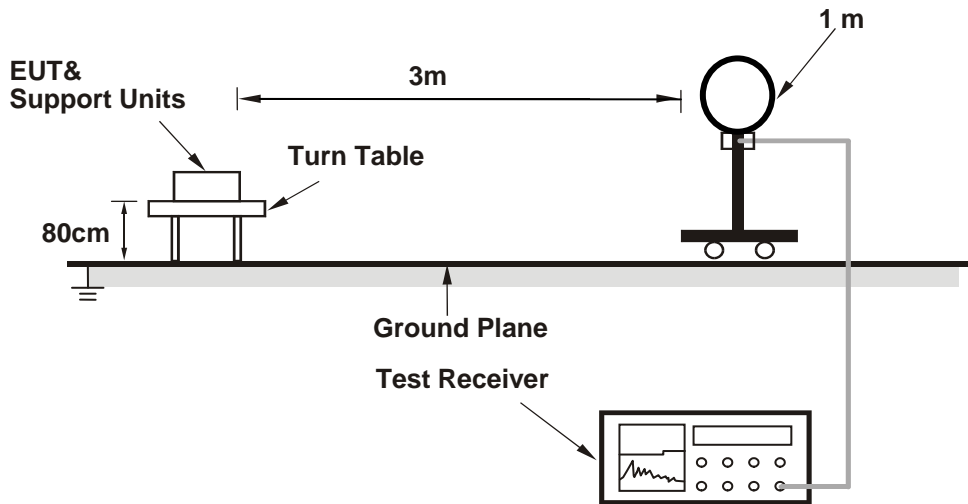

For Radiated emission 30MHz to 1GHz

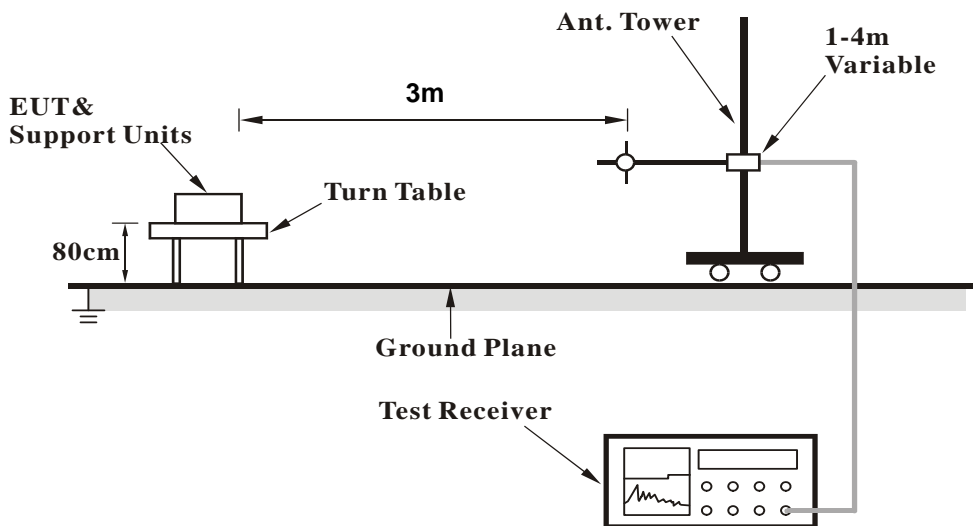

For Radiated emission above 1GHz

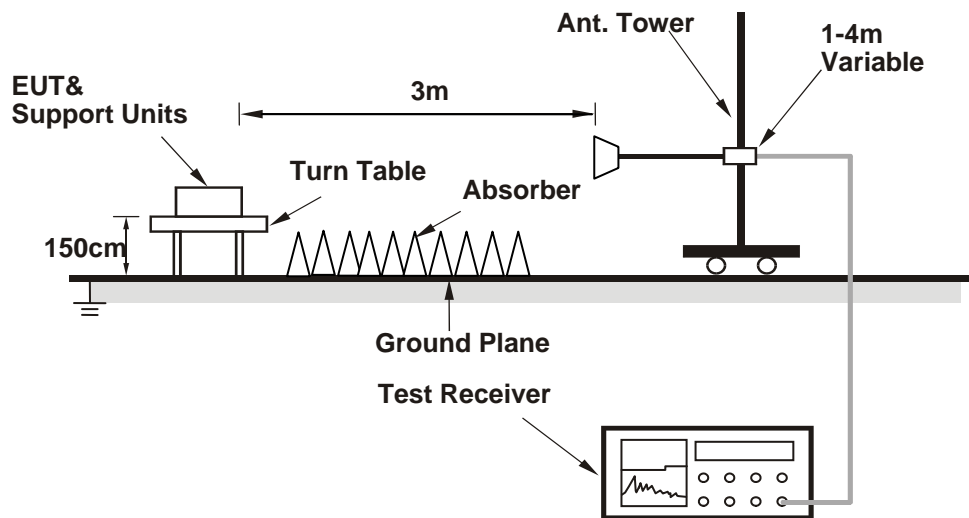

For the actual test configuration, please refer to the attached file (Test Setup Photo).

4.1.6 EUT Operating Condition

- a. Connected the EUT with AC adapter placed on testing table.
- b. Set the EUT under transmission condition continuously at specific channel frequency.

4.1.7 Test Results

CDD MODE (Mode A)

Above 1GHz Data:

802.11a

CHANNEL	TX Channel 52	DETECTOR FUNCTION	Peak (PK)
FREQUENCY RANGE	1GHz ~ 40GHz		Average (AV)

ANTENNA POLARITY & TEST DISTANCE: HORIZONTAL AT 3 M

NO.	FREQ. (MHz)	EMISSION LEVEL (dBuV/m)	LIMIT (dBuV/m)	MARGIN (dB)	ANTENNA HEIGHT (m)	TABLE ANGLE (Degree)	RAW VALUE (dBuV)	CORRECTION FACTOR (dB/m)
1	5150.00	58.15 PK	74.00	-15.85	1.88 H	333	53.24	4.91
2	5150.00	44.57 AV	54.00	-9.43	1.88 H	333	39.66	4.91
3	*5260.00	110.63 PK			1.88 H	333	105.54	5.09
4	*5260.00	99.62 AV			1.88 H	333	94.53	5.09
5	#10520.00	56.34 PK	74.00	-17.66	1.57 H	154	40.51	15.83
6	#10520.00	43.68 AV	54.00	-10.32	1.57 H	154	27.85	15.83

ANTENNA POLARITY & TEST DISTANCE: VERTICAL AT 3 M

NO.	FREQ. (MHz)	EMISSION LEVEL (dBuV/m)	LIMIT (dBuV/m)	MARGIN (dB)	ANTENNA HEIGHT (m)	TABLE ANGLE (Degree)	RAW VALUE (dBuV)	CORRECTION FACTOR (dB/m)
1	5150.00	57.28 PK	74.00	-16.72	1.49 V	246	52.37	4.91
2	5150.00	43.74 AV	54.00	-10.26	1.49 V	246	38.83	4.91
3	*5260.00	107.59 PK			1.49 V	246	102.50	5.09
4	*5260.00	96.03 AV			1.49 V	246	90.94	5.09
5	#10520.00	55.09 PK	74.00	-18.91	1.34 V	264	39.26	15.83
6	#10520.00	42.06 AV	54.00	-11.94	1.34 V	264	26.23	15.83

REMARKS:

1. Emission Level(dBuV/m) = Raw Value(dBuV) + Correction Factor(dB/m)
2. Correction Factor(dB/m) = Antenna Factor(dB/m) + Cable Factor(dB) – Pre-Amplifier Factor(dB)
3. The other emission levels were very low against the limit.
4. Margin value = Emission Level – Limit value
5. " * ": Fundamental frequency.
6. " # ": The radiated frequency is out of the restricted band.

CHANNEL	TX Channel 60	DETECTOR FUNCTION	Peak (PK)
FREQUENCY RANGE	1GHz ~ 40GHz		Average (AV)

ANTENNA POLARITY & TEST DISTANCE: HORIZONTAL AT 3 M

NO.	FREQ. (MHz)	EMISSION LEVEL (dBuV/m)	LIMIT (dBuV/m)	MARGIN (dB)	ANTENNA HEIGHT (m)	TABLE ANGLE (Degree)	RAW VALUE (dBuV)	CORRECTION FACTOR (dB/m)
1	*5300.00	110.25 PK			1.87 H	333	105.09	5.16
2	*5300.00	98.98 AV			1.87 H	333	93.82	5.16
3	10600.00	56.48 PK	74.00	-17.52	1.56 H	264	40.56	15.92
4	10600.00	43.56 AV	54.00	-10.44	1.56 H	264	27.64	15.92

ANTENNA POLARITY & TEST DISTANCE: VERTICAL AT 3 M

NO.	FREQ. (MHz)	EMISSION LEVEL (dBuV/m)	LIMIT (dBuV/m)	MARGIN (dB)	ANTENNA HEIGHT (m)	TABLE ANGLE (Degree)	RAW VALUE (dBuV)	CORRECTION FACTOR (dB/m)
1	*5300.00	107.01 PK			1.51 V	250	101.85	5.16
2	*5300.00	94.85 AV			1.51 V	250	89.69	5.16
3	10600.00	55.57 PK	74.00	-18.43	1.39 V	269	39.65	15.92
4	10600.00	42.27 AV	54.00	-11.73	1.39 V	269	26.35	15.92

REMARKS:

1. Emission Level(dBuV/m) = Raw Value(dBuV) + Correction Factor(dB/m)
2. Correction Factor(dB/m) = Antenna Factor(dB/m) + Cable Factor(dB) – Pre-Amplifier Factor(dB)
3. The other emission levels were very low against the limit.
4. Margin value = Emission Level – Limit value
5. " * ": Fundamental frequency.

CHANNEL	TX Channel 64	DETECTOR FUNCTION	Peak (PK)
FREQUENCY RANGE	1GHz ~ 40GHz		Average (AV)

ANTENNA POLARITY & TEST DISTANCE: HORIZONTAL AT 3 M

NO.	FREQ. (MHz)	EMISSION LEVEL (dBuV/m)	LIMIT (dBuV/m)	MARGIN (dB)	ANTENNA HEIGHT (m)	TABLE ANGLE (Degree)	RAW VALUE (dBuV)	CORRECTION FACTOR (dB/m)
1	*5320.00	109.75 PK			1.88 H	283	104.51	5.24
2	*5320.00	98.45 AV			1.88 H	283	93.21	5.24
3	5350.00	56.48 PK	74.00	-17.52	1.88 H	283	51.13	5.35
4	5350.00	42.39 AV	54.00	-11.61	1.88 H	283	37.04	5.35
5	10640.00	56.57 PK	74.00	-17.43	1.59 H	156	40.51	16.06
6	10640.00	43.75 AV	54.00	-10.25	1.59 H	156	27.69	16.06

ANTENNA POLARITY & TEST DISTANCE: VERTICAL AT 3 M

NO.	FREQ. (MHz)	EMISSION LEVEL (dBuV/m)	LIMIT (dBuV/m)	MARGIN (dB)	ANTENNA HEIGHT (m)	TABLE ANGLE (Degree)	RAW VALUE (dBuV)	CORRECTION FACTOR (dB/m)
1	*5320.00	106.27 PK			1.47 V	254	101.03	5.24
2	*5320.00	94.49 AV			1.47 V	254	89.25	5.24
3	5350.00	55.51 PK	74.00	-18.49	1.47 V	254	50.16	5.35
4	5350.00	41.98 AV	54.00	-12.02	1.47 V	254	36.63	5.35
5	10640.00	55.91 PK	74.00	-18.09	1.88 V	157	39.85	16.06
6	10640.00	42.44 AV	54.00	-11.56	1.88 V	157	26.38	16.06

REMARKS:

1. Emission Level(dBuV/m) = Raw Value(dBuV) + Correction Factor(dB/m)
2. Correction Factor(dB/m) = Antenna Factor(dB/m) + Cable Factor(dB) – Pre-Amplifier Factor(dB)
3. The other emission levels were very low against the limit.
4. Margin value = Emission Level – Limit value
5. " * ": Fundamental frequency.

CHANNEL	TX Channel 100	DETECTOR FUNCTION	Peak (PK)
FREQUENCY RANGE	1GHz ~ 40GHz		Average (AV)

ANTENNA POLARITY & TEST DISTANCE: HORIZONTAL AT 3 M

NO.	FREQ. (MHz)	EMISSION LEVEL (dBuV/m)	LIMIT (dBuV/m)	MARGIN (dB)	ANTENNA HEIGHT (m)	TABLE ANGLE (Degree)	RAW VALUE (dBuV)	CORRECTION FACTOR (dB/m)
1	5460.00	57.71 PK	74.00	-16.29	2.53 H	324	51.94	5.77
2	5460.00	44.07 AV	54.00	-9.93	2.53 H	324	38.30	5.77
3	5470.00	58.42 PK	68.20	-9.78	2.53 H	324	52.60	5.82
4	*5500.00	116.78 PK			2.53 H	324	110.84	5.94
5	*5500.00	105.64 AV			2.53 H	324	99.70	5.94
6	11000.00	57.91 PK	74.00	-16.09	1.57 H	124	40.55	17.36
7	11000.00	45.25 AV	54.00	-8.75	1.57 H	124	27.89	17.36

ANTENNA POLARITY & TEST DISTANCE: VERTICAL AT 3 M

NO.	FREQ. (MHz)	EMISSION LEVEL (dBuV/m)	LIMIT (dBuV/m)	MARGIN (dB)	ANTENNA HEIGHT (m)	TABLE ANGLE (Degree)	RAW VALUE (dBuV)	CORRECTION FACTOR (dB/m)
1	5460.00	56.65 PK	74.00	-17.35	1.47 V	134	50.88	5.77
2	5460.00	43.46 AV	54.00	-10.54	1.47 V	134	37.69	5.77
3	5470.00	57.06 PK	68.20	-11.14	1.47 V	134	51.24	5.82
4	*5500.00	112.46 PK			1.47 V	134	106.52	5.94
5	*5500.00	101.28 AV			1.47 V	134	95.34	5.94
6	11000.00	56.92 PK	74.00	-17.08	1.85 V	285	39.56	17.36
7	11000.00	43.73 AV	54.00	-10.27	1.85 V	285	26.37	17.36

REMARKS:

1. Emission Level(dBuV/m) = Raw Value(dBuV) + Correction Factor(dB/m)
2. Correction Factor(dB/m) = Antenna Factor(dB/m) + Cable Factor(dB) – Pre-Amplifier Factor(dB)
3. The other emission levels were very low against the limit.
4. Margin value = Emission Level – Limit value
5. " * ": Fundamental frequency.

CHANNEL	TX Channel 116	DETECTOR FUNCTION	Peak (PK)
FREQUENCY RANGE	1GHz ~ 40GHz		Average (AV)

ANTENNA POLARITY & TEST DISTANCE: HORIZONTAL AT 3 M

NO.	FREQ. (MHz)	EMISSION LEVEL (dBuV/m)	LIMIT (dBuV/m)	MARGIN (dB)	ANTENNA HEIGHT (m)	TABLE ANGLE (Degree)	RAW VALUE (dBuV)	CORRECTION FACTOR (dB/m)
1	*5580.00	117.34 PK			2.84 H	317	110.90	6.44
2	*5580.00	106.15 AV			2.84 H	317	99.71	6.44
3	11160.00	58.12 PK	74.00	-15.88	1.92 H	261	40.82	17.30
4	11160.00	44.43 AV	54.00	-9.57	1.92 H	261	27.13	17.30

ANTENNA POLARITY & TEST DISTANCE: VERTICAL AT 3 M

NO.	FREQ. (MHz)	EMISSION LEVEL (dBuV/m)	LIMIT (dBuV/m)	MARGIN (dB)	ANTENNA HEIGHT (m)	TABLE ANGLE (Degree)	RAW VALUE (dBuV)	CORRECTION FACTOR (dB/m)
1	*5580.00	113.28 PK			1.53 V	124	106.84	6.44
2	*5580.00	101.60 AV			1.53 V	124	95.16	6.44
3	11160.00	56.73 PK	74.00	-17.27	2.03 V	100	39.43	17.30
4	11160.00	43.76 AV	54.00	-10.24	2.03 V	100	26.46	17.30

REMARKS:

1. Emission Level(dBuV/m) = Raw Value(dBuV) + Correction Factor(dB/m)
2. Correction Factor(dB/m) = Antenna Factor(dB/m) + Cable Factor(dB) – Pre-Amplifier Factor(dB)
3. The other emission levels were very low against the limit.
4. Margin value = Emission Level – Limit value
5. " * ": Fundamental frequency.

CHANNEL	TX Channel 132	DETECTOR FUNCTION	Peak (PK)
FREQUENCY RANGE	1GHz ~ 40GHz		Average (AV)

ANTENNA POLARITY & TEST DISTANCE: HORIZONTAL AT 3 M

NO.	FREQ. (MHz)	EMISSION LEVEL (dBuV/m)	LIMIT (dBuV/m)	MARGIN (dB)	ANTENNA HEIGHT (m)	TABLE ANGLE (Degree)	RAW VALUE (dBuV)	CORRECTION FACTOR (dB/m)
1	*5660.00	117.10 PK			1.78 H	326	110.48	6.62
2	*5660.00	106.25 AV			1.78 H	326	99.63	6.62
3	11320.00	57.54 PK	74.00	-16.46	1.87 H	145	40.55	16.99
4	11320.00	44.65 AV	54.00	-9.35	1.87 H	145	27.66	16.99

ANTENNA POLARITY & TEST DISTANCE: VERTICAL AT 3 M

NO.	FREQ. (MHz)	EMISSION LEVEL (dBuV/m)	LIMIT (dBuV/m)	MARGIN (dB)	ANTENNA HEIGHT (m)	TABLE ANGLE (Degree)	RAW VALUE (dBuV)	CORRECTION FACTOR (dB/m)
1	*5660.00	113.36 PK			1.54 V	167	106.74	6.62
2	*5660.00	101.91 AV			1.54 V	167	95.29	6.62
3	11320.00	56.74 PK	74.00	-17.26	2.14 V	114	39.75	16.99
4	11320.00	43.12 AV	54.00	-10.88	2.14 V	114	26.13	16.99

REMARKS:

1. Emission Level(dBuV/m) = Raw Value(dBuV) + Correction Factor(dB/m)
2. Correction Factor(dB/m) = Antenna Factor(dB/m) + Cable Factor(dB) – Pre-Amplifier Factor(dB)
3. The other emission levels were very low against the limit.
4. Margin value = Emission Level – Limit value
5. " * ": Fundamental frequency.

CHANNEL	TX Channel 140	DETECTOR FUNCTION	Peak (PK)
FREQUENCY RANGE	1GHz ~ 40GHz		Average (AV)

ANTENNA POLARITY & TEST DISTANCE: HORIZONTAL AT 3 M

NO.	FREQ. (MHz)	EMISSION LEVEL (dBuV/m)	LIMIT (dBuV/m)	MARGIN (dB)	ANTENNA HEIGHT (m)	TABLE ANGLE (Degree)	RAW VALUE (dBuV)	CORRECTION FACTOR (dB/m)
1	*5700.00	116.45 PK			2.41 H	325	109.80	6.65
2	*5700.00	105.65 AV			2.41 H	325	99.00	6.65
3	5725.00	64.77 PK	68.20	-3.43	2.41 H	325	58.09	6.68
4	11400.00	57.67 PK	74.00	-16.33	1.69 H	352	40.67	17.00
5	11400.00	44.19 AV	54.00	-9.81	1.69 H	352	27.19	17.00

ANTENNA POLARITY & TEST DISTANCE: VERTICAL AT 3 M

NO.	FREQ. (MHz)	EMISSION LEVEL (dBuV/m)	LIMIT (dBuV/m)	MARGIN (dB)	ANTENNA HEIGHT (m)	TABLE ANGLE (Degree)	RAW VALUE (dBuV)	CORRECTION FACTOR (dB/m)
1	*5700.00	112.13 PK			1.56 V	136	105.48	6.65
2	*5700.00	101.50 AV			1.56 V	136	94.85	6.65
3	5725.00	62.94 PK	68.20	-5.26	1.56 V	136	56.26	6.68
4	11400.00	56.46 PK	74.00	-17.54	1.96 V	281	39.46	17.00
5	11400.00	43.22 AV	54.00	-10.78	1.96 V	281	26.22	17.00

REMARKS:

1. Emission Level(dBuV/m) = Raw Value(dBuV) + Correction Factor(dB/m)
2. Correction Factor(dB/m) = Antenna Factor(dB/m) + Cable Factor(dB) – Pre-Amplifier Factor(dB)
3. The other emission levels were very low against the limit.
4. Margin value = Emission Level – Limit value
5. " * ": Fundamental frequency.

802.11ac (20MHz)

CHANNEL	TX Channel 52	DETECTOR FUNCTION	Peak (PK)
FREQUENCY RANGE	1GHz ~ 40GHz		Average (AV)

ANTENNA POLARITY & TEST DISTANCE: HORIZONTAL AT 3 M

NO.	FREQ. (MHz)	EMISSION LEVEL (dBuV/m)	LIMIT (dBuV/m)	MARGIN (dB)	ANTENNA HEIGHT (m)	TABLE ANGLE (Degree)	RAW VALUE (dBuV)	CORRECTION FACTOR (dB/m)
1	5150.00	58.30 PK	74.00	-15.70	1.29 H	342	53.39	4.91
2	5150.00	44.18 AV	54.00	-9.82	1.29 H	342	39.27	4.91
3	*5260.00	109.45 PK			1.29 H	342	104.36	5.09
4	*5260.00	96.83 AV			1.29 H	342	91.74	5.09
5	#10520.00	56.09 PK	74.00	-17.91	1.87 H	164	40.26	15.83
6	#10520.00	42.51 AV	54.00	-11.49	1.87 H	164	26.68	15.83

ANTENNA POLARITY & TEST DISTANCE: VERTICAL AT 3 M

NO.	FREQ. (MHz)	EMISSION LEVEL (dBuV/m)	LIMIT (dBuV/m)	MARGIN (dB)	ANTENNA HEIGHT (m)	TABLE ANGLE (Degree)	RAW VALUE (dBuV)	CORRECTION FACTOR (dB/m)
1	5150.00	57.17 PK	74.00	-16.83	1.87 V	182	52.26	4.91
2	5150.00	43.37 AV	54.00	-10.63	1.87 V	182	38.46	4.91
3	*5260.00	106.29 PK			1.87 V	182	101.20	5.09
4	*5260.00	93.65 AV			1.87 V	182	88.56	5.09
5	#10520.00	55.66 PK	74.00	-18.34	1.62 V	236	39.83	15.83
6	#10520.00	41.05 AV	54.00	-12.95	1.62 V	236	25.22	15.83

REMARKS:

1. Emission Level(dBuV/m) = Raw Value(dBuV) + Correction Factor(dB/m)
2. Correction Factor(dB/m) = Antenna Factor(dB/m) + Cable Factor(dB) – Pre-Amplifier Factor(dB)
3. The other emission levels were very low against the limit.
4. Margin value = Emission Level – Limit value
5. " * ": Fundamental frequency.
6. " # ": The radiated frequency is out of the restricted band.

CHANNEL	TX Channel 60	DETECTOR FUNCTION	Peak (PK)
FREQUENCY RANGE	1GHz ~ 40GHz		Average (AV)

ANTENNA POLARITY & TEST DISTANCE: HORIZONTAL AT 3 M

NO.	FREQ. (MHz)	EMISSION LEVEL (dBuV/m)	LIMIT (dBuV/m)	MARGIN (dB)	ANTENNA HEIGHT (m)	TABLE ANGLE (Degree)	RAW VALUE (dBuV)	CORRECTION FACTOR (dB/m)
1	*5300.00	110.65 PK			1.88 H	328	105.49	5.16
2	*5300.00	97.99 AV			1.88 H	328	92.83	5.16
3	10600.00	56.07 PK	74.00	-17.93	1.77 H	154	40.15	15.92
4	10600.00	42.23 AV	54.00	-11.77	1.77 H	154	26.31	15.92

ANTENNA POLARITY & TEST DISTANCE: VERTICAL AT 3 M

NO.	FREQ. (MHz)	EMISSION LEVEL (dBuV/m)	LIMIT (dBuV/m)	MARGIN (dB)	ANTENNA HEIGHT (m)	TABLE ANGLE (Degree)	RAW VALUE (dBuV)	CORRECTION FACTOR (dB/m)
1	*5300.00	107.62 PK			1.86 V	179	102.46	5.16
2	*5300.00	94.82 AV			1.86 V	179	89.66	5.16
3	10600.00	55.18 PK	74.00	-18.82	1.39 V	226	39.26	15.92
4	10600.00	41.73 AV	54.00	-12.27	1.39 V	226	25.81	15.92

REMARKS:

1. Emission Level(dBuV/m) = Raw Value(dBuV) + Correction Factor(dB/m)
2. Correction Factor(dB/m) = Antenna Factor(dB/m) + Cable Factor(dB) – Pre-Amplifier Factor(dB)
3. The other emission levels were very low against the limit.
4. Margin value = Emission Level – Limit value
5. " * ": Fundamental frequency.

CHANNEL	TX Channel 64	DETECTOR FUNCTION	Peak (PK)
FREQUENCY RANGE	1GHz ~ 40GHz		Average (AV)

ANTENNA POLARITY & TEST DISTANCE: HORIZONTAL AT 3 M

NO.	FREQ. (MHz)	EMISSION LEVEL (dBuV/m)	LIMIT (dBuV/m)	MARGIN (dB)	ANTENNA HEIGHT (m)	TABLE ANGLE (Degree)	RAW VALUE (dBuV)	CORRECTION FACTOR (dB/m)
1	*5320.00	110.50 PK			1.86 H	315	105.26	5.24
2	*5320.00	97.82 AV			1.86 H	315	92.58	5.24
3	5350.00	56.61 PK	74.00	-17.39	1.86 H	315	51.26	5.35
4	5350.00	42.81 AV	54.00	-11.19	1.86 H	315	37.46	5.35
5	10640.00	56.64 PK	74.00	-17.36	2.31 H	124	40.58	16.06
6	10640.00	42.21 AV	54.00	-11.79	2.31 H	124	26.15	16.06

ANTENNA POLARITY & TEST DISTANCE: VERTICAL AT 3 M

NO.	FREQ. (MHz)	EMISSION LEVEL (dBuV/m)	LIMIT (dBuV/m)	MARGIN (dB)	ANTENNA HEIGHT (m)	TABLE ANGLE (Degree)	RAW VALUE (dBuV)	CORRECTION FACTOR (dB/m)
1	*5320.00	107.40 PK			1.77 V	169	102.16	5.24
2	*5320.00	94.60 AV			1.77 V	169	89.36	5.24
3	5350.00	55.48 PK	74.00	-18.52	1.77 V	169	50.13	5.35
4	5350.00	42.02 AV	54.00	-11.98	1.77 V	169	36.67	5.35
5	10640.00	55.80 PK	74.00	-18.20	1.15 V	187	39.74	16.06
6	10640.00	41.74 AV	54.00	-12.26	1.15 V	187	25.68	16.06

REMARKS:

1. Emission Level(dBuV/m) = Raw Value(dBuV) + Correction Factor(dB/m)
2. Correction Factor(dB/m) = Antenna Factor(dB/m) + Cable Factor(dB) – Pre-Amplifier Factor(dB)
3. The other emission levels were very low against the limit.
4. Margin value = Emission Level – Limit value
5. " * ": Fundamental frequency.

CHANNEL	TX Channel 100	DETECTOR FUNCTION	Peak (PK)
FREQUENCY RANGE	1GHz ~ 40GHz		Average (AV)

ANTENNA POLARITY & TEST DISTANCE: HORIZONTAL AT 3 M

NO.	FREQ. (MHz)	EMISSION LEVEL (dBuV/m)	LIMIT (dBuV/m)	MARGIN (dB)	ANTENNA HEIGHT (m)	TABLE ANGLE (Degree)	RAW VALUE (dBuV)	CORRECTION FACTOR (dB/m)
1	5460.00	57.52 PK	74.00	-16.48	2.44 H	325	51.75	5.77
2	5460.00	44.55 AV	54.00	-9.45	2.44 H	325	38.78	5.77
3	5470.00	59.56 PK	68.20	-8.64	2.44 H	325	53.74	5.82
4	*5500.00	117.23 PK			2.44 H	325	111.29	5.94
5	*5500.00	105.08 AV			2.44 H	325	99.14	5.94
6	11000.00	58.03 PK	74.00	-15.97	1.50 H	155	40.67	17.36
7	11000.00	44.34 AV	54.00	-9.66	1.50 H	155	26.98	17.36

ANTENNA POLARITY & TEST DISTANCE: VERTICAL AT 3 M

NO.	FREQ. (MHz)	EMISSION LEVEL (dBuV/m)	LIMIT (dBuV/m)	MARGIN (dB)	ANTENNA HEIGHT (m)	TABLE ANGLE (Degree)	RAW VALUE (dBuV)	CORRECTION FACTOR (dB/m)
1	5460.00	56.54 PK	74.00	-17.46	1.54 V	174	50.77	5.77
2	5460.00	42.90 AV	54.00	-11.10	1.54 V	174	37.13	5.77
3	5470.00	58.28 PK	68.20	-9.92	1.54 V	174	52.46	5.82
4	*5500.00	113.40 PK			1.54 V	174	107.46	5.94
5	*5500.00	101.79 AV			1.54 V	174	95.85	5.94
6	11000.00	56.74 PK	74.00	-17.26	1.21 V	135	39.38	17.36
7	11000.00	43.02 AV	54.00	-10.98	1.21 V	135	25.66	17.36

REMARKS:

1. Emission Level(dBuV/m) = Raw Value(dBuV) + Correction Factor(dB/m)
2. Correction Factor(dB/m) = Antenna Factor(dB/m) + Cable Factor(dB) – Pre-Amplifier Factor(dB)
3. The other emission levels were very low against the limit.
4. Margin value = Emission Level – Limit value
5. " * ": Fundamental frequency.

CHANNEL	TX Channel 116	DETECTOR FUNCTION	Peak (PK)
FREQUENCY RANGE	1GHz ~ 40GHz		Average (AV)

ANTENNA POLARITY & TEST DISTANCE: HORIZONTAL AT 3 M

NO.	FREQ. (MHz)	EMISSION LEVEL (dBuV/m)	LIMIT (dBuV/m)	MARGIN (dB)	ANTENNA HEIGHT (m)	TABLE ANGLE (Degree)	RAW VALUE (dBuV)	CORRECTION FACTOR (dB/m)
1	*5580.00	117.89 PK			2.51 H	316	111.45	6.44
2	*5580.00	105.84 AV			2.51 H	316	99.40	6.44
3	11160.00	57.97 PK	74.00	-16.03	1.56 H	239	40.67	17.30
4	11160.00	43.63 AV	54.00	-10.37	1.56 H	239	26.33	17.30

ANTENNA POLARITY & TEST DISTANCE: VERTICAL AT 3 M

NO.	FREQ. (MHz)	EMISSION LEVEL (dBuV/m)	LIMIT (dBuV/m)	MARGIN (dB)	ANTENNA HEIGHT (m)	TABLE ANGLE (Degree)	RAW VALUE (dBuV)	CORRECTION FACTOR (dB/m)
1	*5580.00	112.62 PK			1.53 V	169	107.46	5.16
2	*5580.00	101.00 AV			1.53 V	169	95.84	5.16
3	11160.00	56.97 PK	74.00	-17.03	1.85 V	281	39.67	17.30
4	11160.00	43.12 AV	54.00	-10.88	1.85 V	281	25.82	17.30

REMARKS:

1. Emission Level(dBuV/m) = Raw Value(dBuV) + Correction Factor(dB/m)
2. Correction Factor(dB/m) = Antenna Factor(dB/m) + Cable Factor(dB) – Pre-Amplifier Factor(dB)
3. The other emission levels were very low against the limit.
4. Margin value = Emission Level – Limit value
5. " # ": The radiated frequency is out of the restricted band.

CHANNEL	TX Channel 132	DETECTOR FUNCTION	Peak (PK)
FREQUENCY RANGE	1GHz ~ 40GHz		Average (AV)

ANTENNA POLARITY & TEST DISTANCE: HORIZONTAL AT 3 M

NO.	FREQ. (MHz)	EMISSION LEVEL (dBuV/m)	LIMIT (dBuV/m)	MARGIN (dB)	ANTENNA HEIGHT (m)	TABLE ANGLE (Degree)	RAW VALUE (dBuV)	CORRECTION FACTOR (dB/m)
1	*5660.00	118.46 PK			2.48 H	326	111.84	6.62
2	*5660.00	106.26 AV			2.48 H	326	99.64	6.62
3	11320.00	57.63 PK	74.00	-16.37	1.08 H	155	40.64	16.99
4	11320.00	43.33 AV	54.00	-10.67	1.08 H	155	26.34	16.99

ANTENNA POLARITY & TEST DISTANCE: VERTICAL AT 3 M

NO.	FREQ. (MHz)	EMISSION LEVEL (dBuV/m)	LIMIT (dBuV/m)	MARGIN (dB)	ANTENNA HEIGHT (m)	TABLE ANGLE (Degree)	RAW VALUE (dBuV)	CORRECTION FACTOR (dB/m)
1	*5660.00	114.02 PK			1.57 V	185	107.40	6.62
2	*5660.00	102.46 AV			1.57 V	185	95.84	6.62
3	11320.00	56.83 PK	74.00	-17.17	1.56 V	229	39.84	16.99
4	11320.00	42.33 AV	54.00	-11.67	1.56 V	229	25.34	16.99

REMARKS:

1. Emission Level(dBuV/m) = Raw Value(dBuV) + Correction Factor(dB/m)
2. Correction Factor(dB/m) = Antenna Factor(dB/m) + Cable Factor(dB) – Pre-Amplifier Factor(dB)
3. The other emission levels were very low against the limit.
4. Margin value = Emission Level – Limit value
5. " * ": Fundamental frequency.

CHANNEL	TX Channel 140	DETECTOR FUNCTION	Peak (PK)
FREQUENCY RANGE	1GHz ~ 40GHz		Average (AV)

ANTENNA POLARITY & TEST DISTANCE: HORIZONTAL AT 3 M

NO.	FREQ. (MHz)	EMISSION LEVEL (dBuV/m)	LIMIT (dBuV/m)	MARGIN (dB)	ANTENNA HEIGHT (m)	TABLE ANGLE (Degree)	RAW VALUE (dBuV)	CORRECTION FACTOR (dB/m)
1	*5700.00	117.08 PK			2.42 H	327	110.43	6.65
2	*5700.00	105.54 AV			2.42 H	327	98.89	6.65
3	5725.00	65.11 PK	68.20	-3.09	2.42 H	327	58.43	6.68
4	11400.00	57.69 PK	74.00	-16.31	1.52 H	132	40.69	17.00
5	11400.00	43.34 AV	54.00	-10.66	1.52 H	132	26.34	17.00

ANTENNA POLARITY & TEST DISTANCE: VERTICAL AT 3 M

NO.	FREQ. (MHz)	EMISSION LEVEL (dBuV/m)	LIMIT (dBuV/m)	MARGIN (dB)	ANTENNA HEIGHT (m)	TABLE ANGLE (Degree)	RAW VALUE (dBuV)	CORRECTION FACTOR (dB/m)
1	*5700.00	113.49 PK			1.56 V	166	106.84	6.65
2	*5700.00	101.34 AV			1.56 V	166	94.69	6.65
3	5725.00	63.32 PK	68.20	-4.88	1.56 V	166	56.64	6.68
4	11400.00	56.67 PK	74.00	-17.33	1.94 V	136	39.67	17.00
5	11400.00	42.33 AV	54.00	-11.67	1.94 V	136	25.33	17.00

REMARKS:

1. Emission Level(dBuV/m) = Raw Value(dBuV) + Correction Factor(dB/m)
2. Correction Factor(dB/m) = Antenna Factor(dB/m) + Cable Factor(dB) – Pre-Amplifier Factor(dB)
3. The other emission levels were very low against the limit.
4. Margin value = Emission Level – Limit value
5. " * ": Fundamental frequency.

802.11ac (40MHz)

CHANNEL	TX Channel 54	DETECTOR FUNCTION	Peak (PK)
FREQUENCY RANGE	1GHz ~ 40GHz		Average (AV)

ANTENNA POLARITY & TEST DISTANCE: HORIZONTAL AT 3 M

NO.	FREQ. (MHz)	EMISSION LEVEL (dBuV/m)	LIMIT (dBuV/m)	MARGIN (dB)	ANTENNA HEIGHT (m)	TABLE ANGLE (Degree)	RAW VALUE (dBuV)	CORRECTION FACTOR (dB/m)
1	5150.00	57.71 PK	74.00	-16.29	1.98 H	328	52.80	4.91
2	5150.00	43.90 AV	54.00	-10.10	1.98 H	328	38.99	4.91
3	*5270.00	109.62 PK			1.98 H	328	104.51	5.11
4	*5270.00	98.69 AV			1.98 H	328	93.58	5.11
5	#10540.00	56.17 PK	74.00	-17.83	1.86 H	255	40.32	15.85
6	#10540.00	43.74 AV	54.00	-10.26	1.86 H	255	27.89	15.85

ANTENNA POLARITY & TEST DISTANCE: VERTICAL AT 3 M

NO.	FREQ. (MHz)	EMISSION LEVEL (dBuV/m)	LIMIT (dBuV/m)	MARGIN (dB)	ANTENNA HEIGHT (m)	TABLE ANGLE (Degree)	RAW VALUE (dBuV)	CORRECTION FACTOR (dB/m)
1	5150.00	56.94 PK	74.00	-17.06	1.42 V	236	52.03	4.91
2	5150.00	42.79 AV	54.00	-11.21	1.42 V	236	37.88	4.91
3	*5270.00	106.58 PK			1.42 V	236	101.47	5.11
4	*5270.00	95.36 AV			1.42 V	236	90.25	5.11
5	#10540.00	55.10 PK	74.00	-18.90	1.27 V	154	39.25	15.85
6	#10540.00	42.23 AV	54.00	-11.77	1.27 V	154	26.38	15.85

REMARKS:

1. Emission Level(dBuV/m) = Raw Value(dBuV) + Correction Factor(dB/m)
2. Correction Factor(dB/m) = Antenna Factor(dB/m) + Cable Factor(dB) – Pre-Amplifier Factor(dB)
3. The other emission levels were very low against the limit.
4. Margin value = Emission Level – Limit value
5. " * ": Fundamental frequency.
6. " # ": The radiated frequency is out of the restricted band.

CHANNEL	TX Channel 62	DETECTOR FUNCTION	Peak (PK)
FREQUENCY RANGE	1GHz ~ 40GHz		Average (AV)

ANTENNA POLARITY & TEST DISTANCE: HORIZONTAL AT 3 M

NO.	FREQ. (MHz)	EMISSION LEVEL (dBuV/m)	LIMIT (dBuV/m)	MARGIN (dB)	ANTENNA HEIGHT (m)	TABLE ANGLE (Degree)	RAW VALUE (dBuV)	CORRECTION FACTOR (dB/m)
1	*5310.00	109.39 PK			1.81 H	196	104.19	5.20
2	*5310.00	98.30 AV			1.81 H	196	93.10	5.20
3	5350.00	56.68 PK	74.00	-17.32	1.81 H	196	51.33	5.35
4	5350.00	42.65 AV	54.00	-11.35	1.81 H	196	37.30	5.35
5	10620.00	56.25 PK	74.00	-17.75	1.58 H	103	40.26	15.99
6	10620.00	43.47 AV	54.00	-10.53	1.58 H	103	27.48	15.99

ANTENNA POLARITY & TEST DISTANCE: VERTICAL AT 3 M

NO.	FREQ. (MHz)	EMISSION LEVEL (dBuV/m)	LIMIT (dBuV/m)	MARGIN (dB)	ANTENNA HEIGHT (m)	TABLE ANGLE (Degree)	RAW VALUE (dBuV)	CORRECTION FACTOR (dB/m)
1	*5310.00	106.66 PK			1.42 V	188	101.46	5.20
2	*5310.00	95.45 AV			1.42 V	188	90.25	5.20
3	5350.00	55.76 PK	74.00	-18.24	1.42 V	188	50.41	5.35
4	5350.00	42.24 AV	54.00	-11.76	1.42 V	188	36.89	5.35
5	10620.00	55.16 PK	74.00	-18.84	1.44 V	124	39.17	15.99
6	10620.00	42.41 AV	54.00	-11.59	1.44 V	124	26.42	15.99

REMARKS:

1. Emission Level(dBuV/m) = Raw Value(dBuV) + Correction Factor(dB/m)
2. Correction Factor(dB/m) = Antenna Factor(dB/m) + Cable Factor(dB) – Pre-Amplifier Factor(dB)
3. The other emission levels were very low against the limit.
4. Margin value = Emission Level – Limit value
5. " * ": Fundamental frequency.

CHANNEL	TX Channel 102	DETECTOR FUNCTION	Peak (PK)
FREQUENCY RANGE	1GHz ~ 40GHz		Average (AV)

ANTENNA POLARITY & TEST DISTANCE: HORIZONTAL AT 3 M

NO.	FREQ. (MHz)	EMISSION LEVEL (dBuV/m)	LIMIT (dBuV/m)	MARGIN (dB)	ANTENNA HEIGHT (m)	TABLE ANGLE (Degree)	RAW VALUE (dBuV)	CORRECTION FACTOR (dB/m)
1	5460.00	62.22 PK	74.00	-11.78	2.16 H	321	56.45	5.77
2	5460.00	48.46 AV	54.00	-5.54	2.16 H	321	42.69	5.77
3	5470.00	66.20 PK	68.20	-2.00	2.16 H	321	60.38	5.82
4	*5510.00	115.00 PK			2.16 H	321	108.99	6.01
5	*5510.00	103.91 AV			2.16 H	321	97.90	6.01
6	11020.00	58.06 PK	74.00	-15.94	1.87 H	164	40.67	17.39
7	11020.00	44.85 AV	54.00	-9.15	1.87 H	164	27.46	17.39

ANTENNA POLARITY & TEST DISTANCE: VERTICAL AT 3 M

NO.	FREQ. (MHz)	EMISSION LEVEL (dBuV/m)	LIMIT (dBuV/m)	MARGIN (dB)	ANTENNA HEIGHT (m)	TABLE ANGLE (Degree)	RAW VALUE (dBuV)	CORRECTION FACTOR (dB/m)
1	5460.00	60.90 PK	74.00	-13.10	1.57 V	167	55.13	5.77
2	5460.00	47.00 AV	54.00	-7.00	1.57 V	167	41.23	5.77
3	5470.00	64.70 PK	68.20	-3.50	1.57 V	167	58.88	5.82
4	*5510.00	110.59 PK			1.57 V	167	104.58	6.01
5	*5510.00	99.47 AV			1.57 V	167	93.46	6.01
6	11020.00	57.03 PK	74.00	-16.97	2.14 V	115	39.64	17.39
7	11020.00	44.06 AV	54.00	-9.94	2.14 V	115	26.67	17.39

REMARKS:

1. Emission Level(dBuV/m) = Raw Value(dBuV) + Correction Factor(dB/m)
2. Correction Factor(dB/m) = Antenna Factor(dB/m) + Cable Factor(dB) – Pre-Amplifier Factor(dB)
3. The other emission levels were very low against the limit.
4. Margin value = Emission Level – Limit value
5. " * ": Fundamental frequency.

CHANNEL	TX Channel 110	DETECTOR FUNCTION	Peak (PK)
FREQUENCY RANGE	1GHz ~ 40GHz		Average (AV)

ANTENNA POLARITY & TEST DISTANCE: HORIZONTAL AT 3 M

NO.	FREQ. (MHz)	EMISSION LEVEL (dBuV/m)	LIMIT (dBuV/m)	MARGIN (dB)	ANTENNA HEIGHT (m)	TABLE ANGLE (Degree)	RAW VALUE (dBuV)	CORRECTION FACTOR (dB/m)
1	*5550.00	114.72 PK			2.23 H	326	108.46	6.26
2	*5550.00	103.71 AV			2.23 H	326	97.45	6.26
3	11100.00	58.35 PK	74.00	-15.65	1.52 H	116	40.88	17.47
4	11100.00	45.16 AV	54.00	-8.84	1.52 H	116	27.69	17.47

ANTENNA POLARITY & TEST DISTANCE: VERTICAL AT 3 M

NO.	FREQ. (MHz)	EMISSION LEVEL (dBuV/m)	LIMIT (dBuV/m)	MARGIN (dB)	ANTENNA HEIGHT (m)	TABLE ANGLE (Degree)	RAW VALUE (dBuV)	CORRECTION FACTOR (dB/m)
1	*5550.00	110.78 PK			1.44 V	187	104.52	6.26
2	*5550.00	99.81 AV			1.44 V	187	93.55	6.26
3	11100.00	56.81 PK	74.00	-17.19	1.44 V	169	39.34	17.47
4	11100.00	43.66 AV	54.00	-10.34	1.44 V	169	26.19	17.47

REMARKS:

1. Emission Level(dBuV/m) = Raw Value(dBuV) + Correction Factor(dB/m)
2. Correction Factor(dB/m) = Antenna Factor(dB/m) + Cable Factor(dB) – Pre-Amplifier Factor(dB)
3. The other emission levels were very low against the limit.
4. Margin value = Emission Level – Limit value
5. " * ": Fundamental frequency.

CHANNEL	TX Channel 134	DETECTOR FUNCTION	Peak (PK)
FREQUENCY RANGE	1GHz ~ 40GHz		Average (AV)

ANTENNA POLARITY & TEST DISTANCE: HORIZONTAL AT 3 M

NO.	FREQ. (MHz)	EMISSION LEVEL (dBuV/m)	LIMIT (dBuV/m)	MARGIN (dB)	ANTENNA HEIGHT (m)	TABLE ANGLE (Degree)	RAW VALUE (dBuV)	CORRECTION FACTOR (dB/m)
1	*5670.00	115.34 PK			2.17 H	318	108.71	6.63
2	*5670.00	104.35 AV			2.17 H	318	97.72	6.63
3	5725.00	62.46 PK	68.20	-5.74	2.17 H	318	55.78	6.68
4	11340.00	56.26 PK	74.00	-17.74	1.88 H	251	39.27	16.99
5	11340.00	43.48 AV	54.00	-10.52	1.88 H	251	26.49	16.99

ANTENNA POLARITY & TEST DISTANCE: VERTICAL AT 3 M

NO.	FREQ. (MHz)	EMISSION LEVEL (dBuV/m)	LIMIT (dBuV/m)	MARGIN (dB)	ANTENNA HEIGHT (m)	TABLE ANGLE (Degree)	RAW VALUE (dBuV)	CORRECTION FACTOR (dB/m)
1	*5670.00	111.40 PK			1.57 V	186	104.77	6.63
2	*5670.00	100.25 AV			1.57 V	186	93.62	6.63
3	5725.00	60.14 PK	68.20	-8.06	1.57 V	186	53.46	6.68
4	11340.00	54.79 PK	74.00	-19.21	1.58 V	171	37.80	16.99
5	11340.00	41.53 AV	54.00	-12.47	1.58 V	171	24.54	16.99

REMARKS:

1. Emission Level(dBuV/m) = Raw Value(dBuV) + Correction Factor(dB/m)
2. Correction Factor(dB/m) = Antenna Factor(dB/m) + Cable Factor(dB) – Pre-Amplifier Factor(dB)
3. The other emission levels were very low against the limit.
4. Margin value = Emission Level – Limit value
5. " * ": Fundamental frequency.

802.11ac (80MHz)

CHANNEL	TX Channel 58	DETECTOR FUNCTION	Peak (PK)
FREQUENCY RANGE	1GHz ~ 40GHz		Average (AV)

ANTENNA POLARITY & TEST DISTANCE: HORIZONTAL AT 3 M

NO.	FREQ. (MHz)	EMISSION LEVEL (dBuV/m)	LIMIT (dBuV/m)	MARGIN (dB)	ANTENNA HEIGHT (m)	TABLE ANGLE (Degree)	RAW VALUE (dBuV)	CORRECTION FACTOR (dB/m)
1	5150.00	56.78 PK	74.00	-17.22	1.76 H	194	51.87	4.91
2	5150.00	43.86 AV	54.00	-10.14	1.76 H	194	38.95	4.91
3	*5290.00	104.25 PK			1.76 H	194	99.11	5.14
4	*5290.00	93.47 AV			1.76 H	194	88.33	5.14
5	5350.00	56.81 PK	74.00	-17.19	1.76 H	194	51.46	5.35
6	5350.00	43.20 AV	54.00	-10.80	1.76 H	194	37.85	5.35
7	#10580.00	56.05 PK	74.00	-17.95	1.74 H	120	40.16	15.89
8	#10580.00	42.23 AV	54.00	-11.77	1.74 H	120	26.34	15.89

ANTENNA POLARITY & TEST DISTANCE: VERTICAL AT 3 M

NO.	FREQ. (MHz)	EMISSION LEVEL (dBuV/m)	LIMIT (dBuV/m)	MARGIN (dB)	ANTENNA HEIGHT (m)	TABLE ANGLE (Degree)	RAW VALUE (dBuV)	CORRECTION FACTOR (dB/m)
1	5150.00	55.38 PK	74.00	-18.62	1.43 V	231	50.47	4.91
2	5150.00	42.57 AV	54.00	-11.43	1.43 V	231	37.66	4.91
3	*5290.00	101.79 PK			1.43 V	231	96.65	5.14
4	*5290.00	90.60 AV			1.43 V	231	85.46	5.14
5	5350.00	55.81 PK	74.00	-18.19	1.43 V	231	50.46	5.35
6	5350.00	42.19 AV	54.00	-11.81	1.43 V	231	36.84	5.35
7	#10580.00	55.36 PK	74.00	-18.64	1.77 V	134	39.47	15.89
8	#10580.00	41.70 AV	54.00	-12.30	1.77 V	134	25.81	15.89

REMARKS:

1. Emission Level(dBuV/m) = Raw Value(dBuV) + Correction Factor(dB/m)
2. Correction Factor(dB/m) = Antenna Factor(dB/m) + Cable Factor(dB) – Pre-Amplifier Factor(dB)
3. The other emission levels were very low against the limit.
4. Margin value = Emission Level – Limit value
5. " * ": Fundamental frequency.
6. " # ": The radiated frequency is out of the restricted band.

CHANNEL	TX Channel 106	DETECTOR FUNCTION	Peak (PK)
FREQUENCY RANGE	1GHz ~ 40GHz		Average (AV)

ANTENNA POLARITY & TEST DISTANCE: HORIZONTAL AT 3 M

NO.	FREQ. (MHz)	EMISSION LEVEL (dBuV/m)	LIMIT (dBuV/m)	MARGIN (dB)	ANTENNA HEIGHT (m)	TABLE ANGLE (Degree)	RAW VALUE (dBuV)	CORRECTION FACTOR (dB/m)
1	5460.00	65.43 PK	74.00	-8.57	3.17 H	203	59.66	5.77
2	5460.00	49.44 AV	54.00	-4.56	3.17 H	203	43.67	5.77
3	5470.00	67.06 PK	68.20	-1.14	3.17 H	203	61.24	5.82
4	*5530.00	111.02 PK			3.17 H	203	104.89	6.13
5	*5530.00	100.39 AV			3.17 H	203	94.26	6.13
6	11060.00	58.00 PK	74.00	-16.00	1.69 H	125	40.57	17.43
7	11060.00	44.10 AV	54.00	-9.90	1.69 H	125	26.67	17.43

ANTENNA POLARITY & TEST DISTANCE: VERTICAL AT 3 M

NO.	FREQ. (MHz)	EMISSION LEVEL (dBuV/m)	LIMIT (dBuV/m)	MARGIN (dB)	ANTENNA HEIGHT (m)	TABLE ANGLE (Degree)	RAW VALUE (dBuV)	CORRECTION FACTOR (dB/m)
1	5460.00	63.21 PK	74.00	-10.79	1.53 V	231	57.44	5.77
2	5460.00	47.33 AV	54.00	-6.67	1.53 V	231	41.56	5.77
3	5470.00	65.67 PK	68.20	-2.53	1.53 V	231	59.85	5.82
4	*5530.00	106.58 PK			1.53 V	231	100.45	6.13
5	*5530.00	96.93 AV			1.53 V	231	90.80	6.13
6	11060.00	57.09 PK	74.00	-16.91	1.44 V	124	39.66	17.43
7	11060.00	43.24 AV	54.00	-10.76	1.44 V	124	25.81	17.43

REMARKS:

1. Emission Level(dBuV/m) = Raw Value(dBuV) + Correction Factor(dB/m)
2. Correction Factor(dB/m) = Antenna Factor(dB/m) + Cable Factor(dB) – Pre-Amplifier Factor(dB)
3. The other emission levels were very low against the limit.
4. Margin value = Emission Level – Limit value
5. " * ": Fundamental frequency.

CHANNEL	TX Channel 122	DETECTOR FUNCTION	Peak (PK)
FREQUENCY RANGE	1GHz ~ 40GHz		Average (AV)

ANTENNA POLARITY & TEST DISTANCE: HORIZONTAL AT 3 M

NO.	FREQ. (MHz)	EMISSION LEVEL (dBuV/m)	LIMIT (dBuV/m)	MARGIN (dB)	ANTENNA HEIGHT (m)	TABLE ANGLE (Degree)	RAW VALUE (dBuV)	CORRECTION FACTOR (dB/m)
1	*5610.00	110.42 PK			3.20 H	200	103.84	6.58
2	*5610.00	100.29 AV			3.20 H	200	93.71	6.58
3	5725.00	66.84 PK	68.20	-1.36	3.20 H	200	60.16	6.68
4	11220.00	57.71 PK	74.00	-16.29	1.57 H	134	40.55	17.16
5	11220.00	43.79 AV	54.00	-10.21	1.57 H	134	26.63	17.16

ANTENNA POLARITY & TEST DISTANCE: VERTICAL AT 3 M

NO.	FREQ. (MHz)	EMISSION LEVEL (dBuV/m)	LIMIT (dBuV/m)	MARGIN (dB)	ANTENNA HEIGHT (m)	TABLE ANGLE (Degree)	RAW VALUE (dBuV)	CORRECTION FACTOR (dB/m)
1	*5610.00	106.12 PK			1.48 V	129	99.54	6.58
2	*5610.00	96.21 AV			1.48 V	129	89.63	6.58
3	5725.00	65.35 PK	68.20	-2.85	1.48 V	129	58.67	6.68
4	11220.00	56.61 PK	74.00	-17.39	2.36 V	251	39.45	17.16
5	11220.00	43.04 AV	54.00	-10.96	2.36 V	251	25.88	17.16

REMARKS:

1. Emission Level(dBuV/m) = Raw Value(dBuV) + Correction Factor(dB/m)
2. Correction Factor(dB/m) = Antenna Factor(dB/m) + Cable Factor(dB) – Pre-Amplifier Factor(dB)
3. The other emission levels were very low against the limit.
4. Margin value = Emission Level – Limit value
5. " * ": Fundamental frequency.

CDD Mode (Mode B)

802.11a

CHANNEL	TX Channel 52	DETECTOR FUNCTION	Peak (PK)
FREQUENCY RANGE	1GHz ~ 40GHz		Average (AV)

ANTENNA POLARITY & TEST DISTANCE: HORIZONTAL AT 3 M

NO.	FREQ. (MHz)	EMISSION LEVEL (dBuV/m)	LIMIT (dBuV/m)	MARGIN (dB)	ANTENNA HEIGHT (m)	TABLE ANGLE (Degree)	RAW VALUE (dBuV)	CORRECTION FACTOR (dB/m)
1	5150.00	56.80 PK	74.00	-17.20	1.59 H	44	51.89	4.91
2	5150.00	43.14 AV	54.00	-10.86	1.59 H	44	38.23	4.91
3	*5260.00	99.79 PK			1.59 H	44	94.70	5.09
4	*5260.00	88.51 AV			1.59 H	44	83.42	5.09
5	#10520.00	55.51 PK	74.00	-18.49	1.99 H	239	39.68	15.83
6	#10520.00	42.68 AV	54.00	-11.32	1.99 H	239	26.85	15.83

ANTENNA POLARITY & TEST DISTANCE: VERTICAL AT 3 M

NO.	FREQ. (MHz)	EMISSION LEVEL (dBuV/m)	LIMIT (dBuV/m)	MARGIN (dB)	ANTENNA HEIGHT (m)	TABLE ANGLE (Degree)	RAW VALUE (dBuV)	CORRECTION FACTOR (dB/m)
1	5150.00	57.43 PK	74.00	-16.57	1.42 V	242	52.52	4.91
2	5150.00	43.67 AV	54.00	-10.33	1.42 V	242	38.76	4.91
3	*5260.00	112.24 PK			1.42 V	242	107.15	5.09
4	*5260.00	100.41 AV			1.42 V	242	95.32	5.09
5	#10520.00	56.47 PK	74.00	-17.53	1.84 V	164	40.64	15.83
6	#10520.00	43.47 AV	54.00	-10.53	1.84 V	164	27.64	15.83

REMARKS:

1. Emission Level(dBuV/m) = Raw Value(dBuV) + Correction Factor(dB/m)
2. Correction Factor(dB/m) = Antenna Factor(dB/m) + Cable Factor(dB) – Pre-Amplifier Factor(dB)
3. The other emission levels were very low against the limit.
4. Margin value = Emission Level – Limit value
5. " * ": Fundamental frequency.
6. " # ": The radiated frequency is out of the restricted band.

CHANNEL	TX Channel 60	DETECTOR FUNCTION	Peak (PK)
FREQUENCY RANGE	1GHz ~ 40GHz		Average (AV)

ANTENNA POLARITY & TEST DISTANCE: HORIZONTAL AT 3 M

NO.	FREQ. (MHz)	EMISSION LEVEL (dBuV/m)	LIMIT (dBuV/m)	MARGIN (dB)	ANTENNA HEIGHT (m)	TABLE ANGLE (Degree)	RAW VALUE (dBuV)	CORRECTION FACTOR (dB/m)
1	*5300.00	99.83 PK			1.63 H	45	94.67	5.16
2	*5300.00	88.71 AV			1.63 H	45	83.55	5.16
3	10600.00	55.55 PK	74.00	-18.45	2.18 H	167	39.63	15.92
4	10600.00	42.56 AV	54.00	-11.44	2.18 H	167	26.64	15.92

ANTENNA POLARITY & TEST DISTANCE: VERTICAL AT 3 M

NO.	FREQ. (MHz)	EMISSION LEVEL (dBuV/m)	LIMIT (dBuV/m)	MARGIN (dB)	ANTENNA HEIGHT (m)	TABLE ANGLE (Degree)	RAW VALUE (dBuV)	CORRECTION FACTOR (dB/m)
1	*5300.00	112.80 PK			1.40 V	248	107.64	5.16
2	*5300.00	101.01 AV			1.40 V	248	95.85	5.16
3	10600.00	56.59 PK	74.00	-17.41	1.77 V	154	40.67	15.92
4	10600.00	43.60 AV	54.00	-10.40	1.77 V	154	27.68	15.92

REMARKS:

1. Emission Level(dBuV/m) = Raw Value(dBuV) + Correction Factor(dB/m)
2. Correction Factor(dB/m) = Antenna Factor(dB/m) + Cable Factor(dB) – Pre-Amplifier Factor(dB)
3. The other emission levels were very low against the limit.
4. Margin value = Emission Level – Limit value
5. " * ": Fundamental frequency.

CHANNEL	TX Channel 64	DETECTOR FUNCTION	Peak (PK)
FREQUENCY RANGE	1GHz ~ 40GHz		Average (AV)

ANTENNA POLARITY & TEST DISTANCE: HORIZONTAL AT 3 M

NO.	FREQ. (MHz)	EMISSION LEVEL (dBuV/m)	LIMIT (dBuV/m)	MARGIN (dB)	ANTENNA HEIGHT (m)	TABLE ANGLE (Degree)	RAW VALUE (dBuV)	CORRECTION FACTOR (dB/m)
1	*5320.00	98.80 PK			1.45 H	49	93.56	5.24
2	*5320.00	87.83 AV			1.45 H	49	82.59	5.24
3	5350.00	55.37 PK	74.00	-18.63	1.45 H	49	50.02	5.35
4	5350.00	42.02 AV	54.00	-11.98	1.45 H	49	36.67	5.35
5	10640.00	55.68 PK	74.00	-18.32	1.88 H	269	39.62	16.06
6	10640.00	42.40 AV	54.00	-11.60	1.88 H	269	26.34	16.06

ANTENNA POLARITY & TEST DISTANCE: VERTICAL AT 3 M

NO.	FREQ. (MHz)	EMISSION LEVEL (dBuV/m)	LIMIT (dBuV/m)	MARGIN (dB)	ANTENNA HEIGHT (m)	TABLE ANGLE (Degree)	RAW VALUE (dBuV)	CORRECTION FACTOR (dB/m)
1	*5320.00	111.31 PK			1.42 V	225	106.07	5.24
2	*5320.00	99.58 AV			1.42 V	225	94.34	5.24
3	5350.00	55.74 PK	74.00	-18.26	1.42 V	225	50.39	5.35
4	5350.00	45.34 AV	54.00	-8.66	1.42 V	225	39.99	5.35
5	10640.00	56.50 PK	74.00	-17.50	1.55 V	288	40.44	16.06
6	10640.00	43.25 AV	54.00	-10.75	1.55 V	288	27.19	16.06

REMARKS:

1. Emission Level(dBuV/m) = Raw Value(dBuV) + Correction Factor(dB/m)
2. Correction Factor(dB/m) = Antenna Factor(dB/m) + Cable Factor(dB) – Pre-Amplifier Factor(dB)
3. The other emission levels were very low against the limit.
4. Margin value = Emission Level – Limit value
5. " * ": Fundamental frequency.

CHANNEL	TX Channel 100	DETECTOR FUNCTION	Peak (PK)
FREQUENCY RANGE	1GHz ~ 40GHz		Average (AV)

ANTENNA POLARITY & TEST DISTANCE: HORIZONTAL AT 3 M

NO.	FREQ. (MHz)	EMISSION LEVEL (dBuV/m)	LIMIT (dBuV/m)	MARGIN (dB)	ANTENNA HEIGHT (m)	TABLE ANGLE (Degree)	RAW VALUE (dBuV)	CORRECTION FACTOR (dB/m)
1	5460.00	56.24 PK	74.00	-17.76	1.41 H	13	50.47	5.77
2	5460.00	43.90 AV	54.00	-10.10	1.41 H	13	38.13	5.77
3	5470.00	59.97 PK	68.20	-8.23	1.41 H	13	54.15	5.82
4	*5500.00	108.10 PK			1.41 H	13	102.16	5.94
5	*5500.00	97.59 AV			1.41 H	13	91.65	5.94
6	11000.00	57.03 PK	74.00	-16.97	2.57 H	46	39.67	17.36
7	11000.00	43.55 AV	54.00	-10.45	2.57 H	46	26.19	17.36

ANTENNA POLARITY & TEST DISTANCE: VERTICAL AT 3 M

NO.	FREQ. (MHz)	EMISSION LEVEL (dBuV/m)	LIMIT (dBuV/m)	MARGIN (dB)	ANTENNA HEIGHT (m)	TABLE ANGLE (Degree)	RAW VALUE (dBuV)	CORRECTION FACTOR (dB/m)
1	5460.00	57.64 PK	74.00	-16.36	1.42 V	132	51.87	5.77
2	5460.00	44.73 AV	54.00	-9.27	1.42 V	132	38.96	5.77
3	5470.00	62.14 PK	68.20	-6.06	1.42 V	132	56.32	5.82
4	*5500.00	118.68 PK			1.42 V	132	112.74	5.94
5	*5500.00	107.25 AV			1.42 V	132	101.31	5.94
6	11000.00	57.52 PK	74.00	-16.48	1.87 V	164	40.16	17.36
7	11000.00	45.25 AV	54.00	-8.75	1.87 V	164	27.89	17.36

REMARKS:

1. Emission Level(dBuV/m) = Raw Value(dBuV) + Correction Factor(dB/m)
2. Correction Factor(dB/m) = Antenna Factor(dB/m) + Cable Factor(dB) – Pre-Amplifier Factor(dB)
3. The other emission levels were very low against the limit.
4. Margin value = Emission Level – Limit value
5. " * ": Fundamental frequency.

CHANNEL	TX Channel 116	DETECTOR FUNCTION	Peak (PK)
FREQUENCY RANGE	1GHz ~ 40GHz		Average (AV)

ANTENNA POLARITY & TEST DISTANCE: HORIZONTAL AT 3 M

NO.	FREQ. (MHz)	EMISSION LEVEL (dBuV/m)	LIMIT (dBuV/m)	MARGIN (dB)	ANTENNA HEIGHT (m)	TABLE ANGLE (Degree)	RAW VALUE (dBuV)	CORRECTION FACTOR (dB/m)
1	*5580.00	108.60 PK			1.39 H	26	102.16	6.44
2	*5580.00	98.02 AV			1.39 H	26	91.58	6.44
3	11160.00	56.86 PK	74.00	-17.14	2.51 H	84	39.56	17.30
4	11160.00	43.94 AV	54.00	-10.06	2.51 H	84	26.64	17.30

ANTENNA POLARITY & TEST DISTANCE: VERTICAL AT 3 M

NO.	FREQ. (MHz)	EMISSION LEVEL (dBuV/m)	LIMIT (dBuV/m)	MARGIN (dB)	ANTENNA HEIGHT (m)	TABLE ANGLE (Degree)	RAW VALUE (dBuV)	CORRECTION FACTOR (dB/m)
1	*5580.00	118.89 PK			1.46 V	142	112.45	6.44
2	*5580.00	107.70 AV			1.46 V	142	101.26	6.44
3	11160.00	58.15 PK	74.00	-15.85	1.89 V	254	40.85	17.30
4	11160.00	44.73 AV	54.00	-9.27	1.89 V	254	27.43	17.30

REMARKS:

1. Emission Level(dBuV/m) = Raw Value(dBuV) + Correction Factor(dB/m)
2. Correction Factor(dB/m) = Antenna Factor(dB/m) + Cable Factor(dB) – Pre-Amplifier Factor(dB)
3. The other emission levels were very low against the limit.
4. Margin value = Emission Level – Limit value
5. " * ": Fundamental frequency.

CHANNEL	TX Channel 132	DETECTOR FUNCTION	Peak (PK)
FREQUENCY RANGE	1GHz ~ 40GHz		Average (AV)

ANTENNA POLARITY & TEST DISTANCE: HORIZONTAL AT 3 M

NO.	FREQ. (MHz)	EMISSION LEVEL (dBuV/m)	LIMIT (dBuV/m)	MARGIN (dB)	ANTENNA HEIGHT (m)	TABLE ANGLE (Degree)	RAW VALUE (dBuV)	CORRECTION FACTOR (dB/m)
1	*5660.00	108.90 PK			1.38 H	27	102.28	6.62
2	*5660.00	98.00 AV			1.38 H	27	91.38	6.62
3	11320.00	56.49 PK	74.00	-17.51	1.87 H	164	39.50	16.99
4	11320.00	43.39 AV	54.00	-10.61	1.87 H	164	26.40	16.99

ANTENNA POLARITY & TEST DISTANCE: VERTICAL AT 3 M

NO.	FREQ. (MHz)	EMISSION LEVEL (dBuV/m)	LIMIT (dBuV/m)	MARGIN (dB)	ANTENNA HEIGHT (m)	TABLE ANGLE (Degree)	RAW VALUE (dBuV)	CORRECTION FACTOR (dB/m)
1	*5660.00	119.16 PK			1.47 V	139	112.54	6.62
2	*5660.00	108.46 AV			1.47 V	139	101.84	6.62
3	11320.00	57.67 PK	74.00	-16.33	2.15 V	156	40.68	16.99
4	11320.00	44.63 AV	54.00	-9.37	2.15 V	156	27.64	16.99

REMARKS:

1. Emission Level(dBuV/m) = Raw Value(dBuV) + Correction Factor(dB/m)
2. Correction Factor(dB/m) = Antenna Factor(dB/m) + Cable Factor(dB) – Pre-Amplifier Factor(dB)
3. The other emission levels were very low against the limit.
4. Margin value = Emission Level – Limit value
5. " * ": Fundamental frequency.

CHANNEL	TX Channel 140	DETECTOR FUNCTION	Peak (PK)
FREQUENCY RANGE	1GHz ~ 40GHz		Average (AV)

ANTENNA POLARITY & TEST DISTANCE: HORIZONTAL AT 3 M

NO.	FREQ. (MHz)	EMISSION LEVEL (dBuV/m)	LIMIT (dBuV/m)	MARGIN (dB)	ANTENNA HEIGHT (m)	TABLE ANGLE (Degree)	RAW VALUE (dBuV)	CORRECTION FACTOR (dB/m)
1	*5700.00	108.83 PK			1.58 H	69	102.18	6.65
2	*5700.00	98.30 AV			1.58 H	69	91.65	6.65
3	5725.00	64.84 PK	68.20	-3.36	1.58 H	69	58.16	6.68
4	11400.00	56.65 PK	74.00	-17.35	1.52 H	134	39.65	17.00
5	11400.00	43.34 AV	54.00	-10.66	1.52 H	134	26.34	17.00

ANTENNA POLARITY & TEST DISTANCE: VERTICAL AT 3 M

NO.	FREQ. (MHz)	EMISSION LEVEL (dBuV/m)	LIMIT (dBuV/m)	MARGIN (dB)	ANTENNA HEIGHT (m)	TABLE ANGLE (Degree)	RAW VALUE (dBuV)	CORRECTION FACTOR (dB/m)
1	*5700.00	118.84 PK			1.72 V	159	112.19	6.65
2	*5700.00	107.71 AV			1.72 V	159	101.06	6.65
3	5725.00	66.09 PK	68.20	-2.11	1.72 V	159	59.41	6.68
4	11400.00	57.55 PK	74.00	-16.45	1.84 V	125	40.55	17.00
5	11400.00	44.42 AV	54.00	-9.58	1.84 V	125	27.42	17.00

REMARKS:

1. Emission Level(dBuV/m) = Raw Value(dBuV) + Correction Factor(dB/m)
2. Correction Factor(dB/m) = Antenna Factor(dB/m) + Cable Factor(dB) – Pre-Amplifier Factor(dB)
3. The other emission levels were very low against the limit.
4. Margin value = Emission Level – Limit value
5. " * ": Fundamental frequency.

802.11ac (20MHz)

CHANNEL	TX Channel 52	DETECTOR FUNCTION	Peak (PK)
FREQUENCY RANGE	1GHz ~ 40GHz		Average (AV)

ANTENNA POLARITY & TEST DISTANCE: HORIZONTAL AT 3 M

NO.	FREQ. (MHz)	EMISSION LEVEL (dBuV/m)	LIMIT (dBuV/m)	MARGIN (dB)	ANTENNA HEIGHT (m)	TABLE ANGLE (Degree)	RAW VALUE (dBuV)	CORRECTION FACTOR (dB/m)
1	5150.00	55.94 PK	74.00	-18.06	1.59 H	14	51.03	4.91
2	5150.00	43.79 AV	54.00	-10.21	1.59 H	14	38.88	4.91
3	*5260.00	101.35 PK			1.59 H	14	96.26	5.09
4	*5260.00	90.55 AV			1.59 H	14	85.46	5.09
5	#10520.00	55.39 PK	74.00	-18.61	1.75 H	169	39.56	15.83
6	#10520.00	41.47 AV	54.00	-12.53	1.75 H	169	25.64	15.83

ANTENNA POLARITY & TEST DISTANCE: VERTICAL AT 3 M

NO.	FREQ. (MHz)	EMISSION LEVEL (dBuV/m)	LIMIT (dBuV/m)	MARGIN (dB)	ANTENNA HEIGHT (m)	TABLE ANGLE (Degree)	RAW VALUE (dBuV)	CORRECTION FACTOR (dB/m)
1	5150.00	56.37 PK	74.00	-17.63	1.67 V	140	51.46	4.91
2	5150.00	44.27 AV	54.00	-9.73	1.67 V	140	39.36	4.91
3	*5260.00	113.13 PK			1.67 V	140	108.04	5.09
4	*5260.00	98.38 AV			1.67 V	140	93.29	5.09
5	#10520.00	56.19 PK	74.00	-17.81	2.25 V	215	40.36	15.83
6	#10520.00	42.22 AV	54.00	-11.78	2.25 V	215	26.39	15.83

REMARKS:

1. Emission Level(dBuV/m) = Raw Value(dBuV) + Correction Factor(dB/m)
2. Correction Factor(dB/m) = Antenna Factor(dB/m) + Cable Factor(dB) – Pre-Amplifier Factor(dB)
3. The other emission levels were very low against the limit.
4. Margin value = Emission Level – Limit value
5. " * ": Fundamental frequency.
6. " # ": The radiated frequency is out of the restricted band.

CHANNEL	TX Channel 60	DETECTOR FUNCTION	Peak (PK)
FREQUENCY RANGE	1GHz ~ 40GHz		Average (AV)

ANTENNA POLARITY & TEST DISTANCE: HORIZONTAL AT 3 M

NO.	FREQ. (MHz)	EMISSION LEVEL (dBuV/m)	LIMIT (dBuV/m)	MARGIN (dB)	ANTENNA HEIGHT (m)	TABLE ANGLE (Degree)	RAW VALUE (dBuV)	CORRECTION FACTOR (dB/m)
1	*5300.00	102.00 PK			1.44 H	23	96.84	5.16
2	*5300.00	89.41 AV			1.44 H	23	84.25	5.16
3	10600.00	55.43 PK	74.00	-18.57	2.51 H	182	39.51	15.92
4	10600.00	41.53 AV	54.00	-12.47	2.51 H	182	25.61	15.92

ANTENNA POLARITY & TEST DISTANCE: VERTICAL AT 3 M

NO.	FREQ. (MHz)	EMISSION LEVEL (dBuV/m)	LIMIT (dBuV/m)	MARGIN (dB)	ANTENNA HEIGHT (m)	TABLE ANGLE (Degree)	RAW VALUE (dBuV)	CORRECTION FACTOR (dB/m)
1	*5300.00	113.64 PK			1.77 V	149	108.48	5.16
2	*5300.00	99.04 AV			1.77 V	149	93.88	5.16
3	10600.00	56.77 PK	74.00	-17.23	1.97 V	144	40.85	15.92
4	10600.00	42.23 AV	54.00	-11.77	1.97 V	144	26.31	15.92

REMARKS:

1. Emission Level(dBuV/m) = Raw Value(dBuV) + Correction Factor(dB/m)
2. Correction Factor(dB/m) = Antenna Factor(dB/m) + Cable Factor(dB) – Pre-Amplifier Factor(dB)
3. The other emission levels were very low against the limit.
4. Margin value = Emission Level – Limit value
5. " * ": Fundamental frequency.

CHANNEL	TX Channel 64	DETECTOR FUNCTION	Peak (PK)
FREQUENCY RANGE	1GHz ~ 40GHz		Average (AV)

ANTENNA POLARITY & TEST DISTANCE: HORIZONTAL AT 3 M

NO.	FREQ. (MHz)	EMISSION LEVEL (dBuV/m)	LIMIT (dBuV/m)	MARGIN (dB)	ANTENNA HEIGHT (m)	TABLE ANGLE (Degree)	RAW VALUE (dBuV)	CORRECTION FACTOR (dB/m)
1	*5320.00	101.79 PK			1.45 H	28	96.55	5.24
2	*5320.00	90.50 AV			1.45 H	28	85.26	5.24
3	5350.00	55.38 PK	74.00	-18.62	1.45 H	28	50.03	5.35
4	5350.00	42.34 AV	54.00	-11.66	1.45 H	28	36.99	5.35
5	10640.00	55.72 PK	74.00	-18.28	2.59 H	200	39.66	16.06
6	10640.00	41.14 AV	54.00	-12.86	2.59 H	200	25.08	16.06

ANTENNA POLARITY & TEST DISTANCE: VERTICAL AT 3 M

NO.	FREQ. (MHz)	EMISSION LEVEL (dBuV/m)	LIMIT (dBuV/m)	MARGIN (dB)	ANTENNA HEIGHT (m)	TABLE ANGLE (Degree)	RAW VALUE (dBuV)	CORRECTION FACTOR (dB/m)
1	*5320.00	112.89 PK			1.72 V	152	107.65	5.24
2	*5320.00	97.82 AV			1.72 V	152	92.58	5.24
3	5350.00	55.61 PK	74.00	-18.39	1.72 V	152	50.26	5.35
4	5350.00	43.19 AV	54.00	-10.81	1.72 V	152	37.84	5.35
5	10640.00	56.66 PK	74.00	-17.34	1.88 V	298	40.60	16.06
6	10640.00	42.37 AV	54.00	-11.63	1.88 V	298	26.31	16.06

REMARKS:

1. Emission Level(dBuV/m) = Raw Value(dBuV) + Correction Factor(dB/m)
2. Correction Factor(dB/m) = Antenna Factor(dB/m) + Cable Factor(dB) – Pre-Amplifier Factor(dB)
3. The other emission levels were very low against the limit.
4. Margin value = Emission Level – Limit value
5. " * ": Fundamental frequency.

CHANNEL	TX Channel 100	DETECTOR FUNCTION	Peak (PK)
FREQUENCY RANGE	1GHz ~ 40GHz		Average (AV)

ANTENNA POLARITY & TEST DISTANCE: HORIZONTAL AT 3 M

NO.	FREQ. (MHz)	EMISSION LEVEL (dBuV/m)	LIMIT (dBuV/m)	MARGIN (dB)	ANTENNA HEIGHT (m)	TABLE ANGLE (Degree)	RAW VALUE (dBuV)	CORRECTION FACTOR (dB/m)
1	5460.00	58.79 PK	74.00	-15.21	1.68 H	55	53.02	5.77
2	5460.00	45.93 AV	54.00	-8.07	1.68 H	55	40.16	5.77
3	5470.00	57.98 PK	68.20	-10.22	1.68 H	55	52.16	5.82
4	*5500.00	108.39 PK			1.68 H	55	102.45	5.94
5	*5500.00	95.61 AV			1.68 H	55	89.67	5.94
6	11000.00	56.81 PK	74.00	-17.19	2.23 H	36	39.45	17.36
7	11000.00	42.44 AV	54.00	-11.56	2.23 H	36	25.08	17.36

ANTENNA POLARITY & TEST DISTANCE: VERTICAL AT 3 M

NO.	FREQ. (MHz)	EMISSION LEVEL (dBuV/m)	LIMIT (dBuV/m)	MARGIN (dB)	ANTENNA HEIGHT (m)	TABLE ANGLE (Degree)	RAW VALUE (dBuV)	CORRECTION FACTOR (dB/m)
1	5460.00	59.88 PK	74.00	-14.12	1.50 V	123	54.11	5.77
2	5460.00	46.96 AV	54.00	-7.04	1.50 V	123	41.19	5.77
3	5470.00	60.19 PK	68.20	-8.01	1.50 V	123	54.37	5.82
4	*5500.00	118.42 PK			1.50 V	123	112.48	5.94
5	*5500.00	105.75 AV			1.50 V	123	99.81	5.94
6	11000.00	57.87 PK	74.00	-16.13	2.71 V	154	40.51	17.36
7	11000.00	43.79 AV	54.00	-10.21	2.71 V	154	26.43	17.36

REMARKS:

1. Emission Level(dBuV/m) = Raw Value(dBuV) + Correction Factor(dB/m)
2. Correction Factor(dB/m) = Antenna Factor(dB/m) + Cable Factor(dB) – Pre-Amplifier Factor(dB)
3. The other emission levels were very low against the limit.
4. Margin value = Emission Level – Limit value
5. " * ": Fundamental frequency.

CHANNEL	TX Channel 116	DETECTOR FUNCTION	Peak (PK)
FREQUENCY RANGE	1GHz ~ 40GHz		Average (AV)

ANTENNA POLARITY & TEST DISTANCE: HORIZONTAL AT 3 M

NO.	FREQ. (MHz)	EMISSION LEVEL (dBuV/m)	LIMIT (dBuV/m)	MARGIN (dB)	ANTENNA HEIGHT (m)	TABLE ANGLE (Degree)	RAW VALUE (dBuV)	CORRECTION FACTOR (dB/m)
1	*5580.00	108.98 PK			1.74 H	62	102.54	6.44
2	*5580.00	96.10 AV			1.74 H	62	89.66	6.44
3	11160.00	56.96 PK	74.00	-17.04	1.99 H	268	39.66	17.30
4	11160.00	42.56 AV	54.00	-11.44	1.99 H	268	25.26	17.30

ANTENNA POLARITY & TEST DISTANCE: VERTICAL AT 3 M

NO.	FREQ. (MHz)	EMISSION LEVEL (dBuV/m)	LIMIT (dBuV/m)	MARGIN (dB)	ANTENNA HEIGHT (m)	TABLE ANGLE (Degree)	RAW VALUE (dBuV)	CORRECTION FACTOR (dB/m)
1	*5580.00	119.02 PK			1.56 V	131	112.58	6.44
2	*5580.00	105.80 AV			1.56 V	131	99.36	6.44
3	11160.00	57.88 PK	74.00	-16.12	1.84 V	269	40.58	17.30
4	11160.00	44.15 AV	54.00	-9.85	1.84 V	269	26.85	17.30

REMARKS:

1. Emission Level(dBuV/m) = Raw Value(dBuV) + Correction Factor(dB/m)
2. Correction Factor(dB/m) = Antenna Factor(dB/m) + Cable Factor(dB) – Pre-Amplifier Factor(dB)
3. The other emission levels were very low against the limit.
4. Margin value = Emission Level – Limit value
5. " * ": Fundamental frequency.

CHANNEL	TX Channel 132	DETECTOR FUNCTION	Peak (PK)
FREQUENCY RANGE	1GHz ~ 40GHz		Average (AV)

ANTENNA POLARITY & TEST DISTANCE: HORIZONTAL AT 3 M

NO.	FREQ. (MHz)	EMISSION LEVEL (dBuV/m)	LIMIT (dBuV/m)	MARGIN (dB)	ANTENNA HEIGHT (m)	TABLE ANGLE (Degree)	RAW VALUE (dBuV)	CORRECTION FACTOR (dB/m)
1	*5660.00	109.20 PK			1.62 H	54	102.58	6.62
2	*5660.00	96.46 AV			1.62 H	54	89.84	6.62
3	11320.00	56.63 PK	74.00	-17.37	1.00 H	226	39.64	16.99
4	11320.00	42.50 AV	54.00	-11.50	1.00 H	226	25.51	16.99

ANTENNA POLARITY & TEST DISTANCE: VERTICAL AT 3 M

NO.	FREQ. (MHz)	EMISSION LEVEL (dBuV/m)	LIMIT (dBuV/m)	MARGIN (dB)	ANTENNA HEIGHT (m)	TABLE ANGLE (Degree)	RAW VALUE (dBuV)	CORRECTION FACTOR (dB/m)
1	*5660.00	118.88 PK			1.53 V	122	112.26	6.62
2	*5660.00	106.25 AV			1.53 V	122	99.63	6.62
3	11320.00	57.83 PK	74.00	-16.17	2.16 V	298	40.84	16.99
4	11320.00	43.95 AV	54.00	-10.05	2.16 V	298	26.96	16.99

REMARKS:

1. Emission Level(dBuV/m) = Raw Value(dBuV) + Correction Factor(dB/m)
2. Correction Factor(dB/m) = Antenna Factor(dB/m) + Cable Factor(dB) – Pre-Amplifier Factor(dB)
3. The other emission levels were very low against the limit.
4. Margin value = Emission Level – Limit value
5. " * ": Fundamental frequency.

CHANNEL	TX Channel 140	DETECTOR FUNCTION	Peak (PK)
FREQUENCY RANGE	1GHz ~ 40GHz		Average (AV)

ANTENNA POLARITY & TEST DISTANCE: HORIZONTAL AT 3 M

NO.	FREQ. (MHz)	EMISSION LEVEL (dBuV/m)	LIMIT (dBuV/m)	MARGIN (dB)	ANTENNA HEIGHT (m)	TABLE ANGLE (Degree)	RAW VALUE (dBuV)	CORRECTION FACTOR (dB/m)
1	*5700.00	110.30 PK			1.69 H	84	103.65	6.65
2	*5700.00	98.91 AV			1.69 H	84	92.26	6.65
3	5725.00	62.94 PK	68.20	-5.26	1.69 H	84	56.26	6.68
4	11400.00	56.45 PK	74.00	-17.55	1.27 H	55	39.45	17.00
5	11400.00	42.64 AV	54.00	-11.36	1.27 H	55	25.64	17.00

ANTENNA POLARITY & TEST DISTANCE: VERTICAL AT 3 M

NO.	FREQ. (MHz)	EMISSION LEVEL (dBuV/m)	LIMIT (dBuV/m)	MARGIN (dB)	ANTENNA HEIGHT (m)	TABLE ANGLE (Degree)	RAW VALUE (dBuV)	CORRECTION FACTOR (dB/m)
1	*5700.00	120.08 PK			2.11 V	56	113.43	6.65
2	*5700.00	108.87 AV			2.11 V	56	102.22	6.65
3	5725.00	66.21 PK	68.20	-1.99	2.11 V	56	59.53	6.68
4	11400.00	57.56 PK	74.00	-16.44	2.50 V	261	40.56	17.00
5	11400.00	43.63 AV	54.00	-10.37	2.50 V	261	26.63	17.00

REMARKS:

1. Emission Level(dBuV/m) = Raw Value(dBuV) + Correction Factor(dB/m)
2. Correction Factor(dB/m) = Antenna Factor(dB/m) + Cable Factor(dB) – Pre-Amplifier Factor(dB)
3. The other emission levels were very low against the limit.
4. Margin value = Emission Level – Limit value
5. " * ": Fundamental frequency.

802.11ac (40MHz)

CHANNEL	TX Channel 54	DETECTOR FUNCTION	Peak (PK)
FREQUENCY RANGE	1GHz ~ 40GHz		Average (AV)

ANTENNA POLARITY & TEST DISTANCE: HORIZONTAL AT 3 M

NO.	FREQ. (MHz)	EMISSION LEVEL (dBuV/m)	LIMIT (dBuV/m)	MARGIN (dB)	ANTENNA HEIGHT (m)	TABLE ANGLE (Degree)	RAW VALUE (dBuV)	CORRECTION FACTOR (dB/m)
1	*5270.00	99.27 PK			1.44 H	29	94.16	5.11
2	*5270.00	88.37 AV			1.44 H	29	83.26	5.11
3	5350.00	57.77 PK	74.00	-16.23	1.44 H	29	52.42	5.35
4	5350.00	42.78 AV	54.00	-11.22	1.44 H	29	37.43	5.35
5	#10540.00	54.98 PK	74.00	-19.02	2.61 H	103	39.13	15.85
6	#10540.00	42.28 AV	54.00	-11.72	2.61 H	103	26.43	15.85

ANTENNA POLARITY & TEST DISTANCE: VERTICAL AT 3 M

NO.	FREQ. (MHz)	EMISSION LEVEL (dBuV/m)	LIMIT (dBuV/m)	MARGIN (dB)	ANTENNA HEIGHT (m)	TABLE ANGLE (Degree)	RAW VALUE (dBuV)	CORRECTION FACTOR (dB/m)
1	5150.00	57.85 PK	74.00	-16.15	1.50 V	241	52.94	4.91
2	5150.00	43.66 AV	54.00	-10.34	1.50 V	241	38.75	4.91
3	*5270.00	109.49 PK			1.50 V	241	104.38	5.11
4	*5270.00	98.25 AV			1.50 V	241	93.14	5.11
5	#10540.00	56.69 PK	74.00	-17.31	1.86 V	321	40.84	15.85
6	#10540.00	43.00 AV	54.00	-11.00	1.86 V	321	27.15	15.85

REMARKS:

1. Emission Level(dBuV/m) = Raw Value(dBuV) + Correction Factor(dB/m)
2. Correction Factor(dB/m) = Antenna Factor(dB/m) + Cable Factor(dB) – Pre-Amplifier Factor(dB)
3. The other emission levels were very low against the limit.
4. Margin value = Emission Level – Limit value
5. " * ": Fundamental frequency.
6. " # ": The radiated frequency is out of the restricted band.

CHANNEL	TX Channel 62	DETECTOR FUNCTION	Peak (PK)
FREQUENCY RANGE	1GHz ~ 40GHz		Average (AV)

ANTENNA POLARITY & TEST DISTANCE: HORIZONTAL AT 3 M

NO.	FREQ. (MHz)	EMISSION LEVEL (dBuV/m)	LIMIT (dBuV/m)	MARGIN (dB)	ANTENNA HEIGHT (m)	TABLE ANGLE (Degree)	RAW VALUE (dBuV)	CORRECTION FACTOR (dB/m)
1	*5310.00	98.66 PK			1.41 H	49	93.46	5.20
2	*5310.00	86.64 AV			1.41 H	49	81.44	5.20
3	5350.00	55.38 PK	74.00	-18.62	1.41 H	49	50.03	5.35
4	5350.00	42.11 AV	54.00	-11.89	1.41 H	49	36.76	5.35
5	10620.00	55.45 PK	74.00	-18.55	1.87 H	164	39.46	15.99
6	10620.00	42.37 AV	54.00	-11.63	1.87 H	164	26.38	15.99

ANTENNA POLARITY & TEST DISTANCE: VERTICAL AT 3 M

NO.	FREQ. (MHz)	EMISSION LEVEL (dBuV/m)	LIMIT (dBuV/m)	MARGIN (dB)	ANTENNA HEIGHT (m)	TABLE ANGLE (Degree)	RAW VALUE (dBuV)	CORRECTION FACTOR (dB/m)
1	*5310.00	108.58 PK			1.64 V	243	103.38	5.20
2	*5310.00	96.81 AV			1.64 V	243	91.61	5.20
3	5350.00	55.63 PK	74.00	-18.37	1.64 V	243	50.28	5.35
4	5350.00	42.35 AV	54.00	-11.65	1.64 V	243	37.00	5.35
5	10620.00	56.62 PK	74.00	-17.38	1.57 V	124	40.63	15.99
6	10620.00	43.45 AV	54.00	-10.55	1.57 V	124	27.46	15.99

REMARKS:

1. Emission Level(dBuV/m) = Raw Value(dBuV) + Correction Factor(dB/m)
2. Correction Factor(dB/m) = Antenna Factor(dB/m) + Cable Factor(dB) – Pre-Amplifier Factor(dB)
3. The other emission levels were very low against the limit.
4. Margin value = Emission Level – Limit value
5. " * ": Fundamental frequency.

CHANNEL	TX Channel 102	DETECTOR FUNCTION	Peak (PK)
FREQUENCY RANGE	1GHz ~ 40GHz		Average (AV)

ANTENNA POLARITY & TEST DISTANCE: HORIZONTAL AT 3 M

NO.	FREQ. (MHz)	EMISSION LEVEL (dBuV/m)	LIMIT (dBuV/m)	MARGIN (dB)	ANTENNA HEIGHT (m)	TABLE ANGLE (Degree)	RAW VALUE (dBuV)	CORRECTION FACTOR (dB/m)
1	5460.00	62.11 PK	74.00	-11.89	1.64 H	25	56.34	5.77
2	5460.00	47.93 AV	54.00	-6.07	1.64 H	25	42.16	5.77
3	5470.00	63.67 PK	68.20	-4.53	1.64 H	25	57.85	5.82
4	*5510.00	107.25 PK			1.64 H	25	101.24	6.01
5	*5510.00	96.67 AV			1.64 H	25	90.66	6.01
6	11020.00	57.03 PK	74.00	-16.97	1.92 H	231	39.64	17.39
7	11020.00	43.73 AV	54.00	-10.27	1.92 H	231	26.34	17.39

ANTENNA POLARITY & TEST DISTANCE: VERTICAL AT 3 M

NO.	FREQ. (MHz)	EMISSION LEVEL (dBuV/m)	LIMIT (dBuV/m)	MARGIN (dB)	ANTENNA HEIGHT (m)	TABLE ANGLE (Degree)	RAW VALUE (dBuV)	CORRECTION FACTOR (dB/m)
1	5460.00	65.43 PK	74.00	-8.57	1.77 V	230	59.66	5.77
2	5460.00	51.33 AV	54.00	-2.67	1.77 V	230	45.56	5.77
3	5470.00	66.97 PK	68.20	-1.23	1.77 V	230	61.15	5.82
4	*5510.00	117.16 PK			1.77 V	230	111.15	6.01
5	*5510.00	106.09 AV			1.77 V	230	100.08	6.01
6	11020.00	58.23 PK	74.00	-15.77	1.84 V	251	40.84	17.39
7	11020.00	44.84 AV	54.00	-9.16	1.84 V	251	27.45	17.39

REMARKS:

1. Emission Level(dBuV/m) = Raw Value(dBuV) + Correction Factor(dB/m)
2. Correction Factor(dB/m) = Antenna Factor(dB/m) + Cable Factor(dB) – Pre-Amplifier Factor(dB)
3. The other emission levels were very low against the limit.
4. Margin value = Emission Level – Limit value
5. " * ": Fundamental frequency.

CHANNEL	TX Channel 110	DETECTOR FUNCTION	Peak (PK)
FREQUENCY RANGE	1GHz ~ 40GHz		Average (AV)

ANTENNA POLARITY & TEST DISTANCE: HORIZONTAL AT 3 M

NO.	FREQ. (MHz)	EMISSION LEVEL (dBuV/m)	LIMIT (dBuV/m)	MARGIN (dB)	ANTENNA HEIGHT (m)	TABLE ANGLE (Degree)	RAW VALUE (dBuV)	CORRECTION FACTOR (dB/m)
1	*5550.00	107.72 PK			1.58 H	45	101.46	6.26
2	*5550.00	96.92 AV			1.58 H	45	90.66	6.26
3	11100.00	56.81 PK	74.00	-17.19	1.95 H	241	39.34	17.47
4	11100.00	44.16 AV	54.00	-9.84	1.95 H	241	26.69	17.47

ANTENNA POLARITY & TEST DISTANCE: VERTICAL AT 3 M

NO.	FREQ. (MHz)	EMISSION LEVEL (dBuV/m)	LIMIT (dBuV/m)	MARGIN (dB)	ANTENNA HEIGHT (m)	TABLE ANGLE (Degree)	RAW VALUE (dBuV)	CORRECTION FACTOR (dB/m)
1	*5550.00	117.52 PK			1.84 V	239	111.26	6.26
2	*5550.00	106.71 AV			1.84 V	239	100.45	6.26
3	11100.00	57.83 PK	74.00	-16.17	1.84 V	251	40.36	17.47
4	11100.00	45.11 AV	54.00	-8.89	1.84 V	251	27.64	17.47

REMARKS:

1. Emission Level(dBuV/m) = Raw Value(dBuV) + Correction Factor(dB/m)
2. Correction Factor(dB/m) = Antenna Factor(dB/m) + Cable Factor(dB) – Pre-Amplifier Factor(dB)
3. The other emission levels were very low against the limit.
4. Margin value = Emission Level – Limit value
5. " * ": Fundamental frequency.

CHANNEL	TX Channel 134	DETECTOR FUNCTION	Peak (PK)
FREQUENCY RANGE	1GHz ~ 40GHz		Average (AV)

ANTENNA POLARITY & TEST DISTANCE: HORIZONTAL AT 3 M

NO.	FREQ. (MHz)	EMISSION LEVEL (dBuV/m)	LIMIT (dBuV/m)	MARGIN (dB)	ANTENNA HEIGHT (m)	TABLE ANGLE (Degree)	RAW VALUE (dBuV)	CORRECTION FACTOR (dB/m)
1	*5670.00	107.79 PK			1.82 H	100	101.16	6.63
2	*5670.00	96.41 AV			1.82 H	100	89.78	6.63
3	5725.00	61.94 PK	68.20	-6.26	1.82 H	100	55.26	6.68
4	11340.00	56.63 PK	74.00	-17.37	1.88 H	120	39.64	16.99
5	11340.00	42.81 AV	54.00	-11.19	1.88 H	120	25.82	16.99

ANTENNA POLARITY & TEST DISTANCE: VERTICAL AT 3 M

NO.	FREQ. (MHz)	EMISSION LEVEL (dBuV/m)	LIMIT (dBuV/m)	MARGIN (dB)	ANTENNA HEIGHT (m)	TABLE ANGLE (Degree)	RAW VALUE (dBuV)	CORRECTION FACTOR (dB/m)
1	*5670.00	117.91 PK			2.20 V	229	111.28	6.63
2	*5670.00	106.62 AV			2.20 V	229	99.99	6.63
3	5725.00	65.24 PK	68.20	-2.96	2.20 V	229	58.56	6.68
4	11340.00	57.48 PK	74.00	-16.52	1.84 V	173	40.49	16.99
5	11340.00	43.76 AV	54.00	-10.24	1.84 V	173	26.77	16.99

REMARKS:

1. Emission Level(dBuV/m) = Raw Value(dBuV) + Correction Factor(dB/m)
2. Correction Factor(dB/m) = Antenna Factor(dB/m) + Cable Factor(dB) – Pre-Amplifier Factor(dB)
3. The other emission levels were very low against the limit.
4. Margin value = Emission Level – Limit value
5. " * ": Fundamental frequency.

802.11ac (80MHz)

CHANNEL	TX Channel 58	DETECTOR FUNCTION	Peak (PK)
FREQUENCY RANGE	1GHz ~ 40GHz		Average (AV)

ANTENNA POLARITY & TEST DISTANCE: HORIZONTAL AT 3 M

NO.	FREQ. (MHz)	EMISSION LEVEL (dBuV/m)	LIMIT (dBuV/m)	MARGIN (dB)	ANTENNA HEIGHT (m)	TABLE ANGLE (Degree)	RAW VALUE (dBuV)	CORRECTION FACTOR (dB/m)
1	5150.00	56.33 PK	74.00	-17.67	1.42 H	23	51.42	4.91
2	5150.00	42.80 AV	54.00	-11.20	1.42 H	23	37.89	4.91
3	*5290.00	95.80 PK			1.42 H	23	90.66	5.14
4	*5290.00	84.82 AV			1.42 H	23	79.68	5.14
5	5350.00	55.21 PK	74.00	-18.79	1.42 H	23	49.86	5.35
6	5350.00	42.17 AV	54.00	-11.83	1.42 H	23	36.82	5.35
7	#10580.00	55.53 PK	74.00	-18.47	2.29 H	136	39.64	15.89
8	#10580.00	41.26 AV	54.00	-12.74	2.29 H	136	25.37	15.89

ANTENNA POLARITY & TEST DISTANCE: VERTICAL AT 3 M

NO.	FREQ. (MHz)	EMISSION LEVEL (dBuV/m)	LIMIT (dBuV/m)	MARGIN (dB)	ANTENNA HEIGHT (m)	TABLE ANGLE (Degree)	RAW VALUE (dBuV)	CORRECTION FACTOR (dB/m)
1	5150.00	57.18 PK	74.00	-16.82	1.65 V	116	52.27	4.91
2	5150.00	43.88 AV	54.00	-10.12	1.65 V	116	38.97	4.91
3	*5290.00	105.30 PK			1.65 V	116	100.16	5.14
4	*5290.00	94.41 AV			1.65 V	116	89.27	5.14
5	5350.00	55.72 PK	74.00	-18.28	1.65 V	116	50.37	5.35
6	5350.00	42.56 AV	54.00	-11.44	1.65 V	116	37.21	5.35
7	#10580.00	56.25 PK	74.00	-17.75	1.54 V	126	40.36	15.89
8	#10580.00	42.22 AV	54.00	-11.78	1.54 V	126	26.33	15.89

REMARKS:

1. Emission Level(dBuV/m) = Raw Value(dBuV) + Correction Factor(dB/m)
2. Correction Factor(dB/m) = Antenna Factor(dB/m) + Cable Factor(dB) – Pre-Amplifier Factor(dB)
3. The other emission levels were very low against the limit.
4. Margin value = Emission Level – Limit value
5. " * ": Fundamental frequency.
6. " # ": The radiated frequency is out of the restricted band.

CHANNEL	TX Channel 106	DETECTOR FUNCTION	Peak (PK)
FREQUENCY RANGE	1GHz ~ 40GHz		Average (AV)

ANTENNA POLARITY & TEST DISTANCE: HORIZONTAL AT 3 M

NO.	FREQ. (MHz)	EMISSION LEVEL (dBuV/m)	LIMIT (dBuV/m)	MARGIN (dB)	ANTENNA HEIGHT (m)	TABLE ANGLE (Degree)	RAW VALUE (dBuV)	CORRECTION FACTOR (dB/m)
1	5460.00	63.23 PK	74.00	-10.77	1.67 H	59	57.46	5.77
2	5460.00	47.93 AV	54.00	-6.07	1.67 H	59	42.16	5.77
3	5470.00	63.70 PK	68.20	-4.50	1.67 H	59	57.88	5.82
4	*5530.00	103.00 PK			1.67 H	59	96.87	6.13
5	*5530.00	92.72 AV			1.67 H	59	86.59	6.13
6	11060.00	56.89 PK	74.00	-17.11	2.02 H	155	39.46	17.43
7	11060.00	43.12 AV	54.00	-10.88	2.02 H	155	25.69	17.43

ANTENNA POLARITY & TEST DISTANCE: VERTICAL AT 3 M

NO.	FREQ. (MHz)	EMISSION LEVEL (dBuV/m)	LIMIT (dBuV/m)	MARGIN (dB)	ANTENNA HEIGHT (m)	TABLE ANGLE (Degree)	RAW VALUE (dBuV)	CORRECTION FACTOR (dB/m)
1	5460.00	67.75 PK	74.00	-6.25	1.85 V	229	61.98	5.77
2	5460.00	51.91 AV	54.00	-2.09	1.85 V	229	46.14	5.77
3	5470.00	66.94 PK	68.20	-1.26	1.85 V	229	61.12	5.82
4	*5530.00	112.65 PK			1.85 V	229	106.52	6.13
5	*5530.00	102.49 AV			1.85 V	229	96.36	6.13
6	11060.00	58.28 PK	74.00	-15.72	1.69 V	234	40.85	17.43
7	11060.00	44.42 AV	54.00	-9.58	1.69 V	234	26.99	17.43

REMARKS:

1. Emission Level(dBuV/m) = Raw Value(dBuV) + Correction Factor(dB/m)
2. Correction Factor(dB/m) = Antenna Factor(dB/m) + Cable Factor(dB) – Pre-Amplifier Factor(dB)
3. The other emission levels were very low against the limit.
4. Margin value = Emission Level – Limit value
5. " * ": Fundamental frequency.

CHANNEL	TX Channel 122	DETECTOR FUNCTION	Peak (PK)
FREQUENCY RANGE	1GHz ~ 40GHz		Average (AV)

ANTENNA POLARITY & TEST DISTANCE: HORIZONTAL AT 3 M

NO.	FREQ. (MHz)	EMISSION LEVEL (dBuV/m)	LIMIT (dBuV/m)	MARGIN (dB)	ANTENNA HEIGHT (m)	TABLE ANGLE (Degree)	RAW VALUE (dBuV)	CORRECTION FACTOR (dB/m)
1	*5610.00	103.46 PK			1.67 H	49	96.88	6.58
2	*5610.00	92.54 AV			1.67 H	49	85.96	6.58
3	5725.00	61.94 PK	68.20	-6.26	1.67 H	49	55.26	6.68
4	11220.00	56.62 PK	74.00	-17.38	1.80 H	269	39.46	17.16
5	11220.00	42.98 AV	54.00	-11.02	1.80 H	269	25.82	17.16

ANTENNA POLARITY & TEST DISTANCE: VERTICAL AT 3 M

NO.	FREQ. (MHz)	EMISSION LEVEL (dBuV/m)	LIMIT (dBuV/m)	MARGIN (dB)	ANTENNA HEIGHT (m)	TABLE ANGLE (Degree)	RAW VALUE (dBuV)	CORRECTION FACTOR (dB/m)
1	*5610.00	112.70 PK			1.84 V	230	106.12	6.58
2	*5610.00	102.14 AV			1.84 V	230	95.56	6.58
3	5725.00	67.10 PK	68.20	-1.10	1.84 V	230	60.42	6.68
4	11220.00	58.02 PK	74.00	-15.98	1.97 V	264	40.86	17.16
5	11220.00	44.10 AV	54.00	-9.90	1.97 V	264	26.94	17.16

REMARKS:

1. Emission Level(dBuV/m) = Raw Value(dBuV) + Correction Factor(dB/m)
2. Correction Factor(dB/m) = Antenna Factor(dB/m) + Cable Factor(dB) – Pre-Amplifier Factor(dB)
3. The other emission levels were very low against the limit.
4. Margin value = Emission Level – Limit value
5. " * ": Fundamental frequency.

Beamforming_NSS1 Mode (Mode A)

802.11ac (20MHz)

CHANNEL	TX Channel 52	DETECTOR FUNCTION	Peak (PK)
FREQUENCY RANGE	1GHz ~ 40GHz		Average (AV)

ANTENNA POLARITY & TEST DISTANCE: HORIZONTAL AT 3 M

NO.	FREQ. (MHz)	EMISSION LEVEL (dBuV/m)	LIMIT (dBuV/m)	MARGIN (dB)	ANTENNA HEIGHT (m)	TABLE ANGLE (Degree)	RAW VALUE (dBuV)	CORRECTION FACTOR (dB/m)
1	5150.00	58.51 PK	74.00	-15.49	1.53 H	296	53.60	4.91
2	5150.00	44.24 AV	54.00	-9.76	1.53 H	296	39.33	4.91
3	*5260.00	115.14 PK			1.53 H	296	110.05	5.09
4	*5260.00	102.16 AV			1.53 H	296	97.07	5.09
5	#10520.00	56.51 PK	74.00	-17.49	1.96 H	267	40.68	15.83
6	#10520.00	43.83 AV	54.00	-10.17	1.96 H	267	28.00	15.83

ANTENNA POLARITY & TEST DISTANCE: VERTICAL AT 3 M

NO.	FREQ. (MHz)	EMISSION LEVEL (dBuV/m)	LIMIT (dBuV/m)	MARGIN (dB)	ANTENNA HEIGHT (m)	TABLE ANGLE (Degree)	RAW VALUE (dBuV)	CORRECTION FACTOR (dB/m)
1	5150.00	57.99 PK	74.00	-16.01	1.57 V	242	53.08	4.91
2	5150.00	44.08 AV	54.00	-9.92	1.57 V	242	39.17	4.91
3	*5260.00	114.00 PK			1.57 V	242	108.91	5.09
4	*5260.00	100.52 AV			1.57 V	242	95.43	5.09
5	#10520.00	55.99 PK	74.00	-18.01	1.87 V	316	40.16	15.83
6	#10520.00	42.14 AV	54.00	-11.86	1.87 V	316	26.31	15.83

REMARKS:

1. Emission Level(dBuV/m) = Raw Value(dBuV) + Correction Factor(dB/m)
2. Correction Factor(dB/m) = Antenna Factor(dB/m) + Cable Factor(dB) – Pre-Amplifier Factor(dB)
3. The other emission levels were very low against the limit.
4. Margin value = Emission Level – Limit value
5. " * ": Fundamental frequency.
6. " # ": The radiated frequency is out of the restricted band.

CHANNEL	TX Channel 60	DETECTOR FUNCTION	Peak (PK)
FREQUENCY RANGE	1GHz ~ 40GHz		Average (AV)

ANTENNA POLARITY & TEST DISTANCE: HORIZONTAL AT 3 M

NO.	FREQ. (MHz)	EMISSION LEVEL (dBuV/m)	LIMIT (dBuV/m)	MARGIN (dB)	ANTENNA HEIGHT (m)	TABLE ANGLE (Degree)	RAW VALUE (dBuV)	CORRECTION FACTOR (dB/m)
1	*5300.00	115.62 PK			1.59 H	301	110.46	5.16
2	*5300.00	102.65 AV			1.59 H	301	97.49	5.16
3	10600.00	56.59 PK	74.00	-17.41	1.88 H	257	40.67	15.92
4	10600.00	43.36 AV	54.00	-10.64	1.88 H	257	27.44	15.92

ANTENNA POLARITY & TEST DISTANCE: VERTICAL AT 3 M

NO.	FREQ. (MHz)	EMISSION LEVEL (dBuV/m)	LIMIT (dBuV/m)	MARGIN (dB)	ANTENNA HEIGHT (m)	TABLE ANGLE (Degree)	RAW VALUE (dBuV)	CORRECTION FACTOR (dB/m)
1	*5300.00	113.62 PK			1.53 V	251	108.46	5.16
2	*5300.00	100.55 AV			1.53 V	251	95.39	5.16
3	10600.00	55.82 PK	74.00	-18.18	1.44 V	214	39.90	15.92
4	10600.00	42.81 AV	54.00	-11.19	1.44 V	214	26.89	15.92

REMARKS:

1. Emission Level(dBuV/m) = Raw Value(dBuV) + Correction Factor(dB/m)
2. Correction Factor(dB/m) = Antenna Factor(dB/m) + Cable Factor(dB) – Pre-Amplifier Factor(dB)
3. The other emission levels were very low against the limit.
4. Margin value = Emission Level – Limit value
5. " * ": Fundamental frequency.

CHANNEL	TX Channel 64	DETECTOR FUNCTION	Peak (PK)
FREQUENCY RANGE	1GHz ~ 40GHz		Average (AV)

ANTENNA POLARITY & TEST DISTANCE: HORIZONTAL AT 3 M

NO.	FREQ. (MHz)	EMISSION LEVEL (dBuV/m)	LIMIT (dBuV/m)	MARGIN (dB)	ANTENNA HEIGHT (m)	TABLE ANGLE (Degree)	RAW VALUE (dBuV)	CORRECTION FACTOR (dB/m)
1	*5320.00	115.05 PK			1.59 H	288	109.81	5.24
2	*5320.00	101.62 AV			1.59 H	288	96.38	5.24
3	5350.00	63.51 PK	74.00	-10.49	1.52 H	313	58.16	5.35
4	5350.00	45.72 AV	54.00	-8.28	1.52 H	313	40.37	5.35
5	10640.00	56.58 PK	74.00	-17.42	1.99 H	263	40.52	16.06
6	10640.00	43.55 AV	54.00	-10.45	1.99 H	263	27.49	16.06

ANTENNA POLARITY & TEST DISTANCE: VERTICAL AT 3 M

NO.	FREQ. (MHz)	EMISSION LEVEL (dBuV/m)	LIMIT (dBuV/m)	MARGIN (dB)	ANTENNA HEIGHT (m)	TABLE ANGLE (Degree)	RAW VALUE (dBuV)	CORRECTION FACTOR (dB/m)
1	*5320.00	112.73 PK			1.54 V	239	107.49	5.24
2	*5320.00	100.12 AV			1.54 V	239	94.88	5.24
3	5350.00	60.81 PK	74.00	-13.19	1.54 V	239	55.46	5.35
4	5350.00	43.91 AV	54.00	-10.09	1.54 V	239	38.56	5.35
5	10640.00	55.54 PK	74.00	-18.46	1.39 V	263	39.48	16.06
6	10640.00	42.44 AV	54.00	-11.56	1.39 V	263	26.38	16.06

REMARKS:

1. Emission Level(dBuV/m) = Raw Value(dBuV) + Correction Factor(dB/m)
2. Correction Factor(dB/m) = Antenna Factor(dB/m) + Cable Factor(dB) – Pre-Amplifier Factor(dB)
3. The other emission levels were very low against the limit.
4. Margin value = Emission Level – Limit value
5. " * ": Fundamental frequency.

CHANNEL	TX Channel 100	DETECTOR FUNCTION	Peak (PK)
FREQUENCY RANGE	1GHz ~ 40GHz		Average (AV)

ANTENNA POLARITY & TEST DISTANCE: HORIZONTAL AT 3 M

NO.	FREQ. (MHz)	EMISSION LEVEL (dBuV/m)	LIMIT (dBuV/m)	MARGIN (dB)	ANTENNA HEIGHT (m)	TABLE ANGLE (Degree)	RAW VALUE (dBuV)	CORRECTION FACTOR (dB/m)
1	5460.00	57.36 PK	74.00	-16.64	1.48 H	322	51.59	5.77
2	5460.00	43.30 AV	54.00	-10.70	1.48 H	322	37.53	5.77
3	5470.00	59.63 PK	68.20	-8.57	1.48 H	322	53.81	5.82
4	*5500.00	117.19 PK			1.48 H	322	111.25	5.94
5	*5500.00	98.61 AV			1.48 H	322	92.67	5.94
6	11000.00	58.20 PK	74.00	-15.80	1.57 H	281	40.84	17.36
7	11000.00	44.03 AV	54.00	-9.97	1.57 H	281	26.67	17.36

ANTENNA POLARITY & TEST DISTANCE: VERTICAL AT 3 M

NO.	FREQ. (MHz)	EMISSION LEVEL (dBuV/m)	LIMIT (dBuV/m)	MARGIN (dB)	ANTENNA HEIGHT (m)	TABLE ANGLE (Degree)	RAW VALUE (dBuV)	CORRECTION FACTOR (dB/m)
1	5460.00	56.79 PK	74.00	-17.21	1.62 V	233	51.02	5.77
2	5460.00	42.77 AV	54.00	-11.23	1.62 V	233	37.00	5.77
3	5470.00	57.98 PK	68.20	-10.22	1.62 V	233	52.16	5.82
4	*5500.00	115.20 PK			1.62 V	233	109.26	5.94
5	*5500.00	96.78 AV			1.62 V	233	90.84	5.94
6	11000.00	57.07 PK	74.00	-16.93	1.89 V	284	39.71	17.36
7	11000.00	42.55 AV	54.00	-11.45	1.89 V	284	25.19	17.36

REMARKS:

1. Emission Level(dBuV/m) = Raw Value(dBuV) + Correction Factor(dB/m)
2. Correction Factor(dB/m) = Antenna Factor(dB/m) + Cable Factor(dB) – Pre-Amplifier Factor(dB)
3. The other emission levels were very low against the limit.
4. Margin value = Emission Level – Limit value
5. " * ": Fundamental frequency.

CHANNEL	TX Channel 116	DETECTOR FUNCTION	Peak (PK)
FREQUENCY RANGE	1GHz ~ 40GHz		Average (AV)

ANTENNA POLARITY & TEST DISTANCE: HORIZONTAL AT 3 M

NO.	FREQ. (MHz)	EMISSION LEVEL (dBuV/m)	LIMIT (dBuV/m)	MARGIN (dB)	ANTENNA HEIGHT (m)	TABLE ANGLE (Degree)	RAW VALUE (dBuV)	CORRECTION FACTOR (dB/m)
1	*5580.00	117.96 PK			1.51 H	336	111.52	6.44
2	*5580.00	99.18 AV			1.51 H	336	92.74	6.44
3	11160.00	57.92 PK	74.00	-16.08	1.92 H	268	40.62	17.30
4	11160.00	43.98 AV	54.00	-10.02	1.92 H	268	26.68	17.30

ANTENNA POLARITY & TEST DISTANCE: VERTICAL AT 3 M

NO.	FREQ. (MHz)	EMISSION LEVEL (dBuV/m)	LIMIT (dBuV/m)	MARGIN (dB)	ANTENNA HEIGHT (m)	TABLE ANGLE (Degree)	RAW VALUE (dBuV)	CORRECTION FACTOR (dB/m)
1	*5580.00	116.29 PK			1.58 V	288	109.85	6.44
2	*5580.00	96.90 AV			1.58 V	288	90.46	6.44
3	11160.00	56.91 PK	74.00	-17.09	1.88 V	276	39.61	17.30
4	11160.00	42.46 AV	54.00	-11.54	1.88 V	276	25.16	17.30

REMARKS:

1. Emission Level(dBuV/m) = Raw Value(dBuV) + Correction Factor(dB/m)
2. Correction Factor(dB/m) = Antenna Factor(dB/m) + Cable Factor(dB) – Pre-Amplifier Factor(dB)
3. The other emission levels were very low against the limit.
4. Margin value = Emission Level – Limit value
5. " * ": Fundamental frequency.

CHANNEL	TX Channel 132	DETECTOR FUNCTION	Peak (PK)
FREQUENCY RANGE	1GHz ~ 40GHz		Average (AV)

ANTENNA POLARITY & TEST DISTANCE: HORIZONTAL AT 3 M

NO.	FREQ. (MHz)	EMISSION LEVEL (dBuV/m)	LIMIT (dBuV/m)	MARGIN (dB)	ANTENNA HEIGHT (m)	TABLE ANGLE (Degree)	RAW VALUE (dBuV)	CORRECTION FACTOR (dB/m)
1	*5660.00	118.19 PK			1.53 H	327	111.57	6.62
2	*5660.00	99.47 AV			1.53 H	327	92.85	6.62
3	11320.00	57.93 PK	74.00	-16.07	1.87 H	46	40.94	16.99
4	11320.00	43.61 AV	54.00	-10.39	1.87 H	46	26.62	16.99

ANTENNA POLARITY & TEST DISTANCE: VERTICAL AT 3 M

NO.	FREQ. (MHz)	EMISSION LEVEL (dBuV/m)	LIMIT (dBuV/m)	MARGIN (dB)	ANTENNA HEIGHT (m)	TABLE ANGLE (Degree)	RAW VALUE (dBuV)	CORRECTION FACTOR (dB/m)
1	*5660.00	115.81 PK			1.52 V	241	109.19	6.62
2	*5660.00	96.96 AV			1.52 V	241	90.34	6.62
3	11320.00	56.67 PK	74.00	-17.33	2.50 V	269	39.68	16.99
4	11320.00	42.22 AV	54.00	-11.78	2.50 V	269	25.23	16.99

REMARKS:

1. Emission Level(dBuV/m) = Raw Value(dBuV) + Correction Factor(dB/m)
2. Correction Factor(dB/m) = Antenna Factor(dB/m) + Cable Factor(dB) – Pre-Amplifier Factor(dB)
3. The other emission levels were very low against the limit.
4. Margin value = Emission Level – Limit value
5. " * ": Fundamental frequency.

CHANNEL	TX Channel 140	DETECTOR FUNCTION	Peak (PK)
FREQUENCY RANGE	1GHz ~ 40GHz		Average (AV)

ANTENNA POLARITY & TEST DISTANCE: HORIZONTAL AT 3 M

NO.	FREQ. (MHz)	EMISSION LEVEL (dBuV/m)	LIMIT (dBuV/m)	MARGIN (dB)	ANTENNA HEIGHT (m)	TABLE ANGLE (Degree)	RAW VALUE (dBuV)	CORRECTION FACTOR (dB/m)
1	*5700.00	118.53 PK			1.49 H	338	111.88	6.65
2	*5700.00	99.34 AV			1.49 H	338	92.69	6.65
3	5725.00	63.65 PK	68.20	-4.55	1.49 H	338	56.97	6.68
4	11400.00	57.96 PK	74.00	-16.04	1.78 H	288	40.96	17.00
5	11400.00	43.38 AV	54.00	-10.62	1.78 H	288	26.38	17.00

ANTENNA POLARITY & TEST DISTANCE: VERTICAL AT 3 M

NO.	FREQ. (MHz)	EMISSION LEVEL (dBuV/m)	LIMIT (dBuV/m)	MARGIN (dB)	ANTENNA HEIGHT (m)	TABLE ANGLE (Degree)	RAW VALUE (dBuV)	CORRECTION FACTOR (dB/m)
1	*5700.00	116.39 PK			1.63 V	251	109.74	6.65
2	*5700.00	97.48 AV			1.63 V	251	90.83	6.65
3	5725.00	60.87 PK	68.20	-7.33	1.63 V	251	54.19	6.68
4	11400.00	56.43 PK	74.00	-17.57	1.55 V	208	39.43	17.00
5	11400.00	42.52 AV	54.00	-11.48	1.55 V	208	25.52	17.00

REMARKS:

1. Emission Level(dBuV/m) = Raw Value(dBuV) + Correction Factor(dB/m)
2. Correction Factor(dB/m) = Antenna Factor(dB/m) + Cable Factor(dB) – Pre-Amplifier Factor(dB)
3. The other emission levels were very low against the limit.
4. Margin value = Emission Level – Limit value
5. " * ": Fundamental frequency.

802.11ac (40MHz)

CHANNEL	TX Channel 54	DETECTOR FUNCTION	Peak (PK)
FREQUENCY RANGE	1GHz ~ 40GHz		Average (AV)

ANTENNA POLARITY & TEST DISTANCE: HORIZONTAL AT 3 M

NO.	FREQ. (MHz)	EMISSION LEVEL (dBuV/m)	LIMIT (dBuV/m)	MARGIN (dB)	ANTENNA HEIGHT (m)	TABLE ANGLE (Degree)	RAW VALUE (dBuV)	CORRECTION FACTOR (dB/m)
1	5150.00	58.63 PK	74.00	-15.37	3.20 H	203	53.72	4.91
2	5150.00	43.86 AV	54.00	-10.14	3.20 H	203	38.95	4.91
3	*5270.00	115.48 PK			3.20 H	203	110.37	5.11
4	*5270.00	99.16 AV			3.20 H	203	94.05	5.11
5	#10540.00	56.69 PK	74.00	-17.31	1.87 H	164	40.84	15.85
6	#10540.00	42.22 AV	54.00	-11.78	1.87 H	164	26.37	15.85

ANTENNA POLARITY & TEST DISTANCE: VERTICAL AT 3 M

NO.	FREQ. (MHz)	EMISSION LEVEL (dBuV/m)	LIMIT (dBuV/m)	MARGIN (dB)	ANTENNA HEIGHT (m)	TABLE ANGLE (Degree)	RAW VALUE (dBuV)	CORRECTION FACTOR (dB/m)
1	5150.00	57.07 PK	74.00	-16.93	1.48 V	243	52.16	4.91
2	5150.00	43.04 AV	54.00	-10.96	1.48 V	243	38.13	4.91
3	*5270.00	113.70 PK			1.48 V	243	108.59	5.11
4	*5270.00	97.74 AV			1.48 V	243	92.63	5.11
5	#10540.00	55.49 PK	74.00	-18.51	2.26 V	218	39.64	15.85
6	#10540.00	41.67 AV	54.00	-12.33	2.26 V	218	25.82	15.85

REMARKS:

1. Emission Level(dBuV/m) = Raw Value(dBuV) + Correction Factor(dB/m)
2. Correction Factor(dB/m) = Antenna Factor(dB/m) + Cable Factor(dB) – Pre-Amplifier Factor(dB)
3. The other emission levels were very low against the limit.
4. Margin value = Emission Level – Limit value
5. " * ": Fundamental frequency.
6. " # ": The radiated frequency is out of the restricted band.

CHANNEL	TX Channel 62	DETECTOR FUNCTION	Peak (PK)
FREQUENCY RANGE	1GHz ~ 40GHz		Average (AV)

ANTENNA POLARITY & TEST DISTANCE: HORIZONTAL AT 3 M

NO.	FREQ. (MHz)	EMISSION LEVEL (dBuV/m)	LIMIT (dBuV/m)	MARGIN (dB)	ANTENNA HEIGHT (m)	TABLE ANGLE (Degree)	RAW VALUE (dBuV)	CORRECTION FACTOR (dB/m)
1	*5310.00	116.88 PK			3.15 H	204	111.68	5.20
2	*5310.00	100.05 AV			3.15 H	204	94.85	5.20
3	5350.00	66.80 PK	74.00	-7.20	3.15 H	204	61.45	5.35
4	5350.00	44.19 AV	54.00	-9.81	3.15 H	204	38.84	5.35
5	10620.00	56.83 PK	74.00	-17.17	1.84 H	284	40.84	15.99
6	10620.00	42.83 AV	54.00	-11.17	1.84 H	284	26.84	15.99

ANTENNA POLARITY & TEST DISTANCE: VERTICAL AT 3 M

NO.	FREQ. (MHz)	EMISSION LEVEL (dBuV/m)	LIMIT (dBuV/m)	MARGIN (dB)	ANTENNA HEIGHT (m)	TABLE ANGLE (Degree)	RAW VALUE (dBuV)	CORRECTION FACTOR (dB/m)
1	*5310.00	114.84 PK			1.58 V	288	109.64	5.20
2	*5310.00	97.75 AV			1.58 V	288	92.55	5.20
3	5350.00	63.79 PK	74.00	-10.21	1.00 V	288	58.44	5.35
4	5350.00	41.71 AV	54.00	-12.29	1.00 V	288	36.36	5.35
5	10620.00	55.63 PK	74.00	-18.37	2.14 V	102	39.64	15.99
6	10620.00	41.63 AV	54.00	-12.37	2.14 V	102	25.64	15.99

REMARKS:

1. Emission Level(dBuV/m) = Raw Value(dBuV) + Correction Factor(dB/m)
2. Correction Factor(dB/m) = Antenna Factor(dB/m) + Cable Factor(dB) – Pre-Amplifier Factor(dB)
3. The other emission levels were very low against the limit.
4. Margin value = Emission Level – Limit value
5. " * ": Fundamental frequency.

CHANNEL	TX Channel 102	DETECTOR FUNCTION	Peak (PK)
FREQUENCY RANGE	1GHz ~ 40GHz		Average (AV)

ANTENNA POLARITY & TEST DISTANCE: HORIZONTAL AT 3 M

NO.	FREQ. (MHz)	EMISSION LEVEL (dBuV/m)	LIMIT (dBuV/m)	MARGIN (dB)	ANTENNA HEIGHT (m)	TABLE ANGLE (Degree)	RAW VALUE (dBuV)	CORRECTION FACTOR (dB/m)
1	5460.00	69.06 PK	74.00	-4.94	1.46 H	323	63.29	5.77
2	5460.00	43.93 AV	54.00	-10.07	1.46 H	323	38.16	5.77
3	5470.00	67.05 PK	68.20	-1.15	1.46 H	323	61.23	5.82
4	*5510.00	116.83 PK			1.46 H	323	110.82	6.01
5	*5510.00	96.55 AV			1.46 H	323	90.54	6.01
6	11020.00	57.60 PK	74.00	-16.40	1.93 H	251	40.21	17.39
7	11020.00	44.27 AV	54.00	-9.73	1.93 H	251	26.88	17.39

ANTENNA POLARITY & TEST DISTANCE: VERTICAL AT 3 M

NO.	FREQ. (MHz)	EMISSION LEVEL (dBuV/m)	LIMIT (dBuV/m)	MARGIN (dB)	ANTENNA HEIGHT (m)	TABLE ANGLE (Degree)	RAW VALUE (dBuV)	CORRECTION FACTOR (dB/m)
1	5460.00	66.19 PK	74.00	-7.81	1.68 V	231	60.42	5.77
2	5460.00	42.46 AV	54.00	-11.54	1.68 V	231	36.69	5.77
3	5470.00	65.68 PK	68.20	-2.52	1.68 V	231	59.86	5.82
4	*5510.00	114.27 PK			1.68 V	231	108.26	6.01
5	*5510.00	94.57 AV			1.68 V	231	88.56	6.01
6	11020.00	56.85 PK	74.00	-17.15	1.74 V	154	39.46	17.39
7	11020.00	42.55 AV	54.00	-11.45	1.74 V	154	25.16	17.39

REMARKS:

1. Emission Level(dBuV/m) = Raw Value(dBuV) + Correction Factor(dB/m)
2. Correction Factor(dB/m) = Antenna Factor(dB/m) + Cable Factor(dB) – Pre-Amplifier Factor(dB)
3. The other emission levels were very low against the limit.
4. Margin value = Emission Level – Limit value
5. " * ": Fundamental frequency.
6. " # ": The radiated frequency is out of the restricted band.

CHANNEL	TX Channel 110	DETECTOR FUNCTION	Peak (PK)
FREQUENCY RANGE	1GHz ~ 40GHz		Average (AV)

ANTENNA POLARITY & TEST DISTANCE: HORIZONTAL AT 3 M

NO.	FREQ. (MHz)	EMISSION LEVEL (dBuV/m)	LIMIT (dBuV/m)	MARGIN (dB)	ANTENNA HEIGHT (m)	TABLE ANGLE (Degree)	RAW VALUE (dBuV)	CORRECTION FACTOR (dB/m)
1	*5550.00	116.80 PK			1.49 H	329	110.54	6.26
2	*5550.00	96.90 AV			1.49 H	329	90.64	6.26
3	11100.00	58.04 PK	74.00	-15.96	1.98 H	226	40.57	17.47
4	11100.00	44.13 AV	54.00	-9.87	1.98 H	226	26.66	17.47

ANTENNA POLARITY & TEST DISTANCE: VERTICAL AT 3 M

NO.	FREQ. (MHz)	EMISSION LEVEL (dBuV/m)	LIMIT (dBuV/m)	MARGIN (dB)	ANTENNA HEIGHT (m)	TABLE ANGLE (Degree)	RAW VALUE (dBuV)	CORRECTION FACTOR (dB/m)
1	*5550.00	114.78 PK			1.57 V	234	108.52	6.26
2	*5550.00	94.95 AV			1.57 V	234	88.69	6.26
3	11100.00	56.99 PK	74.00	-17.01	1.82 V	201	39.52	17.47
4	11100.00	42.79 AV	54.00	-11.21	1.82 V	201	25.32	17.47

REMARKS:

1. Emission Level(dBuV/m) = Raw Value(dBuV) + Correction Factor(dB/m)
2. Correction Factor(dB/m) = Antenna Factor(dB/m) + Cable Factor(dB) – Pre-Amplifier Factor(dB)
3. The other emission levels were very low against the limit.
4. Margin value = Emission Level – Limit value
5. " * ": Fundamental frequency.

CHANNEL	TX Channel 134	DETECTOR FUNCTION	Peak (PK)
FREQUENCY RANGE	1GHz ~ 40GHz		Average (AV)

ANTENNA POLARITY & TEST DISTANCE: HORIZONTAL AT 3 M

NO.	FREQ. (MHz)	EMISSION LEVEL (dBuV/m)	LIMIT (dBuV/m)	MARGIN (dB)	ANTENNA HEIGHT (m)	TABLE ANGLE (Degree)	RAW VALUE (dBuV)	CORRECTION FACTOR (dB/m)
1	*5670.00	117.77 PK			1.47 H	324	111.14	6.63
2	*5670.00	97.74 AV			1.47 H	324	91.11	6.63
3	5725.00	66.84 PK	68.20	-1.36	1.47 H	324	60.16	6.68
4	11340.00	57.87 PK	74.00	-16.13	1.58 H	229	40.88	16.99
5	11340.00	43.68 AV	54.00	-10.32	1.58 H	229	26.69	16.99

ANTENNA POLARITY & TEST DISTANCE: VERTICAL AT 3 M

NO.	FREQ. (MHz)	EMISSION LEVEL (dBuV/m)	LIMIT (dBuV/m)	MARGIN (dB)	ANTENNA HEIGHT (m)	TABLE ANGLE (Degree)	RAW VALUE (dBuV)	CORRECTION FACTOR (dB/m)
1	*5670.00	116.15 PK			1.56 V	239	109.52	6.63
2	*5670.00	96.32 AV			1.56 V	239	89.69	6.63
3	5725.00	64.53 PK	68.20	-3.67	1.56 V	239	57.85	6.68
4	11340.00	56.41 PK	74.00	-17.59	1.85 V	214	39.42	16.99
5	11340.00	42.08 AV	54.00	-11.92	1.85 V	214	25.09	16.99

REMARKS:

1. Emission Level(dBuV/m) = Raw Value(dBuV) + Correction Factor(dB/m)
2. Correction Factor(dB/m) = Antenna Factor(dB/m) + Cable Factor(dB) – Pre-Amplifier Factor(dB)
3. The other emission levels were very low against the limit.
4. Margin value = Emission Level – Limit value
5. " * ": Fundamental frequency.

802.11ac (80MHz)

CHANNEL	TX Channel 58	DETECTOR FUNCTION	Peak (PK)
FREQUENCY RANGE	1GHz ~ 40GHz		Average (AV)

ANTENNA POLARITY & TEST DISTANCE: HORIZONTAL AT 3 M

NO.	FREQ. (MHz)	EMISSION LEVEL (dBuV/m)	LIMIT (dBuV/m)	MARGIN (dB)	ANTENNA HEIGHT (m)	TABLE ANGLE (Degree)	RAW VALUE (dBuV)	CORRECTION FACTOR (dB/m)
1	5150.00	68.01 PK	74.00	-5.99	3.33 H	199	63.10	4.91
2	5150.00	44.09 AV	54.00	-9.91	3.33 H	199	39.18	4.91
3	*5290.00	114.60 PK			3.33 H	199	109.46	5.14
4	*5290.00	97.87 AV			3.33 H	199	92.73	5.14
5	5350.00	71.89 PK	74.00	-2.11	3.33 H	199	66.54	5.35
6	5350.00	43.82 AV	54.00	-10.18	3.33 H	199	38.47	5.35
7	#10580.00	56.73 PK	74.00	-17.27	1.97 H	145	40.84	15.89
8	#10580.00	42.28 AV	54.00	-11.72	1.97 H	145	26.39	15.89

ANTENNA POLARITY & TEST DISTANCE: VERTICAL AT 3 M

NO.	FREQ. (MHz)	EMISSION LEVEL (dBuV/m)	LIMIT (dBuV/m)	MARGIN (dB)	ANTENNA HEIGHT (m)	TABLE ANGLE (Degree)	RAW VALUE (dBuV)	CORRECTION FACTOR (dB/m)
1	5150.00	65.04 PK	74.00	-8.96	2.34 V	216	60.13	4.91
2	5150.00	41.79 AV	54.00	-12.21	2.34 V	216	36.88	4.91
3	*5290.00	112.98 PK			2.34 V	216	107.84	5.14
4	*5290.00	95.52 AV			2.34 V	216	90.38	5.14
5	5350.00	68.79 PK	74.00	-5.21	2.34 V	216	63.44	5.35
6	5350.00	41.74 AV	54.00	-12.26	2.34 V	216	36.39	5.35
7	#10580.00	55.36 PK	74.00	-18.64	2.39 V	241	39.47	15.89
8	#10580.00	41.26 AV	54.00	-12.74	2.39 V	241	25.37	15.89

REMARKS:

1. Emission Level(dBuV/m) = Raw Value(dBuV) + Correction Factor(dB/m)
2. Correction Factor(dB/m) = Antenna Factor(dB/m) + Cable Factor(dB) – Pre-Amplifier Factor(dB)
3. The other emission levels were very low against the limit.
4. Margin value = Emission Level – Limit value
5. " * ": Fundamental frequency.
6. " # ": The radiated frequency is out of the restricted band.

CHANNEL	TX Channel 106	DETECTOR FUNCTION	Peak (PK)
FREQUENCY RANGE	1GHz ~ 40GHz		Average (AV)

ANTENNA POLARITY & TEST DISTANCE: HORIZONTAL AT 3 M

NO.	FREQ. (MHz)	EMISSION LEVEL (dBuV/m)	LIMIT (dBuV/m)	MARGIN (dB)	ANTENNA HEIGHT (m)	TABLE ANGLE (Degree)	RAW VALUE (dBuV)	CORRECTION FACTOR (dB/m)
1	5460.00	64.53 PK	74.00	-9.47	1.47 H	323	58.76	5.77
2	5460.00	43.99 AV	54.00	-10.01	1.47 H	323	38.22	5.77
3	5470.00	67.15 PK	68.20	-1.05	1.47 H	323	61.33	5.82
4	*5530.00	112.44 PK			1.47 H	323	106.31	6.13
5	*5530.00	93.00 AV			1.47 H	323	86.87	6.13
6	11060.00	57.69 PK	74.00	-16.31	1.75 H	263	40.26	17.43
7	11060.00	43.81 AV	54.00	-10.19	1.75 H	263	26.38	17.43

ANTENNA POLARITY & TEST DISTANCE: VERTICAL AT 3 M

NO.	FREQ. (MHz)	EMISSION LEVEL (dBuV/m)	LIMIT (dBuV/m)	MARGIN (dB)	ANTENNA HEIGHT (m)	TABLE ANGLE (Degree)	RAW VALUE (dBuV)	CORRECTION FACTOR (dB/m)
1	5460.00	61.05 PK	74.00	-12.95	1.59 V	262	55.28	5.77
2	5460.00	42.22 AV	54.00	-11.78	1.59 V	262	36.45	5.77
3	5470.00	64.28 PK	68.20	-3.92	1.59 V	262	58.46	5.82
4	*5530.00	110.65 PK			1.59 V	262	104.52	6.13
5	*5530.00	90.85 AV			1.59 V	262	84.72	6.13
6	11060.00	56.86 PK	74.00	-17.14	2.18 V	271	39.43	17.43
7	11060.00	42.52 AV	54.00	-11.48	2.18 V	271	25.09	17.43

REMARKS:

1. Emission Level(dBuV/m) = Raw Value(dBuV) + Correction Factor(dB/m)
2. Correction Factor(dB/m) = Antenna Factor(dB/m) + Cable Factor(dB) – Pre-Amplifier Factor(dB)
3. The other emission levels were very low against the limit.
4. Margin value = Emission Level – Limit value
5. " * ": Fundamental frequency.

CHANNEL	TX Channel 122	DETECTOR FUNCTION	Peak (PK)
FREQUENCY RANGE	1GHz ~ 40GHz		Average (AV)

ANTENNA POLARITY & TEST DISTANCE: HORIZONTAL AT 3 M

NO.	FREQ. (MHz)	EMISSION LEVEL (dBuV/m)	LIMIT (dBuV/m)	MARGIN (dB)	ANTENNA HEIGHT (m)	TABLE ANGLE (Degree)	RAW VALUE (dBuV)	CORRECTION FACTOR (dB/m)
1	*5610.00	115.83 PK			1.47 H	328	109.25	6.58
2	*5610.00	96.38 AV			1.47 H	328	89.80	6.58
3	5725.00	67.04 PK	68.20	-1.16	1.47 H	328	60.36	6.68
4	11220.00	57.88 PK	74.00	-16.12	1.83 H	251	40.72	17.16
5	11220.00	43.29 AV	54.00	-10.71	1.83 H	251	26.13	17.16

ANTENNA POLARITY & TEST DISTANCE: VERTICAL AT 3 M

NO.	FREQ. (MHz)	EMISSION LEVEL (dBuV/m)	LIMIT (dBuV/m)	MARGIN (dB)	ANTENNA HEIGHT (m)	TABLE ANGLE (Degree)	RAW VALUE (dBuV)	CORRECTION FACTOR (dB/m)
1	*5610.00	113.16 PK			1.74 V	231	106.58	6.58
2	*5610.00	93.13 AV			1.74 V	231	86.55	6.58
3	5725.00	64.56 PK	68.20	-3.64	1.74 V	231	57.88	6.68
4	11220.00	56.30 PK	74.00	-17.70	1.52 V	32	39.14	17.16
5	11220.00	42.42 AV	54.00	-11.58	1.52 V	32	25.26	17.16

REMARKS:

1. Emission Level(dBuV/m) = Raw Value(dBuV) + Correction Factor(dB/m)
2. Correction Factor(dB/m) = Antenna Factor(dB/m) + Cable Factor(dB) – Pre-Amplifier Factor(dB)
3. The other emission levels were very low against the limit.
4. Margin value = Emission Level – Limit value
5. " * ": Fundamental frequency.

Beamforming_NSS1 Mode (Mode B)

802.11ac (20MHz)

CHANNEL	TX Channel 52	DETECTOR FUNCTION	Peak (PK)
FREQUENCY RANGE	1GHz ~ 40GHz		Average (AV)

ANTENNA POLARITY & TEST DISTANCE: HORIZONTAL AT 3 M

NO.	FREQ. (MHz)	EMISSION LEVEL (dBuV/m)	LIMIT (dBuV/m)	MARGIN (dB)	ANTENNA HEIGHT (m)	TABLE ANGLE (Degree)	RAW VALUE (dBuV)	CORRECTION FACTOR (dB/m)
1	5150.00	56.46 PK	74.00	-17.54	1.79 H	219	51.55	4.91
2	5150.00	43.07 AV	54.00	-10.93	1.79 H	219	38.16	4.91
3	*5260.00	103.29 PK			1.79 H	219	98.20	5.09
4	*5260.00	90.10 AV			1.79 H	219	85.01	5.09
5	#10520.00	55.43 PK	74.00	-18.57	1.63 H	268	39.60	15.83
6	#10520.00	41.65 AV	54.00	-12.35	1.63 H	268	25.82	15.83

ANTENNA POLARITY & TEST DISTANCE: VERTICAL AT 3 M

NO.	FREQ. (MHz)	EMISSION LEVEL (dBuV/m)	LIMIT (dBuV/m)	MARGIN (dB)	ANTENNA HEIGHT (m)	TABLE ANGLE (Degree)	RAW VALUE (dBuV)	CORRECTION FACTOR (dB/m)
1	5150.00	58.65 PK	74.00	-15.35	1.52 V	316	53.74	4.91
2	5150.00	44.77 AV	54.00	-9.23	1.52 V	316	39.86	4.91
3	*5260.00	118.68 PK			1.52 V	316	113.59	5.09
4	*5260.00	106.51 AV			1.52 V	316	101.42	5.09
5	#10520.00	56.64 PK	74.00	-17.36	1.87 V	194	40.81	15.83
6	#10520.00	42.49 AV	54.00	-11.51	1.87 V	194	26.66	15.83

REMARKS:

1. Emission Level(dBuV/m) = Raw Value(dBuV) + Correction Factor(dB/m)
2. Correction Factor(dB/m) = Antenna Factor(dB/m) + Cable Factor(dB) – Pre-Amplifier Factor(dB)
3. The other emission levels were very low against the limit.
4. Margin value = Emission Level – Limit value
5. " * ": Fundamental frequency.
6. " # ": The radiated frequency is out of the restricted band.

CHANNEL	TX Channel 60	DETECTOR FUNCTION	Peak (PK)
FREQUENCY RANGE	1GHz ~ 40GHz		Average (AV)

ANTENNA POLARITY & TEST DISTANCE: HORIZONTAL AT 3 M

NO.	FREQ. (MHz)	EMISSION LEVEL (dBuV/m)	LIMIT (dBuV/m)	MARGIN (dB)	ANTENNA HEIGHT (m)	TABLE ANGLE (Degree)	RAW VALUE (dBuV)	CORRECTION FACTOR (dB/m)
1	*5300.00	103.83 PK			1.89 H	220	98.67	5.16
2	*5300.00	90.58 AV			1.89 H	220	85.42	5.16
3	10600.00	55.66 PK	74.00	-18.34	1.45 H	251	39.74	15.92
4	10600.00	41.00 AV	54.00	-13.00	1.45 H	251	25.08	15.92

ANTENNA POLARITY & TEST DISTANCE: VERTICAL AT 3 M

NO.	FREQ. (MHz)	EMISSION LEVEL (dBuV/m)	LIMIT (dBuV/m)	MARGIN (dB)	ANTENNA HEIGHT (m)	TABLE ANGLE (Degree)	RAW VALUE (dBuV)	CORRECTION FACTOR (dB/m)
1	*5300.00	118.70 PK			1.56 V	321	113.54	5.16
2	*5300.00	107.01 AV			1.56 V	321	101.85	5.16
3	10600.00	56.77 PK	74.00	-17.23	1.96 V	36	40.85	15.92
4	10600.00	42.56 AV	54.00	-11.44	1.96 V	36	26.64	15.92

REMARKS:

1. Emission Level(dBuV/m) = Raw Value(dBuV) + Correction Factor(dB/m)
2. Correction Factor(dB/m) = Antenna Factor(dB/m) + Cable Factor(dB) – Pre-Amplifier Factor(dB)
3. The other emission levels were very low against the limit.
4. Margin value = Emission Level – Limit value
5. " * ": Fundamental frequency.

CHANNEL	TX Channel 64	DETECTOR FUNCTION	Peak (PK)
FREQUENCY RANGE	1GHz ~ 40GHz		Average (AV)

ANTENNA POLARITY & TEST DISTANCE: HORIZONTAL AT 3 M

NO.	FREQ. (MHz)	EMISSION LEVEL (dBuV/m)	LIMIT (dBuV/m)	MARGIN (dB)	ANTENNA HEIGHT (m)	TABLE ANGLE (Degree)	RAW VALUE (dBuV)	CORRECTION FACTOR (dB/m)
1	*5320.00	103.98 PK			1.74 H	215	98.74	5.24
2	*5320.00	90.40 AV			1.74 H	215	85.16	5.24
3	5350.00	56.77 PK	74.00	-17.23	1.74 H	215	51.42	5.35
4	5350.00	43.20 AV	54.00	-10.80	1.74 H	215	37.85	5.35
5	10640.00	55.90 PK	74.00	-18.10	1.23 H	268	39.84	16.06
6	10640.00	41.87 AV	54.00	-12.13	1.23 H	268	25.81	16.06

ANTENNA POLARITY & TEST DISTANCE: VERTICAL AT 3 M

NO.	FREQ. (MHz)	EMISSION LEVEL (dBuV/m)	LIMIT (dBuV/m)	MARGIN (dB)	ANTENNA HEIGHT (m)	TABLE ANGLE (Degree)	RAW VALUE (dBuV)	CORRECTION FACTOR (dB/m)
1	*5320.00	118.75 PK			1.53 V	280	113.51	5.24
2	*5320.00	106.27 AV			1.53 V	280	101.03	5.24
3	5350.00	58.61 PK	74.00	-15.39	1.53 V	280	53.26	5.35
4	5350.00	43.94 AV	54.00	-10.06	1.53 V	280	38.59	5.35
5	10640.00	56.78 PK	74.00	-17.22	1.88 V	74	40.72	16.06
6	10640.00	42.34 AV	54.00	-11.66	1.88 V	74	26.28	16.06

REMARKS:

1. Emission Level(dBuV/m) = Raw Value(dBuV) + Correction Factor(dB/m)
2. Correction Factor(dB/m) = Antenna Factor(dB/m) + Cable Factor(dB) – Pre-Amplifier Factor(dB)
3. The other emission levels were very low against the limit.
4. Margin value = Emission Level – Limit value
5. " * ": Fundamental frequency.

CHANNEL	TX Channel 100	DETECTOR FUNCTION	Peak (PK)
FREQUENCY RANGE	1GHz ~ 40GHz		Average (AV)

ANTENNA POLARITY & TEST DISTANCE: HORIZONTAL AT 3 M

NO.	FREQ. (MHz)	EMISSION LEVEL (dBuV/m)	LIMIT (dBuV/m)	MARGIN (dB)	ANTENNA HEIGHT (m)	TABLE ANGLE (Degree)	RAW VALUE (dBuV)	CORRECTION FACTOR (dB/m)
1	5460.00	56.80 PK	74.00	-17.20	1.86 H	214	51.03	5.77
2	5460.00	42.22 AV	54.00	-11.78	1.86 H	214	36.45	5.77
3	5470.00	59.98 PK	68.20	-8.22	1.86 H	214	54.16	5.82
4	*5500.00	102.19 PK			1.86 H	214	96.25	5.94
5	*5500.00	90.13 AV			1.86 H	214	84.19	5.94
6	11000.00	57.00 PK	74.00	-17.00	1.87 H	145	39.64	17.36
7	11000.00	43.00 AV	54.00	-11.00	1.87 H	145	25.64	17.36

ANTENNA POLARITY & TEST DISTANCE: VERTICAL AT 3 M

NO.	FREQ. (MHz)	EMISSION LEVEL (dBuV/m)	LIMIT (dBuV/m)	MARGIN (dB)	ANTENNA HEIGHT (m)	TABLE ANGLE (Degree)	RAW VALUE (dBuV)	CORRECTION FACTOR (dB/m)
1	5460.00	59.08 PK	74.00	-14.92	1.60 V	313	53.31	5.77
2	5460.00	43.60 AV	54.00	-10.40	1.60 V	313	37.83	5.77
3	5470.00	63.02 PK	68.20	-5.18	1.60 V	313	57.20	5.82
4	*5500.00	118.87 PK			1.60 V	313	112.93	5.94
5	*5500.00	100.33 AV			1.60 V	313	94.39	5.94
6	11000.00	58.21 PK	74.00	-15.79	1.94 V	152	40.85	17.36
7	11000.00	44.10 AV	54.00	-9.90	1.94 V	152	26.74	17.36

REMARKS:

1. Emission Level(dBuV/m) = Raw Value(dBuV) + Correction Factor(dB/m)
2. Correction Factor(dB/m) = Antenna Factor(dB/m) + Cable Factor(dB) – Pre-Amplifier Factor(dB)
3. The other emission levels were very low against the limit.
4. Margin value = Emission Level – Limit value
5. " * ": Fundamental frequency.

CHANNEL	TX Channel 116	DETECTOR FUNCTION	Peak (PK)
FREQUENCY RANGE	1GHz ~ 40GHz		Average (AV)

ANTENNA POLARITY & TEST DISTANCE: HORIZONTAL AT 3 M

NO.	FREQ. (MHz)	EMISSION LEVEL (dBuV/m)	LIMIT (dBuV/m)	MARGIN (dB)	ANTENNA HEIGHT (m)	TABLE ANGLE (Degree)	RAW VALUE (dBuV)	CORRECTION FACTOR (dB/m)
1	*5580.00	102.92 PK			1.97 H	211	96.48	6.44
2	*5580.00	91.13 AV			1.97 H	211	84.69	6.44
3	11160.00	56.48 PK	74.00	-17.52	2.25 H	209	39.18	17.30
4	11160.00	43.12 AV	54.00	-10.88	2.25 H	209	25.82	17.30

ANTENNA POLARITY & TEST DISTANCE: VERTICAL AT 3 M

NO.	FREQ. (MHz)	EMISSION LEVEL (dBuV/m)	LIMIT (dBuV/m)	MARGIN (dB)	ANTENNA HEIGHT (m)	TABLE ANGLE (Degree)	RAW VALUE (dBuV)	CORRECTION FACTOR (dB/m)
1	*5580.00	118.94 PK			1.62 V	319	112.50	6.44
2	*5580.00	100.76 AV			1.62 V	319	94.32	6.44
3	11160.00	57.59 PK	74.00	-16.41	1.87 V	205	40.29	17.30
4	11160.00	43.61 AV	54.00	-10.39	1.87 V	205	26.31	17.30

REMARKS:

1. Emission Level(dBuV/m) = Raw Value(dBuV) + Correction Factor(dB/m)
2. Correction Factor(dB/m) = Antenna Factor(dB/m) + Cable Factor(dB) – Pre-Amplifier Factor(dB)
3. The other emission levels were very low against the limit.
4. Margin value = Emission Level – Limit value
5. " * ": Fundamental frequency.

CHANNEL	TX Channel 132	DETECTOR FUNCTION	Peak (PK)
FREQUENCY RANGE	1GHz ~ 40GHz		Average (AV)

ANTENNA POLARITY & TEST DISTANCE: HORIZONTAL AT 3 M

NO.	FREQ. (MHz)	EMISSION LEVEL (dBuV/m)	LIMIT (dBuV/m)	MARGIN (dB)	ANTENNA HEIGHT (m)	TABLE ANGLE (Degree)	RAW VALUE (dBuV)	CORRECTION FACTOR (dB/m)
1	*5660.00	103.40 PK			1.88 H	219	96.78	6.62
2	*5660.00	91.179 AV			1.88 H	219	84.55	6.62
3	11320.00	56.83 PK	74.00	-17.17	2.19 H	285	39.84	16.99
4	11320.00	42.29 AV	54.00	-11.71	2.19 H	285	25.30	16.99

ANTENNA POLARITY & TEST DISTANCE: VERTICAL AT 3 M

NO.	FREQ. (MHz)	EMISSION LEVEL (dBuV/m)	LIMIT (dBuV/m)	MARGIN (dB)	ANTENNA HEIGHT (m)	TABLE ANGLE (Degree)	RAW VALUE (dBuV)	CORRECTION FACTOR (dB/m)
1	*5660.00	118.79 PK			1.57 V	320	112.17	6.62
2	*5660.00	102.04 AV			1.57 V	320	95.42	6.62
3	11320.00	57.50 PK	74.00	-16.50	1.08 V	25	40.51	16.99
4	11320.00	43.18 AV	54.00	-10.82	1.08 V	25	26.19	16.99

REMARKS:

1. Emission Level(dBuV/m) = Raw Value(dBuV) + Correction Factor(dB/m)
2. Correction Factor(dB/m) = Antenna Factor(dB/m) + Cable Factor(dB) – Pre-Amplifier Factor(dB)
3. The other emission levels were very low against the limit.
4. Margin value = Emission Level – Limit value
5. " * ": Fundamental frequency.

CHANNEL	TX Channel 140	DETECTOR FUNCTION	Peak (PK)
FREQUENCY RANGE	1GHz ~ 40GHz		Average (AV)

ANTENNA POLARITY & TEST DISTANCE: HORIZONTAL AT 3 M

NO.	FREQ. (MHz)	EMISSION LEVEL (dBuV/m)	LIMIT (dBuV/m)	MARGIN (dB)	ANTENNA HEIGHT (m)	TABLE ANGLE (Degree)	RAW VALUE (dBuV)	CORRECTION FACTOR (dB/m)
1	*5700.00	102.50 PK			1.88 H	201	95.85	6.65
2	*5700.00	91.91 AV			1.88 H	201	85.26	6.65
3	5725.00	62.97 PK	68.20	-5.23	1.88 H	201	56.29	6.68
4	11400.00	56.42 PK	74.00	-17.58	1.47 H	157	39.42	17.00
5	11400.00	42.82 AV	54.00	-11.18	1.47 H	157	25.82	17.00

ANTENNA POLARITY & TEST DISTANCE: VERTICAL AT 3 M

NO.	FREQ. (MHz)	EMISSION LEVEL (dBuV/m)	LIMIT (dBuV/m)	MARGIN (dB)	ANTENNA HEIGHT (m)	TABLE ANGLE (Degree)	RAW VALUE (dBuV)	CORRECTION FACTOR (dB/m)
1	*5700.00	117.26 PK			1.79 V	299	110.61	6.65
2	*5700.00	104.32 AV			1.79 V	299	97.67	6.65
3	5725.00	67.17 PK	68.20	-1.03	1.79 V	299	60.49	6.68
4	11400.00	57.85 PK	74.00	-16.15	1.88 V	269	40.85	17.00
5	11400.00	43.96 AV	54.00	-10.04	1.88 V	269	26.96	17.00

REMARKS:

1. Emission Level(dBuV/m) = Raw Value(dBuV) + Correction Factor(dB/m)
2. Correction Factor(dB/m) = Antenna Factor(dB/m) + Cable Factor(dB) – Pre-Amplifier Factor(dB)
3. The other emission levels were very low against the limit.
4. Margin value = Emission Level – Limit value
5. " * ": Fundamental frequency.

802.11ac (40MHz)

CHANNEL	TX Channel 54	DETECTOR FUNCTION	Peak (PK)
FREQUENCY RANGE	1GHz ~ 40GHz		Average (AV)

ANTENNA POLARITY & TEST DISTANCE: HORIZONTAL AT 3 M

NO.	FREQ. (MHz)	EMISSION LEVEL (dBuV/m)	LIMIT (dBuV/m)	MARGIN (dB)	ANTENNA HEIGHT (m)	TABLE ANGLE (Degree)	RAW VALUE (dBuV)	CORRECTION FACTOR (dB/m)
1	5150.00	56.17 PK	74.00	-17.83	1.89 H	206	51.26	4.91
2	5150.00	41.89 AV	54.00	-12.11	1.89 H	206	36.98	4.91
3	*5270.00	104.00 PK			1.89 H	206	98.89	5.11
4	*5270.00	90.80 AV			1.89 H	206	85.69	5.11
5	#10520.00	55.47 PK	74.00	-18.53	2.18 H	237	39.64	15.83
6	#10520.00	42.21 AV	54.00	-11.79	2.18 H	237	26.38	15.83

ANTENNA POLARITY & TEST DISTANCE: VERTICAL AT 3 M

NO.	FREQ. (MHz)	EMISSION LEVEL (dBuV/m)	LIMIT (dBuV/m)	MARGIN (dB)	ANTENNA HEIGHT (m)	TABLE ANGLE (Degree)	RAW VALUE (dBuV)	CORRECTION FACTOR (dB/m)
1	5150.00	58.08 PK	74.00	-15.92	1.77 V	324	53.17	4.91
2	5150.00	43.75 AV	54.00	-10.25	1.77 V	324	38.84	4.91
3	*5270.00	119.92 PK			1.77 V	324	114.81	5.11
4	*5270.00	100.34 AV			1.77 V	324	95.23	5.11
5	#10540.00	56.72 PK	74.00	-17.28	1.68 V	142	40.87	15.85
6	#10540.00	43.73 AV	54.00	-10.27	1.68 V	142	27.88	15.85

REMARKS:

1. Emission Level(dBuV/m) = Raw Value(dBuV) + Correction Factor(dB/m)
2. Correction Factor(dB/m) = Antenna Factor(dB/m) + Cable Factor(dB) – Pre-Amplifier Factor(dB)
3. The other emission levels were very low against the limit.
4. Margin value = Emission Level – Limit value
5. " * ": Fundamental frequency.
6. " # ": The radiated frequency is out of the restricted band.

CHANNEL	TX Channel 62	DETECTOR FUNCTION	Peak (PK)
FREQUENCY RANGE	1GHz ~ 40GHz		Average (AV)

ANTENNA POLARITY & TEST DISTANCE: HORIZONTAL AT 3 M

NO.	FREQ. (MHz)	EMISSION LEVEL (dBuV/m)	LIMIT (dBuV/m)	MARGIN (dB)	ANTENNA HEIGHT (m)	TABLE ANGLE (Degree)	RAW VALUE (dBuV)	CORRECTION FACTOR (dB/m)
1	*5310.00	103.97 PK			1.72 H	209	98.77	5.20
2	*5310.00	91.49 AV			1.72 H	209	86.29	5.20
3	5350.00	65.53 PK	74.00	-8.47	1.72 H	209	60.18	5.35
4	5350.00	42.79 AV	54.00	-11.21	1.72 H	209	37.44	5.35
5	10620.00	55.63 PK	74.00	-18.37	1.88 H	241	39.64	15.99
6	10620.00	42.88 AV	54.00	-11.12	1.88 H	241	26.89	15.99

ANTENNA POLARITY & TEST DISTANCE: VERTICAL AT 3 M

NO.	FREQ. (MHz)	EMISSION LEVEL (dBuV/m)	LIMIT (dBuV/m)	MARGIN (dB)	ANTENNA HEIGHT (m)	TABLE ANGLE (Degree)	RAW VALUE (dBuV)	CORRECTION FACTOR (dB/m)
1	*5310.00	118.92 PK			1.81 V	267	113.72	5.20
2	*5310.00	101.82 AV			1.81 V	267	96.62	5.20
3	5350.00	69.60 PK	74.00	-4.40	1.81 V	267	64.25	5.35
4	5350.00	44.27 AV	54.00	-9.73	1.81 V	267	38.92	5.35
5	10620.00	56.63 PK	74.00	-17.37	2.06 V	298	40.64	15.99
6	10620.00	43.97 AV	54.00	-10.03	2.06 V	298	27.98	15.99

REMARKS:

1. Emission Level(dBuV/m) = Raw Value(dBuV) + Correction Factor(dB/m)
2. Correction Factor(dB/m) = Antenna Factor(dB/m) + Cable Factor(dB) – Pre-Amplifier Factor(dB)
3. The other emission levels were very low against the limit.
4. Margin value = Emission Level – Limit value
5. " * ": Fundamental frequency.

CHANNEL	TX Channel 102	DETECTOR FUNCTION	Peak (PK)
FREQUENCY RANGE	1GHz ~ 40GHz		Average (AV)

ANTENNA POLARITY & TEST DISTANCE: HORIZONTAL AT 3 M

NO.	FREQ. (MHz)	EMISSION LEVEL (dBuV/m)	LIMIT (dBuV/m)	MARGIN (dB)	ANTENNA HEIGHT (m)	TABLE ANGLE (Degree)	RAW VALUE (dBuV)	CORRECTION FACTOR (dB/m)
1	5460.00	60.23 PK	74.00	-13.77	1.47 H	215	54.46	5.77
2	5460.00	42.88 AV	54.00	-11.12	1.47 H	215	37.11	5.77
3	5470.00	63.30 PK	68.20	-4.90	1.47 H	215	57.48	5.82
4	*5510.00	102.27 PK			1.47 H	215	96.26	6.01
5	*5510.00	91.60 AV			1.47 H	215	85.59	6.01
6	11020.00	56.87 PK	74.00	-17.13	2.61 H	159	39.48	17.39
7	11020.00	42.90 AV	54.00	-11.10	2.61 H	159	25.51	17.39

ANTENNA POLARITY & TEST DISTANCE: VERTICAL AT 3 M

NO.	FREQ. (MHz)	EMISSION LEVEL (dBuV/m)	LIMIT (dBuV/m)	MARGIN (dB)	ANTENNA HEIGHT (m)	TABLE ANGLE (Degree)	RAW VALUE (dBuV)	CORRECTION FACTOR (dB/m)
1	5460.00	63.82 PK	74.00	-10.18	1.90 V	315	58.05	5.77
2	5460.00	45.47 AV	54.00	-8.53	1.90 V	315	39.70	5.77
3	5470.00	67.06 PK	68.20	-1.14	1.90 V	315	61.24	5.82
4	*5510.00	113.22 PK			1.90 V	315	107.21	6.01
5	*5510.00	100.70 AV			1.90 V	315	94.69	6.01
6	11020.00	58.23 PK	74.00	-15.77	1.58 V	228	40.84	17.39
7	11020.00	44.37 AV	54.00	-9.63	1.58 V	228	26.98	17.39

REMARKS:

1. Emission Level(dBuV/m) = Raw Value(dBuV) + Correction Factor(dB/m)
2. Correction Factor(dB/m) = Antenna Factor(dB/m) + Cable Factor(dB) – Pre-Amplifier Factor(dB)
3. The other emission levels were very low against the limit.
4. Margin value = Emission Level – Limit value
5. " * ": Fundamental frequency.

CHANNEL	TX Channel 110	DETECTOR FUNCTION	Peak (PK)
FREQUENCY RANGE	1GHz ~ 40GHz		Average (AV)

ANTENNA POLARITY & TEST DISTANCE: HORIZONTAL AT 3 M

NO.	FREQ. (MHz)	EMISSION LEVEL (dBuV/m)	LIMIT (dBuV/m)	MARGIN (dB)	ANTENNA HEIGHT (m)	TABLE ANGLE (Degree)	RAW VALUE (dBuV)	CORRECTION FACTOR (dB/m)
1	*5550.00	105.52 PK			1.46 H	215	99.26	6.26
2	*5550.00	96.10 AV			1.46 H	215	89.84	6.26
3	11100.00	56.89 PK	74.00	-17.11	2.17 H	48	39.42	17.47
4	11100.00	43.29 AV	54.00	-10.71	2.17 H	48	25.82	17.47

ANTENNA POLARITY & TEST DISTANCE: VERTICAL AT 3 M

NO.	FREQ. (MHz)	EMISSION LEVEL (dBuV/m)	LIMIT (dBuV/m)	MARGIN (dB)	ANTENNA HEIGHT (m)	TABLE ANGLE (Degree)	RAW VALUE (dBuV)	CORRECTION FACTOR (dB/m)
1	*5550.00	118.80 PK			1.87 V	321	112.54	6.26
2	*5550.00	106.11 AV			1.87 V	321	99.85	6.26
3	11100.00	58.09 PK	74.00	-15.91	1.84 V	152	40.62	17.47
4	11100.00	43.63 AV	54.00	-10.37	1.84 V	152	26.16	17.47

REMARKS:

1. Emission Level(dBuV/m) = Raw Value(dBuV) + Correction Factor(dB/m)
2. Correction Factor(dB/m) = Antenna Factor(dB/m) + Cable Factor(dB) – Pre-Amplifier Factor(dB)
3. The other emission levels were very low against the limit.
4. Margin value = Emission Level – Limit value
5. " * ": Fundamental frequency.

CHANNEL	TX Channel 134	DETECTOR FUNCTION	Peak (PK)
FREQUENCY RANGE	1GHz ~ 40GHz		Average (AV)

ANTENNA POLARITY & TEST DISTANCE: HORIZONTAL AT 3 M

NO.	FREQ. (MHz)	EMISSION LEVEL (dBuV/m)	LIMIT (dBuV/m)	MARGIN (dB)	ANTENNA HEIGHT (m)	TABLE ANGLE (Degree)	RAW VALUE (dBuV)	CORRECTION FACTOR (dB/m)
1	*5670.00	104.79 PK			1.47 H	241	98.16	6.63
2	*5670.00	93.52 AV			1.47 H	241	86.89	6.63
3	5725.00	63.47 PK	68.20	-4.73	1.47 H	241	56.79	6.68
4	11340.00	56.18 PK	74.00	-17.82	2.81 H	285	39.19	16.99
5	11340.00	42.80 AV	54.00	-11.20	2.81 H	285	25.81	16.99

ANTENNA POLARITY & TEST DISTANCE: VERTICAL AT 3 M

NO.	FREQ. (MHz)	EMISSION LEVEL (dBuV/m)	LIMIT (dBuV/m)	MARGIN (dB)	ANTENNA HEIGHT (m)	TABLE ANGLE (Degree)	RAW VALUE (dBuV)	CORRECTION FACTOR (dB/m)
1	*5670.00	116.74 PK			2.01 V	344	110.11	6.63
2	*5670.00	99.30 AV			2.01 V	344	92.67	6.63
3	5725.00	67.05 PK	68.20	-1.15	2.01 V	344	60.37	6.68
4	11340.00	57.84 PK	74.00	-16.16	1.62 V	234	40.85	16.99
5	11340.00	43.50 AV	54.00	-10.50	1.62 V	234	26.51	16.99

REMARKS:

1. Emission Level(dBuV/m) = Raw Value(dBuV) + Correction Factor(dB/m)
2. Correction Factor(dB/m) = Antenna Factor(dB/m) + Cable Factor(dB) – Pre-Amplifier Factor(dB)
3. The other emission levels were very low against the limit.
4. Margin value = Emission Level – Limit value
5. " * ": Fundamental frequency.

802.11ac (80MHz)

CHANNEL	TX Channel 58	DETECTOR FUNCTION	Peak (PK)
FREQUENCY RANGE	1GHz ~ 40GHz		Average (AV)

ANTENNA POLARITY & TEST DISTANCE: HORIZONTAL AT 3 M

NO.	FREQ. (MHz)	EMISSION LEVEL (dBuV/m)	LIMIT (dBuV/m)	MARGIN (dB)	ANTENNA HEIGHT (m)	TABLE ANGLE (Degree)	RAW VALUE (dBuV)	CORRECTION FACTOR (dB/m)
1	5150.00	62.40 PK	74.00	-11.60	1.68 H	214	57.49	4.91
2	5150.00	41.67 AV	54.00	-12.33	1.68 H	214	36.76	4.91
3	*5290.00	102.29 PK			1.68 H	214	97.15	5.14
4	*5290.00	85.33 AV			1.68 H	214	80.19	5.14
5	5350.00	66.38 PK	74.00	-7.62	1.68 H	214	61.03	5.35
6	5350.00	42.45 AV	54.00	-11.55	1.68 H	214	37.10	5.35
7	#10580.00	55.74 PK	74.00	-18.26	1.74 H	151	39.85	15.89
8	#10580.00	41.77 AV	54.00	-12.23	1.74 H	151	25.88	15.89

ANTENNA POLARITY & TEST DISTANCE: VERTICAL AT 3 M

NO.	FREQ. (MHz)	EMISSION LEVEL (dBuV/m)	LIMIT (dBuV/m)	MARGIN (dB)	ANTENNA HEIGHT (m)	TABLE ANGLE (Degree)	RAW VALUE (dBuV)	CORRECTION FACTOR (dB/m)
1	5150.00	67.75 PK	74.00	-6.25	1.53 V	313	62.84	4.91
2	5150.00	43.89 AV	54.00	-10.11	1.53 V	313	38.98	4.91
3	*5290.00	118.13 PK			1.53 V	313	112.99	5.14
4	*5290.00	96.84 AV			1.53 V	313	91.70	5.14
5	5350.00	71.43 PK	74.00	-2.57	1.53 V	313	66.08	5.35
6	5350.00	44.18 AV	54.00	-9.82	1.53 V	313	38.83	5.35
7	#10580.00	56.08 PK	74.00	-17.92	2.05 V	231	40.19	15.89
8	#10580.00	42.72 AV	54.00	-11.28	2.05 V	231	26.83	15.89

REMARKS:

1. Emission Level(dBuV/m) = Raw Value(dBuV) + Correction Factor(dB/m)
2. Correction Factor(dB/m) = Antenna Factor(dB/m) + Cable Factor(dB) – Pre-Amplifier Factor(dB)
3. The other emission levels were very low against the limit.
4. Margin value = Emission Level – Limit value
5. " * ": Fundamental frequency.
6. " # ": The radiated frequency is out of the restricted band.

CHANNEL	TX Channel 106	DETECTOR FUNCTION	Peak (PK)
FREQUENCY RANGE	1GHz ~ 40GHz		Average (AV)

ANTENNA POLARITY & TEST DISTANCE: HORIZONTAL AT 3 M

NO.	FREQ. (MHz)	EMISSION LEVEL (dBuV/m)	LIMIT (dBuV/m)	MARGIN (dB)	ANTENNA HEIGHT (m)	TABLE ANGLE (Degree)	RAW VALUE (dBuV)	CORRECTION FACTOR (dB/m)
1	5460.00	59.93 PK	74.00	-14.07	1.52 H	219	54.16	5.77
2	5460.00	42.32 AV	54.00	-11.68	1.52 H	219	36.55	5.77
3	5470.00	63.31 PK	68.20	-4.89	1.52 H	219	57.49	5.82
4	*5530.00	102.39 PK			1.52 H	219	96.26	6.13
5	*5530.00	85.77 AV			1.52 H	219	79.64	6.13
6	11060.00	57.07 PK	74.00	-16.93	2.30 H	215	39.64	17.43
7	11060.00	42.56 AV	54.00	-11.44	2.30 H	215	25.13	17.43

ANTENNA POLARITY & TEST DISTANCE: VERTICAL AT 3 M

NO.	FREQ. (MHz)	EMISSION LEVEL (dBuV/m)	LIMIT (dBuV/m)	MARGIN (dB)	ANTENNA HEIGHT (m)	TABLE ANGLE (Degree)	RAW VALUE (dBuV)	CORRECTION FACTOR (dB/m)
1	5460.00	65.66 PK	74.00	-8.34	2.00 V	296	59.89	5.77
2	5460.00	44.69 AV	54.00	-9.31	2.00 V	296	38.92	5.77
3	5470.00	67.06 PK	68.20	-1.14	2.00 V	296	61.24	5.82
4	*5530.00	112.33 PK			2.00 V	296	106.20	6.13
5	*5530.00	95.64 AV			2.00 V	296	89.51	6.13
6	11060.00	58.28 PK	74.00	-15.72	1.62 V	215	40.85	17.43
7	11060.00	44.28 AV	54.00	-9.72	1.62 V	215	26.85	17.43

REMARKS:

1. Emission Level(dBuV/m) = Raw Value(dBuV) + Correction Factor(dB/m)
2. Correction Factor(dB/m) = Antenna Factor(dB/m) + Cable Factor(dB) – Pre-Amplifier Factor(dB)
3. The other emission levels were very low against the limit.
4. Margin value = Emission Level – Limit value
5. " * ": Fundamental frequency.

CHANNEL	TX Channel 122	DETECTOR FUNCTION	Peak (PK)
FREQUENCY RANGE	1GHz ~ 40GHz		Average (AV)

ANTENNA POLARITY & TEST DISTANCE: HORIZONTAL AT 3 M

NO.	FREQ. (MHz)	EMISSION LEVEL (dBuV/m)	LIMIT (dBuV/m)	MARGIN (dB)	ANTENNA HEIGHT (m)	TABLE ANGLE (Degree)	RAW VALUE (dBuV)	CORRECTION FACTOR (dB/m)
1	*5610.00	106.43 PK			1.48 H	223	99.85	6.58
2	*5610.00	86.26 AV			1.48 H	223	79.68	6.58
3	5725.00	63.02 PK	68.20	-5.18	1.48 H	223	56.34	6.68
4	11220.00	56.62 PK	74.00	-17.38	1.56 H	230	39.46	17.16
5	11220.00	42.41 AV	54.00	-11.59	1.56 H	230	25.25	17.16

ANTENNA POLARITY & TEST DISTANCE: VERTICAL AT 3 M

NO.	FREQ. (MHz)	EMISSION LEVEL (dBuV/m)	LIMIT (dBuV/m)	MARGIN (dB)	ANTENNA HEIGHT (m)	TABLE ANGLE (Degree)	RAW VALUE (dBuV)	CORRECTION FACTOR (dB/m)
1	*5610.00	116.32 PK			1.84 V	293	109.74	6.58
2	*5610.00	95.91 AV			1.84 V	293	89.33	6.58
3	5725.00	67.19 PK	68.20	-1.01	1.84 V	293	60.51	6.68
4	11220.00	58.00 PK	74.00	-16.00	1.78 V	264	40.84	17.16
5	11220.00	44.06 AV	54.00	-9.94	1.78 V	264	26.90	17.16

REMARKS:

1. Emission Level(dBuV/m) = Raw Value(dBuV) + Correction Factor(dB/m)
2. Correction Factor(dB/m) = Antenna Factor(dB/m) + Cable Factor(dB) – Pre-Amplifier Factor(dB)
3. The other emission levels were very low against the limit.
4. Margin value = Emission Level – Limit value
5. " * ": Fundamental frequency.

Below 1GHz Data:

CDD Mode (Mode A)

802.11a

CHANNEL	TX Channel 52	DETECTOR FUNCTION	Quasi-Peak (QP)
FREQUENCY RANGE	9kHz ~ 1GHz		

ANTENNA POLARITY & TEST DISTANCE: HORIZONTAL AT 3 M

NO.	FREQ. (MHz)	EMISSION LEVEL (dBuV/m)	LIMIT (dBuV/m)	MARGIN (dB)	ANTENNA HEIGHT (m)	TABLE ANGLE (Degree)	RAW VALUE (dBuV)	CORRECTION FACTOR (dB/m)
1	36.74	29.70 QP	40.00	-10.30	1.88 H	54	39.85	-10.15
2	148.29	24.98 QP	43.50	-18.52	2.74 H	256	34.14	-9.16
3	215.66	32.10 QP	43.50	-11.40	1.45 H	79	43.21	-11.11
4	293.89	27.06 QP	46.00	-18.94	2.63 H	313	34.66	-7.60
5	400.01	37.62 QP	46.00	-8.38	2.54 H	117	42.94	-5.32
6	473.24	29.69 QP	46.00	-16.31	1.29 H	243	33.16	-3.47

ANTENNA POLARITY & TEST DISTANCE: VERTICAL AT 3 M

NO.	FREQ. (MHz)	EMISSION LEVEL (dBuV/m)	LIMIT (dBuV/m)	MARGIN (dB)	ANTENNA HEIGHT (m)	TABLE ANGLE (Degree)	RAW VALUE (dBuV)	CORRECTION FACTOR (dB/m)
1	33.20	34.11 QP	40.00	-5.89	1.64 V	182	44.79	-10.68
2	148.15	26.28 QP	43.50	-17.22	1.29 V	74	35.45	-9.17
3	217.55	26.92 QP	46.00	-19.08	1.82 V	340	38.01	-11.09
4	279.97	26.38 QP	46.00	-19.62	1.08 V	158	34.31	-7.93
5	409.42	33.94 QP	46.00	-12.06	1.42 V	166	39.14	-5.20
6	474.79	33.26 QP	46.00	-12.74	1.78 V	166	36.74	-3.48

REMARKS:

1. Emission Level(dBuV/m) = Raw Value(dBuV) + Correction Factor(dB/m)
2. Correction Factor(dB/m) = Antenna Factor(dB/m) + Cable Factor(dB) – Pre-Amplifier Factor(dB)
3. The other emission levels were very low against the limit.
4. Margin value = Emission Level – Limit value

CDD Mode (Mode B)

802.11a

CHANNEL	TX Channel 52	DETECTOR FUNCTION	Quasi-Peak (QP)
FREQUENCY RANGE	9kHz ~ 1GHz		

ANTENNA POLARITY & TEST DISTANCE: HORIZONTAL AT 3 M

NO.	FREQ. (MHz)	EMISSION LEVEL (dBuV/m)	LIMIT (dBuV/m)	MARGIN (dB)	ANTENNA HEIGHT (m)	TABLE ANGLE (Degree)	RAW VALUE (dBuV)	CORRECTION FACTOR (dB/m)
1	36.45	30.27 QP	40.00	-9.73	2.14 H	225	40.44	-10.17
2	146.59	23.63 QP	43.50	-19.87	1.69 H	252	32.78	-9.15
3	223.32	32.18 QP	46.00	-13.82	2.63 H	277	43.40	-11.22
4	302.04	26.17 QP	46.00	-19.83	2.29 H	310	33.51	-7.34
5	412.47	39.33 QP	46.00	-6.67	2.88 H	252	44.43	-5.10
6	471.40	29.99 QP	46.00	-16.01	1.52 H	124	33.47	-3.48

ANTENNA POLARITY & TEST DISTANCE: VERTICAL AT 3 M

NO.	FREQ. (MHz)	EMISSION LEVEL (dBuV/m)	LIMIT (dBuV/m)	MARGIN (dB)	ANTENNA HEIGHT (m)	TABLE ANGLE (Degree)	RAW VALUE (dBuV)	CORRECTION FACTOR (dB/m)
1	34.03	35.04 QP	40.00	-4.96	1.34 V	207	45.61	-10.57
2	147.03	25.09 QP	43.50	-18.41	1.28 V	114	34.26	-9.17
3	225.46	28.29 QP	46.00	-17.71	1.96 V	202	39.58	-11.29
4	410.63	35.14 QP	46.00	-10.86	2.20 V	147	40.32	-5.18
5	474.99	31.74 QP	46.00	-14.26	1.57 V	188	35.22	-3.48
6	606.52	37.70 QP	46.00	-8.30	1.42 V	56	38.15	-0.45

REMARKS:

1. Emission Level(dBuV/m) = Raw Value(dBuV) + Correction Factor(dB/m)
2. Correction Factor(dB/m) = Antenna Factor(dB/m) + Cable Factor(dB) – Pre-Amplifier Factor(dB)
3. The other emission levels were very low against the limit.
4. Margin value = Emission Level – Limit value

4.2 Conducted Emission Measurement

4.2.1 Limits of Conducted Emission Measurement

Frequency (MHz)	Conducted Limit (dBuV)	
	Quasi-peak	Average
0.15 - 0.5	66 - 56	56 - 46
0.50 - 5.0	56	46
5.0 - 30.0	60	50

Note: 1. The lower limit shall apply at the transition frequencies.

2. The limit decreases in line with the logarithm of the frequency in the range of 0.15 to 0.50MHz.

4.2.2 Test Instruments

Description & Manufacturer	Model No.	Serial No.	Cal. Date	Cal. Due
ROHDE & SCHWARZ TEST RECEIVER	ESCS 30	100276	Apr. 10, 2017	Apr. 09, 2018
ROHDE & SCHWARZ Artificial Mains Network (for EUT)	ENV216	101197	May 22, 2017	May 21, 2018
LISN With Adapter (for EUT)	AD10	C10Ada-002	May 22, 2017	May 21, 2018
ROHDE & SCHWARZ Artificial Mains Network (for peripherals)	ESH3-Z5	100218	Nov. 23, 2016	Nov. 22, 2017
SCHWARZBECK Artificial Mains Network (For EUT)	NNLK8129	8129229	May 09, 2017	May 08, 2018
Software	Cond_V7.3.7.4	NA	NA	NA
RF cable (JYEBAO) With 10dB PAD	5D-FB	Cable-C10.01	Feb. 14, 2017	Feb. 13, 2018
SUHNER Terminator (For ROHDE & SCHWARZ LISN)	65BNC-5001	E1-011484	May 18, 2017	May 17, 2018
ROHDE & SCHWARZ Artificial Mains Network (For TV EUT)	ESH3-Z5	100220	Nov. 08, 2016	Nov. 07, 2017
LISN With Adapter (for TV EUT)	100220	N/A	Nov. 08, 2016	Nov. 07, 2017

Notes: 1. The calibration interval of the above test instruments is 12 months and the calibrations are traceable to NML/ROC and NIST/USA.

2. The test was performed in Shielded Room No. 10.

3. The FCC Designation Number is TW2021.

4. Tested Date: Sep. 18, 2017

4.2.3 Test Procedure

- The EUT was placed 0.4 meters from the conducting wall of the shielded room with EUT being connected to the power mains through a line impedance stabilization network (LISN). Other support units were connected to the power mains through another LISN. The two LISNs provide 50 ohm/ 50uH of coupling impedance for the measuring instrument.
- Both lines of the power mains connected to the EUT were checked for maximum conducted interference.
- The frequency range from 150kHz to 30MHz was searched. Emission levels under (Limit - 20dB) was not recorded.

NOTE: All modes of operation were investigated and the worst-case emissions are reported.

4.2.4 Deviation from Test Standard

No deviation.

4.2.5 Test Setup

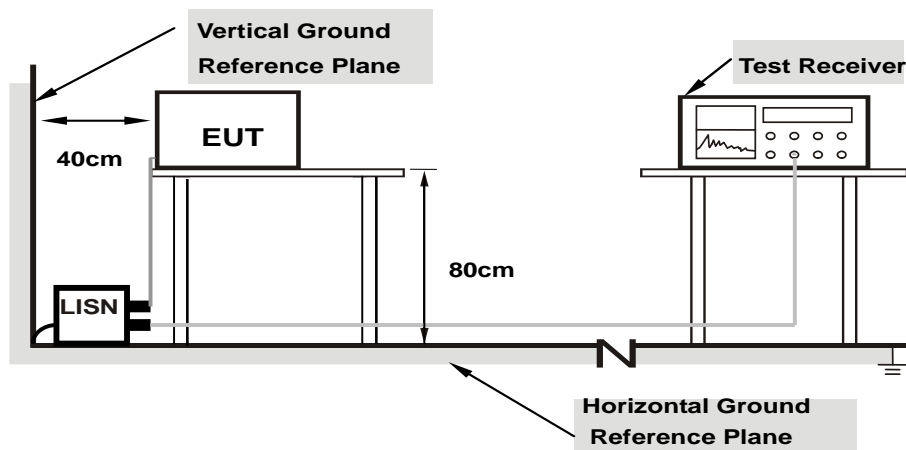

Note: 1.Support units were connected to second LISN.

For the actual test configuration, please refer to the attached file (Test Setup Photo).

4.2.6 EUT Operating Condition

Same as 4.1.6.

4.2.7 Test Results

CDD MODE

Phase	Line (L)	Detector Function	Quasi-Peak (QP) / Average (AV)
-------	----------	-------------------	--------------------------------

No	Freq. [MHz]	Corr.	Reading Value		Emission Level		Limit		Margin	
		Factor	[dB (uV)]		[dB (uV)]		[dB (uV)]		(dB)	
		(dB)	Q.P.	AV.	Q.P.	AV.	Q.P.	AV.	Q.P.	AV.
1	0.15000	9.65	33.32	24.03	42.97	33.68	66.00	56.00	-23.03	-22.32
2	0.35703	9.66	36.96	36.83	46.62	46.49	58.80	48.80	-12.18	-2.31
3	0.63828	9.68	19.92	18.22	29.60	27.90	56.00	46.00	-26.40	-18.10
4	4.09766	9.84	20.05	13.08	29.89	22.92	56.00	46.00	-26.11	-23.08
5	9.97656	9.93	26.26	21.70	36.19	31.63	60.00	50.00	-23.81	-18.37
6	21.87500	10.02	28.12	26.55	38.14	36.57	60.00	50.00	-21.86	-13.43

REMARKS:

1. Q.P. and AV. are abbreviations of quasi-peak and average individually.
2. The emission levels of other frequencies were very low against the limit.
3. Margin value = Emission level - Limit value
4. Correction factor = Insertion loss + Cable loss
5. Emission Level = Correction Factor + Reading Value.

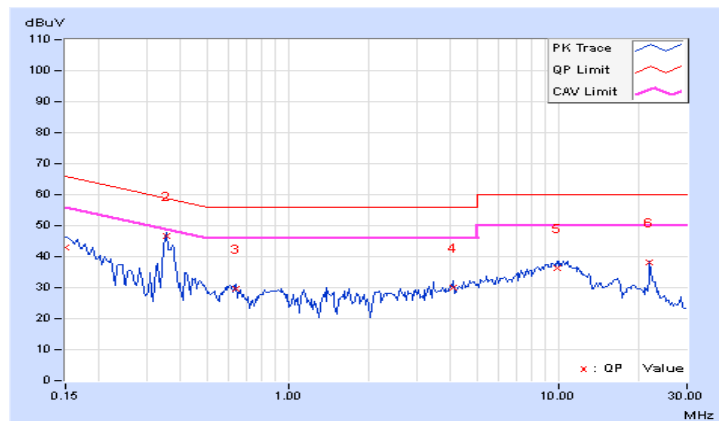

Phase	Neutral (N)	Detector Function	Quasi-Peak (QP) / Average (AV)
-------	-------------	-------------------	--------------------------------

No	Freq. [MHz]	Corr.	Reading Value		Emission Level		Limit		Margin	
		Factor	[dB (uV)]		[dB (uV)]		[dB (uV)]		(dB)	
		(dB)	Q.P.	AV.	Q.P.	AV.	Q.P.	AV.	Q.P.	AV.
1	0.15391	9.67	37.26	24.53	46.93	34.20	65.79	55.79	-18.86	-21.59
2	0.35313	9.68	38.20	36.66	47.88	46.34	58.89	48.89	-11.01	-2.55
3	0.63828	9.69	20.62	19.02	30.31	28.71	56.00	46.00	-25.69	-17.29
4	2.62891	9.78	17.93	11.07	27.71	20.85	56.00	46.00	-28.29	-25.15
5	10.91016	9.96	25.99	21.34	35.95	31.30	60.00	50.00	-24.05	-18.70
6	21.87500	10.08	29.12	28.49	39.20	38.57	60.00	50.00	-20.80	-11.43

REMARKS:

1. Q.P. and AV. are abbreviations of quasi-peak and average individually.
2. The emission levels of other frequencies were very low against the limit.
3. Margin value = Emission level - Limit value
4. Correction factor = Insertion loss + Cable loss
5. Emission Level = Correction Factor + Reading Value.

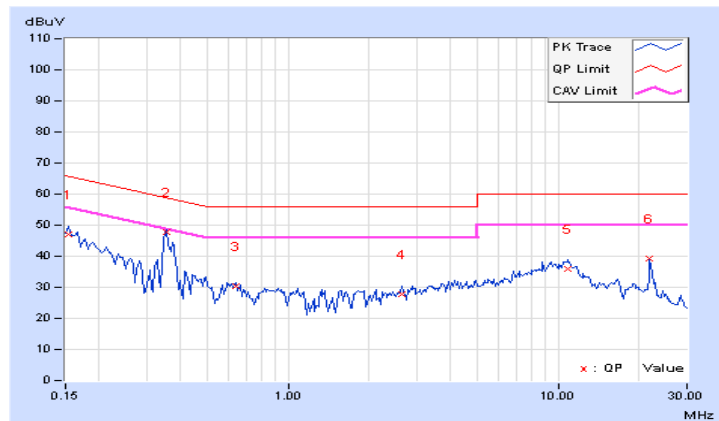

4.3 Transmit Power Measurement

4.3.1 Limits of Transmit Power Measurement

Operation Band	EUT Category		Limit
U-NII-1	---	Outdoor Access Point	1 Watt (30 dBm) (Max. e.i.r.p \leq 125mW(21 dBm) at any elevation angle above 30 degrees as measured from the horizon)
	---	Fixed point-to-point Access Point	1 Watt (30 dBm)
	---	Indoor Access Point	1 Watt (30 dBm)
	---	Mobile and Portable client device	250mW (24 dBm)
U-NII-2A	√		250mW (24 dBm) or 11 dBm+10 log B*
U-NII-2C	√		250mW (24 dBm) or 11 dBm+10 log B*
U-NII-3	---		1 Watt (30 dBm)

*B is the 26 dB emission bandwidth in megahertz

Per KDB 662911 Method of conducted output power measurement on IEEE 802.11 devices,

Array Gain = 0 dB (i.e., no array gain) for $N_{ANT} \leq 4$;

Array Gain = 0 dB (i.e., no array gain) for channel widths ≥ 40 MHz for any N_{ANT} ;

Array Gain = $5 \log(N_{ANT}/N_{SS})$ dB or 3 dB, whichever is less for 20-MHz channel widths with $N_{ANT} \geq 5$.

For power measurements on all other devices: Array Gain = $10 \log(N_{ANT}/N_{SS})$ dB.

4.3.2 Test Setup

For Power Output Measurement

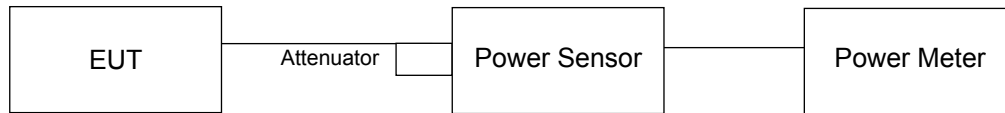

For 26dB Occupied Bandwidth

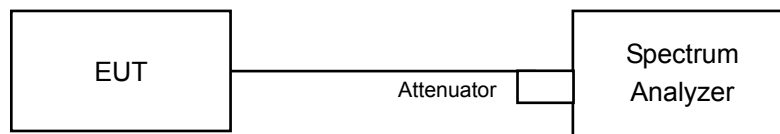

4.3.3 Test Instruments

Refer to section 4.1.2 to get information of above instrument.

4.3.4 Test Procedure

For Average Power Measurement

For 802.11a, 802.11ac (20MHz), 802.11ac (40MHz)

Method PM is used to perform output power measurement, trigger and gating function of wide band power meter is enabled to measure max output power of TX on burst and set the detector to AVERAGE. Duty factor is not added to measured value.

For 802.11ac (80MHz)

- 1) Set span to encompass the entire 26 dB EBW (or, alternatively, the entire 99% occupied bandwidth) of the signal.
- 2) Set sweep trigger to "free run".
- 3) Set RBW = 1 MHz.
- 4) Set VBW \geq 3 MHz
- 5) Number of points in sweep \geq 2 Span / RBW.
- 6) Sweep time \leq (number of points in sweep) * T
- 7) Using emission bandwidth to determine the frequency span for integration the channel bandwidth.
- 8) Detector = RMS.
- 9) Trace mode = max hold.
- 10) Allow max hold to run for at least 60 seconds, or longer as needed to allow the trace to stabilize.

For 26dB Occupied Bandwidth

- 1) Set RBW = approximately 1% of the emission bandwidth.
- 2) Set the VBW > RBW.
- 3) Detector = Peak.
- 4) Trace mode = max hold.
- 5) Measure the maximum width of the emission that is 26 dB down from the peak of the emission. Compare this with the RBW setting of the analyzer. Readjust RBW and repeat measurement as needed until the RBW/EBW ratio is approximately 1%.

4.3.5 Deviation from Test Standard

No deviation.

4.3.6 EUT Operating Condition

The software provided by client to enable the EUT under transmission condition continuously at lowest, middle and highest channel frequencies individually.

4.3.7 Test Result

CDD Mode (Mode A)

Power Output:

802.11a

Chan.	Chan. Freq. (MHz)	Maximum Conducted Power (dBm)				Total Power (mW)	Total Power (dBm)	Power Limit (dBm)	Pass/Fail
		Chain 0	Chain 1	Chain 2	Chain 3				
52	5260	11.78	12.05	12.16	13.22	68.531	18.36	24.00	PASS
60	5300	11.70	11.95	12.19	13.28	68.298	18.34	23.99	PASS
64	5320	11.74	11.94	12.17	13.26	68.225	18.34	23.97	PASS
100	5500	13.25	14.15	12.75	12.74	84.766	19.28	23.98	PASS
116	5580	13.52	13.22	13.38	12.81	84.356	19.26	24.00	PASS
132	5660	13.60	13.24	13.39	12.84	85.053	19.30	24.00	PASS
140	5700	13.52	13.12	13.39	13.04	84.967	19.29	24.00	PASS

NOTE:

Chain 0:

1. $11\text{dBm} + 10\log (20.10) = 24.03 > 24\text{dBm}$
2. $11\text{dBm} + 10\log (19.90) = 23.99 < 24\text{dBm}$
3. $11\text{dBm} + 10\log (20.15) = 24.04 > 24\text{dBm}$
4. $11\text{dBm} + 10\log (20.16) = 24.04 > 24\text{dBm}$
5. $11\text{dBm} + 10\log (20.10) = 24.03 > 24\text{dBm}$
6. $11\text{dBm} + 10\log (20.19) = 24.05 > 24\text{dBm}$
7. $11\text{dBm} + 10\log (20.08) = 24.03 > 24\text{dBm}$

Chain 2:

1. $11\text{dBm} + 10\log (20.36) = 24.09 > 24\text{dBm}$
2. $11\text{dBm} + 10\log (20.18) = 24.05 > 24\text{dBm}$
3. $11\text{dBm} + 10\log (19.83) = 23.97 < 24\text{dBm}$
4. $11\text{dBm} + 10\log (19.85) = 23.98 < 24\text{dBm}$
5. $11\text{dBm} + 10\log (20.08) = 24.03 > 24\text{dBm}$
6. $11\text{dBm} + 10\log (20.21) = 24.06 > 24\text{dBm}$
7. $11\text{dBm} + 10\log (20.03) = 24.02 > 24\text{dBm}$

Chain 1:

1. $11\text{dBm} + 10\log (20.44) = 24.10 > 24\text{dBm}$
2. $11\text{dBm} + 10\log (20.04) = 24.02 > 24\text{dBm}$
3. $11\text{dBm} + 10\log (20.19) = 24.05 > 24\text{dBm}$
4. $11\text{dBm} + 10\log (20.01) = 24.01 > 24\text{dBm}$
5. $11\text{dBm} + 10\log (20.22) = 24.06 > 24\text{dBm}$
6. $11\text{dBm} + 10\log (20.11) = 24.03 > 24\text{dBm}$
7. $11\text{dBm} + 10\log (19.99) = 24.01 > 24\text{dBm}$

Chain 3:

1. $11\text{dBm} + 10\log (20.09) = 24.03 > 24\text{dBm}$
2. $11\text{dBm} + 10\log (20.34) = 24.08 > 24\text{dBm}$
3. $11\text{dBm} + 10\log (20.21) = 24.06 > 24\text{dBm}$
4. $11\text{dBm} + 10\log (19.97) = 24.00 > 24\text{dBm}$
5. $11\text{dBm} + 10\log (20.09) = 24.03 > 24\text{dBm}$
6. $11\text{dBm} + 10\log (20.24) = 24.06 > 24\text{dBm}$
7. $11\text{dBm} + 10\log (20.02) = 24.01 > 24\text{dBm}$

802.11ac (20MHz)

Chan.	Chan. Freq. (MHz)	Maximum Conducted Power (dBm)				Total Power (mW)	Total Power (dBm)	Power Limit (dBm)	Pass/Fail
		Chain 0	Chain 1	Chain 2	Chain 3				
52	5260	11.72	11.96	12.18	13.22	68.072	18.33	24.00	PASS
60	5300	12.26	12.12	12.06	12.97	69.004	18.39	24.00	PASS
64	5320	12.27	11.78	12.29	13.01	68.874	18.38	24.00	PASS
100	5500	13.68	14.06	13.62	13.36	93.494	19.71	24.00	PASS
116	5580	13.74	13.45	13.85	13.67	93.337	19.70	24.00	PASS
132	5660	14.01	13.26	13.70	13.81	93.847	19.72	24.00	PASS
140	5700	13.77	13.42	14.02	13.47	93.27	19.70	24.00	PASS

NOTE:

Chain 0:

1. 11dBm + 10log (20.98) = 24.22 > 24dBm
2. 11dBm + 10log (20.82) = 24.18 > 24dBm
3. 11dBm + 10log (20.73) = 24.17 > 24dBm
4. 11dBm + 10log (20.74) = 24.17 > 24dBm
5. 11dBm + 10log (20.74) = 24.17 > 24dBm
6. 11dBm + 10log (20.71) = 24.16 > 24dBm
7. 11dBm + 10log (20.71) = 24.16 > 24dBm

Chain 2:

1. 11dBm + 10log (20.92) = 24.21 > 24dBm
2. 11dBm + 10log (20.71) = 24.16 > 24dBm
3. 11dBm + 10log (20.71) = 24.16 > 24dBm
4. 11dBm + 10log (20.91) = 24.20 > 24dBm
5. 11dBm + 10log (20.94) = 24.21 > 24dBm
6. 11dBm + 10log (20.79) = 24.18 > 24dBm
7. 11dBm + 10log (20.83) = 24.19 > 24dBm

Chain 1:

1. 11dBm + 10log (20.71) = 24.16 > 24dBm
2. 11dBm + 10log (20.70) = 24.16 > 24dBm
3. 11dBm + 10log (20.90) = 24.20 > 24dBm
4. 11dBm + 10log (20.89) = 24.20 > 24dBm
5. 11dBm + 10log (20.99) = 24.22 > 24dBm
6. 11dBm + 10log (21.13) = 24.25 > 24dBm
7. 11dBm + 10log (20.61) = 24.14 > 24dBm

Chain 3:

1. 11dBm + 10log (20.81) = 24.18 > 24dBm
2. 11dBm + 10log (20.81) = 24.18 > 24dBm
3. 11dBm + 10log (20.76) = 24.17 > 24dBm
4. 11dBm + 10log (20.72) = 24.16 > 24dBm
5. 11dBm + 10log (20.83) = 24.19 > 24dBm
6. 11dBm + 10log (20.82) = 24.18 > 24dBm
7. 11dBm + 10log (21.00) = 24.22 > 24dBm

802.11ac (40MHz)

Chan.	Chan. Freq. (MHz)	Maximum Conducted Power (dBm)				Total Power (mW)	Total Power (dBm)	Power Limit (dBm)	Pass/Fail
		Chain 0	Chain 1	Chain 2	Chain 3				
54	5270	11.76	12.10	12.46	13.01	68.834	18.38	24.00	PASS
62	5310	11.88	12.02	12.37	12.95	68.321	18.35	24.00	PASS
102	5510	16.02	16.21	16.42	16.05	165.902	22.20	24.00	PASS
110	5550	16.52	16.32	16.25	15.64	166.544	22.22	24.00	PASS
134	5670	16.48	15.37	16.37	16.51	167.02	22.23	24.00	PASS

NOTE:

Chain 0:

1. 11dBm + 10log (40.11) = 27.03 > 24dBm
2. 11dBm + 10log (40.04) = 27.02 > 24dBm
3. 11dBm + 10log (39.93) = 27.01 > 24dBm
4. 11dBm + 10log (39.88) = 27.01 > 24dBm
5. 11dBm + 10log (40.03) = 27.02 > 24dBm

Chain 1:

1. 11dBm + 10log(40.07) = 27.03 > 24dBm
2. 11dBm + 10log(40.16) = 27.04 > 24dBm
3. 11dBm + 10log(40.36) = 27.06 > 24dBm
4. 11dBm + 10log(39.91) = 27.01 > 24dBm
5. 11dBm + 10log(39.95) = 27.02 > 24dBm

Chain 2:

1. 11dBm + 10log (40.18) = 27.04 > 24dBm
2. 11dBm + 10log (39.84) = 27.00 > 24dBm
3. 11dBm + 10log (40.10) = 27.03 > 24dBm
4. 11dBm + 10log (40.08) = 27.03 > 24dBm
5. 11dBm + 10log (40.15) = 27.04 > 24dBm

Chain 3:

1. 11dBm + 10log(40.15) = 27.04 > 24dBm
2. 11dBm + 10log(40.06) = 27.03 > 24dBm
3. 11dBm + 10log(40.00) = 27.02 > 24dBm
4. 11dBm + 10log(40.00) = 27.02 > 24dBm
5. 11dBm + 10log(39.95) = 27.02 > 24dBm

802.11ac (80MHz)

Chan.	Chan. Freq. (MHz)	Maximum Conducted Power (dBm)				Total Power (mW)	Total Power (dBm)	Power Limit (dBm)	Pass/Fail
		Chain 0	Chain 1	Chain 2	Chain 3				
58	5290	11.99	11.85	12.35	13.09	68.672	18.37	24.00	PASS
106	5530	17.78	17.18	17.11	17.03	214.089	23.31	24.00	PASS
122	5610	17.70	17.01	17.07	17.19	212.411	23.27	24.00	PASS

NOTE:

Chain 0:

1. 11dBm + 10log (83.48) = 30.22 > 24dBm
2. 11dBm + 10log (83.77) = 30.23 > 24dBm
3. 11dBm + 10log (84.08) = 30.25 > 24dBm

Chain 1:

1. 11dBm + 10log (84.44) = 30.27 > 24dBm
2. 11dBm + 10log (83.86) = 30.24 > 24dBm
3. 11dBm + 10log (83.44) = 30.21 > 24dBm

Chain 2:

1. 11dBm + 10log (83.85) = 30.24 > 24dBm
2. 11dBm + 10log (83.52) = 30.22 > 24dBm
3. 11dBm + 10log (83.48) = 30.22 > 24dBm

Chain 3:

1. 11dBm + 10log (83.45) = 30.21 > 24dBm
2. 11dBm + 10log (84.00) = 30.24 > 24dBm
3. 11dBm + 10log (83.44) = 30.21 > 24dBm

26dB BANDWIDTH:
802.11a

Channel	Channel Frequency (MHz)	26dBc Bandwidth (MHz)				Pass/Fail
		Chain 0	Chain 1	Chain 2	Chain 3	
52	5260	20.10	20.44	20.36	20.09	Pass
60	5300	19.90	20.04	20.18	20.34	Pass
64	5320	20.15	20.19	19.83	20.21	Pass
100	5500	20.16	20.01	19.85	19.97	Pass
116	5580	20.10	20.22	20.08	20.09	Pass
132	5660	20.19	20.11	20.21	20.24	Pass
140	5700	20.08	19.99	20.03	20.02	Pass

802.11ac (20MHz)

Channel	Channel Frequency (MHz)	26dBc Bandwidth (MHz)				Pass/Fail
		Chain 0	Chain 1	Chain 2	Chain 3	
52	5260	20.98	20.71	20.92	20.81	Pass
60	5300	20.82	20.70	20.71	20.81	Pass
64	5320	20.73	20.90	20.71	20.76	Pass
100	5500	20.74	20.89	20.91	20.72	Pass
116	5580	20.74	20.99	20.94	20.83	Pass
132	5660	20.71	21.13	20.79	20.82	Pass
140	5700	20.71	20.61	20.83	21.00	Pass

802.11ac (40MHz)

Channel	Channel Frequency (MHz)	26dBc Bandwidth (MHz)				Pass/Fail
		Chain 0	Chain 1	Chain 2	Chain 3	
54	5270	40.11	40.07	40.18	40.15	Pass
62	5310	40.04	40.16	39.84	40.06	Pass
102	5510	39.93	40.36	40.10	40.00	Pass
110	5550	39.88	39.91	40.08	40.00	Pass
134	5670	40.03	39.95	40.15	39.95	Pass

802.11ac (80MHz)

Channel	Channel Frequency (MHz)	26dBc Bandwidth (MHz)				Pass/Fail
		Chain 0	Chain 1	Chain 2	Chain 3	
58	5290	83.48	84.44	83.85	83.45	Pass
106	5530	83.77	83.86	83.52	84.00	Pass
122	5610	84.08	83.44	83.48	83.44	Pass

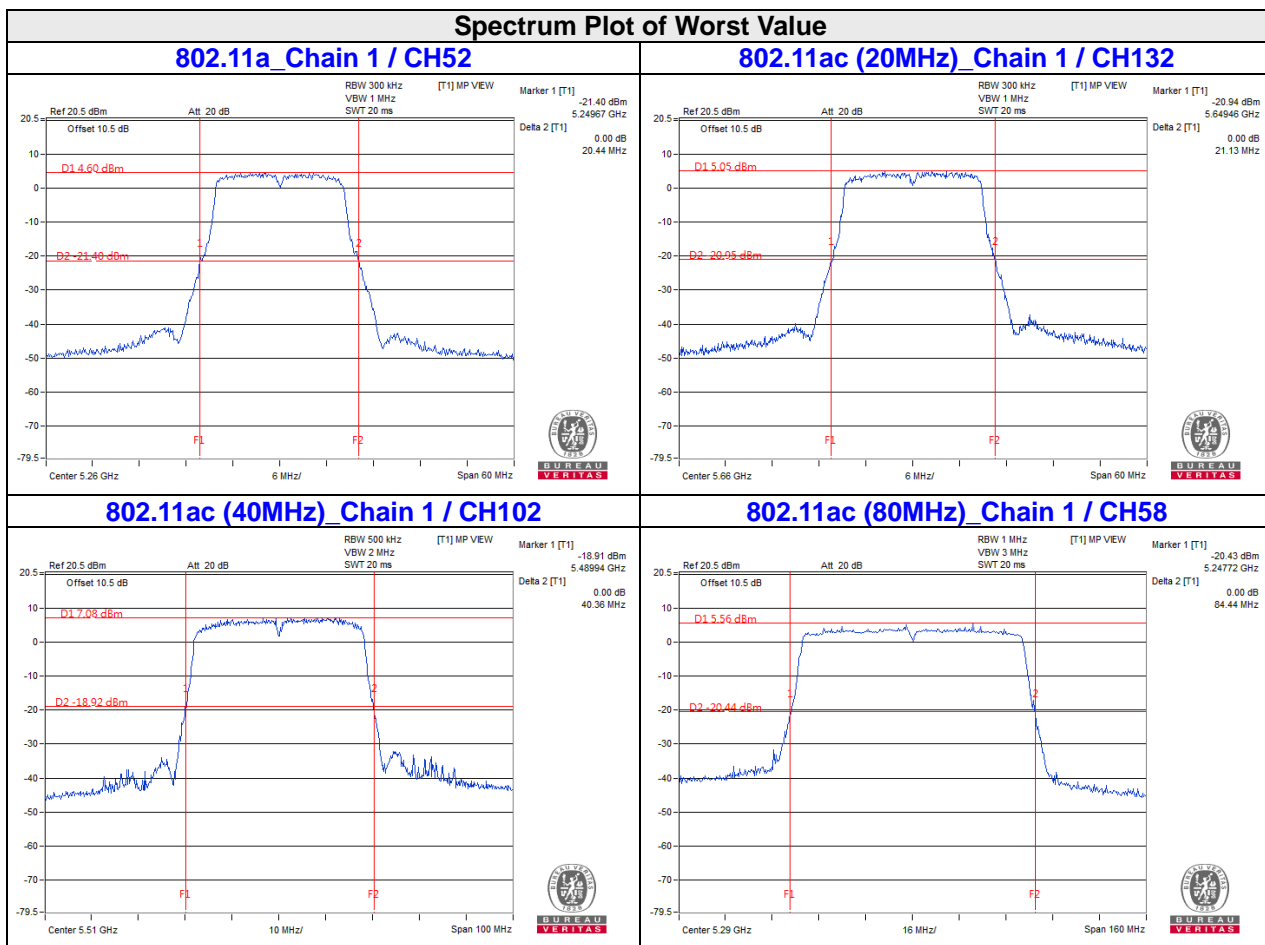

EUT MAXIMUM CONDUCTED POWER

802.11a

FREQUENCY BAND (MHz)	MAX. POWER	
	OUTPUT POWER (mW)	OUTPUT POWER (dBm)
5250~5350	68.531	18.36
5470~5725	85.053	19.30

NOTE: Manufacturer provides Transmit Power Control description to meet this requirement.

802.11ac (20MHz)

FREQUENCY BAND (MHz)	MAX. POWER	
	OUTPUT POWER (mW)	OUTPUT POWER (dBm)
5250~5350	69.004	18.39
5470~5725	93.847	19.72

NOTE: Manufacturer provides Transmit Power Control description to meet this requirement.

802.11ac (40MHz)

FREQUENCY BAND (MHz)	MAX. POWER	
	OUTPUT POWER (mW)	OUTPUT POWER (dBm)
5250~5350	68.834	18.38
5470~5725	167.02	22.23

NOTE: Manufacturer provides Transmit Power Control description to meet this requirement.

802.11ac (80MHz)

FREQUENCY BAND (MHz)	MAX. POWER	
	OUTPUT POWER (mW)	OUTPUT POWER (dBm)
5250~5350	68.672	18.37
5470~5725	214.089	23.31

NOTE: Manufacturer provides Transmit Power Control description to meet this requirement.

CDD Mode (Mode B)

Power Output:

802.11a

Chan.	Chan. Freq. (MHz)	Maximum Conducted Power (dBm)				Total Power (mW)	Total Power (dBm)	Power Limit (dBm)	Pass/Fail
		Chain 0	Chain 1	Chain 2	Chain 3				
52	5260	10.29	10.63	10.72	11.71	48.88	16.89	24.00	PASS
60	5300	10.21	10.44	10.68	11.92	48.816	16.89	24.00	PASS
64	5320	10.24	10.44	10.65	11.75	48.21	16.83	23.98	PASS
100	5500	11.78	12.67	11.28	11.25	60.322	17.80	23.99	PASS
116	5580	12.04	11.71	11.89	11.34	59.888	17.77	23.97	PASS
132	5660	12.08	11.78	11.87	11.36	60.269	17.80	23.99	PASS
140	5700	12.09	11.63	11.88	11.52	60.344	17.81	23.99	PASS

NOTE:

Chain 0:

1. $11\text{dBm} + 10\log (20.18) = 24.05 > 24\text{dBm}$
2. $11\text{dBm} + 10\log (19.97) = 24.00 > 24\text{dBm}$
3. $11\text{dBm} + 10\log (19.99) = 24.01 > 24\text{dBm}$
4. $11\text{dBm} + 10\log (19.99) = 24.01 > 24\text{dBm}$
5. $11\text{dBm} + 10\log (20.14) = 24.04 > 24\text{dBm}$
6. $11\text{dBm} + 10\log (19.92) = 23.99 < 24\text{dBm}$
7. $11\text{dBm} + 10\log (19.92) = 23.99 < 24\text{dBm}$

Chain 2:

1. $11\text{dBm} + 10\log (20.18) = 24.05 > 24\text{dBm}$
2. $11\text{dBm} + 10\log (20.06) = 24.02 > 24\text{dBm}$
3. $11\text{dBm} + 10\log (19.97) = 24.00 > 24\text{dBm}$
4. $11\text{dBm} + 10\log (20.25) = 24.06 > 24\text{dBm}$
5. $11\text{dBm} + 10\log (19.80) = 23.97 < 24\text{dBm}$
6. $11\text{dBm} + 10\log (20.06) = 24.02 > 24\text{dBm}$
7. $11\text{dBm} + 10\log (20.12) = 24.04 > 24\text{dBm}$

Chain 1:

1. $11\text{dBm} + 10\log (19.96) = 24.00 > 24\text{dBm}$
2. $11\text{dBm} + 10\log (20.12) = 24.04 > 24\text{dBm}$
3. $11\text{dBm} + 10\log (19.87) = 23.98 < 24\text{dBm}$
4. $11\text{dBm} + 10\log (19.98) = 24.01 > 24\text{dBm}$
5. $11\text{dBm} + 10\log (20.26) = 24.07 > 24\text{dBm}$
6. $11\text{dBm} + 10\log (20.03) = 24.02 > 24\text{dBm}$
7. $11\text{dBm} + 10\log (20.07) = 24.03 > 24\text{dBm}$

Chain 3:

1. $11\text{dBm} + 10\log (20.09) = 24.03 > 24\text{dBm}$
2. $11\text{dBm} + 10\log (20.12) = 24.04 > 24\text{dBm}$
3. $11\text{dBm} + 10\log (20.23) = 24.06 > 24\text{dBm}$
4. $11\text{dBm} + 10\log (19.91) = 23.99 < 24\text{dBm}$
5. $11\text{dBm} + 10\log (20.41) = 24.10 > 24\text{dBm}$
6. $11\text{dBm} + 10\log (20.01) = 24.01 > 24\text{dBm}$
7. $11\text{dBm} + 10\log (20.07) = 24.03 > 24\text{dBm}$

802.11ac (20MHz)

Chan.	Chan. Freq. (MHz)	Maximum Conducted Power (dBm)				Total Power (mW)	Total Power (dBm)	Power Limit (dBm)	Pass/Fail
		Chain 0	Chain 1	Chain 2	Chain 3				
52	5260	10.22	10.46	10.69	11.71	48.184	16.83	24.00	PASS
60	5300	10.75	10.61	10.55	11.48	48.803	16.88	24.00	PASS
64	5320	10.78	10.29	10.76	11.52	48.761	16.88	24.00	PASS
100	5500	12.20	11.63	12.14	12.36	64.738	18.11	24.00	PASS
116	5580	12.24	11.98	12.33	11.87	65.007	18.13	24.00	PASS
132	5660	12.48	11.74	12.21	12.19	65.821	18.18	24.00	PASS
140	5700	12.27	11.84	12.22	12.27	65.68	18.17	24.00	PASS

NOTE:

Chain 0:

1. 11dBm + 10log (20.59) = 24.14 > 24dBm
2. 11dBm + 10log (21.06) = 24.23 > 24dBm
3. 11dBm + 10log (20.78) = 24.18 > 24dBm
4. 11dBm + 10log (20.84) = 24.19 > 24dBm
5. 11dBm + 10log (20.67) = 24.15 > 24dBm
6. 11dBm + 10log (20.81) = 24.18 > 24dBm
7. 11dBm + 10log (20.73) = 24.17 > 24dBm

Chain 2:

1. 11dBm + 10log (20.79) = 24.18 > 24dBm
2. 11dBm + 10log (20.70) = 24.16 > 24dBm
3. 11dBm + 10log (20.99) = 24.22 > 24dBm
4. 11dBm + 10log (20.90) = 24.20 > 24dBm
5. 11dBm + 10log (20.95) = 24.21 > 24dBm
6. 11dBm + 10log (20.77) = 24.17 > 24dBm
7. 11dBm + 10log (20.86) = 24.19 > 24dBm

Chain 1:

1. 11dBm + 10log (20.97) = 24.22 > 24dBm
2. 11dBm + 10log (20.74) = 24.17 > 24dBm
3. 11dBm + 10log (20.89) = 24.20 > 24dBm
4. 11dBm + 10log (20.84) = 24.19 > 24dBm
5. 11dBm + 10log (21.11) = 24.24 > 24dBm
6. 11dBm + 10log (20.91) = 24.20 > 24dBm
7. 11dBm + 10log (20.94) = 24.21 > 24dBm

Chain 3:

1. 11dBm + 10log (20.94) = 24.21 > 24dBm
2. 11dBm + 10log (20.85) = 24.19 > 24dBm
3. 11dBm + 10log (20.85) = 24.19 > 24dBm
4. 11dBm + 10log (20.95) = 24.21 > 24dBm
5. 11dBm + 10log (20.60) = 24.14 > 24dBm
6. 11dBm + 10log (20.83) = 24.19 > 24dBm
7. 11dBm + 10log (20.87) = 24.20 > 24dBm

802.11ac (40MHz)

Chan.	Chan. Freq. (MHz)	Maximum Conducted Power (dBm)				Total Power (mW)	Total Power (dBm)	Power Limit (dBm)	Pass/Fail
		Chain 0	Chain 1	Chain 2	Chain 3				
54	5270	10.27	10.61	10.92	11.50	48.633	16.87	24.00	PASS
62	5310	10.39	10.54	10.88	11.45	48.474	16.86	24.00	PASS
102	5510	14.59	14.71	14.93	14.49	117.59	20.70	24.00	PASS
110	5550	15.02	14.81	14.76	14.12	117.784	20.71	24.00	PASS
134	5670	14.88	13.88	14.85	15.03	117.586	20.70	24.00	PASS

NOTE:

Chain 0:

1. $11\text{dBm} + 10\log (39.98) = 27.02 > 24\text{dBm}$
2. $11\text{dBm} + 10\log (40.10) = 27.03 > 24\text{dBm}$
3. $11\text{dBm} + 10\log (40.25) = 27.05 > 24\text{dBm}$
4. $11\text{dBm} + 10\log (40.12) = 27.03 > 24\text{dBm}$
5. $11\text{dBm} + 10\log (40.35) = 27.06 > 24\text{dBm}$

Chain 2:

1. $11\text{dBm} + 10\log (40.40) = 27.06 > 24\text{dBm}$
2. $11\text{dBm} + 10\log (40.04) = 27.02 > 24\text{dBm}$
3. $11\text{dBm} + 10\log (39.91) = 27.01 > 24\text{dBm}$
4. $11\text{dBm} + 10\log (40.18) = 27.04 > 24\text{dBm}$
5. $11\text{dBm} + 10\log (40.21) = 27.04 > 24\text{dBm}$

Chain 1:

1. $11\text{dBm} + 10\log (40.12) = 27.03 > 24\text{dBm}$
2. $11\text{dBm} + 10\log (40.15) = 27.04 > 24\text{dBm}$
3. $11\text{dBm} + 10\log (40.04) = 27.02 > 24\text{dBm}$
4. $11\text{dBm} + 10\log (40.09) = 27.03 > 24\text{dBm}$
5. $11\text{dBm} + 10\log (39.98) = 27.02 > 24\text{dBm}$

Chain 3:

1. $11\text{dBm} + 10\log (40.11) = 27.03 > 24\text{dBm}$
2. $11\text{dBm} + 10\log (40.07) = 27.03 > 24\text{dBm}$
3. $11\text{dBm} + 10\log (39.90) = 27.01 > 24\text{dBm}$
4. $11\text{dBm} + 10\log (39.93) = 27.01 > 24\text{dBm}$
5. $11\text{dBm} + 10\log (40.24) = 27.05 > 24\text{dBm}$

802.11ac (80MHz)

Chan.	Chan. Freq. (MHz)	Maximum Conducted Power (dBm)				Total Power (mW)	Total Power (dBm)	Power Limit (dBm)	Pass/Fail
		Chain 0	Chain 1	Chain 2	Chain 3				
58	5290	10.48	10.36	10.84	11.58	48.555	16.86	24.00	PASS
106	5530	16.75	16.28	16.10	16.04	170.694	22.32	24.00	PASS
122	5610	16.72	16.22	16.07	16.12	170.252	22.31	24.00	PASS

NOTE:

Chain 0:

1. $11\text{dBm} + 10\log (83.74) = 30.23 > 24\text{dBm}$
2. $11\text{dBm} + 10\log (83.66) = 30.23 > 24\text{dBm}$
3. $11\text{dBm} + 10\log (83.66) = 30.23 > 24\text{dBm}$

Chain 2:

1. $11\text{dBm} + 10\log (83.54) = 30.22 > 24\text{dBm}$
2. $11\text{dBm} + 10\log (84.47) = 30.27 > 24\text{dBm}$
3. $11\text{dBm} + 10\log (83.67) = 30.23 > 24\text{dBm}$

Chain 1:

1. $11\text{dBm} + 10\log (84.05) = 30.25 > 24\text{dBm}$
2. $11\text{dBm} + 10\log (84.02) = 30.24 > 24\text{dBm}$
3. $11\text{dBm} + 10\log (83.53) = 30.22 > 24\text{dBm}$

Chain 3:

1. $11\text{dBm} + 10\log (83.80) = 30.23 > 24\text{dBm}$
2. $11\text{dBm} + 10\log (83.55) = 30.22 > 24\text{dBm}$
3. $11\text{dBm} + 10\log (83.35) = 30.21 > 24\text{dBm}$

26dB BANDWIDTH:

802.11a

Channel	Channel Frequency (MHz)	26dBc Bandwidth (MHz)				Pass/Fail
		Chain 0	Chain 1	Chain 2	Chain 3	
52	5260	20.18	19.96	20.18	20.09	Pass
60	5300	19.97	20.12	20.06	20.12	Pass
64	5320	19.99	19.87	19.97	20.23	Pass
100	5500	19.99	19.98	20.25	19.91	Pass
116	5580	20.14	20.26	19.80	20.41	Pass
132	5660	19.92	20.03	20.06	20.01	Pass
140	5700	19.92	20.07	20.12	20.07	Pass

802.11ac (20MHz)

Channel	Channel Frequency (MHz)	26dBc Bandwidth (MHz)				Pass/Fail
		Chain 0	Chain 1	Chain 2	Chain 3	
52	5260	20.59	20.97	20.79	20.94	Pass
60	5300	21.06	20.74	20.70	20.85	Pass
64	5320	20.78	20.89	20.99	20.85	Pass
100	5500	20.84	20.84	20.90	20.95	Pass
116	5580	20.67	21.11	20.95	20.60	Pass
132	5660	20.81	20.91	20.77	20.83	Pass
140	5700	20.73	20.94	20.86	20.87	Pass

802.11ac (40MHz)

Channel	Channel Frequency (MHz)	26dBc Bandwidth (MHz)				Pass/Fail
		Chain 0	Chain 1	Chain 2	Chain 3	
54	5270	39.98	40.12	40.40	40.11	Pass
62	5310	40.10	40.15	40.04	40.07	Pass
102	5510	40.25	40.04	39.91	39.90	Pass
110	5550	40.12	40.09	40.18	39.93	Pass
134	5670	40.35	39.98	40.21	40.24	Pass

802.11ac (80MHz)

Channel	Channel Frequency (MHz)	26dBc Bandwidth (MHz)				Pass/Fail
		Chain 0	Chain 1	Chain 2	Chain 3	
58	5290	83.74	84.05	83.54	83.80	Pass
106	5530	83.66	84.02	84.47	83.55	Pass
122	5610	83.66	83.53	83.67	83.35	Pass

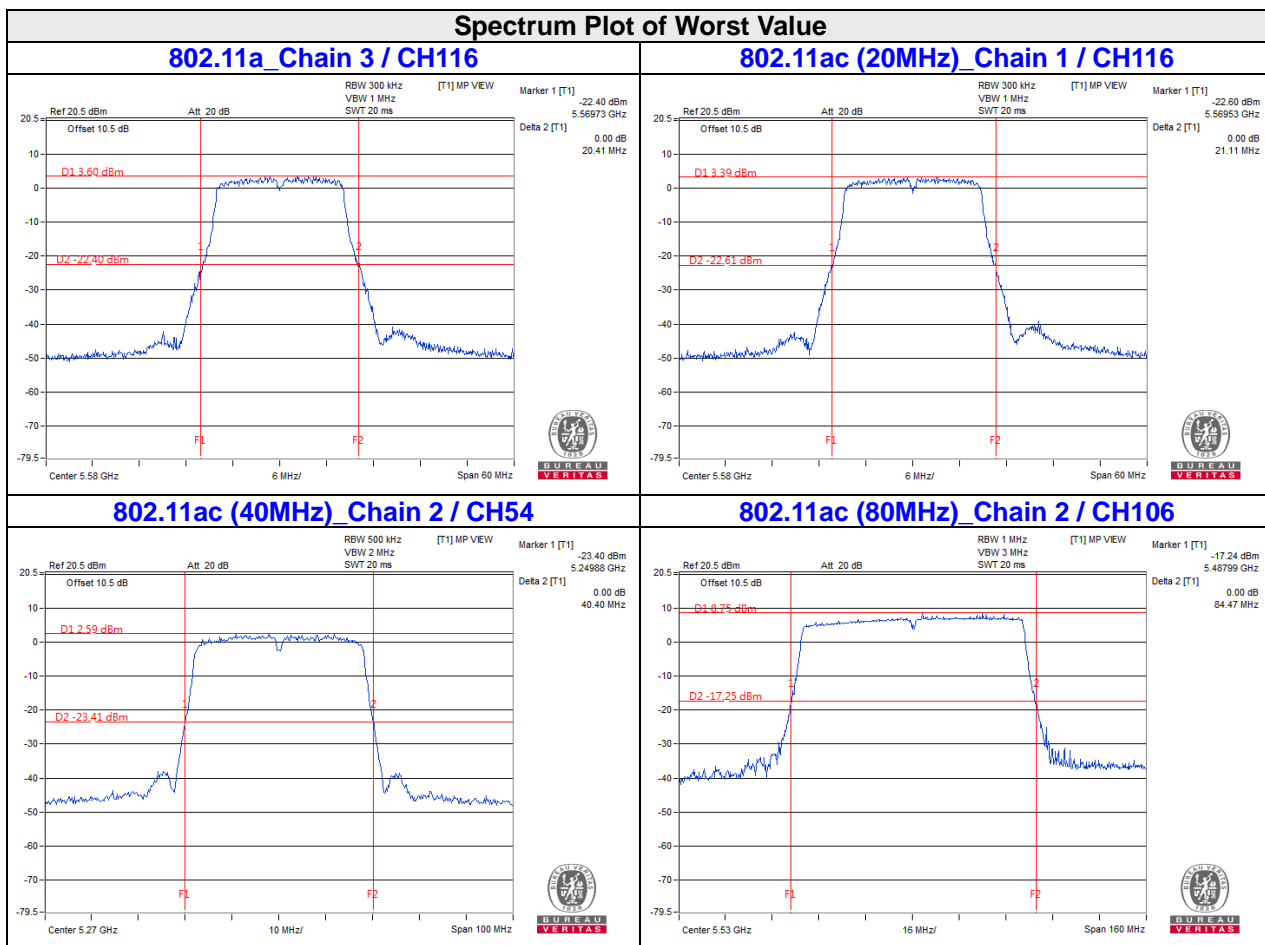

EUT MAXIMUM CONDUCTED POWER

802.11a

FREQUENCY BAND (MHz)	MAX. POWER	
	OUTPUT POWER (mW)	OUTPUT POWER (dBm)
5250~5350	48.88	16.89
5470~5725	60.344	17.81

NOTE: Manufacturer provides Transmit Power Control description to meet this requirement.

802.11ac (20MHz)

FREQUENCY BAND (MHz)	MAX. POWER	
	OUTPUT POWER (mW)	OUTPUT POWER (dBm)
5250~5350	48.803	16.88
5470~5725	65.821	18.18

NOTE: Manufacturer provides Transmit Power Control description to meet this requirement.

802.11ac (40MHz)

FREQUENCY BAND (MHz)	MAX. POWER	
	OUTPUT POWER (mW)	OUTPUT POWER (dBm)
5250~5350	48.633	16.87
5470~5725	117.784	20.71

NOTE: Manufacturer provides Transmit Power Control description to meet this requirement.

802.11ac (80MHz)

FREQUENCY BAND (MHz)	MAX. POWER	
	OUTPUT POWER (mW)	OUTPUT POWER (dBm)
5250~5350	48.555	16.86
5470~5725	170.694	22.32

NOTE: Manufacturer provides Transmit Power Control description to meet this requirement.

Beamforming_NSS1 Mode (Mode A)

Power Output:

802.11ac (20MHz)

Chan.	Chan. Freq. (MHz)	Maximum Conducted Power (dBm)				Total Power (mW)	Total Power (dBm)	Power Limit (dBm)	Pass/Fail
		Chain 0	Chain 1	Chain 2	Chain 3				
52	5260	5.67	5.92	6.12	7.16	16.891	12.28	19.51	PASS
60	5300	6.20	6.07	5.98	6.96	17.144	12.34	19.51	PASS
64	5320	6.19	5.74	6.22	6.95	17.052	12.32	19.51	PASS
100	5500	13.19	13.57	13.14	12.88	83.611	19.22	19.51	PASS
116	5580	13.22	12.96	13.36	13.19	83.281	19.21	19.51	PASS
132	5660	13.53	12.78	13.22	13.33	84.026	19.24	19.51	PASS
140	5700	13.29	12.92	13.51	13.04	83.494	19.22	19.51	PASS

NOTE: Directional gain = $10 \log[(10^{G1/20} + 10^{G2/20} + \dots + 10^{GN/20})^2 / 4]$ = 10.49dBi > 6dBi, so the Power limit shall be reduced to $24 - (10.49 - 6) = 19.51\text{dBm}$

Chain 0:

1. 11dBm + 10log (20.98) = 24.22 > 19.51dBm
2. 11dBm + 10log (20.82) = 24.18 > 19.51dBm
3. 11dBm + 10log (20.73) = 24.17 > 19.51dBm
4. 11dBm + 10log (20.74) = 24.17 > 19.51dBm
5. 11dBm + 10log (20.74) = 24.17 > 19.51dBm
6. 11dBm + 10log (20.71) = 24.16 > 19.51dBm
7. 11dBm + 10log (20.71) = 24.16 > 19.51dBm

Chain 1:

1. 11dBm + 10log (20.71) = 24.16 > 19.51dBm
2. 11dBm + 10log (20.70) = 24.16 > 19.51dBm
3. 11dBm + 10log (20.90) = 24.20 > 19.51dBm
4. 11dBm + 10log (20.89) = 24.20 > 19.51dBm
5. 11dBm + 10log (20.99) = 24.22 > 19.51dBm
6. 11dBm + 10log (21.13) = 24.25 > 19.51dBm
7. 11dBm + 10log (20.61) = 24.14 > 19.51dBm

Chain 2:

1. 11dBm + 10log (20.92) = 24.21 > 19.51dBm
2. 11dBm + 10log (20.71) = 24.16 > 19.51dBm
3. 11dBm + 10log (20.71) = 24.16 > 19.51dBm
4. 11dBm + 10log (20.91) = 24.20 > 19.51dBm
5. 11dBm + 10log (20.94) = 24.21 > 19.51dBm
6. 11dBm + 10log (20.79) = 24.18 > 19.51dBm
7. 11dBm + 10log (20.83) = 24.19 > 19.51dBm

Chain 3:

1. 11dBm + 10log (20.81) = 24.18 > 19.51dBm
2. 11dBm + 10log (20.81) = 24.18 > 19.51dBm
3. 11dBm + 10log (20.76) = 24.17 > 19.51dBm
4. 11dBm + 10log (20.72) = 24.16 > 19.51dBm
5. 11dBm + 10log (20.83) = 24.19 > 19.51dBm
6. 11dBm + 10log (20.82) = 24.18 > 19.51dBm
7. 11dBm + 10log (21.00) = 24.22 > 19.51dBm

802.11ac (40MHz)

Chan.	Chan. Freq. (MHz)	Maximum Conducted Power (dBm)				Total Power (mW)	Total Power (dBm)	Power Limit (dBm)	Pass/Fail
		Chain 0	Chain 1	Chain 2	Chain 3				
54	5270	5.71	6.05	6.41	6.96	17.092	12.33	19.51	PASS
62	5310	5.82	5.95	6.32	6.90	16.938	12.29	19.51	PASS
102	5510	13.02	13.09	13.41	13.08	82.667	19.17	19.51	PASS
110	5550	13.51	13.31	13.26	12.62	83.333	19.21	19.51	PASS
134	5670	13.47	12.36	13.35	13.49	83.415	19.21	19.51	PASS

NOTE: Directional gain = $10 \log[(10^{G1/20} + 10^{G2/20} + \dots + 10^{GN/20})^2 / 4] = 10.49\text{dBi} > 6\text{dBi}$, so the Power limit shall be reduced to $24 - (10.49 - 6) = 19.51\text{dBm}$

Chain 0:

1. $11\text{dBm} + 10\log(40.11) = 27.03 > 19.51\text{dBm}$
2. $11\text{dBm} + 10\log(40.04) = 27.02 > 19.51\text{dBm}$
3. $11\text{dBm} + 10\log(39.93) = 27.01 > 19.51\text{dBm}$
4. $11\text{dBm} + 10\log(39.88) = 27.01 > 19.51\text{dBm}$
5. $11\text{dBm} + 10\log(40.03) = 27.02 > 19.51\text{dBm}$

Chain 1:

1. $11\text{dBm} + 10\log(40.07) = 27.03 > 19.51\text{dBm}$
2. $11\text{dBm} + 10\log(40.16) = 27.04 > 19.51\text{dBm}$
3. $11\text{dBm} + 10\log(40.36) = 27.06 > 19.51\text{dBm}$
4. $11\text{dBm} + 10\log(39.91) = 27.01 > 19.51\text{dBm}$
5. $11\text{dBm} + 10\log(39.95) = 27.02 > 19.51\text{dBm}$

Chain 2:

1. $11\text{dBm} + 10\log(40.18) = 27.04 > 19.51\text{dBm}$
2. $11\text{dBm} + 10\log(39.84) = 27.00 > 19.51\text{dBm}$
3. $11\text{dBm} + 10\log(40.10) = 27.03 > 19.51\text{dBm}$
4. $11\text{dBm} + 10\log(40.08) = 27.03 > 19.51\text{dBm}$
5. $11\text{dBm} + 10\log(40.15) = 27.04 > 19.51\text{dBm}$

Chain 3:

1. $11\text{dBm} + 10\log(40.15) = 27.04 > 19.51\text{dBm}$
2. $11\text{dBm} + 10\log(40.06) = 27.03 > 19.51\text{dBm}$
3. $11\text{dBm} + 10\log(40.00) = 27.02 > 19.51\text{dBm}$
4. $11\text{dBm} + 10\log(40.00) = 27.02 > 19.51\text{dBm}$
5. $11\text{dBm} + 10\log(39.95) = 27.02 > 19.51\text{dBm}$

802.11ac (80MHz)

Chan.	Chan. Freq. (MHz)	Maximum Conducted Power (dBm)				Total Power (mW)	Total Power (dBm)	Power Limit (dBm)	Pass/Fail
		Chain 0	Chain 1	Chain 2	Chain 3				
58	5290	5.95	5.81	6.30	7.05	17.083	12.33	19.51	PASS
106	5530	12.74	13.65	13.37	12.56	81.724	19.12	19.51	PASS
122	5610	13.22	12.52	12.56	12.68	75.419	18.77	19.51	PASS

NOTE: Directional gain = $10 \log[(10^{G1/20} + 10^{G2/20} + \dots + 10^{GN/20})^2 / 4] = 10.49\text{dBi} > 6\text{dBi}$, so the Power limit shall be reduced to $24 - (10.49 - 6) = 19.51\text{dBm}$

Chain 0:

1. $11\text{dBm} + 10\log(83.48) = 30.22 > 19.51\text{dBm}$
2. $11\text{dBm} + 10\log(83.77) = 30.23 > 19.51\text{dBm}$
3. $11\text{dBm} + 10\log(84.08) = 30.25 > 19.51\text{dBm}$

Chain 1:

1. $11\text{dBm} + 10\log(84.44) = 30.27 > 19.51\text{dBm}$
2. $11\text{dBm} + 10\log(83.86) = 30.24 > 19.51\text{dBm}$
3. $11\text{dBm} + 10\log(83.44) = 30.21 > 19.51\text{dBm}$

Chain 2:

1. $11\text{dBm} + 10\log(83.85) = 30.24 > 19.51\text{dBm}$
2. $11\text{dBm} + 10\log(83.52) = 30.22 > 19.51\text{dBm}$
3. $11\text{dBm} + 10\log(83.48) = 30.22 > 19.51\text{dBm}$

Chain 3:

1. $11\text{dBm} + 10\log(83.45) = 30.21 > 19.51\text{dBm}$
2. $11\text{dBm} + 10\log(84.00) = 30.24 > 19.51\text{dBm}$
3. $11\text{dBm} + 10\log(83.44) = 30.21 > 19.51\text{dBm}$

Beamforming_NSS1 Mode (Mode B)

Power Output:

802.11ac (20MHz)

Chan.	Chan. Freq. (MHz)	Maximum Conducted Power (dBm)				Total Power (mW)	Total Power (dBm)	Power Limit (dBm)	Pass/Fail
		Chain 0	Chain 1	Chain 2	Chain 3				
52	5260	4.18	4.45	4.65	5.65	11.994	10.79	17.98	PASS
60	5300	4.71	4.59	4.51	5.43	12.151	10.85	17.98	PASS
64	5320	4.74	4.26	4.72	5.48	12.143	10.84	17.98	PASS
100	5500	11.71	11.13	11.62	11.88	57.735	17.61	17.98	PASS
116	5580	11.73	11.46	11.81	11.37	57.77	17.62	17.98	PASS
132	5660	11.82	11.25	11.72	11.68	58.122	17.64	17.98	PASS
140	5700	11.77	11.36	11.74	11.65	58.258	17.65	17.98	PASS

NOTE: Directional gain = $10 \log[(10^{G1/20} + 10^{G2/20} + \dots + 10^{GN/20})^2 / 4] = 12.02\text{dBi} > 6\text{dBi}$, so the Power limit shall be reduced to $24 - (12.02 - 6) = 17.98\text{dBm}$

Chain 0:

1. $11\text{dBm} + 10\log (20.59) = 24.14 > 17.98\text{dBm}$
2. $11\text{dBm} + 10\log (21.06) = 24.23 > 17.98\text{dBm}$
3. $11\text{dBm} + 10\log (20.78) = 24.18 > 17.98\text{dBm}$
4. $11\text{dBm} + 10\log (20.84) = 24.19 > 17.98\text{dBm}$
5. $11\text{dBm} + 10\log (20.67) = 24.15 > 17.98\text{dBm}$
6. $11\text{dBm} + 10\log (20.81) = 24.18 > 17.98\text{dBm}$
7. $11\text{dBm} + 10\log (20.73) = 24.17 > 17.98\text{dBm}$

Chain 2:

1. $11\text{dBm} + 10\log (20.79) = 24.18 > 17.98\text{dBm}$
2. $11\text{dBm} + 10\log (20.70) = 24.16 > 17.98\text{dBm}$
3. $11\text{dBm} + 10\log (20.99) = 24.22 > 17.98\text{dBm}$
4. $11\text{dBm} + 10\log (20.90) = 24.20 > 17.98\text{dBm}$
5. $11\text{dBm} + 10\log (20.95) = 24.21 > 17.98\text{dBm}$
6. $11\text{dBm} + 10\log (20.77) = 24.17 > 17.98\text{dBm}$
7. $11\text{dBm} + 10\log (20.86) = 24.19 > 17.98\text{dBm}$

Chain 1:

1. $11\text{dBm} + 10\log (20.97) = 24.22 > 17.98\text{dBm}$
2. $11\text{dBm} + 10\log (20.74) = 24.17 > 17.98\text{dBm}$
3. $11\text{dBm} + 10\log (20.89) = 24.20 > 17.98\text{dBm}$
4. $11\text{dBm} + 10\log (20.84) = 24.19 > 17.98\text{dBm}$
5. $11\text{dBm} + 10\log (21.11) = 24.24 > 17.98\text{dBm}$
6. $11\text{dBm} + 10\log (20.91) = 24.20 > 17.98\text{dBm}$
7. $11\text{dBm} + 10\log (20.94) = 24.21 > 17.98\text{dBm}$

Chain 3:

1. $11\text{dBm} + 10\log (20.94) = 24.21 > 17.98\text{dBm}$
2. $11\text{dBm} + 10\log (20.85) = 24.19 > 17.98\text{dBm}$
3. $11\text{dBm} + 10\log (20.85) = 24.19 > 17.98\text{dBm}$
4. $11\text{dBm} + 10\log (20.95) = 24.21 > 17.98\text{dBm}$
5. $11\text{dBm} + 10\log (20.60) = 24.14 > 17.98\text{dBm}$
6. $11\text{dBm} + 10\log (20.83) = 24.19 > 17.98\text{dBm}$
7. $11\text{dBm} + 10\log (20.87) = 24.20 > 17.98\text{dBm}$

802.11ac (40MHz)

Chan.	Chan. Freq. (MHz)	Maximum Conducted Power (dBm)				Total Power (mW)	Total Power (dBm)	Power Limit (dBm)	Pass/Fail
		Chain 0	Chain 1	Chain 2	Chain 3				
54	5270	4.25	4.58	4.86	5.46	12.11	10.83	17.98	PASS
62	5310	4.38	4.54	4.82	5.42	12.103	10.83	17.98	PASS
102	5510	11.48	11.62	11.85	11.39	57.664	17.61	17.98	PASS
110	5550	11.94	11.69	11.67	11.03	57.754	17.62	17.98	PASS
134	5670	11.78	10.77	11.74	11.94	57.565	17.60	17.98	PASS

NOTE: Directional gain = $10 \log[(10^{G1/20} + 10^{G2/20} + \dots + 10^{GN/20})^2 / 4] = 12.02\text{dBi} > 6\text{dBi}$, so the Power limit shall be reduced to $24 - (12.02 - 6) = 17.98\text{dBm}$

Chain 0:

1. $11\text{dBm} + 10\log (39.98) = 27.02 > 17.98\text{dBm}$
2. $11\text{dBm} + 10\log (40.10) = 27.03 > 17.98\text{dBm}$
3. $11\text{dBm} + 10\log (40.25) = 27.05 > 17.98\text{dBm}$
4. $11\text{dBm} + 10\log (40.12) = 27.03 > 17.98\text{dBm}$
5. $11\text{dBm} + 10\log (40.35) = 27.06 > 17.98\text{dBm}$

Chain 1:

1. $11\text{dBm} + 10\log (40.12) = 27.03 > 17.98\text{dBm}$
2. $11\text{dBm} + 10\log (40.15) = 27.04 > 17.98\text{dBm}$
3. $11\text{dBm} + 10\log (40.04) = 27.02 > 17.98\text{dBm}$
4. $11\text{dBm} + 10\log (40.09) = 27.03 > 17.98\text{dBm}$
5. $11\text{dBm} + 10\log (39.98) = 27.02 > 17.98\text{dBm}$

Chain 2:

1. $11\text{dBm} + 10\log (40.40) = 27.06 > 17.98\text{dBm}$
2. $11\text{dBm} + 10\log (40.04) = 27.02 > 17.98\text{dBm}$
3. $11\text{dBm} + 10\log (39.91) = 27.01 > 17.98\text{dBm}$
4. $11\text{dBm} + 10\log (40.18) = 27.04 > 17.98\text{dBm}$
5. $11\text{dBm} + 10\log (40.21) = 27.04 > 17.98\text{dBm}$

Chain 3:

1. $11\text{dBm} + 10\log (40.11) = 27.03 > 17.98\text{dBm}$
2. $11\text{dBm} + 10\log (40.07) = 27.03 > 17.98\text{dBm}$
3. $11\text{dBm} + 10\log (39.90) = 27.01 > 17.98\text{dBm}$
4. $11\text{dBm} + 10\log (39.93) = 27.01 > 17.98\text{dBm}$
5. $11\text{dBm} + 10\log (40.24) = 27.05 > 17.98\text{dBm}$

802.11ac (80MHz)

Chan.	Chan. Freq. (MHz)	Maximum Conducted Power (dBm)				Total Power (mW)	Total Power (dBm)	Power Limit (dBm)	Pass/Fail
		Chain 0	Chain 1	Chain 2	Chain 3				
58	5290	4.42	4.37	4.77	5.49	12.041	10.81	17.98	PASS
106	5530	11.96	11.46	11.31	11.31	56.742	17.54	17.98	PASS
122	5610	11.94	11.45	11.24	11.29	56.359	17.51	17.98	PASS

NOTE: Directional gain = $10 \log[(10^{G1/20} + 10^{G2/20} + \dots + 10^{GN/20})^2 / 4] = 12.02\text{dBi} > 6\text{dBi}$, so the Power limit shall be reduced to $24 - (12.02 - 6) = 17.98\text{dBm}$

Chain 0:

1. $11\text{dBm} + 10\log (83.74) = 30.23 > 17.98\text{dBm}$
2. $11\text{dBm} + 10\log (83.66) = 30.23 > 17.98\text{dBm}$
3. $11\text{dBm} + 10\log (83.66) = 30.23 > 17.98\text{dBm}$

Chain 1:

1. $11\text{dBm} + 10\log (84.05) = 30.25 > 17.98\text{dBm}$
2. $11\text{dBm} + 10\log (84.02) = 30.24 > 17.98\text{dBm}$
3. $11\text{dBm} + 10\log (83.53) = 30.22 > 17.98\text{dBm}$

Chain 2:

1. $11\text{dBm} + 10\log (83.54) = 30.22 > 17.98\text{dBm}$
2. $11\text{dBm} + 10\log (84.47) = 30.27 > 17.98\text{dBm}$
3. $11\text{dBm} + 10\log (83.67) = 30.23 > 17.98\text{dBm}$

Chain 3:

1. $11\text{dBm} + 10\log (83.80) = 30.23 > 17.98\text{dBm}$
2. $11\text{dBm} + 10\log (83.55) = 30.22 > 17.98\text{dBm}$
3. $11\text{dBm} + 10\log (83.35) = 30.21 > 17.98\text{dBm}$

4.4 Occupied Bandwidth Measurement

4.4.1 Test Setup



4.4.2 Test Instruments

Refer to section 4.1.2 to get information of above instrument.

4.4.3 Test Procedure

The transmitter output was connected to the spectrum analyzer through an attenuator. The bandwidth of the fundamental frequency was measured by spectrum analyzer with resolution bandwidth in the range of 1% to 5% of the anticipated emission bandwidth, and a video bandwidth at least 3x the resolution bandwidth and set the detector to SAMPLE. The width of a frequency band such that, below the lower and above the upper frequency limits, the mean powers emitted are each equal to a specified percentage 0.5 %of the total mean power of a given emission.

4.4.4 Test Results

CDD Mode (Mode A)

802.11a

Channel	Channel Frequency (MHz)	Occupied Bandwidth (MHz)				Pass/Fail
		Chain 0	Chain 1	Chain 2	Chain 3	
52	5260	16.44	16.44	16.44	16.44	Pass
60	5300	16.44	16.44	16.44	16.44	Pass
64	5320	16.44	16.44	16.44	16.44	Pass
100	5500	16.52	16.52	16.52	16.52	Pass
116	5580	16.52	16.52	16.52	16.52	Pass
132	5660	16.52	16.52	16.52	16.52	Pass
140	5700	16.52	16.52	16.52	16.52	Pass

802.11ac (20MHz)

Channel	Channel Frequency (MHz)	Occupied Bandwidth (MHz)				Pass/Fail
		Chain 0	Chain 1	Chain 2	Chain 3	
52	5260	17.64	17.64	17.64	17.64	Pass
60	5300	17.64	17.64	17.64	17.64	Pass
64	5320	17.64	17.64	17.64	17.64	Pass
100	5500	17.56	17.56	17.65	17.65	Pass
116	5580	17.65	17.65	17.65	17.65	Pass
132	5660	17.65	17.65	17.65	17.73	Pass
140	5700	17.56	17.65	17.65	17.65	Pass

802.11ac (40MHz)

Channel	Channel Frequency (MHz)	Occupied Bandwidth (MHz)				Pass/Fail
		Chain 0	Chain 1	Chain 2	Chain 3	
54	5270	36.00	36.00	36.00	36.00	Pass
62	5310	36.00	36.00	36.00	36.00	Pass
102	5510	36.08	35.94	36.08	36.08	Pass
110	5550	36.08	35.94	35.94	36.08	Pass
134	5670	35.94	35.94	35.94	36.08	Pass

802.11ac (80MHz)

Channel	Channel Frequency (MHz)	Occupied Bandwidth (MHz)				Pass/Fail
		Chain 0	Chain 1	Chain 2	Chain 3	
58	5290	75.84	75.60	75.84	75.60	Pass
106	5530	75.82	75.82	75.82	75.82	Pass
122	5610	75.82	75.82	75.82	75.82	Pass

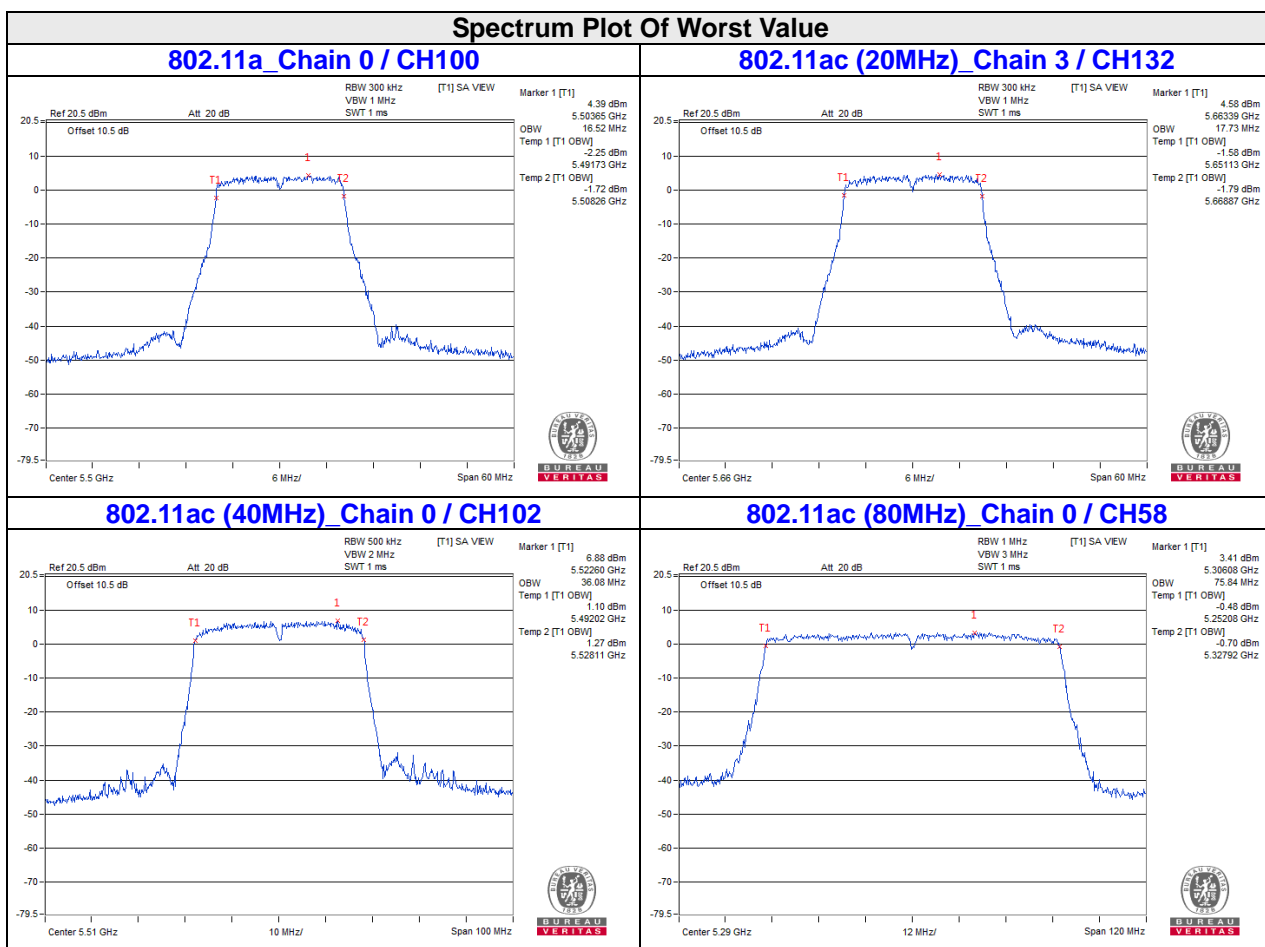

CDD Mode (Mode B)
802.11a

Channel	Channel Frequency (MHz)	Occupied Bandwidth (MHz)				Pass/Fail
		Chain 0	Chain 1	Chain 2	Chain 3	
52	5260	16.44	16.44	16.44	16.44	Pass
60	5300	16.44	16.44	16.44	16.44	Pass
64	5320	16.44	16.44	16.44	16.44	Pass
100	5500	16.52	16.52	16.52	16.52	Pass
116	5580	16.52	16.52	16.52	16.52	Pass
132	5660	16.52	16.52	16.52	16.52	Pass
140	5700	16.52	16.52	16.52	16.52	Pass

802.11ac (20MHz)

Channel	Channel Frequency (MHz)	Occupied Bandwidth (MHz)				Pass/Fail
		Chain 0	Chain 1	Chain 2	Chain 3	
52	5260	17.64	17.64	17.64	17.64	Pass
60	5300	17.64	17.64	17.64	17.64	Pass
64	5320	17.64	17.64	17.64	17.64	Pass
100	5500	17.73	17.65	17.65	17.65	Pass
116	5580	17.65	17.65	17.65	17.65	Pass
132	5660	17.65	17.65	17.73	17.73	Pass
140	5700	17.65	17.65	17.65	17.65	Pass

802.11ac (40MHz)

Channel	Channel Frequency (MHz)	Occupied Bandwidth (MHz)				Pass/Fail
		Chain 0	Chain 1	Chain 2	Chain 3	
54	5270	36.00	36.00	36.00	36.00	Pass
62	5310	36.00	36.00	36.00	36.00	Pass
102	5510	35.94	36.08	35.94	35.94	Pass
110	5550	35.94	35.94	36.08	35.94	Pass
134	5670	35.94	36.08	35.94	35.94	Pass

802.11ac (80MHz)

Channel	Channel Frequency (MHz)	Occupied Bandwidth (MHz)				Pass/Fail
		Chain 0	Chain 1	Chain 2	Chain 3	
58	5290	75.84	75.84	75.84	75.60	Pass
106	5530	75.82	75.82	75.82	75.82	Pass
122	5610	75.82	75.82	75.82	76.00	Pass

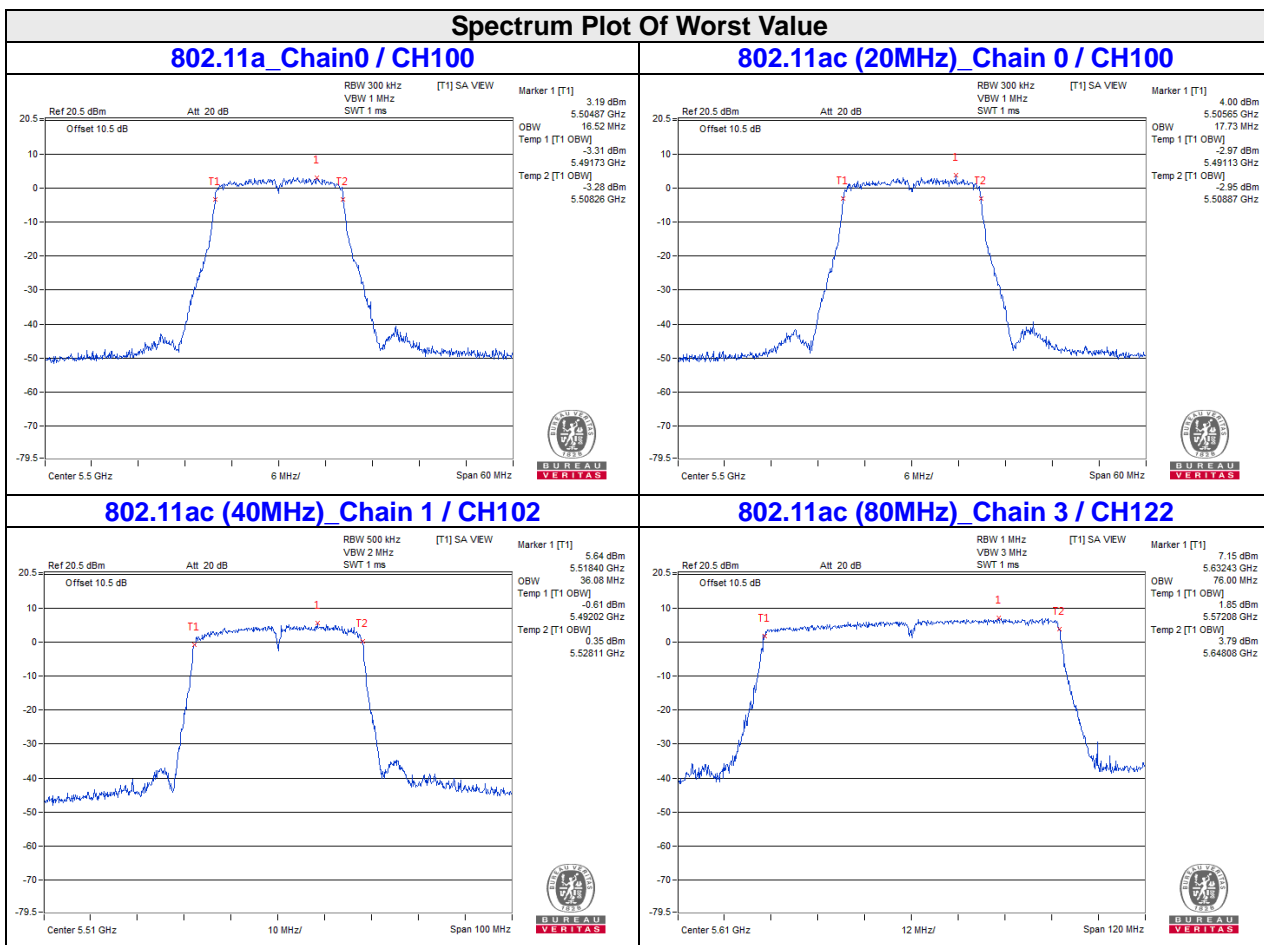

4.5 Peak Power Spectral Density Measurement

4.5.1 Limits of Peak Power Spectral Density Measurement

Operation Band	EUT Category		Limit
U-NII-1	---	Outdoor Access Point	17dBm/ MHz
	---	Fixed point-to-point Access Point	
	---	Indoor Access Point	
	---	Mobile and Portable client device	11dBm/ MHz
U-NII-2A	√		11dBm/ MHz
U-NII-2C	√		11dBm/ MHz
U-NII-3	---		30dBm/ 500kHz

4.5.2 Test Setup

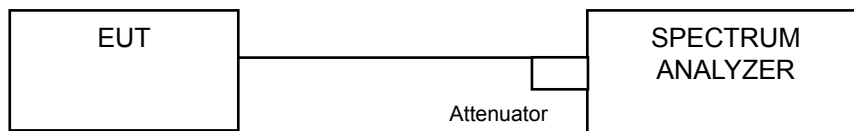

4.5.3 Test Instruments

Refer to section 4.1.2 to get information of above instrument.

4.5.4 Test Procedure

For U-NII-2A, U-NII-2C band:

Using method SA-1

- 1) Set span to encompass the entire emission bandwidth (EBW) of the signal.
- 2) Set RBW = 1 MHz, Set VBW ≥ 3 MHz, Detector = RMS
- 3) Sweep time = auto, trigger set to “free run”.
- 4) Trace average at least 100 traces in power averaging mode.
- 5) Record the max value

4.5.5 Deviation from Test Standard

No deviation.

4.5.6 EUT Operating Condition

Same as Item 4.3.6.

4.5.7 Test Results

CDD Mode (Mode A)

802.11a

Chan.	Chan. Freq. (MHz)	PSD (dBm/MHz)				Duty Factor	Total Power Density (dBm/MHz)	MAX. Limit (dBm/MHz)	Pass / Fail
		Chain 0	Chain 1	Chain 2	Chain 3				
52	5260	0.02	0.03	0.04	0.01	0.19	6.24	6.51	Pass
60	5300	0.06	0.08	0.02	0.03	0.19	6.26	6.51	Pass
64	5320	-0.16	-0.16	-0.20	-0.17	0.19	6.04	6.51	Pass
100	5500	0.00	-0.09	-0.09	-0.08	0.19	6.15	6.51	Pass
120	5600	-0.15	-0.13	-0.14	-0.12	0.19	6.08	6.51	Pass
132	5660	0.07	0.11	0.10	0.10	0.19	6.31	6.51	Pass
140	5700	-0.02	0.00	0.01	-0.04	0.19	6.20	6.51	Pass

- Note:**
- Method a) of power density measurement of KDB 662911 is using for calculating total power density. Total power density is summing entire spectra across corresponding frequency bins on the various outputs by computer.
 - Directional gain = $10 \log[(10^{G1/20} + 10^{G2/20} + \dots + 10^{GN/20})^2 / 4] = 10.49\text{dBi} > 6\text{dBi}$, so the PSD limit shall be reduced to $11 - (10.49 - 6) = 6.51\text{dBm}$
 - Refer to section 3.3 for duty cycle spectrum plot.

802.11ac (20MHz)

Chan.	Chan. Freq. (MHz)	PSD (dBm/MHz)				Total Power Density (dBm/MHz)	MAX. Limit (dBm/MHz)	Pass / Fail
		Chain 0	Chain 1	Chain 2	Chain 3			
52	5260	-0.49	-0.48	-0.52	-0.47	5.53	6.51	Pass
60	5300	-0.46	-0.45	-0.53	-0.51	5.53	6.51	Pass
64	5320	-0.73	-0.74	-0.75	-0.76	5.28	6.51	Pass
100	5500	-0.07	-0.06	-0.07	-0.06	5.96	6.51	Pass
120	5600	-0.08	-0.05	-0.03	-0.05	5.97	6.51	Pass
132	5660	0.13	0.13	0.13	0.13	6.15	6.51	Pass
140	5700	0.00	0.02	0.02	0.03	6.04	6.51	Pass

- Note:**
- Method a) of power density measurement of KDB 662911 is using for calculating total power density. Total power density is summing entire spectra across corresponding frequency bins on the various outputs by computer.
 - Directional gain = $10 \log[(10^{G1/20} + 10^{G2/20} + \dots + 10^{GN/20})^2 / 4] = 10.49\text{dBi} > 6\text{dBi}$, so the PSD limit shall be reduced to $11 - (10.49 - 6) = 6.51\text{dBm}$
 - Refer to section 3.3 for duty cycle spectrum plot.

802.11ac (40MHz)

Chan.	Chan. Freq. (MHz)	PSD (dBm/MHz)				Duty Factor	Total Power Density (dBm/MHz)	MAX. Limit (dBm/MHz)	Pass / Fail
		Chain 0	Chain 1	Chain 2	Chain 3				
54	5270	-3.02	-2.99	-3.11	-3.03	0.21	3.20	6.51	Pass
62	5310	-2.94	-3.07	-3.04	-3.07	0.21	3.20	6.51	Pass
102	5510	0.11	0.02	0.06	0.13	0.21	6.31	6.51	Pass
110	5550	-0.18	-0.12	-0.17	-0.15	0.21	6.08	6.51	Pass
134	5670	-0.15	-0.21	-0.17	-0.20	0.21	6.05	6.51	Pass

- Note:**
- Method a) of power density measurement of KDB 662911 is using for calculating total power density. Total power density is summing entire spectra across corresponding frequency bins on the various outputs by computer.
 - Directional gain = $10 \log[(10^{G1/20} + 10^{G2/20} + \dots + 10^{GN/20})^2 / 4] = 10.49\text{dBi} > 6\text{dBi}$, so the PSD limit shall be reduced to $11 - (10.49 - 6) = 6.51\text{dBm}$
 - Refer to section 3.3 for duty cycle spectrum plot.

802.11ac (80MHz)

Chan.	Chan. Freq. (MHz)	PSD (dBm/MHz)				Duty Factor	Total Power Density (dBm/MHz)	MAX. Limit (dBm/MHz)	Pass / Fail
		Chain 0	Chain 1	Chain 2	Chain 3				
58	5290	-6.26	-6.26	-6.27	-6.29	0.32	0.07	6.51	Pass
106	5530	-1.79	-1.82	-1.78	-1.86	0.32	4.52	6.51	Pass
122	5610	-2.17	-2.13	-2.13	-2.18	0.32	4.18	6.51	Pass

- Note:**
- Method a) of power density measurement of KDB 662911 is using for calculating total power density. Total power density is summing entire spectra across corresponding frequency bins on the various outputs by computer.
 - Directional gain = $10 \log[(10^{G1/20} + 10^{G2/20} + \dots + 10^{GN/20})^2 / 4] = 10.49\text{dBi} > 6\text{dBi}$, so the PSD limit shall be reduced to $11 - (10.49 - 6) = 6.51\text{dBm}$
 - Refer to section 3.3 for duty cycle spectrum plot.

Spectrum Plot of Worst Value

802.11a_Chain 1 / CH132

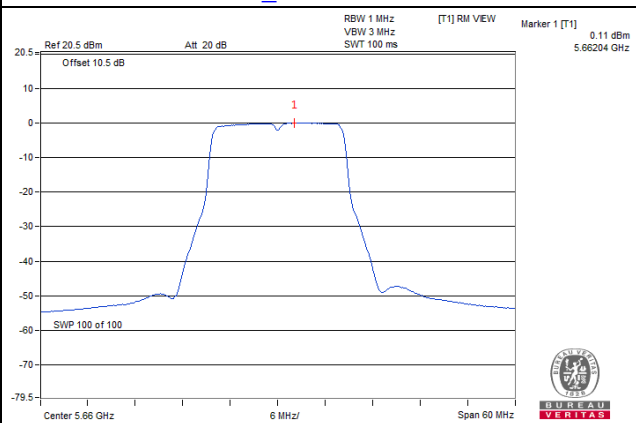

802.11ac (20MHz)_Chain 0 / CH132

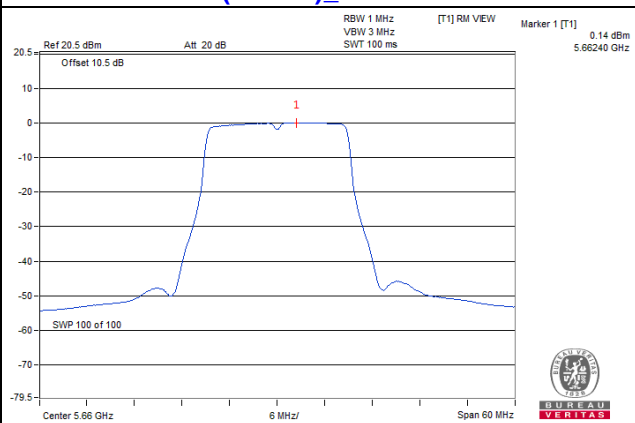

802.11ac (40MHz)_Chain 3 / CH102

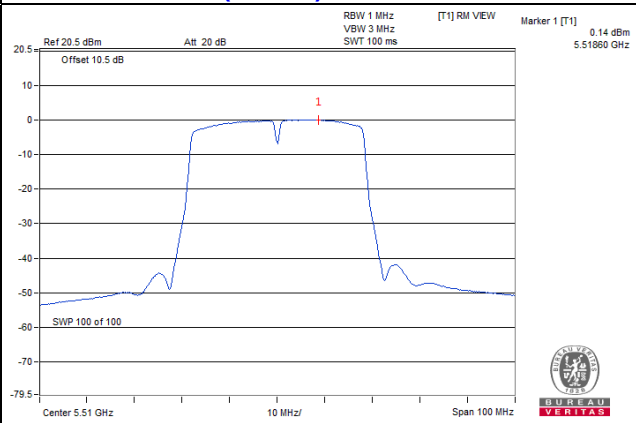

802.11ac (80MHz)_Chain 2 / CH106

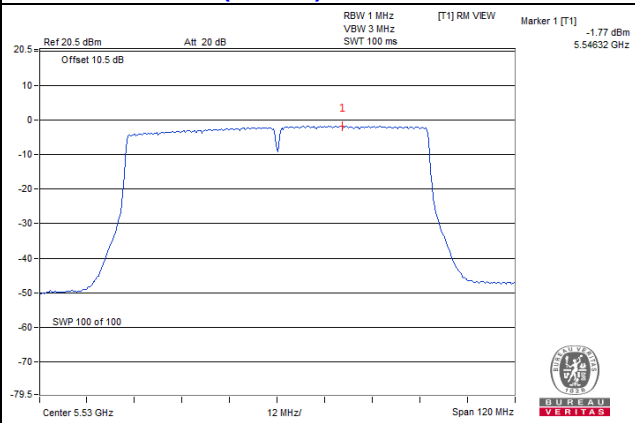

CDD Mode (Mode B)

802.11a

Chan.	Chan. Freq. (MHz)	PSD (dBm/MHz)				Duty Factor	Total Power Density (dBm/MHz)	MAX. Limit (dBm/MHz)	Pass / Fail
		Chain 0	Chain 1	Chain 2	Chain 3				
52	5260	-1.48	-1.51	-1.48	-1.49	0.19	4.72	4.98	Pass
60	5300	-1.42	-1.39	-1.38	-1.39	0.19	4.82	4.98	Pass
64	5320	-1.59	-1.59	-1.60	-1.59	0.19	4.62	4.98	Pass
100	5500	-1.47	-1.51	-1.45	-1.48	0.19	4.73	4.98	Pass
120	5600	-1.63	-1.66	-1.62	-1.63	0.19	4.58	4.98	Pass
132	5660	-1.41	-1.37	-1.40	-1.36	0.19	4.83	4.98	Pass
140	5700	-1.56	-1.56	-1.55	-1.57	0.19	4.65	4.98	Pass

- Note:**
- Method a) of power density measurement of KDB 662911 is using for calculating total power density. Total power density is summing entire spectra across corresponding frequency bins on the various outputs by computer.
 - Directional gain = $10 \log[(10^{G1/20} + 10^{G2/20} + \dots + 10^{GN/20})^2 / 4] = 12.02\text{dBi} > 6\text{dBi}$, so the PSD limit shall be reduced to $11 - (12.02 - 6) = 4.98\text{dBm}$
 - Refer to section 3.3 for duty cycle spectrum plot.

802.11ac (20MHz)

Chan.	Chan. Freq. (MHz)	PSD (dBm/MHz)				Total Power Density (dBm/MHz)	MAX. Limit (dBm/MHz)	Pass / Fail
		Chain 0	Chain 1	Chain 2	Chain 3			
52	5260	-2.05	-1.98	-2.04	-2.01	4.00	4.98	Pass
60	5300	-1.96	-1.96	-1.93	-1.97	4.07	4.98	Pass
64	5320	-2.17	-2.16	-2.18	-2.22	3.84	4.98	Pass
100	5500	-1.54	-1.54	-1.54	-1.57	4.47	4.98	Pass
120	5600	-1.69	-1.67	-1.70	-1.68	4.34	4.98	Pass
132	5660	-1.41	-1.37	-1.39	-1.38	4.63	4.98	Pass
140	5700	-1.60	-1.57	-1.60	-1.59	4.43	4.98	Pass

- Note:**
- Method a) of power density measurement of KDB 662911 is using for calculating total power density. Total power density is summing entire spectra across corresponding frequency bins on the various outputs by computer.
 - Directional gain = $10 \log[(10^{G1/20} + 10^{G2/20} + \dots + 10^{GN/20})^2 / 4] = 12.02\text{dBi} > 6\text{dBi}$, so the PSD limit shall be reduced to $11 - (12.02 - 6) = 4.98\text{dBm}$
 - Refer to section 3.3 for duty cycle spectrum plot.

802.11ac (40MHz)

Chan.	Chan. Freq. (MHz)	PSD (dBm/MHz)				Duty Factor	Total Power Density (dBm/MHz)	MAX. Limit (dBm/MHz)	Pass / Fail
		Chain 0	Chain 1	Chain 2	Chain 3				
54	5270	-4.63	-4.61	-4.67	-4.64	0.21	1.60	4.98	Pass
62	5310	-4.56	-4.54	-4.58	-4.64	0.21	1.65	4.98	Pass
102	5510	-1.45	-1.49	-1.46	-1.49	0.21	4.76	4.98	Pass
110	5550	-1.73	-1.74	-1.72	-1.74	0.21	4.50	4.98	Pass
134	5670	-1.74	-1.71	-1.75	-1.75	0.21	4.50	4.98	Pass

- Note:**
- Method a) of power density measurement of KDB 662911 is using for calculating total power density. Total power density is summing entire spectra across corresponding frequency bins on the various outputs by computer.
 - Directional gain = $10 \log[(10^{G1/20} + 10^{G2/20} + \dots + 10^{GN/20})^2 / 4] = 12.02\text{dBi} > 6\text{dBi}$, so the PSD limit shall be reduced to $11 - (12.02 - 6) = 4.98\text{dBm}$
 - Refer to section 3.3 for duty cycle spectrum plot.

802.11ac (80MHz)

Chan.	Chan. Freq. (MHz)	PSD (dBm/MHz)				Duty Factor	Total Power Density (dBm/MHz)	MAX. Limit (dBm/MHz)	Pass / Fail
		Chain 0	Chain 1	Chain 2	Chain 3				
58	5290	-7.78	-7.79	-7.73	-7.75	0.32	-1.43	4.98	Pass
106	5530	-2.92	-2.88	-2.87	-2.87	0.32	3.45	4.98	Pass
122	5610	-3.19	-3.18	-3.11	-3.19	0.32	3.17	4.98	Pass

- Note:**
- Method a) of power density measurement of KDB 662911 is using for calculating total power density. Total power density is summing entire spectra across corresponding frequency bins on the various outputs by computer.
 - Directional gain = $10 \log[(10^{G1/20} + 10^{G2/20} + \dots + 10^{GN/20})^2 / 4] = 12.02\text{dBi} > 6\text{dBi}$, so the PSD limit shall be reduced to $11 - (12.02 - 6) = 4.98\text{dBm}$
 - Refer to section 3.3 for duty cycle spectrum plot.

Spectrum Plot of Worst Value

802.11a_Chain 1 / CH132

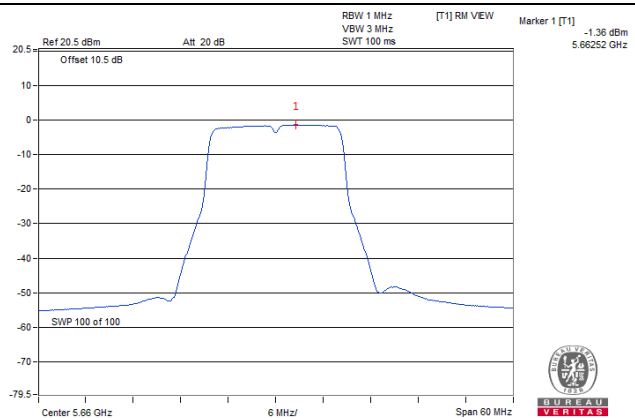

802.11ac (20MHz)_Chain 1 / CH132

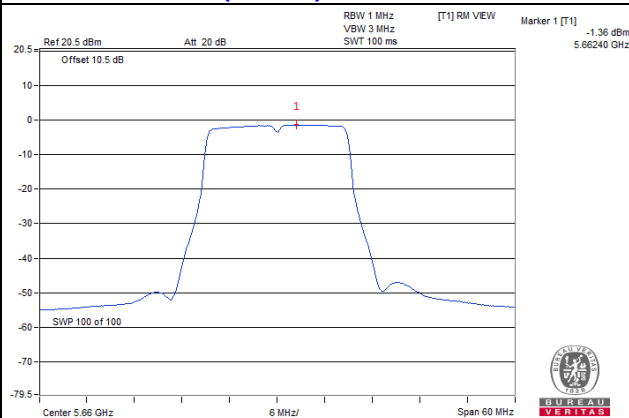

802.11ac (40MHz)_Chain 1 / CH134

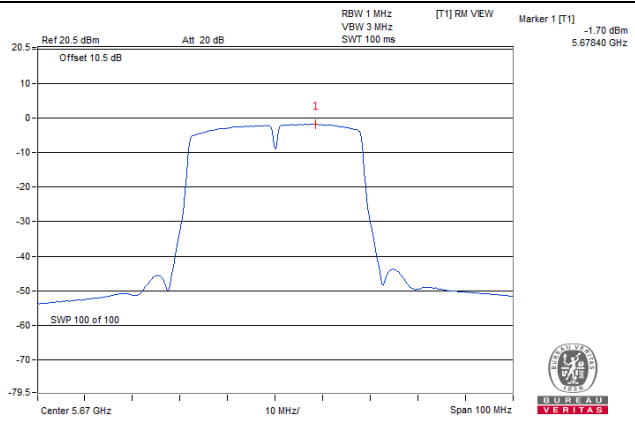

802.11ac (80MHz)_Chain 2 / CH106

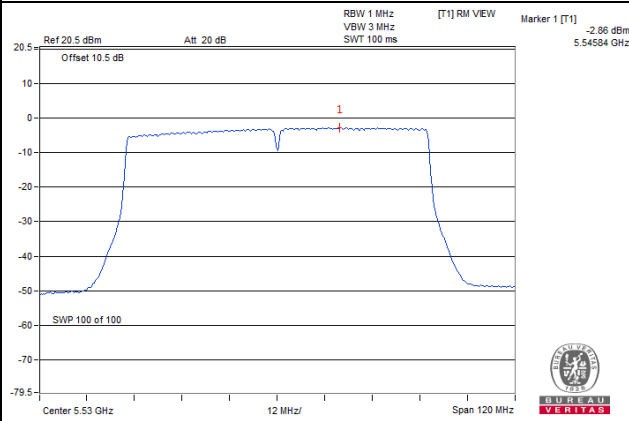

4.6 Frequency Stability Measurement

4.6.1 Limits of Frequency Stability Measurement

The frequency of the carrier signal shall be maintained within band of operation

4.6.2 Test Setup

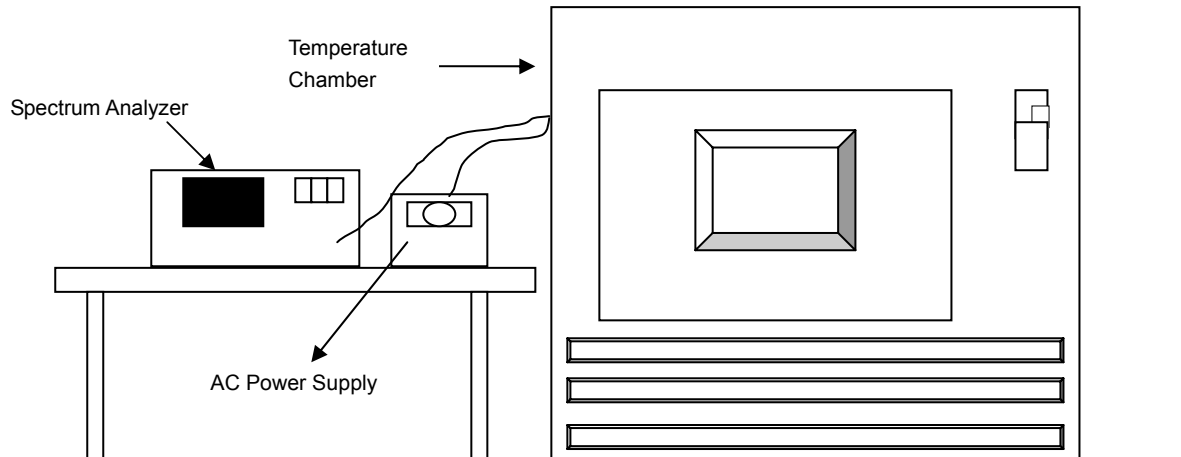

4.6.3 Test Instruments

Refer to section 4.1.2 to get information of above instrument.

4.6.4 Test Procedure

- The EUT was placed inside the environmental test chamber and powered by nominal AC voltage.
- Turn the EUT on and couple its output to a spectrum analyzer.
- Turn the EUT off and set the chamber to the highest temperature specified.
- Allow sufficient time (approximately 30 min) for the temperature of the chamber to stabilize, turn the EUT on and measure the operating frequency after 2, 5, and 10 Minutes.
- Repeat step 2 and 3 with the temperature chamber set to the lowest temperature.
- The test chamber was allowed to stabilize at +20 degree C for a minimum of 30 Minutes. The supply voltage was then adjusted on the EUT from 85% to 115% and the frequency record.

4.6.5 Deviation from Test Standard

No deviation.

4.6.6 EUT Operating Condition

Set the EUT transmit at un-modulation mode to test frequency stability.

4.6.7 Test Results

CDD Mode (Mode A)

Frequency Stability Versus Temp.									
Operating Frequency: 5260 MHz									
TEMP. (°C)	Power Supply (Vac)	0 Minute		2 Minute		5 Minute		10 Minute	
		Measured Frequency (MHz)	Pass/Fail	Measured Frequency (MHz)	Pass/Fail	Measured Frequency (MHz)	Pass/Fail	Measured Frequency (MHz)	Pass/Fail
50	120	5260.043125	Pass	5260.043294	Pass	5260.042853	Pass	5260.042989	Pass
40	120	5260.043501	Pass	5260.043604	Pass	5260.043706	Pass	5260.044039	Pass
30	120	5260.041657	Pass	5260.041872	Pass	5260.042077	Pass	5260.041905	Pass
20	120	5260.043353	Pass	5260.043044	Pass	5260.043172	Pass	5260.043149	Pass
10	120	5260.043834	Pass	5260.043673	Pass	5260.043834	Pass	5260.043585	Pass
0	120	5260.042698	Pass	5260.042774	Pass	5260.042731	Pass	5260.042753	Pass
-10	120	5260.043081	Pass	5260.043256	Pass	5260.042980	Pass	5260.042956	Pass
-20	120	5260.043548	Pass	5260.043318	Pass	5260.043708	Pass	5260.043538	Pass

Frequency Stability Versus Voltage									
Operating Frequency: 5260 MHz									
TEMP. (°C)	Power Supply (Vac)	0 Minute		2 Minute		5 Minute		10 Minute	
		Measured Frequency(MHz)	Pass/Fail	Measured Frequency(M Hz)	Pass/Fail	Measured Frequency(MHz)	Pass/Fail	Measured Frequency(M Hz)	Pass/Fail
20	138	5260.042684	Pass	5260.042397	Pass	5260.042491	Pass	5260.042539	Pass
	120	5260.043353	Pass	5260.043044	Pass	5260.043172	Pass	5260.043149	Pass
	102	5260.043104	Pass	5260.042866	Pass	5260.042842	Pass	5260.04305	Pass

5 Pictures of Test Arrangements

Please refer to the attached file (Test Setup Photo).

Appendix – Information on the Testing Laboratories

We, Bureau Veritas Consumer Products Services (H.K.) Ltd., Taoyuan Branch, were founded in 1988 to provide our best service in EMC, Radio, Telecom and Safety consultation. Our laboratories are accredited and approved according to ISO/IEC 17025.

If you have any comments, please feel free to contact us at the following:

Linko EMC/RF Lab

Tel: 886-2-26052180

Fax: 886-2-26051924

Hsin Chu EMC/RF/Telecom Lab

Tel: 886-3-6668565

Fax: 886-3-6668323

Hwa Ya EMC/RF/Safety Lab

Tel: 886-3-3183232

Fax: 886-3-3270892

Email: service.adt@tw.bureauveritas.com

Web Site: www.bureauveritas-adt.com

The address and road map of all our labs can be found in our web site also.

--- END ---