

DFS Test Report

Report No.: RF170918D11A-4

FCC ID: 2AI9TOAW-AP123X

Test Model: OAW-AP1231

Series Model: OAW-AP1232

Received Date: July 20, 2017

Test Date: Mar. 02 to 09, 2018

Issued Date: Apr. 09, 2018

Applicant: ALE USA Inc.

Address: 26801 West Agoura Road, Calabasas, CA 91301

Issued By: Bureau Veritas Consumer Products Services (H.K.) Ltd., Taoyuan Branch
Hsin Chu Laboratory

Lab Address: E-2, No.1, Li Hsin 1st Road, Hsinchu Science Park, Hsinchu City 300,
Taiwan R.O.C.

Test Location : E-2, No.1, Li Hsin 1st Road, Hsinchu Science Park, Hsinchu City 300,
Taiwan R.O.C.

**FCC Registration /
Designation Number:** 723255 / TW2022



This report is for your exclusive use. Any copying or replication of this report to or for any other person or entity, or use of our name or trademark, is permitted only with our prior written permission. This report sets forth our findings solely with respect to the test samples identified herein. The results set forth in this report are not indicative or representative of the quality or characteristics of the lot from which a test sample was taken or any similar or identical product unless specifically and expressly noted. Our report includes all of the tests requested by you and the results thereof based upon the information that you provided to us. You have 60 days from date of issuance of this report to notify us of any material error or omission caused by our negligence, provided, however, that such notice shall be in writing and shall specifically address the issue you wish to raise. A failure to raise such issue within the prescribed time shall constitute your unqualified acceptance of the completeness of this report, the tests conducted and the correctness of the report contents. Unless specific mention, the uncertainty of measurement has been explicitly taken into account to declare the compliance or non-compliance to the specification. The report must not be used by the client to claim product certification, approval, or endorsement by TAF or any government agencies.

Table of Contents

Release Control Record	3
1 Certificate of Conformity	4
2 EUT Information	5
2.1 Operating Frequency Bands and Mode of EUT	5
2.2 EUT Software and Firmware Version	5
2.3 Description of Available Antennas to the EUT	5
2.4 EUT Maximum and Minimum Conducted Power	6
2.5 EUT Maximum and Minimum EIRP Power	8
2.6 Transmit Power Control (TPC)	10
2.7 Statement of Manufacturer	10
3. U-NII DFS Rule Requirements	11
3.1 Working Modes and Required Test Items	11
3.2 Test Limits and Radar Signal Parameters	12
4. Test & Support Equipment List	15
4.1 Test Instruments	15
4.2 Description of Support Units	15
5. Test Procedure	16
5.1 DFS Measurement System	16
5.2 Calibration of DFS Detection Threshold Level	17
5.3 Deviation from Test Standard	17
5.4 Radiated Test Setup Configuration	18
6. Test Results	19
6.1 Summary of Test Results	19
6.2 Test Results	20
6.2.1 Test Mode: Device Operating In Master Mode	20
6.2.2 U-NII Detection Bandwidth	25
6.2.3 Channel Availability Check Time	36
6.2.4 Channel Closing Transmission and Channel Move Time	39
6.2.5 Non- Occupancy Period	98
7. Information on the Testing Laboratories	100
8. Appendix-A	101

Release Control Record

Issue No.	Description	Date Issued
RF170918D11A-4	Original release.	Apr. 09, 2018

1 Certificate of Conformity

Product: OmniAccess Stellar

Brand: Alcatel-Lucent Enterprise

Test Model: OAW-AP1231

Series Model: OAW-AP1232

Sample Status: ENGINEERING SAMPLE

Applicant: ALE USA Inc.

Test Date: Mar. 02 to 09, 2018

Standards: FCC Part 15, Subpart E (Section 15.407)

KDB 905462 D02 UNII DFS Compliance Procedures New Rules v02

The above equipment has been tested by **Bureau Veritas Consumer Products Services (H.K.) Ltd., Taoyuan Branch**, and found compliance with the requirement of the above standards. The test record, data evaluation & Equipment Under Test (EUT) configurations represented herein are true and accurate accounts of the measurements of the sample's EMC characteristics under the conditions specified in this report.

Prepared by : Wendy Wu , **Date:** Apr. 09, 2018
Wendy Wu / Specialist

Approved by : May Chen , **Date:** Apr. 09, 2018
May Chen / Manager

2 EUT Information

2.1 Operating Frequency Bands and Mode of EUT

Table 1: Operating Frequency Bands and Mode of EUT

Operational Mode	Operating Frequency Range	
	5250~5350MHz	5470~5725MHz
Master	✓	✓

2.2 EUT Software and Firmware Version

Table 2: The EUT Software/Firmware Version

No.	Product	Model No.	Software/Firmware Version
1	OmniAccess Stellar	OAW-AP1231	3.0.2.4915

2.3 Description of Available Antennas to the EUT

Table 3: Antenna List

Mode of EUT	Antenna	Frequency	Chain No	Antenna Type	Antenna Gain (dBi)	Connector Type
OAW-AP1231	Internal	5GHz	Chain 0	PIFA	4.46	I-PEX
			Chain 1	PIFA	4.22	I-PEX
			Chain 2	PIFA	4.17	I-PEX
			Chain 3	PIFA	4.47	I-PEX
			Chain 4	PIFA	4.41	I-PEX
			Chain 5	PIFA	4.30	I-PEX
			Chain 6	PIFA	4.43	I-PEX
			Chain 7	PIFA	4.13	I-PEX
OAW-AP1232	External	5GHz	Chain 0	Dipole	6	R-SMA
			Chain 1	Dipole	6	R-SMA
			Chain 2	Dipole	6	R-SMA
			Chain 3	Dipole	6	R-SMA
			Chain 4	Dipole	6	R-SMA
			Chain 5	Dipole	6	R-SMA
			Chain 6	Dipole	6	R-SMA
			Chain 7	Dipole	6	R-SMA

Note: From the above antennas, internal antenna was selected as representative antenna for the test, its data was recorded in this report.

2.4 EUT Maximum and Minimum Conducted Power

Table 4: The Measured Conducted Output Power

802.11a

CDD Mode

Frequency Band (MHz)	MAX. Power		MIN. Power	
	Output Power(mW)	Output Power(dBm)	Output Power(mW)	Output Power(dBm)
5250~5350	68.531	18.36	17.219	12.36
5470~5725	85.053	19.3	21.380	13.3

802.11ac (VHT20)

CDD Mode

Frequency Band (MHz)	MAX. Power		MIN. Power	
	Output Power(mW)	Output Power(dBm)	Output Power(mW)	Output Power(dBm)
5250~5350	69.004	18.39	17.338	12.39
5470~5725	93.847	19.72	23.550	13.72

Beamforming Mode

Frequency Band (MHz)	MAX. Power		MIN. Power	
	Output Power(mW)	Output Power(dBm)	Output Power(mW)	Output Power(dBm)
5250~5350	17.144	12.34	4.305	6.34
5470~5725	84.026	19.24	21.086	13.24

802.11ac (VHT40)

CDD Mode

Frequency Band (MHz)	MAX. Power		MIN. Power	
	Output Power(mW)	Output Power(dBm)	Output Power(mW)	Output Power(dBm)
5250~5350	68.834	18.38	17.298	12.38
5470~5725	167.02	22.23	41.976	16.23

Beamforming Mode

Frequency Band (MHz)	MAX. Power		MIN. Power	
	Output Power(mW)	Output Power(dBm)	Output Power(mW)	Output Power(dBm)
5250~5350	17.092	12.33	4.295	6.33
5470~5725	83.415	19.21	20.941	13.21

**802.11ac (VHT80)
CDD Mode**

Frequency Band (MHz)	MAX. Power		MIN. Power	
	Output Power(mW)	Output Power(dBm)	Output Power(mW)	Output Power(dBm)
5250~5350	68.672	18.37	17.258	12.37
5470~5725	214.089	23.31	53.827	17.31

Beamforming Mode

Frequency Band (MHz)	MAX. Power		MIN. Power	
	Output Power(mW)	Output Power(dBm)	Output Power(mW)	Output Power(dBm)
5250~5350	17.083	12.33	4.295	6.33
5470~5725	81.724	19.12	20.512	13.12

2.5 EUT Maximum and Minimum EIRP Power

Table 5: The EIRP Output Power List

802.11a

CDD Mode

Frequency Band (MHz)	MAX. EIRP Power		MIN. EIRP Power	
	Output Power(mW)	Output Power(dBm)	Output Power(mW)	Output Power(dBm)
5250~5350	191.817	22.83	48.195	16.83
5470~5725	238.062	23.77	59.841	17.77

802.11ac (VHT20)

CDD Mode

Frequency Band (MHz)	MAX. EIRP Power		MIN. EIRP Power	
	Output Power(mW)	Output Power(dBm)	Output Power(mW)	Output Power(dBm)
5250~5350	193.141	22.86	48.529	16.86
5470~5725	262.676	24.19	65.917	18.19

Beamforming Mode

Frequency Band (MHz)	MAX. EIRP Power		MIN. EIRP Power	
	Output Power(mW)	Output Power(dBm)	Output Power(mW)	Output Power(dBm)
5250~5350	191.916	22.83	48.195	16.83
5470~5725	940.619	29.73	236.048	23.73

802.11ac (VHT40)

CDD Mode

Frequency Band (MHz)	MAX. EIRP Power		MIN. EIRP Power	
	Output Power(mW)	Output Power(dBm)	Output Power(mW)	Output Power(dBm)
5250~5350	192.665	22.85	48.417	16.85
5470~5725	467.486	26.7	117.490	20.7

Beamforming Mode

Frequency Band (MHz)	MAX. EIRP Power		MIN. EIRP Power	
	Output Power(mW)	Output Power(dBm)	Output Power(mW)	Output Power(dBm)
5250~5350	191.334	22.82	48.084	16.82
5470~5725	933.779	29.7	234.423	23.7

802.11ac (VHT80)
CDD Mode

Frequency Band (MHz)	MAX. EIRP Power		MIN. EIRP Power	
	Output Power(mW)	Output Power(dBm)	Output Power(mW)	Output Power(dBm)
5250~5350	192.212	22.84	48.306	16.84
5470~5725	599.231	27.78	150.661	21.78

Beamforming Mode

Frequency Band (MHz)	MAX. EIRP Power		MIN. EIRP Power	
	Output Power(mW)	Output Power(dBm)	Output Power(mW)	Output Power(dBm)
5250~5350	191.234	22.82	48.084	16.82
5470~5725	914.849	29.61	229.615	23.61

2.6 Transmit Power Control (TPC)

U-NII devices operating in the 5.25-5.35 GHz band and the 5.47-5.725 GHz band shall employ a TPC mechanism. The U-NII device is required to have the capability to operate at least 6 dB below the mean EIRP value of 30 dBm. A TPC mechanism is not required for systems with an e.i.r.p. of less than 500 mW.

Applicable	EIRP	FCC 15.407 (h)(1)
√	>500mW	The TPC mechanism is required for system with an EIRP of above 500Mw
	<500mW	The TPC mechanism is not required for system with an EIRP of less 500mW

The UUT can adjust a transmitter's output power based on the signal level present at the receiver. TPC is auto controlled by software.

2.7 Statement of Manufacturer

Manufacturer statement confirming that information regarding the parameters of the detected Radar Waveforms is not available to the end user.

3. U-NII DFS Rule Requirements

3.1 Working Modes and Required Test Items

The manufacturer shall state whether the UUT is capable of operating as a Master and/or a Client. If the UUT is capable of operating in more than one operating mode then each operating mode shall be tested separately. See tables 6 and 7 for the applicability of DFS requirements for each of the operational modes.

Table 6: Applicability of DFS Requirements Prior to Use a Channel

Requirement	Operational Mode		
	Master	Client without radar detection	Client with radar detection
Non-Occupancy Period	✓	✓ note	✓
DFS Detection Threshold	✓	Not required	✓
Channel Availability Check Time	✓	Not required	Not required
U-NII Detection Bandwidth	✓	Not required	✓

Note: Per KDB 905462 D03 UNII Clients Without Radar Detection New Rules v01r02 section (b)(5/6), If the client moves with the master, the device is considered compliant if nothing appears in the client non-occupancy period test. For devices that shut down (rather than moving channels), no beacons should appear. An analyzer plot that contains a single 30-minute sweep on the original channel.

Table 7: Applicability of DFS Requirements during Normal Operation.

Requirement	Operational Mode	
	Master or Client with radar detection	Client without radar detection
DFS Detection Threshold	✓	Not required
Channel Closing Transmission Time	✓	✓
Channel Move Time	✓	✓
U-NII Detection Bandwidth	✓	Not required

Additional requirements for devices with multiple bandwidth modes	Master or Client with radar detection	Client without radar detection
U-NII Detection Bandwidth and Statistical Performance Check	All BW modes must be tested	Not required
Channel Move Time and Channel Closing Transmission Time	Test using widest BW mode available	Test using the widest BW mode available for the link
All other tests	Any single BW mode	Not required

Note: Frequencies selected for statistical performance check (Section 7.8.4) should include several frequencies within the radar detection bandwidth and frequencies near the edge of the radar detection bandwidth. For 802.11 devices it is suggested to select frequencies in each of the bonded 20 MHz channels and the channel center frequency.

3.2 Test Limits and Radar Signal Parameters

Detection Threshold Values

Table 8: DFS Detection Thresholds for Master Devices and Client Devices with Radar Detection

Maximum Transmit Power	Value (See Notes 1, 2, and 3)
EIRP \geq 200 milliwatt	-64 dBm
EIRP < 200 milliwatt and power spectral density < 10 dBm/MHz	-62 dBm
EIRP < 200 milliwatt that do not meet the power spectral density requirement	-64 dBm

Note 1: This is the level at the input of the receiver assuming a 0 dBi receive antenna.

Note 2: Throughout these test procedures an additional 1 dB has been added to the amplitude of the test transmission waveforms to account for variations in measurement equipment. This will ensure that the test signal is at or above the detection threshold level to trigger a DFS response.

Note3: EIRP is based on the highest antenna gain. For MIMO devices refer to KDB Publication 662911 D01.

Table 9: DFS Response Requirement Values

Parameter	Value
Non-occupancy period	Minimum 30 minutes
Channel Availability Check Time	60 seconds
Channel Move Time	10 seconds See Note 1.
Channel Closing Transmission Time	200 milliseconds + an aggregate of 60 milliseconds over remaining 10 second period. See Notes 1 and 2.
U-NII Detection Bandwidth	Minimum 100% of the U-NII 99% transmission power bandwidth. See Note 3

Note 1: Channel Move Time and the Channel Closing Transmission Time should be performed with Radar Type 0. The measurement timing begins at the end of the Radar Type 0 burst.

Note 2: The Channel Closing Transmission Time is comprised of 200 milliseconds starting at the beginning of the Channel Move Time plus any additional intermittent control signals required to facilitate a Channel move (an aggregate of 60 milliseconds) during the remainder of the 10 second period. The aggregate duration of control signals will not count quiet periods in between transmissions.

Note 3: During the U-NII Detection Bandwidth detection test, radar type 0 should be used. For each frequency step the minimum percentage of detection is 90 percent. Measurements are performed with no data traffic.

Parameters of DFS Test Signals

Step intervals of 0.1 microsecond for Pulse Width, 1 microsecond for PRI, 1 MHz for chirp width and 1 for the number of pulses will be utilized for the random determination of specific test waveforms.

Table 10: Short Pulse Radar Test Waveforms

Radar Type	Pulse Width (μsec)	PRI (μsec)	Number of Pulses	Minimum Percentage of Successful Detection	Minimum Number of Trials
0	1	1428	18	See Note 1	See Note 1
1	1	Test A: 15 unique PRI values randomly selected from the list of 23 PRI values in Table 5a	Roundup $\left\{ \left(\frac{1}{360} \right) \cdot \left(\frac{19 \cdot 10^6}{PRI_{\mu sec}} \right) \right\}$	60%	30
		Test B: 15 unique PRI values randomly selected within the range of 518-3066μ sec, with a minimum increment of 1μ sec, excluding PRI values selected in Test A			
2	1-5	150-230	23-29	60%	30
3	6-10	200-500	16-18	60%	30
4	11-20	200-500	12-16	60%	30
Aggregate (Radar Types 1-4)				80%	120
Note 1: Short Pulse Radar Type 0 should be used for the detection bandwidth test, channel move time, and channel closing time tests.					

Table 11: Long Pulse Radar Test Waveform

Radar Type	Pulse Width (µsec)	Chirp Width (MHz)	PRI (µsec)	Number of Pulses Per Burst	Number of Bursts	Minimum Percentage of Successful Detection	Minimum Number of Trials
5	50-100	5-20	1000-2000	1-3	8-20	80%	30

Three subsets of trials will be performed with a minimum of ten trials per subset. The subset of trials differ in where the Long Pulse Type 5 Signal is tuned in frequency.

- a) the Channel center frequency
- b) tuned frequencies such that 90% of the Long Pulse Type 5 frequency modulation is within the low edge of the UUT Occupied Bandwidth
- c) tuned frequencies such that 90% of the Long Pulse Type 5 frequency modulation is within the high edge of the UUT Occupied Bandwidth

It include 10 trails for every subset, the formula as below,

For subset case 1: the center frequency of the signal generator will remain fixed at the center of the UUT Channel.

For subset case 2: to retain 90% frequency overlap between the radar signal and the UUT Occupied Bandwidth, the center frequency of the signal generator will vary for each of the ten trials in subset case 2. The center frequency of the signal generator for each trial is calculated by:

$$FL+(0.4*Chirp\ Width\ [in\ MHz])$$

For subset case 3: to retain 90% frequency overlap between the radar signal and the UUT Occupied Bandwidth, the center frequency of the signal generator will vary for each of the ten trials in subset case 3. The center frequency of the signal generator for each trial is calculated by:

$$FH-(0.4*Chirp\ Width\ [in\ MHz])$$

Table 12: Frequency Hopping Radar Test Waveform

Radar Type	Pulse Width (µsec)	PRI (µsec)	Pulses per Hop	Hopping Rate (kHz)	Hopping Sequence Length (msec)	Minimum Percentage of Successful Detection	Minimum Number of Trials
6	1	333	9	0.333	300	70%	30

4. Test & Support Equipment List

4.1 Test Instruments

Table 13: Test Instruments List

DESCRIPTION & MANUFACTURER	MODEL NO.	SERIAL NO.	CALIBRATED DATE	CALIBRATED UNTIL
Spectrum Analyzer Agilent	N9030A	MY553390160	Jan. 26, 2018	Jan. 25, 2019
Vector Signal Generator Agilent	E4438CK-403	ESG E4_010001	Oct. 11, 2017	Oct. 10, 2018
Horn_Antenna EMCO	1018G	0001	Nov 30, 2017	Nov. 29, 2018
DFS Control Box	BV-DFS-CB	001	Dec. 05, 2017	Dec. 04, 2018

4.2 Description of Support Units

Table 14: Support Unit Information

No.	Product	Brand	Model No.	FCC ID	Spec
1	Wireless LAN Unit	NEC	NP05LM	RRK-NECNP05LM	

NOTE: This device was functioned as a Master Slave device during the DFS test.

Table 15: Software/Firmware Information

No.	Product	Model No.	Software/Firmware Version
1	Wireless LAN Unit	NP05LM	Driver Version: 06/18/2014, 1026.12.606.2014

5. Test Procedure

5.1 DFS Measurement System

A complete DFS Measurement System consists of two subsystems: (1) the Radar Signal Generating system and (2) the Traffic Monitoring system. The control PC is necessary for generating the Radar waveforms in Table 10, 11 and 12. The traffic monitoring subsystem is specified to the type of unit under test (UUT).

Radiated Setup Configuration of DFS Measurement System

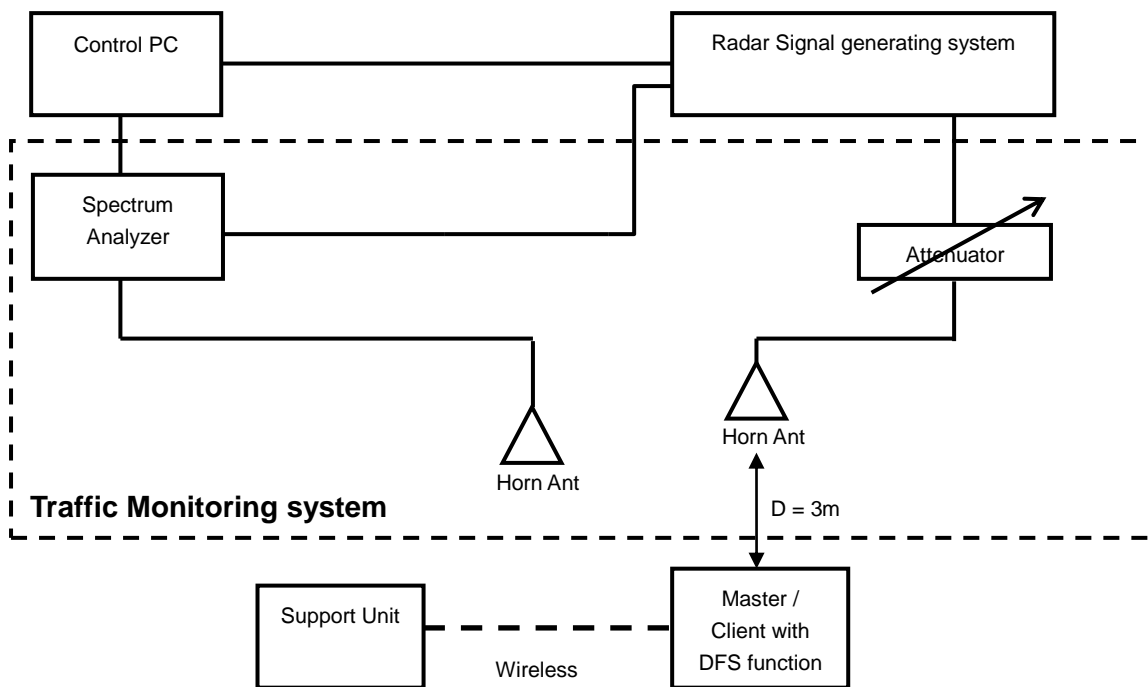

Channel Loading

System testing will be performed with channel-loading using means appropriate to the data types that are used by the unlicensed device. The following requirements apply:

a)	The data file must be of a type that is typical for the device (i.e., MPEG-2, MPEG-4, WAV, MP3, MP4, AVI, etc.) and must generally be transmitting in a streaming mode.	
b)	Software to ping the client is permitted to simulate data transfer but must have random ping intervals.	
c)	Timing plots are required with calculations demonstrating a minimum channel loading of approximately 17% or greater.	✓
d)	Unicast or Multicast protocols are preferable but other protocols may be used. The appropriate protocol used must be described in the test procedures.	

5.2 Calibration of DFS Detection Threshold Level

The measured channel is 5500MHz and 5510MHz and 5530MHz. The radar signal was the same as transmitted channels, and injected into the antenna of AP (master) or Client Device with Radar Detection, measured the channel closing transmission time and channel move time.

Radiated setup configuration of Calibration of DFS Detection Threshold Level

The calibrated conducted detection threshold level is set to -64dBm. The tested level is lower than required level hence it provides margin to the limit.

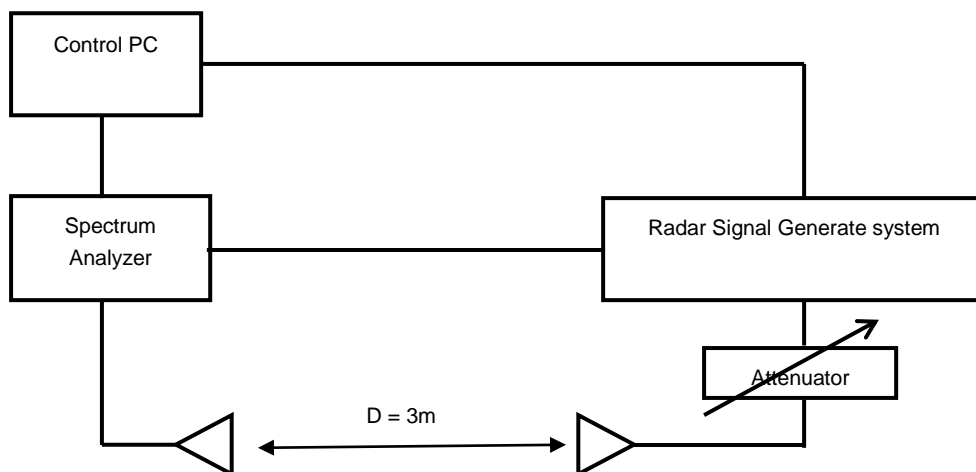

5.3 Deviation from Test Standard

No deviation.

5.4 Radiated Test Setup Configuration

Master mode

The EUT is a U-NII Device operating in Master mode. The radar test signals are injected into the Master Device.

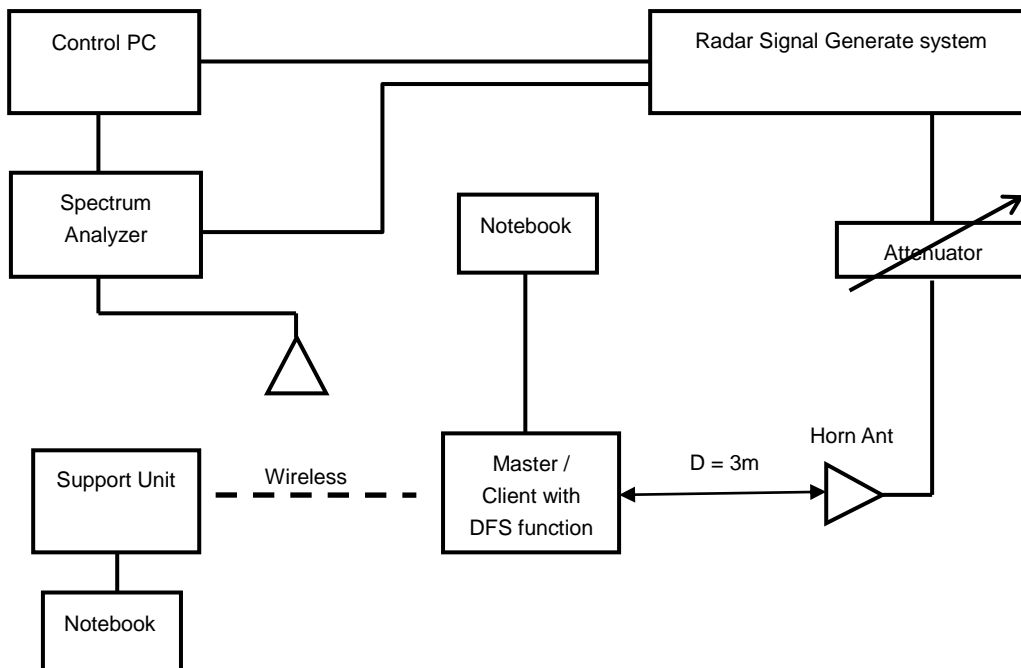

Note: The UUT main beam of the antenna is directly toward the radar emitter during testing.

6. Test Results

6.1 Summary of Test Results

Clause	Test Parameter	Remarks	Pass/Fail
15.407	DFS Detection Threshold	Applicable	Pass
15.407	Channel Availability Check Time	Applicable	Pass
15.407	Channel Move Time	Applicable	Pass
15.407	Channel Closing Transmission Time	Applicable	Pass
15.407	Non- Occupancy Period	Applicable	Pass
15.407	U-NII Detection Bandwidth	Applicable	Pass

6.2 Test Results

6.2.1 Test Mode: Device Operating In Master Mode.

The radar test waveforms are injected into the Master.
 This test was investigated for different bandwidth (20MHz · 40MHz and 80MHz).
 The following plots was done on 80MHz as a representative

DFS Detection Threshold

For detection threshold level of -64dBm, the tested level is lower than required level for 1dB, hence it provides margin to the limit.

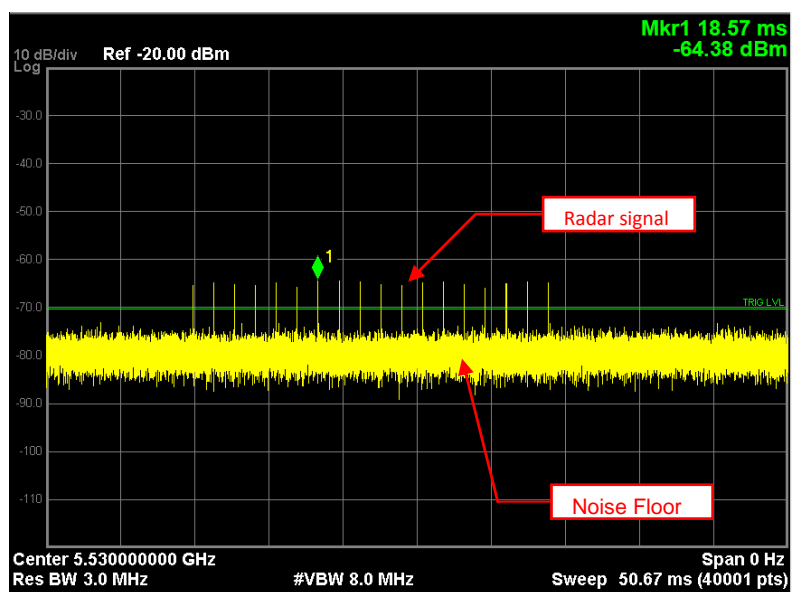

Radar Signal 0

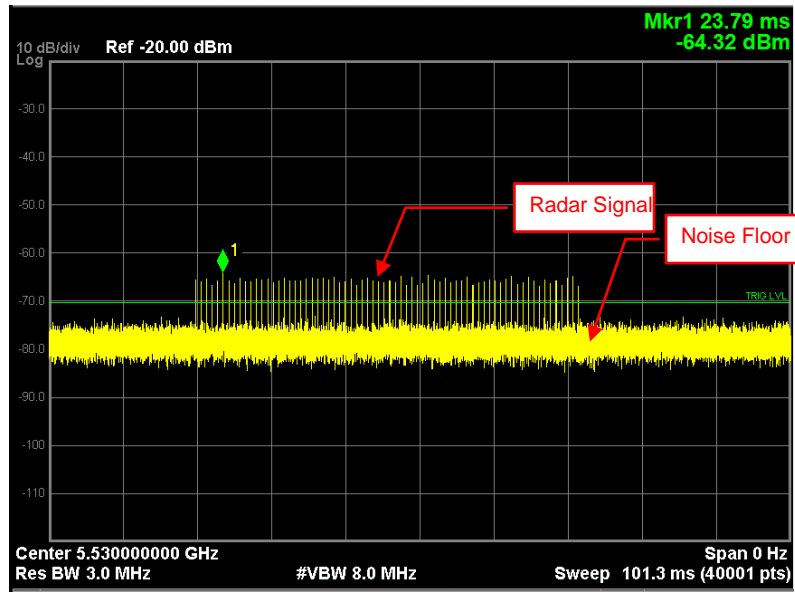

Radar Signal 1 (Test A)

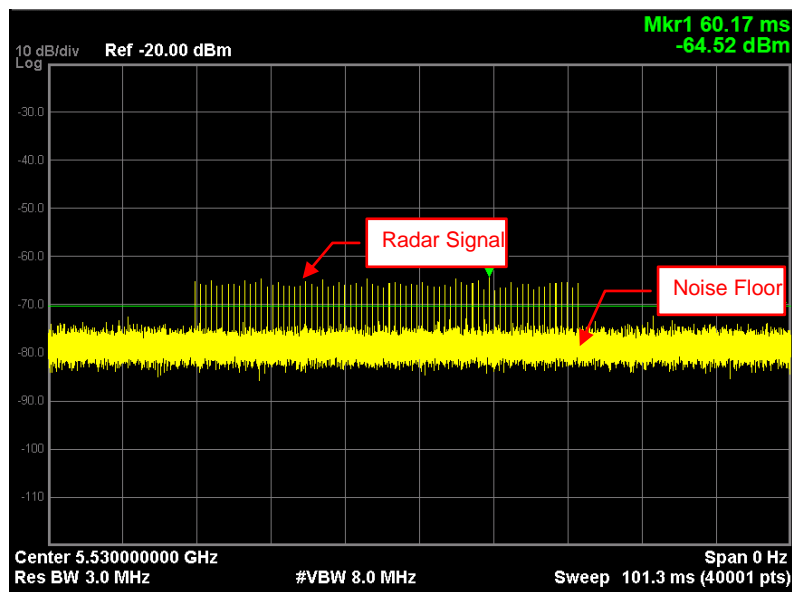

Radar Signal 1 (Test B)

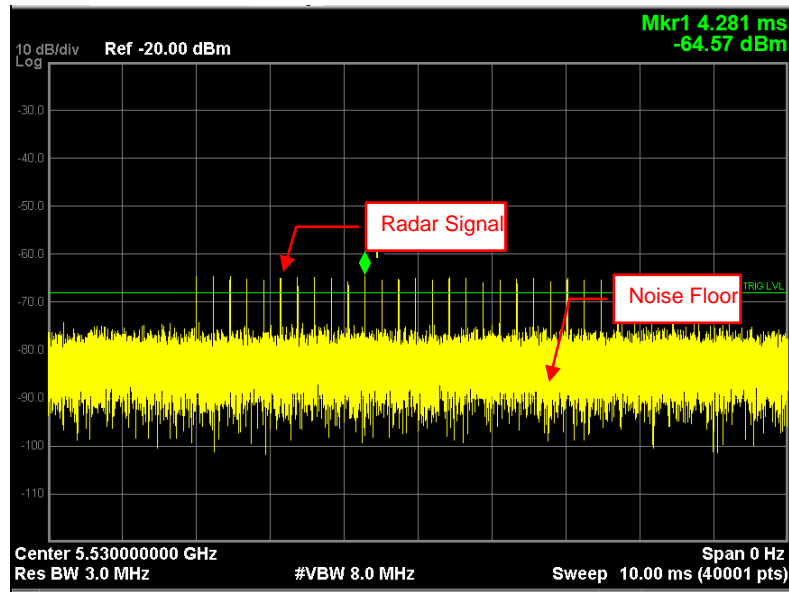

Radar Signal 2

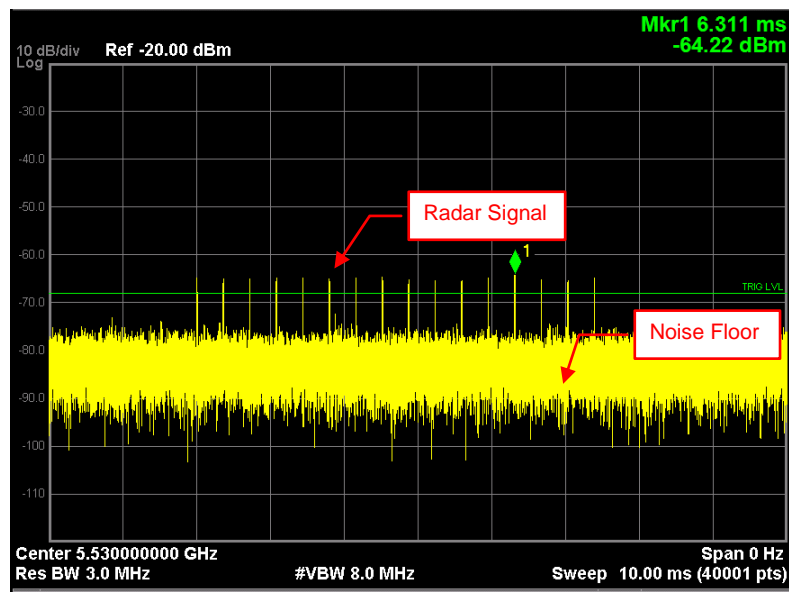

Radar Signal 3

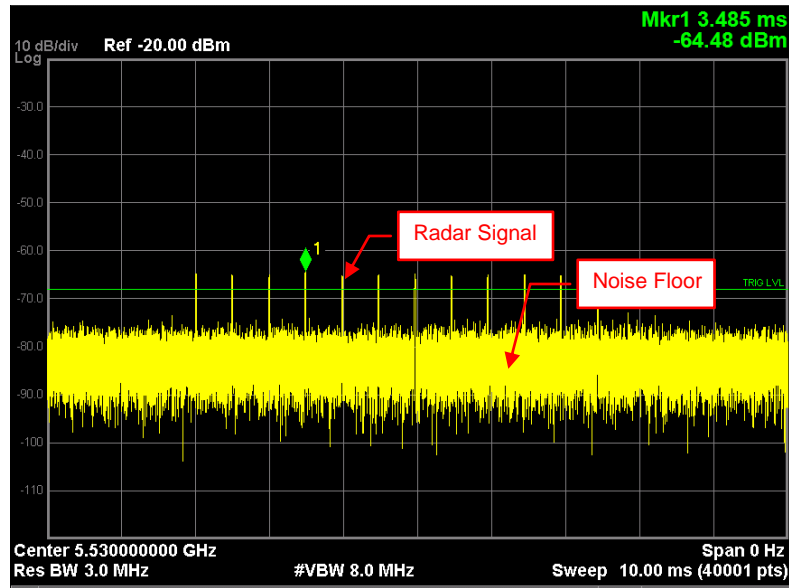

Single Burst of Radar Signal 4

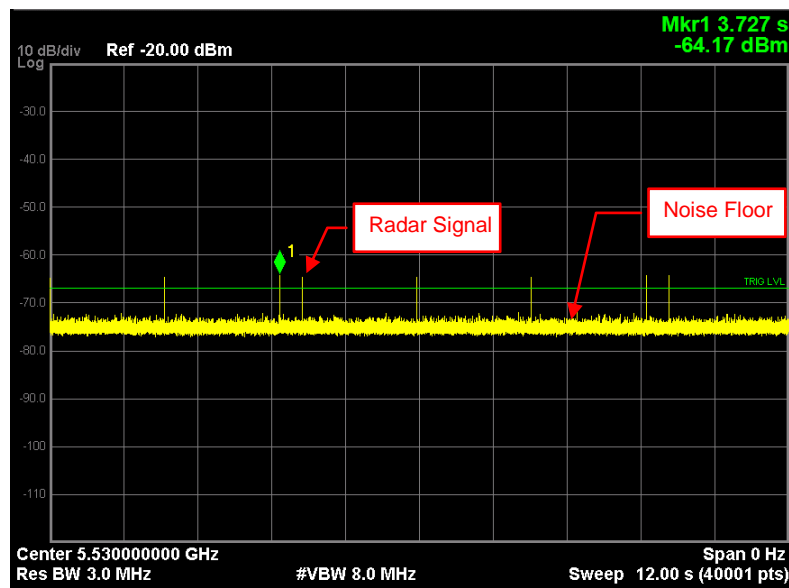

Radar Signal 5

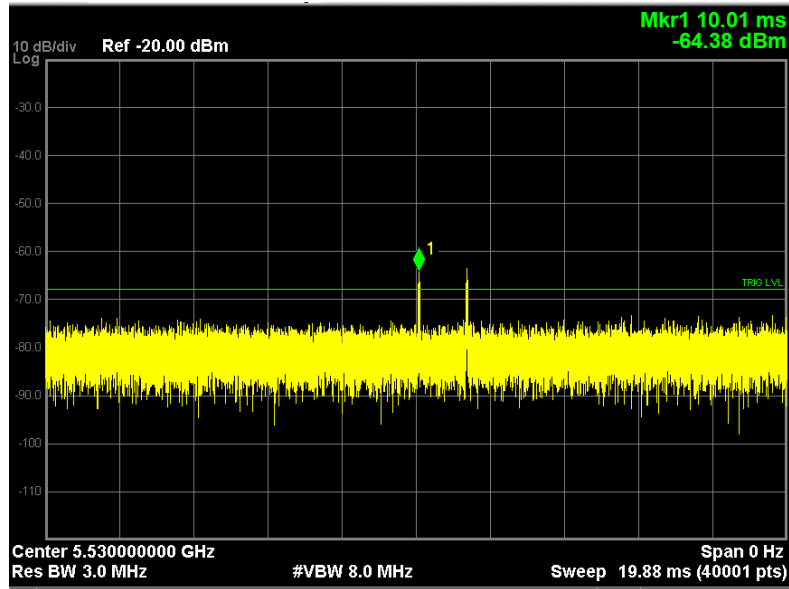

Single Burst of Radar Signal 5

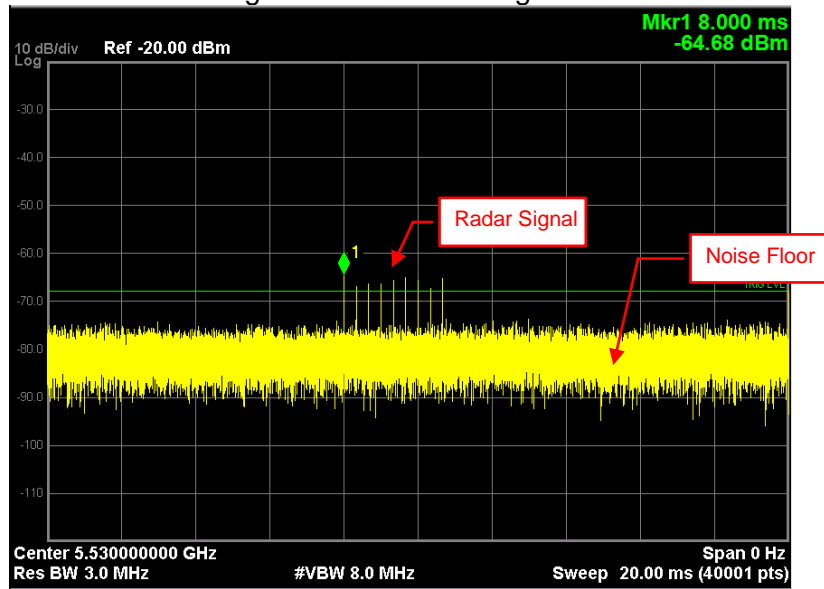

Radar Signal 6

6.2.2 U-NII Detection Bandwidth

802.11ac (VHT20)

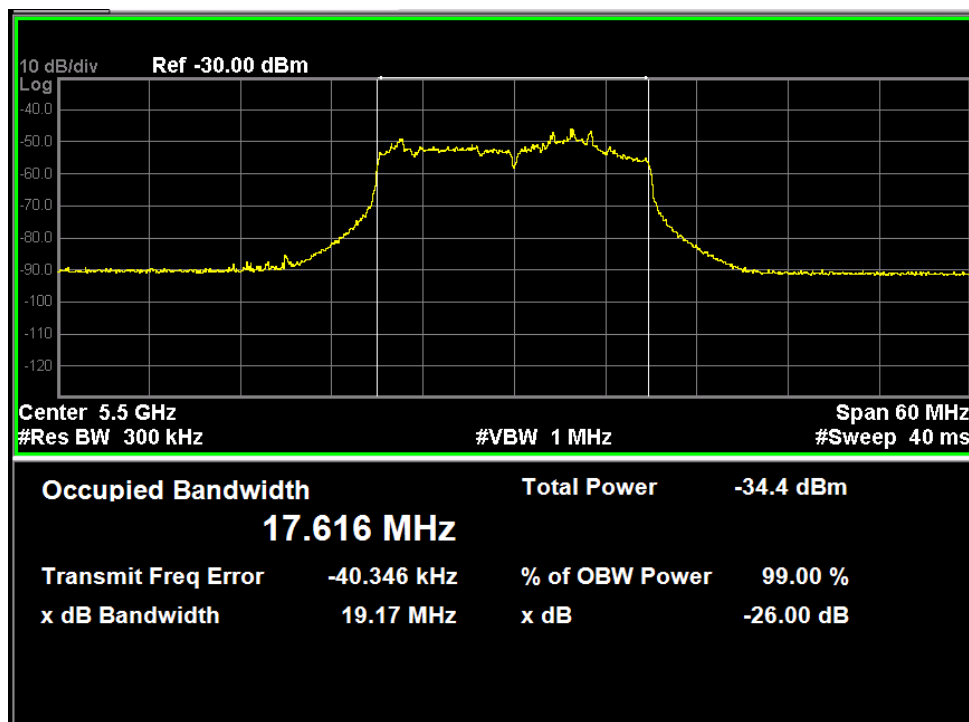
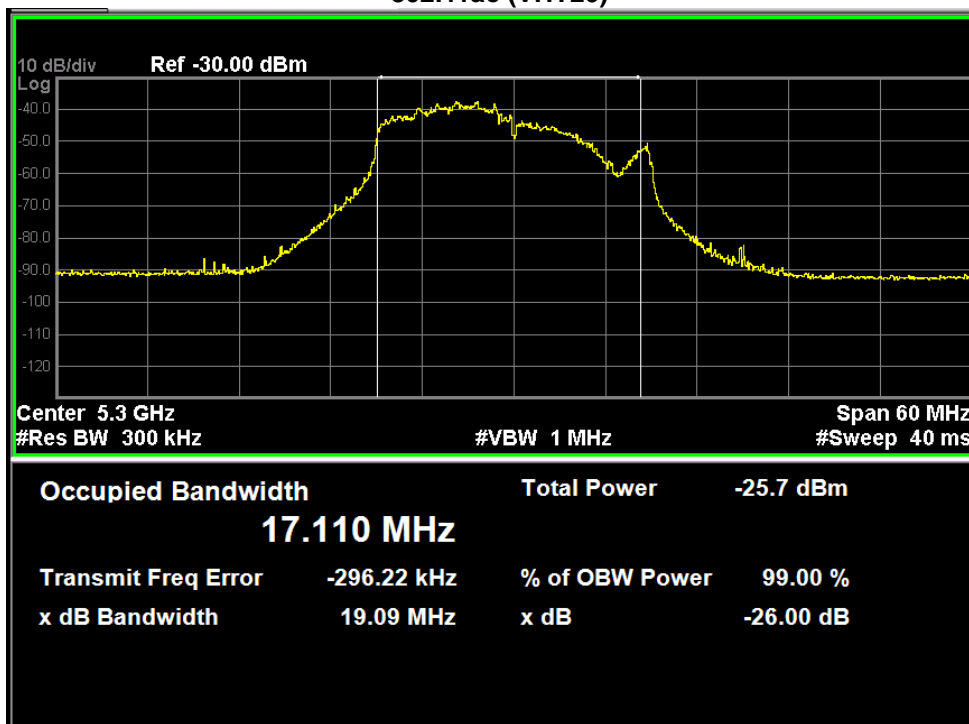

U-NII 99% Channel bandwidth

802.11ac (VHT40)

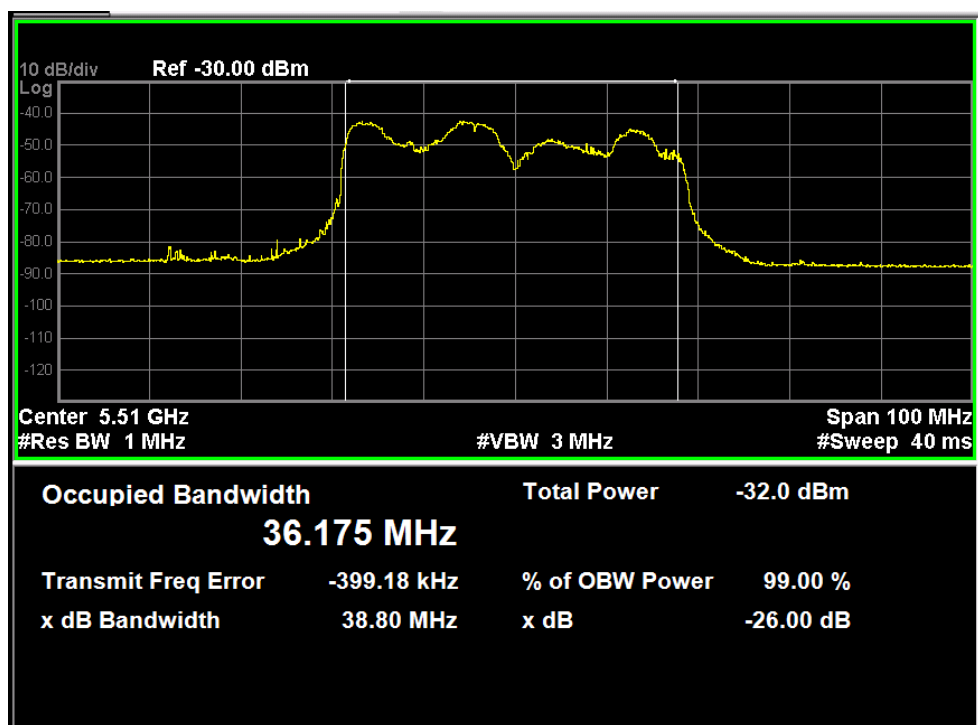
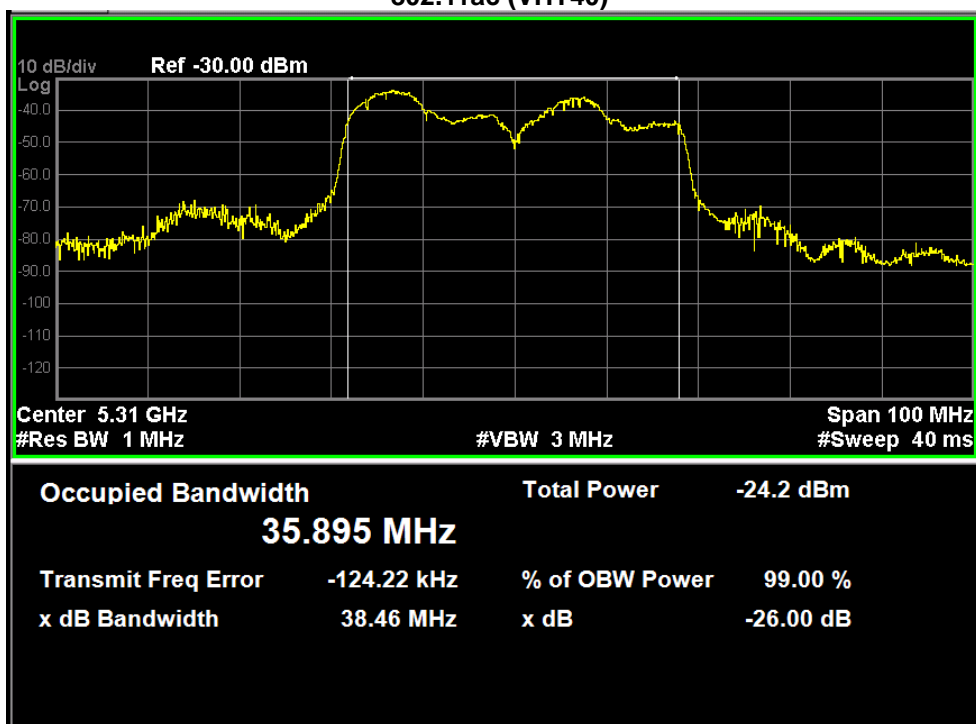

U-NII 99% Channel bandwidth

802.11ac (VHT80)

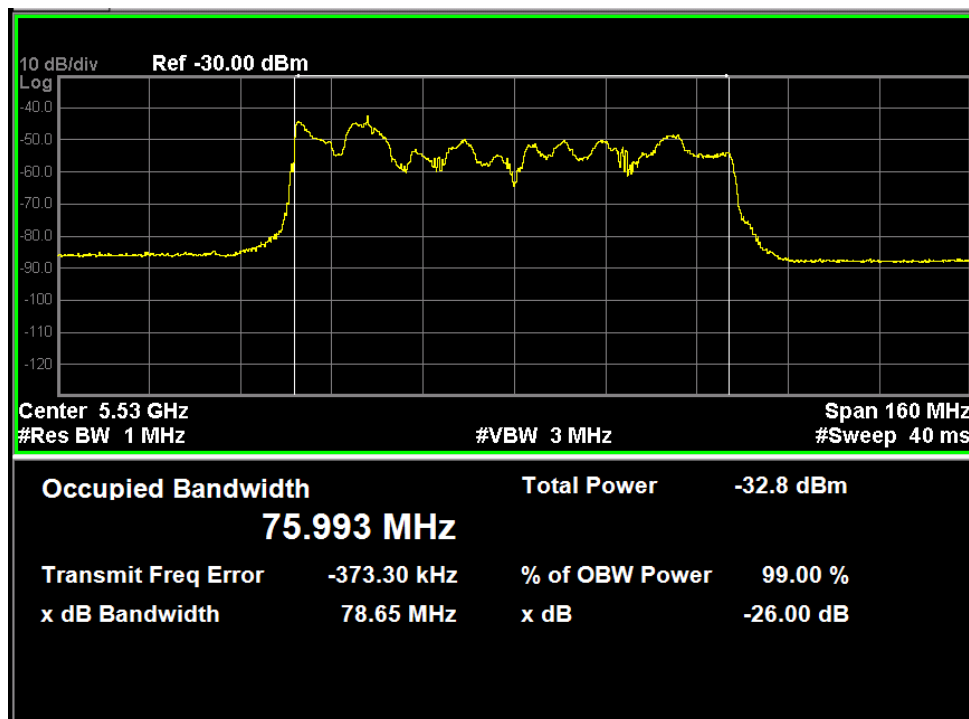
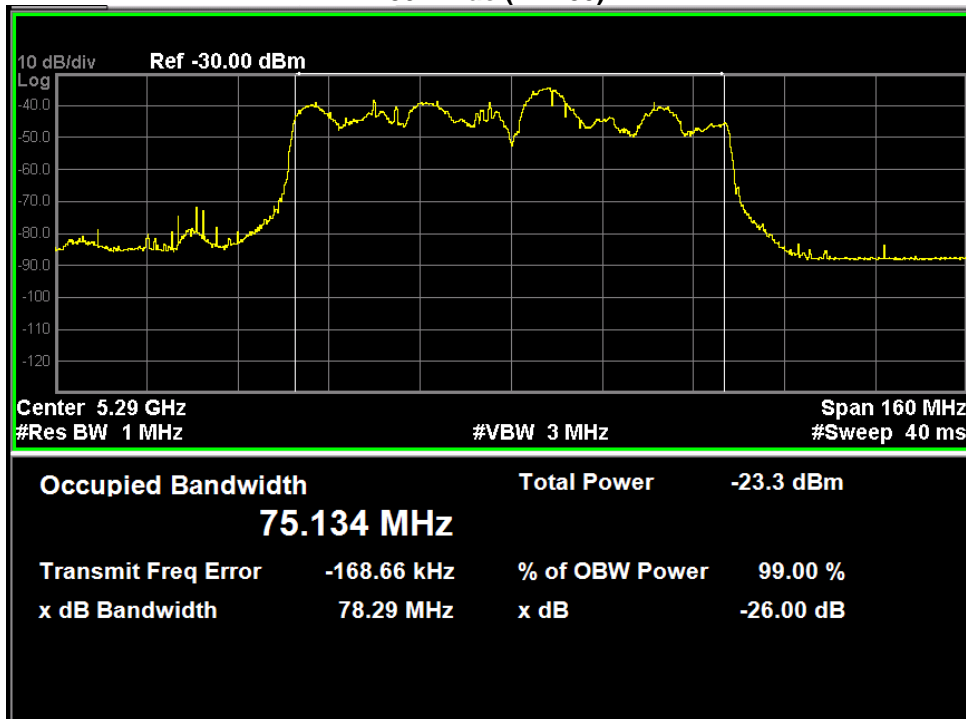

U-NII 99% Channel bandwidth

Detection Bandwidth Test - 802.11ac (VHT20)											
Radar Type 0											
EUT Frequency: 5300MHz											
EUT 99% Power bandwidth: 17.11MHz											
Detection bandwidth limit (100% of EUT 99% Power bandwidth): 17.11MHz											
Detection bandwidth (5309(FH) – 5291(FL)) : 18MHz											
Test Result : PASS											
Radar Frequency (MHz)	Trial Number / Detection										Detection Rate (%)
	1	2	3	4	5	6	7	8	9	10	
5.291G(FL)	Yes	Yes	Yes	No	Yes	Yes	Yes	Yes	Yes	Yes	90
5.292G	Yes	Yes	Yes	Yes	Yes	Yes	Yes	Yes	Yes	Yes	100
5.293G	Yes	Yes	Yes	Yes	Yes	Yes	Yes	Yes	Yes	Yes	100
5.294G	Yes	Yes	Yes	Yes	Yes	Yes	Yes	Yes	Yes	Yes	100
5.295G	Yes	Yes	Yes	Yes	Yes	Yes	Yes	Yes	Yes	Yes	100
5.296G	Yes	Yes	Yes	Yes	Yes	Yes	Yes	Yes	Yes	Yes	100
5.297G	Yes	Yes	Yes	Yes	Yes	Yes	Yes	Yes	Yes	Yes	100
5.298G	Yes	Yes	Yes	Yes	Yes	Yes	Yes	Yes	Yes	Yes	100
5.299G	Yes	Yes	Yes	Yes	Yes	Yes	Yes	Yes	Yes	Yes	100
5.300G	Yes	Yes	Yes	Yes	Yes	Yes	Yes	Yes	Yes	Yes	100
5.301G	Yes	Yes	Yes	Yes	Yes	Yes	Yes	Yes	Yes	Yes	100
5.302G	Yes	Yes	Yes	Yes	Yes	Yes	Yes	Yes	Yes	Yes	100
5.303G	Yes	Yes	Yes	Yes	Yes	Yes	Yes	Yes	Yes	Yes	100
5.304G	Yes	Yes	Yes	Yes	Yes	Yes	Yes	Yes	Yes	Yes	100
5.305G	Yes	Yes	Yes	Yes	Yes	Yes	Yes	Yes	Yes	Yes	100
5.306G	Yes	Yes	Yes	Yes	Yes	Yes	Yes	Yes	Yes	Yes	100
5.307G	Yes	Yes	Yes	Yes	Yes	Yes	Yes	Yes	Yes	Yes	100
5.308G	Yes	Yes	Yes	Yes	Yes	Yes	Yes	Yes	Yes	Yes	100
5.309G(FH)	Yes	Yes	Yes	Yes	Yes	Yes	Yes	Yes	Yes	Yes	100

Detection Bandwidth Test - 802.11ac (VHT20)

Radar Type 0

EUT Frequency: 5500MHz

EUT 99% Power bandwidth: 17.616MHz

Detection bandwidth limit (100% of EUT 99% Power bandwidth): 17.616MHz

Detection bandwidth (5509(FH) – 5491(FL)) : 18MHz

Test Result : PASS

Radar Frequency (MHz)	Trial Number / Detection										Detection Rate (%)
	1	2	3	4	5	6	7	8	9	10	
5.491G(FL)	Yes	Yes	Yes	Yes	Yes	Yes	No	Yes	Yes	Yes	90
5.492G	Yes	Yes	Yes	Yes	Yes	Yes	Yes	Yes	Yes	Yes	100
5.493G	Yes	Yes	Yes	Yes	Yes	Yes	Yes	Yes	Yes	Yes	100
5.494G	Yes	Yes	Yes	Yes	Yes	Yes	Yes	Yes	Yes	Yes	100
5.495G	Yes	Yes	Yes	Yes	Yes	Yes	Yes	Yes	Yes	Yes	100
5.496G	Yes	Yes	Yes	Yes	Yes	Yes	Yes	Yes	Yes	Yes	100
5.497G	Yes	Yes	Yes	Yes	Yes	Yes	Yes	Yes	Yes	Yes	100
5.498G	Yes	Yes	Yes	Yes	Yes	Yes	Yes	Yes	Yes	Yes	100
5.499G	Yes	Yes	Yes	Yes	Yes	Yes	Yes	Yes	Yes	Yes	100
5.500G	Yes	Yes	Yes	Yes	Yes	Yes	Yes	Yes	Yes	Yes	100
5.501G	Yes	Yes	Yes	Yes	Yes	Yes	Yes	Yes	Yes	Yes	100
5.502G	Yes	Yes	Yes	Yes	Yes	Yes	Yes	Yes	Yes	Yes	100
5.503G	Yes	Yes	Yes	Yes	Yes	Yes	Yes	Yes	Yes	Yes	100
5.504G	Yes	Yes	Yes	Yes	Yes	Yes	Yes	Yes	Yes	Yes	100
5.505G	Yes	Yes	Yes	Yes	Yes	Yes	Yes	Yes	Yes	Yes	100
5.506G	Yes	Yes	Yes	Yes	Yes	Yes	Yes	Yes	Yes	Yes	100
5.507G	Yes	Yes	Yes	Yes	Yes	Yes	Yes	Yes	Yes	Yes	100
5.508G	Yes	Yes	Yes	Yes	Yes	Yes	Yes	Yes	Yes	Yes	100
5.509G(FH)	Yes	Yes	Yes	Yes	Yes	Yes	Yes	Yes	Yes	Yes	100

Detection Bandwidth Test - 802.11ac (VHT40)											
Radar Type 0											
EUT Frequency: 5310MHz											
EUT 99% Power bandwidth: 35.895MHz											
Detection bandwidth limit (100% of EUT 99% Power bandwidth): 35.895MHz											
Detection bandwidth (5328(FH) – 5292(FL)) : 36MHz											
Test Result : PASS											
Radar Frequency (MHz)	Trial Number / Detection										Detection Rate (%)
	1	2	3	4	5	6	7	8	9	10	
5.292G(FL)	Yes	Yes	Yes	Yes	Yes	Yes	Yes	Yes	Yes	Yes	100
5.293G	Yes	Yes	Yes	Yes	Yes	Yes	Yes	Yes	Yes	Yes	100
5.294G	Yes	Yes	Yes	Yes	Yes	Yes	Yes	Yes	Yes	Yes	100
5.295G	Yes	Yes	Yes	Yes	Yes	Yes	Yes	Yes	Yes	Yes	100
5.296G	Yes	Yes	Yes	Yes	Yes	Yes	Yes	Yes	Yes	Yes	100
5.297G	Yes	Yes	Yes	Yes	Yes	Yes	Yes	Yes	Yes	Yes	100
5.298G	Yes	Yes	Yes	Yes	Yes	Yes	Yes	Yes	Yes	Yes	100
5.299G	Yes	Yes	Yes	Yes	Yes	Yes	Yes	Yes	Yes	Yes	100
5.300G	Yes	Yes	Yes	Yes	Yes	Yes	Yes	Yes	Yes	Yes	100
5.301G	Yes	Yes	Yes	Yes	Yes	Yes	Yes	Yes	Yes	Yes	100
5.302G	Yes	Yes	Yes	Yes	Yes	Yes	Yes	Yes	Yes	Yes	100
5.303G	Yes	Yes	Yes	Yes	Yes	Yes	Yes	Yes	Yes	Yes	100
5.304G	Yes	Yes	Yes	Yes	Yes	Yes	Yes	Yes	Yes	Yes	100
5.305G	Yes	Yes	Yes	Yes	Yes	Yes	Yes	Yes	Yes	Yes	100
5.306G	Yes	Yes	Yes	Yes	Yes	Yes	Yes	Yes	Yes	Yes	100
5.307G	Yes	Yes	Yes	Yes	Yes	Yes	Yes	Yes	Yes	Yes	100
5.308G	Yes	Yes	Yes	Yes	Yes	Yes	Yes	Yes	Yes	Yes	100
5.309G	Yes	Yes	Yes	Yes	Yes	Yes	Yes	Yes	Yes	Yes	100
5.310G	Yes	Yes	Yes	Yes	Yes	Yes	Yes	Yes	Yes	Yes	100
5.311G	Yes	Yes	Yes	Yes	Yes	Yes	Yes	Yes	Yes	Yes	100
5.312G	Yes	Yes	Yes	Yes	Yes	Yes	Yes	Yes	Yes	Yes	100
5.313G	Yes	Yes	Yes	Yes	Yes	Yes	Yes	Yes	Yes	Yes	100
5.314G	Yes	Yes	Yes	Yes	Yes	Yes	Yes	Yes	Yes	Yes	100
5.315G	Yes	Yes	Yes	Yes	Yes	Yes	Yes	Yes	Yes	Yes	100
5.316G	Yes	Yes	Yes	Yes	Yes	Yes	Yes	Yes	Yes	Yes	100
5.317G	Yes	Yes	Yes	Yes	Yes	Yes	Yes	Yes	Yes	Yes	100
5.318G	Yes	Yes	Yes	Yes	Yes	Yes	Yes	Yes	Yes	Yes	100
5.319G	Yes	Yes	Yes	Yes	Yes	Yes	Yes	Yes	Yes	Yes	100
5.320G	Yes	Yes	Yes	Yes	Yes	Yes	Yes	Yes	Yes	Yes	100
5.321G	Yes	Yes	Yes	Yes	Yes	Yes	Yes	Yes	Yes	Yes	100
5.322G	Yes	Yes	Yes	Yes	Yes	Yes	Yes	Yes	Yes	Yes	100
5.323G	Yes	Yes	Yes	Yes	Yes	Yes	Yes	Yes	Yes	Yes	100
5.324G	Yes	Yes	Yes	Yes	Yes	Yes	Yes	Yes	Yes	Yes	100
5.325G	Yes	Yes	Yes	Yes	Yes	Yes	Yes	Yes	Yes	Yes	100
5.326G	Yes	Yes	Yes	Yes	Yes	Yes	Yes	Yes	Yes	Yes	100
5.327G	Yes	Yes	Yes	Yes	Yes	Yes	Yes	Yes	Yes	Yes	100
5.328G(FH)	Yes	Yes	Yes	Yes	Yes	Yes	Yes	Yes	Yes	Yes	100

Detection Bandwidth Test - 802.11ac (VHT40)

Radar Type 0

EUT Frequency: 5510MHz

EUT 99% Power bandwidth: 36.175MHz

Detection bandwidth limit (100% of EUT 99% Power bandwidth): 36.175MHz

Detection bandwidth (5529(FH) – 5491(FL)) : 38MHz

Test Result : PASS

Radar Frequency (MHz)	Trial Number / Detection										Detection Rate (%)
	1	2	3	4	5	6	7	8	9	10	
5491(FL)	Yes	No	Yes	Yes	Yes	Yes	Yes	Yes	Yes	Yes	90
5492	Yes	Yes	Yes	Yes	Yes	Yes	Yes	Yes	Yes	Yes	100
5493	Yes	Yes	Yes	Yes	Yes	Yes	Yes	Yes	Yes	Yes	100
5494	Yes	Yes	Yes	Yes	Yes	Yes	Yes	Yes	Yes	Yes	100
5495	Yes	Yes	Yes	Yes	Yes	Yes	Yes	Yes	Yes	Yes	100
5496	Yes	Yes	Yes	Yes	Yes	Yes	Yes	Yes	Yes	Yes	100
5497	Yes	Yes	Yes	Yes	Yes	Yes	Yes	Yes	Yes	Yes	100
5498	Yes	Yes	Yes	Yes	Yes	Yes	Yes	Yes	Yes	Yes	100
5499	Yes	Yes	Yes	Yes	Yes	Yes	Yes	Yes	Yes	Yes	100
5500	Yes	Yes	Yes	Yes	Yes	Yes	Yes	Yes	Yes	Yes	100
5501	Yes	Yes	Yes	Yes	Yes	Yes	Yes	Yes	Yes	Yes	100
5502	Yes	Yes	Yes	Yes	Yes	Yes	Yes	Yes	Yes	Yes	100
5503	Yes	Yes	Yes	Yes	Yes	Yes	Yes	Yes	Yes	Yes	100
5504	Yes	Yes	Yes	Yes	Yes	Yes	Yes	Yes	Yes	Yes	100
5505	Yes	Yes	Yes	Yes	Yes	Yes	Yes	Yes	Yes	Yes	100
5506	Yes	Yes	Yes	Yes	Yes	Yes	Yes	Yes	Yes	Yes	100
5507	Yes	Yes	Yes	Yes	Yes	Yes	Yes	Yes	Yes	Yes	100
5508	Yes	Yes	Yes	Yes	Yes	Yes	Yes	Yes	Yes	Yes	100
5509	Yes	Yes	Yes	Yes	Yes	Yes	Yes	Yes	Yes	Yes	100
5510	Yes	Yes	Yes	Yes	Yes	Yes	Yes	Yes	Yes	Yes	100
5511	Yes	Yes	Yes	Yes	Yes	Yes	Yes	Yes	Yes	Yes	100
5512	Yes	Yes	Yes	Yes	Yes	Yes	Yes	Yes	Yes	Yes	100
5513	Yes	Yes	Yes	Yes	Yes	Yes	Yes	Yes	Yes	Yes	100
5514	Yes	Yes	Yes	Yes	Yes	Yes	Yes	Yes	Yes	Yes	100
5515	Yes	Yes	Yes	Yes	Yes	Yes	Yes	Yes	Yes	Yes	100
5516	Yes	Yes	Yes	Yes	Yes	Yes	Yes	Yes	Yes	Yes	100
5517	Yes	Yes	Yes	Yes	Yes	Yes	Yes	Yes	Yes	Yes	100
5518	Yes	Yes	Yes	Yes	Yes	Yes	Yes	Yes	Yes	Yes	100
5519	Yes	Yes	Yes	Yes	Yes	Yes	Yes	Yes	Yes	Yes	100
5520	Yes	Yes	Yes	Yes	Yes	Yes	Yes	Yes	Yes	Yes	100
5521	Yes	Yes	Yes	Yes	Yes	Yes	Yes	Yes	Yes	Yes	100
5522	Yes	Yes	Yes	Yes	Yes	Yes	Yes	Yes	Yes	Yes	100
5523	Yes	Yes	Yes	Yes	Yes	Yes	Yes	Yes	Yes	Yes	100
5524	Yes	Yes	Yes	Yes	Yes	Yes	Yes	Yes	Yes	Yes	100
5525	Yes	Yes	Yes	Yes	Yes	Yes	Yes	Yes	Yes	Yes	100
5526	Yes	Yes	Yes	Yes	Yes	Yes	Yes	Yes	Yes	Yes	100
5527	Yes	Yes	Yes	Yes	Yes	Yes	Yes	Yes	Yes	Yes	100
5528	Yes	Yes	No	Yes	Yes	Yes	Yes	Yes	Yes	Yes	90
5529(FH)	Yes	Yes	Yes	Yes	Yes	Yes	Yes	Yes	No	Yes	90

Detection Bandwidth Test - **802.11ac (VHT80)**
 Radar Type 0
 EUT Frequency: 5290MHz
 EUT 99% Power bandwidth: 75.134MHz
 Detection bandwidth limit (100% of EUT 99% Power bandwidth): 75.134MHz
 Detection bandwidth (5328(FH) – 5252(FL)) : 76MHz
 Test Result : PASS

Radar Frequency (MHz)	Trial Number / Detection										Detection Rate (%)
	1	2	3	4	5	6	7	8	9	10	
5252(FL)	Yes	No	Yes	Yes	Yes	Yes	Yes	Yes	Yes	Yes	90
5253	Yes	Yes	Yes	Yes	Yes	Yes	Yes	Yes	Yes	Yes	100
5254	Yes	Yes	Yes	Yes	Yes	Yes	Yes	Yes	Yes	Yes	100
5255	Yes	Yes	Yes	Yes	Yes	Yes	Yes	Yes	Yes	Yes	100
5256	Yes	Yes	Yes	Yes	Yes	Yes	Yes	Yes	Yes	Yes	100
5257	Yes	Yes	Yes	Yes	Yes	Yes	Yes	Yes	Yes	Yes	100
5258	Yes	Yes	Yes	Yes	Yes	Yes	Yes	Yes	Yes	Yes	100
5259	Yes	Yes	Yes	Yes	Yes	Yes	Yes	Yes	Yes	Yes	100
5260	Yes	Yes	Yes	Yes	Yes	Yes	Yes	Yes	Yes	Yes	100
5261	Yes	Yes	Yes	Yes	Yes	Yes	Yes	Yes	Yes	Yes	100
5262	Yes	Yes	Yes	Yes	Yes	Yes	Yes	Yes	Yes	Yes	100
5263	Yes	Yes	Yes	Yes	Yes	Yes	Yes	Yes	Yes	Yes	100
5264	Yes	Yes	Yes	Yes	Yes	Yes	Yes	Yes	Yes	Yes	100
5265	Yes	Yes	Yes	Yes	Yes	Yes	Yes	Yes	Yes	Yes	100
5266	Yes	Yes	Yes	Yes	Yes	Yes	Yes	Yes	Yes	Yes	100
5267	Yes	Yes	Yes	Yes	Yes	Yes	Yes	Yes	Yes	Yes	100
5268	Yes	Yes	Yes	Yes	Yes	Yes	Yes	Yes	Yes	Yes	100
5269	Yes	Yes	Yes	Yes	Yes	Yes	Yes	Yes	Yes	Yes	100
5270	Yes	Yes	Yes	Yes	Yes	Yes	Yes	Yes	Yes	Yes	100
5271	Yes	Yes	Yes	Yes	Yes	Yes	Yes	Yes	Yes	Yes	100
5272	Yes	Yes	Yes	Yes	Yes	Yes	Yes	Yes	Yes	Yes	100
5273	Yes	Yes	Yes	Yes	Yes	Yes	Yes	Yes	Yes	Yes	100
5274	Yes	Yes	Yes	Yes	Yes	Yes	Yes	Yes	Yes	Yes	100
5275	Yes	Yes	Yes	Yes	Yes	Yes	Yes	Yes	Yes	Yes	100
5276	Yes	Yes	Yes	Yes	Yes	Yes	Yes	Yes	Yes	Yes	100
5277	Yes	Yes	Yes	Yes	Yes	Yes	Yes	Yes	Yes	Yes	100
5278	Yes	Yes	Yes	Yes	Yes	Yes	Yes	Yes	Yes	Yes	100
5279	Yes	Yes	Yes	Yes	Yes	Yes	Yes	Yes	Yes	Yes	100
5280	Yes	Yes	Yes	Yes	Yes	Yes	Yes	Yes	Yes	Yes	100
5281	Yes	Yes	Yes	Yes	Yes	Yes	Yes	Yes	Yes	Yes	100
5282	Yes	Yes	Yes	Yes	Yes	Yes	Yes	Yes	Yes	Yes	100
5283	Yes	Yes	Yes	Yes	Yes	Yes	Yes	Yes	Yes	Yes	100
5284	Yes	Yes	Yes	Yes	Yes	Yes	Yes	Yes	Yes	Yes	100
5285	Yes	Yes	Yes	Yes	Yes	Yes	Yes	Yes	Yes	Yes	100
5286	Yes	Yes	Yes	Yes	Yes	Yes	Yes	Yes	Yes	Yes	100
5287	Yes	Yes	Yes	Yes	Yes	Yes	Yes	Yes	Yes	Yes	100
5288	Yes	Yes	Yes	Yes	Yes	Yes	Yes	Yes	Yes	Yes	100
5289	Yes	Yes	Yes	Yes	Yes	Yes	Yes	Yes	Yes	Yes	100
5290	Yes	Yes	Yes	Yes	Yes	Yes	Yes	Yes	Yes	Yes	100
5291	Yes	Yes	Yes	Yes	Yes	Yes	Yes	Yes	Yes	Yes	100
5292	Yes	Yes	Yes	Yes	Yes	Yes	Yes	Yes	Yes	Yes	100
5293	Yes	Yes	Yes	Yes	Yes	Yes	Yes	Yes	Yes	Yes	100
5294	Yes	Yes	Yes	Yes	Yes	Yes	Yes	Yes	Yes	Yes	100
5295	Yes	Yes	Yes	Yes	Yes	Yes	Yes	Yes	Yes	Yes	100
5296	Yes	Yes	Yes	Yes	Yes	Yes	Yes	Yes	Yes	Yes	100

5297	Yes	Yes	Yes	Yes	Yes	Yes	Yes	Yes	Yes	Yes	100
5298	Yes	Yes	Yes	Yes	Yes	Yes	Yes	Yes	Yes	Yes	100
5299	Yes	Yes	Yes	Yes	Yes	Yes	Yes	Yes	Yes	Yes	100
5300	Yes	Yes	Yes	Yes	Yes	Yes	Yes	Yes	Yes	Yes	100
5301	Yes	Yes	Yes	Yes	Yes	Yes	Yes	Yes	Yes	Yes	100
5302	Yes	Yes	Yes	Yes	Yes	Yes	Yes	Yes	Yes	Yes	100
5303	Yes	Yes	Yes	Yes	Yes	Yes	Yes	Yes	Yes	Yes	100
5304	Yes	Yes	Yes	Yes	Yes	Yes	Yes	Yes	Yes	Yes	100
5305	Yes	Yes	Yes	Yes	Yes	Yes	Yes	Yes	Yes	Yes	100
5306	Yes	Yes	Yes	Yes	Yes	Yes	Yes	Yes	Yes	Yes	100
5307	Yes	Yes	Yes	Yes	Yes	Yes	Yes	Yes	Yes	Yes	100
5308	Yes	Yes	Yes	Yes	Yes	Yes	Yes	Yes	Yes	Yes	100
5309	Yes	Yes	Yes	Yes	Yes	Yes	Yes	Yes	Yes	Yes	100
5310	Yes	Yes	Yes	Yes	Yes	Yes	Yes	Yes	Yes	Yes	100
5311	Yes	Yes	Yes	Yes	Yes	Yes	Yes	Yes	Yes	Yes	100
5312	Yes	Yes	Yes	Yes	Yes	Yes	Yes	Yes	Yes	Yes	100
5313	Yes	Yes	Yes	Yes	Yes	Yes	Yes	Yes	Yes	Yes	100
5314	Yes	Yes	Yes	Yes	Yes	Yes	Yes	Yes	Yes	Yes	100
5315	Yes	Yes	Yes	Yes	Yes	Yes	Yes	Yes	Yes	Yes	100
5316	Yes	Yes	Yes	Yes	Yes	Yes	Yes	Yes	Yes	Yes	100
5317	Yes	Yes	Yes	Yes	Yes	Yes	Yes	Yes	Yes	Yes	100
5318	Yes	Yes	Yes	Yes	Yes	Yes	Yes	Yes	Yes	Yes	100
5319	Yes	Yes	Yes	Yes	Yes	Yes	Yes	Yes	Yes	Yes	100
5320	Yes	Yes	Yes	Yes	Yes	Yes	Yes	Yes	Yes	Yes	100
5321	Yes	Yes	Yes	Yes	Yes	Yes	Yes	Yes	Yes	Yes	100
5322	Yes	Yes	Yes	Yes	Yes	Yes	Yes	Yes	Yes	Yes	100
5323	Yes	Yes	Yes	Yes	Yes	Yes	Yes	Yes	Yes	Yes	100
5324	Yes	Yes	Yes	Yes	Yes	Yes	Yes	Yes	Yes	Yes	100
5325	Yes	Yes	Yes	Yes	Yes	Yes	Yes	Yes	Yes	Yes	100
5326	Yes	Yes	Yes	Yes	Yes	Yes	Yes	Yes	Yes	Yes	100
5327	Yes	Yes	Yes	Yes	Yes	Yes	Yes	Yes	Yes	Yes	100
5328(FH)	Yes	Yes	Yes	Yes	Yes	Yes	Yes	Yes	Yes	Yes	100

Detection Bandwidth Test - 802.11ac (VHT80)											
Radar Type 0											
EUT Frequency: 5530MHz											
EUT 99% Power bandwidth: 75.993MHz											
Detection bandwidth limit (100% of EUT 99% Power bandwidth): 75.993MHz											
Detection bandwidth (5568(FH) – 5492(FL)) : 76MHz											
Test Result : PASS											
Radar Frequency (MHz)	Trial Number / Detection										Detection Rate (%)
	1	2	3	4	5	6	7	8	9	10	
5492(FL)	Yes	No	Yes	Yes	Yes	Yes	Yes	Yes	Yes	Yes	90
5493	Yes	Yes	Yes	Yes	Yes	Yes	Yes	Yes	Yes	Yes	100
5494	Yes	Yes	Yes	Yes	Yes	Yes	Yes	Yes	Yes	Yes	100
5495	Yes	Yes	Yes	Yes	Yes	Yes	Yes	Yes	Yes	Yes	100
5496	Yes	Yes	Yes	Yes	Yes	Yes	Yes	Yes	Yes	Yes	100
5497	Yes	Yes	Yes	Yes	Yes	Yes	Yes	Yes	Yes	Yes	100
5498	Yes	Yes	Yes	Yes	Yes	Yes	Yes	Yes	Yes	Yes	100
5499	Yes	Yes	Yes	Yes	Yes	Yes	Yes	Yes	Yes	Yes	100
5500	Yes	Yes	Yes	Yes	Yes	Yes	Yes	Yes	Yes	Yes	100
5501	Yes	Yes	Yes	Yes	Yes	Yes	Yes	Yes	Yes	Yes	100
5502	Yes	Yes	Yes	Yes	Yes	Yes	Yes	Yes	Yes	Yes	100
5503	Yes	Yes	Yes	Yes	Yes	Yes	Yes	Yes	Yes	Yes	100
5504	Yes	Yes	Yes	Yes	Yes	Yes	Yes	Yes	Yes	Yes	100
5505	Yes	Yes	Yes	Yes	Yes	Yes	Yes	Yes	Yes	Yes	100
5506	Yes	Yes	Yes	Yes	Yes	Yes	Yes	Yes	Yes	Yes	100
5507	Yes	Yes	Yes	Yes	Yes	Yes	Yes	Yes	Yes	Yes	100
5508	Yes	Yes	Yes	Yes	Yes	Yes	Yes	Yes	Yes	Yes	100
5509	Yes	Yes	Yes	Yes	Yes	Yes	Yes	Yes	Yes	Yes	100
5510	Yes	Yes	Yes	Yes	Yes	Yes	Yes	Yes	Yes	Yes	100
5511	Yes	Yes	Yes	Yes	Yes	Yes	Yes	Yes	Yes	Yes	100
5512	Yes	Yes	Yes	Yes	Yes	Yes	Yes	Yes	Yes	Yes	100
5513	Yes	Yes	Yes	Yes	Yes	Yes	Yes	Yes	Yes	Yes	100
5514	Yes	Yes	Yes	Yes	Yes	Yes	Yes	Yes	Yes	Yes	100
5515	Yes	Yes	Yes	Yes	Yes	Yes	Yes	Yes	Yes	Yes	100
5516	Yes	Yes	Yes	Yes	Yes	Yes	Yes	Yes	Yes	Yes	100
5517	Yes	Yes	Yes	Yes	Yes	Yes	Yes	Yes	Yes	Yes	100
5518	Yes	Yes	Yes	Yes	Yes	Yes	Yes	Yes	Yes	Yes	100
5519	Yes	Yes	Yes	Yes	Yes	Yes	Yes	Yes	Yes	Yes	100
5520	Yes	Yes	Yes	Yes	Yes	Yes	Yes	Yes	Yes	Yes	100
5521	Yes	Yes	Yes	Yes	Yes	Yes	Yes	Yes	Yes	Yes	100
5522	Yes	Yes	Yes	Yes	Yes	Yes	Yes	Yes	Yes	Yes	100
5523	Yes	Yes	Yes	Yes	Yes	Yes	Yes	Yes	Yes	Yes	100
5524	Yes	Yes	Yes	Yes	Yes	Yes	Yes	Yes	Yes	Yes	100
5525	Yes	Yes	Yes	Yes	Yes	Yes	Yes	Yes	Yes	Yes	100
5526	Yes	Yes	Yes	Yes	Yes	Yes	Yes	Yes	Yes	Yes	100
5527	Yes	Yes	Yes	Yes	Yes	Yes	Yes	Yes	Yes	Yes	100
5528	Yes	Yes	Yes	Yes	Yes	Yes	Yes	Yes	Yes	Yes	100
5529	Yes	Yes	Yes	Yes	Yes	Yes	Yes	Yes	Yes	Yes	100
5530	Yes	Yes	Yes	Yes	Yes	Yes	Yes	Yes	Yes	Yes	100
5531	Yes	Yes	Yes	Yes	Yes	Yes	Yes	Yes	Yes	Yes	100
5532	Yes	Yes	Yes	Yes	Yes	Yes	Yes	Yes	Yes	Yes	100
5533	Yes	Yes	Yes	Yes	Yes	Yes	Yes	Yes	Yes	Yes	100
5534	Yes	Yes	Yes	Yes	Yes	Yes	Yes	Yes	Yes	Yes	100
5535	Yes	Yes	Yes	Yes	Yes	Yes	Yes	Yes	Yes	Yes	100
5536	Yes	Yes	Yes	Yes	Yes	Yes	Yes	Yes	Yes	Yes	100

5537	Yes	Yes	Yes	Yes	Yes	Yes	Yes	Yes	Yes	Yes	100
5538	Yes	Yes	Yes	Yes	Yes	Yes	Yes	Yes	Yes	Yes	100
5539	Yes	Yes	Yes	Yes	Yes	Yes	Yes	Yes	Yes	Yes	100
5540	Yes	Yes	Yes	Yes	Yes	Yes	Yes	Yes	Yes	Yes	100
5541	Yes	Yes	Yes	Yes	Yes	Yes	Yes	Yes	Yes	Yes	100
5542	Yes	Yes	Yes	Yes	Yes	Yes	Yes	Yes	Yes	Yes	100
5543	Yes	Yes	Yes	Yes	Yes	Yes	Yes	Yes	Yes	Yes	100
5544	Yes	Yes	Yes	Yes	Yes	Yes	Yes	Yes	Yes	Yes	100
5545	Yes	Yes	Yes	Yes	Yes	Yes	Yes	Yes	Yes	Yes	100
5546	Yes	Yes	Yes	Yes	Yes	Yes	Yes	Yes	Yes	Yes	100
5547	Yes	Yes	Yes	Yes	Yes	Yes	Yes	Yes	Yes	Yes	100
5548	Yes	Yes	Yes	Yes	Yes	Yes	Yes	Yes	Yes	Yes	100
5549	Yes	Yes	Yes	Yes	Yes	Yes	Yes	Yes	Yes	Yes	100
5550	Yes	Yes	Yes	Yes	Yes	Yes	Yes	Yes	Yes	Yes	100
5551	Yes	Yes	Yes	Yes	Yes	Yes	Yes	Yes	Yes	Yes	100
5552	Yes	Yes	Yes	Yes	Yes	Yes	Yes	Yes	Yes	Yes	100
5553	Yes	Yes	Yes	Yes	Yes	Yes	Yes	Yes	Yes	Yes	100
5554	Yes	Yes	Yes	Yes	Yes	Yes	Yes	Yes	Yes	Yes	100
5555	Yes	Yes	Yes	Yes	Yes	Yes	Yes	Yes	Yes	Yes	100
5556	Yes	Yes	Yes	Yes	Yes	Yes	Yes	Yes	Yes	Yes	100
5557	Yes	Yes	Yes	Yes	Yes	Yes	Yes	Yes	Yes	Yes	100
5558	Yes	Yes	Yes	Yes	Yes	Yes	Yes	Yes	Yes	Yes	100
5559	Yes	Yes	Yes	Yes	Yes	Yes	Yes	Yes	Yes	Yes	100
5560	Yes	Yes	Yes	Yes	Yes	Yes	Yes	Yes	Yes	Yes	100
5561	Yes	Yes	Yes	Yes	Yes	Yes	Yes	Yes	Yes	Yes	100
5562	Yes	Yes	Yes	Yes	Yes	Yes	Yes	Yes	Yes	Yes	100
5563	Yes	Yes	Yes	Yes	Yes	Yes	Yes	Yes	Yes	Yes	100
5564	Yes	Yes	Yes	Yes	Yes	Yes	Yes	Yes	Yes	Yes	100
5565	Yes	Yes	Yes	Yes	Yes	Yes	Yes	Yes	Yes	Yes	100
5566	Yes	Yes	Yes	Yes	Yes	Yes	Yes	Yes	Yes	Yes	100
5567	Yes	Yes	Yes	Yes	Yes	Yes	Yes	Yes	Yes	Yes	100
5568(FH)	Yes	Yes	Yes	Yes	Yes	Yes	Yes	Yes	Yes	Yes	100

6.2.3 Channel Availability Check Time

If the EUT successfully detected the radar burst, it should be observed as the EUT has no transmissions occurred until the EUT starts transmitting on another channel.

Timing of Radar Signal	Observation	
	EUT	Spectrum Analyzer
Within 1 to 6 second	Detected	No transmissions
Within 54 to 60 second	Detected	No transmissions

Initial Channel Availability Check Time

Channel Availability Check @ CH58 - 5290MHz

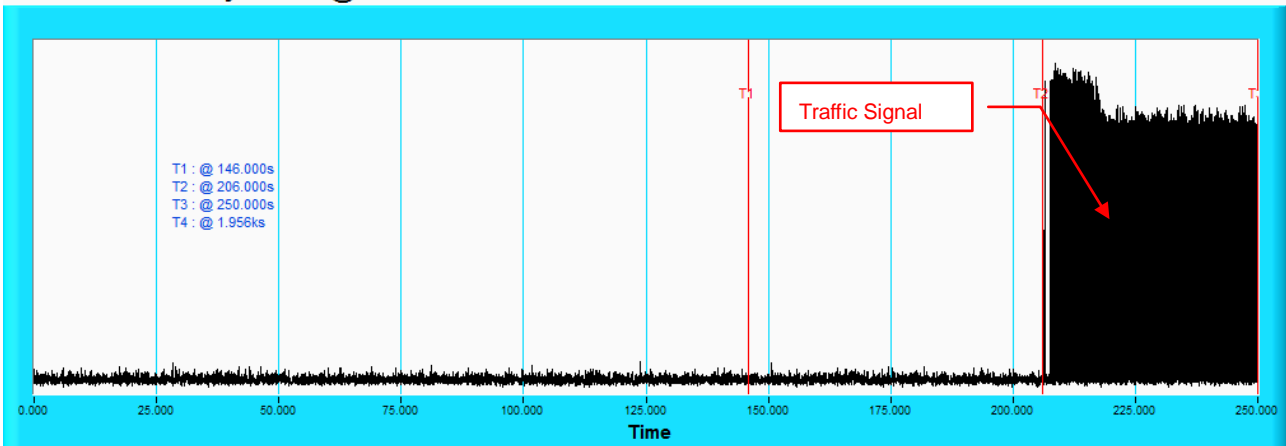

NOTE: T1 denotes the end of power-up time period is 146th second. T2 denotes the end of Channel Availability Check time is 206th second. Channel Availability Check time is equal to (T2 – T1) 60 seconds

Radar Burst at the Beginning of the Channel Availability Check Time

Channel Availability Check @ CH58 - 5290MHz

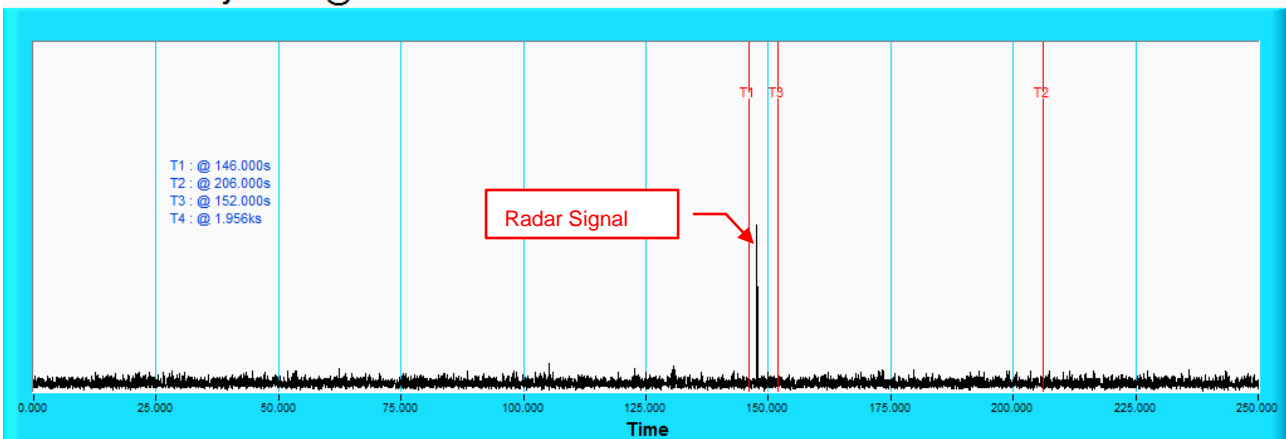

NOTE: T1 denotes the end of power up time period is 146th second. T3 denotes 152th second and the radar burst was commenced within a 6 second window starting from the end of power-up sequence. T2 denotes the 206th second.

Radar Burst at the End of the Channel Availability Check Time

Channel Availability Check @ CH58 - 5290MHz

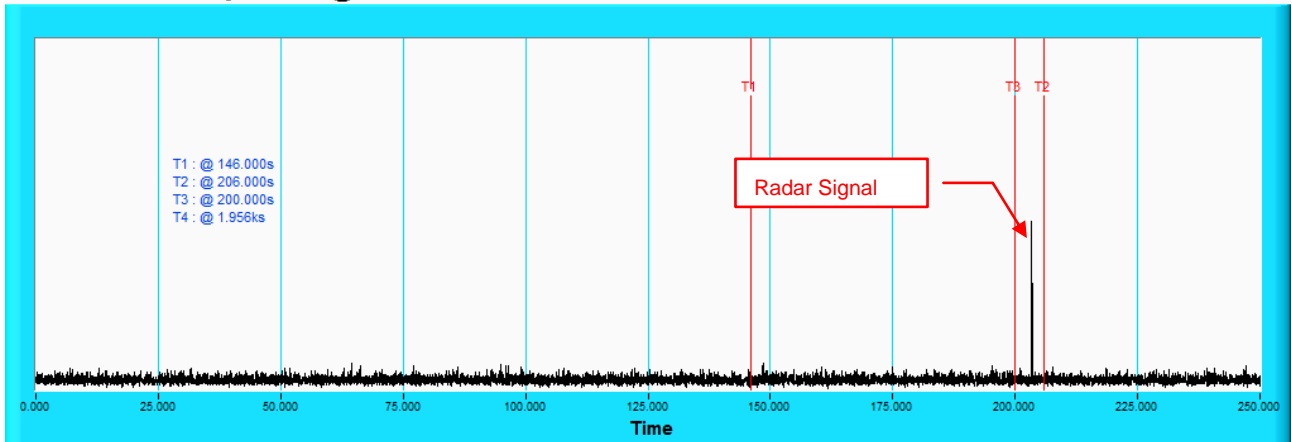

NOTE: T1 denotes the end of power up time period is 146th second. T3 denotes 200th second and the radar burst was commenced within 54th second to 60th second window starting from the end of power-up sequence. T2 denotes the 206th second.

Initial Channel Availability Check Time

Channel Availability Check @ CH106 - 5530MHz

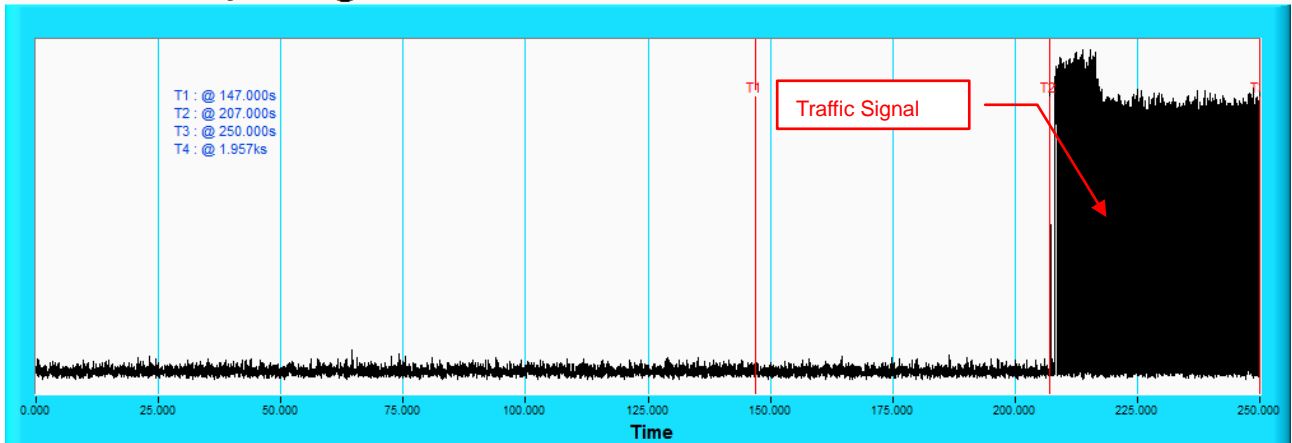

NOTE: T1 denotes the end of power-up time period is 147th second. T2 denotes the end of Channel Availability Check time is 207th second. Channel Availability Check time is equal to (T2 – T1) 60 seconds.

Radar Burst at the Beginning of the Channel Availability Check Time

Channel Availability Check @ CH106 - 5530MHz

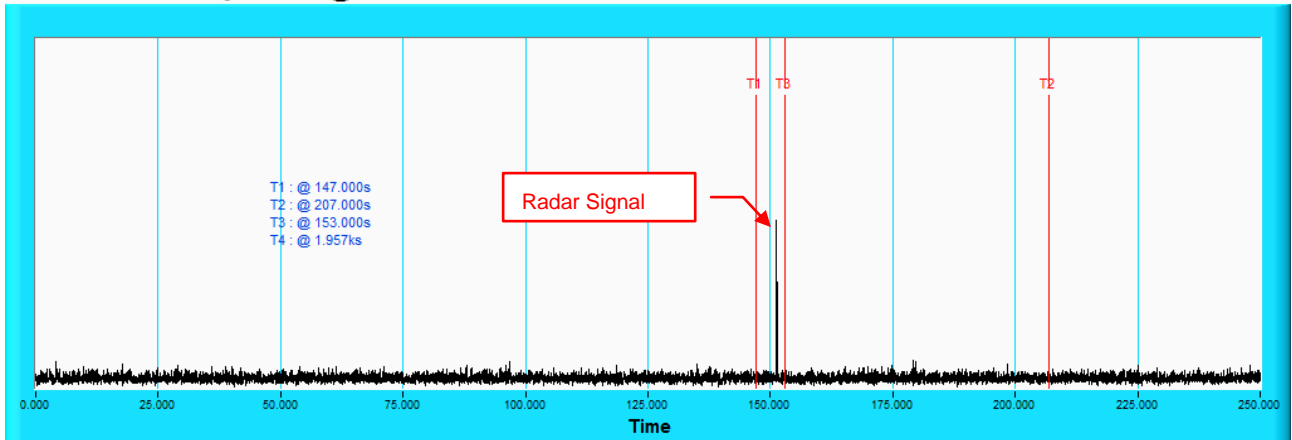

NOTE: T1 denotes the end of power up time period is 147th second. T3 denotes 153th second and the radar burst was commenced within a 6 second window starting from the end of power-up sequence. T2 denotes the 207th second.

Radar Burst at the End of the Channel Availability Check Time

Channel Availability Check @ CH106 - 5530MHz

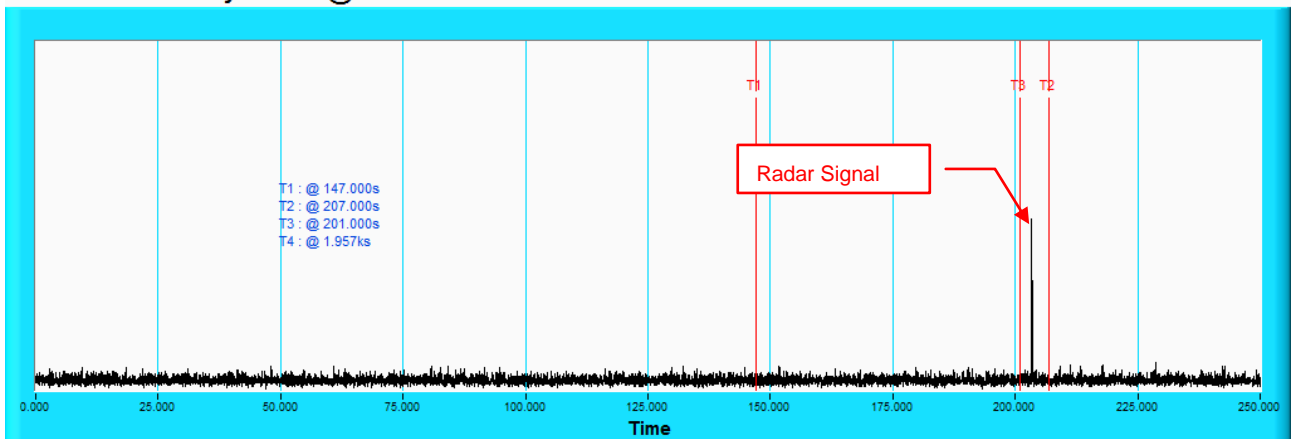

NOTE: T1 denotes the end of power up time period is 147th second. T3 denotes 201th second and the radar burst was commenced within 54th second to 60th second window starting from the end of power-up sequence. T2 denotes the 207th second.

6.2.4 Channel Closing Transmission and Channel Move Time

Wireless Traffic Loading

802.11ac (VHT20)

Duty Cycle

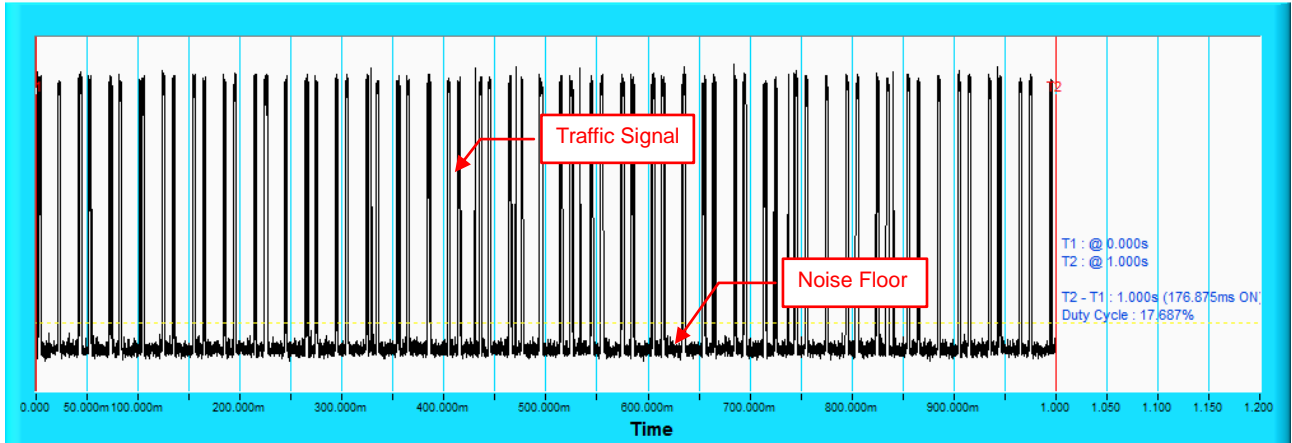

802.11ac (VHT40)

Duty Cycle

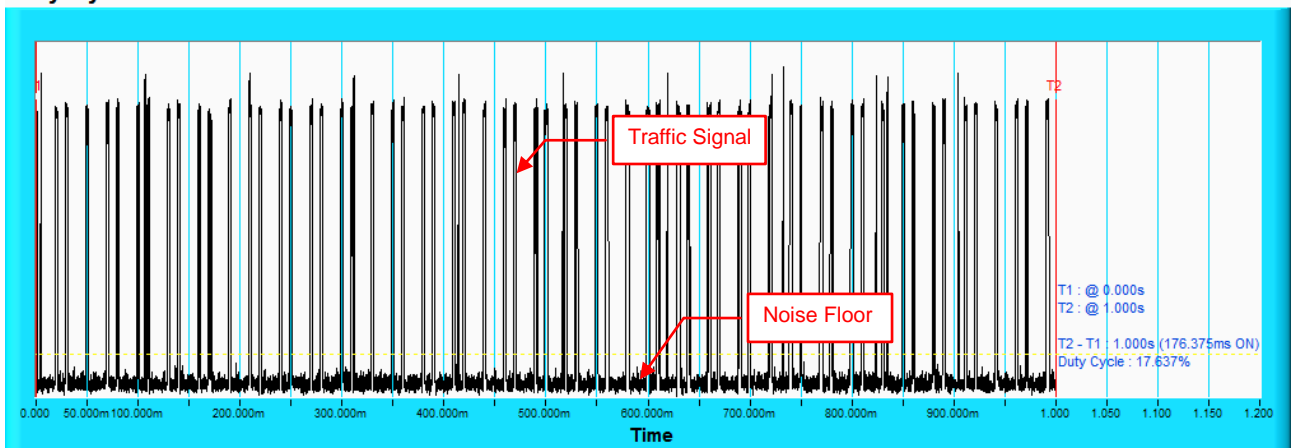

802.11ac (VHT80)

Duty Cycle

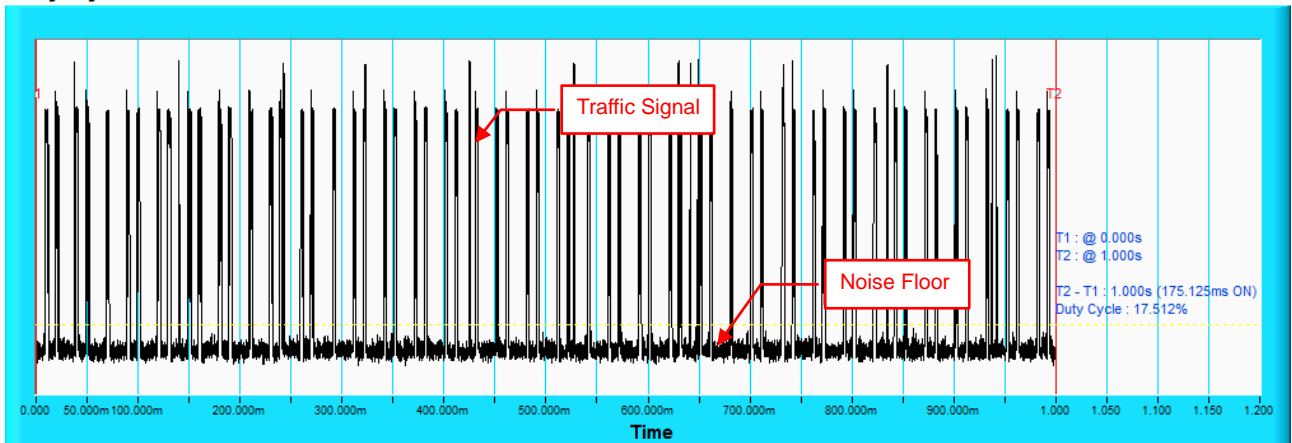

802.11ac (VHT20) CH60

Table 1: Short Pulse Radar Test Waveforms.

Radar Type	Pulse Width (μsec)	PRI (μsec)	Number of Pulses	Number of Trials(Times)	Percentage of Successful Detection (%)
1	Test A: 15 unique PRI values randomly selected from the list of 23 PRI values in Table 5a	Roundup $\left\{ \left\{ \frac{1}{360} \right\} \cdot \left\{ \frac{19 \cdot 10^6}{\text{PRI}_{\mu \text{ sec}}} \right\} \right\}$	18	30	93.3
	Test B: 15 unique PRI values randomly selected within the range of 518~3066μ sec with a minimum of 1μ sec, excluding PRI values selected in Test A				
2	1-5	150-230	23-29	30	80
3	6-10	200-500	16-18	30	80
4	11-20	200-500	12-16	30	76.7
Aggregate (Radar Types 1-4)				120	82.5

Table 2: Long Pulse Radar Test Waveform

Radar Type	Pulse Width (μsec)	Chirp Width (MHz)	PRI (μsec)	Number of Pulses per Burst	Number of Bursts	Number of Trials(Times)	Percentage of Successful Detection (%)
5	50-100	5-20	1000-2000	1-3	8-20	30	83.3

Table 3: Frequency Hopping Radar Test Waveform

Radar Type	Pulse Width (μsec)	PRI (μsec)	Pulses per Hop	Hopping Rate (kHz)	Hopping Sequence Length (msec)	Number of Trials(Times)	Percentage of Successful Detection (%)
6	1	333	9	0.333	300	30	86.7

802.11ac (VHT20) CH100

Table 1: Short Pulse Radar Test Waveforms.

Radar Type	Pulse Width (μsec)	PRI (μsec)	Number of Pulses	Number of Trials(Times)	Percentage of Successful Detection (%)
1	Test A: 15 unique PRI values randomly selected from the list of 23 PRI values in Table 5a	Roundup $\left\{ \left(\frac{1}{360} \right) \cdot \left(\frac{19 \cdot 10^6}{\text{PRI}_{\mu \text{ sec}}} \right) \right\}$	18	30	93.3
	Test B: 15 unique PRI values randomly selected within the range of 518~3066μ sec with a minimum of 1μ sec, excluding PRI values selected in Test A				
2	1-5	150-230	23-29	30	90
3	6-10	200-500	16-18	30	93.3
4	11-20	200-500	12-16	30	83.3
Aggregate (Radar Types 1-4)				120	90

Table 2: Long Pulse Radar Test Waveform

Radar Type	Pulse Width (μsec)	Chirp Width (MHz)	PRI (μsec)	Number of Pulses per Burst	Number of Bursts	Number of Trials(Times)	Percentage of Successful Detection (%)
5	50-100	5-20	1000-2000	1-3	8-20	30	90

Table 3: Frequency Hopping Radar Test Waveform

Radar Type	Pulse Width (μsec)	PRI (μsec)	Pulses per Hop	Hopping Rate (kHz)	Hopping Sequence Length (msec)	Number of Trials(Times)	Percentage of Successful Detection (%)
6	1	333	9	0.333	300	30	86.7

802.11ac (VHT40) CH62

Table 1: Short Pulse Radar Test Waveforms.

Radar Type	Pulse Width (μsec)	PRI (μsec)	Number of Pulses	Number of Trials(Times)	Percentage of Successful Detection (%)
1	Test A: 15 unique PRI values randomly selected from the list of 23 PRI values in Table 5a	Roundup $\left\{ \left(\frac{1}{360} \right) \cdot \left(\frac{19 \cdot 10^6}{\text{PRI}_{\mu \text{ sec}}} \right) \right\}$	18	30	86.7
	Test B: 15 unique PRI values randomly selected within the range of 518~3066μ sec with a minimum of 1μ sec, excluding PRI values selected in Test A				
2	1-5	150-230	23-29	30	93.3
3	6-10	200-500	16-18	30	80
4	11-20	200-500	12-16	30	80
Aggregate (Radar Types 1-4)				120	85

Table 2: Long Pulse Radar Test Waveform

Radar Type	Pulse Width (μsec)	Chirp Width (MHz)	PRI (μsec)	Number of Pulses per Burst	Number of Bursts	Number of Trials(Times)	Percentage of Successful Detection (%)
5	50-100	5-20	1000-2000	1-3	8-20	30	86.7

Table 3: Frequency Hopping Radar Test Waveform

Radar Type	Pulse Width (μsec)	PRI (μsec)	Pulses per Hop	Hopping Rate (kHz)	Hopping Sequence Length (msec)	Number of Trials(Times)	Percentage of Successful Detection (%)
6	1	333	9	0.333	300	30	90

802.11ac (VHT40) CH102

Table 1: Short Pulse Radar Test Waveforms.

Radar Type	Pulse Width (μsec)	PRI (μsec)	Number of Pulses	Number of Trials(Times)	Percentage of Successful Detection (%)
1	Test A: 15 unique PRI values randomly selected from the list of 23 PRI values in Table 5a	Roundup $\left\{ \left(\frac{1}{360} \right) \cdot \left(\frac{19 \cdot 10^6}{\text{PRI}_{\mu \text{sec}}} \right) \right\}$	18	30	90
	Test B: 15 unique PRI values randomly selected within the range of 518~3066μ sec with a minimum of 1μ sec, excluding PRI values selected in Test A				
2	1-5	150-230	23-29	30	90
3	6-10	200-500	16-18	30	83.3
4	11-20	200-500	12-16	30	70
Aggregate (Radar Types 1-4)				120	83.3

Table 2: Long Pulse Radar Test Waveform

Radar Type	Pulse Width (μsec)	Chirp Width (MHz)	PRI (μsec)	Number of Pulses per Burst	Number of Bursts	Number of Trials(Times)	Percentage of Successful Detection (%)
5	50-100	5-20	1000-2000	1-3	8-20	30	83.3

Table 3: Frequency Hopping Radar Test Waveform

Radar Type	Pulse Width (μsec)	PRI (μsec)	Pulses per Hop	Hopping Rate (kHz)	Hopping Sequence Length (msec)	Number of Trials(Times)	Percentage of Successful Detection (%)
6	1	333	9	0.333	300	30	90

802.11ac (VHT80) CH58

Table 1: Short Pulse Radar Test Waveforms.

Radar Type	Pulse Width (μsec)	PRI (μsec)	Number of Pulses	Number of Trials(Times)	Percentage of Successful Detection (%)
1	Test A: 15 unique PRI values randomly selected from the list of 23 PRI values in Table 5a	Roundup $\left\{ \left(\frac{1}{360} \right) \cdot \left(\frac{19 \cdot 10^6}{\text{PRI}_{\mu \text{ sec}}} \right) \right\}$	18	30	96.7
	Test B: 15 unique PRI values randomly selected within the range of 518~3066μ sec with a minimum of 1μ sec, excluding PRI values selected in Test A				
2	1-5	150-230	23-29	30	93.3
3	6-10	200-500	16-18	30	80
4	11-20	200-500	12-16	30	83.3
Aggregate (Radar Types 1-4)				120	88.3

Table 2: Long Pulse Radar Test Waveform

Radar Type	Pulse Width (μsec)	Chirp Width (MHz)	PRI (μsec)	Number of Pulses per Burst	Number of Bursts	Number of Trials(Times)	Percentage of Successful Detection (%)
5	50-100	5-20	1000-2000	1-3	8-20	30	90

Table 3: Frequency Hopping Radar Test Waveform

Radar Type	Pulse Width (μsec)	PRI (μsec)	Pulses per Hop	Hopping Rate (kHz)	Hopping Sequence Length (msec)	Number of Trials(Times)	Percentage of Successful Detection (%)
6	1	333	9	0.333	300	30	93.3

802.11ac (VHT80) CH106

Table 1: Short Pulse Radar Test Waveforms.

Radar Type	Pulse Width (μsec)	PRI (μsec)	Number of Pulses	Number of Trials(Times)	Percentage of Successful Detection (%)
1	Test A: 15 unique PRI values randomly selected from the list of 23 PRI values in Table 5a	Roundup $\left\{ \left(\frac{1}{360} \right) \cdot \left(\frac{19 \cdot 10^6}{\text{PRI}_{\mu \text{ sec}}} \right) \right\}$	18	30	86.7
	Test B: 15 unique PRI values randomly selected within the range of 518~3066μ sec with a minimum of 1μ sec, excluding PRI values selected in Test A				
2	1-5	150-230	23-29	30	90
3	6-10	200-500	16-18	30	86.7
4	11-20	200-500	12-16	30	70
Aggregate (Radar Types 1-4)				120	83.3

Table 2: Long Pulse Radar Test Waveform

Radar Type	Pulse Width (μsec)	Chirp Width (MHz)	PRI (μsec)	Number of Pulses per Burst	Number of Bursts	Number of Trials(Times)	Percentage of Successful Detection (%)
5	50-100	5-20	1000-2000	1-3	8-20	30	90

Table 3: Frequency Hopping Radar Test Waveform

Radar Type	Pulse Width (μsec)	PRI (μsec)	Pulses per Hop	Hopping Rate (kHz)	Hopping Sequence Length (msec)	Number of Trials(Times)	Percentage of Successful Detection (%)
6	1	333	9	0.333	300	30	90

Radar signal 0

802.11ac (VHT80)

Channel Closing Transmission Time & Channel Move Time @ CH58 - 5290MHz

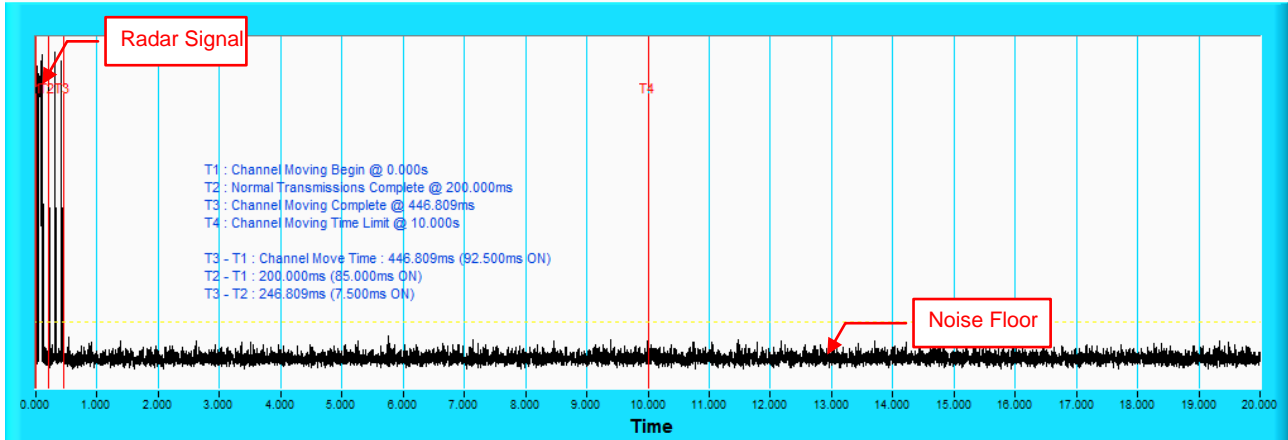

NOTE: T1 denotes the start of Channel Move Time upon the end of the last Radar burst. T2 denotes the data transmission time of 200ms from T1. T3 denotes the end of Channel Move Time. T4 denotes the 10 second from T1 to observe the aggregate duration of transmissions.

Channel Closing Transmission Time & Channel Move Time @ CH58 - 5290MHz

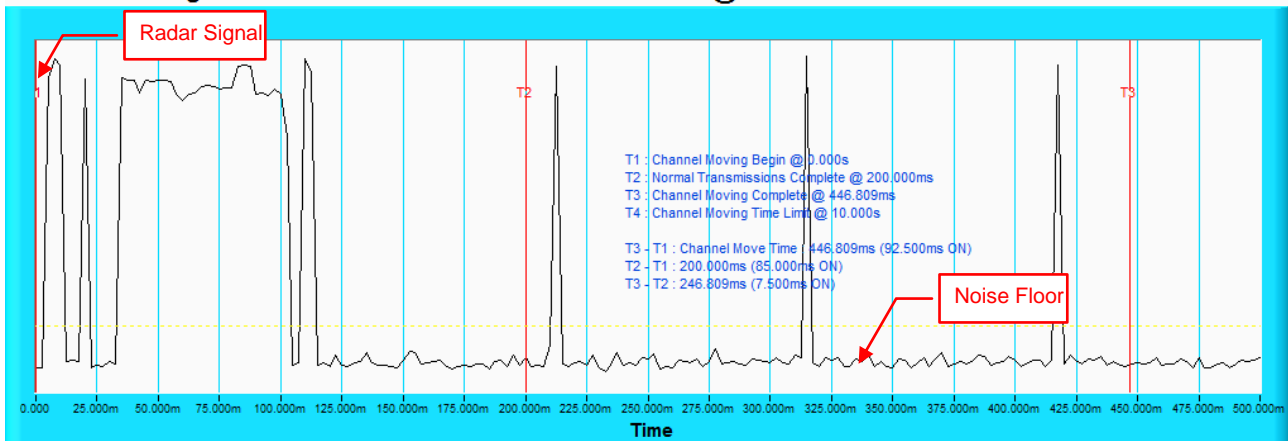

NOTE: Zoom in of the first 500ms after radar signal applied.

Radar signal 1

802.11ac (VHT80)

Channel Closing Transmission Time & Channel Move Time @ CH58 - 5290MHZ

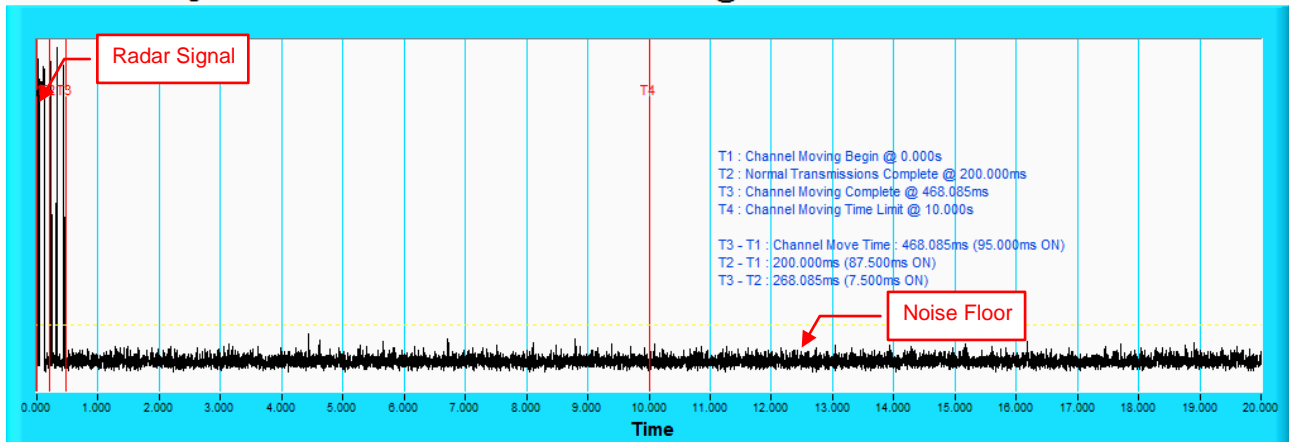

NOTE: T1 denotes the start of Channel Move Time upon the end of the last Radar burst. T2 denotes the data transmission time of 200ms from T1. T3 denotes the end of Channel Move Time. T4 denotes the 10 second from T1 to observe the aggregate duration of transmissions.

Channel Closing Transmission Time & Channel Move Time @ CH58 - 5290MHZ

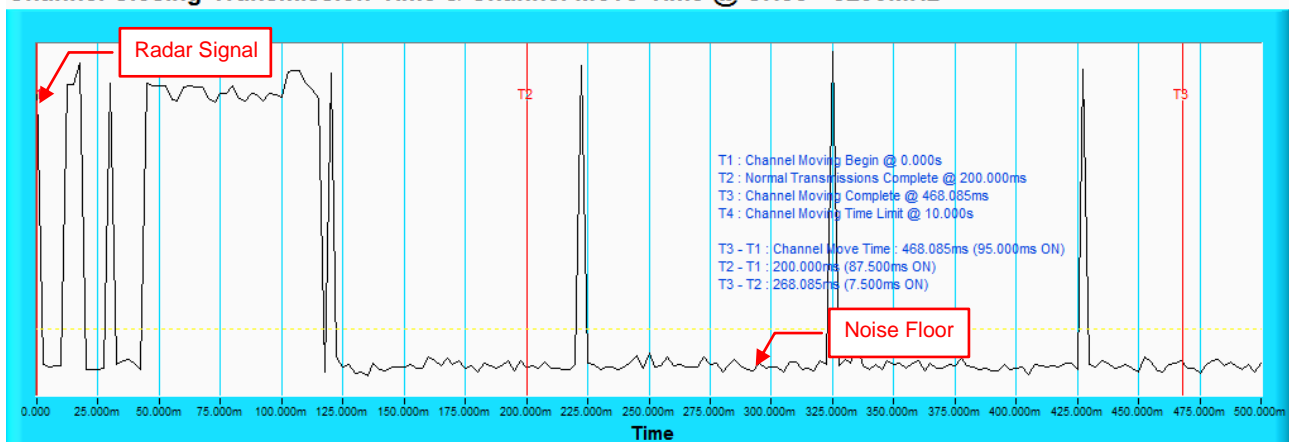

NOTE: Zoom in of the first 500ms after radar signal applied.

Radar signal 2

802.11ac (VHT80)

Channel Closing Transmission Time & Channel Move Time @ CH58 - 5290MHz

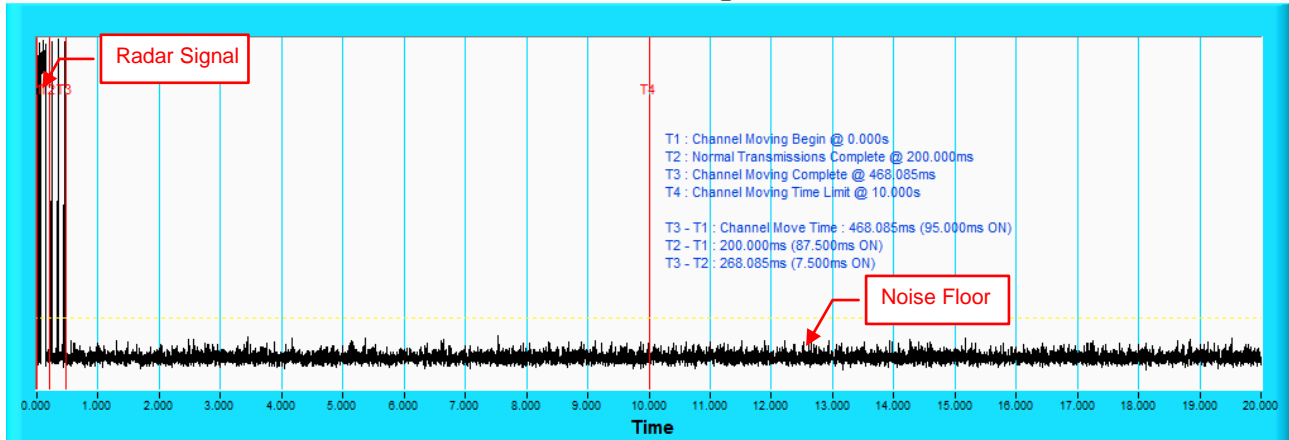

NOTE: T1 denotes the start of Channel Move Time upon the end of the last Radar burst. T2 denotes the data transmission time of 200ms from T1. T3 denotes the end of Channel Move Time. T4 denotes the 10 second from T1 to observe the aggregate duration of transmissions.

Channel Closing Transmission Time & Channel Move Time @ CH58 - 5290MHz

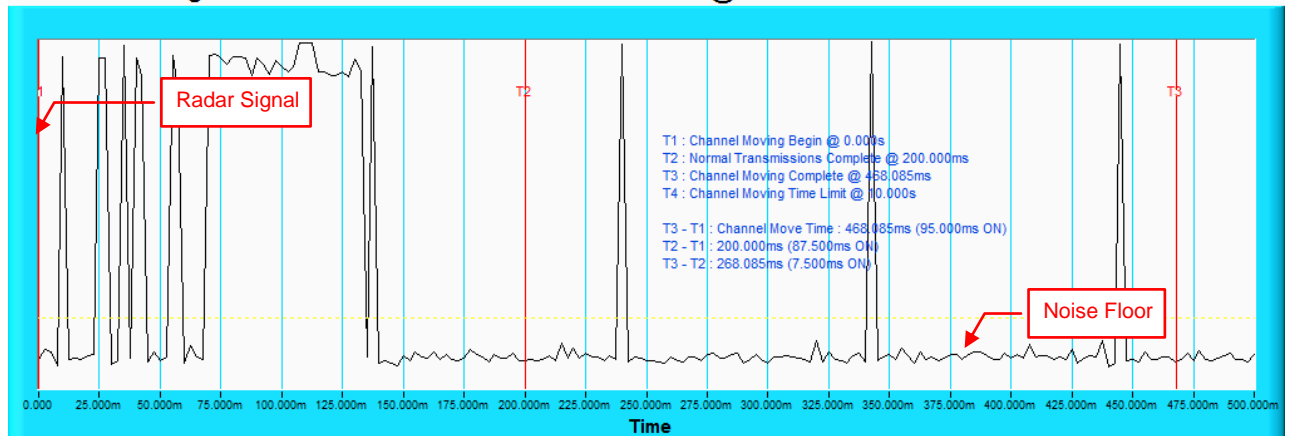

NOTE: Zoom in of the first 500ms after radar signal applied.

Radar signal 3

802.11ac (VHT80)

Channel Closing Transmission Time & Channel Move Time @ CH58 - 5290MHz

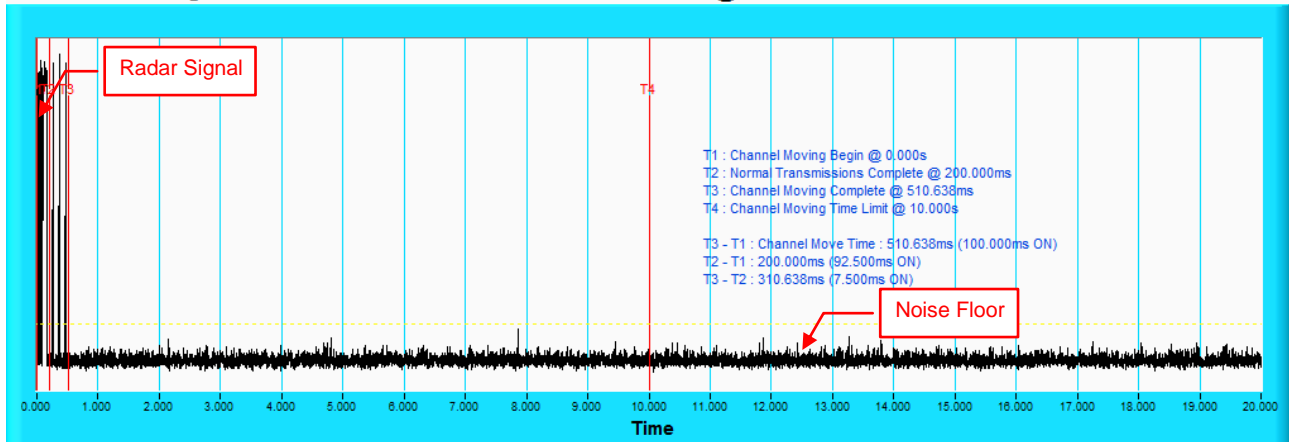

NOTE: T1 denotes the start of Channel Move Time upon the end of the last Radar burst. T2 denotes the data transmission time of 200ms from T1. T3 denotes the end of Channel Move Time. T4 denotes the 10 second from T1 to observe the aggregate duration of transmissions.

Channel Closing Transmission Time & Channel Move Time @ CH58 - 5290MHz

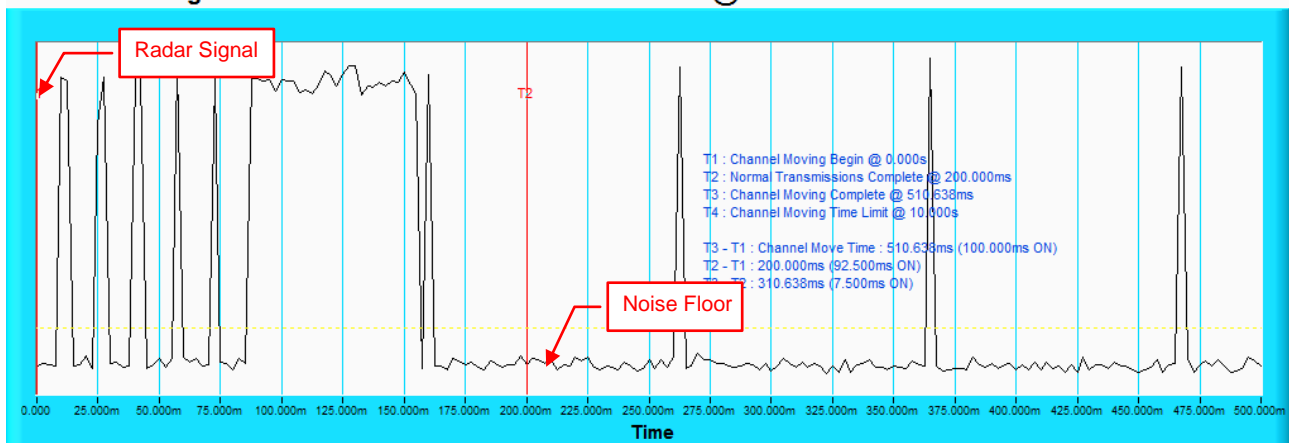

NOTE: Zoom in of the first 500ms after radar signal applied.

Radar signal 4

802.11ac (VHT80)

Channel Closing Transmission Time & Channel Move Time @ CH58 - 5290MHZ

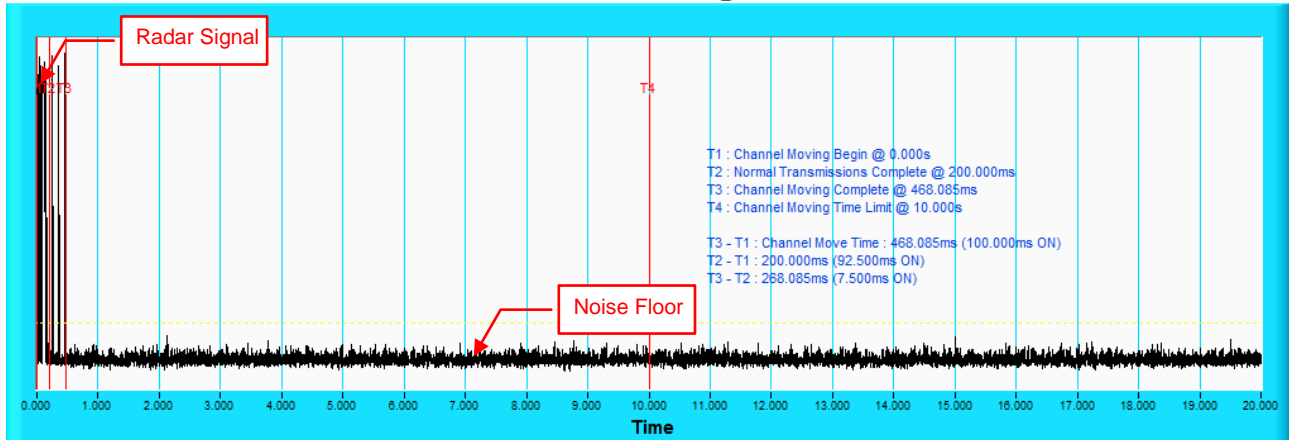

NOTE: T1 denotes the start of Channel Move Time upon the end of the last Radar burst. T2 denotes the data transmission time of 200ms from T1. T3 denotes the end of Channel Move Time. T4 denotes the 10 second from T1 to observe the aggregate duration of transmissions.

Channel Closing Transmission Time & Channel Move Time @ CH58 - 5290MHZ

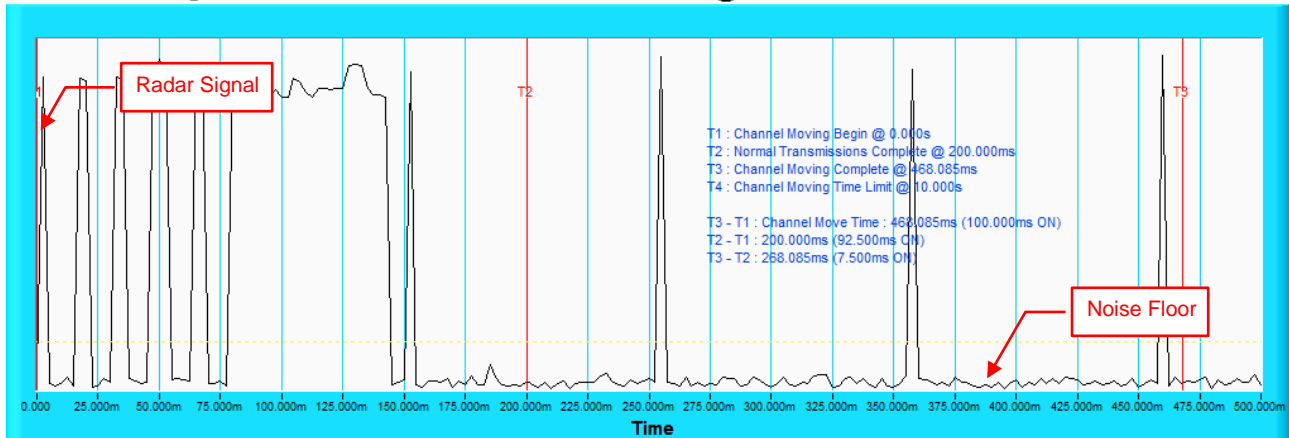

NOTE: Zoom in of the first 500ms after radar signal applied.

Radar signal 0

802.11ac (VHT80)

Channel Closing Transmission Time & Channel Move Time@CH106-5530MHz

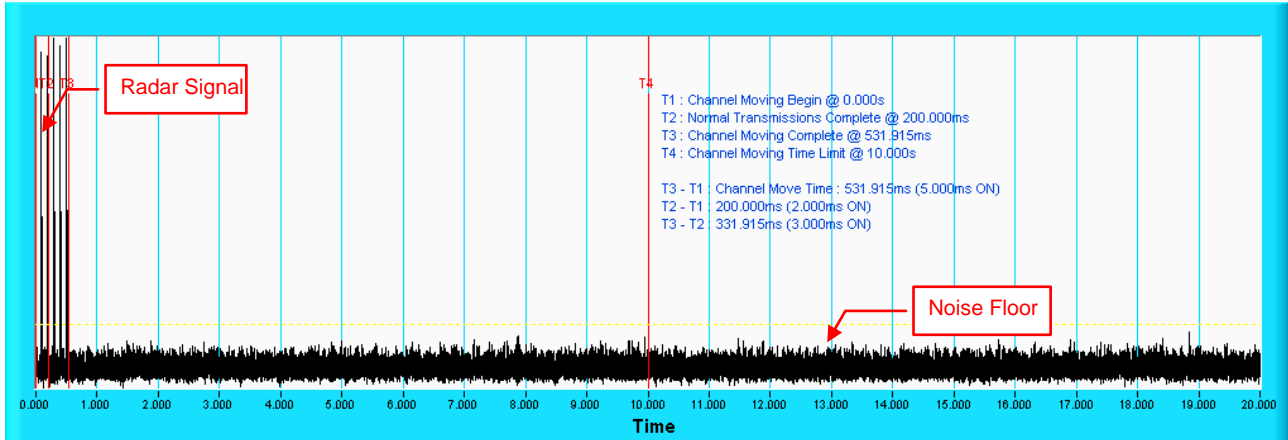

NOTE: T1 denotes the start of Channel Move Time upon the end of the last Radar burst. T2 denotes the data transmission time of 200ms from T1. T3 denotes the end of Channel Move Time. T4 denotes the 10 second from T1 to observe the aggregate duration of transmissions.

Channel Closing Transmission Time & Channel Move Time@CH106-5530MHz

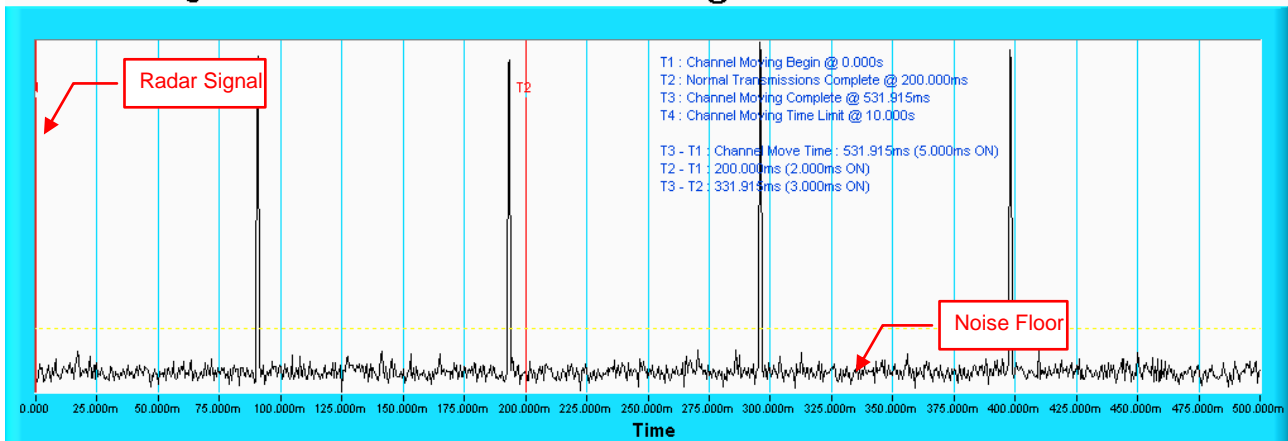

NOTE: Zoom in of the first 500ms after radar signal applied.

Radar signal 1

802.11ac (VHT80)

Channel Closing Transmission Time & Channel Move Time@CH106-5530MHZ

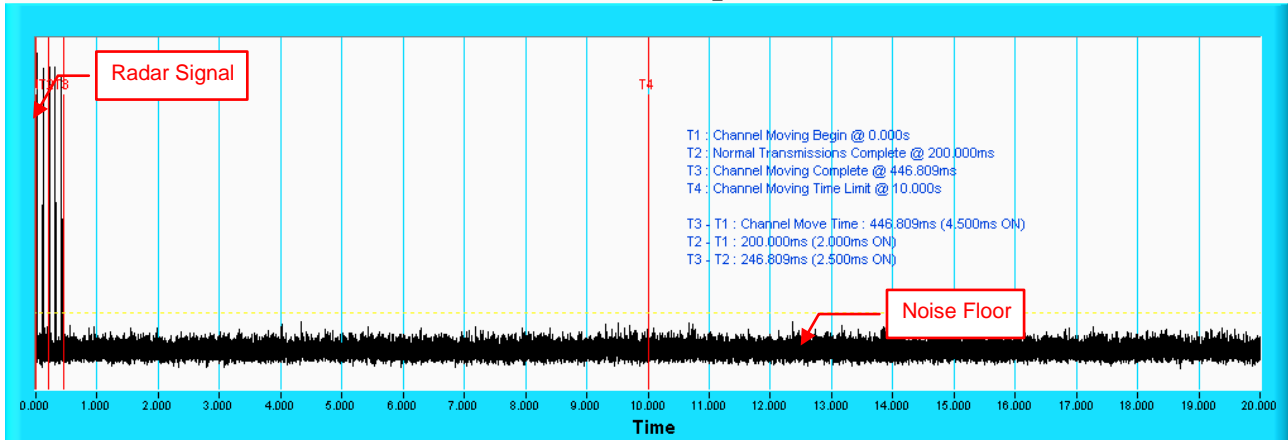

NOTE: T1 denotes the start of Channel Move Time upon the end of the last Radar burst. T2 denotes the data transmission time of 200ms from T1. T3 denotes the end of Channel Move Time. T4 denotes the 10 second from T1 to observe the aggregate duration of transmissions.

Channel Closing Transmission Time & Channel Move Time@CH106-5530MHZ

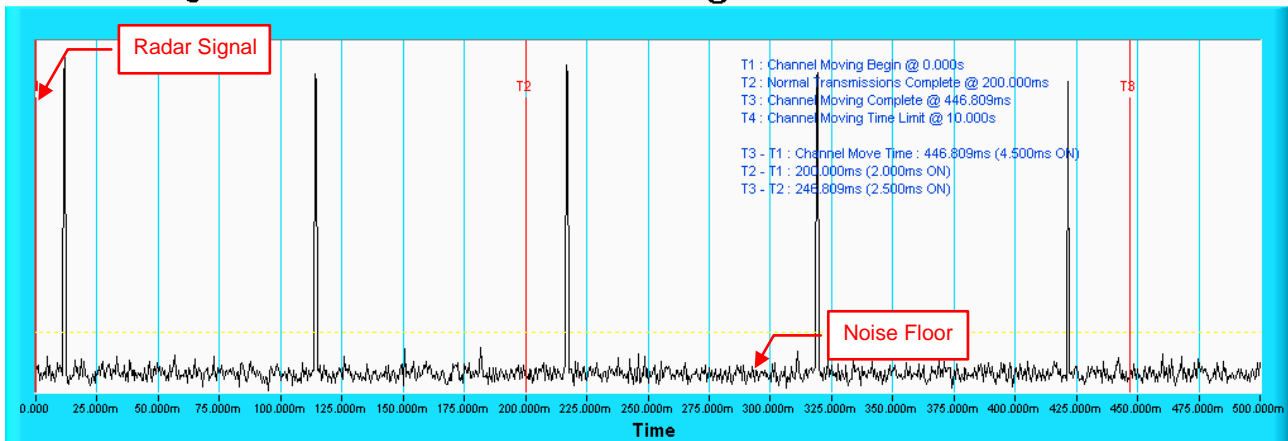

NOTE: Zoom in of the first 500ms after radar signal applied.

Radar signal 2

802.11ac (VHT80)

Channel Closing Transmission Time & Channel Move Time@CH106-5530MHz

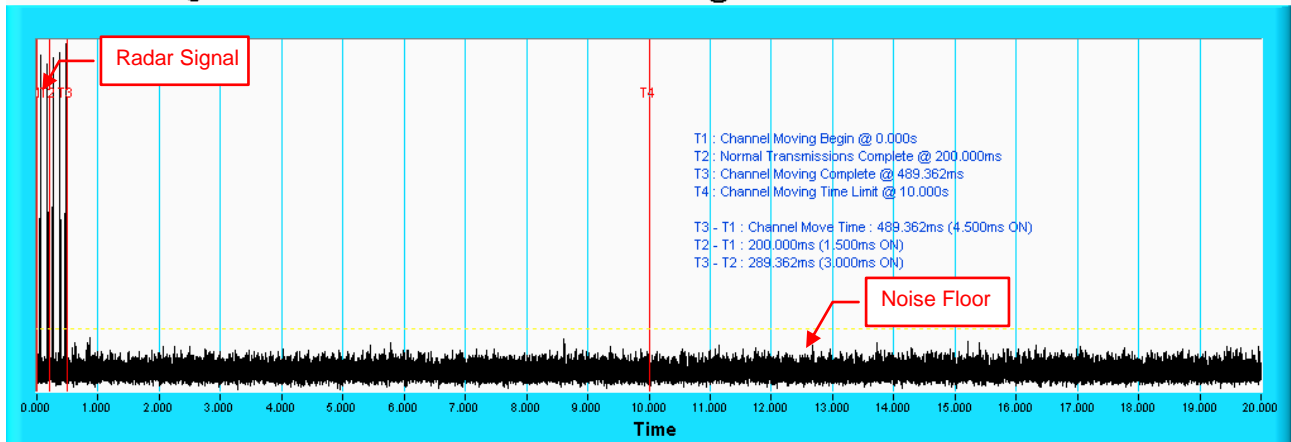

NOTE: T1 denotes the start of Channel Move Time upon the end of the last Radar burst. T2 denotes the data transmission time of 200ms from T1. T3 denotes the end of Channel Move Time. T4 denotes the 10 second from T1 to observe the aggregate duration of transmissions.

Channel Closing Transmission Time & Channel Move Time@CH106-5530MHz

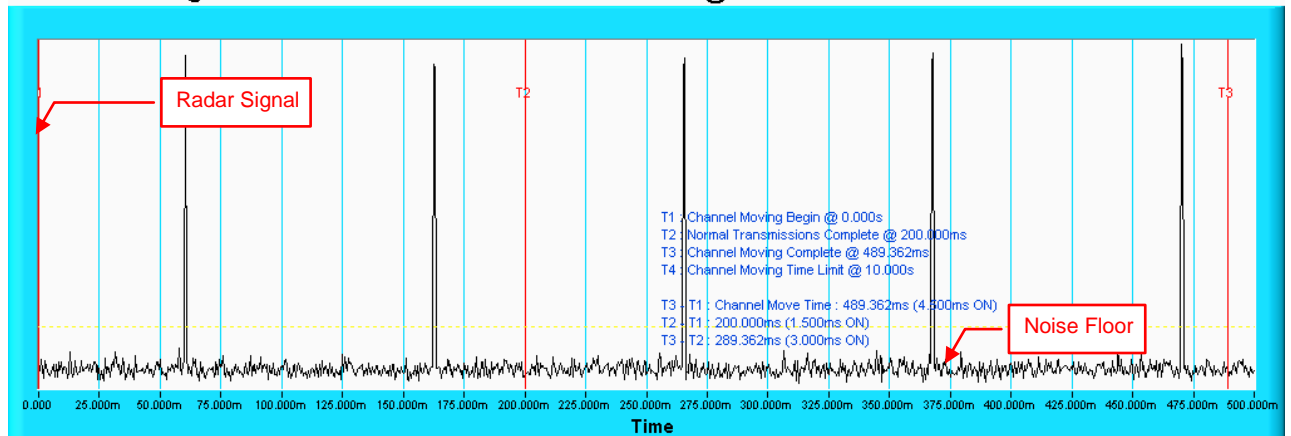

NOTE: Zoom in of the first 500ms after radar signal applied.

Radar signal 3

802.11ac (VHT80)

Channel Closing Transmission Time & Channel Move Time@CH106-5530MHZ

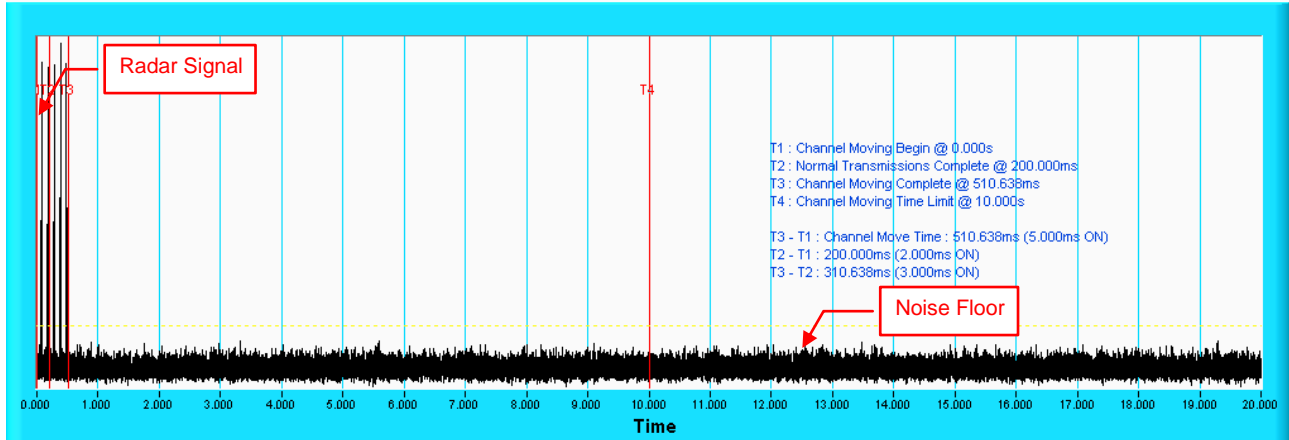

NOTE: T1 denotes the start of Channel Move Time upon the end of the last Radar burst. T2 denotes the data transmission time of 200ms from T1. T3 denotes the end of Channel Move Time. T4 denotes the 10 second from T1 to observe the aggregate duration of transmissions.

Channel Closing Transmission Time & Channel Move Time@CH106-5530MHZ

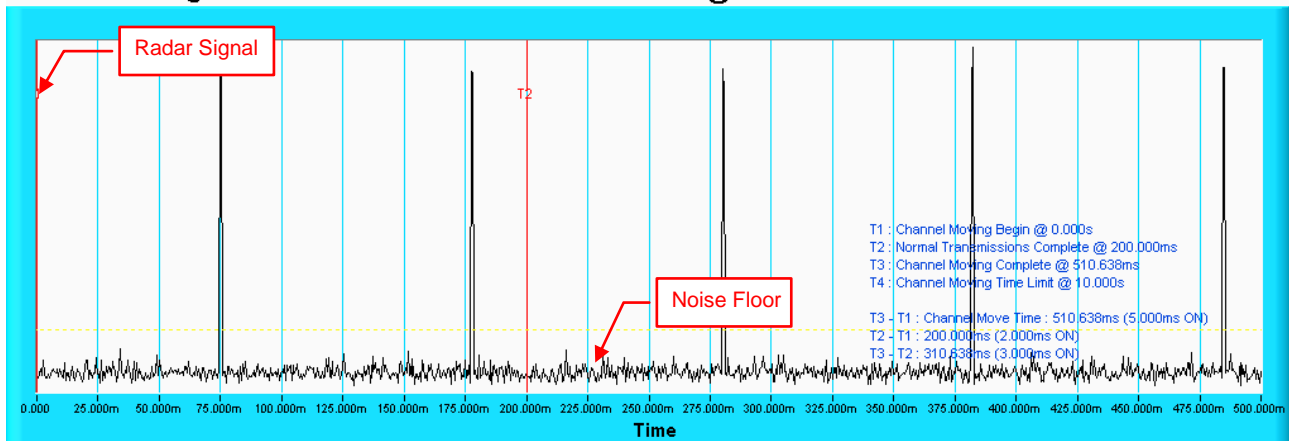

NOTE: Zoom in of the first 500ms after radar signal applied.

Radar signal 4

802.11ac (VHT80)

Channel Closing Transmission Time & Channel Move Time@CH106-5530MHZ

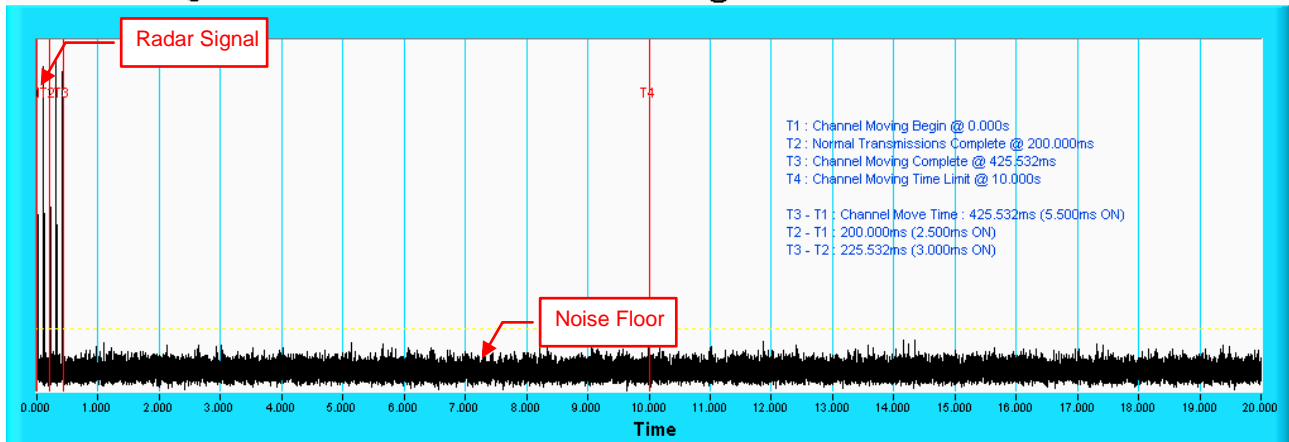

NOTE: T1 denotes the start of Channel Move Time upon the end of the last Radar burst. T2 denotes the data transmission time of 200ms from T1. T3 denotes the end of Channel Move Time. T4 denotes the 10 second from T1 to observe the aggregate duration of transmissions.

Channel Closing Transmission Time & Channel Move Time@CH106-5530MHZ

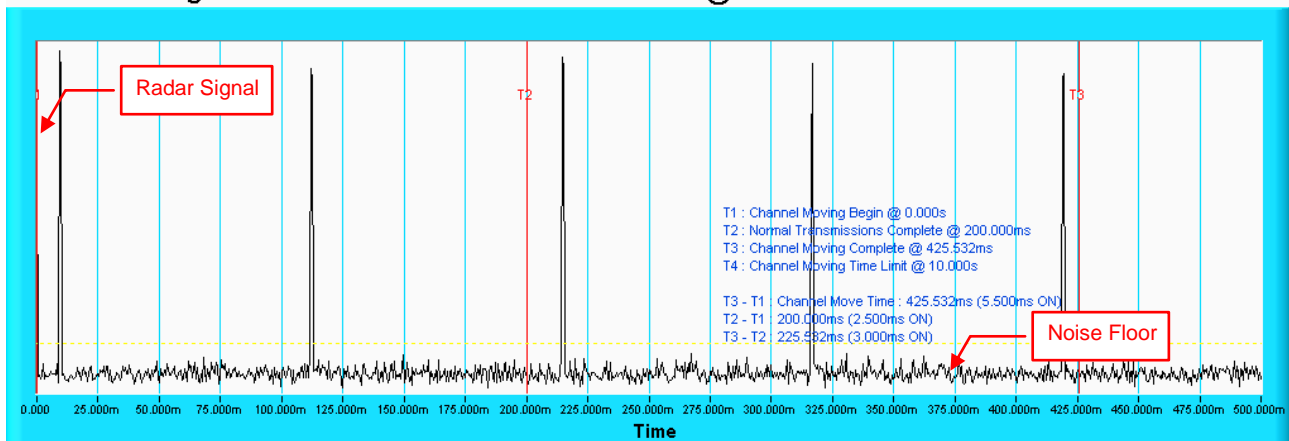

NOTE: Zoom in of the first 500ms after radar signal applied.

802.11ac (VHT20) CH60

Type 1 Radar Statistical Performances						
Trial #	Test Frequency (MHz)	Pulse Repetition Frequency Number (1 to 23)	Pulse Repetition Frequency (Pulse per seconds)	Pulses per Burst	Pulse Repetition Interval (microseconds)	Detection
1	5300	15	1253	67	798	Yes
2	5292	16	1223	65	818	Yes
3	5295	4	1730	92	578	Yes
4	5292	11	1393	74	718	Yes
5	5307	22	1066	57	938	Yes
6	5293	7	1567	83	638	Yes
7	5305	2	1859	99	538	Yes
8	5294	8	1520	81	658	Yes
9	5306	1	1931	102	518	Yes
10	5297	19	1139	61	878	No
11	5306	21	1089	58	918	Yes
12	5301	23	326.2	18	3066	Yes
13	5298	9	1475	78	678	Yes
14	5297	5	1672	89	598	Yes
15	5305	6	1618	86	618	Yes
16	5303		1111	59	900	Yes
17	5306		1024	55	977	Yes
18	5297		625.8	34	1598	Yes
19	5299		730.5	39	1369	Yes
20	5306		1181	63	847	Yes
21	5305		400.6	22	2496	Yes
22	5309		529.4	28	1889	Yes
23	5298		347.6	19	2877	No
24	5301		641.4	34	1559	Yes
25	5304		508.9	27	1965	Yes
26	5307		345.4	19	2895	Yes
27	5306		580.7	31	1722	Yes
28	5301		786.8	42	1271	Yes
29	5296		808.4	43	1237	Yes
30	5294		517.1	28	1934	Yes
Detection Rate: 93.3 %						

802.11ac (VHT20) CH60
Type 2 Radar Statistical Performances

Trial #	Test Frequency (MHz)	Pulses per Burst	Pulse Width(us)	PRI(us)	Detection
1	5300	24	1.7	174	Yes
2	5308	27	3.8	176	Yes
3	5307	28	4	161	Yes
4	5296	28	4.3	226	No
5	5303	24	1.9	193	No
6	5305	23	1.1	230	Yes
7	5293	29	4.5	198	Yes
8	5309	26	2.9	227	Yes
9	5293	26	2.8	171	Yes
10	5308	27	3.6	221	Yes
11	5305	23	1.1	180	No
12	5306	23	1.3	189	Yes
13	5302	25	2.5	204	Yes
14	5293	29	4.5	203	Yes
15	5307	29	5	170	Yes
16	5303	26	3.1	201	Yes
17	5303	24	2.1	218	Yes
18	5294	25	2.6	208	Yes
19	5292	24	1.8	223	Yes
20	5306	23	1.2	220	Yes
21	5304	26	2.9	224	Yes
22	5306	28	4	160	No
23	5302	25	2.5	209	Yes
24	5295	23	1	205	Yes
25	5301	27	3.7	151	No
26	5305	25	2.5	186	Yes
27	5293	23	1.5	190	Yes
28	5294	23	1.3	185	Yes
29	5299	23	1.2	175	Yes
30	5307	24	1.7	216	No

Detection Rate: 80 %

802.11ac (VHT20) CH60

Type 3 Radar Statistical Performances

Trial #	Test Frequency (MHz)	Pulses per Burst	Pulse Width(us)	PRI(us)	Detection
1	5300	16	6.7	467	Yes
2	5308	18	8.8	304	Yes
3	5300	18	9	316	No
4	5300	18	9.3	439	Yes
5	5293	16	6.9	420	No
6	5301	16	6.1	249	Yes
7	5302	18	9.5	463	Yes
8	5297	17	7.9	258	Yes
9	5291	17	7.8	212	Yes
10	5298	17	8.6	236	Yes
11	5308	16	6.1	474	Yes
12	5302	16	6.3	461	Yes
13	5293	17	7.5	437	No
14	5297	18	9.5	287	Yes
15	5306	18	10	395	No
16	5301	17	8.1	322	Yes
17	5306	16	7.1	468	No
18	5303	17	7.6	255	No
19	5301	16	6.8	423	Yes
20	5292	16	6.2	456	Yes
21	5294	17	7.9	351	Yes
22	5307	18	9	411	Yes
23	5303	17	7.5	279	Yes
24	5301	16	6	431	Yes
25	5300	17	8.7	324	Yes
26	5304	17	7.5	419	Yes
27	5299	16	6.5	447	Yes
28	5297	16	6.3	481	Yes
29	5298	16	6.2	438	Yes
30	5297	16	6.7	270	Yes

Detection Rate: 80 %

802.11ac (VHT20) CH60

Type 4 Radar Statistical Performances

Trial #	Test Frequency (MHz)	Pulses per Burst	Pulse Width(us)	PRI(us)	Detection
1	5300	12	12.5	467	Yes
2	5297	15	17.2	304	Yes
3	5300	15	17.8	316	Yes
4	5295	16	18.5	439	No
5	5296	13	13.1	420	Yes
6	5302	12	11.3	249	No
7	5299	16	18.8	463	Yes
8	5308	14	15.3	258	No
9	5302	14	15.1	212	Yes
10	5294	15	16.9	236	Yes
11	5293	12	11.2	474	No
12	5301	12	11.7	461	Yes
13	5302	13	14.4	437	No
14	5292	16	18.9	287	Yes
15	5297	16	19.9	395	No
16	5301	14	15.7	322	Yes
17	5299	13	13.4	468	Yes
18	5297	13	14.5	255	Yes
19	5305	13	12.9	423	Yes
20	5292	12	11.5	456	Yes
21	5303	14	15.3	351	Yes
22	5302	15	17.8	411	Yes
23	5298	13	14.3	279	Yes
24	5301	12	11.1	431	Yes
25	5295	15	17	324	No
26	5307	13	14.5	419	Yes
27	5304	12	12.1	447	Yes
28	5295	12	11.7	481	Yes
29	5298	12	11.6	438	Yes
30	5298	12	12.7	270	Yes

Detection Rate: 76.7 %

802.11ac (VHT20) CH60

Type 5 Radar Statistical Performances

Trial #	Minimum Chirp Width(MHz)	Chirp Center Frequency(MHz)	Test Signal Name	Detection
1	17	5300	LP_Signal_01	Yes
2	7	5300	LP_Signal_02	Yes
3	8	5300	LP_Signal_03	Yes
4	19	5300	LP_Signal_04	Yes
5	12	5300	LP_Signal_05	Yes
6	11	5300	LP_Signal_06	Yes
7	6	5300	LP_Signal_07	Yes
8	20	5300	LP_Signal_08	No
9	6	5300	LP_Signal_09	Yes
10	12	5300	LP_Signal_10	Yes
11	16	5297	LP_Signal_11	Yes
12	20	5299	LP_Signal_12	Yes
13	18	5298	LP_Signal_13	Yes
14	12	5296	LP_Signal_14	Yes
15	12	5296	LP_Signal_15	Yes
16	15	5297	LP_Signal_16	No
17	10	5295	LP_Signal_17	No
18	12	5296	LP_Signal_18	Yes
19	10	5295	LP_Signal_19	Yes
20	20	5299	LP_Signal_20	Yes
21	7	5306	LP_Signal_21	Yes
22	20	5301	LP_Signal_22	Yes
23	8	5306	LP_Signal_23	Yes
24	17	5302	LP_Signal_24	Yes
25	7	5306	LP_Signal_25	No
26	14	5303	LP_Signal_26	Yes
27	11	5305	LP_Signal_27	Yes
28	7	5306	LP_Signal_28	Yes
29	12	5304	LP_Signal_29	Yes
30	8	5306	LP_Signal_30	No

Detection Rate: 83.3 %

The Long Pulse Radar pattern shown in Appendix A.1

802.11ac (VHT20) CH60

Type 6 Radar Statistical Performances

Trial #	Pulses per Burst	Pulse Width(us)	PRI(us)	Detection
1	9	1	333.3	Yes
2	9	1	333.3	Yes
3	9	1	333.3	Yes
4	9	1	333.3	Yes
5	9	1	333.3	Yes
6	9	1	333.3	Yes
7	9	1	333.3	Yes
8	9	1	333.3	Yes
9	9	1	333.3	Yes
10	9	1	333.3	Yes
11	9	1	333.3	No
12	9	1	333.3	Yes
13	9	1	333.3	Yes
14	9	1	333.3	Yes
15	9	1	333.3	Yes
16	9	1	333.3	Yes
17	9	1	333.3	Yes
18	9	1	333.3	Yes
19	9	1	333.3	Yes
20	9	1	333.3	Yes
21	9	1	333.3	No
22	9	1	333.3	Yes
23	9	1	333.3	Yes
24	9	1	333.3	No
25	9	1	333.3	Yes
26	9	1	333.3	No
27	9	1	333.3	Yes
28	9	1	333.3	Yes
29	9	1	333.3	Yes
30	9	1	333.3	Yes

Detection Rate: 86.7 %

802.11ac (VHT20) CH60
Type 6 Radar Statistical Performances

Trial #	Hopping Frequency Sequence Name	Detection
1	HOP_FREQ_SEQ_01	Yes
2	HOP_FREQ_SEQ_02	Yes
3	HOP_FREQ_SEQ_03	Yes
4	HOP_FREQ_SEQ_04	Yes
5	HOP_FREQ_SEQ_05	Yes
6	HOP_FREQ_SEQ_06	Yes
7	HOP_FREQ_SEQ_07	Yes
8	HOP_FREQ_SEQ_08	Yes
9	HOP_FREQ_SEQ_09	Yes
10	HOP_FREQ_SEQ_10	Yes
11	HOP_FREQ_SEQ_11	No
12	HOP_FREQ_SEQ_12	Yes
13	HOP_FREQ_SEQ_13	Yes
14	HOP_FREQ_SEQ_14	Yes
15	HOP_FREQ_SEQ_15	Yes
16	HOP_FREQ_SEQ_16	Yes
17	HOP_FREQ_SEQ_17	Yes
18	HOP_FREQ_SEQ_18	Yes
19	HOP_FREQ_SEQ_19	Yes
20	HOP_FREQ_SEQ_20	Yes
21	HOP_FREQ_SEQ_21	No
22	HOP_FREQ_SEQ_22	Yes
23	HOP_FREQ_SEQ_23	Yes
24	HOP_FREQ_SEQ_24	No
25	HOP_FREQ_SEQ_25	Yes
26	HOP_FREQ_SEQ_26	No
27	HOP_FREQ_SEQ_27	Yes
28	HOP_FREQ_SEQ_28	Yes
29	HOP_FREQ_SEQ_29	Yes
30	HOP_FREQ_SEQ_30	Yes

Detection Rate: 86.7 %

The Frequency Hopping Radar pattern shown in Appendix A.2

802.11ac (VHT20) CH100

Type 1 Radar Statistical Performances

Trial #	Test Frequency (MHz)	Pulse Repetition Frequency Number (1 to 23)	Pulse Repetition Frequency (Pulse per seconds)	Pulses per Burst	Pulse Repetition Interval (microseconds)	Detection
1	5500	15	1253	67	798	Yes
2	5491	16	1223	65	818	Yes
3	5502	4	1730	92	578	Yes
4	5495	11	1393	74	718	No
5	5498	22	1066	57	938	Yes
6	5503	7	1567	83	638	Yes
7	5493	2	1859	99	538	Yes
8	5505	8	1520	81	658	Yes
9	5501	1	1931	102	518	No
10	5505	19	1139	61	878	Yes
11	5497	21	1089	58	918	Yes
12	5499	23	326.2	18	3066	Yes
13	5501	9	1475	78	678	Yes
14	5497	5	1672	89	598	Yes
15	5502	6	1618	86	618	Yes
16	5509		1111	59	900	Yes
17	5502		1024	55	977	Yes
18	5503		625.8	34	1598	Yes
19	5499		730.5	39	1369	Yes
20	5508		1181	63	847	Yes
21	5509		400.6	22	2496	Yes
22	5499		529.4	28	1889	Yes
23	5505		347.6	19	2877	Yes
24	5492		641.4	34	1559	Yes
25	5503		508.9	27	1965	Yes
26	5493		345.4	19	2895	Yes
27	5508		580.7	31	1722	Yes
28	5498		786.8	42	1271	Yes
29	5505		808.4	43	1237	Yes
30	5503		517.1	28	1934	Yes

Detection Rate: 93.3 %

802.11ac (VHT20) CH100
Type 2 Radar Statistical Performances

Trial #	Test Frequency (MHz)	Pulses per Burst	Pulse Width(us)	PRI(us)	Detection
1	5500	24	1.7	174	Yes
2	5493	27	3.8	176	Yes
3	5506	28	4	161	Yes
4	5497	28	4.3	226	Yes
5	5506	24	1.9	193	No
6	5497	23	1.1	230	Yes
7	5502	29	4.5	198	Yes
8	5506	26	2.9	227	Yes
9	5505	26	2.8	171	Yes
10	5506	27	3.6	221	No
11	5504	23	1.1	180	Yes
12	5504	23	1.3	189	Yes
13	5497	25	2.5	204	Yes
14	5497	29	4.5	203	Yes
15	5497	29	5	170	Yes
16	5505	26	3.1	201	Yes
17	5506	24	2.1	218	Yes
18	5507	25	2.6	208	Yes
19	5493	24	1.8	223	Yes
20	5502	23	1.2	220	Yes
21	5500	26	2.9	224	Yes
22	5507	28	4	160	Yes
23	5494	25	2.5	209	No
24	5505	23	1	205	Yes
25	5494	27	3.7	151	Yes
26	5500	25	2.5	186	Yes
27	5492	23	1.5	190	Yes
28	5491	23	1.3	185	Yes
29	5496	23	1.2	175	Yes
30	5509	24	1.7	216	Yes

Detection Rate: 90 %

802.11ac (VHT20) CH100
Type 3 Radar Statistical Performances

Trial #	Test Frequency (MHz)	Pulses per Burst	Pulse Width(us)	PRI(us)	Detection
1	5500	16	6.7	467	No
2	5502	18	8.8	304	Yes
3	5495	18	9	316	Yes
4	5508	18	9.3	439	Yes
5	5499	16	6.9	420	No
6	5499	16	6.1	249	Yes
7	5494	18	9.5	463	Yes
8	5499	17	7.9	258	Yes
9	5504	17	7.8	212	Yes
10	5495	17	8.6	236	Yes
11	5508	16	6.1	474	Yes
12	5492	16	6.3	461	Yes
13	5505	17	7.5	437	Yes
14	5508	18	9.5	287	Yes
15	5495	18	10	395	Yes
16	5495	17	8.1	322	Yes
17	5504	16	7.1	468	Yes
18	5500	17	7.6	255	Yes
19	5502	16	6.8	423	Yes
20	5496	16	6.2	456	Yes
21	5492	17	7.9	351	Yes
22	5494	18	9	411	Yes
23	5502	17	7.5	279	Yes
24	5505	16	6	431	Yes
25	5499	17	8.7	324	Yes
26	5501	17	7.5	419	Yes
27	5495	16	6.5	447	Yes
28	5508	16	6.3	481	Yes
29	5503	16	6.2	438	Yes
30	5494	16	6.7	270	Yes

Detection Rate: 93.3 %

802.11ac (VHT20) CH100
Type 4 Radar Statistical Performances

Trial #	Test Frequency (MHz)	Pulses per Burst	Pulse Width(us)	PRI(us)	Detection
1	5500	12	12.5	467	Yes
2	5500	15	17.2	304	Yes
3	5505	15	17.8	316	Yes
4	5505	16	18.5	439	Yes
5	5494	13	13.1	420	Yes
6	5495	12	11.3	249	Yes
7	5505	16	18.8	463	Yes
8	5507	14	15.3	258	No
9	5495	14	15.1	212	Yes
10	5508	15	16.9	236	Yes
11	5495	12	11.2	474	No
12	5504	12	11.7	461	Yes
13	5507	13	14.4	437	Yes
14	5497	16	18.9	287	Yes
15	5504	16	19.9	395	Yes
16	5503	14	15.7	322	Yes
17	5498	13	13.4	468	Yes
18	5498	13	14.5	255	Yes
19	5492	13	12.9	423	No
20	5502	12	11.5	456	Yes
21	5492	14	15.3	351	Yes
22	5502	15	17.8	411	No
23	5501	13	14.3	279	Yes
24	5502	12	11.1	431	Yes
25	5501	15	17	324	No
26	5492	13	14.5	419	Yes
27	5507	12	12.1	447	Yes
28	5499	12	11.7	481	Yes
29	5492	12	11.6	438	Yes
30	5499	12	12.7	270	Yes

Detection Rate: 83.3 %

802.11ac (VHT20) CH100
Type 5 Radar Statistical Performances

Trial #	Minimum Chirp Width(MHz)	Chirp Center Frequency(MHz)	Test Signal Name	Detection
1	17	5500	LP_Signal_01	Yes
2	7	5500	LP_Signal_02	No
3	8	5500	LP_Signal_03	Yes
4	19	5500	LP_Signal_04	Yes
5	12	5500	LP_Signal_05	Yes
6	11	5500	LP_Signal_06	Yes
7	6	5500	LP_Signal_07	Yes
8	20	5500	LP_Signal_08	Yes
9	6	5500	LP_Signal_09	Yes
10	12	5500	LP_Signal_10	Yes
11	16	5497	LP_Signal_11	Yes
12	20	5499	LP_Signal_12	No
13	18	5498	LP_Signal_13	Yes
14	12	5496	LP_Signal_14	Yes
15	12	5496	LP_Signal_15	Yes
16	15	5497	LP_Signal_16	Yes
17	10	5495	LP_Signal_17	Yes
18	12	5496	LP_Signal_18	Yes
19	10	5495	LP_Signal_19	No
20	20	5499	LP_Signal_20	Yes
21	7	5506	LP_Signal_21	Yes
22	20	5501	LP_Signal_22	Yes
23	8	5506	LP_Signal_23	Yes
24	17	5502	LP_Signal_24	Yes
25	7	5506	LP_Signal_25	Yes
26	14	5503	LP_Signal_26	Yes
27	11	5505	LP_Signal_27	Yes
28	7	5506	LP_Signal_28	Yes
29	12	5504	LP_Signal_29	Yes
30	8	5506	LP_Signal_30	Yes

Detection Rate: 90 %

The Long Pulse Radar pattern shown in Appendix A.1

802.11ac (VHT20) CH100

Type 6 Radar Statistical Performances

Trial #	Pulses per Burst	Pulse Width(us)	PRI(us)	Detection
1	9	1	333.3	Yes
2	9	1	333.3	No
3	9	1	333.3	Yes
4	9	1	333.3	Yes
5	9	1	333.3	Yes
6	9	1	333.3	Yes
7	9	1	333.3	Yes
8	9	1	333.3	Yes
9	9	1	333.3	Yes
10	9	1	333.3	Yes
11	9	1	333.3	Yes
12	9	1	333.3	Yes
13	9	1	333.3	Yes
14	9	1	333.3	Yes
15	9	1	333.3	No
16	9	1	333.3	Yes
17	9	1	333.3	Yes
18	9	1	333.3	No
19	9	1	333.3	No
20	9	1	333.3	Yes
21	9	1	333.3	Yes
22	9	1	333.3	Yes
23	9	1	333.3	Yes
24	9	1	333.3	Yes
25	9	1	333.3	Yes
26	9	1	333.3	Yes
27	9	1	333.3	Yes
28	9	1	333.3	Yes
29	9	1	333.3	Yes
30	9	1	333.3	Yes

Detection Rate: 86.7 %

802.11ac (VHT20) CH100
Type 6 Radar Statistical Performances

Trial #	Hopping Frequency Sequence Name	Detection
1	HOP_FREQ_SEQ_01	Yes
2	HOP_FREQ_SEQ_02	No
3	HOP_FREQ_SEQ_03	Yes
4	HOP_FREQ_SEQ_04	Yes
5	HOP_FREQ_SEQ_05	Yes
6	HOP_FREQ_SEQ_06	Yes
7	HOP_FREQ_SEQ_07	Yes
8	HOP_FREQ_SEQ_08	Yes
9	HOP_FREQ_SEQ_09	Yes
10	HOP_FREQ_SEQ_10	Yes
11	HOP_FREQ_SEQ_11	Yes
12	HOP_FREQ_SEQ_12	Yes
13	HOP_FREQ_SEQ_13	Yes
14	HOP_FREQ_SEQ_14	Yes
15	HOP_FREQ_SEQ_15	No
16	HOP_FREQ_SEQ_16	Yes
17	HOP_FREQ_SEQ_17	Yes
18	HOP_FREQ_SEQ_18	No
19	HOP_FREQ_SEQ_19	No
20	HOP_FREQ_SEQ_20	Yes
21	HOP_FREQ_SEQ_21	Yes
22	HOP_FREQ_SEQ_22	Yes
23	HOP_FREQ_SEQ_23	Yes
24	HOP_FREQ_SEQ_24	Yes
25	HOP_FREQ_SEQ_25	Yes
26	HOP_FREQ_SEQ_26	Yes
27	HOP_FREQ_SEQ_27	Yes
28	HOP_FREQ_SEQ_28	Yes
29	HOP_FREQ_SEQ_29	Yes
30	HOP_FREQ_SEQ_30	Yes

Detection Rate: 86.7 %

The Frequency Hopping Radar pattern shown in Appendix A.2

802.11ac (VHT40) CH62

Type 1 Radar Statistical Performances

Trial #	Test Frequency (MHz)	Pulse Repetition Frequency Number (1 to 23)	Pulse Repetition Frequency (Pulse per seconds)	Pulses per Burst	Pulse Repetition Interval (microseconds)	Detection
1	5310	15	1253	67	798	Yes
2	5320	16	1223	65	818	Yes
3	5300	4	1730	92	578	Yes
4	5300	11	1393	74	718	Yes
5	5301	22	1066	57	938	Yes
6	5316	7	1567	83	638	Yes
7	5315	2	1859	99	538	Yes
8	5303	8	1520	81	658	Yes
9	5299	1	1931	102	518	No
10	5318	19	1139	61	878	Yes
11	5311	21	1089	58	918	Yes
12	5313	23	326.2	18	3066	No
13	5325	9	1475	78	678	Yes
14	5320	5	1672	89	598	Yes
15	5313	6	1618	86	618	No
16	5305		1111	59	900	Yes
17	5319		1024	55	977	Yes
18	5299		625.8	34	1598	Yes
19	5323		730.5	39	1369	Yes
20	5322		1181	63	847	Yes
21	5295		400.6	22	2496	Yes
22	5306		529.4	28	1889	Yes
23	5307		347.6	19	2877	Yes
24	5317		641.4	34	1559	No
25	5314		508.9	27	1965	Yes
26	5295		345.4	19	2895	Yes
27	5296		580.7	31	1722	Yes
28	5325		786.8	42	1271	Yes
29	5297		808.4	43	1237	Yes
30	5303		517.1	28	1934	Yes

Detection Rate: 86.7 %

802.11ac (VHT40) CH62
Type 2 Radar Statistical Performances

Trial #	Test Frequency (MHz)	Pulses per Burst	Pulse Width(us)	PRI(us)	Detection
1	5310	24	1.7	174	Yes
2	5320	27	3.8	176	Yes
3	5300	28	4	161	Yes
4	5299	28	4.3	226	Yes
5	5326	24	1.9	193	Yes
6	5312	23	1.1	230	Yes
7	5303	29	4.5	198	Yes
8	5310	26	2.9	227	Yes
9	5313	26	2.8	171	Yes
10	5300	27	3.6	221	Yes
11	5317	23	1.1	180	Yes
12	5294	23	1.3	189	No
13	5311	25	2.5	204	Yes
14	5327	29	4.5	203	Yes
15	5325	29	5	170	Yes
16	5321	26	3.1	201	Yes
17	5296	24	2.1	218	Yes
18	5297	25	2.6	208	Yes
19	5305	24	1.8	223	Yes
20	5318	23	1.2	220	Yes
21	5318	26	2.9	224	Yes
22	5316	28	4	160	Yes
23	5322	25	2.5	209	Yes
24	5297	23	1	205	Yes
25	5321	27	3.7	151	No
26	5321	25	2.5	186	Yes
27	5308	23	1.5	190	Yes
28	5297	23	1.3	185	Yes
29	5322	23	1.2	175	Yes
30	5308	24	1.7	216	Yes

Detection Rate: 93.3 %

802.11ac (VHT40) CH62
Type 3 Radar Statistical Performances

Trial #	Test Frequency (MHz)	Pulses per Burst	Pulse Width(us)	PRI(us)	Detection
1	5310	16	6.7	467	Yes
2	5320	18	8.8	304	No
3	5300	18	9	316	Yes
4	5321	18	9.3	439	Yes
5	5308	16	6.9	420	Yes
6	5316	16	6.1	249	Yes
7	5311	18	9.5	463	Yes
8	5314	17	7.9	258	Yes
9	5326	17	7.8	212	Yes
10	5318	17	8.6	236	Yes
11	5302	16	6.1	474	No
12	5312	16	6.3	461	Yes
13	5311	17	7.5	437	No
14	5326	18	9.5	287	Yes
15	5313	18	10	395	Yes
16	5325	17	8.1	322	Yes
17	5306	16	7.1	468	Yes
18	5309	17	7.6	255	Yes
19	5314	16	6.8	423	Yes
20	5326	16	6.2	456	Yes
21	5312	17	7.9	351	No
22	5298	18	9	411	Yes
23	5304	17	7.5	279	Yes
24	5301	16	6	431	No
25	5300	17	8.7	324	Yes
26	5317	17	7.5	419	Yes
27	5324	16	6.5	447	Yes
28	5300	16	6.3	481	Yes
29	5320	16	6.2	438	No
30	5303	16	6.7	270	Yes

Detection Rate: 80 %

802.11ac (VHT40) CH62
Type 4 Radar Statistical Performances

Trial #	Test Frequency (MHz)	Pulses per Burst	Pulse Width(us)	PRI(us)	Detection
1	5310	12	12.5	467	Yes
2	5320	15	17.2	304	Yes
3	5300	15	17.8	316	Yes
4	5315	16	18.5	439	Yes
5	5302	13	13.1	420	No
6	5303	12	11.3	249	Yes
7	5303	16	18.8	463	Yes
8	5321	14	15.3	258	Yes
9	5301	14	15.1	212	Yes
10	5326	15	16.9	236	Yes
11	5309	12	11.2	474	Yes
12	5326	12	11.7	461	No
13	5293	13	14.4	437	Yes
14	5297	16	18.9	287	Yes
15	5294	16	19.9	395	Yes
16	5320	14	15.7	322	No
17	5324	13	13.4	468	Yes
18	5311	13	14.5	255	Yes
19	5318	13	12.9	423	Yes
20	5322	12	11.5	456	Yes
21	5312	14	15.3	351	Yes
22	5324	15	17.8	411	Yes
23	5298	13	14.3	279	Yes
24	5317	12	11.1	431	Yes
25	5324	15	17	324	Yes
26	5301	13	14.5	419	No
27	5321	12	12.1	447	Yes
28	5325	12	11.7	481	No
29	5327	12	11.6	438	No
30	5292	12	12.7	270	Yes

Detection Rate: 80 %

802.11ac (VHT40) CH62

Type 5 Radar Statistical Performances

Trial #	Minimum Chirp Width(MHz)	Chirp Center Frequency(MHz)	Test Signal Name	Detection
1	17	5310	LP_Signal_01	Yes
2	7	5310	LP_Signal_02	Yes
3	8	5310	LP_Signal_03	No
4	19	5310	LP_Signal_04	Yes
5	12	5310	LP_Signal_05	Yes
6	11	5310	LP_Signal_06	No
7	6	5310	LP_Signal_07	Yes
8	20	5310	LP_Signal_08	Yes
9	6	5310	LP_Signal_09	Yes
10	12	5310	LP_Signal_10	Yes
11	16	5298	LP_Signal_11	Yes
12	20	5300	LP_Signal_12	Yes
13	18	5299	LP_Signal_13	Yes
14	12	5297	LP_Signal_14	Yes
15	12	5297	LP_Signal_15	Yes
16	15	5298	LP_Signal_16	Yes
17	10	5296	LP_Signal_17	Yes
18	12	5297	LP_Signal_18	Yes
19	10	5296	LP_Signal_19	No
20	20	5300	LP_Signal_20	Yes
21	7	5325	LP_Signal_21	Yes
22	20	5320	LP_Signal_22	No
23	8	5325	LP_Signal_23	Yes
24	17	5321	LP_Signal_24	Yes
25	7	5325	LP_Signal_25	Yes
26	14	5322	LP_Signal_26	Yes
27	11	5324	LP_Signal_27	Yes
28	7	5325	LP_Signal_28	Yes
29	12	5323	LP_Signal_29	Yes
30	8	5325	LP_Signal_30	Yes

Detection Rate: 86.7 %

The Long Pulse Radar pattern shown in Appendix A.1

802.11ac (VHT40) CH62

Type 6 Radar Statistical Performances

Trial #	Pulses per Burst	Pulse Width(us)	PRI(us)	Detection
1	9	1	333.3	Yes
2	9	1	333.3	No
3	9	1	333.3	Yes
4	9	1	333.3	Yes
5	9	1	333.3	Yes
6	9	1	333.3	Yes
7	9	1	333.3	Yes
8	9	1	333.3	Yes
9	9	1	333.3	Yes
10	9	1	333.3	Yes
11	9	1	333.3	Yes
12	9	1	333.3	Yes
13	9	1	333.3	Yes
14	9	1	333.3	Yes
15	9	1	333.3	Yes
16	9	1	333.3	Yes
17	9	1	333.3	Yes
18	9	1	333.3	Yes
19	9	1	333.3	No
20	9	1	333.3	Yes
21	9	1	333.3	No
22	9	1	333.3	Yes
23	9	1	333.3	Yes
24	9	1	333.3	Yes
25	9	1	333.3	Yes
26	9	1	333.3	Yes
27	9	1	333.3	Yes
28	9	1	333.3	Yes
29	9	1	333.3	Yes
30	9	1	333.3	Yes

Detection Rate: 90 %

802.11ac (VHT40) CH62

Type 6 Radar Statistical Performances

Trial #	Hopping Frequency Sequence Name	Detection
1	HOP_FREQ_SEQ_01	Yes
2	HOP_FREQ_SEQ_02	No
3	HOP_FREQ_SEQ_03	Yes
4	HOP_FREQ_SEQ_04	Yes
5	HOP_FREQ_SEQ_05	Yes
6	HOP_FREQ_SEQ_06	Yes
7	HOP_FREQ_SEQ_07	Yes
8	HOP_FREQ_SEQ_08	Yes
9	HOP_FREQ_SEQ_09	Yes
10	HOP_FREQ_SEQ_10	Yes
11	HOP_FREQ_SEQ_11	Yes
12	HOP_FREQ_SEQ_12	Yes
13	HOP_FREQ_SEQ_13	Yes
14	HOP_FREQ_SEQ_14	Yes
15	HOP_FREQ_SEQ_15	Yes
16	HOP_FREQ_SEQ_16	Yes
17	HOP_FREQ_SEQ_17	Yes
18	HOP_FREQ_SEQ_18	Yes
19	HOP_FREQ_SEQ_19	No
20	HOP_FREQ_SEQ_20	Yes
21	HOP_FREQ_SEQ_21	No
22	HOP_FREQ_SEQ_22	Yes
23	HOP_FREQ_SEQ_23	Yes
24	HOP_FREQ_SEQ_24	Yes
25	HOP_FREQ_SEQ_25	Yes
26	HOP_FREQ_SEQ_26	Yes
27	HOP_FREQ_SEQ_27	Yes
28	HOP_FREQ_SEQ_28	Yes
29	HOP_FREQ_SEQ_29	Yes
30	HOP_FREQ_SEQ_30	Yes

Detection Rate: 90 %

The Frequency Hopping Radar pattern shown in Appendix A.2

802.11ac (VHT40) CH102
Type 1 Radar Statistical Performances

Trial #	Test Frequency (MHz)	Pulse Repetition Frequency Number (1 to 23)	Pulse Repetition Frequency (Pulse per seconds)	Pulses per Burst	Pulse Repetition Interval (microseconds)	Detection
1	5510	15	1253	67	798	Yes
2	5520	16	1223	65	818	Yes
3	5500	4	1730	92	578	Yes
4	5500	11	1393	74	718	Yes
5	5507	22	1066	57	938	No
6	5500	7	1567	83	638	Yes
7	5506	2	1859	99	538	Yes
8	5492	8	1520	81	658	Yes
9	5497	1	1931	102	518	Yes
10	5520	19	1139	61	878	Yes
11	5506	21	1089	58	918	Yes
12	5517	23	326.2	18	3066	Yes
13	5509	9	1475	78	678	Yes
14	5497	5	1672	89	598	Yes
15	5509	6	1618	86	618	Yes
16	5501		1111	59	900	Yes
17	5518		1024	55	977	Yes
18	5497		625.8	34	1598	No
19	5494		730.5	39	1369	No
20	5520		1181	63	847	Yes
21	5522		400.6	22	2496	Yes
22	5506		529.4	28	1889	Yes
23	5512		347.6	19	2877	Yes
24	5527		641.4	34	1559	Yes
25	5514		508.9	27	1965	Yes
26	5521		345.4	19	2895	Yes
27	5523		580.7	31	1722	Yes
28	5524		786.8	42	1271	Yes
29	5499		808.4	43	1237	Yes
30	5500		517.1	28	1934	Yes

Detection Rate: 90 %

802.11ac (VHT40) CH102
Type 2 Radar Statistical Performances

Trial #	Test Frequency (MHz)	Pulses per Burst	Pulse Width(us)	PRI(us)	Detection
1	5510	24	1.7	174	Yes
2	5520	27	3.8	176	Yes
3	5500	28	4	161	Yes
4	5495	28	4.3	226	Yes
5	5508	24	1.9	193	Yes
6	5498	23	1.1	230	Yes
7	5503	29	4.5	198	Yes
8	5507	26	2.9	227	Yes
9	5527	26	2.8	171	Yes
10	5521	27	3.6	221	Yes
11	5517	23	1.1	180	Yes
12	5503	23	1.3	189	Yes
13	5510	25	2.5	204	Yes
14	5526	29	4.5	203	Yes
15	5525	29	5	170	Yes
16	5493	26	3.1	201	Yes
17	5494	24	2.1	218	Yes
18	5527	25	2.6	208	Yes
19	5518	24	1.8	223	Yes
20	5504	23	1.2	220	Yes
21	5509	26	2.9	224	Yes
22	5510	28	4	160	No
23	5526	25	2.5	209	Yes
24	5495	23	1	205	Yes
25	5495	27	3.7	151	Yes
26	5527	25	2.5	186	Yes
27	5499	23	1.5	190	No
28	5523	23	1.3	185	Yes
29	5499	23	1.2	175	Yes
30	5497	24	1.7	216	No

Detection Rate: 90 %

802.11ac (VHT40) CH102

Type 3 Radar Statistical Performances

Trial #	Test Frequency (MHz)	Pulses per Burst	Pulse Width(us)	PRI(us)	Detection
1	5510	16	6.7	467	Yes
2	5520	18	8.8	304	Yes
3	5500	18	9	316	Yes
4	5524	18	9.3	439	Yes
5	5526	16	6.9	420	Yes
6	5512	16	6.1	249	Yes
7	5518	18	9.5	463	Yes
8	5494	17	7.9	258	Yes
9	5520	17	7.8	212	No
10	5502	17	8.6	236	No
11	5496	16	6.1	474	Yes
12	5504	16	6.3	461	Yes
13	5499	17	7.5	437	No
14	5517	18	9.5	287	Yes
15	5510	18	10	395	Yes
16	5509	17	8.1	322	Yes
17	5514	16	7.1	468	Yes
18	5517	17	7.6	255	Yes
19	5516	16	6.8	423	No
20	5495	16	6.2	456	Yes
21	5527	17	7.9	351	Yes
22	5506	18	9	411	No
23	5520	17	7.5	279	Yes
24	5525	16	6	431	Yes
25	5507	17	8.7	324	Yes
26	5492	17	7.5	419	Yes
27	5499	16	6.5	447	Yes
28	5527	16	6.3	481	Yes
29	5526	16	6.2	438	Yes
30	5517	16	6.7	270	Yes

Detection Rate: 83.3 %

802.11ac (VHT40) CH102

Type 4 Radar Statistical Performances

Trial #	Test Frequency (MHz)	Pulses per Burst	Pulse Width(us)	PRI(us)	Detection
1	5510	12	12.5	467	No
2	5520	15	17.2	304	No
3	5500	15	17.8	316	No
4	5519	16	18.5	439	Yes
5	5518	13	13.1	420	Yes
6	5511	12	11.3	249	No
7	5505	16	18.8	463	No
8	5495	14	15.3	258	No
9	5507	14	15.1	212	Yes
10	5522	15	16.9	236	Yes
11	5498	12	11.2	474	Yes
12	5520	12	11.7	461	Yes
13	5497	13	14.4	437	Yes
14	5512	16	18.9	287	Yes
15	5511	16	19.9	395	Yes
16	5524	14	15.7	322	No
17	5496	13	13.4	468	Yes
18	5507	13	14.5	255	Yes
19	5524	13	12.9	423	Yes
20	5523	12	11.5	456	Yes
21	5500	14	15.3	351	Yes
22	5496	15	17.8	411	No
23	5500	13	14.3	279	Yes
24	5509	12	11.1	431	Yes
25	5517	15	17	324	Yes
26	5504	13	14.5	419	Yes
27	5516	12	12.1	447	No
28	5506	12	11.7	481	Yes
29	5525	12	11.6	438	Yes
30	5493	12	12.7	270	Yes

Detection Rate: 70 %

802.11ac (VHT40) CH102

Type 5 Radar Statistical Performances

Trial #	Minimum Chirp Width(MHz)	Chirp Center Frequency(MHz)	Test Signal Name	Detection
1	17	5510	LP_Signal_01	Yes
2	7	5510	LP_Signal_02	Yes
3	8	5510	LP_Signal_03	No
4	19	5510	LP_Signal_04	Yes
5	12	5510	LP_Signal_05	No
6	11	5510	LP_Signal_06	Yes
7	6	5510	LP_Signal_07	No
8	20	5510	LP_Signal_08	Yes
9	6	5510	LP_Signal_09	Yes
10	12	5510	LP_Signal_10	Yes
11	16	5497	LP_Signal_11	Yes
12	20	5499	LP_Signal_12	Yes
13	18	5498	LP_Signal_13	Yes
14	12	5496	LP_Signal_14	Yes
15	12	5496	LP_Signal_15	Yes
16	15	5497	LP_Signal_16	Yes
17	10	5495	LP_Signal_17	Yes
18	12	5496	LP_Signal_18	Yes
19	10	5495	LP_Signal_19	Yes
20	20	5499	LP_Signal_20	Yes
21	7	5526	LP_Signal_21	Yes
22	20	5521	LP_Signal_22	Yes
23	8	5526	LP_Signal_23	Yes
24	17	5522	LP_Signal_24	Yes
25	7	5526	LP_Signal_25	Yes
26	14	5523	LP_Signal_26	No
27	11	5525	LP_Signal_27	Yes
28	7	5526	LP_Signal_28	No
29	12	5524	LP_Signal_29	Yes
30	8	5526	LP_Signal_30	Yes

Detection Rate: 83.3 %

The Long Pulse Radar pattern shown in Appendix A.1

802.11ac (VHT40) CH102

Type 6 Radar Statistical Performances

Trial #	Pulses per Burst	Pulse Width(us)	PRI(us)	Detection
1	9	1	333.3	Yes
2	9	1	333.3	Yes
3	9	1	333.3	Yes
4	9	1	333.3	Yes
5	9	1	333.3	Yes
6	9	1	333.3	Yes
7	9	1	333.3	No
8	9	1	333.3	Yes
9	9	1	333.3	Yes
10	9	1	333.3	Yes
11	9	1	333.3	No
12	9	1	333.3	Yes
13	9	1	333.3	Yes
14	9	1	333.3	No
15	9	1	333.3	Yes
16	9	1	333.3	Yes
17	9	1	333.3	Yes
18	9	1	333.3	Yes
19	9	1	333.3	Yes
20	9	1	333.3	Yes
21	9	1	333.3	Yes
22	9	1	333.3	Yes
23	9	1	333.3	Yes
24	9	1	333.3	Yes
25	9	1	333.3	Yes
26	9	1	333.3	Yes
27	9	1	333.3	Yes
28	9	1	333.3	Yes
29	9	1	333.3	Yes
30	9	1	333.3	Yes

Detection Rate: 90 %

802.11ac (VHT40) CH102

Type 6 Radar Statistical Performances

Trial #	Hopping Frequency Sequence Name	Detection
1	HOP_FREQ_SEQ_01	Yes
2	HOP_FREQ_SEQ_02	Yes
3	HOP_FREQ_SEQ_03	Yes
4	HOP_FREQ_SEQ_04	Yes
5	HOP_FREQ_SEQ_05	Yes
6	HOP_FREQ_SEQ_06	Yes
7	HOP_FREQ_SEQ_07	No
8	HOP_FREQ_SEQ_08	Yes
9	HOP_FREQ_SEQ_09	Yes
10	HOP_FREQ_SEQ_10	Yes
11	HOP_FREQ_SEQ_11	No
12	HOP_FREQ_SEQ_12	Yes
13	HOP_FREQ_SEQ_13	Yes
14	HOP_FREQ_SEQ_14	No
15	HOP_FREQ_SEQ_15	Yes
16	HOP_FREQ_SEQ_16	Yes
17	HOP_FREQ_SEQ_17	Yes
18	HOP_FREQ_SEQ_18	Yes
19	HOP_FREQ_SEQ_19	Yes
20	HOP_FREQ_SEQ_20	Yes
21	HOP_FREQ_SEQ_21	Yes
22	HOP_FREQ_SEQ_22	Yes
23	HOP_FREQ_SEQ_23	Yes
24	HOP_FREQ_SEQ_24	Yes
25	HOP_FREQ_SEQ_25	Yes
26	HOP_FREQ_SEQ_26	Yes
27	HOP_FREQ_SEQ_27	Yes
28	HOP_FREQ_SEQ_28	Yes
29	HOP_FREQ_SEQ_29	Yes
30	HOP_FREQ_SEQ_30	Yes

Detection Rate: 90 %

The Frequency Hopping Radar pattern shown in Appendix A.2

802.11ac (VHT80)CH58
Type 1 Radar Statistical Performances

Trial #	Test Frequency (MHz)	Pulse Repetition Frequency Number (1 to 23)	Pulse Repetition Frequency (Pulse per seconds)	Pulses per Burst	Pulse Repetition Interval (microseconds)	Detection
1	5290	15	1253	67	798	Yes
2	5300	16	1223	65	818	Yes
3	5320	4	1730	92	578	Yes
4	5280	11	1393	74	718	Yes
5	5260	22	1066	57	938	Yes
6	5315	7	1567	83	638	Yes
7	5267	2	1859	99	538	Yes
8	5315	8	1520	81	658	Yes
9	5287	1	1931	102	518	Yes
10	5271	19	1139	61	878	Yes
11	5314	21	1089	58	918	Yes
12	5256	23	326.2	18	3066	Yes
13	5268	9	1475	78	678	Yes
14	5284	5	1672	89	598	Yes
15	5299	6	1618	86	618	Yes
16	5270		1111	59	900	Yes
17	5260		1024	55	977	Yes
18	5309		625.8	34	1598	Yes
19	5314		730.5	39	1369	Yes
20	5266		1181	63	847	Yes
21	5260		400.6	22	2496	Yes
22	5327		529.4	28	1889	Yes
23	5264		347.6	19	2877	Yes
24	5273		641.4	34	1559	Yes
25	5314		508.9	27	1965	Yes
26	5260		345.4	19	2895	Yes
27	5254		580.7	31	1722	Yes
28	5275		786.8	42	1271	Yes
29	5318		808.4	43	1237	No
30	5278		517.1	28	1934	Yes

Detection Rate: 96.7 %

802.11ac (VHT80) CH58
Type 2 Radar Statistical Performances

Trial #	Test Frequency (MHz)	Pulses per Burst	Pulse Width(us)	PRI(us)	Detection
1	5290	24	1.7	174	Yes
2	5300	27	3.8	176	Yes
3	5320	28	4	161	Yes
4	5280	28	4.3	226	Yes
5	5260	24	1.9	193	Yes
6	5254	23	1.1	230	Yes
7	5280	29	4.5	198	Yes
8	5321	26	2.9	227	Yes
9	5308	26	2.8	171	No
10	5310	27	3.6	221	Yes
11	5310	23	1.1	180	No
12	5278	23	1.3	189	Yes
13	5278	25	2.5	204	Yes
14	5320	29	4.5	203	Yes
15	5273	29	5	170	Yes
16	5327	26	3.1	201	Yes
17	5291	24	2.1	218	Yes
18	5271	25	2.6	208	Yes
19	5262	24	1.8	223	Yes
20	5305	23	1.2	220	Yes
21	5258	26	2.9	224	Yes
22	5319	28	4	160	Yes
23	5299	25	2.5	209	Yes
24	5295	23	1	205	Yes
25	5296	27	3.7	151	Yes
26	5326	25	2.5	186	Yes
27	5288	23	1.5	190	Yes
28	5308	23	1.3	185	Yes
29	5313	23	1.2	175	Yes
30	5280	24	1.7	216	Yes

Detection Rate: 93.3 %

802.11ac (VHT80) CH58
Type 3 Radar Statistical Performances

Trial #	Test Frequency (MHz)	Pulses per Burst	Pulse Width(us)	PRI(us)	Detection
1	5290	16	6.7	467	Yes
2	5300	18	8.8	304	Yes
3	5320	18	9	316	Yes
4	5280	18	9.3	439	No
5	5260	16	6.9	420	Yes
6	5277	16	6.1	249	Yes
7	5316	18	9.5	463	Yes
8	5291	17	7.9	258	Yes
9	5274	17	7.8	212	Yes
10	5266	17	8.6	236	Yes
11	5320	16	6.1	474	No
12	5310	16	6.3	461	Yes
13	5295	17	7.5	437	Yes
14	5288	18	9.5	287	Yes
15	5271	18	10	395	Yes
16	5261	17	8.1	322	Yes
17	5279	16	7.1	468	Yes
18	5272	17	7.6	255	Yes
19	5323	16	6.8	423	Yes
20	5318	16	6.2	456	Yes
21	5263	17	7.9	351	No
22	5257	18	9	411	Yes
23	5326	17	7.5	279	No
24	5326	16	6	431	No
25	5279	17	8.7	324	Yes
26	5256	17	7.5	419	Yes
27	5283	16	6.5	447	No
28	5258	16	6.3	481	Yes
29	5274	16	6.2	438	Yes
30	5270	16	6.7	270	Yes

Detection Rate: 80 %

802.11ac (VHT80) CH58
Type 4 Radar Statistical Performances

Trial #	Test Frequency (MHz)	Pulses per Burst	Pulse Width(us)	PRI(us)	Detection
1	5290	12	12.5	467	Yes
2	5300	15	17.2	304	Yes
3	5320	15	17.8	316	Yes
4	5280	16	18.5	439	Yes
5	5260	13	13.1	420	No
6	5262	12	11.3	249	Yes
7	5301	16	18.8	463	Yes
8	5297	14	15.3	258	No
9	5297	14	15.1	212	Yes
10	5315	15	16.9	236	Yes
11	5312	12	11.2	474	Yes
12	5324	12	11.7	461	Yes
13	5311	13	14.4	437	Yes
14	5264	16	18.9	287	Yes
15	5323	16	19.9	395	No
16	5274	14	15.7	322	Yes
17	5281	13	13.4	468	Yes
18	5296	13	14.5	255	No
19	5292	13	12.9	423	Yes
20	5320	12	11.5	456	Yes
21	5315	14	15.3	351	Yes
22	5275	15	17.8	411	Yes
23	5323	13	14.3	279	Yes
24	5296	12	11.1	431	Yes
25	5277	15	17	324	No
26	5270	13	14.5	419	Yes
27	5307	12	12.1	447	Yes
28	5263	12	11.7	481	Yes
29	5282	12	11.6	438	Yes
30	5304	12	12.7	270	Yes

Detection Rate: 83.3 %

802.11ac (VHT80) CH58

Type 5 Radar Statistical Performances

Trial #	Minimum Chirp Width(MHz)	Chirp Center Frequency(MHz)	Test Signal Name	Detection
1	17	5290	LP_Signal_01	No
2	7	5290	LP_Signal_02	Yes
3	8	5290	LP_Signal_03	Yes
4	19	5290	LP_Signal_04	Yes
5	12	5290	LP_Signal_05	Yes
6	11	5290	LP_Signal_06	Yes
7	6	5290	LP_Signal_07	Yes
8	20	5290	LP_Signal_08	Yes
9	6	5290	LP_Signal_09	Yes
10	12	5290	LP_Signal_10	Yes
11	16	5258	LP_Signal_11	Yes
12	20	5260	LP_Signal_12	Yes
13	18	5259	LP_Signal_13	Yes
14	12	5257	LP_Signal_14	Yes
15	12	5257	LP_Signal_15	No
16	15	5258	LP_Signal_16	Yes
17	10	5256	LP_Signal_17	Yes
18	12	5257	LP_Signal_18	Yes
19	10	5256	LP_Signal_19	Yes
20	20	5260	LP_Signal_20	No
21	7	5325	LP_Signal_21	Yes
22	20	5320	LP_Signal_22	Yes
23	8	5325	LP_Signal_23	Yes
24	17	5321	LP_Signal_24	Yes
25	7	5325	LP_Signal_25	Yes
26	14	5322	LP_Signal_26	Yes
27	11	5324	LP_Signal_27	Yes
28	7	5325	LP_Signal_28	Yes
29	12	5323	LP_Signal_29	Yes
30	8	5325	LP_Signal_30	Yes

Detection Rate: 90 %

The Long Pulse Radar pattern shown in Appendix A.1

802.11ac (VHT80) CH58

Type 6 Radar Statistical Performances

Trial #	Pulses per Burst	Pulse Width(us)	PRI(us)	Detection
1	9	1	333.3	Yes
2	9	1	333.3	Yes
3	9	1	333.3	Yes
4	9	1	333.3	Yes
5	9	1	333.3	Yes
6	9	1	333.3	Yes
7	9	1	333.3	Yes
8	9	1	333.3	Yes
9	9	1	333.3	No
10	9	1	333.3	Yes
11	9	1	333.3	Yes
12	9	1	333.3	No
13	9	1	333.3	Yes
14	9	1	333.3	Yes
15	9	1	333.3	Yes
16	9	1	333.3	Yes
17	9	1	333.3	Yes
18	9	1	333.3	Yes
19	9	1	333.3	Yes
20	9	1	333.3	Yes
21	9	1	333.3	Yes
22	9	1	333.3	Yes
23	9	1	333.3	Yes
24	9	1	333.3	Yes
25	9	1	333.3	Yes
26	9	1	333.3	Yes
27	9	1	333.3	Yes
28	9	1	333.3	Yes
29	9	1	333.3	Yes
30	9	1	333.3	Yes

Detection Rate: 93.3 %

802.11ac (VHT80) CH58
Type 6 Radar Statistical Performances

Trial #	Hopping Frequency Sequence Name	Detection
1	HOP_FREQ_SEQ_01	Yes
2	HOP_FREQ_SEQ_02	Yes
3	HOP_FREQ_SEQ_03	Yes
4	HOP_FREQ_SEQ_04	Yes
5	HOP_FREQ_SEQ_05	Yes
6	HOP_FREQ_SEQ_06	Yes
7	HOP_FREQ_SEQ_07	Yes
8	HOP_FREQ_SEQ_08	Yes
9	HOP_FREQ_SEQ_09	No
10	HOP_FREQ_SEQ_10	Yes
11	HOP_FREQ_SEQ_11	Yes
12	HOP_FREQ_SEQ_12	No
13	HOP_FREQ_SEQ_13	Yes
14	HOP_FREQ_SEQ_14	Yes
15	HOP_FREQ_SEQ_15	Yes
16	HOP_FREQ_SEQ_16	Yes
17	HOP_FREQ_SEQ_17	Yes
18	HOP_FREQ_SEQ_18	Yes
19	HOP_FREQ_SEQ_19	Yes
20	HOP_FREQ_SEQ_20	Yes
21	HOP_FREQ_SEQ_21	Yes
22	HOP_FREQ_SEQ_22	Yes
23	HOP_FREQ_SEQ_23	Yes
24	HOP_FREQ_SEQ_24	Yes
25	HOP_FREQ_SEQ_25	Yes
26	HOP_FREQ_SEQ_26	Yes
27	HOP_FREQ_SEQ_27	Yes
28	HOP_FREQ_SEQ_28	Yes
29	HOP_FREQ_SEQ_29	Yes
30	HOP_FREQ_SEQ_30	Yes

Detection Rate: 93.3 %

The Frequency Hopping Radar pattern shown in Appendix A.2

802.11ac (VHT80) CH106
Type 1 Radar Statistical Performances

Trial #	Test Frequency (MHz)	Pulse Repetition Frequency Number (1 to 23)	Pulse Repetition Frequency (Pulse per seconds)	Pulses per Burst	Pulse Repetition Interval (microseconds)	Detection
1	5530	15	1253	67	798	No
2	5540	16	1223	65	818	Yes
3	5560	4	1730	92	578	Yes
4	5520	11	1393	74	718	Yes
5	5500	22	1066	57	938	Yes
6	5532	7	1567	83	638	Yes
7	5547	2	1859	99	538	Yes
8	5546	8	1520	81	658	Yes
9	5516	1	1931	102	518	Yes
10	5564	19	1139	61	878	Yes
11	5533	21	1089	58	918	Yes
12	5507	23	326.2	18	3066	Yes
13	5552	9	1475	78	678	Yes
14	5509	5	1672	89	598	Yes
15	5566	6	1618	86	618	Yes
16	5502		1111	59	900	Yes
17	5566		1024	55	977	Yes
18	5544		625.8	34	1598	Yes
19	5504		730.5	39	1369	Yes
20	5505		1181	63	847	Yes
21	5508		400.6	22	2496	No
22	5513		529.4	28	1889	Yes
23	5562		347.6	19	2877	Yes
24	5507		641.4	34	1559	Yes
25	5554		508.9	27	1965	Yes
26	5527		345.4	19	2895	No
27	5513		580.7	31	1722	Yes
28	5566		786.8	42	1271	Yes
29	5534		808.4	43	1237	Yes
30	5561		517.1	28	1934	No

Detection Rate: 86.7 %

802.11ac (VHT80) CH106

Type 2 Radar Statistical Performances

Trial #	Test Frequency (MHz)	Pulses per Burst	Pulse Width(us)	PRI(us)	Detection
1	5530	24	1.7	174	Yes
2	5540	27	3.8	176	Yes
3	5560	28	4	161	Yes
4	5520	28	4.3	226	Yes
5	5500	24	1.9	193	Yes
6	5527	23	1.1	230	Yes
7	5551	29	4.5	198	Yes
8	5526	26	2.9	227	Yes
9	5541	26	2.8	171	Yes
10	5511	27	3.6	221	Yes
11	5553	23	1.1	180	Yes
12	5555	23	1.3	189	Yes
13	5561	25	2.5	204	Yes
14	5541	29	4.5	203	Yes
15	5522	29	5	170	Yes
16	5493	26	3.1	201	No
17	5495	24	2.1	218	Yes
18	5547	25	2.6	208	No
19	5521	24	1.8	223	Yes
20	5555	23	1.2	220	Yes
21	5519	26	2.9	224	Yes
22	5546	28	4	160	Yes
23	5543	25	2.5	209	Yes
24	5553	23	1	205	Yes
25	5521	27	3.7	151	Yes
26	5494	25	2.5	186	No
27	5524	23	1.5	190	Yes
28	5519	23	1.3	185	Yes
29	5504	23	1.2	175	Yes
30	5547	24	1.7	216	Yes

Detection Rate: 90 %

802.11ac (VHT80) CH106

Type 3 Radar Statistical Performances

Trial #	Test Frequency (MHz)	Pulses per Burst	Pulse Width(us)	PRI(us)	Detection
1	5530	16	6.7	467	Yes
2	5540	18	8.8	304	Yes
3	5560	18	9	316	No
4	5520	18	9.3	439	Yes
5	5500	16	6.9	420	Yes
6	5497	16	6.1	249	Yes
7	5516	18	9.5	463	Yes
8	5529	17	7.9	258	Yes
9	5508	17	7.8	212	Yes
10	5524	17	8.6	236	Yes
11	5522	16	6.1	474	Yes
12	5560	16	6.3	461	No
13	5542	17	7.5	437	Yes
14	5522	18	9.5	287	Yes
15	5561	18	10	395	Yes
16	5509	17	8.1	322	Yes
17	5512	16	7.1	468	Yes
18	5535	17	7.6	255	Yes
19	5556	16	6.8	423	Yes
20	5540	16	6.2	456	Yes
21	5502	17	7.9	351	Yes
22	5494	18	9	411	No
23	5525	17	7.5	279	Yes
24	5494	16	6	431	Yes
25	5515	17	8.7	324	Yes
26	5564	17	7.5	419	No
27	5497	16	6.5	447	Yes
28	5565	16	6.3	481	Yes
29	5503	16	6.2	438	Yes
30	5552	16	6.7	270	Yes

Detection Rate: 86.7 %

802.11ac (VHT80) CH106

Type 4 Radar Statistical Performances

Trial #	Test Frequency (MHz)	Pulses per Burst	Pulse Width(us)	PRI(us)	Detection
1	5530	12	12.5	467	Yes
2	5540	15	17.2	304	Yes
3	5560	15	17.8	316	Yes
4	5520	16	18.5	439	Yes
5	5500	13	13.1	420	Yes
6	5561	12	11.3	249	No
7	5548	16	18.8	463	No
8	5550	14	15.3	258	Yes
9	5564	14	15.1	212	No
10	5504	15	16.9	236	No
11	5545	12	11.2	474	No
12	5539	12	11.7	461	Yes
13	5554	13	14.4	437	No
14	5548	16	18.9	287	Yes
15	5557	16	19.9	395	Yes
16	5518	14	15.7	322	Yes
17	5515	13	13.4	468	Yes
18	5512	13	14.5	255	Yes
19	5529	13	12.9	423	Yes
20	5526	12	11.5	456	No
21	5515	14	15.3	351	Yes
22	5536	15	17.8	411	No
23	5559	13	14.3	279	Yes
24	5534	12	11.1	431	Yes
25	5553	15	17	324	Yes
26	5550	13	14.5	419	No
27	5561	12	12.1	447	Yes
28	5552	12	11.7	481	Yes
29	5564	12	11.6	438	Yes
30	5547	12	12.7	270	Yes

Detection Rate: 70 %

802.11ac (VHT80) CH106
Type 5 Radar Statistical Performances

Trial #	Minimum Chirp Width(MHz)	Chirp Center Frequency(MHz)	Test Signal Name	Detection
1	17	5530	LP_Signal_01	Yes
2	7	5530	LP_Signal_02	Yes
3	8	5530	LP_Signal_03	Yes
4	19	5530	LP_Signal_04	Yes
5	12	5530	LP_Signal_05	Yes
6	11	5530	LP_Signal_06	No
7	6	5530	LP_Signal_07	Yes
8	20	5530	LP_Signal_08	Yes
9	6	5530	LP_Signal_09	Yes
10	12	5530	LP_Signal_10	Yes
11	16	5498	LP_Signal_11	Yes
12	20	5500	LP_Signal_12	Yes
13	18	5499	LP_Signal_13	Yes
14	12	5497	LP_Signal_14	Yes
15	12	5497	LP_Signal_15	Yes
16	15	5498	LP_Signal_16	Yes
17	10	5496	LP_Signal_17	Yes
18	12	5497	LP_Signal_18	Yes
19	10	5496	LP_Signal_19	Yes
20	20	5500	LP_Signal_20	No
21	7	5565	LP_Signal_21	Yes
22	20	5560	LP_Signal_22	No
23	8	5565	LP_Signal_23	Yes
24	17	5561	LP_Signal_24	Yes
25	7	5565	LP_Signal_25	Yes
26	14	5562	LP_Signal_26	Yes
27	11	5564	LP_Signal_27	Yes
28	7	5565	LP_Signal_28	Yes
29	12	5563	LP_Signal_29	Yes
30	8	5565	LP_Signal_30	Yes

Detection Rate: 90 %

The Long Pulse Radar pattern shown in Appendix A.1

802.11ac (VHT80) CH106

Type 6 Radar Statistical Performances

Trial #	Pulses per Burst	Pulse Width(us)	PRI(us)	Detection
1	9	1	333.3	Yes
2	9	1	333.3	Yes
3	9	1	333.3	Yes
4	9	1	333.3	Yes
5	9	1	333.3	No
6	9	1	333.3	Yes
7	9	1	333.3	Yes
8	9	1	333.3	Yes
9	9	1	333.3	Yes
10	9	1	333.3	Yes
11	9	1	333.3	No
12	9	1	333.3	Yes
13	9	1	333.3	Yes
14	9	1	333.3	Yes
15	9	1	333.3	Yes
16	9	1	333.3	Yes
17	9	1	333.3	Yes
18	9	1	333.3	Yes
19	9	1	333.3	Yes
20	9	1	333.3	Yes
21	9	1	333.3	Yes
22	9	1	333.3	Yes
23	9	1	333.3	Yes
24	9	1	333.3	Yes
25	9	1	333.3	Yes
26	9	1	333.3	Yes
27	9	1	333.3	Yes
28	9	1	333.3	Yes
29	9	1	333.3	No
30	9	1	333.3	Yes

Detection Rate: 90 %

802.11ac (VHT80) CH106

Type 6 Radar Statistical Performances

Trial #	Hopping Frequency Sequence Name	Detection
1	HOP_FREQ_SEQ_01	Yes
2	HOP_FREQ_SEQ_02	Yes
3	HOP_FREQ_SEQ_03	Yes
4	HOP_FREQ_SEQ_04	Yes
5	HOP_FREQ_SEQ_05	No
6	HOP_FREQ_SEQ_06	Yes
7	HOP_FREQ_SEQ_07	Yes
8	HOP_FREQ_SEQ_08	Yes
9	HOP_FREQ_SEQ_09	Yes
10	HOP_FREQ_SEQ_10	Yes
11	HOP_FREQ_SEQ_11	No
12	HOP_FREQ_SEQ_12	Yes
13	HOP_FREQ_SEQ_13	Yes
14	HOP_FREQ_SEQ_14	Yes
15	HOP_FREQ_SEQ_15	Yes
16	HOP_FREQ_SEQ_16	Yes
17	HOP_FREQ_SEQ_17	Yes
18	HOP_FREQ_SEQ_18	Yes
19	HOP_FREQ_SEQ_19	Yes
20	HOP_FREQ_SEQ_20	Yes
21	HOP_FREQ_SEQ_21	Yes
22	HOP_FREQ_SEQ_22	Yes
23	HOP_FREQ_SEQ_23	Yes
24	HOP_FREQ_SEQ_24	Yes
25	HOP_FREQ_SEQ_25	Yes
26	HOP_FREQ_SEQ_26	Yes
27	HOP_FREQ_SEQ_27	Yes
28	HOP_FREQ_SEQ_28	Yes
29	HOP_FREQ_SEQ_29	No
30	HOP_FREQ_SEQ_30	Yes

Detection Rate: 90 %

The Frequency Hopping Radar pattern shown in Appendix A.2

6.2.5 Non- Occupancy Period

1) Test results demonstrating an associated client link is established with the master on a test frequency.

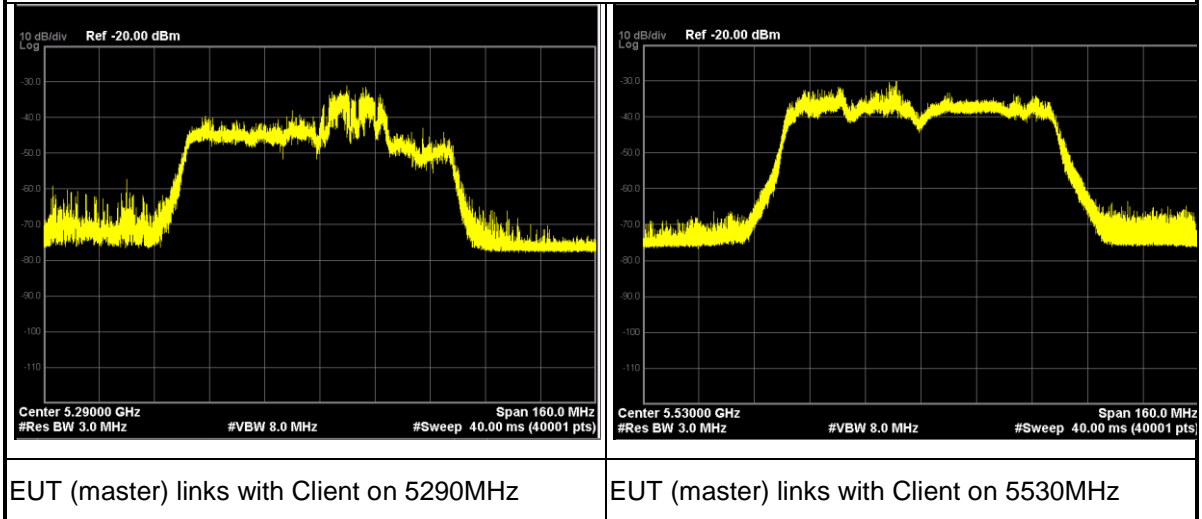

2) The master and DFS-certified client device are associated, and system testing will be performed with channel-loading for a non-occupancy period test.

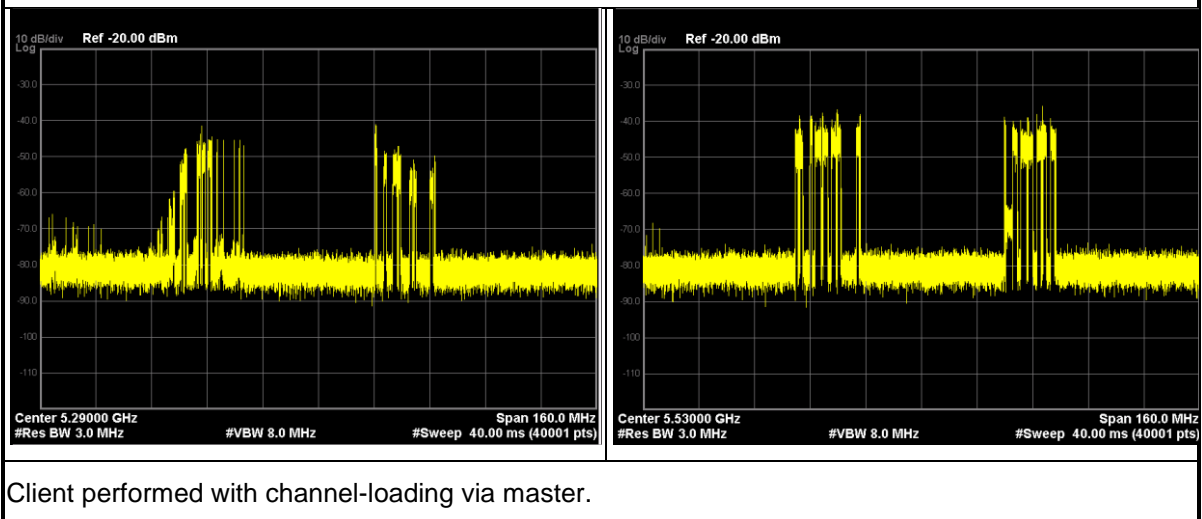

3). The device transmits one type of radar as specified in the DFS Order.

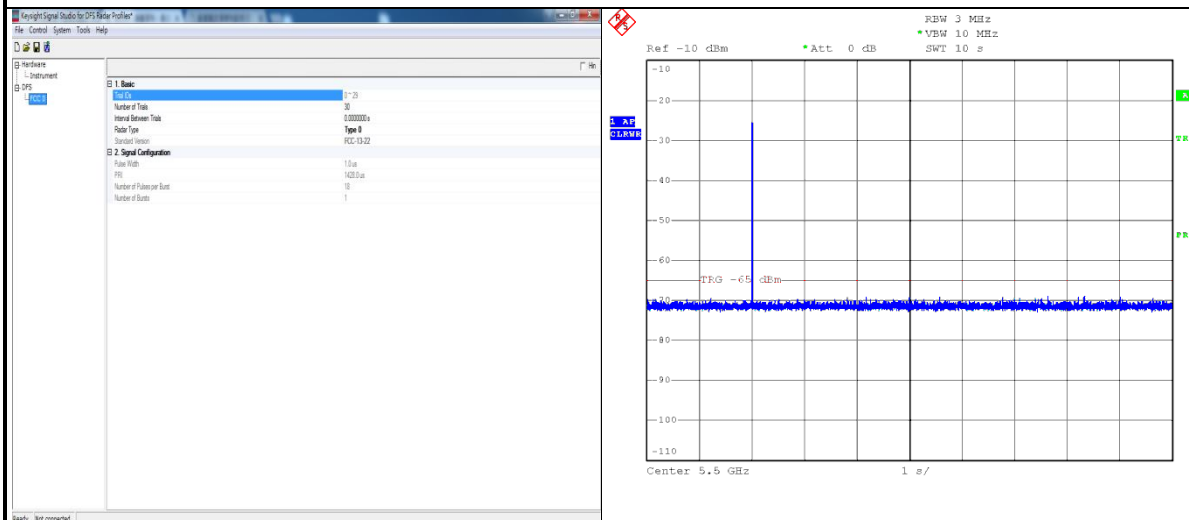

Radar 0 is used to test during DFS testing.

4) The test frequency has been monitored to ensure no transmission of any type has occurred for 30 minutes;

Note: If the client moves with the master, the device is considered compliant if nothing appears in the client non-occupancy period test. For devices that shut down (rather than moving channels), no beacons should appear;

5) An analyzer plot that contains a single 30-minute sweep on the original test frequency.

Non - Occupancy Period @ CH58 - 5290MHz

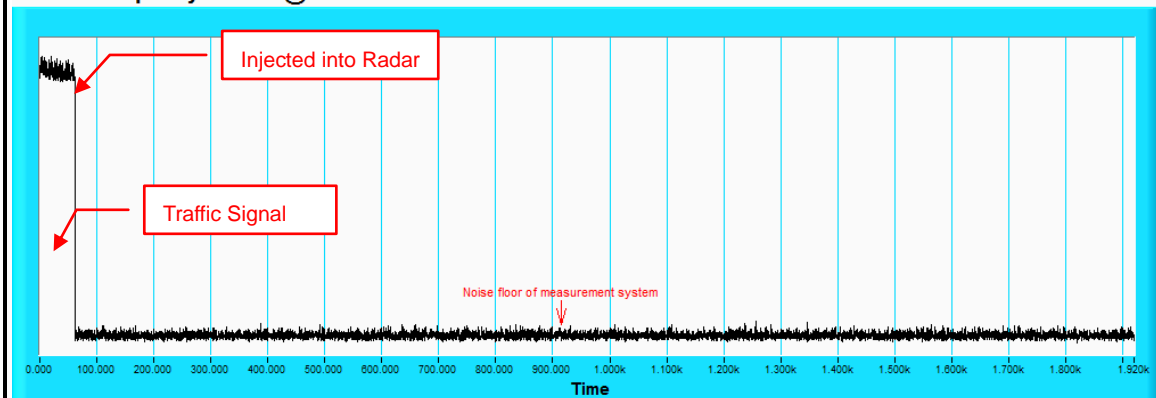

Non - Occupancy Period @ CH106 - 5530MHz

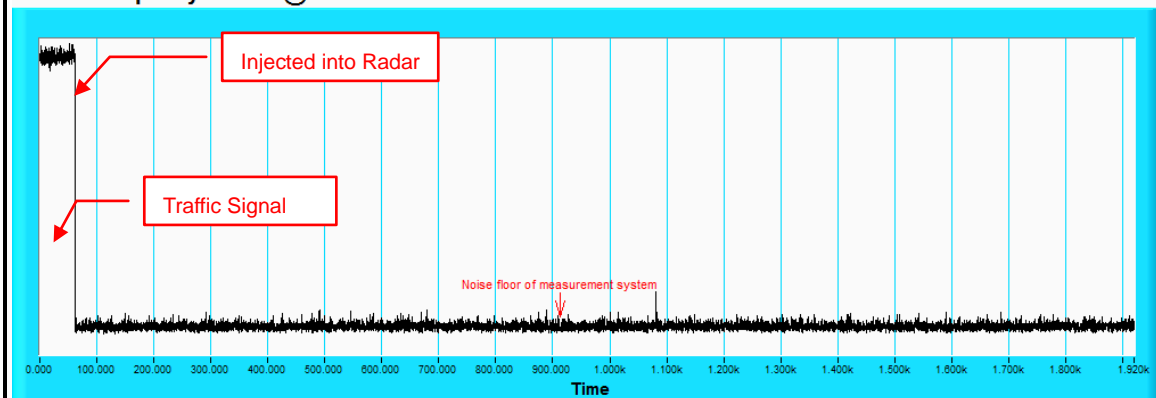

7. Information on the Testing Laboratories

We, Bureau Veritas Consumer Products Services (H.K.) Ltd., Taoyuan Branch, were founded in 1988 to provide our best service in EMC, Radio, Telecom and Safety consultation. Our laboratories are accredited and approved according to ISO/IEC 17025.

If you have any comments, please feel free to contact us at the following:

Linko EMC/RF Lab:

Tel: 886-2-26052180

Fax: 886-2-26051924

Hsin Chu EMC/RF/Telecom Lab:

Tel: 886-3-6668565

Fax: 886-3-6668323

Hwa Ya EMC/RF/Safety Lab:

Tel: 886-3-3183232

Fax: 886-3-3270892

Email: service.adt@tw.bureauveritas.com

Web Site: www.bureauveritas-adt.com

The address and road map of all our labs can be found in our web site also.

8. Appendix-A

RADAR TEST SIGNAL

A.1 The Long Pulse Radar Pattern

Long Pulse Radar Test Signal

Test Signal Name: LP_Signal_01

Number of Bursts in Trial: 18

Burst	Pulses per Burst	Chrip (MHz)	Pulse Width(us)	PRI-1 (us)	PRI-2 (us)	PRI-3 (us)
1	3	17	89.4	1750	1823	1091
2	1	17	57.6	1831	-	-
3	1	17	62.1	1839	-	-
4	3	17	94.8	1258	1771	1217
5	2	17	74.7	1246	1854	-
6	2	17	70.3	1286	1132	-
7	1	17	55.3	1409	-	-
8	3	17	99.3	1879	1810	1391
9	1	17	53.5	1673	-	-
10	2	17	74.6	1448	1969	-
11	3	17	85.5	1999	1087	1140
12	3	17	99.3	1602	1435	1376
13	3	17	91	1211	1374	1783
14	2	17	73.8	1924	1124	-
15	2	17	74.1	1641	1247	-
16	2	17	82.2	1904	1345	-
17	2	17	68.6	1168	1844	-
18	2	17	74.8	1444	1778	-
19						
20						

Long Pulse Radar Test Signal

Test Signal Name: LP_Signal_02

Number of Bursts in Trial: 9

Burst	Pulses per Burst	Chrip (MHz)	Pulse Width(us)	PRI-1 (us)	PRI-2 (us)	PRI-3 (us)
1	2	7	67.7	1691	1157	-
2	3	7	99.8	1097	1766	1178
3	1	7	56.9	1188	-	-
4	3	7	99.1	1208	1655	1974
5	1	7	60.8	1480	-	-
6	3	7	88.3	1272	1863	1474
7	1	7	57.5	1911	-	-
8	2	7	80.3	1455	1881	-
9	2	7	71.4	1137	1241	0
10						
11						
12						
13						
14						
15						
16						
17						
18						
19						
20						

Long Pulse Radar Test Signal

Test Signal Name: LP_Signal_03

Number of Bursts in Trial: 11

Burst	Pulses per Burst	Chrip (MHz)	Pulse Width(us)	PRI-1 (us)	PRI-2 (us)	PRI-3 (us)
1	1	8	58.9	1295	-	-
2	2	8	72.6	1375	1213	-
3	1	8	60.7	1039	-	-
4	2	8	70.8	1230	1064	-
5	1	8	51.9	1025	-	-
6	2	8	67.5	1895	1802	-
7	2	8	80.8	1550	1533	-
8	2	8	68.6	1525	1221	-
9	3	8	92.4	1651	1985	1505
10	3	8	87	1671	1451	1643
11	2	8	70.9	1439	1724	-
12						
13						
14						
15						
16						
17						
18						
19						
20						

Long Pulse Radar Test Signal

Test Signal Name: LP_Signal_04

Number of Bursts in Trial: 19

Burst	Pulses per Burst	Chrip (MHz)	Pulse Width(us)	PRI-1 (us)	PRI-2 (us)	PRI-3 (us)
1	2	19	81.2	1922	1020	-
2	1	19	57.6	1677	-	-
3	3	19	84.9	1073	1244	1949
4	2	19	83.1	1935	1174	-
5	2	19	71.1	1542	1560	-
6	1	19	55.1	1790	-	-
7	1	19	54.4	1396	-	-
8	3	19	90.6	1035	1886	1980
9	3	19	92.2	1950	1759	1163
10	3	19	92.5	1108	1661	1358
11	2	19	79.5	1441	1957	-
12	2	19	76.3	1259	1876	-
13	1	19	65.7	1880	-	-
14	3	19	99.4	1971	1493	1004
15	3	19	89.5	1238	1700	1581
16	2	19	79.1	1906	1546	-
17	1	19	60	1019	-	-
18	3	19	90.3	1808	1034	1199
19	3	19	96.8	1869	1993	1967
20						

Long Pulse Radar Test Signal

Test Signal Name: LP_Signal_05

Number of Bursts in Trial: 14

Burst	Pulses per Burst	Chrip (MHz)	Pulse Width(us)	PRI-1 (us)	PRI-2 (us)	PRI-3 (us)
1	2	12	73.8	1686	1255	-
2	3	12	87.2	1201	1621	1693
3	3	12	94.4	1503	1529	1431
4	3	12	99	1308	1366	1481
5	3	12	96.5	1318	1418	1452
6	2	12	76.6	1695	1170	-
7	3	12	92.8	1304	1113	1835
8	1	12	53.8	1068	-	-
9	3	12	83.6	1384	1593	1212
10	2	12	81.8	1395	1768	-
11	1	12	60.2	1129	-	-
12	1	12	55.1	1045	-	-
13	2	12	81.8	1984	1703	-
14	3	12	95.3	1992	1828	1932
15						
16						
17						
18						
19						
20						

Long Pulse Radar Test Signal

Test Signal Name: LP_Signal_06

Number of Bursts in Trial: 13

Burst	Pulses per Burst	Chrip (MHz)	Pulse Width(us)	PRI-1 (us)	PRI-2 (us)	PRI-3 (us)
1	3	11	97.7	1350	1354	1424
2	3	11	93.6	1779	1273	1540
3	1	11	60	1065	-	-
4	1	11	64.8	1956	-	-
5	2	11	73.9	1390	1794	-
6	2	11	77.9	1670	1206	-
7	1	11	55.7	1942	-	-
8	3	11	83.9	1105	1853	1440
9	2	11	66.9	1819	1281	-
10	3	11	88.2	1734	1361	1371
11	2	11	79	1400	1522	-
12	2	11	79.4	1516	1031	-
13	3	11	96.4	1328	1845	1833
14						
15						
16						
17						
18						
19						
20						

Long Pulse Radar Test Signal

Test Signal Name: LP_Signal_07

Number of Bursts in Trial: 9

Burst	Pulses per Burst	Chrip (MHz)	Pulse Width(us)	PRI-1 (us)	PRI-2 (us)	PRI-3 (us)
1	3	6	95.1	1436	1883	1146
2	2	6	71.5	1669	1952	-
3	1	6	62.5	1309	-	-
4	3	6	88.5	1797	1846	1528
5	2	6	70.7	1976	1714	-
6	2	6	78.3	1943	1873	-
7	3	6	95.6	1763	1887	1977
8	1	6	63.1	1434	-	-
9	3	6	83.7	1069	1236	1277
10						
11						
12						
13						
14						
15						
16						
17						
18						
19						
20						

Long Pulse Radar Test Signal

Test Signal Name: LP_Signal_08

Number of Bursts in Trial: 20

Burst	Pulses per Burst	Chrip (MHz)	Pulse Width(us)	PRI-1 (us)	PRI-2 (us)	PRI-3 (us)
1	3	20	86.9	1257	1010	1287
2	1	20	58.7	1628	-	-
3	3	20	88.4	1800	1214	1234
4	1	20	56.4	1340	-	-
5	2	20	78.4	1792	1243	-
6	1	20	51.3	1416	-	-
7	2	20	70.8	1645	1975	-
8	1	20	58.8	1755	-	-
9	2	20	82	1476	1356	-
10	3	20	87.3	1650	1941	1834
11	3	20	97.8	1898	1608	1523
12	2	20	81.1	1696	1870	-
13	2	20	68.1	1652	1323	-
14	1	20	55.7	1814	-	-
15	2	20	79.4	1078	1527	-
16	1	20	64.2	1667	-	-
17	3	20	86.2	1052	1038	1690
18	1	20	62.3	1494	-	-
19	3	20	91.1	1885	1460	1013
20	3	20	89.9	1603	1592	1239

Long Pulse Radar Test Signal

Test Signal Name: LP_Signal_09

Number of Bursts in Trial: 8

Burst	Pulses per Burst	Chrip (MHz)	Pulse Width(us)	PRI-1 (us)	PRI-2 (us)	PRI-3 (us)
1	2	6	70.2	1773	1471	-
2	1	6	56.2	1180	-	-
3	2	6	69.9	1042	1393	-
4	2	6	67	1569	1594	-
5	2	6	80.3	1292	1588	-
6	3	6	97.8	1338	1678	1114
7	2	6	82.3	1803	1185	-
8	2	6	71.1	1564	1164	-
9						
10						
11						
12						
13						
14						
15						
16						
17						
18						
19						
20						

Long Pulse Radar Test Signal

Test Signal Name: LP_Signal_10

Number of Bursts in Trial: 14

Burst	Pulses per Burst	Chrip (MHz)	Pulse Width(us)	PRI-1 (us)	PRI-2 (us)	PRI-3 (us)
1	3	12	93.3	1781	1456	1265
2	3	12	89.5	1276	1002	1998
3	2	12	76.9	1607	1538	-
4	3	12	86.2	1261	1890	1231
5	2	12	82.1	1559	1369	-
6	1	12	63.9	1752	-	-
7	1	12	56.7	1225	-	-
8	1	12	51.3	1183	-	-
9	2	12	76.5	1498	1486	-
10	2	12	67.4	1235	1381	-
11	3	12	99.6	1582	1629	1177
12	1	12	54.4	1983	-	-
13	1	12	63.1	1953	-	-
14	1	12	58.1	1075	-	-
15						
16						
17						
18						
19						
20						

Long Pulse Radar Test Signal

Test Signal Name: LP_Signal_11

Number of Bursts in Trial: 17

Burst	Pulses per Burst	Chrip (MHz)	Pulse Width(us)	PRI-1 (us)	PRI-2 (us)	PRI-3 (us)
1	1	16	56.2	1389	-	-
2	3	16	91.7	1227	1497	1722
3	2	16	81.7	1437	1561	-
4	1	16	65.2	1001	-	-
5	2	16	76.9	1649	1267	-
6	1	16	65.7	1962	-	-
7	2	16	83.1	1242	1536	-
8	2	16	74.3	1972	1030	-
9	3	16	84.6	1148	1675	1683
10	1	16	66	1398	-	-
11	1	16	54.4	1368	-	-
12	2	16	73.2	1692	1156	-
13	1	16	63.5	1508	-	-
14	2	16	80.7	1506	1426	-
15	3	16	88.8	1939	1738	1841
16	2	16	71.3	1430	1705	-
17	2	16	76.2	1182	1708	-
18						
19						
20						

Long Pulse Radar Test Signal

Test Signal Name: LP_Signal_12

Number of Bursts in Trial: 20

Burst	Pulses per Burst	Chrip (MHz)	Pulse Width(us)	PRI-1 (us)	PRI-2 (us)	PRI-3 (us)
1	2	20	80.6	1716	1419	-
2	2	20	69	1197	1349	-
3	3	20	99.8	1300	1756	1712
4	1	20	65.5	1028	-	-
5	3	20	92.5	1857	1534	1544
6	1	20	60.4	1640	-	-
7	1	20	61.5	1761	-	-
8	3	20	99	1457	1908	1599
9	1	20	54.1	1487	-	-
10	3	20	99.1	1720	1314	1945
11	2	20	78	1155	1829	-
12	3	20	87.8	1812	1617	1159
13	2	20	68.8	1458	1438	-
14	1	20	62.7	1672	-	-
15	3	20	86.7	1618	1422	1224
16	2	20	76.8	1056	1934	-
17	1	20	62	1006	-	-
18	1	20	50	1884	-	-
19	2	20	78.2	1330	1630	-
20	3	20	85.3	1464	1955	1960

Long Pulse Radar Test Signal

Test Signal Name: LP_Signal_13

Number of Bursts in Trial: 18

Burst	Pulses per Burst	Chrip (MHz)	Pulse Width(us)	PRI-1 (us)	PRI-2 (us)	PRI-3 (us)
1	1	18	65	1066	-	-
2	2	18	70.8	1929	1636	-
3	1	18	66.5	1094	-	-
4	3	18	88	1855	1252	1111
5	2	18	69	1290	1859	-
6	1	18	54.9	1551	-	-
7	1	18	60.8	2000	-	-
8	2	18	81.8	1585	1864	-
9	1	18	58.8	1130	-	-
10	1	18	50.4	1169	-	-
11	2	18	76	1325	1445	-
12	1	18	62.6	1530	-	-
13	1	18	55.1	1851	-	-
14	3	18	91.2	1181	1302	1966
15	2	18	68.9	1348	1355	-
16	3	18	85.4	1537	1758	1109
17	1	18	63.4	1011	-	-
18	3	18	92.7	1122	1333	1584
19						
20						

Long Pulse Radar Test Signal

Test Signal Name: LP_Signal_14

Number of Bursts in Trial: 14

Burst	Pulses per Burst	Chrip (MHz)	Pulse Width(us)	PRI-1 (us)	PRI-2 (us)	PRI-3 (us)
1	1	12	63.7	1830	-	-
2	2	12	81.3	1110	1746	-
3	2	12	70.2	1334	1187	-
4	1	12	66.3	1587	-	-
5	2	12	72.8	1578	1745	-
6	2	12	66.7	1694	1931	-
7	1	12	55.1	1284	-	-
8	3	12	86.5	1089	1490	1762
9	1	12	65.7	1084	-	-
10	1	12	53.2	1268	-	-
11	2	12	67.8	1625	1411	-
12	3	12	96.5	1576	1799	1233
13	1	12	51.4	1373	-	-
14	2	12	80.7	1098	1849	-
15						
16						
17						
18						
19						
20						

Long Pulse Radar Test Signal

Test Signal Name: LP_Signal_15

Number of Bursts in Trial: 14

Burst	Pulses per Burst	Chrip (MHz)	Pulse Width(us)	PRI-1 (us)	PRI-2 (us)	PRI-3 (us)
1	1	12	60.5	1668	-	-
2	3	12	86	1786	1666	1266
3	1	12	61.2	1228	-	-
4	1	12	59.8	1204	-	-
5	1	12	52.5	1021	-	-
6	1	12	61.7	1634	-	-
7	3	12	96.5	1741	1875	1296
8	3	12	87.6	1093	1250	1172
9	3	12	99.6	1215	1813	1820
10	2	12	79.7	1327	1512	-
11	3	12	90.2	1589	1145	1082
12	1	12	53.7	1136	-	-
13	2	12	73	1706	1526	-
14	1	12	65.4	1420	-	-
15						
16						
17						
18						
19						
20						

Long Pulse Radar Test Signal

Test Signal Name: LP_Signal_16

Number of Bursts in Trial: 16

Burst	Pulses per Burst	Chrip (MHz)	Pulse Width(us)	PRI-1 (us)	PRI-2 (us)	PRI-3 (us)
1	2	15	82.6	1347	1485	-
2	2	15	77.6	1312	1500	-
3	3	15	93.8	1062	1005	1749
4	1	15	51.3	1809	-	-
5	1	15	63.4	1699	-	-
6	2	15	69.4	1606	1219	-
7	3	15	86.3	1102	1878	1728
8	3	15	97	1192	1858	1772
9	1	15	65.1	1363	-	-
10	3	15	98.8	1083	1567	1961
11	3	15	98.1	1473	1271	1263
12	3	15	99.9	1780	1871	1249
13	2	15	82.9	1785	1081	-
14	2	15	82.5	1501	1921	-
15	3	15	89.2	1767	1357	1479
16	1	15	57.5	1891	-	-
17						
18						
19						
20						

Long Pulse Radar Test Signal

Test Signal Name: LP_Signal_17

Number of Bursts in Trial: 12

Burst	Pulses per Burst	Chrip (MHz)	Pulse Width(us)	PRI-1 (us)	PRI-2 (us)	PRI-3 (us)
1	1	10	63.9	1331	-	-
2	1	10	62.4	1897	-	-
3	3	10	99.1	1769	1832	1647
4	3	10	95.4	1991	1085	1937
5	1	10	52	1029	-	-
6	2	10	69.1	1637	1611	-
7	2	10	80	1447	1685	-
8	1	10	59.1	1635	-	-
9	2	10	82.8	1134	1080	-
10	1	10	51.6	1138	-	-
11	3	10	96.2	1165	1754	1269
12	2	10	76.1	1406	1818	-
13						
14						
15						
16						
17						
18						
19						
20						

Long Pulse Radar Test Signal

Test Signal Name: LP_Signal_18

Number of Bursts in Trial: 14

Burst	Pulses per Burst	Chrip (MHz)	Pulse Width(us)	PRI-1 (us)	PRI-2 (us)	PRI-3 (us)
1	2	12	81.7	1946	1868	-
2	3	12	90.5	1414	1453	1305
3	2	12	76.2	2000	1852	-
4	2	12	69.1	1351	1071	-
5	3	12	93.7	1865	1196	1782
6	3	12	89.7	1429	1948	1402
7	1	12	53.9	1070	-	-
8	3	12	88.2	1632	1940	1689
9	1	12	59.4	1733	-	-
10	1	12	66.4	1285	-	-
11	2	12	83	1321	1591	-
12	2	12	82	1912	1012	-
13	3	12	94.4	1698	1784	1303
14	1	12	63.6	1175	-	-
15						
16						
17						
18						
19						
20						

Long Pulse Radar Test Signal

Test Signal Name: LP_Signal_19

Number of Bursts in Trial: 12

Burst	Pulses per Burst	Chrip (MHz)	Pulse Width(us)	PRI-1 (us)	PRI-2 (us)	PRI-3 (us)
1	2	10	70.9	1736	1367	-
2	1	10	62.4	1193	-	-
3	1	10	61.8	1596	-	-
4	1	10	52.6	1646	-	-
5	2	10	78.9	1049	1639	-
6	1	10	63.9	1679	-	-
7	3	10	98.5	1627	1731	1442
8	3	10	92	1294	1547	1119
9	1	10	65.8	1386	-	-
10	2	10	77.7	1987	1964	-
11	1	10	54.6	1553	-	-
12	2	10	77.7	1171	1413	-
13						
14						
15						
16						
17						
18						
19						
20						

Long Pulse Radar Test Signal

Test Signal Name: LP_Signal_20

Number of Bursts in Trial: 20

Burst	Pulses per Burst	Chrip (MHz)	Pulse Width(us)	PRI-1 (us)	PRI-2 (us)	PRI-3 (us)
1	1	20	63.4	1899	-	-
2	1	20	63.5	1633	-	-
3	3	20	97.6	1815	1198	1488
4	3	20	84.7	1626	1026	1326
5	2	20	68.5	1469	1684	-
6	1	20	61.8	1408	-	-
7	2	20	73.2	1735	1125	-
8	1	20	60.2	1468	-	-
9	1	20	65.2	1519	-	-
10	2	20	74.6	1954	1654	-
11	2	20	72.6	1394	1096	-
12	2	20	78.9	1343	1843	-
13	1	20	56.2	1003	-	-
14	3	20	93.2	1433	1299	1324
15	2	20	78.6	1404	1539	-
16	1	20	50.9	1570	-	-
17	3	20	98.2	1346	1179	1510
18	3	20	97.5	1616	1360	1710
19	2	20	79.5	1822	1721	-
20	2	20	67	1554	1237	-

Long Pulse Radar Test Signal

Test Signal Name: LP_Signal_21

Number of Bursts in Trial: 9

Burst	Pulses per Burst	Chrip (MHz)	Pulse Width(us)	PRI-1 (us)	PRI-2 (us)	PRI-3 (us)
1	1	7	51	1893	-	-
2	3	7	88.5	1270	1664	1623
3	3	7	98.2	1979	1826	1128
4	2	7	67.5	1417	1586	-
5	3	7	97.4	1642	1121	1770
6	2	7	80.2	1816	1060	-
7	2	7	72.8	1619	1203	-
8	2	7	82.2	1499	1848	-
9	2	7	77.6	1562	1573	-
10						
11						
12						
13						
14						
15						
16						
17						
18						
19						
20						

Long Pulse Radar Test Signal

Test Signal Name: LP_Signal_22

Number of Bursts in Trial: 20

Burst	Pulses per Burst	Chrip (MHz)	Pulse Width(us)	PRI-1 (us)	PRI-2 (us)	PRI-3 (us)
1	3	20	89.8	1742	1968	1036
2	2	20	74.7	1850	1306	-
3	3	20	98.5	1123	1336	1791
4	1	20	64.4	1740	-	-
5	1	20	66	1000	-	-
6	2	20	76.3	1521	1928	-
7	3	20	90.4	1764	1383	1726
8	3	20	90.6	1896	1653	1697
9	2	20	74.8	1995	1938	-
10	3	20	98	1251	1520	1725
11	2	20	71.2	1775	1240	-
12	1	20	58.8	1195	-	-
13	3	20	84.1	1475	1472	1590
14	3	20	98.4	1274	1282	1918
15	3	20	96.4	1131	1739	1009
16	3	20	89.9	1484	1283	1412
17	2	20	82.9	1729	1571	-
18	3	20	96.5	1978	1478	1555
19	3	20	85.7	1872	1737	1847
20	3	20	85.4	1387	1151	1531

Long Pulse Radar Test Signal

Test Signal Name: LP_Signal_23

Number of Bursts in Trial: 10

Burst	Pulses per Burst	Chrip (MHz)	Pulse Width(us)	PRI-1 (us)	PRI-2 (us)	PRI-3 (us)
1	3	8	97.6	1568	1676	1023
2	3	8	93.9	1407	1682	1209
3	2	8	68.3	1807	1365	-
4	3	8	98.3	1107	1882	1524
5	3	8	87.6	1557	1342	1910
6	2	8	76.6	1033	1048	-
7	2	8	74.9	1101	1443	-
8	1	8	65.3	1341	-	-
9	2	8	80	1220	1015	-
10	3	8	87.4	1765	1316	1377
11						
12						
13						
14						
15						
16						
17						
18						
19						
20						

Long Pulse Radar Test Signal

Test Signal Name: LP_Signal_24

Number of Bursts in Trial: 17

Burst	Pulses per Burst	Chrip (MHz)	Pulse Width(us)	PRI-1 (us)	PRI-2 (us)	PRI-3 (us)
1	3	17	88.4	1279	1317	1150
2	3	17	89.1	1288	1660	1789
3	3	17	91	1385	1988	1461
4	2	17	82.6	1915	1059	-
5	2	17	75.5	1662	1982	-
6	3	17	99.9	1222	1796	1717
7	2	17	74.1	1877	1917	-
8	1	17	64.5	1380	-	-
9	3	17	90.3	1032	1613	1191
10	2	17	66.9	1158	1930	-
11	3	17	88.2	1753	1399	1507
12	1	17	60.4	1307	-	-
13	2	17	73.3	1152	1543	-
14	3	17	99.6	1207	1491	1297
15	1	17	58.2	1024	-	-
16	1	17	58.2	1925	-	-
17	2	17	66.9	1994	1090	-
18						
19						
20						

Long Pulse Radar Test Signal

Test Signal Name: LP_Signal_25

Number of Bursts in Trial: 9

Burst	Pulses per Burst	Chrip (MHz)	Pulse Width(us)	PRI-1 (us)	PRI-2 (us)	PRI-3 (us)
1	3	7	90.1	1465	1459	1862
2	1	7	51.8	1730	-	-
3	2	7	77.7	1874	1388	-
4	1	7	64.4	1401	-	-
5	3	7	83.7	1517	1861	1612
6	3	7	87.1	1981	1161	1541
7	3	7	96.9	1143	1757	1115
8	2	7	80.1	1232	1574	-
9	3	7	95.9	1051	1202	1344
10						
11						
12						
13						
14						
15						
16						
17						
18						
19						
20						

Long Pulse Radar Test Signal

Test Signal Name: LP_Signal_26

Number of Bursts in Trial: 15

Burst	Pulses per Burst	Chrip (MHz)	Pulse Width(us)	PRI-1 (us)	PRI-2 (us)	PRI-3 (us)
1	1	14	56.4	1379	-	-
2	1	14	50.2	1827	-	-
3	2	14	76.8	1189	1788	-
4	3	14	89.4	1713	1774	1743
5	1	14	51.3	1926	-	-
6	2	14	75	1958	1194	-
7	1	14	60.5	1631	-	-
8	3	14	87.5	1483	1825	1329
9	1	14	59.6	1495	-	-
10	2	14	82.2	1604	1421	-
11	2	14	67.8	1139	1482	-
12	1	14	51.5	1018	-	-
13	2	14	72.9	1135	1332	-
14	3	14	96.5	1116	1291	1665
15	1	14	65.7	1256	-	-
16						
17						
18						
19						
20						

Long Pulse Radar Test Signal

Test Signal Name: LP_Signal_27

Number of Bursts in Trial: 13

Burst	Pulses per Burst	Chrip (MHz)	Pulse Width(us)	PRI-1 (us)	PRI-2 (us)	PRI-3 (us)
1	2	11	68.4	1210	1254	-
2	1	11	56.2	1106	-	-
3	2	11	68.7	1989	1167	-
4	3	11	97.2	1963	1037	1860
5	3	11	87.1	1120	1335	1563
6	2	11	70.6	1298	1502	-
7	2	11	68.7	1747	1446	-
8	3	11	90	1315	1072	1226
9	2	11	79.4	1577	1311	-
10	1	11	59.6	1176	-	-
11	3	11	84.9	1027	1727	1260
12	1	11	63.5	1605	-	-
13	1	11	52.3	1702	-	-
14						
15						
16						
17						
18						
19						
20						

Long Pulse Radar Test Signal

Test Signal Name: LP_Signal_28

Number of Bursts in Trial: 10

Burst	Pulses per Burst	Chrip (MHz)	Pulse Width(us)	PRI-1 (us)	PRI-2 (us)	PRI-3 (us)
1	2	7	72.9	1622	1104	-
2	1	7	54.6	1609	-	-
3	1	7	51.9	1707	-	-
4	3	7	94.2	1173	1515	1688
5	1	7	52.5	1077	-	-
6	2	7	79.6	1054	1245	-
7	3	7	93.5	1575	1141	1046
8	2	7	73.9	1718	1638	-
9	3	7	87.7	1126	1462	1310
10	1	7	50.8	1154	-	-
11						
12						
13						
14						
15						
16						
17						
18						
19						
20						

Long Pulse Radar Test Signal

Test Signal Name: LP_Signal_29

Number of Bursts in Trial: 13

Burst	Pulses per Burst	Chrip (MHz)	Pulse Width(us)	PRI-1 (us)	PRI-2 (us)	PRI-3 (us)
1	1	12	65.6	1074	-	-
2	1	12	63.2	1477	-	-
3	3	12	99.9	1053	1805	1657
4	3	12	85.8	1293	1680	1184
5	3	12	90	1200	1511	1127
6	2	12	76.1	1017	1133	-
7	3	12	90.4	1043	1088	1362
8	1	12	65.4	1610	-	-
9	2	12	67.1	1824	1410	-
10	1	12	55.3	1278	-	-
11	1	12	61.9	1403	-	-
12	3	12	96.1	1923	1216	1744
13	2	12	77.5	1558	1253	-
14						
15						
16						
17						
18						
19						

Long Pulse Radar Test Signal

Test Signal Name: LP_Signal_30

Number of Bursts in Trial: 10

Burst	Pulses per Burst	Chrip (MHz)	Pulse Width(us)	PRI-1 (us)	PRI-2 (us)	PRI-3 (us)
1	2	8	68.4	1190	1907	-
2	3	8	99.7	1996	1806	1079
3	3	8	93	1777	1092	1337
4	2	8	75.3	1548	1583	-
5	3	8	87.7	1715	1889	1470
6	1	8	60.2	1008	-	-
7	3	8	97.5	1658	1514	1748
8	2	8	79.7	1532	1793	-
9	1	8	66.4	1014	-	-
10	1	8	61.4	1322	-	-
11						
12						
13						
14						
15						
16						
17						
18						
19						
20						

A.2 The Frequency Hopping Radar pattern

Hopping Frequency Sequence Name: HOP_FREQ_SEQ_01					
Frequency (MHz)	0	1	2	3	4
0	5436	5618	5502	5507	5674
5	5429	5363	5362	5339	5615
10	5432	5291	5566	5689	5400
15	5658	5277	5656	5265	5588
20	5643	5342	5449	5558	5600
25	5557	5293	5478	5488	5560
30	5331	5350	5559	5604	5505
35	5251	5413	5292	5424	5703
40	5596	5433	5266	5273	5548
45	5437	5253	5447	5628	5286
50	5340	5690	5302	5441	5439
55	5421	5694	5417	5609	5576
60	5305	5351	5288	5354	5335
65	5620	5657	5686	5711	5663
70	5610	5297	5634	5510	5426
75	5357	5667	5370	5387	5281
80	5585	5524	5338	5385	5673
85	5464	5693	5455	5633	5712
90	5679	5269	5607	5651	5352
95	5358	5612	5289	5397	5402

Hopping Frequency Sequence Name: HOP_FREQ_SEQ_02					
Frequency (MHz)	0	1	2	3	4
0	5691	5382	5438	5668	5419
5	5471	5385	5437	5502	5347
10	5363	5555	5607	5409	5421
15	5649	5404	5284	5310	5305
20	5554	5508	5370	5441	5531
25	5488	5496	5582	5522	5602
30	5317	5307	5299	5281	5325
35	5390	5504	5563	5577	5714
40	5435	5613	5679	5513	5642
45	5587	5417	5336	5505	5681
50	5648	5594	5391	5256	5530
55	5262	5722	5387	5278	5614
60	5580	5705	5470	5296	5595
65	5655	5378	5443	5606	5625
70	5446	5413	5466	5717	5275
75	5711	5626	5339	5410	5424
80	5566	5301	5448	5641	5293
85	5573	5393	5367	5535	5515
90	5350	5633	5459	5467	5297
95	5279	5386	5715	5624	5403

Hopping Frequency Sequence Name: HOP_FREQ_SEQ_03

Frequency (MHz)	0	1	2	3	4
0	5471	5621	5374	5354	5261
5	5513	5310	5512	5568	5651
10	5672	5344	5648	5507	5442
15	5262	5434	5290	5355	5497
20	5562	5577	5408	5530	5504
25	5279	5699	5308	5556	5266
30	5681	5264	5514	5523	5432
35	5595	5359	5255	5628	5274
40	5696	5520	5278	5639	5516
45	5397	5419	5563	5259	5438
50	5470	5567	5307	5619	5463
55	5666	5575	5707	5502	5433
60	5551	5635	5338	5427	5481
65	5324	5644	5555	5661	5350
70	5691	5538	5703	5613	5687
75	5585	5686	5547	5553	5461
80	5422	5457	5636	5588	5367
85	5377	5478	5445	5545	5684
90	5610	5287	5462	5285	5323
95	5597	5258	5420	5467	5698

Hopping Frequency Sequence Name: HOP_FREQ_SEQ_04

Frequency (MHz)	0	1	2	3	4
0	5251	5385	5310	5515	5481
5	5555	5332	5587	5256	5383
10	5603	5705	5311	5702	5463
15	5350	5561	5393	5400	5689
20	5570	5268	5349	5522	5477
25	5642	5685	5427	5412	5590
30	5308	5696	5632	5682	5343
35	5571	5686	5252	5505	5542
40	5304	5458	5421	5636	5348
45	5280	5502	5524	5312	5325
50	5346	5358	5708	5286	5513
55	5288	5661	5692	5488	5283
60	5356	5404	5270	5370	5504
65	5697	5717	5397	5707	5616
70	5351	5663	5544	5655	5650
75	5613	5625	5330	5678	5321
80	5307	5316	5538	5637	5413
85	5638	5485	5627	5291	5357
90	5382	5437	5562	5451	5596
95	5473	5366	5395	5509	5464

Hopping Frequency Sequence Name: HOP_FREQ_SEQ_05

Frequency (MHz)	0	1	2	3	4
0	5506	5624	5721	5579	5323
5	5694	5257	5662	5419	5590
10	5437	5494	5352	5422	5484
15	5438	5688	5496	5348	5406
20	5578	5337	5290	5611	5547
25	5433	5537	5533	5516	5350
30	5556	5372	5456	5541	5710
35	5302	5523	5658	5553	5524
40	5387	5396	5661	5633	5277
45	5260	5585	5582	5365	5697
50	5444	5409	5584	5457	5379
55	5615	5407	5546	5520	5490
60	5703	5663	5705	5691	5668
65	5550	5636	5320	5512	5675
70	5304	5716	5639	5503	5527
75	5295	5659	5606	5485	5681
80	5459	5384	5648	5501	5378
85	5689	5631	5305	5317	5297
90	5294	5264	5454	5617	5435
95	5452	5469	5690	5507	5562

Hopping Frequency Sequence Name: HOP_FREQ_SEQ_06

Frequency (MHz)	0	1	2	3	4
0	5664	5388	5657	5265	5543
5	5261	5279	5262	5582	5419
10	5368	5283	5393	5617	5505
15	5526	5340	5599	5598	5489
20	5503	5328	5603	5520	5321
25	5486	5620	5658	5445	5513
30	5587	5705	5361	5277	5490
35	5319	5336	5467	5363	5567
40	5334	5426	5630	5584	5715
45	5668	5640	5418	5477	5476
50	5460	5508	5407	5304	5569
55	5597	5268	5367	5649	5655
60	5648	5495	5531	5259	5394
65	5499	5672	5530	5307	5478
70	5473	5719	5524	5615	5462
75	5496	5415	5327	5694	5377
80	5447	5301	5320	5572	5561
85	5449	5721	5643	5404	5482
90	5303	5488	5471	5392	5413
95	5602	5299	5454	5351	5675

Hopping Frequency Sequence Name: HOP_FREQ_SEQ_07

Frequency (MHz)	0	1	2	3	4
0	5444	5627	5593	5426	5385
5	5303	5679	5337	5648	5626
10	5299	5547	5434	5526	5517
15	5467	5702	5438	5412	5497
20	5572	5269	5692	5493	5587
25	5338	5464	5346	5531	5431
30	5470	5327	5382	5656	5416
35	5581	5590	5586	5381	5677
40	5650	5272	5666	5724	5513
45	5695	5276	5601	5374	5267
50	5352	5321	5511	5597	5608
55	5723	5280	5523	5312	5562
60	5345	5690	5454	5680	5448
65	5611	5362	5674	5281	5545
70	5344	5373	5591	5421	5465
75	5568	5514	5329	5496	5541
80	5510	5298	5515	5551	5414
85	5524	5641	5686	5652	5701
90	5647	5406	5265	5500	5585
95	5252	5387	5313	5675	5697

Hopping Frequency Sequence Name: HOP_FREQ_SEQ_08

Frequency (MHz)	0	1	2	3	4
0	5699	5391	5529	5587	5605
5	5442	5701	5412	5336	5358
10	5608	5475	5435	5547	5497
15	5708	5483	5604	5505	5263
20	5685	5684	5466	5665	5667
25	5450	5251	5573	5320	5427
30	5445	5631	5379	5555	5672
35	5264	5392	5516	5258	5334
40	5721	5675	5359	5659	5629
45	5703	5562	5686	5431	5570
50	5468	5477	5502	5381	5309
55	5432	5510	5635	5256	5280
60	5626	5418	5397	5647	5572
65	5469	5559	5714	5255	5347
70	5600	5470	5380	5337	5558
75	5549	5291	5439	5277	5670
80	5673	5710	5454	5584	5261
85	5554	5648	5425	5521	5299
90	5288	5609	5602	5307	5484
95	5285	5303	5317	5723	5444

Hopping Frequency Sequence Name: HOP_FREQ_SEQ_09

Frequency (MHz)	0	1	2	3	4
0	5479	5630	5465	5273	5447
5	5484	5626	5487	5499	5662
10	5539	5697	5516	5568	5693
15	5624	5336	5431	5321	5416
20	5429	5723	5298	5439	5363
25	5614	5395	5554	5285	5712
30	5684	5384	5660	5308	5674
35	5694	5288	5279	5417	5306
40	5452	5438	5623	5574	5718
45	5274	5655	5442	5717	5480
50	5419	5579	5673	5613	5397
55	5254	5514	5656	5692	5578
60	5658	5561	5675	5580	5563
65	5678	5669	5716	5346	5683
70	5404	5361	5265	5311	5449
75	5446	5339	5659	5530	5543
80	5533	5297	5258	5670	5430
85	5454	5547	5453	5519	5602
90	5719	5502	5418	5711	5548
95	5619	5362	5468	5649	5406

Hopping Frequency Sequence Name: HOP_FREQ_SEQ_10

Frequency (MHz)	0	1	2	3	4
0	5637	5394	5401	5434	5667
5	5526	5648	5562	5662	5470
10	5486	5557	5350	5589	5306
15	5276	5439	5476	5513	5424
20	5498	5664	5290	5412	5629
25	5466	5501	5658	5319	5279
30	5670	5341	5400	5397	5261
35	5379	5550	5570	5695	5291
40	5521	5464	5339	5715	5678
45	5538	5525	5300	5533	5358
50	5374	5552	5361	5369	5385
55	5310	5593	5365	5395	5504
60	5615	5442	5295	5622	5614
65	5631	5543	5383	5324	5450
70	5298	5422	5653	5323	5705
75	5511	5320	5314	5461	5321
80	5625	5357	5512	5607	5645
85	5387	5349	5539	5270	5430
90	5255	5636	5417	5549	5556
95	5628	5509	5352	5410	5672

Hopping Frequency Sequence Name: HOP_FREQ_SEQ_11

Frequency (MHz)	0	1	2	3	4
0	5417	5633	5337	5595	5509
5	5568	5670	5637	5253	5601
10	5304	5275	5598	5545	5610
15	5297	5403	5542	5521	5705
20	5432	5664	5605	5379	5385
25	5517	5415	5704	5287	5353
30	5321	5559	5298	5615	5709
35	5692	5400	5470	5443	5345
40	5609	5604	5402	5482	5712
45	5510	5518	5608	5261	5586
50	5571	5550	5715	5575	5278
55	5305	5460	5339	5500	5691
60	5600	5722	5530	5567	5702
65	5330	5561	5643	5719	5658
70	5446	5426	5346	5552	5310
75	5453	5622	5398	5257	5373
80	5492	5475	5570	5625	5481
85	5442	5260	5354	5265	5352
90	5607	5597	5262	5357	5527
95	5690	5364	5472	5533	5454

Hopping Frequency Sequence Name: HOP_FREQ_SEQ_12

Frequency (MHz)	0	1	2	3	4
0	5672	5397	5273	5659	5254
5	5707	5595	5712	5416	5430
10	5710	5539	5261	5265	5631
15	5385	5530	5645	5469	5422
20	5343	5258	5643	5371	5358
25	5308	5267	5432	5488	5387
30	5460	5448	5255	5483	5415
35	5658	5714	5498	5620	5444
40	5687	5340	5722	5331	5439
45	5691	5319	5639	5458	5585
50	5251	5291	5664	5576	5627
55	5648	5293	5690	5510	5571
60	5376	5695	5512	5534	5253
65	5507	5466	5668	5597	5656
70	5318	5624	5296	5553	5374
75	5494	5419	5473	5252	5685
80	5351	5692	5544	5661	5637
85	5260	5630	5457	5370	5557
90	5522	5533	5716	5572	5292
95	5527	5517	5352	5489	5618

Hopping Frequency Sequence Name: HOP_FREQ_SEQ_13

Frequency (MHz)	0	1	2	3	4
0	5452	5636	5684	5345	5571
5	5274	5617	5312	5579	5637
10	5544	5328	5302	5363	5652
15	5473	5560	5651	5514	5614
20	5351	5424	5584	5460	5331
25	5671	5594	5635	5592	5421
30	5502	5434	5687	5710	5581
35	5510	5534	5380	5392	5278
40	5487	5368	5478	5299	5377
45	5692	5723	5364	5427	5342
50	5399	5361	5722	5405	5707
55	5445	5505	5385	5457	5463
60	5554	5550	5667	5633	5488
65	5588	5318	5379	5556	5698
70	5253	5650	5586	5562	5454
75	5504	5320	5607	5381	5561
80	5357	5638	5610	5593	5552
85	5660	5612	5618	5280	5539
90	5275	5485	5309	5582	5598
95	5347	5371	5721	5568	5358

Hopping Frequency Sequence Name: HOP_FREQ_SEQ_14

Frequency (MHz)	0	1	2	3	4
0	5707	5400	5620	5506	5316
5	5542	5387	5267	5369	5475
10	5689	5343	5558	5673	5561
15	5687	5279	5559	5331	5359
20	5493	5525	5452	5304	5462
25	5543	5363	5696	5358	5544
30	5323	5644	5688	5409	5433
35	5720	5365	5306	5426	5448
40	5694	5691	5252	5325	5675
45	5458	5382	5338	5648	5610
50	5715	5603	5393	5464	5697
55	5418	5549	5579	5595	5526
60	5416	5634	5550	5499	5295
65	5380	5496	5490	5566	5669
70	5698	5480	5608	5390	5656
75	5547	5704	5609	5335	5706
80	5532	5281	5333	5388	5545
85	5670	5552	5541	5556	5269
90	5528	5663	5391	5575	5377
95	5714	5594	5326	5637	5582

Hopping Frequency Sequence Name: HOP_FREQ_SEQ_15

Frequency (MHz)	0	1	2	3	4
0	5390	5639	5556	5667	5633
5	5358	5564	5462	5333	5576
10	5406	5478	5384	5278	5694
15	5552	5339	5382	5604	5620
20	5270	5659	5466	5541	5277
25	5350	5395	5469	5325	5392
30	5586	5687	5601	5428	5561
35	5253	5456	5674	5579	5459
40	5533	5558	5629	5322	5438
45	5465	5396	5701	5400	5591
50	5304	5444	5553	5520	5362
55	5262	5310	5345	5387	5288
60	5715	5602	5303	5442	5691
65	5515	5608	5530	5275	5411
70	5559	5351	5680	5568	5276
75	5513	5443	5644	5709	5355
80	5555	5272	5391	5616	5461
85	5493	5617	5298	5542	5551
90	5721	5596	5703	5343	5692
95	5566	5618	5707	5452	5313

Hopping Frequency Sequence Name: HOP_FREQ_SEQ_16

Frequency (MHz)	0	1	2	3	4
0	5645	5500	5492	5353	5378
5	5497	5489	5537	5496	5405
10	5715	5267	5425	5473	5640
15	5466	5485	5552	5337	5278
20	5253	5504	5533	5250	5616
25	5344	5672	5526	5426	5673
30	5558	5546	5335	5548	5523
35	5547	5470	5257	5373	5372
40	5263	5567	5635	5319	5436
45	5321	5454	5279	5287	5467
50	5480	5495	5642	5721	5684
55	5450	5487	5542	5358	5320
60	5389	5434	5604	5514	5464
65	5644	5265	5545	5689	5631
70	5284	5720	5656	5527	5273
75	5374	5419	5494	5688	5553
80	5301	5418	5564	5444	5708
85	5579	5556	5361	5668	5412
90	5593	5707	5654	5658	5381
95	5457	5272	5647	5516	5686

Hopping Frequency Sequence Name: HOP_FREQ_SEQ_17

Frequency (MHz)	0	1	2	3	4
0	5425	5264	5428	5514	5695
5	5539	5511	5612	5659	5646
10	5531	5466	5668	5261	5253
15	5496	5588	5597	5529	5286
20	5419	5445	5622	5698	5504
25	5671	5400	5630	5460	5292
30	5562	5515	5487	5271	5565
35	5260	5266	5507	5287	5686
40	5346	5505	5316	5365	5301
45	5631	5415	5332	5552	5721
50	5656	5546	5256	5544	5628
55	5638	5441	5593	5361	5707
60	5449	5570	5334	5527	5431
65	5715	5413	5583	5572	5437
70	5492	5325	5420	5472	5632
75	5486	5620	5494	5465	5475
80	5566	5681	5481	5549	5284
85	5347	5647	5639	5273	5326
90	5660	5397	5692	5263	5349
95	5474	5327	5414	5568	5658

Hopping Frequency Sequence Name: HOP_FREQ_SEQ_18

Frequency (MHz)	0	1	2	3	4
0	5680	5503	5364	5675	5440
5	5581	5436	5687	5347	5344
10	5577	5320	5507	5291	5282
15	5341	5623	5594	5642	5721
20	5672	5585	5386	5614	5671
25	5392	5523	5603	5259	5494
30	5334	5548	5472	5501	5261
35	5566	5704	5351	5634	5660
40	5298	5622	5429	5346	5640
45	5410	5294	5281	5714	5473
50	5385	5439	5597	5357	5442
55	5367	5475	5254	5395	5308
60	5655	5678	5578	5260	5376
65	5670	5353	5377	5441	5362
70	5619	5307	5707	5295	5397
75	5406	5387	5321	5608	5445
80	5589	5456	5717	5676	5462
85	5629	5544	5449	5479	5489
90	5602	5368	5669	5673	5336
95	5611	5465	5666	5361	5491

Hopping Frequency Sequence Name: HOP_FREQ_SEQ_19

Frequency (MHz)	0	1	2	3	4
0	5363	5267	5300	5361	5282
5	5623	5458	5287	5510	5648
10	5411	5681	5645	5486	5303
15	5332	5275	5697	5687	5438
20	5680	5654	5424	5703	5644
25	5658	5472	5331	5528	5473
30	5437	5429	5716	5413	5289
35	5368	5442	5430	5338	5461
40	5512	5284	5308	5407	5601
45	5261	5322	5531	5704	5436
50	5665	5419	5349	5498	5474
55	5649	5707	5425	5321	5502
60	5323	5264	5311	5655	5614
65	5599	5573	5566	5392	5390
70	5487	5404	5259	5494	5718
75	5318	5446	5674	5250	5662
80	5560	5634	5627	5584	5334
85	5630	5672	5663	5405	5470
90	5508	5696	5685	5389	5525
95	5596	5292	5465	5720	5520

Hopping Frequency Sequence Name: HOP_FREQ_SEQ_20

Frequency (MHz)	0	1	2	3	4
0	5618	5506	5711	5425	5502
5	5287	5383	5362	5576	5380
10	5342	5470	5686	5681	5324
15	5420	5402	5325	5635	5630
20	5688	5345	5365	5695	5617
25	5546	5437	5564	5562	5515
30	5326	5386	5359	5662	5584
35	5410	5533	5701	5588	5601
40	5300	5692	5697	5548	5404
45	5530	5716	5405	5492	5394
50	5591	5349	5612	5699	5620
55	5391	5266	5303	5671	5361
60	5687	5334	5577	5366	5465
65	5260	5594	5279	5638	5378
70	5393	5494	5463	5363	5430
75	5282	5322	5418	5271	5499
80	5385	5292	5443	5491	5250
85	5270	5625	5277	5678	5357
90	5532	5320	5579	5622	5680
95	5408	5723	5417	5605	5639

Hopping Frequency Sequence Name: HOP_FREQ_SEQ_21

Frequency (MHz)	0	1	2	3	4
0	5398	5270	5647	5586	5344
5	5329	5405	5437	5264	5587
10	5273	5259	5252	5401	5345
15	5508	5529	5428	5680	5347
20	5599	5414	5306	5309	5590
25	5337	5640	5668	5596	5557
30	5312	5343	5574	5339	5307
35	5549	5624	5594	5266	5612
40	5614	5300	5635	5313	5362
45	5696	5488	5550	5447	5381
50	5603	5275	5709	5689	5685
55	5257	5403	5490	5494	5393
60	5377	5686	5641	5288	5684
65	5630	5656	5664	5710	5461
70	5493	5721	5439	5700	5302
75	5402	5368	5399	5426	5434
80	5280	5355	5440	5628	5372
85	5370	5632	5605	5352	5485
90	5634	5547	5591	5639	5578
95	5387	5595	5543	5629	5282

Hopping Frequency Sequence Name: HOP_FREQ_SEQ_22

Frequency (MHz)	0	1	2	3	4
0	5653	5509	5583	5272	5564
5	5371	5330	5512	5427	5416
10	5582	5523	5293	5499	5366
15	5596	5559	5531	5250	5539
20	5607	5580	5344	5301	5563
25	5700	5600	5368	5297	5630
30	5696	5676	5300	5314	5588
35	5602	5688	5715	5390	5419
40	5526	5550	5383	5573	5456
45	5398	5291	5571	5608	5500
50	5268	5479	5489	5326	5420
55	5532	5686	5593	5309	5465
60	5522	5542	5253	5570	5704
65	5258	5633	5666	5391	5556
70	5360	5404	5447	5496	5415
75	5659	5271	5511	5380	5678
80	5536	5713	5515	5437	5406
85	5648	5335	5586	5378	5650
90	5312	5668	5429	5656	5270
95	5476	5269	5698	5266	5277

Hopping Frequency Sequence Name: HOP_FREQ_SEQ_23

Frequency (MHz)	0	1	2	3	4
0	5433	5273	5519	5406	5413
5	5352	5587	5590	5623	5513
10	5312	5334	5694	5387	5686
15	5537	5673	5353	5615	5649
20	5285	5390	5536	5491	5452
25	5571	5401	5664	5263	5565
30	5257	5529	5265	5422	5428
35	5661	5669	5440	5389	5466
40	5511	5696	5492	5695	5559
45	5654	5569	5553	5533	5355
50	5665	5377	5509	5335	5476
55	5719	5640	5308	5506	5436
60	5651	5707	5402	5627	5301
65	5582	5605	5698	5351	5638
70	5596	5419	5391	5618	5715
75	5642	5557	5458	5455	5317
80	5578	5434	5601	5531	5368
85	5708	5659	5678	5637	5626
90	5370	5340	5318	5689	5657
95	5254	5374	5723	5326	5464

Hopping Frequency Sequence Name: HOP_FREQ_SEQ_24

Frequency (MHz)	0	1	2	3	4
0	5591	5512	5455	5594	5626
5	5552	5277	5662	5656	5355
10	5347	5673	5375	5414	5408
15	5675	5338	5640	5718	5545
20	5526	5340	5701	5382	5509
25	5379	5401	5299	5602	5698
30	5305	5551	5689	5647	5514
35	5620	5394	5519	5457	5451
40	5703	5646	5449	5461	5489
45	5527	5539	5359	5627	5606
50	5420	5706	5366	5428	5598
55	5536	5323	5335	5325	5407
60	5397	5618	5709	5453	5722
65	5513	5531	5641	5433	5441
70	5645	5516	5599	5268	5367
75	5577	5587	5287	5700	5439
80	5707	5667	5573	5469	5334
85	5321	5434	5685	5671	5376
90	5643	5399	5568	5505	5324
95	5639	5571	5346	5312	5712

Hopping Frequency Sequence Name: HOP_FREQ_SEQ_25

Frequency (MHz)	0	1	2	3	4
0	5371	5276	5391	5280	5468
5	5594	5299	5262	5344	5659
10	5278	5462	5416	5609	5429
15	5288	5465	5268	5534	5409
20	5264	5471	5482	5267	5253
25	5405	5706	5257	5444	5440
30	5646	5387	5666	5533	5610
35	5350	5500	5365	5542	5254
40	5290	5701	5486	5456	5519
45	5442	5685	5485	5479	5687
50	5359	5523	5548	5591	5619
55	5281	5434	5562	5563	5541
60	5376	5668	5714	5480	5580
65	5265	5513	5622	5717	5502
70	5699	5592	5721	5536	5556
75	5310	5368	5420	5484	5680
80	5354	5633	5704	5331	5613
85	5337	5624	5256	5568	5511
90	5642	5550	5388	5670	5427
95	5576	5453	5455	5329	5292

Hopping Frequency Sequence Name: HOP_FREQ_SEQ_26

Frequency (MHz)	0	1	2	3	4
0	5626	5515	5327	5441	5688
5	5636	5699	5337	5507	5391
10	5684	5251	5457	5329	5450
15	5376	5592	5371	5333	5454
20	5542	5575	5680	5463	5455
25	5533	5677	5608	5335	5291
30	5486	5426	5603	5602	5440
35	5638	5672	5701	5621	5275
40	5279	5381	5703	5369	5483
45	5288	5499	5525	5646	5615
50	5572	5361	5718	5530	5301
55	5657	5589	5711	5405	5306
60	5438	5252	5563	5605	5373
65	5537	5429	5616	5475	5425
70	5411	5488	5702	5344	5697
75	5495	5428	5430	5414	5401
80	5261	5315	5610	5322	5389
85	5328	5466	5694	5663	5476
90	5596	5323	5586	5360	5433
95	5713	5564	5346	5347	5303

Hopping Frequency Sequence Name: HOP_FREQ_SEQ_27

Frequency (MHz)	0	1	2	3	4
0	5406	5279	5263	5505	5530
5	5678	5721	5412	5670	5598
10	5518	5515	5595	5427	5471
15	5367	5622	5474	5281	5646
20	5453	5644	5621	5552	5428
25	5421	5529	5336	5439	5325
30	5528	5315	5560	5342	5592
35	5458	5317	5417	5290	5517
40	5641	5609	5480	5692	5479
45	5608	5704	5668	5362	5712
50	5419	5581	5487	5533	5424
55	5359	5496	5635	5698	5550
60	5302	5503	5657	5378	5652
65	5307	5675	5703	5483	5705
70	5673	5454	5397	5557	5382
75	5416	5425	5391	5486	5452
80	5715	5308	5380	5344	5647
85	5571	5525	5547	5576	5363
90	5402	5287	5538	5445	5500
95	5590	5476	5252	5446	5432

Hopping Frequency Sequence Name: HOP_FREQ_SEQ_28

Frequency (MHz)	0	1	2	3	4
0	5564	5518	5674	5666	5275
5	5342	5646	5487	5261	5427
10	5449	5304	5636	5622	5492
15	5455	5274	5480	5326	5363
20	5461	5335	5659	5544	5401
25	5687	5381	5539	5640	5359
30	5570	5679	5517	5460	5366
35	5656	5378	5505	5310	5581
40	5631	5600	5579	5374	5574
45	5621	5459	5691	5287	5721
50	5724	5491	5595	5632	5576
55	5681	5380	5612	5313	5686
60	5454	5669	5582	5495	5609
65	5426	5603	5561	5327	5591
70	5470	5506	5652	5557	5330
75	5649	5413	5269	5670	5668
80	5438	5647	5553	5515	5322
85	5723	5618	5722	5717	5475
90	5309	5601	5344	5604	5690
95	5445	5685	5457	5368	5436

Hopping Frequency Sequence Name: HOP_FREQ_SEQ_29

Frequency (MHz)	0	1	2	3	4
0	5344	5282	5610	5352	5592
5	5384	5668	5562	5424	5634
10	5380	5665	5677	5342	5513
15	5543	5401	5583	5371	5555
20	5469	5501	5600	5633	5374
25	5575	5330	5267	5269	5393
30	5709	5474	5675	5518	5476
35	5517	5596	5581	5356	5593
40	5470	5683	5614	5571	5453
45	5299	5723	5514	5367	5296
50	5504	5324	5325	5273	5378
55	5272	5537	5441	5252	5549
60	5287	5276	5627	5349	5362
65	5309	5724	5333	5366	5625
70	5372	5713	5315	5271	5445
75	5548	5428	5717	5697	5443
80	5618	5564	5680	5667	5652
85	5615	5262	5494	5512	5334
90	5306	5421	5305	5522	5620
95	5413	5619	5284	5552	5714

Hopping Frequency Sequence Name: HOP_FREQ_SEQ_30

Frequency (MHz)	0	1	2	3	4
0	5599	5521	5546	5513	5337
5	5426	5593	5637	5587	5366
10	5689	5454	5718	5537	5534
15	5631	5528	5686	5416	5272
20	5380	5570	5541	5625	5347
25	5657	5373	5427	5276	5554
30	5431	5415	5292	5296	5656
35	5687	5377	5509	5604	5309
40	5291	5455	5282	5568	5382
45	5322	5306	5352	5401	5472
50	5259	5279	5327	5646	5696
55	5591	5470	5514	5507	5437
60	5482	5273	5553	5592	5585
65	5700	5566	5559	5632	5490
70	5321	5529	5433	5601	5331
75	5338	5317	5325	5697	5658
80	5684	5406	5263	5694	5260
85	5503	5265	5384	5617	5606
90	5365	5622	5545	5552	5522
95	5511	5567	5336	5707	5663

--- END ---