

## FCC Test Report

**Report No.:** RF170918D11-1

**FCC ID:** 2AI9TOAW-AP123X

**Test Model:** OAW-AP1231, OAW-AP1232

**Received Date:** Jul. 13, 2017

**Test Date:** Oct. 24 ~ Nov. 10, 2017

**Issued Date:** Dec. 19, 2017

**Applicant:** ALE USA Inc.

**Address:** 26801 West Agoura Road, Calabasas, CA 91301

**Issued By:** Bureau Veritas Consumer Products Services (H.K.) Ltd., Taoyuan Branch

**Lab Address:** No. 47-2, 14th Ling, Chia Pau Vil., Lin Kou Dist., New Taipei City, Taiwan, R.O.C.

**FCC Registration /  
Designation Number:** 198487 / TW2021



This report is for your exclusive use. Any copying or replication of this report to or for any other person or entity, or use of our name or trademark, is permitted only with our prior written permission. This report sets forth our findings solely with respect to the test samples identified herein. The results set forth in this report are not indicative or representative of the quality or characteristics of the lot from which a test sample was taken or any similar or identical product unless specifically and expressly noted. Our report includes all of the tests requested by you and the results thereof based upon the information that you provided to us. You have 60 days from date of issuance of this report to notify us of any material error or omission caused by our negligence, provided, however, that such notice shall be in writing and shall specifically address the issue you wish to raise. A failure to raise such issue within the prescribed time shall constitute your unqualified acceptance of the completeness of this report, the tests conducted and the correctness of the report contents. Unless specifically mentioned, the uncertainty of measurement has been explicitly taken into account to declare the compliance or non-compliance to the specification. The report must not be used by the client to claim product certification, approval, or endorsement by TAF or any government agencies.

## Table of Contents

<b>Release Control Record</b> .....	<b>4</b>
<b>1 Certificate of Conformity</b> .....	<b>5</b>
<b>2 Summary of Test Results</b> .....	<b>6</b>
2.1 Measurement Uncertainty .....	6
2.2 Modification Record .....	6
<b>3 General Information</b> .....	<b>7</b>
3.1 General Description of EUT .....	7
3.2 Description of Test Modes.....	8
3.2.1 Test Mode Applicability and Tested Channel Detail.....	9
3.3 Duty cycle of test signal .....	11
3.4 Description of Support Units .....	12
3.4.1 Configuration of System under Test .....	13
3.5 General Description of Applied Standards .....	14
<b>4 Test Types and Results</b> .....	<b>15</b>
4.1 Radiated Emission and Bandedge Measurement.....	15
4.1.1 Limits of Radiated Emission and Bandedge Measurement .....	15
4.1.2 Test Instruments .....	16
4.1.3 Test Procedures.....	17
4.1.4 Deviation from Test Standard .....	17
4.1.5 Test Setup.....	18
4.1.6 EUT Operating Conditions.....	19
4.1.7 Test Results .....	20
4.2 Conducted Emission Measurement.....	28
4.2.1 Limits of Conducted Emission Measurement.....	28
4.2.2 Test Instruments .....	28
4.2.3 Test Procedure .....	29
4.2.4 Deviation from Test Standard .....	29
4.2.5 Test Setup.....	29
4.2.6 EUT Operating Condition .....	29
4.2.7 Test Results .....	30
4.3 6dB Bandwidth Measurement.....	38
4.3.1 Limits of 6dB Bandwidth Measurement.....	38
4.3.2 Test Setup.....	38
4.3.3 Test Instruments .....	38
4.3.4 Test Procedure .....	38
4.3.5 Deviation from Test Standard .....	38
4.3.6 EUT Operating Conditions.....	38
4.3.7 Test Result.....	39
4.4 Conducted Output Power Measurement.....	40
4.4.1 Limits OF Conducted Output Power Measurement .....	40
4.4.2 Test Setup.....	40
4.4.3 Test Instruments .....	40
4.4.4 Test Procedures.....	40
4.4.5 Deviation from Test Standard .....	40
4.4.6 EUT Operating Conditions.....	40
4.4.7 Test Results .....	40
4.5 Power Spectral Density Measurement.....	41

4.5.1	Limits of Power Spectral Density Measurement.....	41
4.5.2	Test Setup.....	41
4.5.3	Test Instruments .....	41
4.5.4	Test Procedure .....	41
4.5.5	Deviation from Test Standard .....	41
4.5.6	EUT Operating Condition .....	41
4.5.7	Test Results .....	42
4.6	Conducted Out of Band Emission Measurement.....	43
4.6.1	Limits of Conducted Out of Band Emission Measurement.....	43
4.6.2	Test Setup.....	43
4.6.3	Test Instruments .....	43
4.6.4	Test Procedure .....	43
4.6.5	Deviation from Test Standard .....	43
4.6.6	EUT Operating Condition .....	43
4.6.7	Test Results .....	44
<b>5</b>	<b>Pictures of Test Arrangements.....</b>	<b>45</b>
	<b>Appendix – Information on the Testing Laboratories .....</b>	<b>46</b>

### Release Control Record

Issue No.	Description	Date Issued
RF170918D11-1	Original release.	Dec. 19, 2017

## 1 Certificate of Conformity

**Product:** OmniAccess Stellar

**Brand:** Alcatel-Lucent Enterprise

**Test Model:** OAW-AP1231, OAW-AP1232

**Sample Status:** Engineering sample

**Applicant:** ALE USA Inc.

**Test Date:** Oct. 24 ~ Nov. 10, 2017

**Standards:** 47 CFR FCC Part 15, Subpart C (Section 15.247)  
ANSI C63.10: 2013

The above equipment has been tested by **Bureau Veritas Consumer Products Services (H.K.) Ltd., Taoyuan Branch**, and found compliance with the requirement of the above standards. The test record, data evaluation & Equipment Under Test (EUT) configurations represented herein are true and accurate accounts of the measurements of the sample's EMC characteristics under the conditions specified in this report.

**Prepared by :**

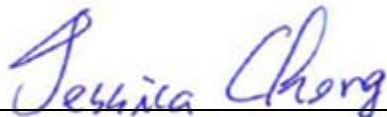

Jessica Cheng / Senior Specialist

**Date:**

Dec. 19, 2017

**Approved by :**



Rex Lai / Associate Technical Manager

**Date:**

Dec. 19, 2017

## 2 Summary of Test Results

47 CFR FCC Part 15, Subpart C (SECTION 15.247)			
FCC Clause	Test Item	Result	Remarks
15.207	AC Power Conducted Emission	PASS	Meet the requirement of limit. Minimum passing margin is -2.80dB at 0.35703 MHz.
15.205 & 209 & 15.247(d)	Radiated Emissions & Band Edge Measurement	PASS	Meet the requirement of limit. Minimum passing margin is -10.17dB at 242.53 MHz.
15.247(d)	Antenna Port Emission	PASS	Meet the requirement of limit.
15.247(a)(2)	6dB bandwidth	PASS	Meet the requirement of limit.
15.247(b)	Conducted power	PASS	Meet the requirement of limit.
15.247(e)	Power Spectral Density	PASS	Meet the requirement of limit.
15.203	Antenna Requirement	PASS	Antenna connector is I-PEX not a standard connector.

### 2.1 Measurement Uncertainty

Where relevant, the following measurement uncertainty levels have been estimated for tests performed on the EUT as specified in CISPR 16-4-2:

Measurement	Frequency	Expanded Uncertainty (k=2) ( $\pm$ )
Conducted Emissions at mains ports	150kHz ~ 30MHz	2.77 dB
Radiated Emissions up to 1 GHz	9kHz ~ 30MHz	2.38 dB
	30MHz ~ 1000MHz	5.54 dB
Radiated Emissions above 1 GHz	1GHz ~ 6GHz	4.47 dB
	Above 6GHz	5.48 dB

### 2.2 Modification Record

There were no modifications required for compliance.

### 3 General Information

#### 3.1 General Description of EUT

Product	OmniAccess Stellar
Brand	Alcatel-Lucent Enterprise
Test Model	OAW-AP1231, OAW-AP1232
Model Difference	Refer to note as below
Status of EUT	Engineering Sample
Power Supply Rating	48Vdc from Adapter or 55Vdc from PoE
Modulation Type	GFSK
Transfer Rate	Up to 1Mbps
Operating Frequency	2402MHz ~ 2480MHz
Number of Channel	40
Output Power	2.831mW
Antenna Type	Refer to note as below
Antenna Connector	Refer to note as below
Accessory Device	N/A
Data Cable Supplied	N/A

Note:

1. All models are listed as below.

Brand	Model	Difference
Alcatel-Lucent Enterprise	OAW-AP1231	Internal PIFA antenna for Bluetooth function, and internal PIFA antenna for WLAN function
	OAW-AP1232	Internal PIFA antenna for Bluetooth function, and external Dipole antenna for WLAN function

2. The EUT was pre-tested with the following modes:

- ✧ Operating Mode (EUT Powered from Adapter)
- ✧ Operating Mode (EUT Powered from PoE)

The worst emission level was found when the EUT tested under **Operating Mode (EUT + Adapter)**, therefore, only its test data was recorded in this report.

3. The antennas provided to the EUT, please refer to the following table:

Model	Antenna Type	Antenna Gain (dBi)	Connector Type
OAW-AP1231	PIFA	4.89	I-PEX
OAW-AP1232	PIFA	3.42	I-PEX

4. The above EUT information is declared by manufacturer and for more detailed features description, please refer to the manufacturer's specifications or user's manual.

### 3.2 Description of Test Modes

40 channels are provided to this EUT:

CHANNEL	FREQ. (MHz)	CHANNEL	FREQ. (MHz)	CHANNEL	FREQ. (MHz)	CHANNEL	FREQ. (MHz)
0	2402	10	2422	20	2442	30	2462
1	2404	11	2424	21	2444	31	2464
2	2406	12	2426	22	2446	32	2466
3	2408	13	2428	23	2448	33	2468
4	2410	14	2430	24	2450	34	2470
5	2412	15	2432	25	2452	35	2472
6	2414	16	2434	26	2454	36	2474
7	2416	17	2436	27	2456	37	2476
8	2418	18	2438	28	2458	38	2478
9	2420	19	2440	29	2460	39	2480



### 3.2.1 Test Mode Applicability and Tested Channel Detail

EUT CONFIGURE MODE	APPLICABLE TO				DESCRIPTION
	RE $\geq$ 1G	RE $<$ 1G	PLC	APCM	
A	√	√	√	√	Model: OAW-AP1231 (Int. antenna), Powered from Adapter
B	√	√	√	√	Model: OAW-AP1232(Ext. antenna), Powered from Adapter
C	-	-	√	-	Model: OAW-AP1231 (Int. antenna), Powered from PoE
D	-	-	√	-	Model: OAW-AP1232(Ext. antenna), Powered from PoE

Where **RE $\geq$ 1G**: Radiated Emission above 1GHz      **RE $<$ 1G**: Radiated Emission below 1GHz  
**PLC**: Power Line Conducted Emission      **APCM**: Antenna Port Conducted Measurement

**NOTE:**

The EUT had been pre-tested on the positioned of each 3 axis. The worst case was found when positioned on **Y-plane**. (Mode A)  
The EUT had been pre-tested on the positioned of each 3 axis. The worst case was found when positioned on **X-plane**. (Mode B)

**Radiated Emission Test (Above 1GHz):**

- Pre-Scan has been conducted to determine the worst-case mode from all possible combinations between available modulations, data rates and antenna ports (if EUT with antenna diversity architecture).
- Following channel(s) was (were) selected for the final test as listed below.

EUT CONFIGURE MODE	AVAILABLE CAIcatel-Lucent EnterpriseNEL	TESTED CAIcatel-Lucent EnterpriseNEL	MODULATION TYPE	DATA RATE (Mbps)
A & B	0 to 39	0, 19, 39	GFSK	1

**Radiated Emission Test (Below 1GHz):**

- Pre-Scan has been conducted to determine the worst-case mode from all possible combinations between available modulations, data rates and antenna ports (if EUT with antenna diversity architecture).
- Following channel(s) was (were) selected for the final test as listed below.

EUT CONFIGURE MODE	AVAILABLE CAIcatel-Lucent EnterpriseNEL	TESTED CAIcatel-Lucent EnterpriseNEL	MODULATION TYPE	DATA RATE (Mbps)
A & B	0 to 39	39	GFSK	1

**Power Line Conducted Emission Test:**

- Pre-Scan has been conducted to determine the worst-case mode from all possible combinations between available modulations, data rates and antenna ports (if EUT with antenna diversity architecture).
- Following channel(s) was (were) selected for the final test as listed below.

EUT CONFIGURE MODE	AVAILABLE CAIcatel-Lucent EnterpriseNEL	TESTED CAIcatel-Lucent EnterpriseNEL	MODULATION TYPE	DATA RATE (Mbps)
A	0 to 39	39	GFSK	1
B	0 to 39	39	GFSK	1
C	0 to 39	39	GFSK	1
D	0 to 39	39	GFSK	1

**Antenna Port Conducted Measurement:**

- This item includes all test value of each mode, but only includes spectrum plot of worst value of each mode.
- Pre-Scan has been conducted to determine the worst-case mode from all possible combinations between available modulations, data rates and antenna ports (if EUT with antenna diversity architecture).
- Following channel(s) was (were) selected for the final test as listed below.

EUT CONFIGUURE MODE	AVAILABLE CAlcatel-Lucent EnterpriseNEL	TESTED CAlcatel-Lucent EnterpriseNEL	MODULATION TYPE	DATA RATE (Mbps)
A & B	0 to 39	0, 19, 39	GFSK	1

**Test Condition:**

APPLICABLE TO	ENVIRONMENTAL CONDITIONS	INPUT POWER	TESTED BY
RE≥1G	27deg. C, 69%RH	120Vac, 60Hz	Ian Chang
RE<1G	27deg. C, 69%RH	120Vac, 60Hz	Ian Chang
PLC	23deg. C, 77%RH	120Vac, 60Hz	Ian Chang
APCM	25deg. C, 76%RH	120Vac, 60Hz	Saxon Lee

### 3.3 Duty cycle of test signal

Duty cycle of test signal is < 98%

Duty cycle =  $0.388/0.65 = 0.597$ , Duty factor =  $10 * \log(1/0.597) = 2.2$

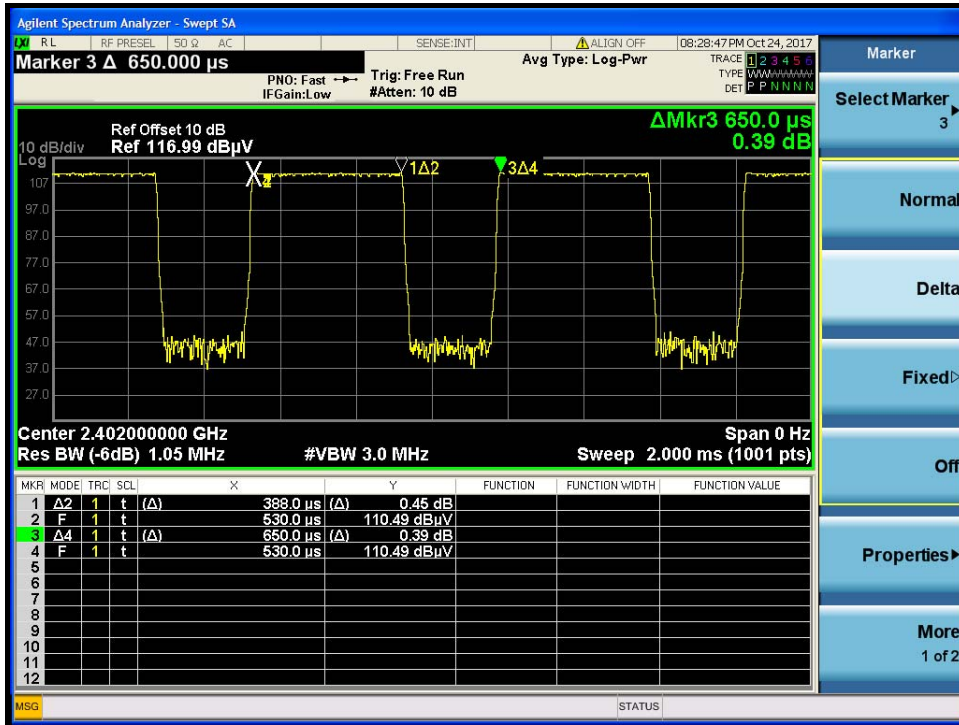

### 3.4 Description of Support Units

The EUT has been tested as an independent unit together with other necessary accessories or support units. The following support units or accessories were used to form a representative test configuration during the tests.

ID	Product	Brand	Model No.	Serial No.	FCC ID	Remarks
A.	Adapter	APD	WB-18D12R	N/A	N/A	Supplied by client
B.	NOTEBOOK PC	DELL	PP27L	8SNZ12S	FCC DoC Approved	Provided by Lab
C.	PoE	Microsemi	PD-9001GR/AT/AC	N/A	N/A	Supplied by client

Note:

1. All power cords of the above support units are non-shielded (1.8m).
2. Item B ~ C acted as communication partners to transfer data.

ID	Descriptions	Qty.	Length (m)	Shielding (Yes/No)	Cores (Qty.)	Remarks
1.	DC cable	1	1.5	N	0	Supplied by client
2.	LAN cable	1	10	N	0	Provided by Lab
3.	LAN cable	1	1.5	N	0	Provided by Lab
4.	AC cable	1	1.8	N	0	Provided by Lab

Note: The core(s) is(are) originally attached to the cable(s).

### 3.4.1 Configuration of System under Test

#### Mode A & B:

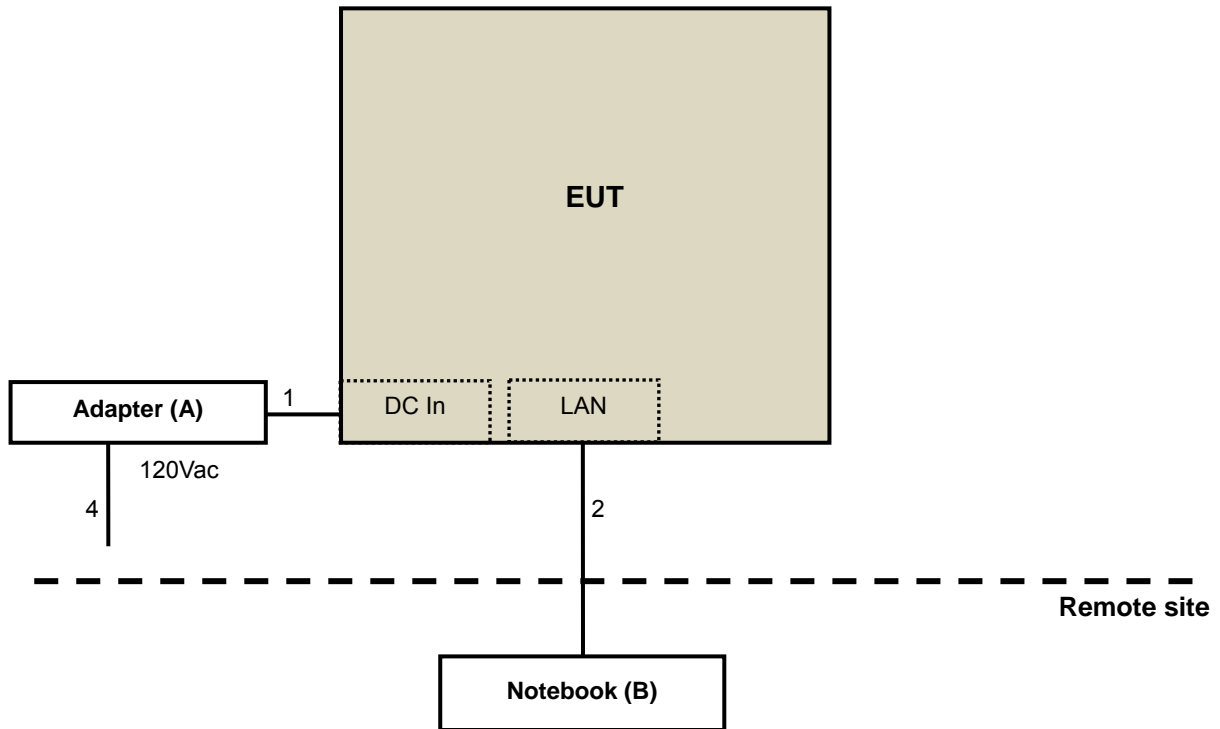

#### Mode C & D:

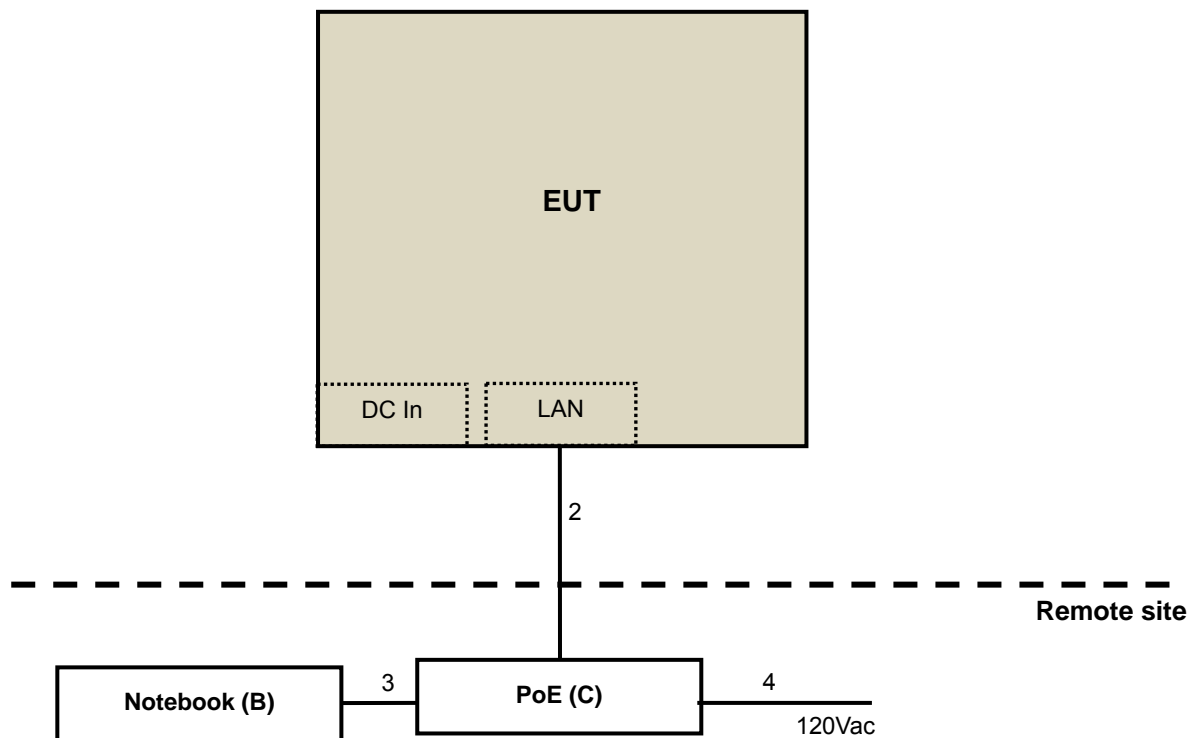

### 3.5 General Description of Applied Standards

The EUT is a RF Product. According to the specifications of the manufacturer, it must comply with the requirements of the following standards:

**FCC Part 15, Subpart C (15.247)**  
**KDB 558074 D01 DTS Meas Guidance v04**  
ANSI C63.10-2013

All test items have been performed and recorded as per the above standards.

## 4 Test Types and Results

### 4.1 Radiated Emission and Bandedge Measurement

#### 4.1.1 Limits of Radiated Emission and Bandedge Measurement

Radiated emissions which fall in the restricted bands must comply with the radiated emission limits specified as below table. Other emissions shall be at least 20dB below the highest level of the desired power:

Frequencies (MHz)	Field Strength (microvolts/meter)	Measurement Distance (meters)
0.009 ~ 0.490	2400/F(kHz)	300
0.490 ~ 1.705	24000/F(kHz)	30
1.705 ~ 30.0	30	30
30 ~ 88	100	3
88 ~ 216	150	3
216 ~ 960	200	3
Above 960	500	3

**NOTE:**

1. The lower limit shall apply at the transition frequencies.
2. Emission level (dBuV/m) = 20 log Emission level (uV/m).
3. For frequencies above 1000MHz, the field strength limits are based on average detector, however, the peak field strength of any emission shall not exceed the maximum permitted average limits, specified above by more than 20dB under any condition of modulation.

## 4.1.2 Test Instruments

DESCRIPTION & MANUFACTURER	MODEL NO.	SERIAL NO.	CALIBRATED DATE	CALIBRATED UNTIL
HP Preamplifier	8447D	2432A03504	Feb. 21, 2017	Feb. 20, 2018
HP Preamplifier	8449B	3008A01201	Feb. 22, 2017	Feb. 21, 2018
MITEQ Preamplifier	AMF-6F-260400-33-8P	892164	Feb. 21, 2017	Feb. 20, 2018
Agilent TEST RECEIVER	N9038A	MY51210129	Feb. 08, 2017	Feb. 07, 2018
Schwarzbeck Antenna	VULB 9168	139	Dec. 13, 2016	Dec. 12, 2017
Schwarzbeck Horn Antenna	BBHA-9170	212	Dec. 30, 2016	Dec. 29, 2017
Schwarzbeck Horn Antenna	BBHA 9120-D1	D130	Dec. 27, 2016	Dec. 26, 2017
ADT. Turn Table	TT100	0306	NA	NA
ADT. Tower	AT100	0306	NA	NA
Software	Radiated_V7.6.15.9.5	NA	NA	NA
SUHNER RF cable With 4dB PAD	SF104	CABLE-CH6	Aug. 14, 2017	Aug. 13, 2018
SUHNER RF cable With 3dB PAD	SF102	Cable-CH8-3.6m	Aug. 14, 2017	Aug. 13, 2018
KEYSIGHT MIMO Powermeasurement Test set	U2021XA	U2021XA-001	May 31, 2017	May 30, 2018
KEYSIGHT Spectrum Analyzer	N9030A	MY54490260	Jul. 26, 2017	Jul. 25, 2018
Loop Antenna EMCI	LPA600	270	Aug. 11, 2017	Aug. 10, 2019
EMCO Horn Antenna	3115	00028257	Dec. 15, 2016	Dec. 14, 2017
Highpass filter Wainwright Instruments	WHK 3.1/18G-10SS	SN 8	NA	NA
ROHDE & SCHWARZ Spectrum Analyzer	FSV40	101042	Sep. 29, 2017	Sep. 28, 2018
Anritsu Power Sensor	MA2411B	0738404	Apr. 24, 2017	Apr. 23, 2018
Anritsu Power Meter	ML2495A	0842014	Apr. 24, 2017	Apr. 23, 2018

- NOTE:**
1. The calibration interval of the above test instruments is 12/24 months. And the calibrations are traceable to NML/ROC and NIST/USA.
  2. The horn antenna and HP preamplifier (model: 8449B) are used only for the measurement of emission frequency above 1GHz if tested.
  3. The test was performed in Chamber No. 6.
  4. The Industry Canada Reference No. IC 7450E-6.
  5. The FCC Site Registration No. is 447212.
  6. Tested Date: Oct. 24 ~ Nov. 10, 2017



#### 4.1.3 Test Procedures

##### **For Radiated emission below 30MHz**

- a. The EUT was placed on the top of a rotating table 0.8 meters above the ground at a 3 meter chamber room. The table was rotated 360 degrees to determine the position of the highest radiation.
- b. The EUT was set 3 meters away from the interference-receiving antenna, which was mounted on the top of a variable-height antenna tower.
- c. Both X and Y axes of the antenna are set to make the measurement.
- d. For each suspected emission, the EUT was arranged to its worst case and the rotatable table was turned from 0 degrees to 360 degrees to find the maximum reading.
- e. The test-receiver system was set to Quasi-Peak Detect Function and Specified Bandwidth with Maximum Hold Mode.

**NOTE:** The resolution bandwidth and video bandwidth of test receiver/spectrum analyzer is 9kHz at frequency below 30MHz.

##### **For Radiated emission above 30MHz**

- a. The EUT was placed on the top of a rotating table 0.8 meters (for 30MHz ~ 1GHz) / 1.5 meters (for above 1GHz) above the ground at 3 meter chamber room for test. The table was rotated 360 degrees to determine the position of the highest radiation.
- b. The EUT was set 3 meters away from the interference-receiving antenna, which was mounted on the top of a variable-height antenna tower.
- c. The height of antenna is varied from one meter to four meters above the ground to determine the maximum value of the field strength. Both horizontal and vertical polarizations of the antenna are set to make the measurement.
- d. For each suspected emission, the EUT was arranged to its worst case and then the antenna was tuned to heights from 1 meter to 4 meters and the rotatable table was turned from 0 degrees to 360 degrees to find the maximum reading.
- e. The test-receiver system was set to quasi-peak detect function and specified bandwidth with maximum hold mode when the test frequency is below 1 GHz.
- f. The test-receiver system was set to peak and average detect function and specified bandwidth with maximum hold mode when the test frequency is above 1 GHz. If the peak reading value also meets average limit, measurement with the average detector is unnecessary.

##### **Note:**

1. The resolution bandwidth and video bandwidth of test receiver/spectrum analyzer is 120kHz for Quasi-peak detection (QP) at frequency below 1GHz.
2. The resolution bandwidth of test receiver/spectrum analyzer is 1 MHz and the video bandwidth is 3 MHz for Peak detection (PK) at frequency above 1GHz.
3. The resolution bandwidth of test receiver/spectrum analyzer is 1MHz and the video bandwidth is  $\geq 1/T$  (Duty cycle < 98%) or 10Hz (Duty cycle  $\geq 98\%$ ) for Peak detection at frequency above 1GHz.
4. All modes of operation were investigated and the worst-case emissions are reported.

#### 4.1.4 Deviation from Test Standard

No deviation.

#### 4.1.5 Test Setup

##### For Radiated emission below 30MHz

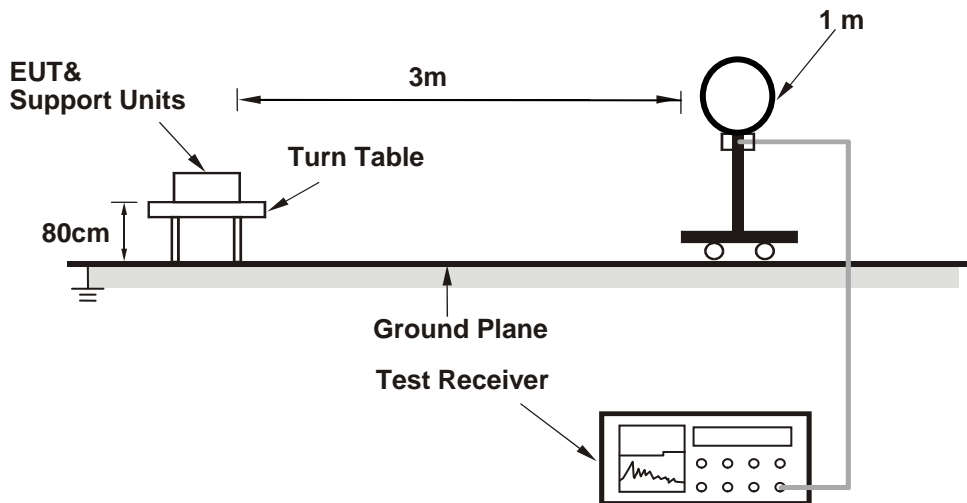

##### For Radiated emission 30MHz to 1GHz

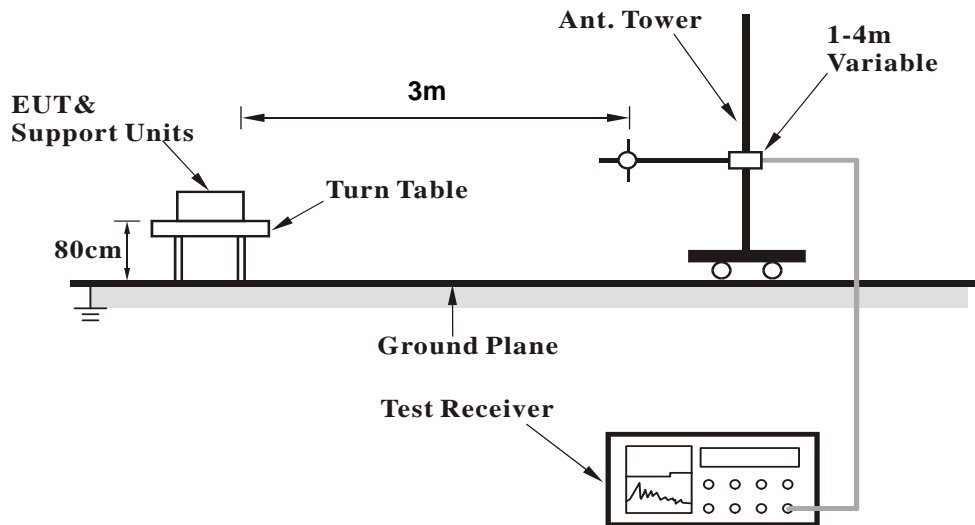

**For Radiated emission above 1GHz**

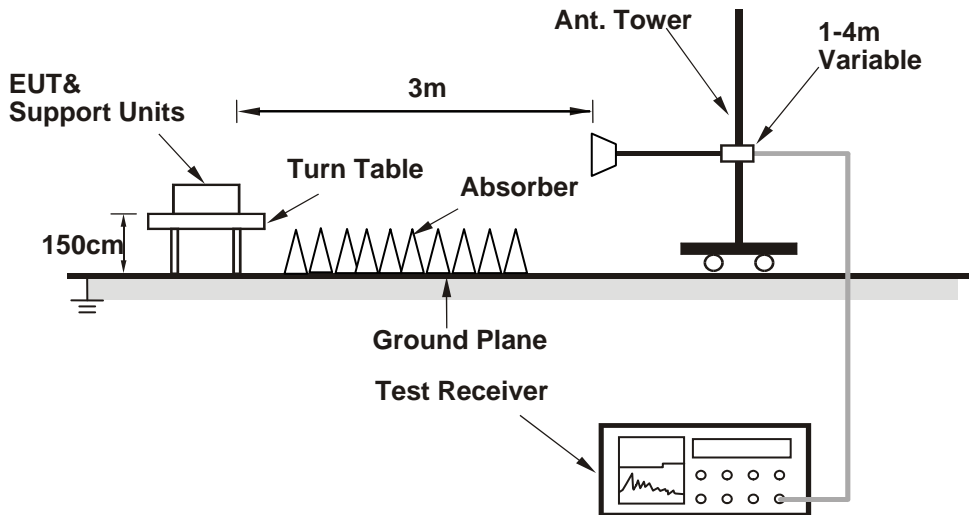

For the actual test configuration, please refer to the attached file (Test Setup Photo).

**4.1.6 EUT Operating Conditions**

- a. Connected the EUT with AC adapter placed on testing table.
- b. Set the EUT under transmission condition continuously at specific channel frequency.

4.1.7 Test Results

Mode A

ABOVE 1GHz DATA

<b>CAIcatel-Lucent EnterpriseNEL</b>	TX Channel 0	<b>DETECTOR FUNCTION</b>	Peak (PK)
<b>FREQUENCY RANGE</b>	1GHz ~ 25GHz		Average (AV)

**ANTENNA POLARITY & TEST DISTANCE: HORIZONTAL AT 3 M**

NO.	FREQ. (MHz)	EMISSION LEVEL (dBuV/m)	LIMIT (dBuV/m)	MARGIN (dB)	ANTENNA HEIGHT (m)	TABLE ANGLE (Degree)	RAW VALUE (dBuV)	CORRECTION FACTOR (dB/m)
1	2390.00	54.43 PK	74.00	-19.57	2.50 H	322	56.74	-2.31
2	2390.00	39.81 AV	54.00	-14.19	2.50 H	322	42.12	-2.31
3	*2402.00	108.96 PK			2.50 H	322	111.20	-2.24
4	*2402.00	108.03 AV			2.50 H	322	110.27	-2.24
5	4804.00	44.31 PK	74.00	-29.69	1.58 H	236	40.18	4.13
6	4804.00	34.12 AV	54.00	-19.88	1.58 H	236	29.99	4.13

**ANTENNA POLARITY & TEST DISTANCE: VERTICAL AT 3 M**

NO.	FREQ. (MHz)	EMISSION LEVEL (dBuV/m)	LIMIT (dBuV/m)	MARGIN (dB)	ANTENNA HEIGHT (m)	TABLE ANGLE (Degree)	RAW VALUE (dBuV)	CORRECTION FACTOR (dB/m)
1	2390.00	52.71 PK	74.00	-21.29	3.02 V	296	55.02	-2.31
2	2390.00	39.05 AV	54.00	-14.95	3.02 V	296	41.36	-2.31
3	*2402.00	102.61 PK			3.02 V	296	104.85	-2.24
4	*2402.00	101.39 AV			3.02 V	296	103.63	-2.24
5	4804.00	43.38 PK	74.00	-30.62	2.29 V	234	39.25	4.13
6	4804.00	32.47 AV	54.00	-21.53	2.29 V	234	28.34	4.13

**REMARKS:**

1. Emission Level(dBuV/m) = Raw Value(dBuV) + Correction Factor(dB/m)
2. Correction Factor(dB/m) = Antenna Factor(dB/m) + Cable Factor(dB) – Pre-Amplifier Factor(dB)
3. The other emission levels were very low against the limit.
4. Margin value = Emission Level – Limit value
5. " \* ": Fundamental frequency.

<b>CAIcatel-Lucent EnterpriseNEL</b>	TX Channel 19	<b>DETECTOR FUNCTION</b>	Peak (PK)
<b>FREQUENCY RANGE</b>	1GHz ~ 25GHz		Average (AV)

**ANTENNA POLARITY & TEST DISTANCE: HORIZONTAL AT 3 M**

NO.	FREQ. (MHz)	EMISSION LEVEL (dBuV/m)	LIMIT (dBuV/m)	MARGIN (dB)	ANTENNA HEIGHT (m)	TABLE ANGLE (Degree)	RAW VALUE (dBuV)	CORRECTION FACTOR (dB/m)
1	*2440.00	109.89 PK			2.48 H	323	111.88	-1.99
2	*2440.00	108.68 AV			2.48 H	323	110.67	-1.99
3	4880.00	45.00 PK	74.00	-29.00	1.67 H	169	40.75	4.25
4	4880.00	34.10 AV	54.00	-19.90	1.67 H	169	29.85	4.25

**ANTENNA POLARITY & TEST DISTANCE: VERTICAL AT 3 M**

NO.	FREQ. (MHz)	EMISSION LEVEL (dBuV/m)	LIMIT (dBuV/m)	MARGIN (dB)	ANTENNA HEIGHT (m)	TABLE ANGLE (Degree)	RAW VALUE (dBuV)	CORRECTION FACTOR (dB/m)
1	*2440.00	102.68 PK			3.04 V	288	104.67	-1.99
2	*2440.00	101.86 AV			3.04 V	288	103.85	-1.99
3	4880.00	43.93 PK	74.00	-30.07	1.69 V	220	39.68	4.25
4	4880.00	32.63 AV	54.00	-21.37	1.69 V	220	28.38	4.25

**REMARKS:**

1. Emission Level(dBuV/m) = Raw Value(dBuV) + Correction Factor(dB/m)
2. Correction Factor(dB/m) = Antenna Factor(dB/m) + Cable Factor(dB) – Pre-Amplifier Factor(dB)
3. The other emission levels were very low against the limit.
4. Margin value = Emission Level – Limit value
5. " \* ": Fundamental frequency.

<b>CAIcatel-Lucent EnterpriseNEL</b>	TX Channel 39	<b>DETECTOR FUNCTION</b>	Peak (PK)
<b>FREQUENCY RANGE</b>	1GHz ~ 25GHz		Average (AV)

**ANTENNA POLARITY & TEST DISTANCE: HORIZONTAL AT 3 M**

NO.	FREQ. (MHz)	EMISSION LEVEL (dBuV/m)	LIMIT (dBuV/m)	MARGIN (dB)	ANTENNA HEIGHT (m)	TABLE ANGLE (Degree)	RAW VALUE (dBuV)	CORRECTION FACTOR (dB/m)
1	*2480.00	111.03 PK			1.48 H	320	112.76	-1.73
2	*2480.00	109.51 AV			1.48 H	320	111.24	-1.73
3	2483.50	56.65 PK	74.00	-17.35	1.48 H	320	58.36	-1.71
4	2483.50	43.48 AV	54.00	-10.52	1.48 H	320	45.19	-1.71
5	4960.00	45.20 PK	74.00	-28.80	1.52 H	157	40.88	4.32
6	4960.00	34.08 AV	54.00	-19.92	1.52 H	157	29.76	4.32

**ANTENNA POLARITY & TEST DISTANCE: VERTICAL AT 3 M**

NO.	FREQ. (MHz)	EMISSION LEVEL (dBuV/m)	LIMIT (dBuV/m)	MARGIN (dB)	ANTENNA HEIGHT (m)	TABLE ANGLE (Degree)	RAW VALUE (dBuV)	CORRECTION FACTOR (dB/m)
1	*2480.00	103.94 PK			3.06 V	296	105.67	-1.73
2	*2480.00	102.78 AV			3.06 V	296	104.51	-1.73
3	2483.50	55.71 PK	74.00	-18.29	3.06 V	296	57.42	-1.71
4	2483.50	42.45 AV	54.00	-11.55	3.06 V	296	44.16	-1.71
5	4960.00	44.16 PK	74.00	-29.84	1.59 V	228	39.84	4.32
6	4960.00	32.67 AV	54.00	-21.33	1.59 V	228	28.35	4.32

**REMARKS:**

1. Emission Level(dBuV/m) = Raw Value(dBuV) + Correction Factor(dB/m)
2. Correction Factor(dB/m) = Antenna Factor(dB/m) + Cable Factor(dB) – Pre-Amplifier Factor(dB)
3. The other emission levels were very low against the limit.
4. Margin value = Emission Level – Limit value
5. " \* ": Fundamental frequency.

**Mode B**

**ABOVE 1GHz DATA**

<b>CAIcatel-Lucent EnterpriseNEL</b>	TX Channel 0	<b>DETECTOR FUNCTION</b>	Peak (PK)
<b>FREQUENCY RANGE</b>	1GHz ~ 25GHz		Average (AV)

**ANTENNA POLARITY & TEST DISTANCE: HORIZONTAL AT 3 M**

NO.	FREQ. (MHz)	EMISSION LEVEL (dBuV/m)	LIMIT (dBuV/m)	MARGIN (dB)	ANTENNA HEIGHT (m)	TABLE ANGLE (Degree)	RAW VALUE (dBuV)	CORRECTION FACTOR (dB/m)
1	2390.00	55.54 PK	74.00	-18.46	2.46 H	326	57.85	-2.31
2	2390.00	39.32 AV	54.00	-14.68	2.46 H	326	41.63	-2.31
3	*2402.00	109.29 PK			2.46 H	326	111.53	-2.24
4	*2402.00	108.19 AV			2.46 H	326	110.43	-2.24
5	4804.00	44.98 PK	74.00	-29.02	1.69 H	239	40.85	4.13
6	4804.00	31.98 AV	54.00	-22.02	1.69 H	239	27.85	4.13

**ANTENNA POLARITY & TEST DISTANCE: VERTICAL AT 3 M**

NO.	FREQ. (MHz)	EMISSION LEVEL (dBuV/m)	LIMIT (dBuV/m)	MARGIN (dB)	ANTENNA HEIGHT (m)	TABLE ANGLE (Degree)	RAW VALUE (dBuV)	CORRECTION FACTOR (dB/m)
1	2390.00	53.92 PK	74.00	-20.08	3.02 V	270	56.23	-2.31
2	2390.00	38.20 AV	54.00	-15.80	3.02 V	270	40.51	-2.31
3	*2402.00	102.32 PK			3.02 V	270	104.56	-2.24
4	*2402.00	101.48 AV			3.02 V	270	103.72	-2.24
5	4804.00	45.09 PK	74.00	-28.91	1.99 V	169	40.96	4.13
6	4804.00	32.15 AV	54.00	-21.85	1.99 V	169	28.02	4.13

**REMARKS:**

1. Emission Level(dBuV/m) = Raw Value(dBuV) + Correction Factor(dB/m)
2. Correction Factor(dB/m) = Antenna Factor(dB/m) + Cable Factor(dB) – Pre-Amplifier Factor(dB)
3. The other emission levels were very low against the limit.
4. Margin value = Emission Level – Limit value
5. " \* ": Fundamental frequency.

<b>Calcatel-Lucent EnterpriseNEL</b>	TX Channel 19	<b>DETECTOR FUNCTION</b>	Peak (PK)
<b>FREQUENCY RANGE</b>	1GHz ~ 25GHz		Average (AV)

**ANTENNA POLARITY & TEST DISTANCE: HORIZONTAL AT 3 M**

NO.	FREQ. (MHz)	EMISSION LEVEL (dBuV/m)	LIMIT (dBuV/m)	MARGIN (dB)	ANTENNA HEIGHT (m)	TABLE ANGLE (Degree)	RAW VALUE (dBuV)	CORRECTION FACTOR (dB/m)
1	*2440.00	109.48 PK			2.50 H	326	111.47	-1.99
2	*2440.00	108.27 AV			2.50 H	326	110.26	-1.99
3	4880.00	44.26 PK	74.00	-29.74	1.67 H	230	40.01	4.25
4	4880.00	31.94 AV	54.00	-22.06	1.67 H	230	27.69	4.25

**ANTENNA POLARITY & TEST DISTANCE: VERTICAL AT 3 M**

NO.	FREQ. (MHz)	EMISSION LEVEL (dBuV/m)	LIMIT (dBuV/m)	MARGIN (dB)	ANTENNA HEIGHT (m)	TABLE ANGLE (Degree)	RAW VALUE (dBuV)	CORRECTION FACTOR (dB/m)
1	*2440.00	102.89 PK			2.95 V	258	104.88	-1.99
2	*2440.00	101.01 AV			2.95 V	258	103.00	-1.99
3	4880.00	45.12 PK	74.00	-28.88	2.06 V	158	40.87	4.25
4	4880.00	32.84 AV	54.00	-21.16	2.06 V	158	28.59	4.25

**REMARKS:**

1. Emission Level(dBuV/m) = Raw Value(dBuV) + Correction Factor(dB/m)
2. Correction Factor(dB/m) = Antenna Factor(dB/m) + Cable Factor(dB) – Pre-Amplifier Factor(dB)
3. The other emission levels were very low against the limit.
4. Margin value = Emission Level – Limit value
5. " \* ": Fundamental frequency.



<b>CAIcatel-Lucent EnterpriseNEL</b>	TX Channel 39	<b>DETECTOR FUNCTION</b>	Peak (PK)
<b>FREQUENCY RANGE</b>	1GHz ~ 25GHz		Average (AV)

**ANTENNA POLARITY & TEST DISTANCE: HORIZONTAL AT 3 M**

NO.	FREQ. (MHz)	EMISSION LEVEL (dBuV/m)	LIMIT (dBuV/m)	MARGIN (dB)	ANTENNA HEIGHT (m)	TABLE ANGLE (Degree)	RAW VALUE (dBuV)	CORRECTION FACTOR (dB/m)
1	*2480.00	110.43 PK			2.52 H	323	112.16	-1.73
2	*2480.00	109.71 AV			2.52 H	323	111.44	-1.73
3	2483.50	56.71 PK	74.00	-17.29	2.52 H	323	58.42	-1.71
4	2483.50	43.45 AV	54.00	-10.55	2.52 H	323	45.16	-1.71
5	4960.00	44.91 PK	74.00	-29.09	1.64 H	205	40.59	4.32
6	4960.00	32.20 AV	54.00	-21.80	1.64 H	205	27.88	4.32

**ANTENNA POLARITY & TEST DISTANCE: VERTICAL AT 3 M**

NO.	FREQ. (MHz)	EMISSION LEVEL (dBuV/m)	LIMIT (dBuV/m)	MARGIN (dB)	ANTENNA HEIGHT (m)	TABLE ANGLE (Degree)	RAW VALUE (dBuV)	CORRECTION FACTOR (dB/m)
1	*2480.00	103.83 PK			3.04 V	266	105.56	-1.73
2	*2480.00	102.84 AV			3.04 V	266	104.57	-1.73
3	2483.50	55.70 PK	74.00	-18.30	3.04 V	266	57.41	-1.71
4	2483.50	42.32 AV	54.00	-11.68	3.04 V	266	44.03	-1.71
5	4960.00	45.09 PK	74.00	-28.91	1.94 V	174	40.77	4.32
6	4960.00	32.35 AV	54.00	-21.65	1.94 V	174	28.03	4.32

**REMARKS:**

1. Emission Level(dBuV/m) = Raw Value(dBuV) + Correction Factor(dB/m)
2. Correction Factor(dB/m) = Antenna Factor(dB/m) + Cable Factor(dB) – Pre-Amplifier Factor(dB)
3. The other emission levels were very low against the limit.
4. Margin value = Emission Level – Limit value
5. " \* ": Fundamental frequency.

**Mode A**

**BELOW 1GHz WORST-CASE DATA**

<b>CAIcatel-Lucent EnterpriseNEL</b>	TX Channel 39	<b>DETECTOR FUNCTION</b>	Quasi-Peak (QP)
<b>FREQUENCY RANGE</b>	9kHz ~ 1GHz		

**ANTENNA POLARITY & TEST DISTANCE: HORIZONTAL AT 3 M**

NO.	FREQ. (MHz)	EMISSION LEVEL (dBuV/m)	LIMIT (dBuV/m)	MARGIN (dB)	ANTENNA HEIGHT (m)	TABLE ANGLE (Degree)	RAW VALUE (dBuV)	CORRECTION FACTOR (dB/m)
1	42.46	19.30 QP	40.00	-20.70	2.36 H	163	28.80	-9.50
2	222.30	28.94 QP	46.00	-17.06	1.00 H	141	40.18	-11.24
3	400.01	33.83 QP	46.00	-12.17	2.15 H	232	39.15	-5.32
4	501.27	31.42 QP	46.00	-14.58	1.57 H	146	34.25	-2.83
5	620.54	29.22 QP	46.00	-16.78	2.23 H	221	29.37	-0.15
6	810.90	31.86 QP	46.00	-14.14	1.92 H	138	28.39	3.47

**ANTENNA POLARITY & TEST DISTANCE: VERTICAL AT 3 M**

NO.	FREQ. (MHz)	EMISSION LEVEL (dBuV/m)	LIMIT (dBuV/m)	MARGIN (dB)	ANTENNA HEIGHT (m)	TABLE ANGLE (Degree)	RAW VALUE (dBuV)	CORRECTION FACTOR (dB/m)
1	46.88	26.44 QP	40.00	-13.56	1.18 V	64	35.55	-9.11
2	106.10	25.25 QP	43.50	-18.25	1.34 V	111	38.35	-13.10
3	249.07	34.63 QP	46.00	-11.37	1.59 V	37	44.12	-9.49
4	400.06	28.21 QP	46.00	-17.79	2.25 V	12	33.53	-5.32
5	501.13	27.45 QP	46.00	-18.55	2.87 V	0	30.29	-2.84
6	667.92	28.77 QP	46.00	-17.23	1.99 V	54	28.44	0.33

**REMARKS:**

1. Emission Level(dBuV/m) = Raw Value(dBuV) + Correction Factor(dB/m)
2. Correction Factor(dB/m) = Antenna Factor(dB/m) + Cable Factor(dB) – Pre-Amplifier Factor(dB)
3. The other emission levels were very low against the limit.
4. Margin value = Emission Level – Limit value

**Mode B**

**BELOW 1GHz WORST-CASE DATA**

<b>CAIcatel-Lucent EnterpriseNEL</b>	TX Channel 39	<b>DETECTOR FUNCTION</b>	Quasi-Peak (QP)
<b>FREQUENCY RANGE</b>	9kHz ~ 1GHz		

**ANTENNA POLARITY & TEST DISTANCE: HORIZONTAL AT 3 M**

NO.	FREQ. (MHz)	EMISSION LEVEL (dBuV/m)	LIMIT (dBuV/m)	MARGIN (dB)	ANTENNA HEIGHT (m)	TABLE ANGLE (Degree)	RAW VALUE (dBuV)	CORRECTION FACTOR (dB/m)
1	46.39	20.16 QP	40.00	-19.84	2.09 H	57	29.22	-9.06
2	225.36	32.02 QP	46.00	-13.98	2.41 H	89	43.30	-11.28
3	341.18	27.88 QP	46.00	-18.12	2.03 H	35	34.33	-6.45
4	384.00	33.35 QP	46.00	-12.65	1.81 H	52	39.05	-5.70
5	471.69	33.38 QP	46.00	-12.62	2.22 H	38	36.87	-3.49
6	505.25	32.72 QP	46.00	-13.28	1.74 H	117	35.43	-2.71

**ANTENNA POLARITY & TEST DISTANCE: VERTICAL AT 3 M**

NO.	FREQ. (MHz)	EMISSION LEVEL (dBuV/m)	LIMIT (dBuV/m)	MARGIN (dB)	ANTENNA HEIGHT (m)	TABLE ANGLE (Degree)	RAW VALUE (dBuV)	CORRECTION FACTOR (dB/m)
1	48.14	25.99 QP	40.00	-14.01	1.68 V	230	35.19	-9.20
2	114.58	24.43 QP	43.50	-19.07	1.84 V	356	36.65	-12.22
<b>3</b>	<b>242.53</b>	<b>35.83 QP</b>	<b>46.00</b>	<b>-10.17</b>	<b>1.44 V</b>	<b>276</b>	<b>45.58</b>	<b>-9.75</b>
4	400.01	30.43 QP	46.00	-15.57	2.05 V	360	35.75	-5.32
5	508.31	27.77 QP	46.00	-18.23	2.36 V	235	30.42	-2.65
6	641.59	29.69 QP	46.00	-16.31	1.99 V	360	29.43	0.26

**REMARKS:**

1. Emission Level(dBuV/m) = Raw Value(dBuV) + Correction Factor(dB/m)
2. Correction Factor(dB/m) = Antenna Factor(dB/m) + Cable Factor(dB) – Pre-Amplifier Factor(dB)
3. The other emission levels were very low against the limit.
4. Margin value = Emission Level – Limit value

## 4.2 Conducted Emission Measurement

### 4.2.1 Limits of Conducted Emission Measurement

Frequency (MHz)	Conducted Limit (dBuV)	
	Quasi-peak	Average
0.15 - 0.5	66 - 56	56 - 46
0.50 - 5.0	56	46
5.0 - 30.0	60	50

Note: 1. The lower limit shall apply at the transition frequencies.

2. The limit decreases in line with the logarithm of the frequency in the range of 0.15 to 0.50MHz.

### 4.2.2 Test Instruments

Description & Manufacturer	Model No.	Serial No.	Cal. Date	Cal. Due
ROHDE & SCHWARZ TEST RECEIVER	ESCS 30	100276	Apr. 10, 2017	Apr. 9, 2018
ROHDE & SCHWARZ Artificial Mains Network (for EUT)	ENV216	101197	May 22, 2017	May 21, 2018
LISN With Adapter (for EUT)	AD10	C10Ada-002	May 22, 2017	May 21, 2018
ROHDE & SCHWARZ Artificial Mains Network (for peripherals)	ESH3-Z5	100218	Nov. 23, 2016	Nov. 22, 2017
SCHWARZBECK Artificial Mains Network (For EUT)	NNLK8129	8129229	May 9, 2017	May 8, 2018
Software	Cond_V7.3.7.4	NA	NA	NA
RF cable (JYEBAO) With 10dB PAD	5D-FB	Cable-C10.01	Feb. 14, 2017	Feb. 13, 2018
SUHNER Terminator (For ROHDE & SCHWARZ LISN)	65BNC-5001	E1-011484	May 18, 2017	May 17, 2018
ROHDE & SCHWARZ Artificial Mains Network (For TV EUT)	ESH3-Z5	100220	Nov. 8, 2016	Nov. 7, 2017
LISN With Adapter (for TV EUT)	100220	N/A	Nov. 8, 2016	Nov. 7, 2017

Notes: 1. The calibration interval of the above test instruments is 12 months and the calibrations are traceable to NML/ROC and NIST/USA.

2. The test was performed in Shielded Room No. 10.

3. Tested Date: Oct. 25, 2017

#### 4.2.3 Test Procedure

- a. The EUT was placed 0.4 meters from the conducting wall of the shielded room with EUT being connected to the power mains through a line impedance stabilization network (LISN). Other support units were connected to the power mains through another LISN. The two LISNs provide 50 ohm/ 50uH of coupling impedance for the measuring instrument.
- b. Both lines of the power mains connected to the EUT were checked for maximum conducted interference.
- c. The frequency range from 150kHz to 30MHz was searched. Emission levels under (Limit - 20dB) was not recorded.

**NOTE:** All modes of operation were investigated and the worst-case emissions are reported.

#### 4.2.4 Deviation from Test Standard

No deviation.

#### 4.2.5 Test Setup

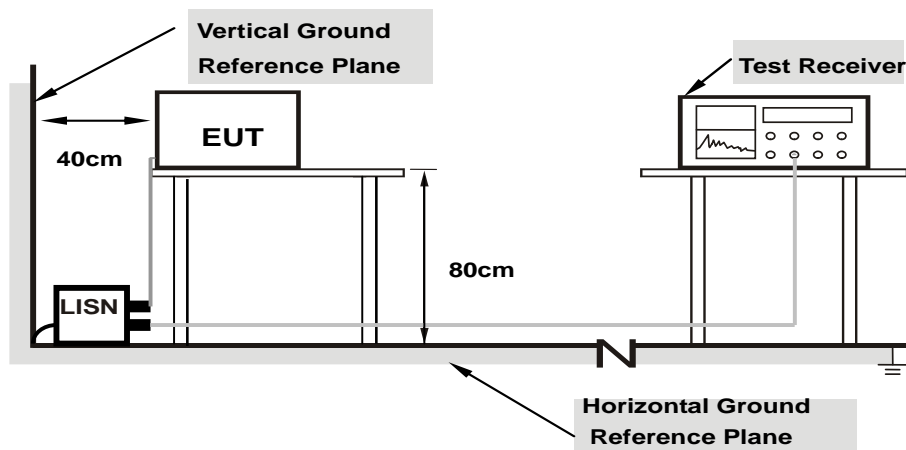

**Note: 1.Support units were connected to second LISN.**

For the actual test configuration, please refer to the attached file (Test Setup Photo).

#### 4.2.6 EUT Operating Condition

- a. Connected the EUT with AC adapter or PoE placed on testing table.
- b. Set the EUT under transmission condition continuously at specific channel frequency.

4.2.7 Test Results

Phase	Line (L)	Detector Function	Quasi-Peak (QP) / Average (AV)
Test Mode	Mode A		

Phase Of Power : Line (L)										
No	Frequency (MHz)	Correction Factor (dB)	Reading Value (dBuV)		Emission Level (dBuV)		Limit (dBuV)		Margin (dB)	
			Q.P.	AV.	Q.P.	AV.	Q.P.	AV.	Q.P.	AV.
1	0.15781	9.65	37.44	25.48	47.09	35.13	65.58	55.58	-18.49	-20.45
2	<b>0.35703</b>	<b>9.66</b>	<b>37.95</b>	<b>36.34</b>	<b>47.61</b>	<b>46.00</b>	<b>58.80</b>	<b>48.80</b>	<b>-11.19</b>	<b>-2.80</b>
3	0.64609	9.68	20.56	18.85	30.24	28.53	56.00	46.00	-25.76	-17.47
4	0.98594	9.70	18.64	12.07	28.34	21.77	56.00	46.00	-27.66	-24.23
5	3.61328	9.82	19.84	12.56	29.66	22.38	56.00	46.00	-26.34	-23.62
6	10.50000	9.93	26.21	21.65	36.14	31.58	60.00	50.00	-23.86	-18.42

Remarks:

1. Q.P. and AV. are abbreviations of quasi-peak and average individually.
2. The emission levels of other frequencies were very low against the limit.
3. Margin value = Emission level – Limit value
4. Correction factor = Insertion loss + Cable loss
5. Emission Level = Correction Factor + Reading Value

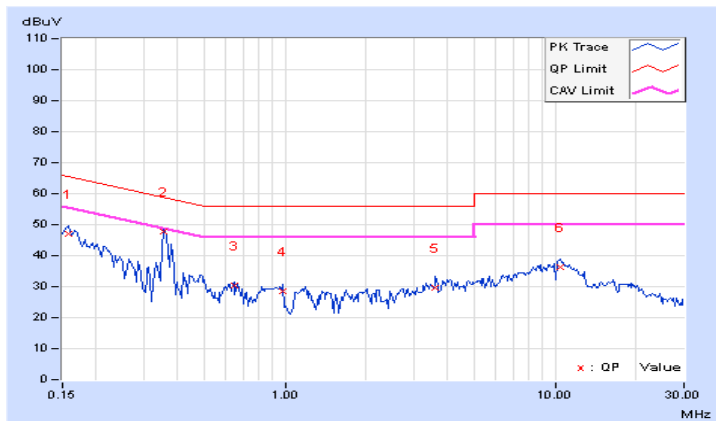

Phase	Neutral (N)	Detector Function	Quasi-Peak (QP) / Average (AV)
Test Mode	Mode A		

Phase Of Power : Neutral (N)										
No	Frequency (MHz)	Correction Factor (dB)	Reading Value (dBUV)		Emission Level (dBUV)		Limit (dBUV)		Margin (dB)	
			Q.P.	AV.	Q.P.	AV.	Q.P.	AV.	Q.P.	AV.
1	0.15391	9.67	36.27	25.04	45.94	34.71	65.79	55.79	-19.85	-21.08
2	0.36094	9.68	36.46	33.29	46.14	42.97	58.71	48.71	-12.57	-5.74
3	0.95859	9.71	18.07	13.59	27.78	23.30	56.00	46.00	-28.22	-22.70
4	1.40625	9.73	18.54	14.17	28.27	23.90	56.00	46.00	-27.73	-22.10
5	4.14844	9.86	19.70	12.96	29.56	22.82	56.00	46.00	-26.44	-23.18
6	10.00391	9.95	26.20	21.56	36.15	31.51	60.00	50.00	-23.85	-18.49

**Remarks:**

1. Q.P. and AV. are abbreviations of quasi-peak and average individually.
2. The emission levels of other frequencies were very low against the limit.
3. Margin value = Emission level – Limit value
4. Correction factor = Insertion loss + Cable loss
5. Emission Level = Correction Factor + Reading Value

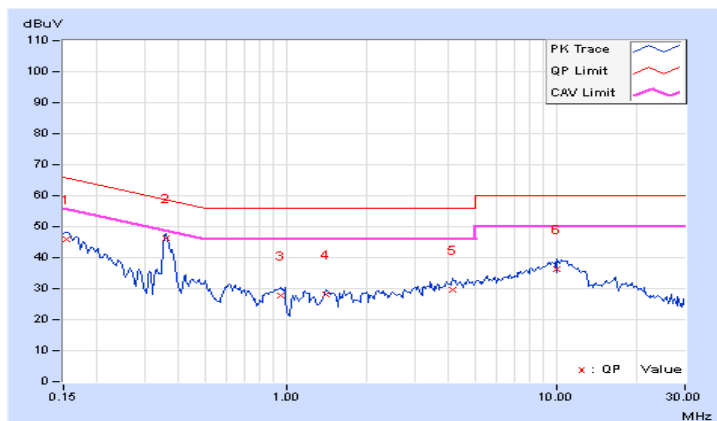

Phase	Line (L)	Detector Function	Quasi-Peak (QP) / Average (AV)
Test Mode	Mode B		

Phase Of Power : Line (L)										
No	Frequency (MHz)	Correction Factor (dB)	Reading Value (dBuV)		Emission Level (dBuV)		Limit (dBuV)		Margin (dB)	
			Q.P.	AV.	Q.P.	AV.	Q.P.	AV.	Q.P.	AV.
1	0.16562	9.65	38.32	31.05	47.97	40.70	65.18	55.18	-17.21	-14.48
2	0.31797	9.66	27.23	18.44	36.89	28.10	59.76	49.76	-22.87	-21.66
3	0.50000	9.67	33.72	27.83	43.39	37.50	56.00	46.00	-12.61	-8.50
4	0.84141	9.69	13.98	7.54	23.67	17.23	56.00	46.00	-32.33	-28.77
5	3.16797	9.80	8.26	4.79	18.06	14.59	56.00	46.00	-37.94	-31.41
6	9.96484	9.93	15.38	10.70	25.31	20.63	60.00	50.00	-34.69	-29.37

**Remarks:**

1. Q.P. and AV. are abbreviations of quasi-peak and average individually.
2. The emission levels of other frequencies were very low against the limit.
3. Margin value = Emission level – Limit value
4. Correction factor = Insertion loss + Cable loss
5. Emission Level = Correction Factor + Reading Value

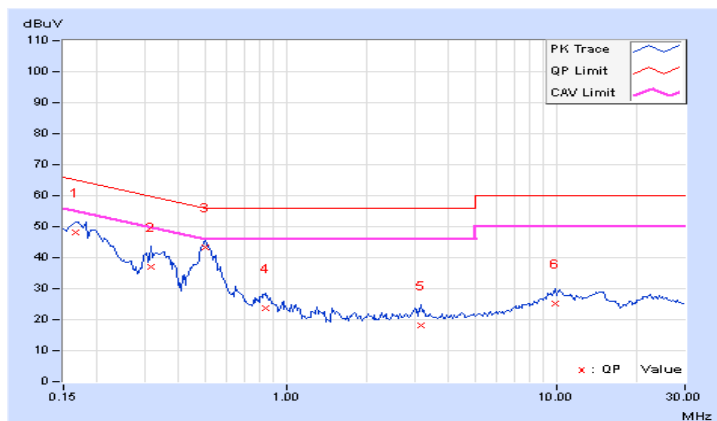



Phase	Neutral (N)	Detector Function	Quasi-Peak (QP) / Average (AV)
Test Mode	Mode B		

Phase Of Power : Neutral (N)										
No	Frequency (MHz)	Correction Factor (dB)	Reading Value (dBuV)		Emission Level (dBuV)		Limit (dBuV)		Margin (dB)	
			Q.P.	AV.	Q.P.	AV.	Q.P.	AV.	Q.P.	AV.
1	0.16172	9.67	37.96	30.48	47.63	40.15	65.38	55.38	-17.75	-15.23
2	0.32969	9.68	27.92	20.87	37.60	30.55	59.46	49.46	-21.86	-18.91
3	0.49375	9.68	32.95	26.86	42.63	36.54	56.10	46.10	-13.47	-9.56
4	0.81016	9.70	14.13	8.47	23.83	18.17	56.00	46.00	-32.17	-27.83
5	2.92969	9.80	7.43	2.89	17.23	12.69	56.00	46.00	-38.77	-33.31
6	10.21484	9.95	16.46	11.52	26.41	21.47	60.00	50.00	-33.59	-28.53

**Remarks:**

1. Q.P. and AV. are abbreviations of quasi-peak and average individually.
2. The emission levels of other frequencies were very low against the limit.
3. Margin value = Emission level – Limit value
4. Correction factor = Insertion loss + Cable loss
5. Emission Level = Correction Factor + Reading Value

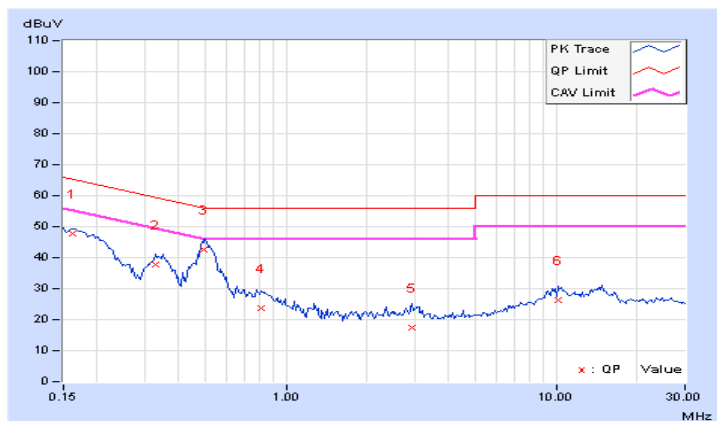

Phase	Line (L)	Detector Function	Quasi-Peak (QP) / Average (AV)
Test Mode	Mode C		

Phase Of Power : Line (L)										
No	Frequency (MHz)	Correction Factor (dB)	Reading Value (dBuV)		Emission Level (dBuV)		Limit (dBuV)		Margin (dB)	
			Q.P.	AV.	Q.P.	AV.	Q.P.	AV.	Q.P.	AV.
1	0.15000	9.65	40.98	28.26	50.63	37.91	66.00	56.00	-15.37	-18.09
2	0.55234	9.67	37.32	32.35	46.99	42.02	56.00	46.00	-9.01	-3.98
3	0.96250	9.70	22.03	17.01	31.73	26.71	56.00	46.00	-24.27	-19.29
4	2.41016	9.76	27.08	20.04	36.84	29.80	56.00	46.00	-19.16	-16.20
5	4.95703	9.85	28.81	24.10	38.66	33.95	56.00	46.00	-17.34	-12.05
6	11.85938	9.94	11.31	6.09	21.25	16.03	60.00	50.00	-38.75	-33.97

**Remarks:**

1. Q.P. and AV. are abbreviations of quasi-peak and average individually.
2. The emission levels of other frequencies were very low against the limit.
3. Margin value = Emission level – Limit value
4. Correction factor = Insertion loss + Cable loss
5. Emission Level = Correction Factor + Reading Value

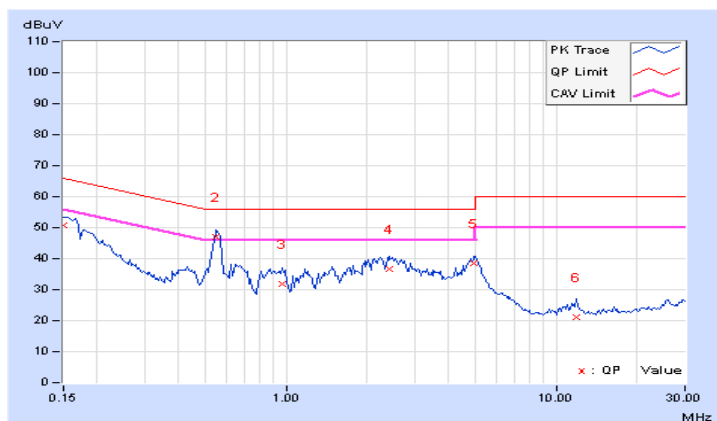

Phase	Neutral (N)	Detector Function	Quasi-Peak (QP) / Average (AV)
Test Mode	Mode C		

Phase Of Power : Neutral (N)										
No	Frequency (MHz)	Correction Factor (dB)	Reading Value (dBuV)		Emission Level (dBuV)		Limit (dBuV)		Margin (dB)	
			Q.P.	AV.	Q.P.	AV.	Q.P.	AV.	Q.P.	AV.
1	0.15391	9.67	41.99	29.12	51.66	38.79	65.79	55.79	-14.13	-17.00
2	0.55625	9.69	37.12	32.21	46.81	41.90	56.00	46.00	-9.19	-4.10
3	0.86094	9.70	21.25	16.35	30.95	26.05	56.00	46.00	-25.05	-19.95
4	2.17188	9.76	26.21	20.64	35.97	30.40	56.00	46.00	-20.03	-15.60
5	4.87500	9.87	27.82	23.00	37.69	32.87	56.00	46.00	-18.31	-13.13
6	11.91797	9.97	10.82	5.30	20.79	15.27	60.00	50.00	-39.21	-34.73

**Remarks:**

1. Q.P. and AV. are abbreviations of quasi-peak and average individually.
2. The emission levels of other frequencies were very low against the limit.
3. Margin value = Emission level – Limit value
4. Correction factor = Insertion loss + Cable loss
5. Emission Level = Correction Factor + Reading Value

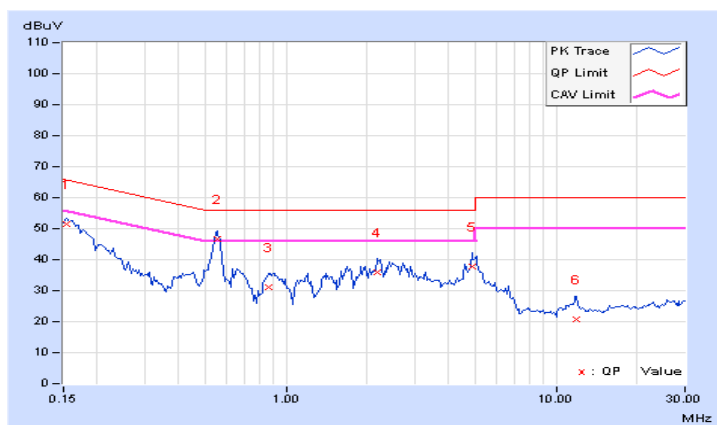

Phase	Line (L)	Detector Function	Quasi-Peak (QP) / Average (AV)
Test Mode	Mode D		

Phase Of Power : Line (L)										
No	Frequency (MHz)	Correction Factor (dB)	Reading Value (dBuV)		Emission Level (dBuV)		Limit (dBuV)		Margin (dB)	
			Q.P.	AV.	Q.P.	AV.	Q.P.	AV.	Q.P.	AV.
1	0.16562	9.65	39.50	30.10	49.15	39.75	65.18	55.18	-16.03	-15.43
2	0.18906	9.65	27.07	4.70	36.72	14.35	64.08	54.08	-27.36	-39.73
3	0.43906	9.66	26.94	22.02	36.60	31.68	57.08	47.08	-20.48	-15.40
4	0.83750	9.69	20.64	7.22	30.33	16.91	56.00	46.00	-25.67	-29.09
5	10.34766	9.93	19.30	13.50	29.23	23.43	60.00	50.00	-30.77	-26.57
6	29.10156	10.14	25.13	19.61	35.27	29.75	60.00	50.00	-24.73	-20.25

**Remarks:**

1. Q.P. and AV. are abbreviations of quasi-peak and average individually.
2. The emission levels of other frequencies were very low against the limit.
3. Margin value = Emission level – Limit value
4. Correction factor = Insertion loss + Cable loss
5. Emission Level = Correction Factor + Reading Value

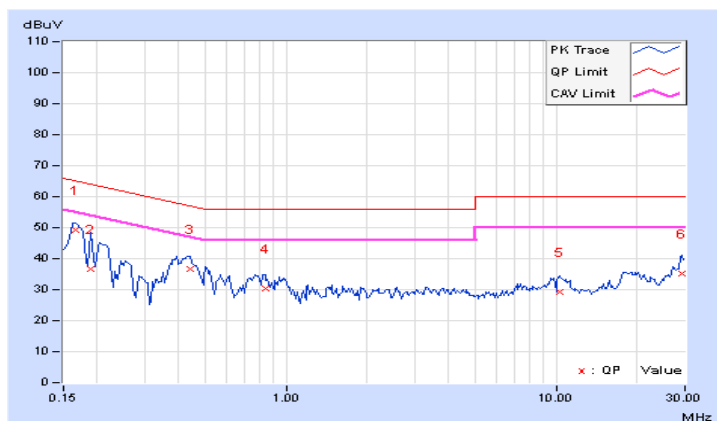

Phase	Neutral (N)	Detector Function	Quasi-Peak (QP) / Average (AV)
Test Mode	Mode D		

Phase Of Power : Neutral (N)										
No	Frequency (MHz)	Correction Factor (dB)	Reading Value (dBuV)		Emission Level (dBuV)		Limit (dBuV)		Margin (dB)	
			Q.P.	AV.	Q.P.	AV.	Q.P.	AV.	Q.P.	AV.
1	0.16562	9.67	38.36	29.76	48.03	39.43	65.18	55.18	-17.15	-15.75
2	0.21250	9.67	32.69	22.50	42.36	32.17	63.11	53.11	-20.75	-20.94
3	0.43125	9.68	28.64	20.29	38.32	29.97	57.23	47.23	-18.91	-17.26
4	2.99609	9.80	11.97	3.90	21.77	13.70	56.00	46.00	-34.23	-32.30
5	18.14844	10.04	22.72	17.16	32.76	27.20	60.00	50.00	-27.24	-22.80
6	29.05469	10.12	24.97	19.51	35.09	29.63	60.00	50.00	-24.91	-20.37

**Remarks:**

1. Q.P. and AV. are abbreviations of quasi-peak and average individually.
2. The emission levels of other frequencies were very low against the limit.
3. Margin value = Emission level – Limit value
4. Correction factor = Insertion loss + Cable loss
5. Emission Level = Correction Factor + Reading Value

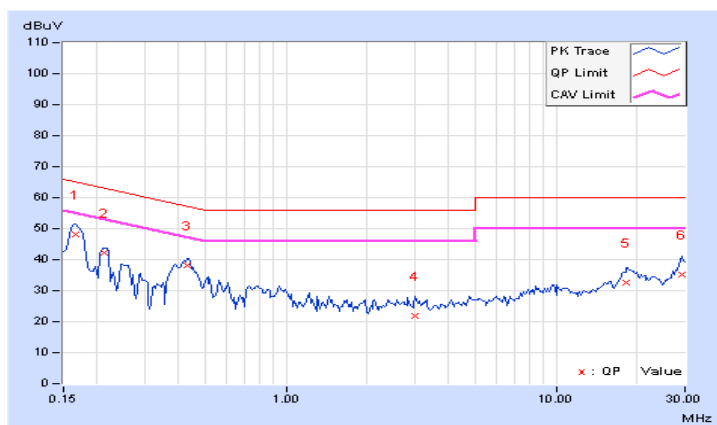

### 4.3 6dB Bandwidth Measurement

#### 4.3.1 Limits of 6dB Bandwidth Measurement

The minimum of 6dB Bandwidth Measurement is 0.5 MHz.

#### 4.3.2 Test Setup

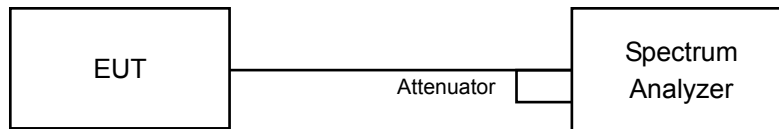

#### 4.3.3 Test Instruments

Refer to section 4.1.2 to get information of above instrument.

#### 4.3.4 Test Procedure

- a. Set resolution bandwidth (RBW) = 100kHz
- b. Set the video bandwidth (VBW)  $\geq 3 \times$  RBW, Detector = Peak.
- c. Trace mode = max hold.
- d. Sweep = auto couple.
- e. Measure the maximum width of the emission that is constrained by the frequencies associated with the two amplitude points (upper and lower) that are attenuated by 6 dB relative to the maximum level measured in the fundamental emission

#### 4.3.5 Deviation from Test Standard

No deviation.

#### 4.3.6 EUT Operating Conditions

The software provided by client to enable the EUT under transmission condition continuously at lowest, middle and highest channel frequencies individually.

4.3.7 Test Result

Mode A & Mode B

CHANNEL	FREQUENCY (MHz)	6dB BANDWIDTH (MHz)	MINIMUM LIMIT (MHz)	PASS / FAIL
0	2402	0.70	0.5	PASS
19	2440	0.71	0.5	PASS
39	2480	0.71	0.5	PASS

SPECTRUM PLOT OF WORST VALUE

CH 39

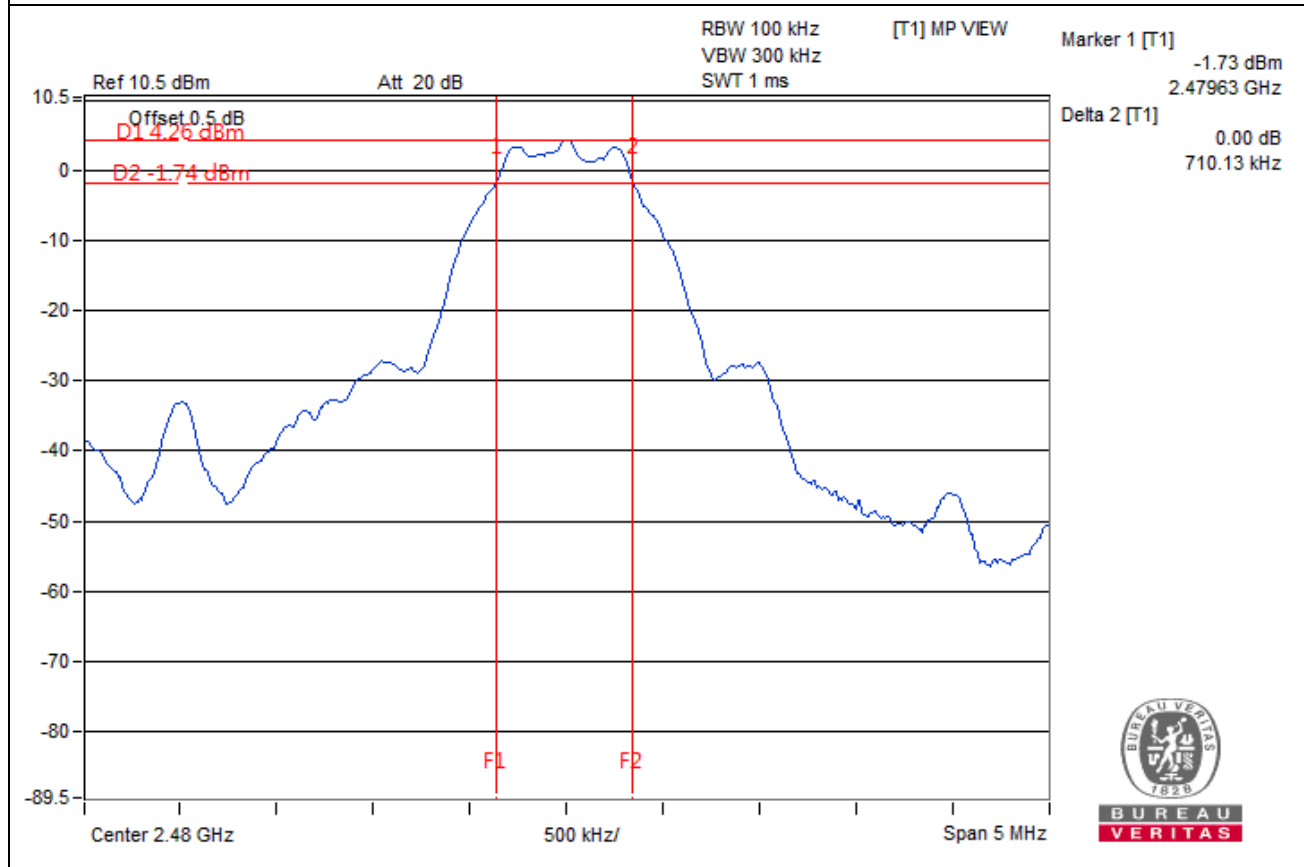

#### 4.4 Conducted Output Power Measurement

##### 4.4.1 Limits OF Conducted Output Power Measurement

For systems using digital modulation in the 2400–2483.5 MHz bands: 1 Watt (30dBm)

##### 4.4.2 Test Setup

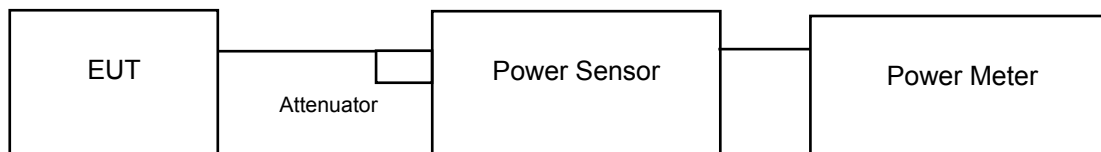

##### 4.4.3 Test Instruments

Refer to section 4.1.2 to get information of above instrument.

##### 4.4.4 Test Procedures

A peak / average power sensor was used on the output port of the EUT. A power meter was used to read the response of the peak / average power sensor. Record the power level.

##### 4.4.5 Deviation from Test Standard

No deviation.

##### 4.4.6 EUT Operating Conditions

Same as Item 4.3.6.

##### 4.4.7 Test Results

###### Mode A & Mode B

Channel	Frequency (MHz)	Peak Power (mW)	Peak Power (dBm)	Limit (dBm)	Pass/Fail
0	2402	1.033	0.14	30	Pass
19	2440	2.028	3.07	30	Pass
39	2480	<b>2.831</b>	4.52	30	Pass



## 4.5 Power Spectral Density Measurement

### 4.5.1 Limits of Power Spectral Density Measurement

The Maximum of Power Spectral Density Measurement is 8dBm.

### 4.5.2 Test Setup

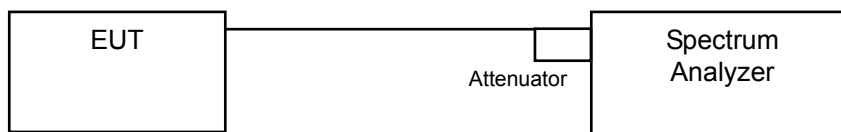

### 4.5.3 Test Instruments

Refer to section 4.1.2 to get information of above instrument.

### 4.5.4 Test Procedure

- a. Set analyzer center frequency to DTS channel center frequency.
- b. Set the span to 1.5 times the DTS bandwidth.
- c. Set the RBW to:  $3 \text{ kHz} \leq \text{RBW} \leq 100 \text{ kHz}$ .
- d. Set the VBW  $\geq 3 \times \text{RBW}$ .
- e. Detector = peak.
- f. Sweep time = auto couple.
- g. Trace mode = max hold.
- h. Allow trace to fully stabilize.
- i. Use the peak marker function to determine the maximum amplitude level within the RBW.

### 4.5.5 Deviation from Test Standard

No deviation.

### 4.5.6 EUT Operating Condition

Same as Item 4.3.6

4.5.7 Test Results

Mode A & Mode B:

Channel	Freq. (MHz)	PSD (dBm/3kHz)	Limit (dBm/3kHz)	PASS /FAIL
0	2402	-15.58	8	PASS
19	2440	-12.49	8	PASS
39	2480	-11.17	8	PASS

SPECTRUM PLOT OF WORST VALUE

CH 39

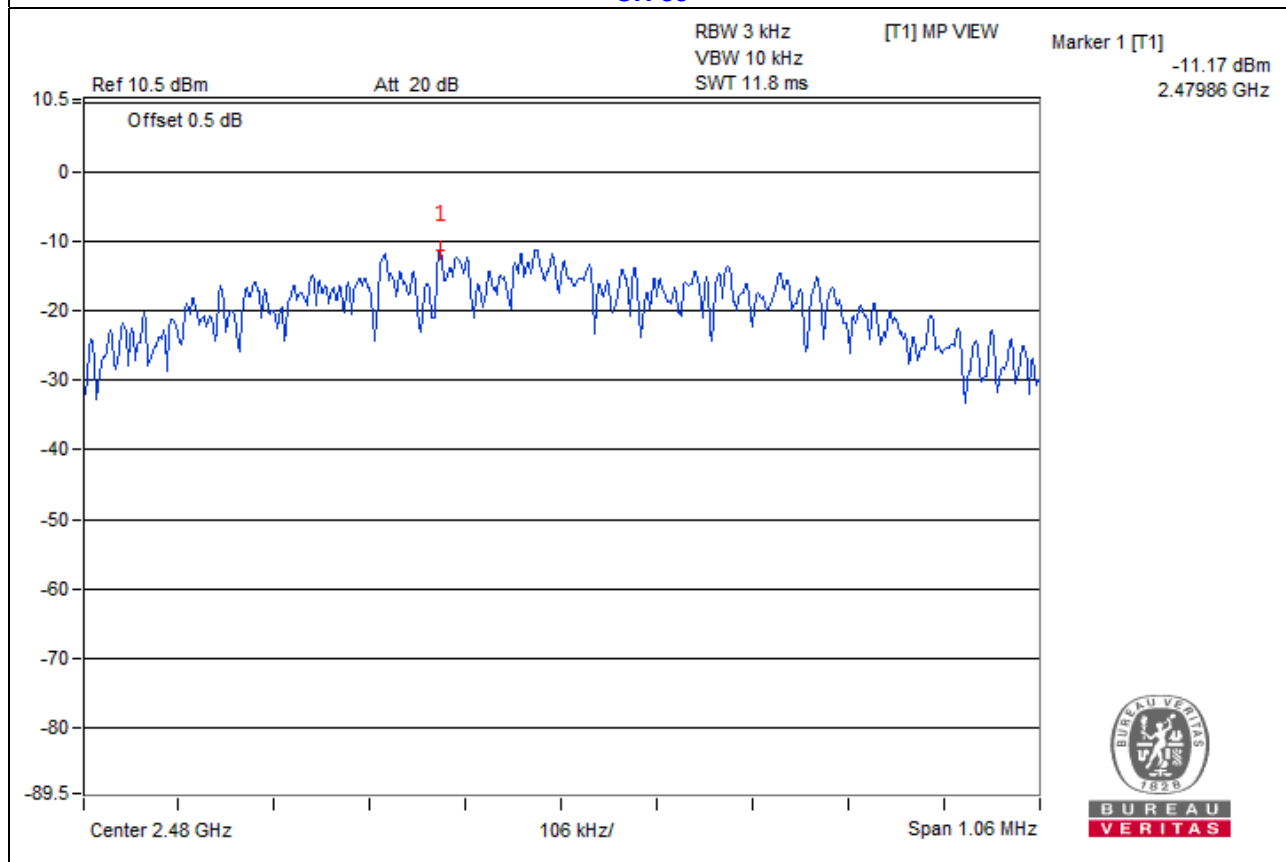

## 4.6 Conducted Out of Band Emission Measurement

### 4.6.1 Limits of Conducted Out of Band Emission Measurement

Below  $-20\text{dB}$  of the highest emission level of operating band (in 100kHz Resolution Bandwidth).

### 4.6.2 Test Setup

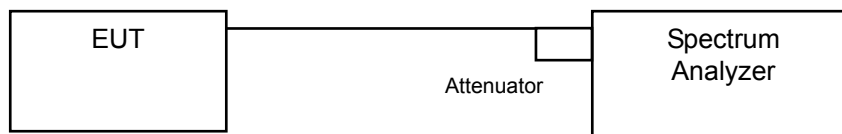

### 4.6.3 Test Instruments

Refer to section 4.1.2 to get information of above instrument.

### 4.6.4 Test Procedure

#### MEASUREMENT PROCEDURE REF

1. Set the RBW = 100 kHz.
2. Set the VBW  $\geq$  300 kHz.
3. Detector = peak.
4. Sweep time = auto couple.
5. Trace mode = max hold.
6. Allow trace to fully stabilize.
7. Use the peak marker function to determine the maximum power level in any 100 kHz band segment within the fundamental EBW.

#### MEASUREMENT PROCEDURE OOBE

1. Set RBW = 100 kHz.
2. Set VBW  $\geq$  300 kHz.
3. Detector = peak.
4. Sweep = auto couple.
5. Trace Mode = max hold.
6. Allow trace to fully stabilize.
7. Use the peak marker function to determine the maximum amplitude level.

### 4.6.5 Deviation from Test Standard

No deviation.

### 4.6.6 EUT Operating Condition

Same as Item 4.3.6

### 4.6.7 Test Results Mode A & Mode B

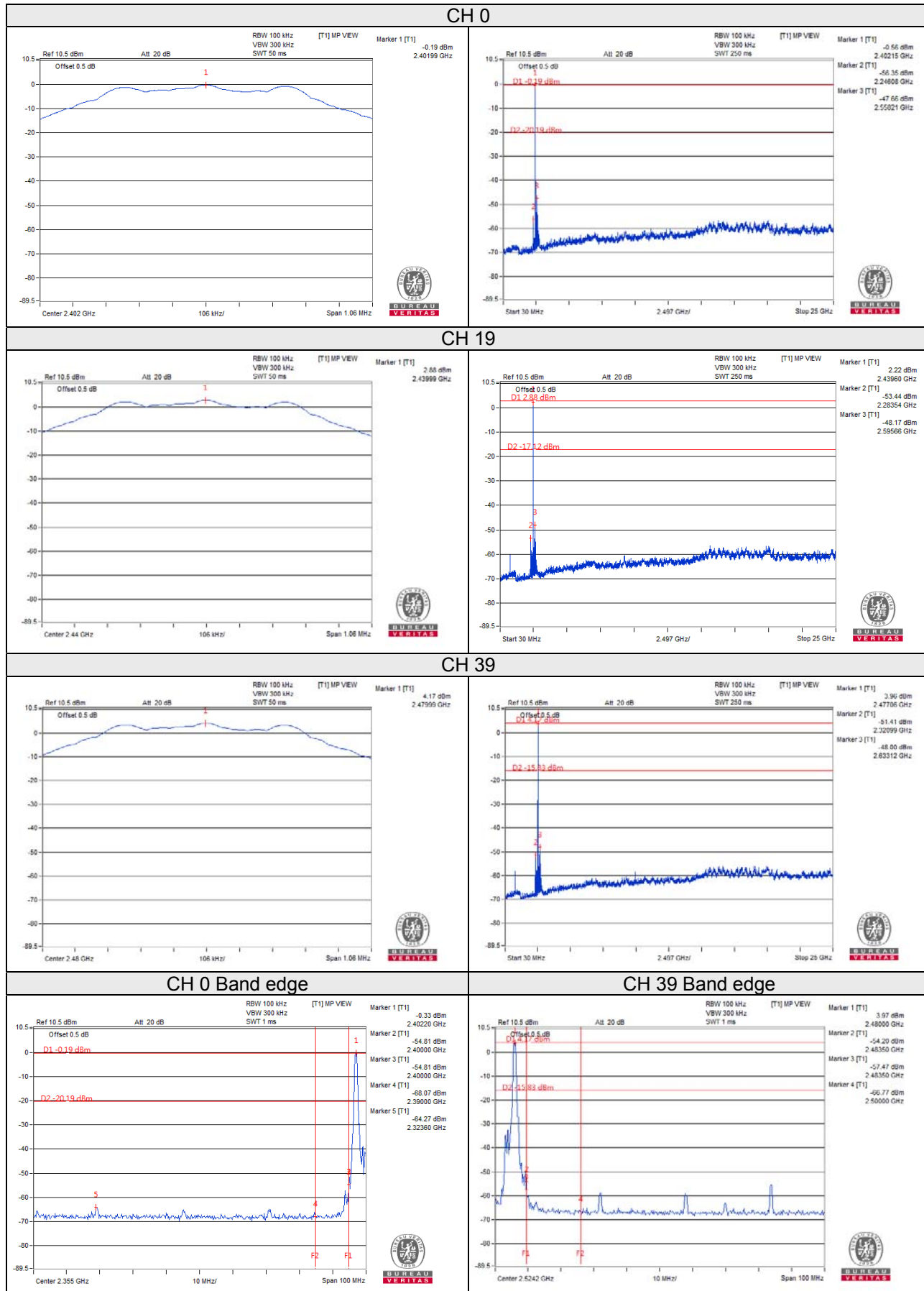

## 5 Pictures of Test Arrangements

Please refer to the attached file (Test Setup Photo).

## Appendix – Information on the Testing Laboratories

We, Bureau Veritas Consumer Products Services (H.K.) Ltd., Taoyuan Branch, were founded in 1988 to provide our best service in EMC, Radio, Telecom and Safety consultation. Our laboratories are accredited and approved according to ISO/IEC 17025.

If you have any comments, please feel free to contact us at the following:

**Linko EMC/RF Lab**

Tel: 886-2-26052180

Fax: 886-2-26051924

**Hsin Chu EMC/RF/Telecom Lab**

Tel: 886-3-6668565

Fax: 886-3-6668323

**Hwa Ya EMC/RF/Safety Lab**

Tel: 886-3-3183232

Fax: 886-3-3270892

**Email:** [service.adt@tw.bureauveritas.com](mailto:service.adt@tw.bureauveritas.com)

**Web Site:** [www.bureauveritas-adt.com](http://www.bureauveritas-adt.com)

The address and road map of all our labs can be found in our web site also.

--- END ---