

FCC Test Report

Report No.: RF180615D14A

FCC ID: 2AI9TOAW-AP1201H

Test Model: OAW-AP1201H

Received Date: Apr. 26, 2018

Test Date: May 9 ~ Jul. 9, 2018

Issued Date: Aug. 27, 2018

Applicant: ALE USA Inc.

Address: 26801 West Agoura Road, Calabasas, CA 91301

Issued By: Bureau Veritas Consumer Products Services (H.K.) Ltd., Taoyuan Branch

Lab Address: No. 47-2, 14th Ling, Chia Pau Vil., Lin Kou Dist., New Taipei City, Taiwan (R.O.C.)

**FCC Registration /
Designation Number:** 198487 / TW2021



This report is for your exclusive use. Any copying or replication of this report to or for any other person or entity, or use of our name or trademark, is permitted only with our prior written permission. This report sets forth our findings solely with respect to the test samples identified herein. The results set forth in this report are not indicative or representative of the quality or characteristics of the lot from which a test sample was taken or any similar or identical product unless specifically and expressly noted. Our report includes all of the tests requested by you and the results thereof based upon the information that you provided to us. You have 60 days from date of issuance of this report to notify us of any material error or omission caused by our negligence, provided, however, that such notice shall be in writing and shall specifically address the issue you wish to raise. A failure to raise such issue within the prescribed time shall constitute your unqualified acceptance of the completeness of this report, the tests conducted and the correctness of the report contents. Unless specific mention, the uncertainty of measurement has been explicitly taken into account to declare the compliance or non-compliance to the specification. The report must not be used by the client to claim product certification, approval, or endorsement by TAF or any government agencies.

Table of Contents

Release Control Record	4
1 Certificate of Conformity	5
2 Summary of Test Results	6
2.1 Measurement Uncertainty.....	6
2.2 Modification Record.....	6
3 General Information	7
3.1 General Description of EUT	7
3.2 Description of Test Modes	9
3.2.1 Test Mode Applicability and Tested Channel Detail	10
3.3 Duty Cycle of Test Signal.....	12
3.4 Description of Support Units	13
3.4.1 Configuration of System under Test	13
3.5 General Description of Applied Standard.....	14
4 Test Types and Results.....	15
4.1 Radiated Emission and Bandedge Measurement.....	15
4.1.1 Limits of Radiated Emission and Bandedge Measurement.....	15
4.1.2 Test Instruments	16
4.1.3 Test Procedure.....	17
4.1.4 Deviation from Test Standard.....	17
4.1.5 Test Setup.....	18
4.1.6 EUT Operating Condition.....	19
4.1.7 Test Results	20
4.2 Conducted Emission Measurement.....	58
4.2.1 Limits of Conducted Emission Measurement	58
4.2.2 Test Instruments	58
4.2.3 Test Procedure.....	59
4.2.4 Deviation from Test Standard.....	59
4.2.5 Test Setup.....	59
4.2.6 EUT Operating Condition.....	59
4.2.7 Test Results	60
4.3 Transmit Power Measurement.....	64
4.3.1 Limits of Transmit Power Measurement.....	64
4.3.2 Test Setup.....	64
4.3.3 Test Instruments	64
4.3.4 Test Procedure.....	65
4.3.5 Deviation from Test Standard.....	65
4.3.6 EUT Operating Condition.....	65
4.3.7 Test Result.....	66
4.4 Occupied Bandwidth Measurement.....	74
4.4.1 Test Setup.....	74
4.4.2 Test Instruments	74
4.4.3 Test Procedure.....	74
4.4.4 Test Results	75
4.5 Peak Power Spectral Density Measurement.....	78
4.5.1 Limits of Peak Power Spectral Density Measurement.....	78
4.5.2 Test Setup.....	78
4.5.3 Test Instruments	78
4.5.4 Test Procedure.....	78
4.5.5 Deviation from Test Standard.....	78
4.5.6 EUT Operating Condition.....	78
4.5.7 Test Results	79
4.6 Frequency Stability Measurement	82

4.6.1	Limits of Frequency Stability Measurement	82
4.6.2	Test Setup.....	82
4.6.3	Test Instruments	82
4.6.4	Test Procedure.....	82
4.6.5	Deviation from Test Standard.....	82
4.6.6	EUT Operating Condition.....	82
4.6.7	Test Results	83
5	Pictures of Test Arrangements.....	84
	Appendix – Information on the Testing Laboratories	85

Release Control Record

Issue No.	Description	Date Issued
RF180615D14A	Original release.	Aug. 27, 2018

1 Certificate of Conformity

Product: OmniAccess Stellar

Brand: Alcatel-Lucent Enterprise

Test Model: OAW-AP1201H

Sample Status: Engineering sample

Applicant: ALE USA Inc.

Test Date: May 9 ~ Jul. 9, 2018

Standard: 47 CFR FCC Part 15, Subpart E (Section 15.407)
ANSI C63.10: 2013

The above equipment has been tested by **Bureau Veritas Consumer Products Services (H.K.) Ltd., Taoyuan Branch**, and found compliance with the requirement of the above standards. The test record, data evaluation & Equipment Under Test (EUT) configurations represented herein are true and accurate accounts of the measurements of the sample's RF characteristics under the conditions specified in this report.

Prepared by : Annie Chang, **Date:** Aug. 27, 2018
Annie Chang / Senior Specialist

Approved by : Rex Lai, **Date:** Aug. 27, 2018
Rex Lai / Associate Technical Manager

2 Summary of Test Results

47 CFR FCC Part 15, Subpart E (Section 15.407)			
FCC Clause	Test Item	Result	Remarks
15.407(b)(6)	AC Power Conducted Emissions	Pass	Meet the requirement of limit. Minimum passing margin is -3.92dB at 15.07422MHz.
15.407(b)(1/2/3/4(i/ii)/6)	Radiated Emissions & Band Edge Measurement*	Pass	Meet the requirement of limit. Minimum passing margin is -1.01dB at 5350.00MHz.
15.407(a)(1/2/3)	Max Average Transmit Power	Pass	Meet the requirement of limit.
---	Occupied Bandwidth Measurement	-	Reference only.
15.407(a)(1/2/3)	Peak Power Spectral Density	Pass	Meet the requirement of limit.
15.407(g)	Frequency Stability	Pass	Meet the requirement of limit.
15.203	Antenna Requirement	Pass	Antenna connector is I-PEX not a standard connector.

*For U-NII-3 band compliance with rule part 15.407(b)(4)(i), the OOB test plots were recorded in Annex A.

2.1 Measurement Uncertainty

Where relevant, the following measurement uncertainty levels have been estimated for tests performed on the EUT as specified in CISPR 16-4-2:

Measurement	Frequency	Expanded Uncertainty (k=2) (\pm)
Conducted Emissions at mains ports	150kHz ~ 30MHz	2.79 dB
Radiated Emissions up to 1 GHz	9kHz ~ 30MHz	2.38 dB
	30MHz ~ 1000MHz	5.54 dB
Radiated Emissions above 1 GHz	1GHz ~ 6GHz	4.77 dB
	6GHz ~ 18GHz	5.48 dB

2.2 Modification Record

There were no modifications required for compliance.

3 General Information

3.1 General Description of EUT

Product	OmniAccess Stellar
Brand	Alcatel-Lucent Enterprise
Test Model	OAW-AP1201H
Status of EUT	Engineering sample
Power Supply Rating	48Vdc from Adapter or 55Vdc from PoE
Modulation Type	64QAM, 16QAM, QPSK, BPSK for OFDM 256QAM for OFDM in 11ac mode only.
Modulation Technology	OFDM
Transfer Rate	802.11a: 54/48/36/24/18/12/9/6Mbps 802.11n: up to 300Mbps 802.11ac: up to 866.6Mbps
Operating Frequency	5260 ~ 5320MHz, 5500 ~ 5700MHz
Number of Channel	5260 ~ 5320MHz: 4 for 802.11a, 802.11n (20MHz) 2 for 802.11n (40MHz) 1 for 802.11ac (80MHz) 5500 ~ 5700MHz 11 for 802.11a, 802.11n (20MHz) 5 for 802.11n (40MHz) 2 for 802.11ac (80MHz)
Output Power	5260 ~ 5320MHz: 232.119mW 5500 ~ 5700MHz: 231.570mW
Antenna Type	Printed antenna with 6.3dBi gain
Antenna Connector	I-PEX
Accessory Device	N/A
Data Cable Supplied	N/A

Note:

1. This report is issued as a supplementary report to BV CPS report no. RF180615D14. The difference compared with original report is adding U-NII-2A, U-NII-2C band, therefore the EUT is re-tested in this report.
2. This report is prepared for FCC class II permissive change.

3. The EUT provides 2 completed transmitters and 2 receivers.

Modulation Mode	TX Function
802.11a	2TX
802.11n (20MHz)	2TX
802.11n (40MHz)	2TX
802.11ac (20MHz)	2TX
802.11ac (40MHz)	2TX
802.11ac (80MHz)	2TX

Note: The modulation and bandwidth are similar for 802.11n mode for 20MHz (40MHz) and 802.11ac mode for 20MHz (40MHz), therefore investigated worst case to representative mode in test report. (Final test mode refer section 3.2.1)

4. The EUT uses following adapter or PoE Adapter (Support unit only):

Item	Brand	Model No.	Rating
Adapter	DELTA	ADP-30HR B	AC I/P: 100-240V, 50-60Hz, 1A DC O/P: 48V, 0.66A Non-shielded DC (1.5m) with one ferrite core
PoE Adapter	Microsemi	PD-9001GR/AT/AC	AC I/P: 100-240V, 50/60Hz, 0.67A DC O/P: 55V, 0.6A

5. For Radiated test, the EUT was pre-tested with the following modes:

- ✧ Operating Mode, Powered from Adapter
- ✧ Operating Mode, Powered from PoE

The worst emission level was found when the EUT tested under **Operating Mode, Powered from Adapter**, therefore, only its test data was recorded in this report.

6. The above EUT information is declared by manufacturer and for more detailed features description, please refers to the manufacturer's specifications or user's manual.

3.2 Description of Test Modes

FOR 5260 ~ 5320MHz

4 channels are provided for 802.11a, 802.11n (20MHz), 802.11ac (20MHz):

Channel	Frequency	Channel	Frequency
52	5260 MHz	60	5300 MHz
56	5280 MHz	64	5320 MHz

2 channels are provided for 802.11n (40MHz), 802.11ac (40MHz):

Channel	Frequency	Channel	Frequency
54	5270 MHz	62	5310 MHz

1 channel is provided for 802.11ac (80MHz):

Channel	Frequency
58	5290MHz

FOR 5500 ~ 5700MHz

11 channels are provided for 802.11a, 802.11n (20MHz), 802.11ac (20MHz):

Channel	Frequency	Channel	Frequency
100	5500 MHz	124	5620 MHz
104	5520 MHz	128	5640 MHz
108	5540 MHz	132	5660 MHz
112	5560 MHz	136	5680 MHz
116	5580 MHz	140	5700 MHz
120	5600 MHz		

5 channels are provided for 802.11n (40MHz), 802.11ac (40MHz):

Channel	Frequency	Channel	Frequency
102	5510 MHz	126	5630 MHz
110	5550 MHz	134	5670 MHz
118	5590 MHz		

2 channels are provided for 802.11ac (80MHz):

Channel	Frequency	Channel	Frequency
106	5530MHz	122	5610 MHz

3.2.1 Test Mode Applicability and Tested Channel Detail

EUT Configure Mode	Applicable To				Description
	RE \geq 1G	RE<1G	PLC	APCM	
A	√	√	√	√	Powered from Adapter
B	-	-	√	-	Powered from PoE

Where **RE \geq 1G**: Radiated Emission above 1GHz **RE<1G**: Radiated Emission below 1GHz
PLC: Power Line Conducted Emission **APCM**: Antenna Port Conducted Measurement

NOTE:

1. The EUT had been pre-tested on the positioned of each 3 axis. The worst case was found when positioned on **X-plane**.
2. "-" means no effect.

Radiated Emission Test (Above 1GHz):

- Pre-Scan has been conducted to determine the worst-case mode from all possible combinations between available modulations, data rates and antenna ports (if EUT with antenna diversity architecture).
- Following channel(s) was (were) selected for the final test as listed below.

CDD Mode							
EUT Configure Mode	Mode	FREQ. Band (MHz)	Available Channel	Tested Channel	Modulation Technology	Modulation Type	Data Rate (Mbps)
A	802.11a	5260-5320	52 to 64	52, 60, 64	OFDM	BPSK	6
A	802.11ac (20MHz)		52 to 64	52, 60, 64	OFDM	BPSK	6.5
A	802.11ac (40MHz)		54 to 62	54, 62	OFDM	BPSK	13.5
A	802.11ac (80MHz)		58	58	OFDM	BPSK	29.3
A	802.11a	5500-5700	100 to 140	100, 116, 132, 140	OFDM	BPSK	6
A	802.11ac (20MHz)		100 to 140	100, 116, 132, 140	OFDM	BPSK	6.5
A	802.11ac (40MHz)		102 to 134	102, 110, 134	OFDM	BPSK	13.5
A	802.11ac (80MHz)		106 to 122	106, 122	OFDM	BPSK	29.3
Beamforming_NSS1 Mode							
EUT Configure Mode	Mode	FREQ. Band (MHz)	Available Channel	Tested Channel	Modulation Technology	Modulation Type	Data Rate (Mbps)
A	802.11ac (20MHz)	5260-5320	52 to 64	52, 60, 64	OFDM	BPSK	6.5
A	802.11ac (40MHz)		54 to 62	54, 62	OFDM	BPSK	13.5
A	802.11ac (80MHz)		58	58	OFDM	BPSK	29.3
A	802.11ac (20MHz)	5500-5700	100 to 140	100, 116, 132, 140	OFDM	BPSK	6.5
A	802.11ac (40MHz)		102 to 134	102, 110, 134	OFDM	BPSK	13.5
A	802.11ac (80MHz)		106 to 122	106, 122	OFDM	BPSK	29.3

Radiated Emission Test (Below 1GHz):

- Pre-Scan has been conducted to determine the worst-case mode from all possible combinations between available modulations, data rates and antenna ports (if EUT with antenna diversity architecture).
- Following channel(s) was (were) selected for the final test as listed below.

CDD Mode							
EUT Configure Mode	Mode	FREQ. Band (MHz)	Available Channel	Tested Channel	Modulation Technology	Modulation Type	Data Rate (Mbps)
A	802.11a	5260-5320	52 to 64	52	OFDM	BPSK	6
A	802.11a	5500-5700	100 to 140		OFDM	BPSK	6

Power Line Conducted Emission Test:

- Pre-Scan has been conducted to determine the worst-case mode from all possible combinations between available modulations, data rates and antenna ports (if EUT with antenna diversity architecture).
- Following channel(s) was (were) selected for the final test as listed below.

CDD Mode							
EUT Configure Mode	Mode	FREQ. Band (MHz)	Available Channel	Tested Channel	Modulation Technology	Modulation Type	Data Rate (Mbps)
A & B	802.11a	5260-5320	52 to 64	52	OFDM	BPSK	6
A & B	802.11a	5500-5700	100 to 140		OFDM	BPSK	6

Antenna Port Conducted Measurement:

- This item includes all test value of each mode, but only includes spectrum plot of worst value of each mode.
- Pre-Scan has been conducted to determine the worst-case mode from all possible combinations between available modulations, data rates and antenna ports (if EUT with antenna diversity architecture).
- Following channel(s) was (were) selected for the final test as listed below.

CDD Mode							
EUT Configure Mode	Mode	FREQ. Band (MHz)	Available Channel	Tested Channel	Modulation Technology	Modulation Type	Data Rate (Mbps)
A	802.11a	5260-5320	52 to 64	52, 60, 64	OFDM	BPSK	6
A	802.11ac (20MHz)		52 to 64	52, 60, 64	OFDM	BPSK	6.5
A	802.11ac (40MHz)		54 to 62	54, 62	OFDM	BPSK	13.5
A	802.11ac (80MHz)		58	58	OFDM	BPSK	29.3
A	802.11a	5500-5700	100 to 140	100, 116, 132, 140	OFDM	BPSK	6
A	802.11ac (20MHz)		100 to 140	100, 116, 132, 140	OFDM	BPSK	6.5
A	802.11ac (40MHz)		102 to 134	102, 110, 134	OFDM	BPSK	13.5
A	802.11ac (80MHz)		106 to 122	106, 122	OFDM	BPSK	29.3

Test Condition:

Applicable To	EUT Configure Mode	Environmental Conditions	Input Power	Tested By
RE \geq 1G	A	22deg. C, 76%RH	120Vac, 60Hz	James Wei
RE<1G	A	23deg. C, 74%RH	120Vac, 60Hz	James Wei
PLC	A	25deg. C, 78%RH	120Vac, 60Hz	StarItaly Wu
	B	25deg. C, 75%RH	120Vac, 60Hz	StarItaly Wu
APCM	A	25deg. C, 76%RH	120Vac, 60Hz	Saxon Lee

3.3 Duty Cycle of Test Signal

If duty cycle of test signal is $\geq 98\%$, duty factor is not required.

If duty cycle of test signal is $< 98\%$, duty factor shall be considered.

802.11a: Duty cycle = $2.019/2.088 = 0.967$, Duty factor = $10 * \log(1/0.967) = 0.15$

802.11ac (20MHz): Duty cycle = $4.949/5.017 = 0.986$

802.11ac (40MHz): Duty cycle = $2.37/2.47 = 0.960$, Duty factor = $10 * \log(1/0.960) = 0.18$

802.11ac (80MHz): Duty cycle = $1.089/1.200 = 0.908$, Duty factor = $10 * \log(1/0.908) = 0.42$

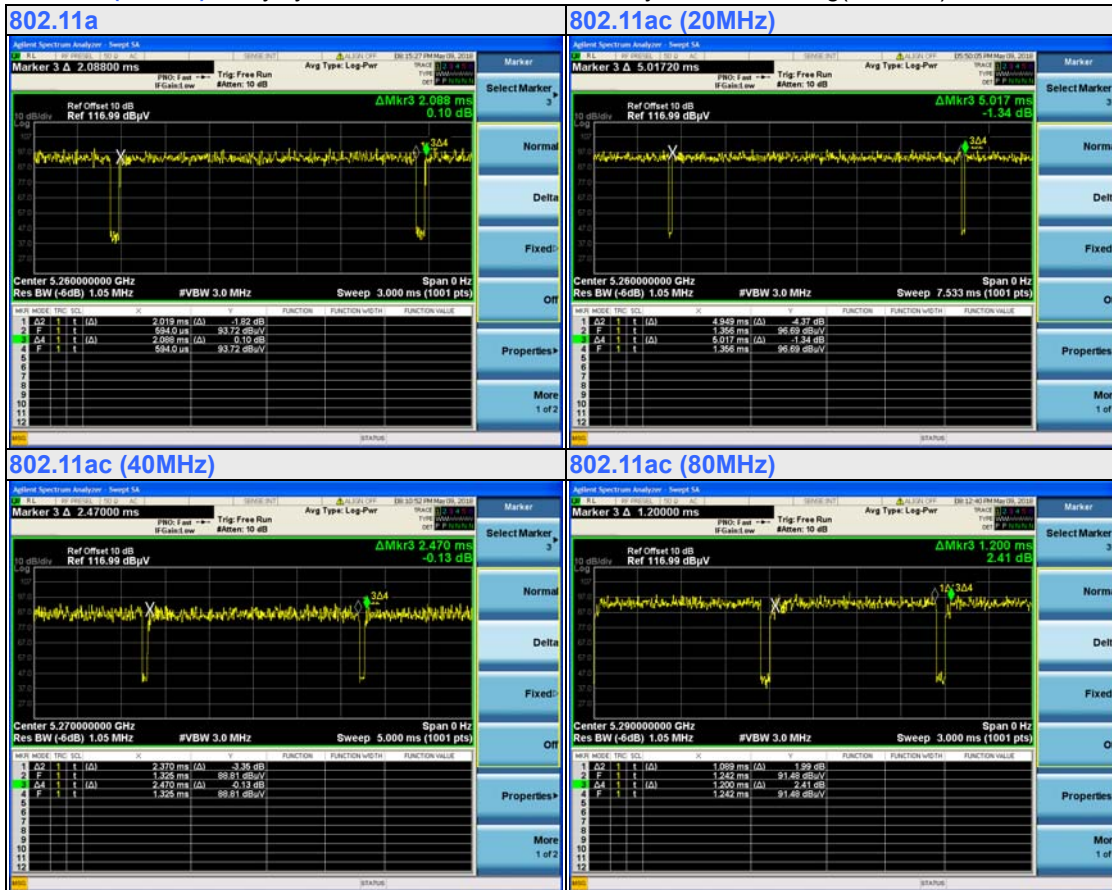

3.4 Description of Support Units

The EUT has been tested as an independent unit together with other necessary accessories or support units. The following support units or accessories were used to form a representative test configuration during the tests.

ID	Product	Brand	Model No.	Serial No.	FCC ID	Remarks
A.	Adapter	DELTA	ADP-30HR B	N/A	N/A	Supplied by client
B.	Notebook PC	DELL	PP27L	8SNZ12S	FCC DoC Approved	Provided by Lab
C.	PoE Adapter	Microsemi	PD-9001GR/AT/AC	N/A	N/A	Supplied by client

Note:

- All power cords of the above support units are non-shielded (1.8m).
- Item B acted as communication partners to transfer data.

ID	Descriptions	Qty.	Length (m)	Shielding (Yes/No)	Cores (Qty.)	Remarks
1.	DC cable	1	1.5	N	1	Supplied by client
2.	LAN cable	1	10	N	0	Provided by Lab
3.	AC Cable	1	1.8	N	0	Provided by Lab
4.	LAN cable	1	1.5	N	0	Provided by Lab
5.	AC Cable	1	1.8	N	0	Provided by Lab

Note: The core(s) is(are) originally attached to the cable(s).

3.4.1 Configuration of System under Test

For Mode A:

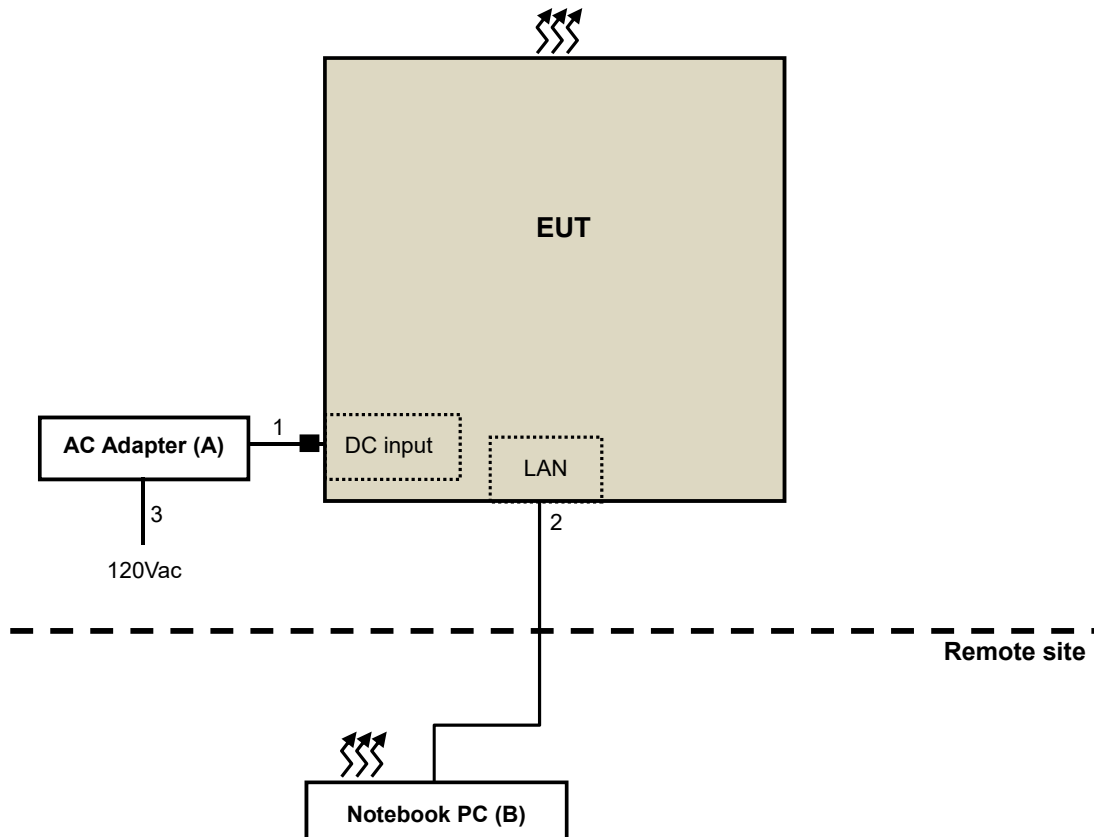

For Mode B:

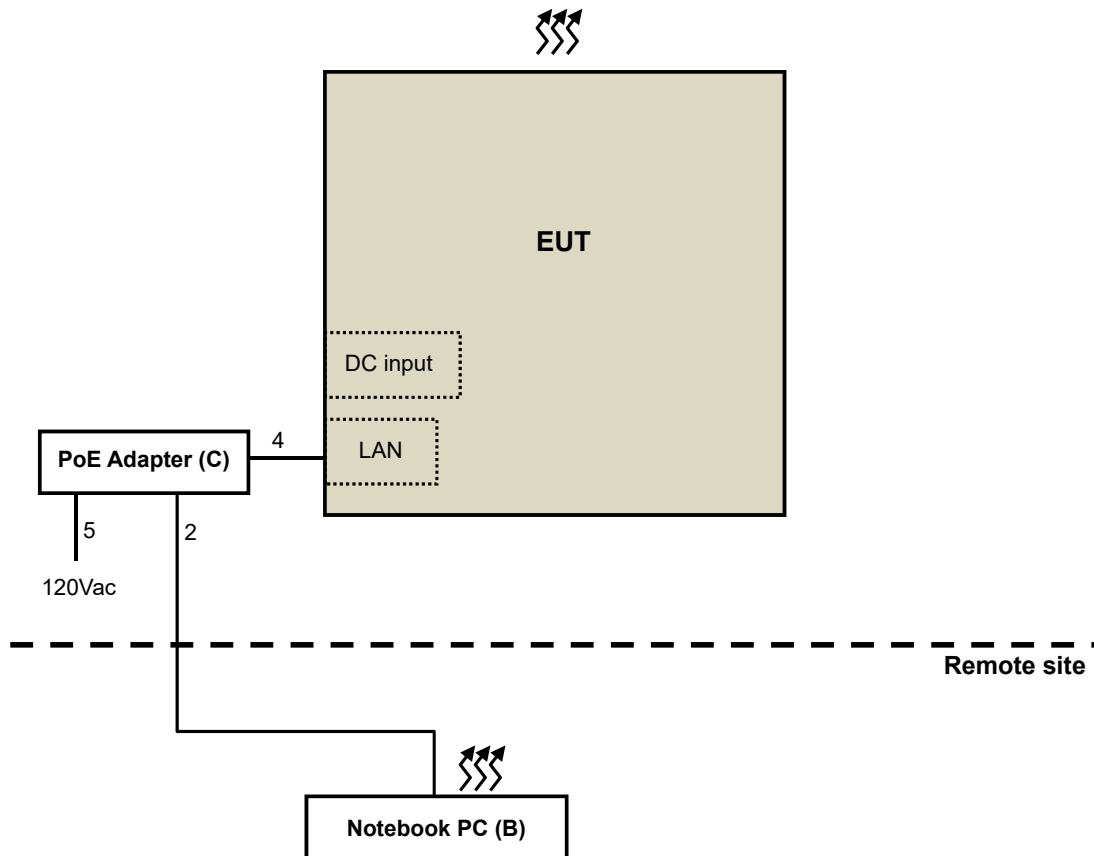

3.5 General Description of Applied Standard

The EUT is a RF Product. According to the specifications of the manufacturer, it must comply with the requirements of the following standards:

FCC Part 15, Subpart E (15.407)
KDB 789033 D02 General UNII Test Procedure New Rules v02r01
KDB 662911 D01 Multiple Transmitter Output v02r01
ANSI C63.10-2013

All test items have been performed and recorded as per the above standards.

4 Test Types and Results

4.1 Radiated Emission and Bandedge Measurement

4.1.1 Limits of Radiated Emission and Bandedge Measurement

Radiated emissions which fall in the restricted bands must comply with the radiated emission limits specified as below table.

Frequencies (MHz)	Field Strength (microvolts/meter)	Measurement Distance (meters)
0.009 ~ 0.490	2400/F(kHz)	300
0.490 ~ 1.705	24000/F(kHz)	30
1.705 ~ 30.0	30	30
30 ~ 88	100	3
88 ~ 216	150	3
216 ~ 960	200	3
Above 960	500	3

NOTE:

- The lower limit shall apply at the transition frequencies.
- Emission level (dBuV/m) = 20 log Emission level (uV/m).
- For frequencies above 1000MHz, the field strength limits are based on average detector, however, the peak field strength of any emission shall not exceed the maximum permitted average limits, specified above by more than 20dB under any condition of modulation.

Limits of unwanted emission out of the restricted bands

Applicable To		Limit	
789033 D02 General UNII Test Procedure New Rules v02r01		Field Strength at 3m	
		PK:74 (dBuV/m)	AV:54 (dBuV/m)
Frequency Band	Applicable To	EIRP Limit	Equivalent Field Strength at 3m
5150~5250 MHz	15.407(b)(1)	PK:-27 (dBm/MHz)	PK:68.2(dBuV/m)
5250~5350 MHz	15.407(b)(2)		
5470~5725 MHz	15.407(b)(3)		
5725~5850 MHz	<input type="checkbox"/> 15.407(b)(4)(i)	PK:-27 (dBm/MHz) ^{*1} PK:10 (dBm/MHz) ^{*2} PK:15.6 (dBm/MHz) ^{*3} PK:27 (dBm/MHz) ^{*4}	PK: 68.2(dBuV/m) ^{*1} PK:105.2 (dBuV/m) ^{*2} PK: 110.8(dBuV/m) ^{*3} PK:122.2 (dBuV/m) ^{*4}
	<input type="checkbox"/> 15.407(b)(4)(ii)	Emission limits in section 15.247(d)	
^{*1} beyond 75 MHz or more above of the band edge.		^{*2} below the band edge increasing linearly to 10 dBm/MHz at 25 MHz above.	
^{*3} below the band edge increasing linearly to a level of 15.6 dBm/MHz at 5 MHz above.		^{*4} from 5 MHz above or below the band edge increasing linearly to a level of 27 dBm/MHz at the band edge.	

Note:

The following formula is used to convert the equipment isotropic radiated power (eirp) to field strength:

$$E = \frac{1000000\sqrt{30P}}{3} \mu\text{V/m, where P is the eirp (Watts).}$$

4.1.2 Test Instruments

DESCRIPTION & MANUFACTURER	MODEL NO.	SERIAL NO.	CALIBRATED DATE	CALIBRATED UNTIL
HP Preamplifier	8447D	2432A03504	Feb. 21, 2018	Feb. 20, 2019
HP Preamplifier	8449B	3008A01201	Feb. 22, 2018	Feb. 21, 2019
MITEQ Preamplifier	AMF-6F-260400-33-8P	892164	Feb. 21, 2018	Feb. 20, 2019
Agilent TEST RECEIVER	N9038A	MY51210129	Feb. 6, 2018	Feb. 5, 2019
Schwarzbeck Antenna	VULB 9168	139	Nov. 29, 2017	Nov. 28, 2018
Schwarzbeck Horn Antenna	BBHA-9170	212	Dec. 1, 2017	Nov. 30, 2018
Schwarzbeck Horn Antenna	BBHA 9120-D1	D130	Dec. 1, 2017	Nov. 30, 2018
ADT. Turn Table	TT100	0306	NA	NA
ADT. Tower	AT100	0306	NA	NA
Software	Radiated_V7.6.15.9.5	NA	NA	NA
SUHNER RF cable With 4dB PAD	SF104	CABLE-CH6	Aug. 14, 2017	Aug. 13, 2018
SUHNER RF cable With 3dB PAD	SF102	Cable-CH8-3.6m	Aug. 14, 2017	Aug. 13, 2018
KEYSIGHT Spectrum Analyzer	N9030A	MY54490260	Jul. 26, 2017	Jul. 25, 2018
Loop Antenna EMCI	LPA600	270	Aug. 11, 2017	Aug. 10, 2019
EMCO Horn Antenna	3115	00028257	Nov. 30, 2017	Nov. 29, 2018
Highpass filter Wainwright Instruments	WHK 3.1/18G-10SS	SN 8	NA	NA
ROHDE & SCHWARZ Spectrum Analyzer	FSV40	101042	Sep. 29, 2017	Sep. 28, 2018
Anritsu Power Sensor	MA2411B	0738404	Apr. 26, 2018	Apr. 25, 2019
Anritsu Power Meter	ML2495A	0842014	Apr. 26, 2018	Apr. 25, 2019
Temperature & Humidity Chamber	MHU-225AU	920409	May 25, 2018	May 24, 2019
DIGITAL POWER METER IDRC	CP-240	240515	Sep. 14, 2017	Sep. 13, 2018
AC Power Source ExTech	CFW-105	E000603	NA	NA

- NOTE:**
1. The calibration interval of the above test instruments is 12/24 months. And the calibrations are traceable to NML/ROC and NIST/USA.
 2. The horn antenna and HP preamplifier (model: 8449B) are used only for the measurement of emission frequency above 1GHz if tested.
 3. The test was performed in Chamber No. 6.
 4. The Industry Canada Reference No. IC 7450E-6.
 5. Tested Date: May 9 ~ Jul. 9, 2018

4.1.3 Test Procedure

For Radiated emission below 30MHz

- a. The EUT was placed on the top of a rotating table 0.8 meters above the ground at a 3 meter chamber room. The table was rotated 360 degrees to determine the position of the highest radiation.
- b. The EUT was set 3 meters away from the interference-receiving antenna, which was mounted on the top of a variable-height antenna tower.
- c. Parallel, perpendicular, and ground-parallel orientations of the antenna are set to make the measurement.
- d. For each suspected emission, the EUT was arranged to its worst case and the rotatable table was turned from 0 degrees to 360 degrees to find the maximum reading.
- e. The test-receiver system was set to Quasi-Peak Detect Function and Specified Bandwidth with Maximum Hold Mode.

NOTE:

1. The resolution bandwidth and video bandwidth of test receiver/spectrum analyzer is 9kHz at frequency below 30MHz.

For Radiated emission above 30MHz

- a. The EUT was placed on the top of a rotating table 0.8 meters (for 30MHz ~ 1GHz) / 1.5 meters (for above 1GHz) above the ground at 3 meter chamber room for test. The table was rotated 360 degrees to determine the position of the highest radiation.
- b. The EUT was set 3 meters away from the interference-receiving antenna, which was mounted on the top of a variable-height antenna tower.
- c. The height of antenna is varied from one meter to four meters above the ground to determine the maximum value of the field strength. Both horizontal and vertical polarizations of the antenna are set to make the measurement.
- d. For each suspected emission, the EUT was arranged to its worst case and then the antenna was tuned to heights from 1 meter to 4 meters and the rotatable table was turned from 0 degrees to 360 degrees to find the maximum reading.
- e. The test-receiver system was set to quasi-peak detect function and specified bandwidth with maximum hold mode when the test frequency is below 1 GHz.
- f. The test-receiver system was set to peak and average detects function and specified bandwidth with maximum hold mode when the test frequency is above 1 GHz. If the peak reading value also meets average limit, measurement with the average detector is unnecessary.

Note:

1. The resolution bandwidth and video bandwidth of test receiver/spectrum analyzer is 120kHz for Quasi-peak detection (QP) at frequency below 1GHz.
2. The resolution bandwidth of test receiver/spectrum analyzer is 1 MHz and the video bandwidth is 3 MHz for Peak detection (PK) at frequency above 1GHz.
3. The resolution bandwidth of test receiver/spectrum analyzer is 1MHz and the video bandwidth is $\geq 1/T$ (Duty cycle < 98%) or 10Hz (Duty cycle $\geq 98\%$) for Average detection (AV) at frequency above 1GHz.
4. All modes of operation were investigated and the worst-case emissions are reported.

4.1.4 Deviation from Test Standard

No deviation.

4.1.5 Test Setup

For Radiated emission below 30MHz

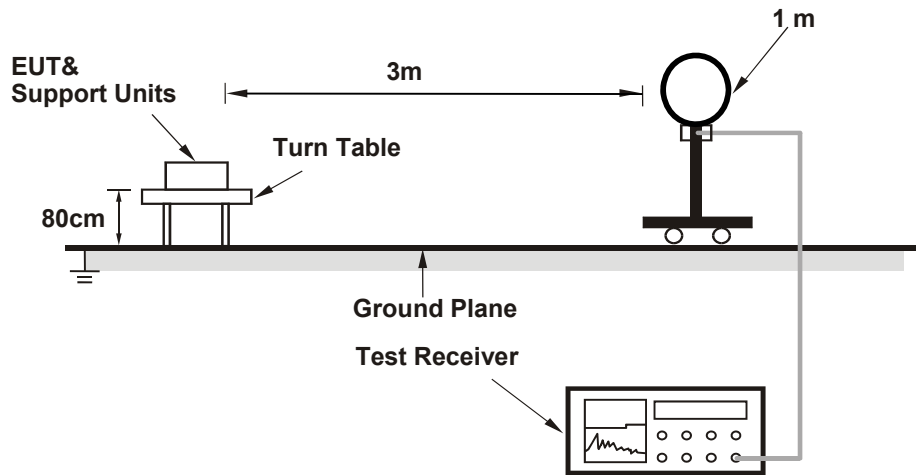

For Radiated emission 30MHz to 1GHz

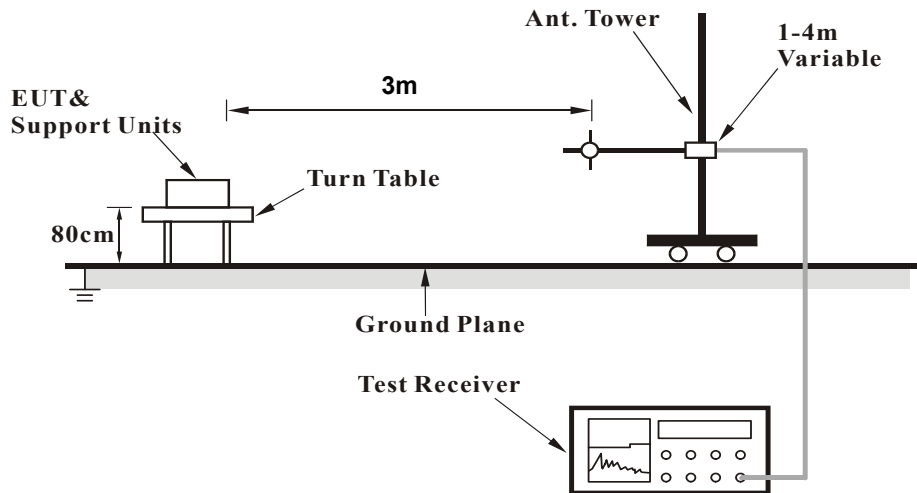

For Radiated emission above 1GHz

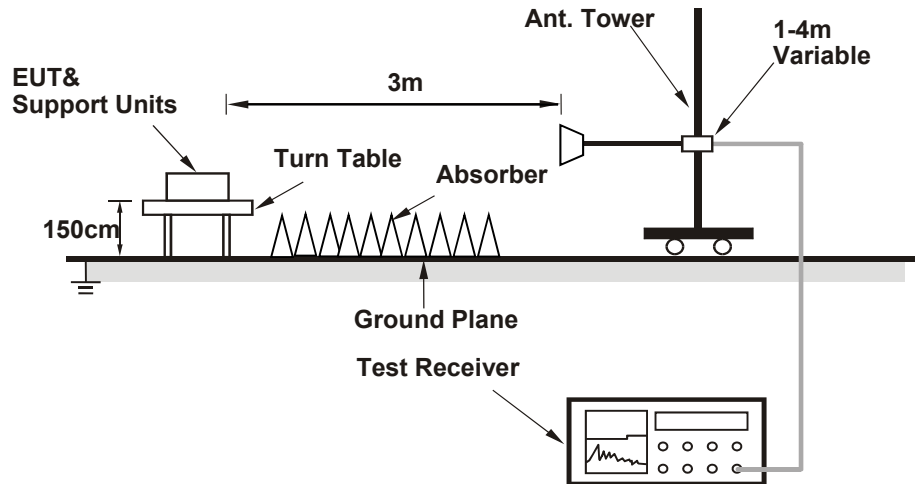

For the actual test configuration, please refer to the attached file (Test Setup Photo).

4.1.6 EUT Operating Condition

- a. Connected the EUT with AC adapter placed on testing table.
- b. Set the EUT under transmission condition continuously at specific channel frequency.

4.1.7 Test Results

Above 1GHz Data:

CDD Mode (Mode A)

802.11a

CHANNEL	TX Channel 52	DETECTOR FUNCTION	Peak (PK)
FREQUENCY RANGE	30MHz ~ 1GHz		Average (AV)

ANTENNA POLARITY & TEST DISTANCE: HORIZONTAL AT 3 M								
NO.	FREQ. (MHz)	EMISSION LEVEL (dBuV/m)	LIMIT (dBuV/m)	MARGIN (dB)	ANTENNA HEIGHT (m)	TABLE ANGLE (Degree)	RAW VALUE (dBuV)	CORRECTION FACTOR (dB/m)
1	5150.00	56.73 PK	74.00	-17.27	2.83 H	73	53.07	3.66
2	5150.00	42.99 AV	54.00	-11.01	2.83 H	73	39.33	3.66
3	*5260.00	114.95 PK			2.83 H	73	112.04	2.91
4	*5260.00	103.78 AV			2.83 H	73	100.87	2.91
5	#10520.00	59.53 PK	74.00	-14.47	1.26 H	335	43.89	15.64
6	#10520.00	44.59 AV	54.00	-9.41	1.26 H	335	28.95	15.64
ANTENNA POLARITY & TEST DISTANCE: VERTICAL AT 3 M								
NO.	FREQ. (MHz)	EMISSION LEVEL (dBuV/m)	LIMIT (dBuV/m)	MARGIN (dB)	ANTENNA HEIGHT (m)	TABLE ANGLE (Degree)	RAW VALUE (dBuV)	CORRECTION FACTOR (dB/m)
1	5150.00	55.55 PK	74.00	-18.45	1.18 V	134	51.89	3.66
2	5150.00	40.89 AV	54.00	-13.11	1.18 V	134	37.23	3.66
3	*5260.00	114.06 PK			1.18 V	134	111.15	2.91
4	*5260.00	102.63 AV			1.18 V	134	99.72	2.91
5	#10520.00	57.57 PK	74.00	-16.43	1.66 V	241	41.93	15.64
6	#10520.00	43.48 AV	54.00	-10.52	1.66 V	241	27.84	15.64

REMARKS:

1. Emission Level(dBuV/m) = Raw Value(dBuV) + Correction Factor(dB/m)
2. Correction Factor(dB/m) = Antenna Factor(dB/m) + Cable Factor(dB) – Pre-Amplifier Factor(dB)
3. The other emission levels were very low against the limit.
4. Margin value = Emission Level – Limit value
5. " * ": Fundamental frequency.
6. " # ": The radiated frequency is out of the restricted band.

CHANNEL	TX Channel 60	DETECTOR FUNCTION	Peak (PK)
FREQUENCY RANGE	30MHz ~ 1GHz		Average (AV)

ANTENNA POLARITY & TEST DISTANCE: HORIZONTAL AT 3 M								
NO.	FREQ. (MHz)	EMISSION LEVEL (dBuV/m)	LIMIT (dBuV/m)	MARGIN (dB)	ANTENNA HEIGHT (m)	TABLE ANGLE (Degree)	RAW VALUE (dBuV)	CORRECTION FACTOR (dB/m)
1	*5300.00	114.70 PK			2.05 H	82	111.93	2.77
2	*5300.00	103.35 AV			2.05 H	82	100.58	2.77
3	5350.00	65.55 PK	74.00	-8.45	2.05 H	82	62.63	2.92
4	5350.00	49.55 AV	54.00	-4.45	2.05 H	82	46.63	2.92
5	10600.00	59.07 PK	74.00	-14.93	1.61 H	304	43.51	15.56
6	10600.00	44.20 AV	54.00	-9.80	1.61 H	304	28.64	15.56
ANTENNA POLARITY & TEST DISTANCE: VERTICAL AT 3 M								
NO.	FREQ. (MHz)	EMISSION LEVEL (dBuV/m)	LIMIT (dBuV/m)	MARGIN (dB)	ANTENNA HEIGHT (m)	TABLE ANGLE (Degree)	RAW VALUE (dBuV)	CORRECTION FACTOR (dB/m)
1	*5300.00	113.35 PK			1.37 V	199	110.58	2.77
2	*5300.00	102.04 AV			1.37 V	199	99.27	2.77
3	5350.00	63.35 PK	74.00	-10.65	1.37 V	199	60.43	2.92
4	5350.00	48.05 AV	54.00	-5.95	1.37 V	199	45.13	2.92
5	10600.00	57.22 PK	74.00	-16.78	1.59 V	231	41.66	15.56
6	10600.00	43.07 AV	54.00	-10.93	1.59 V	231	27.51	15.56

REMARKS:

1. Emission Level(dBuV/m) = Raw Value(dBuV) + Correction Factor(dB/m)
2. Correction Factor(dB/m) = Antenna Factor(dB/m) + Cable Factor(dB) – Pre-Amplifier Factor(dB)
3. The other emission levels were very low against the limit.
4. Margin value = Emission Level – Limit value
5. " * " : Fundamental frequency.

CHANNEL	TX Channel 64	DETECTOR FUNCTION	Peak (PK)
FREQUENCY RANGE	30MHz ~ 1GHz		Average (AV)

ANTENNA POLARITY & TEST DISTANCE: HORIZONTAL AT 3 M								
NO.	FREQ. (MHz)	EMISSION LEVEL (dBuV/m)	LIMIT (dBuV/m)	MARGIN (dB)	ANTENNA HEIGHT (m)	TABLE ANGLE (Degree)	RAW VALUE (dBuV)	CORRECTION FACTOR (dB/m)
1	*5320.00	113.57 PK			1.28 H	75	110.75	2.82
2	*5320.00	102.69 AV			1.28 H	75	99.87	2.82
3	5350.00	67.44 PK	74.00	-6.56	1.28 H	75	64.52	2.92
4	5350.00	52.86 AV	54.00	-1.14	1.28 H	75	49.94	2.92
5	10640.00	59.04 PK	74.00	-14.96	1.33 H	205	43.58	15.46
6	10640.00	44.14 AV	54.00	-9.86	1.33 H	205	28.68	15.46
ANTENNA POLARITY & TEST DISTANCE: VERTICAL AT 3 M								
NO.	FREQ. (MHz)	EMISSION LEVEL (dBuV/m)	LIMIT (dBuV/m)	MARGIN (dB)	ANTENNA HEIGHT (m)	TABLE ANGLE (Degree)	RAW VALUE (dBuV)	CORRECTION FACTOR (dB/m)
1	*5320.00	112.31 PK			1.34 V	201	109.49	2.82
2	*5320.00	101.53 AV			1.34 V	201	98.71	2.82
3	5350.00	65.14 PK	74.00	-8.86	1.34 V	201	62.22	2.92
4	5350.00	50.35 AV	54.00	-3.65	1.34 V	201	47.43	2.92
5	10640.00	57.08 PK	74.00	-16.92	1.77 V	189	41.62	15.46
6	10640.00	42.94 AV	54.00	-11.06	1.77 V	189	27.48	15.46

REMARKS:

1. Emission Level(dBuV/m) = Raw Value(dBuV) + Correction Factor(dB/m)
2. Correction Factor(dB/m) = Antenna Factor(dB/m) + Cable Factor(dB) – Pre-Amplifier Factor(dB)
3. The other emission levels were very low against the limit.
4. Margin value = Emission Level – Limit value
5. " * " : Fundamental frequency.

CHANNEL	TX Channel 100	DETECTOR FUNCTION	Peak (PK)
FREQUENCY RANGE	30MHz ~ 1GHz		Average (AV)

ANTENNA POLARITY & TEST DISTANCE: HORIZONTAL AT 3 M								
NO.	FREQ. (MHz)	EMISSION LEVEL (dBuV/m)	LIMIT (dBuV/m)	MARGIN (dB)	ANTENNA HEIGHT (m)	TABLE ANGLE (Degree)	RAW VALUE (dBuV)	CORRECTION FACTOR (dB/m)
1	5460.00	56.63 PK	74.00	-17.37	1.27 H	80	53.37	3.26
2	5460.00	44.17 AV	54.00	-9.83	1.27 H	80	40.91	3.26
3	5470.00	67.13 PK	68.20	-1.07	1.27 H	80	63.87	3.26
4	*5500.00	112.65 PK			1.27 H	80	109.42	3.23
5	*5500.00	101.42 AV			1.27 H	80	98.19	3.23
6	11000.00	59.05 PK	74.00	-14.95	1.62 H	303	43.17	15.88
7	11000.00	43.99 AV	54.00	-10.01	1.62 H	303	28.11	15.88
ANTENNA POLARITY & TEST DISTANCE: VERTICAL AT 3 M								
NO.	FREQ. (MHz)	EMISSION LEVEL (dBuV/m)	LIMIT (dBuV/m)	MARGIN (dB)	ANTENNA HEIGHT (m)	TABLE ANGLE (Degree)	RAW VALUE (dBuV)	CORRECTION FACTOR (dB/m)
1	5460.00	55.04 PK	74.00	-18.96	1.27 V	80	51.78	3.26
2	5460.00	42.68 AV	54.00	-11.32	1.27 V	80	39.42	3.26
3	5470.00	63.74 PK	68.20	-4.46	1.27 V	80	60.48	3.26
4	*5500.00	111.50 PK			1.27 V	80	108.27	3.23
5	*5500.00	99.76 AV			1.27 V	80	96.53	3.23
6	11000.00	56.91 PK	74.00	-17.09	1.62 V	303	41.03	15.88
7	11000.00	42.79 AV	54.00	-11.21	1.62 V	303	26.91	15.88

REMARKS:

1. Emission Level(dBuV/m) = Raw Value(dBuV) + Correction Factor(dB/m)
2. Correction Factor(dB/m) = Antenna Factor(dB/m) + Cable Factor(dB) – Pre-Amplifier Factor(dB)
3. The other emission levels were very low against the limit.
4. Margin value = Emission Level – Limit value
5. " * " : Fundamental frequency.
6. " # " : The radiated frequency is out of the restricted band.

CHANNEL	TX Channel 116	DETECTOR FUNCTION	Peak (PK)
FREQUENCY RANGE	30MHz ~ 1GHz		Average (AV)

ANTENNA POLARITY & TEST DISTANCE: HORIZONTAL AT 3 M								
NO.	FREQ. (MHz)	EMISSION LEVEL (dBuV/m)	LIMIT (dBuV/m)	MARGIN (dB)	ANTENNA HEIGHT (m)	TABLE ANGLE (Degree)	RAW VALUE (dBuV)	CORRECTION FACTOR (dB/m)
1	*5580.00	117.14 PK			3.06 H	90	113.59	3.55
2	*5580.00	105.27 AV			3.06 H	90	101.72	3.55
3	11160.00	59.85 PK	74.00	-14.15	1.82 H	257	43.59	16.26
4	11160.00	44.92 AV	54.00	-9.08	1.82 H	257	28.66	16.26
ANTENNA POLARITY & TEST DISTANCE: VERTICAL AT 3 M								
NO.	FREQ. (MHz)	EMISSION LEVEL (dBuV/m)	LIMIT (dBuV/m)	MARGIN (dB)	ANTENNA HEIGHT (m)	TABLE ANGLE (Degree)	RAW VALUE (dBuV)	CORRECTION FACTOR (dB/m)
1	*5580.00	115.67 PK			1.33 V	69	112.12	3.55
2	*5580.00	103.68 AV			1.33 V	69	100.13	3.55
3	11160.00	57.84 PK	74.00	-16.16	1.52 V	284	41.58	16.26
4	11160.00	43.65 AV	54.00	-10.35	1.52 V	284	27.39	16.26

REMARKS:

1. Emission Level(dBuV/m) = Raw Value(dBuV) + Correction Factor(dB/m)
2. Correction Factor(dB/m) = Antenna Factor(dB/m) + Cable Factor(dB) – Pre-Amplifier Factor(dB)
3. The other emission levels were very low against the limit.
4. Margin value = Emission Level – Limit value
5. " * " : Fundamental frequency.

CHANNEL	TX Channel 132	DETECTOR FUNCTION	Peak (PK)
FREQUENCY RANGE	30MHz ~ 1GHz		Average (AV)

ANTENNA POLARITY & TEST DISTANCE: HORIZONTAL AT 3 M								
NO.	FREQ. (MHz)	EMISSION LEVEL (dBuV/m)	LIMIT (dBuV/m)	MARGIN (dB)	ANTENNA HEIGHT (m)	TABLE ANGLE (Degree)	RAW VALUE (dBuV)	CORRECTION FACTOR (dB/m)
1	*5660.00	115.48 PK			2.61 H	87	111.61	3.87
2	*5660.00	104.06 AV			2.61 H	87	100.19	3.87
3	11320.00	59.32 PK	74.00	-14.68	1.52 H	331	43.41	15.91
4	11320.00	44.44 AV	54.00	-9.56	1.52 H	331	28.53	15.91

ANTENNA POLARITY & TEST DISTANCE: VERTICAL AT 3 M								
NO.	FREQ. (MHz)	EMISSION LEVEL (dBuV/m)	LIMIT (dBuV/m)	MARGIN (dB)	ANTENNA HEIGHT (m)	TABLE ANGLE (Degree)	RAW VALUE (dBuV)	CORRECTION FACTOR (dB/m)
1	*5660.00	114.36 PK			1.24 V	71	110.49	3.87
2	*5660.00	102.42 AV			1.24 V	71	98.55	3.87
3	11320.00	57.23 PK	74.00	-16.77	1.65 V	288	41.32	15.91
4	11320.00	43.12 AV	54.00	-10.88	1.65 V	288	27.21	15.91

REMARKS:

1. Emission Level(dBuV/m) = Raw Value(dBuV) + Correction Factor(dB/m)
2. Correction Factor(dB/m) = Antenna Factor(dB/m) + Cable Factor(dB) – Pre-Amplifier Factor(dB)
3. The other emission levels were very low against the limit.
4. Margin value = Emission Level – Limit value
5. " * ": Fundamental frequency.

CHANNEL	TX Channel 140	DETECTOR FUNCTION	Peak (PK)
FREQUENCY RANGE	30MHz ~ 1GHz		Average (AV)

ANTENNA POLARITY & TEST DISTANCE: HORIZONTAL AT 3 M								
NO.	FREQ. (MHz)	EMISSION LEVEL (dBuV/m)	LIMIT (dBuV/m)	MARGIN (dB)	ANTENNA HEIGHT (m)	TABLE ANGLE (Degree)	RAW VALUE (dBuV)	CORRECTION FACTOR (dB/m)
1	*5700.00	112.63 PK			2.50 H	89	108.51	4.12
2	*5700.00	101.29 AV			2.50 H	89	97.17	4.12
3	#5725.00	68.50 PK	74.00	-5.50	2.50 H	89	64.20	4.30
4	#5725.00	52.86 AV	54.00	-1.14	2.50 H	89	48.56	4.30
5	11400.00	59.14 PK	74.00	-14.86	1.77 H	251	42.89	16.25
6	11400.00	44.13 AV	54.00	-9.87	1.77 H	251	27.88	16.25
ANTENNA POLARITY & TEST DISTANCE: VERTICAL AT 3 M								
NO.	FREQ. (MHz)	EMISSION LEVEL (dBuV/m)	LIMIT (dBuV/m)	MARGIN (dB)	ANTENNA HEIGHT (m)	TABLE ANGLE (Degree)	RAW VALUE (dBuV)	CORRECTION FACTOR (dB/m)
1	*5700.00	111.47 PK			1.54 V	88	107.35	4.12
2	*5700.00	99.78 AV			1.54 V	88	95.66	4.12
3	#5725.00	66.57 PK	74.00	-7.43	1.54 V	88	62.27	4.30
4	#5725.00	51.13 AV	54.00	-2.87	1.54 V	88	46.83	4.30
5	11400.00	57.01 PK	74.00	-16.99	1.84 V	246	40.76	16.25
6	11400.00	42.93 AV	54.00	-11.07	1.84 V	246	26.68	16.25

REMARKS:

1. Emission Level(dBuV/m) = Raw Value(dBuV) + Correction Factor(dB/m)
2. Correction Factor(dB/m) = Antenna Factor(dB/m) + Cable Factor(dB) – Pre-Amplifier Factor(dB)
3. The other emission levels were very low against the limit.
4. Margin value = Emission Level – Limit value
5. " * ": Fundamental frequency.
6. " # ": The radiated frequency is out of the restricted band.

802.11ac (20MHz)

CHANNEL	TX Channel 52	DETECTOR FUNCTION	Peak (PK)
FREQUENCY RANGE	30MHz ~ 1GHz		Average (AV)

ANTENNA POLARITY & TEST DISTANCE: HORIZONTAL AT 3 M								
NO.	FREQ. (MHz)	EMISSION LEVEL (dBuV/m)	LIMIT (dBuV/m)	MARGIN (dB)	ANTENNA HEIGHT (m)	TABLE ANGLE (Degree)	RAW VALUE (dBuV)	CORRECTION FACTOR (dB/m)
1	5150.00	56.01 PK	74.00	-17.99	1.51 H	75	52.35	3.66
2	5150.00	41.68 AV	54.00	-12.32	1.51 H	75	38.02	3.66
3	*5260.00	115.71 PK			1.51 H	75	112.80	2.91
4	*5260.00	103.33 AV			1.51 H	75	100.42	2.91
5	#10520.00	59.95 PK	74.00	-14.05	1.38 H	322	44.31	15.64
6	#10520.00	44.23 AV	54.00	-9.77	1.38 H	322	28.59	15.64
ANTENNA POLARITY & TEST DISTANCE: VERTICAL AT 3 M								
NO.	FREQ. (MHz)	EMISSION LEVEL (dBuV/m)	LIMIT (dBuV/m)	MARGIN (dB)	ANTENNA HEIGHT (m)	TABLE ANGLE (Degree)	RAW VALUE (dBuV)	CORRECTION FACTOR (dB/m)
1	5150.00	53.94 PK	74.00	-20.06	1.00 V	122	50.28	3.66
2	5150.00	40.25 AV	54.00	-13.75	1.00 V	122	36.59	3.66
3	*5260.00	114.35 PK			1.00 V	122	111.44	2.91
4	*5260.00	101.72 AV			1.00 V	122	98.81	2.91
5	#10520.00	57.71 PK	74.00	-16.29	2.71 V	100	42.07	15.64
6	#10520.00	41.86 AV	54.00	-12.14	2.71 V	100	26.22	15.64

REMARKS:

1. Emission Level(dBuV/m) = Raw Value(dBuV) + Correction Factor(dB/m)
2. Correction Factor(dB/m) = Antenna Factor(dB/m) + Cable Factor(dB) – Pre-Amplifier Factor(dB)
3. The other emission levels were very low against the limit.
4. Margin value = Emission Level – Limit value
5. " * ": Fundamental frequency.
6. " # ": The radiated frequency is out of the restricted band.

CHANNEL	TX Channel 60	DETECTOR FUNCTION	Peak (PK)
FREQUENCY RANGE	30MHz ~ 1GHz		Average (AV)

ANTENNA POLARITY & TEST DISTANCE: HORIZONTAL AT 3 M								
NO.	FREQ. (MHz)	EMISSION LEVEL (dBuV/m)	LIMIT (dBuV/m)	MARGIN (dB)	ANTENNA HEIGHT (m)	TABLE ANGLE (Degree)	RAW VALUE (dBuV)	CORRECTION FACTOR (dB/m)
1	*5300.00	114.53 PK			1.58 H	76	111.76	2.77
2	*5300.00	101.75 AV			1.58 H	76	98.98	2.77
3	10600.00	59.74 PK	74.00	-14.26	1.44 H	303	44.18	15.56
4	10600.00	43.99 AV	54.00	-10.01	1.44 H	303	28.43	15.56

ANTENNA POLARITY & TEST DISTANCE: VERTICAL AT 3 M								
NO.	FREQ. (MHz)	EMISSION LEVEL (dBuV/m)	LIMIT (dBuV/m)	MARGIN (dB)	ANTENNA HEIGHT (m)	TABLE ANGLE (Degree)	RAW VALUE (dBuV)	CORRECTION FACTOR (dB/m)
1	*5300.00	113.24 PK			1.00 V	108	110.47	2.77
2	*5300.00	101.19 AV			1.00 V	108	98.42	2.77
3	10600.00	57.44 PK	74.00	-16.56	2.77 V	104	41.88	15.56
4	10600.00	41.63 AV	54.00	-12.37	2.77 V	104	26.07	15.56

REMARKS:

1. Emission Level(dBuV/m) = Raw Value(dBuV) + Correction Factor(dB/m)
2. Correction Factor(dB/m) = Antenna Factor(dB/m) + Cable Factor(dB) – Pre-Amplifier Factor(dB)
3. The other emission levels were very low against the limit.
4. Margin value = Emission Level – Limit value
5. " * ": Fundamental frequency.

CHANNEL	TX Channel 64	DETECTOR FUNCTION	Peak (PK)
FREQUENCY RANGE	30MHz ~ 1GHz		Average (AV)

ANTENNA POLARITY & TEST DISTANCE: HORIZONTAL AT 3 M								
NO.	FREQ. (MHz)	EMISSION LEVEL (dBuV/m)	LIMIT (dBuV/m)	MARGIN (dB)	ANTENNA HEIGHT (m)	TABLE ANGLE (Degree)	RAW VALUE (dBuV)	CORRECTION FACTOR (dB/m)
1	*5320.00	113.76 PK			1.58 H	76	110.94	2.82
2	*5320.00	101.58 AV			1.58 H	76	98.76	2.82
3	5350.00	65.86 PK	74.00	-8.14	1.58 H	76	62.94	2.92
4	5350.00	52.99 AV	54.00	-1.01	1.58 H	76	50.07	2.92
5	10640.00	59.84 PK	74.00	-14.16	1.44 H	308	44.38	15.46
6	10640.00	44.07 AV	54.00	-9.93	1.44 H	308	28.61	15.46
ANTENNA POLARITY & TEST DISTANCE: VERTICAL AT 3 M								
NO.	FREQ. (MHz)	EMISSION LEVEL (dBuV/m)	LIMIT (dBuV/m)	MARGIN (dB)	ANTENNA HEIGHT (m)	TABLE ANGLE (Degree)	RAW VALUE (dBuV)	CORRECTION FACTOR (dB/m)
1	*5320.00	112.51 PK			1.00 V	124	109.69	2.82
2	*5320.00	99.59 AV			1.00 V	124	96.77	2.82
3	5350.00	61.83 PK	74.00	-12.17	1.00 V	124	58.91	2.92
4	5350.00	45.21 AV	54.00	-8.79	1.00 V	124	42.29	2.92
5	10640.00	57.65 PK	74.00	-16.35	2.77 V	102	42.19	15.46
6	10640.00	41.77 AV	54.00	-12.23	2.77 V	102	26.31	15.46

REMARKS:

1. Emission Level(dBuV/m) = Raw Value(dBuV) + Correction Factor(dB/m)
2. Correction Factor(dB/m) = Antenna Factor(dB/m) + Cable Factor(dB) – Pre-Amplifier Factor(dB)
3. The other emission levels were very low against the limit.
4. Margin value = Emission Level – Limit value
5. " * " : Fundamental frequency.

CHANNEL	TX Channel 100	DETECTOR FUNCTION	Peak (PK)
FREQUENCY RANGE	30MHz ~ 1GHz		Average (AV)

ANTENNA POLARITY & TEST DISTANCE: HORIZONTAL AT 3 M								
NO.	FREQ. (MHz)	EMISSION LEVEL (dBuV/m)	LIMIT (dBuV/m)	MARGIN (dB)	ANTENNA HEIGHT (m)	TABLE ANGLE (Degree)	RAW VALUE (dBuV)	CORRECTION FACTOR (dB/m)
1	5460.00	55.85 PK	74.00	-18.15	1.29 H	86	52.59	3.26
2	5460.00	42.71 AV	54.00	-11.29	1.29 H	86	39.45	3.26
3	5470.00	67.08 PK	68.20	-1.12	1.29 H	86	63.82	3.26
4	*5500.00	112.12 PK			1.29 H	86	108.89	3.23
5	*5500.00	99.04 AV			1.29 H	86	95.81	3.23
6	11000.00	59.70 PK	74.00	-14.30	1.67 H	278	43.82	15.88
7	11000.00	43.95 AV	54.00	-10.05	1.67 H	278	28.07	15.88
ANTENNA POLARITY & TEST DISTANCE: VERTICAL AT 3 M								
NO.	FREQ. (MHz)	EMISSION LEVEL (dBuV/m)	LIMIT (dBuV/m)	MARGIN (dB)	ANTENNA HEIGHT (m)	TABLE ANGLE (Degree)	RAW VALUE (dBuV)	CORRECTION FACTOR (dB/m)
1	5460.00	53.26 PK	74.00	-20.74	1.12 V	143	50.00	3.26
2	5460.00	40.48 AV	54.00	-13.52	1.12 V	143	37.22	3.26
3	5470.00	63.44 PK	68.20	-4.76	1.12 V	143	60.18	3.26
4	*5500.00	110.52 PK			1.12 V	143	107.29	3.23
5	*5500.00	97.25 AV			1.12 V	143	94.02	3.23
6	11000.00	57.60 PK	74.00	-16.40	2.84 V	106	41.72	15.88
7	11000.00	41.77 AV	54.00	-12.23	2.84 V	106	25.89	15.88

REMARKS:

1. Emission Level(dBuV/m) = Raw Value(dBuV) + Correction Factor(dB/m)
2. Correction Factor(dB/m) = Antenna Factor(dB/m) + Cable Factor(dB) – Pre-Amplifier Factor(dB)
3. The other emission levels were very low against the limit.
4. Margin value = Emission Level – Limit value
5. " * " : Fundamental frequency.
6. " # " : The radiated frequency is out of the restricted band.

CHANNEL	TX Channel 116	DETECTOR FUNCTION	Peak (PK)
FREQUENCY RANGE	30MHz ~ 1GHz		Average (AV)

ANTENNA POLARITY & TEST DISTANCE: HORIZONTAL AT 3 M								
NO.	FREQ. (MHz)	EMISSION LEVEL (dBuV/m)	LIMIT (dBuV/m)	MARGIN (dB)	ANTENNA HEIGHT (m)	TABLE ANGLE (Degree)	RAW VALUE (dBuV)	CORRECTION FACTOR (dB/m)
1	*5580.00	115.98 PK			2.81 H	80	112.43	3.55
2	*5580.00	103.53 AV			2.81 H	80	99.98	3.55
3	11160.00	60.95 PK	74.00	-13.05	2.07 H	288	44.69	16.26
4	11160.00	45.81 AV	54.00	-8.19	2.07 H	288	29.55	16.26
ANTENNA POLARITY & TEST DISTANCE: VERTICAL AT 3 M								
NO.	FREQ. (MHz)	EMISSION LEVEL (dBuV/m)	LIMIT (dBuV/m)	MARGIN (dB)	ANTENNA HEIGHT (m)	TABLE ANGLE (Degree)	RAW VALUE (dBuV)	CORRECTION FACTOR (dB/m)
1	*5580.00	114.96 PK			2.21 V	144	111.41	3.55
2	*5580.00	102.52 AV			2.21 V	144	98.97	3.55
3	11160.00	58.60 PK	74.00	-15.40	2.44 V	100	42.34	16.26
4	11160.00	42.75 AV	54.00	-11.25	2.44 V	100	26.49	16.26

REMARKS:

1. Emission Level(dBuV/m) = Raw Value(dBuV) + Correction Factor(dB/m)
2. Correction Factor(dB/m) = Antenna Factor(dB/m) + Cable Factor(dB) – Pre-Amplifier Factor(dB)
3. The other emission levels were very low against the limit.
4. Margin value = Emission Level – Limit value
5. " * ": Fundamental frequency.
6. " # ": The radiated frequency is out of the restricted band.

CHANNEL	TX Channel 132	DETECTOR FUNCTION	Peak (PK)
FREQUENCY RANGE	30MHz ~ 1GHz		Average (AV)

ANTENNA POLARITY & TEST DISTANCE: HORIZONTAL AT 3 M								
NO.	FREQ. (MHz)	EMISSION LEVEL (dBuV/m)	LIMIT (dBuV/m)	MARGIN (dB)	ANTENNA HEIGHT (m)	TABLE ANGLE (Degree)	RAW VALUE (dBuV)	CORRECTION FACTOR (dB/m)
1	*5660.00	115.79 PK			2.23 H	84	111.92	3.87
2	*5660.00	102.91 AV			2.23 H	84	99.04	3.87
3	11320.00	60.38 PK	74.00	-13.62	1.55 H	271	44.47	15.91
4	11320.00	45.29 AV	54.00	-8.71	1.55 H	271	29.38	15.91

ANTENNA POLARITY & TEST DISTANCE: VERTICAL AT 3 M								
NO.	FREQ. (MHz)	EMISSION LEVEL (dBuV/m)	LIMIT (dBuV/m)	MARGIN (dB)	ANTENNA HEIGHT (m)	TABLE ANGLE (Degree)	RAW VALUE (dBuV)	CORRECTION FACTOR (dB/m)
1	*5660.00	114.68 PK			2.81 V	153	110.81	3.87
2	*5660.00	101.99 AV			2.81 V	153	98.12	3.87
3	11320.00	58.03 PK	74.00	-15.97	2.74 V	113	42.12	15.91
4	11320.00	42.24 AV	54.00	-11.76	2.74 V	113	26.33	15.91

REMARKS:

1. Emission Level(dBuV/m) = Raw Value(dBuV) + Correction Factor(dB/m)
2. Correction Factor(dB/m) = Antenna Factor(dB/m) + Cable Factor(dB) – Pre-Amplifier Factor(dB)
3. The other emission levels were very low against the limit.
4. Margin value = Emission Level – Limit value
5. " * ": Fundamental frequency.

CHANNEL	TX Channel 140	DETECTOR FUNCTION	Peak (PK)
FREQUENCY RANGE	30MHz ~ 1GHz		Average (AV)

ANTENNA POLARITY & TEST DISTANCE: HORIZONTAL AT 3 M								
NO.	FREQ. (MHz)	EMISSION LEVEL (dBuV/m)	LIMIT (dBuV/m)	MARGIN (dB)	ANTENNA HEIGHT (m)	TABLE ANGLE (Degree)	RAW VALUE (dBuV)	CORRECTION FACTOR (dB/m)
1	*5700.00	113.52 PK			2.60 H	87	109.40	4.12
2	*5700.00	100.62 AV			2.60 H	87	96.50	4.12
3	#5725.00	64.10 PK	74.00	-9.90	2.60 H	87	59.80	4.30
4	#5725.00	52.96 AV	54.00	-1.04	2.60 H	87	48.66	4.30
5	11400.00	60.24 PK	74.00	-13.76	1.88 H	241	43.99	16.25
6	11400.00	44.44 AV	54.00	-9.56	1.88 H	241	28.19	16.25
ANTENNA POLARITY & TEST DISTANCE: VERTICAL AT 3 M								
NO.	FREQ. (MHz)	EMISSION LEVEL (dBuV/m)	LIMIT (dBuV/m)	MARGIN (dB)	ANTENNA HEIGHT (m)	TABLE ANGLE (Degree)	RAW VALUE (dBuV)	CORRECTION FACTOR (dB/m)
1	*5700.00	111.79 PK			2.99 V	142	107.67	4.12
2	*5700.00	98.67 AV			2.99 V	142	94.55	4.12
3	#5725.00	61.57 PK	74.00	-12.43	2.99 V	142	57.27	4.30
4	#5725.00	51.13 AV	54.00	-2.87	2.99 V	142	46.83	4.30
5	11400.00	58.13 PK	74.00	-15.87	2.91 V	103	41.88	16.25
6	11400.00	42.29 AV	54.00	-11.71	2.91 V	103	26.04	16.25

REMARKS:

1. Emission Level(dBuV/m) = Raw Value(dBuV) + Correction Factor(dB/m)
2. Correction Factor(dB/m) = Antenna Factor(dB/m) + Cable Factor(dB) – Pre-Amplifier Factor(dB)
3. The other emission levels were very low against the limit.
4. Margin value = Emission Level – Limit value
5. " * ": Fundamental frequency.
6. " # ": The radiated frequency is out of the restricted band.

802.11ac (40MHz)

CHANNEL	TX Channel 54	DETECTOR FUNCTION	Peak (PK)
FREQUENCY RANGE	30MHz ~ 1GHz		Average (AV)

ANTENNA POLARITY & TEST DISTANCE: HORIZONTAL AT 3 M								
NO.	FREQ. (MHz)	EMISSION LEVEL (dBuV/m)	LIMIT (dBuV/m)	MARGIN (dB)	ANTENNA HEIGHT (m)	TABLE ANGLE (Degree)	RAW VALUE (dBuV)	CORRECTION FACTOR (dB/m)
1	5150.00	60.09 PK	74.00	-13.91	1.68 H	68	56.43	3.66
2	5150.00	46.23 AV	54.00	-7.77	1.68 H	68	42.57	3.66
3	*5270.00	112.35 PK			1.68 H	68	109.47	2.88
4	*5270.00	101.49 AV			1.68 H	68	98.61	2.88
5	#10540.00	58.79 PK	74.00	-15.21	1.93 H	285	43.17	15.62
6	#10540.00	45.05 AV	54.00	-8.95	1.93 H	285	29.43	15.62
ANTENNA POLARITY & TEST DISTANCE: VERTICAL AT 3 M								
NO.	FREQ. (MHz)	EMISSION LEVEL (dBuV/m)	LIMIT (dBuV/m)	MARGIN (dB)	ANTENNA HEIGHT (m)	TABLE ANGLE (Degree)	RAW VALUE (dBuV)	CORRECTION FACTOR (dB/m)
1	5150.00	56.65 PK	74.00	-17.35	1.41 V	105	52.99	3.66
2	5150.00	44.21 AV	54.00	-9.79	1.41 V	105	40.55	3.66
3	*5270.00	110.90 PK			1.41 V	105	108.02	2.88
4	*5270.00	99.46 AV			1.41 V	105	96.58	2.88
5	#10540.00	56.17 PK	74.00	-17.83	1.33 V	243	40.55	15.62
6	#10540.00	44.59 AV	54.00	-9.41	1.33 V	243	28.97	15.62

REMARKS:

1. Emission Level(dBuV/m) = Raw Value(dBuV) + Correction Factor(dB/m)
2. Correction Factor(dB/m) = Antenna Factor(dB/m) + Cable Factor(dB) – Pre-Amplifier Factor(dB)
3. The other emission levels were very low against the limit.
4. Margin value = Emission Level – Limit value
5. " * ": Fundamental frequency.
6. " # ": The radiated frequency is out of the restricted band.

CHANNEL	TX Channel 62	DETECTOR FUNCTION	Peak (PK)
FREQUENCY RANGE	30MHz ~ 1GHz		Average (AV)

ANTENNA POLARITY & TEST DISTANCE: HORIZONTAL AT 3 M								
NO.	FREQ. (MHz)	EMISSION LEVEL (dBuV/m)	LIMIT (dBuV/m)	MARGIN (dB)	ANTENNA HEIGHT (m)	TABLE ANGLE (Degree)	RAW VALUE (dBuV)	CORRECTION FACTOR (dB/m)
1	*5310.00	106.39 PK			1.68 H	84	103.59	2.80
2	*5310.00	95.77 AV			1.68 H	84	92.97	2.80
3	5350.00	63.03 PK	74.00	-10.97	1.68 H	84	60.11	2.92
4	5350.00	52.79 AV	54.00	-1.21	1.68 H	84	49.87	2.92
5	10620.00	57.95 PK	74.00	-16.05	2.02 H	291	42.43	15.52
6	10620.00	44.23 AV	54.00	-9.77	2.02 H	291	28.71	15.52
ANTENNA POLARITY & TEST DISTANCE: VERTICAL AT 3 M								
NO.	FREQ. (MHz)	EMISSION LEVEL (dBuV/m)	LIMIT (dBuV/m)	MARGIN (dB)	ANTENNA HEIGHT (m)	TABLE ANGLE (Degree)	RAW VALUE (dBuV)	CORRECTION FACTOR (dB/m)
1	*5310.00	103.13 PK			1.34 V	91	100.33	2.80
2	*5310.00	92.79 AV			1.34 V	91	89.99	2.80
3	5350.00	64.83 PK	74.00	-9.17	1.34 V	91	61.91	2.92
4	5350.00	51.31 AV	54.00	-2.69	1.34 V	91	48.39	2.92
5	10620.00	55.63 PK	74.00	-18.37	1.22 V	177	40.11	15.52
6	10620.00	43.65 AV	54.00	-10.35	1.22 V	177	28.13	15.52

REMARKS:

1. Emission Level(dBuV/m) = Raw Value(dBuV) + Correction Factor(dB/m)
2. Correction Factor(dB/m) = Antenna Factor(dB/m) + Cable Factor(dB) – Pre-Amplifier Factor(dB)
3. The other emission levels were very low against the limit.
4. Margin value = Emission Level – Limit value
5. " * ": Fundamental frequency.

CHANNEL	TX Channel 102	DETECTOR FUNCTION	Peak (PK)
FREQUENCY RANGE	30MHz ~ 1GHz		Average (AV)

ANTENNA POLARITY & TEST DISTANCE: HORIZONTAL AT 3 M								
NO.	FREQ. (MHz)	EMISSION LEVEL (dBuV/m)	LIMIT (dBuV/m)	MARGIN (dB)	ANTENNA HEIGHT (m)	TABLE ANGLE (Degree)	RAW VALUE (dBuV)	CORRECTION FACTOR (dB/m)
1	5460.00	61.36 PK	74.00	-12.64	1.66 H	81	58.10	3.26
2	5460.00	47.23 AV	54.00	-6.77	1.66 H	81	43.97	3.26
3	5470.00	67.14 PK	68.20	-1.06	1.66 H	81	63.88	3.26
4	*5510.00	107.77 PK			1.66 H	81	104.50	3.27
5	*5510.00	96.51 AV			1.66 H	81	93.24	3.27
6	11020.00	58.23 PK	74.00	-15.77	1.73 H	255	42.23	16.00
7	11020.00	44.77 AV	54.00	-9.23	1.73 H	255	28.77	16.00
ANTENNA POLARITY & TEST DISTANCE: VERTICAL AT 3 M								
NO.	FREQ. (MHz)	EMISSION LEVEL (dBuV/m)	LIMIT (dBuV/m)	MARGIN (dB)	ANTENNA HEIGHT (m)	TABLE ANGLE (Degree)	RAW VALUE (dBuV)	CORRECTION FACTOR (dB/m)
1	5460.00	59.98 PK	74.00	-14.02	1.58 V	94	56.72	3.26
2	5460.00	45.53 AV	54.00	-8.47	1.58 V	94	42.27	3.26
3	5470.00	63.44 PK	68.20	-4.76	1.58 V	94	60.18	3.26
4	*5510.00	105.04 PK			1.58 V	94	101.77	3.27
5	*5510.00	93.78 AV			1.58 V	94	90.51	3.27
6	11020.00	56.03 PK	74.00	-17.97	1.26 V	199	40.03	16.00
7	11020.00	44.41 AV	54.00	-9.59	1.26 V	199	28.41	16.00

REMARKS:

1. Emission Level(dBuV/m) = Raw Value(dBuV) + Correction Factor(dB/m)
2. Correction Factor(dB/m) = Antenna Factor(dB/m) + Cable Factor(dB) – Pre-Amplifier Factor(dB)
3. The other emission levels were very low against the limit.
4. Margin value = Emission Level – Limit value
5. " * ": Fundamental frequency.
6. " # ": The radiated frequency is out of the restricted band.

CHANNEL	TX Channel 110	DETECTOR FUNCTION	Peak (PK)
FREQUENCY RANGE	30MHz ~ 1GHz		Average (AV)

ANTENNA POLARITY & TEST DISTANCE: HORIZONTAL AT 3 M								
NO.	FREQ. (MHz)	EMISSION LEVEL (dBuV/m)	LIMIT (dBuV/m)	MARGIN (dB)	ANTENNA HEIGHT (m)	TABLE ANGLE (Degree)	RAW VALUE (dBuV)	CORRECTION FACTOR (dB/m)
1	*5550.00	112.19 PK			1.49 H	80	108.75	3.44
2	*5550.00	101.50 AV			1.49 H	80	98.06	3.44
3	11100.00	59.55 PK	74.00	-14.45	1.88 H	219	43.11	16.44
4	11100.00	45.83 AV	54.00	-8.17	1.88 H	219	29.39	16.44

ANTENNA POLARITY & TEST DISTANCE: VERTICAL AT 3 M								
NO.	FREQ. (MHz)	EMISSION LEVEL (dBuV/m)	LIMIT (dBuV/m)	MARGIN (dB)	ANTENNA HEIGHT (m)	TABLE ANGLE (Degree)	RAW VALUE (dBuV)	CORRECTION FACTOR (dB/m)
1	*5550.00	109.46 PK			1.61 V	88	106.02	3.44
2	*5550.00	98.26 AV			1.61 V	88	94.82	3.44
3	11100.00	57.02 PK	74.00	-16.98	1.40 V	209	40.58	16.44
4	11100.00	45.23 AV	54.00	-8.77	1.40 V	209	28.79	16.44

REMARKS:

1. Emission Level(dBuV/m) = Raw Value(dBuV) + Correction Factor(dB/m)
2. Correction Factor(dB/m) = Antenna Factor(dB/m) + Cable Factor(dB) – Pre-Amplifier Factor(dB)
3. The other emission levels were very low against the limit.
4. Margin value = Emission Level – Limit value
5. " * ": Fundamental frequency.

CHANNEL	TX Channel 134	DETECTOR FUNCTION	Peak (PK)
FREQUENCY RANGE	30MHz ~ 1GHz		Average (AV)

ANTENNA POLARITY & TEST DISTANCE: HORIZONTAL AT 3 M								
NO.	FREQ. (MHz)	EMISSION LEVEL (dBuV/m)	LIMIT (dBuV/m)	MARGIN (dB)	ANTENNA HEIGHT (m)	TABLE ANGLE (Degree)	RAW VALUE (dBuV)	CORRECTION FACTOR (dB/m)
1	*5670.00	109.59 PK			2.48 H	87	105.66	3.93
2	*5670.00	98.68 AV			2.48 H	87	94.75	3.93
3	#5725.00	67.40 PK	74.00	-6.60	2.48 H	87	63.10	4.30
4	#5725.00	52.96 AV	54.00	-1.04	2.48 H	87	48.66	4.30
5	11340.00	58.57 PK	74.00	-15.43	1.77 H	234	42.58	15.99
6	11340.00	44.92 AV	54.00	-9.08	1.77 H	234	28.93	15.99
ANTENNA POLARITY & TEST DISTANCE: VERTICAL AT 3 M								
NO.	FREQ. (MHz)	EMISSION LEVEL (dBuV/m)	LIMIT (dBuV/m)	MARGIN (dB)	ANTENNA HEIGHT (m)	TABLE ANGLE (Degree)	RAW VALUE (dBuV)	CORRECTION FACTOR (dB/m)
1	*5670.00	106.76 PK			2.21 V	105	102.83	3.93
2	*5670.00	95.59 AV			2.21 V	105	91.66	3.93
3	#5725.00	64.85 PK	74.00	-9.15	2.21 V	105	60.55	4.30
4	#5725.00	50.48 AV	54.00	-3.52	2.21 V	105	46.18	4.30
5	11340.00	56.28 PK	74.00	-17.72	1.39 V	146	40.29	15.99
6	11340.00	44.49 AV	54.00	-9.51	1.39 V	146	28.50	15.99

REMARKS:

1. Emission Level(dBuV/m) = Raw Value(dBuV) + Correction Factor(dB/m)
2. Correction Factor(dB/m) = Antenna Factor(dB/m) + Cable Factor(dB) – Pre-Amplifier Factor(dB)
3. The other emission levels were very low against the limit.
4. Margin value = Emission Level – Limit value
5. " * ": Fundamental frequency.
6. " # ": The radiated frequency is out of the restricted band.

802.11ac (80MHz)

CHANNEL	TX Channel 58	DETECTOR FUNCTION	Peak (PK)
FREQUENCY RANGE	30MHz ~ 1GHz		Average (AV)

ANTENNA POLARITY & TEST DISTANCE: HORIZONTAL AT 3 M								
NO.	FREQ. (MHz)	EMISSION LEVEL (dBuV/m)	LIMIT (dBuV/m)	MARGIN (dB)	ANTENNA HEIGHT (m)	TABLE ANGLE (Degree)	RAW VALUE (dBuV)	CORRECTION FACTOR (dB/m)
1	5150.00	56.68 PK	74.00	-17.32	2.30 H	78	53.02	3.66
2	5150.00	43.15 AV	54.00	-10.85	2.30 H	78	39.49	3.66
3	*5290.00	101.89 PK			2.30 H	78	99.09	2.80
4	*5290.00	92.08 AV			2.30 H	78	89.28	2.80
5	5350.00	66.87 PK	74.00	-7.13	2.30 H	78	63.95	2.92
6	5350.00	52.88 AV	54.00	-1.12	2.30 H	78	49.96	2.92
7	#10580.00	54.02 PK	74.00	-19.98	2.55 H	103	38.44	15.58
8	#10580.00	41.39 AV	54.00	-12.61	2.55 H	103	25.81	15.58

ANTENNA POLARITY & TEST DISTANCE: VERTICAL AT 3 M								
NO.	FREQ. (MHz)	EMISSION LEVEL (dBuV/m)	LIMIT (dBuV/m)	MARGIN (dB)	ANTENNA HEIGHT (m)	TABLE ANGLE (Degree)	RAW VALUE (dBuV)	CORRECTION FACTOR (dB/m)
1	5150.00	56.12 PK	74.00	-17.88	1.11 V	132	52.46	3.66
2	5150.00	42.68 AV	54.00	-11.32	1.11 V	132	39.02	3.66
3	*5290.00	100.75 PK			1.11 V	132	97.95	2.80
4	*5290.00	90.02 AV			1.11 V	132	87.22	2.80
5	5350.00	67.43 PK	74.00	-6.57	1.11 V	132	64.51	2.92
6	5350.00	52.25 AV	54.00	-1.75	1.11 V	132	49.33	2.92
7	#10580.00	52.85 PK	74.00	-21.15	1.03 V	142	37.27	15.58
8	#10580.00	40.76 AV	54.00	-13.24	1.03 V	142	25.18	15.58

REMARKS:

1. Emission Level(dBuV/m) = Raw Value(dBuV) + Correction Factor(dB/m)
2. Correction Factor(dB/m) = Antenna Factor(dB/m) + Cable Factor(dB) – Pre-Amplifier Factor(dB)
3. The other emission levels were very low against the limit.
4. Margin value = Emission Level – Limit value
5. " * ": Fundamental frequency.
6. " # ": The radiated frequency is out of the restricted band.

CHANNEL	TX Channel 106	DETECTOR FUNCTION	Peak (PK)
FREQUENCY RANGE	30MHz ~ 1GHz		Average (AV)

ANTENNA POLARITY & TEST DISTANCE: HORIZONTAL AT 3 M								
NO.	FREQ. (MHz)	EMISSION LEVEL (dBuV/m)	LIMIT (dBuV/m)	MARGIN (dB)	ANTENNA HEIGHT (m)	TABLE ANGLE (Degree)	RAW VALUE (dBuV)	CORRECTION FACTOR (dB/m)
1	5460.00	63.41 PK	74.00	-10.59	1.85 H	86	60.15	3.26
2	5460.00	48.57 AV	54.00	-5.43	1.85 H	86	45.31	3.26
3	5470.00	67.06 PK	68.20	-1.14	1.85 H	86	63.80	3.26
4	*5530.00	101.10 PK			1.85 H	86	97.74	3.36
5	*5530.00	91.08 AV			1.85 H	86	87.72	3.36
6	11060.00	54.52 PK	74.00	-19.48	1.72 H	95	38.31	16.21
7	11060.00	41.82 AV	54.00	-12.18	1.72 H	95	25.61	16.21
ANTENNA POLARITY & TEST DISTANCE: VERTICAL AT 3 M								
NO.	FREQ. (MHz)	EMISSION LEVEL (dBuV/m)	LIMIT (dBuV/m)	MARGIN (dB)	ANTENNA HEIGHT (m)	TABLE ANGLE (Degree)	RAW VALUE (dBuV)	CORRECTION FACTOR (dB/m)
1	5460.00	63.35 PK	74.00	-10.65	1.10 V	110	60.09	3.26
2	5460.00	49.45 AV	54.00	-4.55	1.10 V	110	46.19	3.26
3	5470.00	63.88 PK	68.20	-4.32	1.10 V	110	60.62	3.26
4	*5530.00	99.02 PK			1.10 V	110	95.66	3.36
5	*5530.00	88.23 AV			1.10 V	110	84.87	3.36
6	11060.00	53.74 PK	74.00	-20.26	2.59 V	22	37.53	16.21
7	11060.00	41.43 AV	54.00	-12.57	2.59 V	22	25.22	16.21

REMARKS:

1. Emission Level(dBuV/m) = Raw Value(dBuV) + Correction Factor(dB/m)
2. Correction Factor(dB/m) = Antenna Factor(dB/m) + Cable Factor(dB) – Pre-Amplifier Factor(dB)
3. The other emission levels were very low against the limit.
4. Margin value = Emission Level – Limit value
5. " * ": Fundamental frequency.
6. " # ": The radiated frequency is out of the restricted band.

CHANNEL	TX Channel 122	DETECTOR FUNCTION	Peak (PK)
FREQUENCY RANGE	30MHz ~ 1GHz		Average (AV)

ANTENNA POLARITY & TEST DISTANCE: HORIZONTAL AT 3 M								
NO.	FREQ. (MHz)	EMISSION LEVEL (dBuV/m)	LIMIT (dBuV/m)	MARGIN (dB)	ANTENNA HEIGHT (m)	TABLE ANGLE (Degree)	RAW VALUE (dBuV)	CORRECTION FACTOR (dB/m)
1	*5610.00	106.98 PK			2.30 H	88	103.31	3.67
2	*5610.00	96.61 AV			2.30 H	88	92.94	3.67
3	#5725.00	67.32 PK	74.00	-6.68	2.30 H	88	63.02	4.30
4	#5725.00	52.91 AV	54.00	-1.09	2.30 H	88	48.61	4.30
5	11220.00	55.02 PK	74.00	-18.98	1.88 H	204	38.92	16.10
6	11220.00	42.20 AV	54.00	-11.80	1.88 H	204	26.10	16.10
ANTENNA POLARITY & TEST DISTANCE: VERTICAL AT 3 M								
NO.	FREQ. (MHz)	EMISSION LEVEL (dBuV/m)	LIMIT (dBuV/m)	MARGIN (dB)	ANTENNA HEIGHT (m)	TABLE ANGLE (Degree)	RAW VALUE (dBuV)	CORRECTION FACTOR (dB/m)
1	*5610.00	104.19 PK			1.12 V	103	100.52	3.67
2	*5610.00	93.00 AV			1.12 V	103	89.33	3.67
3	#5725.00	63.91 PK	74.00	-10.09	1.12 V	103	59.61	4.30
4	#5725.00	49.93 AV	54.00	-4.07	1.12 V	103	45.63	4.30
5	11220.00	53.91 PK	74.00	-20.09	2.66 V	39	37.81	16.10
6	11220.00	41.48 AV	54.00	-12.52	2.66 V	39	25.38	16.10

REMARKS:

1. Emission Level(dBuV/m) = Raw Value(dBuV) + Correction Factor(dB/m)
2. Correction Factor(dB/m) = Antenna Factor(dB/m) + Cable Factor(dB) – Pre-Amplifier Factor(dB)
3. The other emission levels were very low against the limit.
4. Margin value = Emission Level – Limit value
5. " * ": Fundamental frequency.
6. " # ": The radiated frequency is out of the restricted band.

Beamforming_NSS1 Mode (Mode A)
802.11ac (20MHz)

CHANNEL	TX Channel 52	DETECTOR FUNCTION	Peak (PK)
FREQUENCY RANGE	30MHz ~ 1GHz		Average (AV)

ANTENNA POLARITY & TEST DISTANCE: HORIZONTAL AT 3 M								
NO.	FREQ. (MHz)	EMISSION LEVEL (dBuV/m)	LIMIT (dBuV/m)	MARGIN (dB)	ANTENNA HEIGHT (m)	TABLE ANGLE (Degree)	RAW VALUE (dBuV)	CORRECTION FACTOR (dB/m)
1	5150.00	57.78 PK	74.00	-16.22	1.04 H	54	54.12	3.66
2	5150.00	43.16 AV	54.00	-10.84	1.04 H	54	39.50	3.66
3	*5260.00	109.69 PK			1.04 H	54	106.78	2.91
4	*5260.00	98.41 AV			1.04 H	54	95.50	2.91
5	#10520.00	58.19 PK	74.00	-15.81	1.77 H	229	42.55	15.64
6	#10520.00	43.11 AV	54.00	-10.89	1.77 H	229	27.47	15.64
ANTENNA POLARITY & TEST DISTANCE: VERTICAL AT 3 M								
NO.	FREQ. (MHz)	EMISSION LEVEL (dBuV/m)	LIMIT (dBuV/m)	MARGIN (dB)	ANTENNA HEIGHT (m)	TABLE ANGLE (Degree)	RAW VALUE (dBuV)	CORRECTION FACTOR (dB/m)
1	5150.00	55.33 PK	74.00	-18.67	2.05 V	174	51.67	3.66
2	5150.00	41.29 AV	54.00	-12.71	2.05 V	174	37.63	3.66
3	*5260.00	107.33 PK			2.05 V	174	104.42	2.91
4	*5260.00	96.62 AV			2.05 V	174	93.71	2.91
5	#10520.00	56.07 PK	74.00	-17.93	2.32 V	81	40.43	15.64
6	#10520.00	41.72 AV	54.00	-12.28	2.32 V	81	26.08	15.64

REMARKS:

- Emission Level(dBuV/m) = Raw Value(dBuV) + Correction Factor(dB/m)
- Correction Factor(dB/m) = Antenna Factor(dB/m) + Cable Factor(dB) – Pre-Amplifier Factor(dB)
- The other emission levels were very low against the limit.
- Margin value = Emission Level – Limit value
- " * ": Fundamental frequency.
- " # ": The radiated frequency is out of the restricted band.

CHANNEL	TX Channel 60	DETECTOR FUNCTION	Peak (PK)
FREQUENCY RANGE	30MHz ~ 1GHz		Average (AV)

ANTENNA POLARITY & TEST DISTANCE: HORIZONTAL AT 3 M								
NO.	FREQ. (MHz)	EMISSION LEVEL (dBuV/m)	LIMIT (dBuV/m)	MARGIN (dB)	ANTENNA HEIGHT (m)	TABLE ANGLE (Degree)	RAW VALUE (dBuV)	CORRECTION FACTOR (dB/m)
1	*5300.00	109.76 PK			1.27 H	211	106.99	2.77
2	*5300.00	98.48 AV			1.27 H	211	95.71	2.77
3	10600.00	58.18 PK	74.00	-15.82	1.82 H	234	42.62	15.56
4	10600.00	43.09 AV	54.00	-10.91	1.82 H	234	27.53	15.56

ANTENNA POLARITY & TEST DISTANCE: VERTICAL AT 3 M								
NO.	FREQ. (MHz)	EMISSION LEVEL (dBuV/m)	LIMIT (dBuV/m)	MARGIN (dB)	ANTENNA HEIGHT (m)	TABLE ANGLE (Degree)	RAW VALUE (dBuV)	CORRECTION FACTOR (dB/m)
1	*5300.00	107.36 PK			2.48 V	124	104.59	2.77
2	*5300.00	96.56 AV			2.48 V	124	93.79	2.77
3	10600.00	56.07 PK	74.00	-17.93	1.16 V	189	40.51	15.56
4	10600.00	41.73 AV	54.00	-12.27	1.16 V	189	26.17	15.56

REMARKS:

1. Emission Level(dBuV/m) = Raw Value(dBuV) + Correction Factor(dB/m)
2. Correction Factor(dB/m) = Antenna Factor(dB/m) + Cable Factor(dB) – Pre-Amplifier Factor(dB)
3. The other emission levels were very low against the limit.
4. Margin value = Emission Level – Limit value
5. " * ": Fundamental frequency.

CHANNEL	TX Channel 64	DETECTOR FUNCTION	Peak (PK)
FREQUENCY RANGE	30MHz ~ 1GHz		Average (AV)

ANTENNA POLARITY & TEST DISTANCE: HORIZONTAL AT 3 M								
NO.	FREQ. (MHz)	EMISSION LEVEL (dBuV/m)	LIMIT (dBuV/m)	MARGIN (dB)	ANTENNA HEIGHT (m)	TABLE ANGLE (Degree)	RAW VALUE (dBuV)	CORRECTION FACTOR (dB/m)
1	*5320.00	109.60 PK			1.86 H	59	106.78	2.82
2	*5320.00	98.24 AV			1.86 H	59	95.42	2.82
3	5350.00	57.94 PK	74.00	-16.06	1.86 H	59	55.02	2.92
4	5350.00	44.05 AV	54.00	-9.95	1.86 H	59	41.13	2.92
5	10640.00	58.05 PK	74.00	-15.95	1.72 H	188	42.59	15.46
6	10640.00	42.90 AV	54.00	-11.10	1.72 H	188	27.44	15.46
ANTENNA POLARITY & TEST DISTANCE: VERTICAL AT 3 M								
NO.	FREQ. (MHz)	EMISSION LEVEL (dBuV/m)	LIMIT (dBuV/m)	MARGIN (dB)	ANTENNA HEIGHT (m)	TABLE ANGLE (Degree)	RAW VALUE (dBuV)	CORRECTION FACTOR (dB/m)
1	*5320.00	107.33 PK			2.46 V	177	104.51	2.82
2	*5320.00	96.70 AV			2.46 V	177	93.88	2.82
3	5350.00	55.35 PK	74.00	-18.65	2.46 V	177	52.43	2.92
4	5350.00	41.84 AV	54.00	-12.16	2.46 V	177	38.92	2.92
5	10640.00	55.96 PK	74.00	-18.04	1.92 V	203	40.50	15.46
6	10640.00	41.59 AV	54.00	-12.41	1.92 V	203	26.13	15.46

REMARKS:

1. Emission Level(dBuV/m) = Raw Value(dBuV) + Correction Factor(dB/m)
2. Correction Factor(dB/m) = Antenna Factor(dB/m) + Cable Factor(dB) – Pre-Amplifier Factor(dB)
3. The other emission levels were very low against the limit.
4. Margin value = Emission Level – Limit value
5. " * " : Fundamental frequency.

CHANNEL	TX Channel 100	DETECTOR FUNCTION	Peak (PK)
FREQUENCY RANGE	30MHz ~ 1GHz		Average (AV)

ANTENNA POLARITY & TEST DISTANCE: HORIZONTAL AT 3 M								
NO.	FREQ. (MHz)	EMISSION LEVEL (dBuV/m)	LIMIT (dBuV/m)	MARGIN (dB)	ANTENNA HEIGHT (m)	TABLE ANGLE (Degree)	RAW VALUE (dBuV)	CORRECTION FACTOR (dB/m)
1	5460.00	60.79 PK	74.00	-13.21	1.29 H	58	57.53	3.26
2	5460.00	52.93 AV	54.00	-1.07	1.29 H	58	49.67	3.26
3	5470.00	61.59 PK	68.20	-6.61	1.29 H	58	58.33	3.26
4	*5500.00	99.83 PK			1.29 H	58	96.60	3.23
5	*5500.00	90.22 AV			1.29 H	58	86.99	3.23
6	11000.00	57.50 PK	74.00	-16.50	1.47 H	108	41.62	15.88
7	11000.00	42.06 AV	54.00	-11.94	1.47 H	108	26.18	15.88
ANTENNA POLARITY & TEST DISTANCE: VERTICAL AT 3 M								
NO.	FREQ. (MHz)	EMISSION LEVEL (dBuV/m)	LIMIT (dBuV/m)	MARGIN (dB)	ANTENNA HEIGHT (m)	TABLE ANGLE (Degree)	RAW VALUE (dBuV)	CORRECTION FACTOR (dB/m)
1	5460.00	58.95 PK	74.00	-15.05	2.27 V	185	55.69	3.26
2	5460.00	50.69 AV	54.00	-3.31	2.27 V	185	47.43	3.26
3	5470.00	60.75 PK	68.20	-7.45	2.27 V	185	57.49	3.26
4	*5500.00	97.41 PK			2.27 V	185	94.18	3.23
5	*5500.00	88.26 AV			2.27 V	185	85.03	3.23
6	11000.00	56.15 PK	74.00	-17.85	1.97 V	268	40.27	15.88
7	11000.00	41.25 AV	54.00	-12.75	1.97 V	268	25.37	15.88

REMARKS:

1. Emission Level(dBuV/m) = Raw Value(dBuV) + Correction Factor(dB/m)
2. Correction Factor(dB/m) = Antenna Factor(dB/m) + Cable Factor(dB) – Pre-Amplifier Factor(dB)
3. The other emission levels were very low against the limit.
4. Margin value = Emission Level – Limit value
5. " * " : Fundamental frequency.
6. " # " : The radiated frequency is out of the restricted band.

CHANNEL	TX Channel 116	DETECTOR FUNCTION	Peak (PK)
FREQUENCY RANGE	30MHz ~ 1GHz		Average (AV)

ANTENNA POLARITY & TEST DISTANCE: HORIZONTAL AT 3 M								
NO.	FREQ. (MHz)	EMISSION LEVEL (dBuV/m)	LIMIT (dBuV/m)	MARGIN (dB)	ANTENNA HEIGHT (m)	TABLE ANGLE (Degree)	RAW VALUE (dBuV)	CORRECTION FACTOR (dB/m)
1	*5580.00	109.23 PK			1.15 H	56	105.68	3.55
2	*5580.00	98.20 AV			1.15 H	56	94.65	3.55
3	11160.00	58.29 PK	74.00	-15.71	1.43 H	48	42.03	16.26
4	11160.00	42.75 AV	54.00	-11.25	1.43 H	48	26.49	16.26
ANTENNA POLARITY & TEST DISTANCE: VERTICAL AT 3 M								
NO.	FREQ. (MHz)	EMISSION LEVEL (dBuV/m)	LIMIT (dBuV/m)	MARGIN (dB)	ANTENNA HEIGHT (m)	TABLE ANGLE (Degree)	RAW VALUE (dBuV)	CORRECTION FACTOR (dB/m)
1	*5580.00	107.37 PK			1.77 V	66	103.82	3.55
2	*5580.00	96.34 AV			1.77 V	66	92.79	3.55
3	11160.00	56.84 PK	74.00	-17.16	1.85 V	91	40.58	16.26
4	11160.00	41.97 AV	54.00	-12.03	1.85 V	91	25.71	16.26

REMARKS:

1. Emission Level(dBuV/m) = Raw Value(dBuV) + Correction Factor(dB/m)
2. Correction Factor(dB/m) = Antenna Factor(dB/m) + Cable Factor(dB) – Pre-Amplifier Factor(dB)
3. The other emission levels were very low against the limit.
4. Margin value = Emission Level – Limit value
5. " * ": Fundamental frequency.

CHANNEL	TX Channel 132	DETECTOR FUNCTION	Peak (PK)
FREQUENCY RANGE	30MHz ~ 1GHz		Average (AV)

ANTENNA POLARITY & TEST DISTANCE: HORIZONTAL AT 3 M								
NO.	FREQ. (MHz)	EMISSION LEVEL (dBuV/m)	LIMIT (dBuV/m)	MARGIN (dB)	ANTENNA HEIGHT (m)	TABLE ANGLE (Degree)	RAW VALUE (dBuV)	CORRECTION FACTOR (dB/m)
1	*5660.00	109.74 PK			1.64 H	96	105.87	3.87
2	*5660.00	98.84 AV			1.64 H	96	94.97	3.87
3	11320.00	58.02 PK	74.00	-15.98	1.02 H	82	42.11	15.91
4	11320.00	42.44 AV	54.00	-11.56	1.02 H	82	26.53	15.91

ANTENNA POLARITY & TEST DISTANCE: VERTICAL AT 3 M								
NO.	FREQ. (MHz)	EMISSION LEVEL (dBuV/m)	LIMIT (dBuV/m)	MARGIN (dB)	ANTENNA HEIGHT (m)	TABLE ANGLE (Degree)	RAW VALUE (dBuV)	CORRECTION FACTOR (dB/m)
1	*5660.00	107.78 PK			2.63 V	72	103.91	3.87
2	*5660.00	96.80 AV			2.63 V	72	92.93	3.87
3	11320.00	56.53 PK	74.00	-17.47	1.99 V	108	40.62	15.91
4	11320.00	41.75 AV	54.00	-12.25	1.99 V	108	25.84	15.91

REMARKS:

1. Emission Level(dBuV/m) = Raw Value(dBuV) + Correction Factor(dB/m)
2. Correction Factor(dB/m) = Antenna Factor(dB/m) + Cable Factor(dB) – Pre-Amplifier Factor(dB)
3. The other emission levels were very low against the limit.
4. Margin value = Emission Level – Limit value
5. " * ": Fundamental frequency.

CHANNEL	TX Channel 140	DETECTOR FUNCTION	Peak (PK)
FREQUENCY RANGE	30MHz ~ 1GHz		Average (AV)

ANTENNA POLARITY & TEST DISTANCE: HORIZONTAL AT 3 M								
NO.	FREQ. (MHz)	EMISSION LEVEL (dBuV/m)	LIMIT (dBuV/m)	MARGIN (dB)	ANTENNA HEIGHT (m)	TABLE ANGLE (Degree)	RAW VALUE (dBuV)	CORRECTION FACTOR (dB/m)
1	*5700.00	102.29 PK			1.70 H	61	98.17	4.12
2	*5700.00	92.43 AV			1.70 H	61	88.31	4.12
3	#5725.00	64.26 PK	74.00	-9.74	1.70 H	61	59.96	4.30
4	#5725.00	52.91 AV	54.00	-1.09	1.70 H	61	48.61	4.30
5	11400.00	58.06 PK	74.00	-15.94	1.74 H	66	41.81	16.25
6	11400.00	42.56 AV	54.00	-11.44	1.74 H	66	26.31	16.25
ANTENNA POLARITY & TEST DISTANCE: VERTICAL AT 3 M								
NO.	FREQ. (MHz)	EMISSION LEVEL (dBuV/m)	LIMIT (dBuV/m)	MARGIN (dB)	ANTENNA HEIGHT (m)	TABLE ANGLE (Degree)	RAW VALUE (dBuV)	CORRECTION FACTOR (dB/m)
1	*5700.00	99.81 PK			2.03 V	179	95.69	4.12
2	*5700.00	90.59 AV			2.03 V	179	86.47	4.12
3	#5725.00	62.74 PK	74.00	-11.26	2.03 V	179	58.44	4.30
4	#5725.00	51.33 AV	54.00	-2.67	2.03 V	179	47.03	4.30
5	11400.00	56.65 PK	74.00	-17.35	1.97 V	271	40.40	16.25
6	11400.00	41.74 AV	54.00	-12.26	1.97 V	271	25.49	16.25

REMARKS:

1. Emission Level(dBuV/m) = Raw Value(dBuV) + Correction Factor(dB/m)
2. Correction Factor(dB/m) = Antenna Factor(dB/m) + Cable Factor(dB) – Pre-Amplifier Factor(dB)
3. The other emission levels were very low against the limit.
4. Margin value = Emission Level – Limit value
5. " * ": Fundamental frequency.
6. " # ": The radiated frequency is out of the restricted band.

802.11ac (40MHz)

CHANNEL	TX Channel 54	DETECTOR FUNCTION	Peak (PK)
FREQUENCY RANGE	30MHz ~ 1GHz		Average (AV)

ANTENNA POLARITY & TEST DISTANCE: HORIZONTAL AT 3 M								
NO.	FREQ. (MHz)	EMISSION LEVEL (dBuV/m)	LIMIT (dBuV/m)	MARGIN (dB)	ANTENNA HEIGHT (m)	TABLE ANGLE (Degree)	RAW VALUE (dBuV)	CORRECTION FACTOR (dB/m)
1	5150.00	57.95 PK	74.00	-16.05	1.00 H	65	54.29	3.66
2	5150.00	43.39 AV	54.00	-10.61	1.00 H	65	39.73	3.66
3	*5270.00	111.61 PK			1.00 H	65	108.73	2.88
4	*5270.00	100.94 AV			1.00 H	65	98.06	2.88
5	#10540.00	58.59 PK	74.00	-15.41	1.97 H	231	42.97	15.62
6	#10540.00	42.07 AV	54.00	-11.93	1.97 H	231	26.45	15.62
ANTENNA POLARITY & TEST DISTANCE: VERTICAL AT 3 M								
NO.	FREQ. (MHz)	EMISSION LEVEL (dBuV/m)	LIMIT (dBuV/m)	MARGIN (dB)	ANTENNA HEIGHT (m)	TABLE ANGLE (Degree)	RAW VALUE (dBuV)	CORRECTION FACTOR (dB/m)
1	5150.00	55.83 PK	74.00	-18.17	1.17 V	103	52.17	3.66
2	5150.00	42.58 AV	54.00	-11.42	1.17 V	103	38.92	3.66
3	*5270.00	110.32 PK			1.17 V	103	107.44	2.88
4	*5270.00	100.41 AV			1.17 V	103	97.53	2.88
5	#10540.00	56.44 PK	74.00	-17.56	1.23 V	158	40.82	15.62
6	#10540.00	41.20 AV	54.00	-12.80	1.23 V	158	25.58	15.62

REMARKS:

1. Emission Level(dBuV/m) = Raw Value(dBuV) + Correction Factor(dB/m)
2. Correction Factor(dB/m) = Antenna Factor(dB/m) + Cable Factor(dB) – Pre-Amplifier Factor(dB)
3. The other emission levels were very low against the limit.
4. Margin value = Emission Level – Limit value
5. " * ": Fundamental frequency.
6. " # ": The radiated frequency is out of the restricted band.

CHANNEL	TX Channel 62	DETECTOR FUNCTION	Peak (PK)
FREQUENCY RANGE	30MHz ~ 1GHz		Average (AV)

ANTENNA POLARITY & TEST DISTANCE: HORIZONTAL AT 3 M								
NO.	FREQ. (MHz)	EMISSION LEVEL (dBuV/m)	LIMIT (dBuV/m)	MARGIN (dB)	ANTENNA HEIGHT (m)	TABLE ANGLE (Degree)	RAW VALUE (dBuV)	CORRECTION FACTOR (dB/m)
1	*5310.00	107.74 PK			1.46 H	64	104.94	2.80
2	*5310.00	98.19 AV			1.46 H	64	95.39	2.80
3	5350.00	68.16 PK	74.00	-5.84	1.46 H	64	65.24	2.92
4	5350.00	52.76 AV	54.00	-1.24	1.46 H	64	49.84	2.92
5	10620.00	58.24 PK	74.00	-15.76	1.71 H	201	42.72	15.52
6	10620.00	41.83 AV	54.00	-12.17	1.71 H	201	26.31	15.52
ANTENNA POLARITY & TEST DISTANCE: VERTICAL AT 3 M								
NO.	FREQ. (MHz)	EMISSION LEVEL (dBuV/m)	LIMIT (dBuV/m)	MARGIN (dB)	ANTENNA HEIGHT (m)	TABLE ANGLE (Degree)	RAW VALUE (dBuV)	CORRECTION FACTOR (dB/m)
1	*5310.00	106.28 PK			1.02 V	97	103.48	2.80
2	*5310.00	97.46 AV			1.02 V	97	94.66	2.80
3	5350.00	65.63 PK	74.00	-8.37	1.02 V	97	62.71	2.92
4	5350.00	50.95 AV	54.00	-3.05	1.02 V	97	48.03	2.92
5	10620.00	56.13 PK	74.00	-17.87	1.33 V	162	40.61	15.52
6	10620.00	40.89 AV	54.00	-13.11	1.33 V	162	25.37	15.52

REMARKS:

1. Emission Level(dBuV/m) = Raw Value(dBuV) + Correction Factor(dB/m)
2. Correction Factor(dB/m) = Antenna Factor(dB/m) + Cable Factor(dB) – Pre-Amplifier Factor(dB)
3. The other emission levels were very low against the limit.
4. Margin value = Emission Level – Limit value
5. " * ": Fundamental frequency.

CHANNEL	TX Channel 102	DETECTOR FUNCTION	Peak (PK)
FREQUENCY RANGE	30MHz ~ 1GHz		Average (AV)

ANTENNA POLARITY & TEST DISTANCE: HORIZONTAL AT 3 M								
NO.	FREQ. (MHz)	EMISSION LEVEL (dBuV/m)	LIMIT (dBuV/m)	MARGIN (dB)	ANTENNA HEIGHT (m)	TABLE ANGLE (Degree)	RAW VALUE (dBuV)	CORRECTION FACTOR (dB/m)
1	5460.00	60.02 PK	74.00	-13.98	1.62 H	66	56.76	3.26
2	5460.00	43.96 AV	54.00	-10.04	1.62 H	66	40.70	3.26
3	5470.00	67.08 PK	68.20	-1.12	1.62 H	66	63.82	3.26
4	*5510.00	106.68 PK			1.62 H	66	103.41	3.27
5	*5510.00	97.64 AV			1.62 H	66	94.37	3.27
6	11020.00	58.31 PK	74.00	-15.69	1.77 H	245	42.31	16.00
7	11020.00	42.17 AV	54.00	-11.83	1.77 H	245	26.17	16.00
ANTENNA POLARITY & TEST DISTANCE: VERTICAL AT 3 M								
NO.	FREQ. (MHz)	EMISSION LEVEL (dBuV/m)	LIMIT (dBuV/m)	MARGIN (dB)	ANTENNA HEIGHT (m)	TABLE ANGLE (Degree)	RAW VALUE (dBuV)	CORRECTION FACTOR (dB/m)
1	5460.00	56.53 PK	74.00	-17.47	1.27 V	87	53.27	3.26
2	5460.00	41.70 AV	54.00	-12.30	1.27 V	87	38.44	3.26
3	5470.00	63.98 PK	68.20	-4.22	1.27 V	87	60.72	3.26
4	*5510.00	105.44 PK			1.27 V	87	102.17	3.27
5	*5510.00	96.49 AV			1.27 V	87	93.22	3.27
6	11020.00	56.19 PK	74.00	-17.81	1.42 V	168	40.19	16.00
7	11020.00	41.03 AV	54.00	-12.97	1.42 V	168	25.03	16.00

REMARKS:

1. Emission Level(dBuV/m) = Raw Value(dBuV) + Correction Factor(dB/m)
2. Correction Factor(dB/m) = Antenna Factor(dB/m) + Cable Factor(dB) – Pre-Amplifier Factor(dB)
3. The other emission levels were very low against the limit.
4. Margin value = Emission Level – Limit value
5. " * " : Fundamental frequency.
6. " # " : The radiated frequency is out of the restricted band.

CHANNEL	TX Channel 110	DETECTOR FUNCTION	Peak (PK)
FREQUENCY RANGE	30MHz ~ 1GHz		Average (AV)

ANTENNA POLARITY & TEST DISTANCE: HORIZONTAL AT 3 M								
NO.	FREQ. (MHz)	EMISSION LEVEL (dBuV/m)	LIMIT (dBuV/m)	MARGIN (dB)	ANTENNA HEIGHT (m)	TABLE ANGLE (Degree)	RAW VALUE (dBuV)	CORRECTION FACTOR (dB/m)
1	*5550.00	110.47 PK			1.97 H	62	107.03	3.44
2	*5550.00	100.30 AV			1.97 H	62	96.86	3.44
3	11100.00	58.99 PK	74.00	-15.01	1.28 H	282	42.55	16.44
4	11100.00	42.82 AV	54.00	-11.18	1.28 H	282	26.38	16.44
ANTENNA POLARITY & TEST DISTANCE: VERTICAL AT 3 M								
NO.	FREQ. (MHz)	EMISSION LEVEL (dBuV/m)	LIMIT (dBuV/m)	MARGIN (dB)	ANTENNA HEIGHT (m)	TABLE ANGLE (Degree)	RAW VALUE (dBuV)	CORRECTION FACTOR (dB/m)
1	*5550.00	109.33 PK			1.32 V	91	105.89	3.44
2	*5550.00	99.20 AV			1.32 V	91	95.76	3.44
3	11100.00	56.77 PK	74.00	-17.23	1.44 V	171	40.33	16.44
4	11100.00	41.71 AV	54.00	-12.29	1.44 V	171	25.27	16.44

REMARKS:

1. Emission Level(dBuV/m) = Raw Value(dBuV) + Correction Factor(dB/m)
2. Correction Factor(dB/m) = Antenna Factor(dB/m) + Cable Factor(dB) – Pre-Amplifier Factor(dB)
3. The other emission levels were very low against the limit.
4. Margin value = Emission Level – Limit value
5. " * " : Fundamental frequency.

CHANNEL	TX Channel 134	DETECTOR FUNCTION	Peak (PK)
FREQUENCY RANGE	30MHz ~ 1GHz		Average (AV)

ANTENNA POLARITY & TEST DISTANCE: HORIZONTAL AT 3 M								
NO.	FREQ. (MHz)	EMISSION LEVEL (dBuV/m)	LIMIT (dBuV/m)	MARGIN (dB)	ANTENNA HEIGHT (m)	TABLE ANGLE (Degree)	RAW VALUE (dBuV)	CORRECTION FACTOR (dB/m)
1	*5670.00	111.30 PK			1.54 H	69	107.37	3.93
2	*5670.00	101.62 AV			1.54 H	69	97.69	3.93
3	#5725.00	64.89 PK	74.00	-9.11	1.54 H	69	60.59	4.30
4	#5725.00	52.94 AV	54.00	-1.06	1.54 H	69	48.64	4.30
5	11340.00	58.60 PK	74.00	-15.40	1.56 H	281	42.61	15.99
6	11340.00	42.43 AV	54.00	-11.57	1.56 H	281	26.44	15.99
ANTENNA POLARITY & TEST DISTANCE: VERTICAL AT 3 M								
NO.	FREQ. (MHz)	EMISSION LEVEL (dBuV/m)	LIMIT (dBuV/m)	MARGIN (dB)	ANTENNA HEIGHT (m)	TABLE ANGLE (Degree)	RAW VALUE (dBuV)	CORRECTION FACTOR (dB/m)
1	*5670.00	109.90 PK			1.33 V	102	105.97	3.93
2	*5670.00	99.82 AV			1.33 V	102	95.89	3.93
3	#5725.00	58.92 PK	74.00	-15.08	1.33 V	102	54.62	4.30
4	#5725.00	44.47 AV	54.00	-9.53	1.33 V	102	40.17	4.30
5	11340.00	56.46 PK	74.00	-17.54	1.57 V	188	40.47	15.99
6	11340.00	41.34 AV	54.00	-12.66	1.57 V	188	25.35	15.99

REMARKS:

1. Emission Level(dBuV/m) = Raw Value(dBuV) + Correction Factor(dB/m)
2. Correction Factor(dB/m) = Antenna Factor(dB/m) + Cable Factor(dB) – Pre-Amplifier Factor(dB)
3. The other emission levels were very low against the limit.
4. Margin value = Emission Level – Limit value
5. " * ": Fundamental frequency.
6. " # ": The radiated frequency is out of the restricted band.

802.11ac (80MHz)

CHANNEL	TX Channel 58	DETECTOR FUNCTION	Peak (PK)
FREQUENCY RANGE	30MHz ~ 1GHz		Average (AV)

ANTENNA POLARITY & TEST DISTANCE: HORIZONTAL AT 3 M								
NO.	FREQ. (MHz)	EMISSION LEVEL (dBuV/m)	LIMIT (dBuV/m)	MARGIN (dB)	ANTENNA HEIGHT (m)	TABLE ANGLE (Degree)	RAW VALUE (dBuV)	CORRECTION FACTOR (dB/m)
1	5150.00	56.56 PK	74.00	-17.44	1.00 H	70	52.90	3.66
2	5150.00	44.07 AV	54.00	-9.93	1.00 H	70	40.41	3.66
3	*5290.00	103.26 PK			1.00 H	70	100.46	2.80
4	*5290.00	93.77 AV			1.00 H	70	90.97	2.80
5	5350.00	63.89 PK	74.00	-10.11	1.00 H	70	60.97	2.92
6	5350.00	52.82 AV	54.00	-1.18	1.00 H	70	49.90	2.92
7	#10580.00	57.24 PK	74.00	-16.76	1.62 H	166	41.66	15.58
8	#10580.00	41.95 AV	54.00	-12.05	1.62 H	166	26.37	15.58
ANTENNA POLARITY & TEST DISTANCE: VERTICAL AT 3 M								
NO.	FREQ. (MHz)	EMISSION LEVEL (dBuV/m)	LIMIT (dBuV/m)	MARGIN (dB)	ANTENNA HEIGHT (m)	TABLE ANGLE (Degree)	RAW VALUE (dBuV)	CORRECTION FACTOR (dB/m)
1	5150.00	54.38 PK	74.00	-19.62	1.15 V	108	50.72	3.66
2	5150.00	43.43 AV	54.00	-10.57	1.15 V	108	39.77	3.66
3	*5290.00	102.07 PK			1.15 V	108	99.27	2.80
4	*5290.00	92.63 AV			1.15 V	108	89.83	2.80
5	5350.00	61.94 PK	74.00	-12.06	1.15 V	108	59.02	2.92
6	5350.00	51.41 AV	54.00	-2.59	1.15 V	108	48.49	2.92
7	#10580.00	55.19 PK	74.00	-18.81	1.00 V	82	39.61	15.58
8	#10580.00	40.19 AV	54.00	-13.81	1.00 V	82	24.61	15.58

REMARKS:

1. Emission Level(dBuV/m) = Raw Value(dBuV) + Correction Factor(dB/m)
2. Correction Factor(dB/m) = Antenna Factor(dB/m) + Cable Factor(dB) – Pre-Amplifier Factor(dB)
3. The other emission levels were very low against the limit.
4. Margin value = Emission Level – Limit value
5. " * ": Fundamental frequency.
6. " # ": The radiated frequency is out of the restricted band.

CHANNEL	TX Channel 106	DETECTOR FUNCTION	Peak (PK)
FREQUENCY RANGE	30MHz ~ 1GHz		Average (AV)

ANTENNA POLARITY & TEST DISTANCE: HORIZONTAL AT 3 M								
NO.	FREQ. (MHz)	EMISSION LEVEL (dBuV/m)	LIMIT (dBuV/m)	MARGIN (dB)	ANTENNA HEIGHT (m)	TABLE ANGLE (Degree)	RAW VALUE (dBuV)	CORRECTION FACTOR (dB/m)
1	5460.00	64.15 PK	74.00	-9.85	1.63 H	72	60.89	3.26
2	5460.00	51.47 AV	54.00	-2.53	1.63 H	72	48.21	3.26
3	5470.00	67.02 PK	68.20	-1.18	1.63 H	72	63.76	3.26
4	*5530.00	102.44 PK			1.63 H	72	99.08	3.36
5	*5530.00	93.57 AV			1.63 H	72	90.21	3.36
6	11060.00	57.94 PK	74.00	-16.06	1.57 H	163	41.73	16.21
7	11060.00	42.58 AV	54.00	-11.42	1.57 H	163	26.37	16.21
ANTENNA POLARITY & TEST DISTANCE: VERTICAL AT 3 M								
NO.	FREQ. (MHz)	EMISSION LEVEL (dBuV/m)	LIMIT (dBuV/m)	MARGIN (dB)	ANTENNA HEIGHT (m)	TABLE ANGLE (Degree)	RAW VALUE (dBuV)	CORRECTION FACTOR (dB/m)
1	5460.00	61.98 PK	74.00	-12.02	1.12 V	87	58.72	3.26
2	5460.00	50.38 AV	54.00	-3.62	1.12 V	87	47.12	3.26
3	5470.00	63.70 PK	68.20	-4.50	1.12 V	87	60.44	3.26
4	*5530.00	101.18 PK			1.12 V	87	97.82	3.36
5	*5530.00	92.39 AV			1.12 V	87	89.03	3.36
6	11060.00	56.08 PK	74.00	-17.92	1.02 V	44	39.87	16.21
7	11060.00	41.02 AV	54.00	-12.98	1.02 V	44	24.81	16.21

REMARKS:

1. Emission Level(dBuV/m) = Raw Value(dBuV) + Correction Factor(dB/m)
2. Correction Factor(dB/m) = Antenna Factor(dB/m) + Cable Factor(dB) – Pre-Amplifier Factor(dB)
3. The other emission levels were very low against the limit.
4. Margin value = Emission Level – Limit value
5. " * " : Fundamental frequency.
6. " # " : The radiated frequency is out of the restricted band.

CHANNEL	TX Channel 122	DETECTOR FUNCTION	Peak (PK)
FREQUENCY RANGE	30MHz ~ 1GHz		Average (AV)

ANTENNA POLARITY & TEST DISTANCE: HORIZONTAL AT 3 M								
NO.	FREQ. (MHz)	EMISSION LEVEL (dBuV/m)	LIMIT (dBuV/m)	MARGIN (dB)	ANTENNA HEIGHT (m)	TABLE ANGLE (Degree)	RAW VALUE (dBuV)	CORRECTION FACTOR (dB/m)
1	*5610.00	109.13 PK			1.34 H	77	105.46	3.67
2	*5610.00	98.39 AV			1.34 H	77	94.72	3.67
3	#5725.00	64.69 PK	74.00	-9.31	1.34 H	77	60.39	4.30
4	#5725.00	52.88 AV	54.00	-1.12	1.34 H	77	48.58	4.30
5	11220.00	57.98 PK	74.00	-16.02	1.75 H	98	41.88	16.10
6	11220.00	42.53 AV	54.00	-11.47	1.75 H	98	26.43	16.10
ANTENNA POLARITY & TEST DISTANCE: VERTICAL AT 3 M								
NO.	FREQ. (MHz)	EMISSION LEVEL (dBuV/m)	LIMIT (dBuV/m)	MARGIN (dB)	ANTENNA HEIGHT (m)	TABLE ANGLE (Degree)	RAW VALUE (dBuV)	CORRECTION FACTOR (dB/m)
1	*5610.00	107.79 PK			1.08 V	97	104.12	3.67
2	*5610.00	97.29 AV			1.08 V	97	93.62	3.67
3	#5725.00	59.02 PK	74.00	-14.98	1.08 V	97	54.72	4.30
4	#5725.00	44.43 AV	54.00	-9.57	1.08 V	97	40.13	4.30
5	11220.00	56.18 PK	74.00	-17.82	1.14 V	38	40.08	16.10
6	11220.00	41.13 AV	54.00	-12.87	1.14 V	38	25.03	16.10

REMARKS:

1. Emission Level(dBuV/m) = Raw Value(dBuV) + Correction Factor(dB/m)
2. Correction Factor(dB/m) = Antenna Factor(dB/m) + Cable Factor(dB) – Pre-Amplifier Factor(dB)
3. The other emission levels were very low against the limit.
4. Margin value = Emission Level – Limit value
5. " * ": Fundamental frequency.
6. " # ": The radiated frequency is out of the restricted band.

Below 1GHz Data:

CDD Mode

CHANNEL	TX Channel 52	DETECTOR FUNCTION	Quasi-Peak (QP)
FREQUENCY RANGE	9kHz ~ 1GHz		

ANTENNA POLARITY & TEST DISTANCE: HORIZONTAL AT 3 M								
NO.	FREQ. (MHz)	EMISSION LEVEL (dBuV/m)	LIMIT (dBuV/m)	MARGIN (dB)	ANTENNA HEIGHT (m)	TABLE ANGLE (Degree)	RAW VALUE (dBuV)	CORRECTION FACTOR (dB/m)
1	42.90	23.10 QP	40.00	-16.90	1.07 H	95	30.59	-7.49
2	107.36	17.17 QP	43.50	-26.33	2.65 H	52	28.00	-10.83
3	534.74	30.81 QP	46.00	-15.19	2.98 H	82	31.27	-0.46
4	650.02	32.33 QP	46.00	-13.67	1.66 H	160	30.28	2.05
5	775.01	35.10 QP	46.00	-10.90	1.46 H	260	30.43	4.67
6	859.79	33.83 QP	46.00	-12.17	2.05 H	151	28.47	5.36
ANTENNA POLARITY & TEST DISTANCE: VERTICAL AT 3 M								
NO.	FREQ. (MHz)	EMISSION LEVEL (dBuV/m)	LIMIT (dBuV/m)	MARGIN (dB)	ANTENNA HEIGHT (m)	TABLE ANGLE (Degree)	RAW VALUE (dBuV)	CORRECTION FACTOR (dB/m)
1	43.00	35.34 QP	40.00	-4.66	2.28 V	164	42.83	-7.49
2	53.62	29.85 QP	40.00	-10.15	1.05 V	17	37.08	-7.23
3	92.76	24.99 QP	43.50	-18.51	1.15 V	254	37.51	-12.52
4	522.47	28.66 QP	46.00	-17.34	2.68 V	155	29.17	-0.51
5	815.41	33.71 QP	46.00	-12.29	1.48 V	245	28.74	4.97
6	930.11	35.58 QP	46.00	-10.42	1.03 V	133	28.88	6.70

REMARKS:

1. Emission Level(dBuV/m) = Raw Value(dBuV) + Correction Factor(dB/m)
2. Correction Factor(dB/m) = Antenna Factor(dB/m) + Cable Factor(dB) – Pre-Amplifier Factor(dB)
3. The other emission levels were very low against the limit.
4. Margin value = Emission Level – Limit value

4.2 Conducted Emission Measurement

4.2.1 Limits of Conducted Emission Measurement

Frequency (MHz)	Conducted Limit (dBuV)	
	Quasi-peak	Average
0.15 - 0.5	66 - 56	56 - 46
0.50 - 5.0	56	46
5.0 - 30.0	60	50

Note: 1. The lower limit shall apply at the transition frequencies.

2. The limit decreases in line with the logarithm of the frequency in the range of 0.15 to 0.50MHz.

4.2.2 Test Instruments

Description & Manufacturer	Model No.	Serial No.	Cal. Date	Cal. Due
ROHDE & SCHWARZ TEST RECEIVER	ESR3	102413	Feb. 8, 2018	Feb. 7, 2019
ROHDE & SCHWARZ Artificial Mains Network (for EUT)	ESH2-Z5	100104	Dec. 6, 2017	Dec. 5, 2018
LISN With Adapter (for EUT)	AD10	C09Ada-001	Dec. 6, 2017	Dec. 5, 2018
ROHDE & SCHWARZ Artificial Mains Network (for peripherals)	ESH3-Z5	847265/023	Nov. 03, 2017	Nov. 02, 2018
SCHWARZBECK Artificial Mains Network (For EUT)	NNLK8129	8129229	May 3, 2018	May 2, 2019
Software	Cond_V7.3.7.4	NA	NA	NA
RF cable (JYEBAO) With 10dB PAD	5D-FB	Cable-C09.01	Feb. 21, 2018	Feb. 20, 2019
SUHNER Terminator (For ROHDE & SCHWARZ LISN)	65BNC-5001	E1-010789	May 8, 2018	May 7, 2019

Notes: 1. The calibration interval of the above test instruments is 12 months and the calibrations are traceable to NML/ROC and NIST/USA.

2. The test was performed in Shielded Room No. 9.

3. Tested Date: Jun. 1 ~ 27, 2018

4.2.3 Test Procedure

- The EUT was placed 0.4 meters from the conducting wall of the shielded room with EUT being connected to the power mains through a line impedance stabilization network (LISN). Other support units were connected to the power mains through another LISN. The two LISNs provide 50 ohm/ 50uH of coupling impedance for the measuring instrument.
- Both lines of the power mains connected to the EUT were checked for maximum conducted interference.
- The frequency range from 150kHz to 30MHz was searched. Emission levels under (Limit - 20dB) was not recorded.

NOTE: All modes of operation were investigated and the worst-case emissions are reported.

4.2.4 Deviation from Test Standard

No deviation.

4.2.5 Test Setup

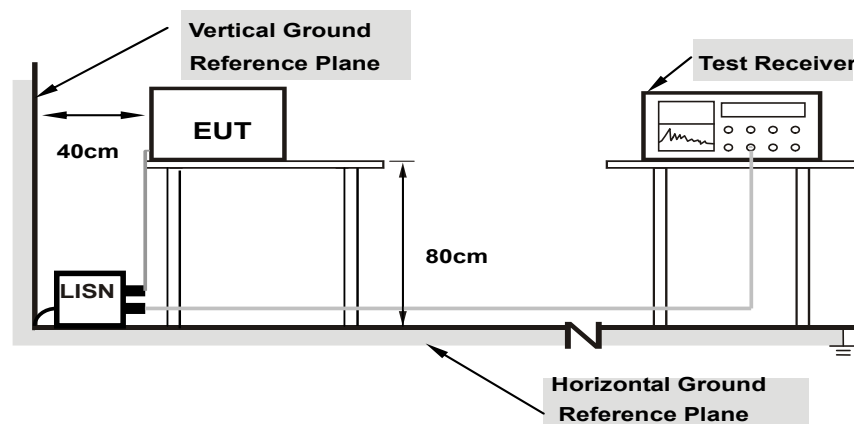

Note: 1.Support units were connected to second LISN.

For the actual test configuration, please refer to the attached file (Test Setup Photo).

4.2.6 EUT Operating Condition

Same as 4.1.6.

4.2.7 Test Results

CDD Mode

Phase	Line (L)	Detector Function	Quasi-Peak (QP) / Average (AV)
Test Mode	Mode A		

No	Freq. [MHz]	Corr. Factor (dB)	Reading Value [dB (uV)]		Emission Level [dB (uV)]		Limit [dB (uV)]		Margin (dB)	
			Q.P.	AV.	Q.P.	AV.	Q.P.	AV.	Q.P.	AV.
			1	0.18125	10.12	28.62	17.75	38.74	27.87	64.43
2	0.37266	10.15	36.67	30.63	46.82	40.78	58.44	48.44	-11.62	-7.66
3	1.09766	10.26	24.90	16.87	35.16	27.13	56.00	46.00	-20.84	-18.87
4	3.46875	10.43	22.62	14.21	33.05	24.64	56.00	46.00	-22.95	-21.36
5	12.40234	10.77	28.70	25.57	39.47	36.34	60.00	50.00	-20.53	-13.66
6	15.07422	10.89	35.68	35.19	46.57	46.08	60.00	50.00	-13.43	-3.92

REMARKS:

1. Q.P. and AV. are abbreviations of quasi-peak and average individually.
2. The emission levels of other frequencies were very low against the limit.
3. Margin value = Emission level - Limit value
4. Correction factor = Insertion loss + Cable loss
5. Emission Level = Correction Factor + Reading Value.

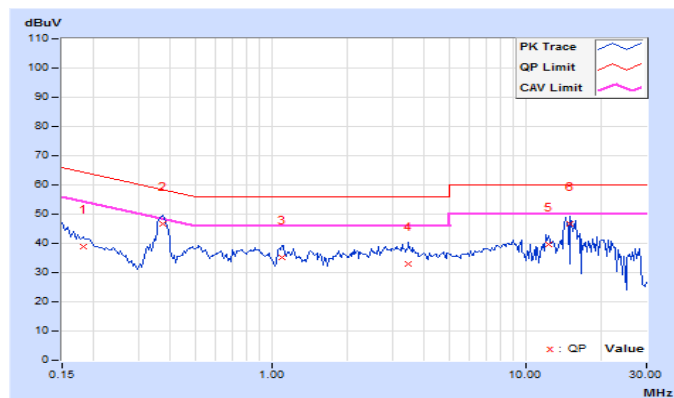

Phase	Neutral (N)	Detector Function	Quasi-Peak (QP) / Average (AV)
Test Mode	Mode A		

No	Freq. [MHz]	Corr. Factor (dB)	Reading Value		Emission Level		Limit		Margin	
			[dB (uV)]		[dB (uV)]		[dB (uV)]		(dB)	
			Q.P.	AV.	Q.P.	AV.	Q.P.	AV.	Q.P.	AV.
1	0.15391	10.12	33.02	20.42	43.14	30.54	65.79	55.79	-22.65	-25.25
2	0.36875	10.16	38.43	33.05	48.59	43.21	58.53	48.53	-9.94	-5.32
3	1.06641	10.27	25.60	14.62	35.87	24.89	56.00	46.00	-20.13	-21.11
4	3.53125	10.45	23.20	14.20	33.65	24.65	56.00	46.00	-22.35	-21.35
5	12.40234	10.71	27.87	25.48	38.58	36.19	60.00	50.00	-21.42	-13.81
6	15.07422	10.77	35.40	34.95	46.17	45.72	60.00	50.00	-13.83	-4.28

REMARKS:

1. Q.P. and AV. are abbreviations of quasi-peak and average individually.
2. The emission levels of other frequencies were very low against the limit.
3. Margin value = Emission level - Limit value
4. Correction factor = Insertion loss + Cable loss
5. Emission Level = Correction Factor + Reading Value.

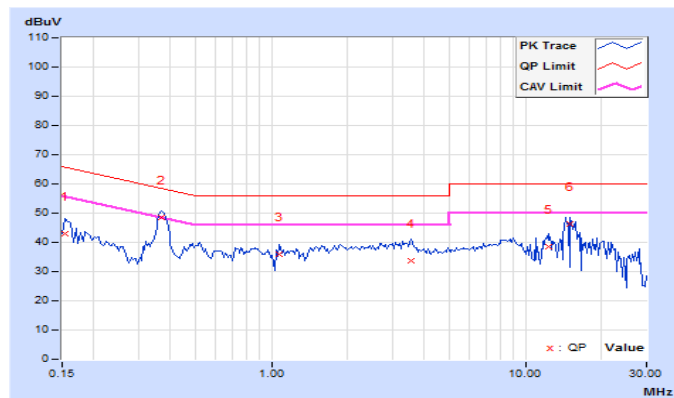

Phase	Line (L)	Detector Function	Quasi-Peak (QP) / Average (AV)
Test Mode	Mode B		

No	Freq. [MHz]	Corr. Factor (dB)	Reading Value [dB (uV)]		Emission Level [dB (uV)]		Limit [dB (uV)]		Margin (dB)	
			Q.P.	AV.	Q.P.	AV.	Q.P.	AV.	Q.P.	AV.
	1	0.16564	10.11	37.13	28.33	47.24	38.44	65.18	55.18	-17.94
2	0.42761	10.15	30.34	23.27	40.49	33.42	57.30	47.30	-16.81	-13.88
3	0.80107	10.22	17.15	11.18	27.37	21.40	56.00	46.00	-28.63	-24.60
4	2.74043	10.38	12.07	6.90	22.45	17.28	56.00	46.00	-33.55	-28.72
5	21.88338	11.13	30.19	27.81	41.32	38.94	60.00	50.00	-18.68	-11.06
6	29.66037	11.13	21.24	14.98	32.37	26.11	60.00	50.00	-27.63	-23.89

REMARKS:

1. Q.P. and AV. are abbreviations of quasi-peak and average individually.
2. The emission levels of other frequencies were very low against the limit.
3. Margin value = Emission level - Limit value
4. Correction factor = Insertion loss + Cable loss
5. Emission Level = Correction Factor + Reading Value.

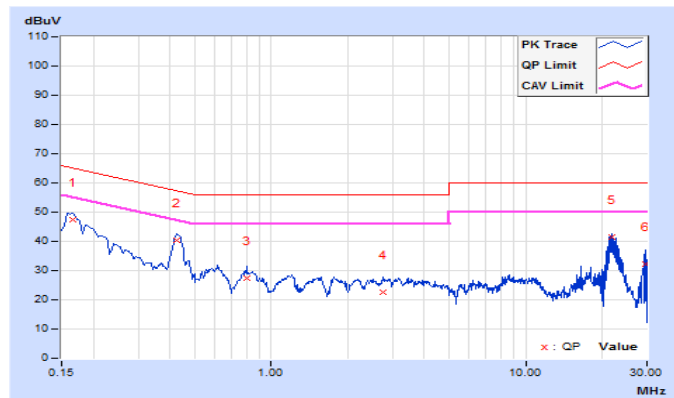

Phase	Neutral (N)	Detector Function	Quasi-Peak (QP) / Average (AV)
Test Mode	Mode B		

No	Freq. [MHz]	Corr. Factor (dB)	Reading Value		Emission Level		Limit		Margin	
			[dB (uV)]		[dB (uV)]		[dB (uV)]		(dB)	
			Q.P.	AV.	Q.P.	AV.	Q.P.	AV.	Q.P.	AV.
1	0.16173	10.12	37.22	26.46	47.34	36.58	65.37	55.37	-18.03	-18.79
2	0.42761	10.17	28.78	21.89	38.95	32.06	57.30	47.30	-18.35	-15.24
3	0.58602	10.19	17.50	12.19	27.69	22.38	56.00	46.00	-28.31	-23.62
4	1.19598	10.28	12.62	7.16	22.90	17.44	56.00	46.00	-33.10	-28.56
5	4.19886	10.50	7.41	2.89	17.91	13.39	56.00	46.00	-38.09	-32.61
6	21.64096	10.85	29.65	26.62	40.50	37.47	60.00	50.00	-19.50	-12.53

REMARKS:

1. Q.P. and AV. are abbreviations of quasi-peak and average individually.
2. The emission levels of other frequencies were very low against the limit.
3. Margin value = Emission level - Limit value
4. Correction factor = Insertion loss + Cable loss
5. Emission Level = Correction Factor + Reading Value.

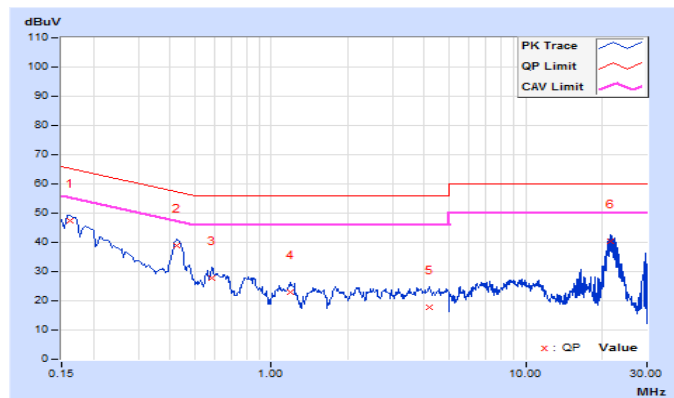

4.3 Transmit Power Measurement

4.3.1 Limits of Transmit Power Measurement

Operation Band	EUT Category		Limit
U-NII-1	---	Outdoor Access Point	1 Watt (30 dBm) (Max. e.i.r.p \leq 125mW(21 dBm) at any elevation angle above 30 degrees as measured from the horizon)
	---	Fixed point-to-point Access Point	1 Watt (30 dBm)
	---	Indoor Access Point	1 Watt (30 dBm)
	---	Client device	250mW (24 dBm)
U-NII-2A	√		250mW (24 dBm) or 11 dBm+10 log B*
U-NII-2C	√		250mW (24 dBm) or 11 dBm+10 log B*
U-NII-3	---		1 Watt (30 dBm)

*B is the 26 dB emission bandwidth in megahertz

Per KDB 662911 Method of conducted output power measurement on IEEE 802.11 devices,

Array Gain = 0 dB (i.e., no array gain) for $N_{ANT} \leq 4$;

Array Gain = 0 dB (i.e., no array gain) for channel widths ≥ 40 MHz for any N_{ANT} ;

Array Gain = $5 \log(N_{ANT}/N_{SS})$ dB or 3 dB, whichever is less for 20-MHz channel widths with $N_{ANT} \geq 5$.

For power measurements on all other devices: Array Gain = $10 \log(N_{ANT}/N_{SS})$ dB.

4.3.2 Test Setup

For Power Output Measurement

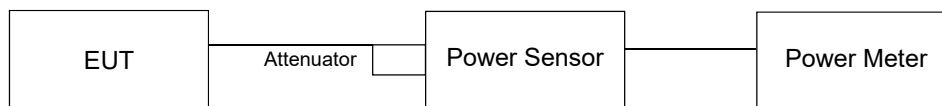

For 26dB Occupied Bandwidth

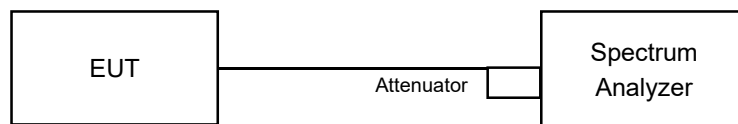

4.3.3 Test Instruments

Refer to section 4.1.2 to get information of above instrument.

4.3.4 Test Procedure

For Average Power Measurement

For 802.11a, 802.11ac (20MHz), 802.11ac (40MHz)

Method PM is used to perform output power measurement, trigger and gating function of wide band power meter is enabled to measure max output power of TX on burst and set the detector to AVERAGE. Duty factor is not added to measured value.

For 802.11ac (80MHz)

- 1) Set span to encompass the entire 26 dB EBW (or, alternatively, the entire 99% occupied bandwidth) of the signal.
- 2) Set sweep trigger to "free run".
- 3) Set RBW = 1 MHz.
- 4) Set VBW \geq 3 MHz
- 5) Number of points in sweep \geq 2 Span / RBW.
- 6) Sweep time \leq (number of points in sweep) * T
- 7) Using emission bandwidth to determine the frequency span for integration the channel bandwidth.
- 8) Detector = RMS.
- 9) Trace mode = max hold.
- 10) Allow max hold to run for at least 60 seconds, or longer as needed to allow the trace to stabilize.

For 26dB Occupied Bandwidth

- 1) Set RBW = approximately 1% of the emission bandwidth.
- 2) Set the VBW > RBW.
- 3) Detector = Peak.
- 4) Trace mode = max hold.
- 5) Measure the maximum width of the emission that is 26 dB down from the peak of the emission. Compare this with the RBW setting of the analyzer. Readjust RBW and repeat measurement as needed until the RBW/EBW ratio is approximately 1%.

4.3.5 Deviation from Test Standard

No deviation.

4.3.6 EUT Operating Condition

The software provided by client to enable the EUT under transmission condition continuously at lowest, middle and highest channel frequencies individually.

4.3.7 Test Result

CDD Mode (Mode A)

Power Output:

802.11a

Chan.	Chan. Freq. (MHz)	Maximum Conducted Power (dBm)		Total Power (mW)	Total Power (dBm)	Power Limit (dBm)	Pass/Fail
		Chain 0	Chain 1				
52	5260	19.97	20.19	203.784	23.09	23.70	PASS
60	5300	20.03	20.21	205.647	23.13	23.70	PASS
64	5320	19.09	19.52	170.632	22.32	23.70	PASS
100	5500	17.77	18.12	124.704	20.96	23.70	PASS
116	5580	17.81	18.18	126.161	21.01	23.70	PASS
132	5660	17.72	18.07	123.277	20.91	23.70	PASS
140	5700	17.74	18.09	123.846	20.93	23.70	PASS

NOTE: Antenna gain = 6.3dBi > 6dBi , so the limit shall be reduced to 24-(6.3-6) = 23.70dBm.

Chain 0:

1. 11dBm + 10log (38.86) = 26.90 > 23.70dBm
2. 11dBm + 10log (37.79) = 26.77 > 23.70dBm
3. 11dBm + 10log (37.44) = 26.73 > 23.70dBm
4. 11dBm + 10log (20.23) = 24.06 > 23.70dBm
5. 11dBm + 10log (20.03) = 24.02 > 23.70dBm
6. 11dBm + 10log (20.28) = 24.07 > 23.70dBm
7. 11dBm + 10log (20.34) = 24.08 > 23.70dBm

Chain 1:

1. 11dBm + 10log (38.93) = 26.90 > 23.70dBm
2. 11dBm + 10log (38.24) = 26.83 > 23.70dBm
3. 11dBm + 10log (37.36) = 26.72 > 23.70dBm
4. 11dBm + 10log (20.23) = 24.06 > 23.70dBm
5. 11dBm + 10log (19.99) = 24.01 > 23.70dBm
6. 11dBm + 10log (20.25) = 24.06 > 23.70dBm
7. 11dBm + 10log (20.42) = 24.10 > 23.70dBm

802.11ac (20MHz)

Chan.	Chan. Freq. (MHz)	Maximum Conducted Power (dBm)		Total Power (mW)	Total Power (dBm)	Power Limit (dBm)	Pass/Fail
		Chain 0	Chain 1				
52	5260	20.52	20.77	232.119	23.66	23.70	PASS
60	5300	20.47	20.79	231.379	23.64	23.70	PASS
64	5320	19.81	20.12	198.521	22.98	23.70	PASS
100	5500	17.98	18.17	128.421	21.09	23.70	PASS
116	5580	17.92	18.11	126.658	21.03	23.70	PASS
132	5660	17.96	18.15	127.830	21.07	23.70	PASS
140	5700	17.94	18.12	127.093	21.04	23.70	PASS

NOTE: Antenna gain = 6.3dBi > 6dBi , so the limit shall be reduced to 24-(6.3-6) = 23.70dBm.

Chain 0:

- | | |
|---|---|
| 1. 11dBm + 10log (42.58) = 27.29 > 23.70dBm | 1. 11dBm + 10log (42.39) = 27.27 > 23.70dBm |
| 2. 11dBm + 10log (40.95) = 27.12 > 23.70dBm | 2. 11dBm + 10log (40.12) = 27.03 > 23.70dBm |
| 3. 11dBm + 10log (39.04) = 26.92 > 23.70dBm | 3. 11dBm + 10log (40.95) = 27.12 > 23.70dBm |
| 4. 11dBm + 10log (20.92) = 24.21 > 23.70dBm | 4. 11dBm + 10log (20.70) = 24.16 > 23.70dBm |
| 5. 11dBm + 10log (20.65) = 24.15 > 23.70dBm | 5. 11dBm + 10log (20.76) = 24.17 > 23.70dBm |
| 6. 11dBm + 10log (20.85) = 24.19 > 23.70dBm | 6. 11dBm + 10log (21.00) = 24.22 > 23.70dBm |
| 7. 11dBm + 10log (20.99) = 24.22 > 23.70dBm | 7. 11dBm + 10log (21.04) = 24.23 > 23.70dBm |

Chain 1:

802.11ac (40MHz)

Chan.	Chan. Freq. (MHz)	Maximum Conducted Power (dBm)		Total Power (mW)	Total Power (dBm)	Power Limit (dBm)	Pass/Fail
		Chain 0	Chain 1				
54	5270	20.51	20.69	229.68	23.61	23.70	PASS
62	5310	15.28	15.52	69.374	18.41	23.70	PASS
102	5510	16.25	16.48	86.633	19.38	23.70	PASS
110	5550	20.52	20.75	231.570	23.65	23.70	PASS
134	5670	19.23	19.49	172.673	22.37	23.70	PASS

NOTE: Antenna gain = 6.3dBi > 6dBi , so the limit shall be reduced to 24-(6.3-6) = 23.70dBm.

Chain 0:

- | | |
|---|---|
| 1. 11dBm + 10log (83.60) = 30.22 > 23.70dBm | 1. 11dBm + 10log (83.71) = 30.23 > 23.70dBm |
| 2. 11dBm + 10log (40.42) = 27.07 > 23.70dBm | 2. 11dBm + 10log (40.48) = 27.07 > 23.70dBm |
| 3. 11dBm + 10log (40.00) = 27.02 > 23.70dBm | 3. 11dBm + 10log (39.94) = 27.01 > 23.70dBm |
| 4. 11dBm + 10log (84.50) = 30.27 > 23.70dBm | 4. 11dBm + 10log (83.66) = 30.23 > 23.70dBm |
| 5. 11dBm + 10log (40.75) = 27.10 > 23.70dBm | 5. 11dBm + 10log (40.68) = 27.09 > 23.70dBm |

Chain 1:

802.11ac (80MHz)

Chan.	Chan. Freq. (MHz)	Maximum Conducted Power (dBm)		Total Power (mW)	Total Power (dBm)	Power Limit (dBm)	Pass/Fail
		Chain 0	Chain 1				
58	5290	15.34	15.56	70.173	18.46	23.70	PASS
106	5530	14.90	14.95	62.164	17.94	23.70	PASS
122	5610	19.64	19.85	188.650	22.76	23.70	PASS

NOTE: Antenna gain = 6.3dBi > 6dBi , so the limit shall be reduced to $24-(6.3-6) = 23.70\text{dBm}$.

Chain 0:

1. $11\text{dBm} + 10\log(83.80) = 30.23 > 23.70\text{dBm}$
2. $11\text{dBm} + 10\log(83.68) = 30.23 > 23.70\text{dBm}$
3. $11\text{dBm} + 10\log(136.42) = 32.35 > 23.70\text{dBm}$

Chain 1:

1. $11\text{dBm} + 10\log(83.93) = 30.24 > 23.70\text{dBm}$
2. $11\text{dBm} + 10\log(83.57) = 30.22 > 23.70\text{dBm}$
3. $11\text{dBm} + 10\log(141.81) = 32.52 > 23.70\text{dBm}$

26dB Bandwidth:
802.11a

Channel	Channel Frequency (MHz)	26dBc Bandwidth (MHz)	
		Chain 0	Chain 1
52	5260	38.86	38.93
60	5300	37.79	38.24
64	5320	37.44	37.36
100	5500	20.23	20.23
116	5580	20.03	19.99
132	5660	20.28	20.25
140	5700	20.34	20.42

802.11ac (20MHz)

Channel	Channel Frequency (MHz)	26dBc Bandwidth (MHz)	
		Chain 0	Chain 1
52	5260	42.58	42.39
60	5300	40.95	40.12
64	5320	39.04	40.95
100	5500	20.92	20.70
116	5580	20.65	20.76
132	5660	20.85	21.00
140	5700	20.99	21.04

802.11ac (40MHz)

Channel	Channel Frequency (MHz)	26dBc Bandwidth (MHz)	
		Chain 0	Chain 1
54	5270	83.60	83.71
62	5310	40.42	40.48
102	5510	40.00	39.94
110	5550	84.50	83.66
134	5670	40.75	40.68

802.11ac (80MHz)

Channel	Channel Frequency (MHz)	26dBc Bandwidth (MHz)	
		Chain 0	Chain 1
58	5290	83.80	83.93
106	5530	83.68	83.57
122	5610	136.42	141.81

Spectrum Plot of Worst Value

802.11a

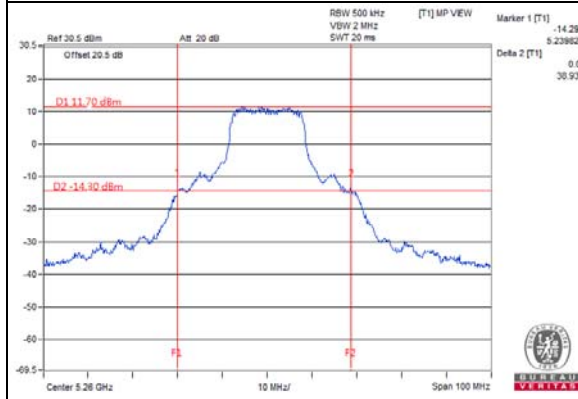

802.11ac (20MHz)

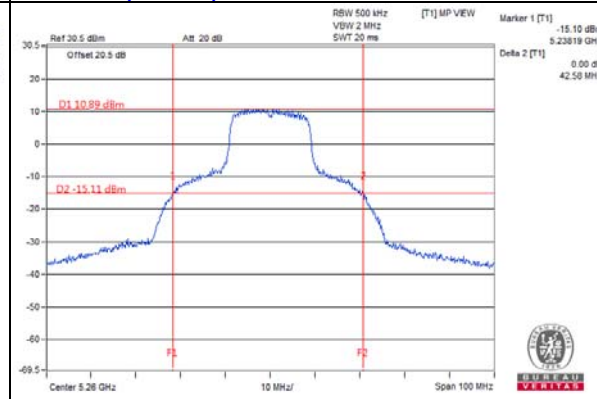

802.11ac (40MHz)

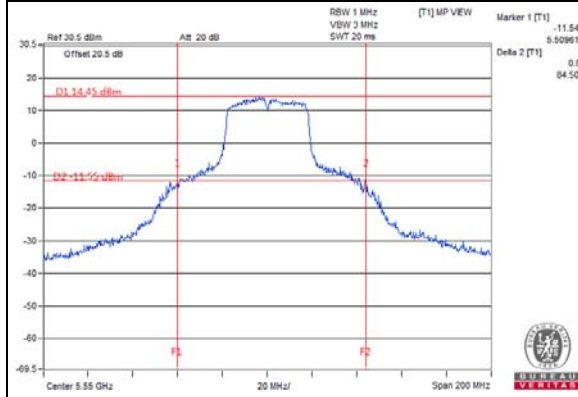

802.11ac (80MHz)

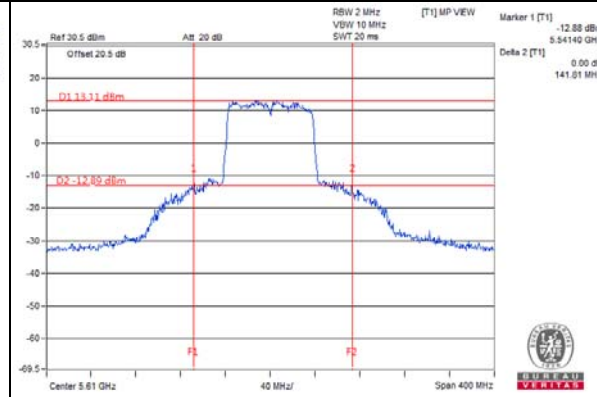

EUT MAXIMUM CONDUCTED POWER

802.11a

Frequency Band (MHz)	MAX. Power	
	Output Power (mW)	Output Power (dBm)
5250~5350	205.647	23.13
5470~5725	126.161	21.01

NOTE: Manufacturer provides Transmit Power Control description to meet this requirement.

802.11ac (20MHz)

Frequency Band (MHz)	MAX. Power	
	Output Power (mW)	Output Power (dBm)
5250~5350	232.119	23.66
5470~5725	128.421	21.09

NOTE: Manufacturer provides Transmit Power Control description to meet this requirement.

802.11ac (40MHz)

Frequency Band (MHz)	MAX. Power	
	Output Power (mW)	Output Power (dBm)
5250~5350	229.68	23.61
5470~5725	231.570	23.65

NOTE: Manufacturer provides Transmit Power Control description to meet this requirement.

802.11ac (80MHz)

Frequency Band (MHz)	MAX. Power	
	Output Power (mW)	Output Power (dBm)
5250~5350	70.173	18.46
5470~5725	188.650	22.76

NOTE: Manufacturer provides Transmit Power Control description to meet this requirement.

Beamforming_NSS1 Mode (Mode A)

Power Output:

802.11ac (20MHz)

Chan.	Chan. Freq. (MHz)	Maximum Conducted Power (dBm)		Total Power (mW)	Total Power (dBm)	Power Limit (dBm)	Pass/Fail
		Chain 0	Chain 1				
52	5260	17.51	17.65	114.574	20.59	20.69	PASS
60	5300	17.49	17.62	113.915	20.57	20.69	PASS
64	5320	17.48	17.61	113.653	20.56	20.69	PASS
100	5500	10.22	10.45	21.612	13.35	20.69	PASS
116	5580	17.43	17.63	113.278	20.54	20.69	PASS
132	5660	17.45	17.62	113.400	20.55	20.69	PASS
140	5700	12.81	12.99	39.006	15.91	20.69	PASS

NOTE: Directional gain = $6.3\text{dBi} + 10\log(2) = 9.31\text{dBi} > 6\text{dBi}$, so the limit shall be reduced to $24 - (9.31 - 6) = 20.69\text{dBm}$.

Chain 0:

1. $11\text{dBm} + 10\log (42.58) = 27.29 > 20.69\text{dBm}$
2. $11\text{dBm} + 10\log (40.95) = 27.12 > 20.69\text{dBm}$
3. $11\text{dBm} + 10\log (39.04) = 26.92 > 20.69\text{dBm}$
4. $11\text{dBm} + 10\log (20.92) = 24.21 > 20.69\text{dBm}$
5. $11\text{dBm} + 10\log (20.65) = 24.15 > 20.69\text{dBm}$
6. $11\text{dBm} + 10\log (20.85) = 24.19 > 20.69\text{dBm}$
7. $11\text{dBm} + 10\log (20.99) = 24.22 > 20.69\text{dBm}$

Chain 1:

1. $11\text{dBm} + 10\log (42.39) = 27.27 > 20.69\text{dBm}$
2. $11\text{dBm} + 10\log (40.12) = 27.03 > 20.69\text{dBm}$
3. $11\text{dBm} + 10\log (40.95) = 27.12 > 20.69\text{dBm}$
4. $11\text{dBm} + 10\log (20.70) = 24.16 > 20.69\text{dBm}$
5. $11\text{dBm} + 10\log (20.76) = 24.17 > 20.69\text{dBm}$
6. $11\text{dBm} + 10\log (21.00) = 24.22 > 20.69\text{dBm}$
7. $11\text{dBm} + 10\log (21.04) = 24.23 > 20.69\text{dBm}$

802.11ac (40MHz)

Chan.	Chan. Freq. (MHz)	Maximum Conducted Power (dBm)		Total Power (mW)	Total Power (dBm)	Power Limit (dBm)	Pass/Fail
		Chain 0	Chain 1				
54	5270	17.49	17.68	114.719	20.60	20.69	PASS
62	5310	15.28	15.52	69.374	18.41	20.69	PASS
102	5510	16.25	16.48	86.633	19.38	20.69	PASS
110	5550	17.29	17.61	111.257	20.46	20.69	PASS
134	5670	17.27	17.68	111.947	20.49	20.69	PASS

NOTE: Directional gain = $6.3\text{dBi} + 10\log(2) = 9.31\text{dBi} > 6\text{dBi}$, so the limit shall be reduced to $24 - (9.31 - 6) = 20.69\text{dBm}$.

Chain 0:

1. $11\text{dBm} + 10\log (83.60) = 30.22 > 20.69\text{dBm}$
2. $11\text{dBm} + 10\log (40.42) = 27.07 > 20.69\text{dBm}$
3. $11\text{dBm} + 10\log (40.00) = 27.02 > 20.69\text{dBm}$
4. $11\text{dBm} + 10\log (84.50) = 30.27 > 20.69\text{dBm}$
5. $11\text{dBm} + 10\log (40.75) = 27.10 > 20.69\text{dBm}$

Chain 1:

1. $11\text{dBm} + 10\log (83.71) = 30.23 > 20.69\text{dBm}$
2. $11\text{dBm} + 10\log (40.48) = 27.07 > 20.69\text{dBm}$
3. $11\text{dBm} + 10\log (39.94) = 27.01 > 20.69\text{dBm}$
4. $11\text{dBm} + 10\log (83.66) = 30.23 > 20.69\text{dBm}$
5. $11\text{dBm} + 10\log (40.68) = 27.09 > 20.69\text{dBm}$

802.11ac (80MHz)

Chan.	Chan. Freq. (MHz)	Maximum Conducted Power (dBm)		Total Power (mW)	Total Power (dBm)	Power Limit (dBm)	Pass/Fail
		Chain 0	Chain 1				
58	5290	15.34	15.56	70.173	18.46	20.69	PASS
106	5530	14.90	14.95	62.164	17.94	20.69	PASS
122	5610	17.29	17.72	112.736	20.52	20.69	PASS

NOTE: Directional gain = $6.3\text{dBi} + 10\log(2) = 9.31\text{dBi} > 6\text{dBi}$, so the limit shall be reduced to $24 - (9.31 - 6) = 20.69\text{dBm}$.

Chain 0:

1. $11\text{dBm} + 10\log(83.80) = 30.23 > 20.69\text{dBm}$
2. $11\text{dBm} + 10\log(83.68) = 30.23 > 20.69\text{dBm}$
3. $11\text{dBm} + 10\log(136.42) = 32.35 > 20.69\text{dBm}$

Chain 1:

1. $11\text{dBm} + 10\log(83.93) = 30.24 > 20.69\text{dBm}$
2. $11\text{dBm} + 10\log(83.57) = 30.22 > 20.69\text{dBm}$
3. $11\text{dBm} + 10\log(141.81) = 32.52 > 20.69\text{dBm}$

4.4 Occupied Bandwidth Measurement

4.4.1 Test Setup



4.4.2 Test Instruments

Refer to section 4.1.2 to get information of above instrument.

4.4.3 Test Procedure

The transmitter output was connected to the spectrum analyzer through an attenuator. The bandwidth of the fundamental frequency was measured by spectrum analyzer with resolution bandwidth in the range of 1% to 5% of the anticipated emission bandwidth, and a video bandwidth at least 3x the resolution bandwidth and set the detector to SAMPLE. The width of a frequency band such that, below the lower and above the upper frequency limits, the mean powers emitted are each equal to a specified percentage 0.5 % of the total mean power of a given emission.

4.4.4 Test Results

CDD Mode (Mode A)

802.11a

Channel	Channel Frequency (MHz)	Occupied Bandwidth (MHz)	
		CHAIN 0	CHAIN 1
52	5260	19.80	19.44
60	5300	17.88	17.88
64	5320	17.04	17.16
100	5500	16.44	16.44
116	5580	16.44	16.44
132	5660	16.44	16.44
140	5700	16.44	16.44

802.11ac (20MHz)

Channel	Channel Frequency (MHz)	Occupied Bandwidth (MHz)	
		CHAIN 0	CHAIN 1
52	5260	19.20	19.08
60	5300	19.92	19.80
64	5320	18.12	18.12
100	5500	17.64	17.64
116	5580	17.64	17.64
132	5660	17.64	17.64
140	5700	17.64	17.64

802.11ac (40MHz)

Channel	Channel Frequency (MHz)	Occupied Bandwidth (MHz)	
		CHAIN 0	CHAIN 1
54	5270	41.40	39.00
62	5310	36.00	36.00
102	5510	35.80	35.80
110	5550	38.00	38.00
134	5670	36.00	36.20

802.11ac (80MHz)

Channel	Channel Frequency (MHz)	Occupied Bandwidth (MHz)	
		CHAIN 0	CHAIN 1
42	5210	75.84	75.84
58	5290	75.60	75.60
106	5530	75.84	76.08

Spectrum Plot of Worst Value

802.11a_Chain0 / CH52

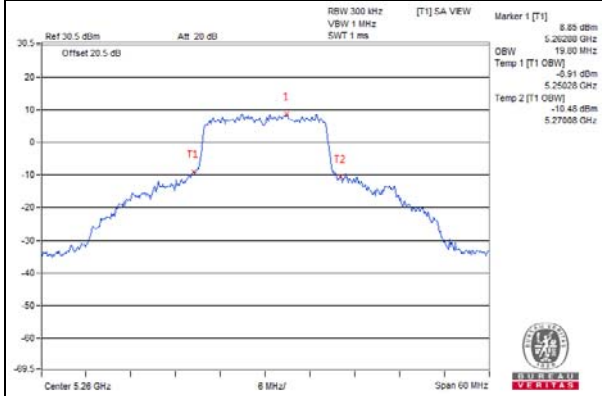

802.11ac (20MHz)_Chain0 / CH60

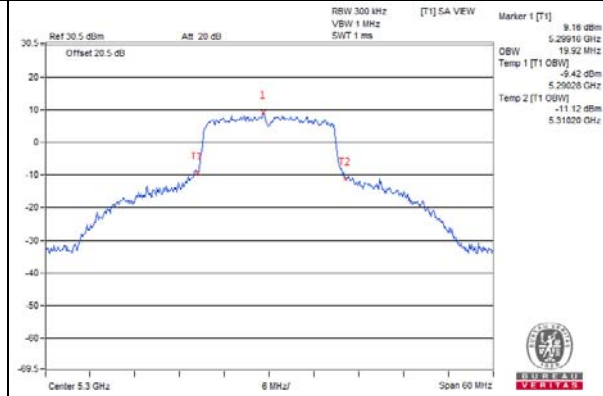

802.11ac (40MHz)_Chain0 / CH54

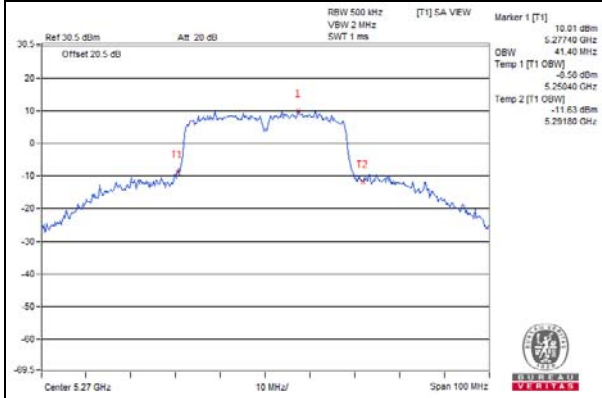

802.11ac (80MHz)_Chain1 / CH106

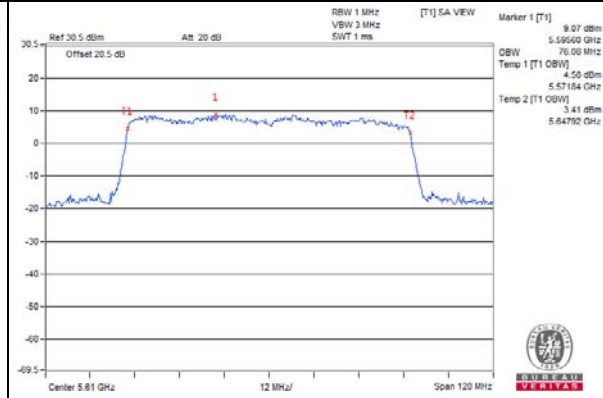

4.5 Peak Power Spectral Density Measurement

4.5.1 Limits of Peak Power Spectral Density Measurement

Operation Band	EUT Category		Limit
U-NII-1	---	Outdoor Access Point	17dBm/ MHz
	---	Fixed point-to-point Access Point	
	---	Indoor Access Point	
	---	Client device	11dBm/ MHz
U-NII-2A	√		11dBm/ MHz
U-NII-2C	√		11dBm/ MHz
U-NII-3	---		30dBm/ 500kHz

4.5.2 Test Setup

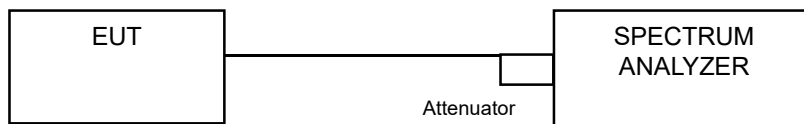

4.5.3 Test Instruments

Refer to section 4.1.2 to get information of above instrument.

4.5.4 Test Procedure

For U-NII-2A, U-NII-2C band:

Using method SA-1

- 1) Set span to encompass the entire emission bandwidth (EBW) of the signal.
- 2) Set RBW = 1 MHz, Set VBW ≥ 3 MHz, Detector = RMS
- 3) Sweep time = auto, trigger set to "free run".
- 4) Trace average at least 100 traces in power averaging mode.
- 5) Record the max value

4.5.5 Deviation from Test Standard

No deviation.

4.5.6 EUT Operating Condition

Same as Item 4.3.6.

4.5.7 Test Results

CDD Mode

802.11a

Chan.	Chan. Freq. (MHz)	PSD (dBm/MHz)		Duty Factor	Total Power Density (dBm/MHz)	MAX. Limit (dBm/MHz)	Pass / Fail
		Chain 0	Chain 1				
52	5260	4.46	4.47	0.15	7.62	7.69	Pass
60	5300	4.46	4.45	0.15	7.61	7.69	Pass
64	5320	3.97	3.93	0.15	7.11	7.69	Pass
100	5500	4.43	4.42	0.15	7.58	7.69	Pass
116	5580	4.45	4.50	0.15	7.63	7.69	Pass
132	5660	4.48	4.40	0.15	7.60	7.69	Pass
140	5700	4.47	4.47	0.15	7.63	7.69	Pass

Note:

- Method a) of power density measurement of KDB 662911 is using for calculating total power density. Total power density is summing entire spectra across corresponding frequency bins on the various outputs by computer.
- Refer to section 3.3 for duty cycle spectrum plot.
- Directional gain = $6.3\text{dBi} + 10\log(2) = 9.31\text{dBi} > 6\text{dBi}$, so the power density limit shall be reduced to $11 - (9.31 - 6) = 7.69\text{dBm}$.

802.11ac (20MHz)

Chan.	Chan. Freq. (MHz)	PSD (dBm/MHz)		Total Power Density (dBm/MHz)	MAX. Limit (dBm/MHz)	Pass / Fail
		Chain 0	Chain 1			
52	5260	4.54	4.58	7.57	7.69	Pass
60	5300	4.59	4.61	7.61	7.69	Pass
64	5320	4.00	4.08	7.05	7.69	Pass
100	5500	4.55	4.57	7.57	7.69	Pass
116	5580	4.44	4.50	7.48	7.69	Pass
132	5660	4.38	4.39	7.40	7.69	Pass
140	5700	4.34	4.37	7.37	7.69	Pass

- Note:**
- Method a) of power density measurement of KDB 662911 is using for calculating total power density. Total power density is summing entire spectra across corresponding frequency bins on the various outputs by computer.
 - Directional gain = $6.3\text{dBi} + 10\log(2) = 9.31\text{dBi} > 6\text{dBi}$, so the power density limit shall be reduced to $11 - (9.31 - 6) = 7.69\text{dBm}$.

802.11ac (40MHz)

Chan.	Chan. Freq. (MHz)	PSD (dBm/MHz)		Duty Factor	Total Power Density (dBm/MHz)	MAX. Limit (dBm/MHz)	Pass / Fail
		Chain 0	Chain 1				
54	5270	3.99	3.80	0.18	7.09	7.69	Pass
62	5310	-1.00	-1.04	0.18	2.17	7.69	Pass
102	5510	0.33	0.22	0.18	3.47	7.69	Pass
118	5590	4.29	4.43	0.18	7.55	7.69	Pass
134	5670	2.39	2.34	0.18	5.55	7.69	Pass

Note:

- Method a) of power density measurement of KDB 662911 is using for calculating total power density. Total power density is summing entire spectra across corresponding frequency bins on the various outputs by computer.
- Refer to section 3.3 for duty cycle spectrum plot.
- Directional gain = $6.3\text{dBi} + 10\log(2) = 9.31\text{dBi} > 6\text{dBi}$, so the power density limit shall be reduced to $11 - (9.31-6) = 7.69\text{dBm}$.

802.11ac (80MHz)

Chan.	Chan. Freq. (MHz)	PSD (dBm/MHz)		Duty Factor	Total Power Density (dBm/MHz)	MAX. Limit (dBm/MHz)	Pass / Fail
		Chain 0	Chain 1				
58	5290	-4.30	-4.89	0.42	-1.15	7.69	Pass
106	5530	-4.57	-4.65	0.42	-1.18	7.69	Pass
122	5610	-0.60	-0.57	0.42	2.85	7.69	Pass

Note:

- Method a) of power density measurement of KDB 662911 is using for calculating total power density. Total power density is summing entire spectra across corresponding frequency bins on the various outputs by computer.
- Refer to section 3.3 for duty cycle spectrum plot.
- Directional gain = $6.3\text{dBi} + 10\log(2) = 9.31\text{dBi} > 6\text{dBi}$, so the power density limit shall be reduced to $11 - (9.31-6) = 7.69\text{dBm}$.

Spectrum Plot of Worst Value

802.11a_Chain 1 / CH116

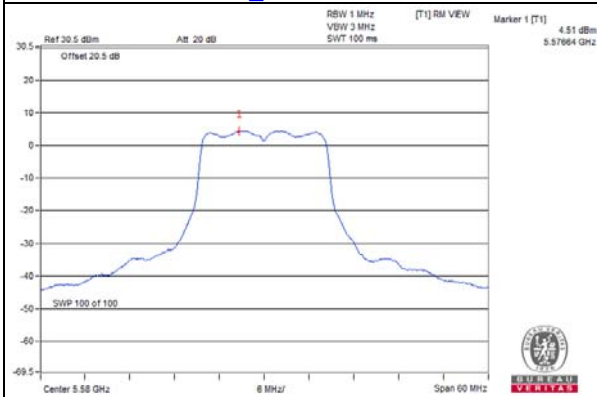

802.11ac (20MHz)_Chain 1 / CH60

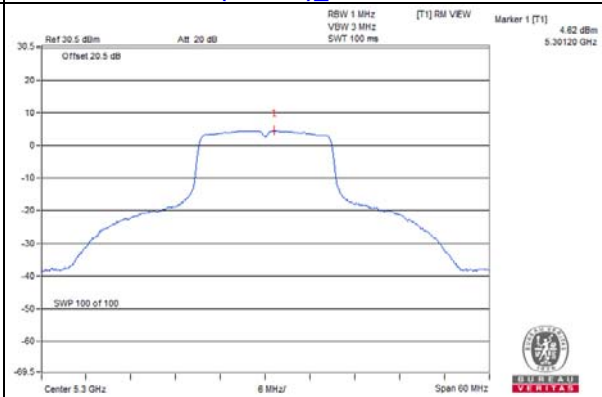

802.11ac (40MHz)_Chain 1 / CH110

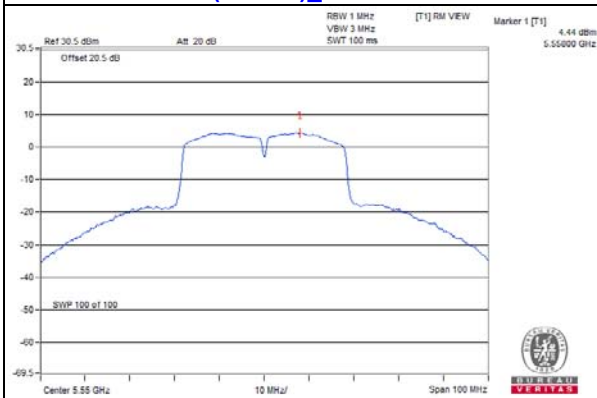

802.11ac (80MHz)_Chain 1 / CH122

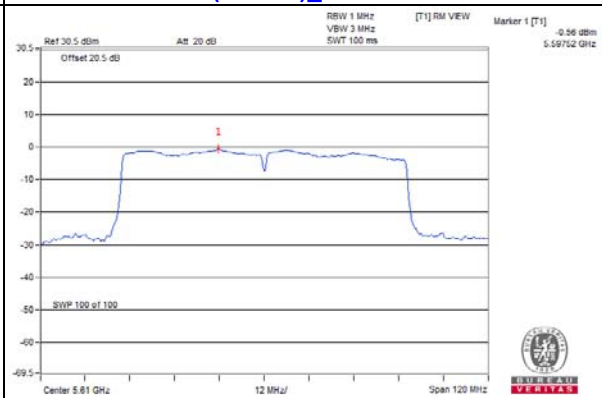

4.6 Frequency Stability Measurement

4.6.1 Limits of Frequency Stability Measurement

The frequency of the carrier signal shall be maintained within band of operation

4.6.2 Test Setup

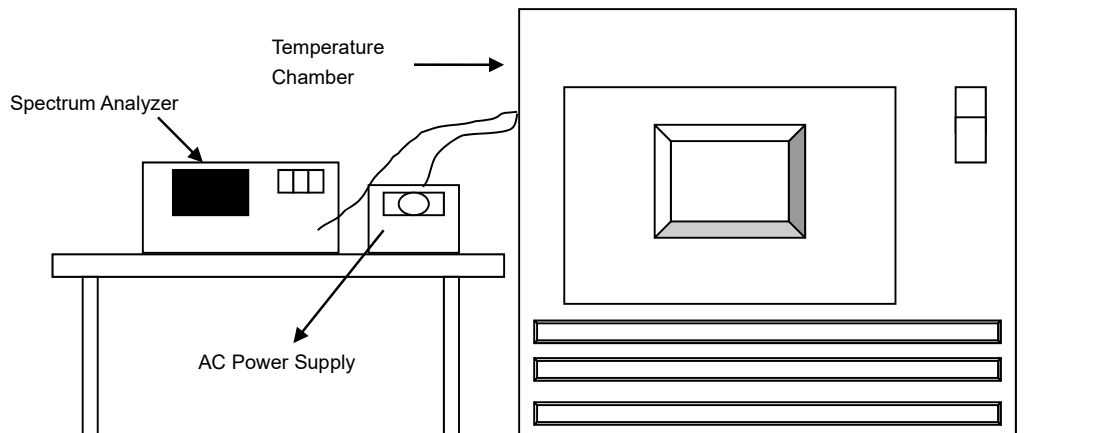

4.6.3 Test Instruments

Refer to section 4.1.2 to get information of above instrument.

4.6.4 Test Procedure

- The EUT was placed inside the environmental test chamber and powered by nominal AC voltage.
- Turn the EUT on and couple its output to a spectrum analyzer.
- Turn the EUT off and set the chamber to the highest temperature specified.
- Allow sufficient time (approximately 30 min) for the temperature of the chamber to stabilize, turn the EUT on and measure the operating frequency after 2, 5, and 10 Minutes.
- Repeat step 2 and 3 with the temperature chamber set to the lowest temperature.
- The test chamber was allowed to stabilize at +20 degree C for a minimum of 30 Minutes. The supply voltage was then adjusted on the EUT from 85% to 115% and the frequency record.

4.6.5 Deviation from Test Standard

No deviation.

4.6.6 EUT Operating Condition

Set the EUT transmit at un-modulation mode to test frequency stability.

4.6.7 Test Results

Frequency Stability Versus Temp.									
Operating Frequency: 5260 MHz									
TEMP. (°C)	Power Supply (Vac)	0 Minute		2 Minute		5 Minute		10 Minute	
		Measured Frequency (MHz)	Pass/Fail	Measured Frequency (MHz)	Pass/Fail	Measured Frequency (MHz)	Pass/Fail	Measured Frequency (MHz)	Pass/Fail
50	120	5259.9956	Pass	5259.9978	Pass	5259.9967	Pass	5259.9965	Pass
40	120	5259.9764	Pass	5259.9767	Pass	5259.9803	Pass	5259.9754	Pass
30	120	5259.9976	Pass	5259.9953	Pass	5259.9956	Pass	5259.9987	Pass
20	120	5260.021	Pass	5260.0172	Pass	5260.0195	Pass	5260.0201	Pass
10	120	5259.9978	Pass	5259.9984	Pass	5259.9988	Pass	5259.999	Pass
0	120	5259.9931	Pass	5259.9899	Pass	5259.993	Pass	5259.991	Pass
-10	120	5259.9875	Pass	5259.9872	Pass	5259.9872	Pass	5259.9901	Pass
-20	120	5259.9997	Pass	5260.0021	Pass	5260.0023	Pass	5260.0017	Pass
-30	120	5259.9989	Pass	5259.9973	Pass	5259.9998	Pass	5260.001	Pass

Frequency Stability Versus Voltage									
Operating Frequency: 5260 MHz									
TEMP. (°C)	Power Supply (Vac)	0 Minute		2 Minute		5 Minute		10 Minute	
		Measured Frequency (MHz)	Pass/Fail	Measured Frequency (MHz)	Pass/Fail	Measured Frequency (MHz)	Pass/Fail	Measured Frequency (MHz)	Pass/Fail
20	138	5260.0216	Pass	5260.0162	Pass	5260.0202	Pass	5260.0197	Pass
	120	5260.0210	Pass	5260.0172	Pass	5260.0195	Pass	5260.0201	Pass
	102	5260.0205	Pass	5260.0176	Pass	5260.0203	Pass	5260.021	Pass

5 Pictures of Test Arrangements

Please refer to the attached file (Test Setup Photo).

Appendix – Information on the Testing Laboratories

We, Bureau Veritas Consumer Products Services (H.K.) Ltd., Taoyuan Branch, were founded in 1988 to provide our best service in EMC, Radio, Telecom and Safety consultation. Our laboratories are FCC recognized accredited test firms and accredited according to ISO/IEC 17025.

If you have any comments, please feel free to contact us at the following:

Linkou EMC/RF Lab

Tel: 886-2-26052180

Fax: 886-2-26051924

Hsin Chu EMC/RF/Telecom Lab

Tel: 886-3-6668565

Fax: 886-3-6668323

Hwa Ya EMC/RF/Safety Lab

Tel: 886-3-3183232

Fax: 886-3-3270892

Email: service.adt@tw.bureauveritas.com

Web Site: www.bureauveritas-adt.com

The address and road map of all our labs can be found in our web site also.

--- END ---