

Test Report

Report No.: MTi230612006-05E1
Date of issue: 2023-07-14
Applicant: Guangzhou Havit Technology Co., Ltd.
Product: TWS earbuds
Model(s): TW958 Pro
FCC ID: 2A16I-TW958PRO

Shenzhen Microtest Co., Ltd.

<http://www.mtitest.com>

The test report is only used for customer scientific research, teaching, internal quality control and other purposes, and is for internal reference only.



Instructions

1. This test report shall not be partially reproduced without the written consent of the laboratory.
2. The test results in this test report are only responsible for the samples submitted
3. This test report is invalid without the seal and signature of the laboratory.
4. This test report is invalid if transferred, altered, or tampered with in any form without authorization.
5. Any objection to this test report shall be submitted to the laboratory within 15 days from the date of receipt of the report.

Table of contents

1	General Description	5
1.1	Description of the EUT	5
1.2	Description of test modes	5
1.3	Environmental Conditions	7
1.4	Description of support units	7
1.5	Measurement uncertainty	7
2	Summary of Test Result	8
3	Test Facilities and accreditations	9
3.1	Test laboratory	9
4	List of test equipment	10
5	Evaluation Results (Evaluation)	13
5.1	Antenna requirement	13
6	Radio Spectrum Matter Test Results (RF)	13
6.1	Occupied Bandwidth	13
6.2	Maximum Conducted Output Power	15
6.3	Channel Separation	16
6.4	Number of Hopping Frequencies	17
6.5	Dwell Time	18
6.6	Emissions in non-restricted frequency bands	19
6.7	Band edge emissions (Radiated)	20
6.8	Emissions in restricted frequency bands (below 1GHz)	25
6.9	Emissions in restricted frequency bands (above 1GHz)	28
	Photographs of the test setup	35
	Photographs of the EUT	36
	Appendix A: 20dB Emission Bandwidth	37
	Appendix B: Maximum conducted output power	40
	Appendix C: Carrier frequency separation	43
	Appendix D: Time of occupancy	45
	Appendix E: Number of hopping channels	50
	Appendix F: Band edge measurements	52
	Appendix G: Conducted Spurious Emission	55

Test Result Certification	
Applicant:	Guangzhou Havit Technology Co., Ltd.
Address:	ROOM 1307, 13F, PHASE 2 B, C BUILDING OF POLY WORLD TRADE CENTER, NO.1000, XINGANG EAST ROAD, HAIZHU GUANGDONG China
Manufacturer:	Guangzhou Havit Technology Co., Ltd.
Address:	ROOM 1307, 13F, PHASE 2 B, C BUILDING OF POLY WORLD TRADE CENTER, NO.1000, XINGANG EAST ROAD, HAIZHU GUANGDONG China
Product description	
Product name:	TWS earbuds
Trademark:	HAVIT
Model name:	TW958 Pro
Series Model:	N/A
Standards:	FCC 47 CFR Part 15 Subpart C
Test method:	ANSI C63.10-2013 KDB 558074 D01 15.247 Meas Guidance v05r02
Date of Test	
Date of test:	2023-07-03 to 2023-07-12
Test result:	Pass

Test Engineer	:	<i>Letter Lan</i>
		(Letter Lan)
Reviewed By	:	<i>Leon Chen</i>
		(Leon Chen)
Approved By	:	<i>Tom Xue</i>
		(Tom Xue)

1 General Description

1.1 Description of the EUT

Product name:	TWS earbuds
Model name:	TW958 Pro
Series Model:	N/A
Model difference:	N/A
Electrical rating:	5V/0.5A
Accessories:	Cable: cable: USB-A to USB-C 30cm
Hardware version:	V0.1
Software version:	2.0.1
Test sample(s) number:	MTi230612006-01S1001 MTi230612006-01S1002
RF specification	
Bluetooth version:	V5.3
Operating frequency range:	2402MHz to 2480MHz
Channel number:	79
Modulation type:	GFSK, $\pi/4$ DQPSK
Antenna(s) type:	ceramic antenna
Antenna(s) gain:	2dBi

1.2 Description of test modes

No.	Emission test modes
Mode1	TX-GFSK
Mode2	TX-Pi/4DQPSK

1.2.1 Operation channel list

Channel	Frequency (MHz)	Channel	Frequency (MHz)	Channel	Frequency (MHz)	Channel	Frequency (MHz)
0	2402	20	2422	40	2442	60	2462
1	2403	21	2423	41	2443	61	2463
2	2404	22	2424	42	2444	62	2464
3	2405	23	2425	43	2445	63	2465
4	2406	24	2426	44	2446	64	2466
5	2407	25	2427	45	2447	65	2467
6	2408	26	2428	46	2448	66	2468
7	2409	27	2429	47	2449	67	2469
8	2410	28	2430	48	2450	68	2470
9	2411	29	2431	49	2451	69	2471

10	2412	30	2432	50	2452	70	2472
11	2413	31	2433	51	2453	71	2473
12	2414	32	2434	52	2454	72	2474
13	2415	33	2435	53	2455	73	2475
14	2416	34	2436	54	2456	74	2476
15	2417	35	2437	55	2457	75	2477
16	2418	36	2438	56	2458	76	2478
17	2419	37	2439	57	2459	77	2479
18	2420	38	2440	58	2460	78	2480
19	2421	39	2441	59	2461	-	-

Note: The test software provided by manufacturer is used to control EUT for working in engineering mode, that enables selectable channel, and capable of continuous transmitting mode.

Test Software:

For power setting, refer to below table.

Mode	Test Software	FCC Assist 1.0.22		
	Channel	2402MHz	2441MHz	2480MHz
GFSK	Power setting	10	10	10
$\pi/4$ -DQPSK		10	10	10
8DPSK		10	10	10

1.3 Environmental Conditions

During the measurement the environmental conditions were within the listed ranges:

Temperature:	15°C ~ 35°C
Humidity:	20% RH ~ 75% RH
Atmospheric pressure:	98 kPa ~ 101 kPa

1.4 Description of support units

The EUT was tested as an independent device.

1.5 Measurement uncertainty

Measurement	Uncertainty
Occupied channel bandwidth	±3 %
RF output power, conducted	±1 dB
Time	±1 %
Unwanted Emissions, conducted	±1 dB
Radiated spurious emissions (1GHz~25GHz)	5.3dB
Radiated spurious emissions (9kHz~30MHz)	4.3dB
Radiated spurious emissions (30MHz~1GHz)	4.7dB
Temperature	±1 °C
Humidity	± 5 %

This uncertainty represents an expanded uncertainty expressed at approximately the 95% confidence level using a coverage factor of k=2.

2 Summary of Test Result

No.	FCC reference	Description of test	Result
1	§ 15.203	Antenna requirement	Pass
2	§ 15.207	AC power line conducted emissions	N/A
3	§ 15.247(d), 15.209, 15.205	Radiated spurious emissions	Pass
4	§ 15.247(a)(1)	20dB emission bandwidth	Pass
5	§ 15.247(b)(1)	Maximum conducted output power	Pass
6	§ 15.247(a)(1)	Carrier Frequencies Separation	Pass
7	§ 15.247(a)(1)	Time of occupancy	Pass
8	§ 15.247(a)(1)	Number of hopping channels	Pass
9	§ 15.247(d)	Band edge (Conducted)	Pass
10	§ 15.247(d)	Conducted spurious emissions	Pass

Notes:

N/A means not applicable.

Since the EUT cannot be operating while charging, therefore AC power line conducted emissions test is not required.

Both left and right earphones were tested, test data appendix only recorded all data of right earphones.

3 Test Facilities and accreditations

3.1 Test laboratory

Test laboratory:	Shenzhen Microtest Co., Ltd.
Test site location:	101, No.7, Zone 2, Xinxing Industrial Park, Fuhai Avenue, Xinhe Community, Fuhai Street, Bao'an District, Shenzhen, Guangdong, China
Telephone:	(86-755)88850135
Fax:	(86-755)88850136
CNAS Registration No.:	CNAS L5868
FCC Registration No.:	448573

4 List of test equipment

No.	Equipment	Manufacturer	Model	Serial No.	Cal. date	Cal. Due
Occupied Bandwidth						
1	Wideband Radio Communication Tester	Rohde&schwarz	CMW500	149155	2023-04-26	2024-04-25
2	ESG Series Analog Ssignal Generator	Agilent	E4421B	GB40051240	2023-04-25	2024-04-24
3	PXA Signal Analyzer	Agilent	N9030A	MY51350296	2023-04-25	2024-04-24
4	Synthesized Sweeper	Agilent	83752A	3610A01957	2023-04-25	2024-04-24
5	MXA Signal Analyzer	Agilent	N9020A	MY50143483	2023-04-26	2024-04-25
6	RF Control Unit	Tonscend	JS0806-1	19D8060152	2023-04-26	2024-04-25
7	Band Reject Filter Group	Tonscend	JS0806-F	19D8060160	2023-05-05	2024-05-04
8	ESG Vector Signal Generator	Agilent	N5182A	MY50143762	2023-04-25	2024-04-24
9	DC Power Supply	Agilent	E3632A	MY40027695	2023-05-05	2024-05-04
Maximum Conducted Output Power						
1	Wideband Radio Communication Tester	Rohde&schwarz	CMW500	149155	2023-04-26	2024-04-25
2	ESG Series Analog Ssignal Generator	Agilent	E4421B	GB40051240	2023-04-25	2024-04-24
3	PXA Signal Analyzer	Agilent	N9030A	MY51350296	2023-04-25	2024-04-24
4	Synthesized Sweeper	Agilent	83752A	3610A01957	2023-04-25	2024-04-24
5	MXA Signal Analyzer	Agilent	N9020A	MY50143483	2023-04-26	2024-04-25
6	RF Control Unit	Tonscend	JS0806-1	19D8060152	2023-04-26	2024-04-25
7	Band Reject Filter Group	Tonscend	JS0806-F	19D8060160	2023-05-05	2024-05-04
8	ESG Vector Signal Generator	Agilent	N5182A	MY50143762	2023-04-25	2024-04-24
9	DC Power Supply	Agilent	E3632A	MY40027695	2023-05-05	2024-05-04
Channel Separation						
1	Wideband Radio Communication Tester	Rohde&schwarz	CMW500	149155	2023-04-26	2024-04-25
2	ESG Series Analog Ssignal Generator	Agilent	E4421B	GB40051240	2023-04-25	2024-04-24
3	PXA Signal Analyzer	Agilent	N9030A	MY51350296	2023-04-25	2024-04-24
4	Synthesized Sweeper	Agilent	83752A	3610A01957	2023-04-25	2024-04-24
5	MXA Signal Analyzer	Agilent	N9020A	MY50143483	2023-04-26	2024-04-25
6	RF Control Unit	Tonscend	JS0806-1	19D8060152	2023-04-26	2024-04-25
7	Band Reject Filter Group	Tonscend	JS0806-F	19D8060160	2023-05-05	2024-05-04
8	ESG Vector Signal Generator	Agilent	N5182A	MY50143762	2023-04-25	2024-04-24

No.	Equipment	Manufacturer	Model	Serial No.	Cal. date	Cal. Due
9	DC Power Supply	Agilent	E3632A	MY40027695	2023-05-05	2024-05-04
Number of Hopping Frequencies						
1	Wideband Radio Communication Tester	Rohde&schwarz	CMW500	149155	2023-04-26	2024-04-25
2	ESG Series Analog Ssignal Generator	Agilent	E4421B	GB40051240	2023-04-25	2024-04-24
3	PXA Signal Analyzer	Agilent	N9030A	MY51350296	2023-04-25	2024-04-24
4	Synthesized Sweeper	Agilent	83752A	3610A01957	2023-04-25	2024-04-24
5	MXA Signal Analyzer	Agilent	N9020A	MY50143483	2023-04-26	2024-04-25
6	RF Control Unit	Tonscend	JS0806-1	19D8060152	2023-04-26	2024-04-25
7	Band Reject Filter Group	Tonscend	JS0806-F	19D8060160	2023-05-05	2024-05-04
8	ESG Vector Signal Generator	Agilent	N5182A	MY50143762	2023-04-25	2024-04-24
9	DC Power Supply	Agilent	E3632A	MY40027695	2023-05-05	2024-05-04
Dwell Time						
1	Wideband Radio Communication Tester	Rohde&schwarz	CMW500	149155	2023-04-26	2024-04-25
2	ESG Series Analog Ssignal Generator	Agilent	E4421B	GB40051240	2023-04-25	2024-04-24
3	PXA Signal Analyzer	Agilent	N9030A	MY51350296	2023-04-25	2024-04-24
4	Synthesized Sweeper	Agilent	83752A	3610A01957	2023-04-25	2024-04-24
5	MXA Signal Analyzer	Agilent	N9020A	MY50143483	2023-04-26	2024-04-25
6	RF Control Unit	Tonscend	JS0806-1	19D8060152	2023-04-26	2024-04-25
7	Band Reject Filter Group	Tonscend	JS0806-F	19D8060160	2023-05-05	2024-05-04
8	ESG Vector Signal Generator	Agilent	N5182A	MY50143762	2023-04-25	2024-04-24
9	DC Power Supply	Agilent	E3632A	MY40027695	2023-05-05	2024-05-04
Emissions in non-restricted frequency bands						
1	Wideband Radio Communication Tester	Rohde&schwarz	CMW500	149155	2023-04-26	2024-04-25
2	ESG Series Analog Ssignal Generator	Agilent	E4421B	GB40051240	2023-04-25	2024-04-24
3	PXA Signal Analyzer	Agilent	N9030A	MY51350296	2023-04-25	2024-04-24
4	Synthesized Sweeper	Agilent	83752A	3610A01957	2023-04-25	2024-04-24
5	MXA Signal Analyzer	Agilent	N9020A	MY50143483	2023-04-26	2024-04-25
6	RF Control Unit	Tonscend	JS0806-1	19D8060152	2023-04-26	2024-04-25
7	Band Reject Filter Group	Tonscend	JS0806-F	19D8060160	2023-05-05	2024-05-04
8	ESG Vector Signal Generator	Agilent	N5182A	MY50143762	2023-04-25	2024-04-24

No.	Equipment	Manufacturer	Model	Serial No.	Cal. date	Cal. Due
9	DC Power Supply	Agilent	E3632A	MY40027695	2023-05-05	2024-05-04
Band edge emissions (Radiated)						
1	EMI Test Receiver	Rohde&schwarz	ESCI7	101166	2023-04-26	2024-04-25
2	Double Ridged Broadband Horn Antenna	schwarabeck	BBHA 9120 D	2278	2023-05-26	2024-05-25
3	Amplifier	Agilent	8449B	3008A01120	2023-05-26	2024-05-25
4	Multi-device Controller	TuoPu	TPMDC	/	/	/
5	MXA signal analyzer	Agilent	N9020A	MY54440859	2023-05-05	2024-05-04
Emissions in restricted frequency bands (below 1GHz)						
1	EMI Test Receiver	Rohde&schwarz	ESCI7	101166	2023-04-26	2024-04-25
2	TRILOG Broadband Antenna	schwarabeck	VULB 9163	9163-1338	2023-06-11	2025-06-10
3	Amplifier	Hewlett-Packard	8447F	3113A06184	2023-04-26	2024-04-25
4	Multi-device Controller	TuoPu	TPMDC	/	/	/
Emissions in restricted frequency bands (above 1GHz)						
1	EMI Test Receiver	Rohde&schwarz	ESCI7	101166	2023-04-26	2024-04-25
2	Double Ridged Broadband Horn Antenna	schwarabeck	BBHA 9120 D	2278	2023-05-26	2024-05-25
3	Amplifier	Agilent	8449B	3008A01120	2023-05-26	2024-05-25
4	Multi-device Controller	TuoPu	TPMDC	/	/	/
5	MXA signal analyzer	Agilent	N9020A	MY54440859	2023-05-05	2024-05-04

5 Evaluation Results (Evaluation)

5.1 Antenna requirement

Test Requirement:	An intentional radiator shall be designed to ensure that no antenna other than that furnished by the responsible party shall be used with the device. The use of a permanently attached antenna or of an antenna that uses a unique coupling to the intentional radiator shall be considered sufficient to comply with the provisions of this section.
Description of the antenna of EUT:	The antenna of the EUT is permanently attached.
Conclusion:	The EUT complies with the requirement of FCC PART 15.203.

6 Radio Spectrum Matter Test Results (RF)

6.1 Occupied Bandwidth

Test Requirement:	Intentional radiators operating under the alternative provisions to the general emission limits, as contained in §§ 15.217 through 15.257 and in subpart E of this part, must be designed to ensure that the 20 dB bandwidth of the emission, or whatever bandwidth may otherwise be specified in the specific rule section under which the equipment operates, is contained within the frequency band designated in the rule section under which the equipment is operated.
Test Limit:	Intentional radiators operating under the alternative provisions to the general emission limits, as contained in §§ 15.217 through 15.257 and in subpart E of this part, must be designed to ensure that the 20 dB bandwidth of the emission, or whatever bandwidth may otherwise be specified in the specific rule section under which the equipment operates, is contained within the frequency band designated in the rule section under which the equipment is operated.
Test Method:	Occupied bandwidth—relative measurement procedure
Procedure:	<p>a) The spectrum analyzer center frequency is set to the nominal EUT channel center frequency. The span range for the EMI receiver or spectrum analyzer shall be between two times and five times the OBW.</p> <p>b) The nominal IF filter bandwidth (3 dB RBW) shall be in the range of 1% to 5% of the OBW and video bandwidth (VBW) shall be approximately three times RBW, unless otherwise specified by the applicable requirement.</p> <p>c) Set the reference level of the instrument as required, keeping the signal from exceeding the maximum input mixer level for linear operation. In general, the peak of the spectral envelope shall be more than $[10 \log (OBW/RBW)]$ below the reference level. Specific guidance is given in 4.1.5.2.</p> <p>d) Steps a) through c) might require iteration to adjust within the specified tolerances.</p> <p>e) The dynamic range of the instrument at the selected RBW shall be more than 10 dB below the target “-xx dB down” requirement; that is, if the requirement calls for measuring the -20 dB OBW, the instrument noise floor at the selected RBW shall be at least 30 dB below the reference value.</p> <p>f) Set detection mode to peak and trace mode to max hold.</p> <p>g) Determine the reference value: Set the EUT to transmit an unmodulated carrier or modulated signal, as applicable. Allow the trace to stabilize. Set the spectrum analyzer marker to the highest level of the displayed trace (this is the reference value).</p> <p>h) Determine the “-xx dB down amplitude” using $[(\text{reference value}) - xx]$. Alternatively, this calculation may be made by using the marker-delta function of the instrument.</p>

	<p>i) If the reference value is determined by an unmodulated carrier, then turn the EUT modulation ON, and either clear the existing trace or start a new trace on the spectrum analyzer and allow the new trace to stabilize. Otherwise, the trace from step g) shall be used for step j).</p> <p>j) Place two markers, one at the lowest frequency and the other at the highest frequency of the envelope of the spectral display, such that each marker is at or slightly below the “-xx dB down amplitude” determined in step h). If a marker is below this “-xx dB down amplitude” value, then it shall be as close as possible to this value. The occupied bandwidth is the frequency difference between the two markers. Alternatively, set a marker at the lowest frequency of the envelope of the spectral display, such that the marker is at or slightly below the “-xx dB down amplitude” determined in step h). Reset the marker-delta function and move the marker to the other side of the emission until the delta marker amplitude is at the same level as the reference marker amplitude. The marker-delta frequency reading at this point is the specified emission bandwidth.</p> <p>k) The occupied bandwidth shall be reported by providing plot(s) of the measuring instrument display; the plot axes and the scale units per division shall be clearly labeled. Tabular data may be reported in addition to the plot(s).</p>
--	--

6.1.1 E.U.T. Operation:

Operating Environment:			
Temperature:	25 °C	Humidity:	56 %
Pre test mode:	Mode1, Mode2,		
Final test mode:	Mode1, Mode2		

6.1.2 Test Data:

Please Refer to Appendix for Details.

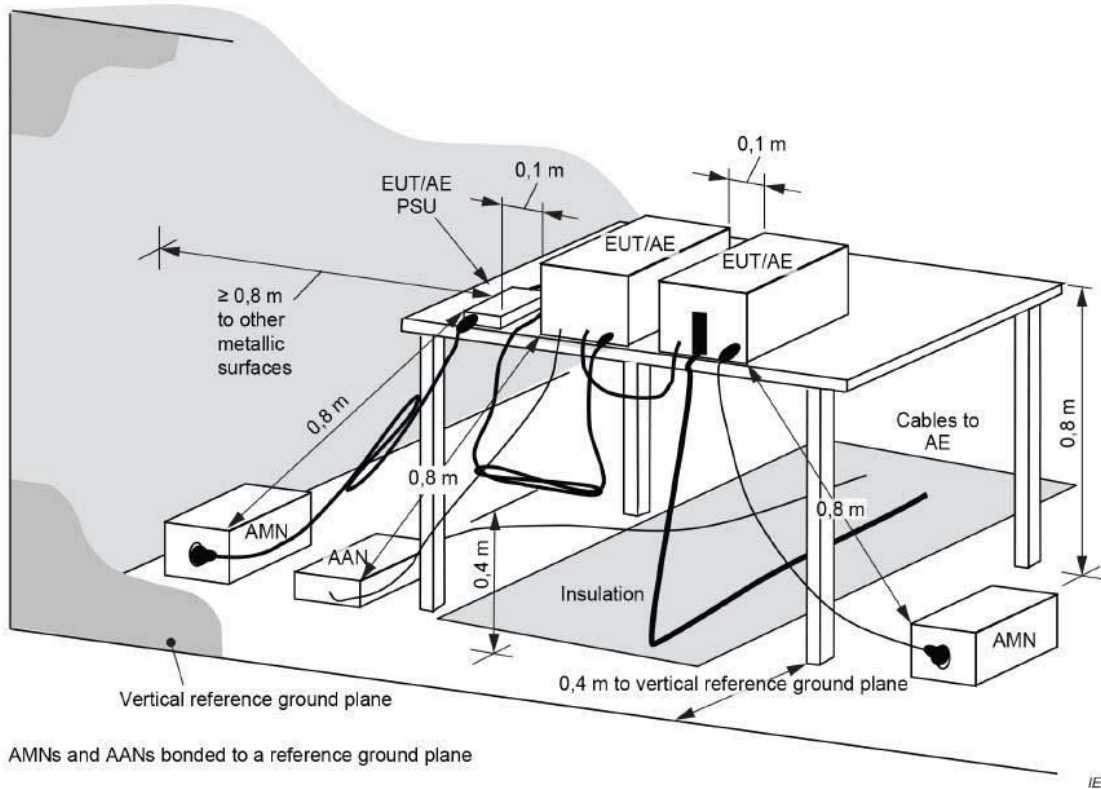

6.2 Maximum Conducted Output Power

Test Requirement:	For frequency hopping systems operating in the 2400-2483.5 MHz band employing at least 75 non-overlapping hopping channels, and all frequency hopping systems in the 5725-5850 MHz band: 1 watt. For all other frequency hopping systems in the 2400-2483.5 MHz band: 0.125 watts.
Test Limit:	For frequency hopping systems operating in the 2400-2483.5 MHz band employing at least 75 non-overlapping hopping channels, and all frequency hopping systems in the 5725-5850 MHz band: 1 watt. For all other frequency hopping systems in the 2400-2483.5 MHz band: 0.125 watts.
Test Method:	Output power test procedure for frequency-hopping spread-spectrum (FHSS) devices
Procedure:	<p>This is an RF-conducted test to evaluate maximum peak output power. Use a direct connection between the antenna port of the unlicensed wireless device and the spectrum analyzer, through suitable attenuation. The hopping shall be disabled for this test:</p> <p>a) Use the following spectrum analyzer settings:</p> <ol style="list-style-type: none"> 1) Span: Approximately five times the 20 dB bandwidth, centered on a hopping channel. 2) RBW > 20 dB bandwidth of the emission being measured. 3) VBW >= RBW. 4) Sweep: Auto. 5) Detector function: Peak. 6) Trace: Max hold. <p>b) Allow trace to stabilize.</p> <p>c) Use the marker-to-peak function to set the marker to the peak of the emission.</p> <p>d) The indicated level is the peak output power, after any corrections for external attenuators and cables.</p> <p>e) A plot of the test results and setup description shall be included in the test report.</p> <p>NOTE—A peak responding power meter may be used, where the power meter and sensor system video bandwidth is greater than the occupied bandwidth of the unlicensed wireless device, rather than a spectrum analyzer.</p>

6.2.1 E.U.T. Operation:

Operating Environment:					
Temperature:	25 °C	Humidity:	56 %	Atmospheric Pressure:	101 kPa
Pre test mode:	Mode1, Mode2,				
Final test mode:	Mode1, Mode2,				

6.2.2 Test Data:

Please Refer to Appendix for Details.

6.3 Channel Separation

Test Requirement:	Frequency hopping systems shall have hopping channel carrier frequencies separated by a minimum of 25 kHz or the 20 dB bandwidth of the hopping channel, whichever is greater. Alternatively, frequency hopping systems operating in the 2400-2483.5 MHz band may have hopping channel carrier frequencies that are separated by 25 kHz or two-thirds of the 20 dB bandwidth of the hopping channel, whichever is greater, provided the systems operate with an output power no greater than 125 mW.
Test Limit:	Frequency hopping systems shall have hopping channel carrier frequencies separated by a minimum of 25 kHz or the 20 dB bandwidth of the hopping channel, whichever is greater. Alternatively, frequency hopping systems operating in the 2400-2483.5 MHz band may have hopping channel carrier frequencies that are separated by 25 kHz or two-thirds of the 20 dB bandwidth of the hopping channel, whichever is greater, provided the systems operate with an output power no greater than 125 mW.
Test Method:	Carrier frequency separation
Procedure:	<p>The EUT shall have its hopping function enabled. Use the following spectrum analyzer settings:</p> <ul style="list-style-type: none"> a) Span: Wide enough to capture the peaks of two adjacent channels. b) RBW: Start with the RBW set to approximately 30% of the channel spacing; adjust as necessary to best identify the center of each individual channel. c) Video (or average) bandwidth (VBW) \geq RBW. d) Sweep: Auto. e) Detector function: Peak. f) Trace: Max hold. g) Allow the trace to stabilize. <p>Use the marker-delta function to determine the separation between the peaks of the adjacent channels. Compliance of an EUT with the appropriate regulatory limit shall be determined. A plot of the data shall be included in the test report.</p>

6.3.1 E.U.T. Operation:

Operating Environment:					
Temperature:	25 °C	Humidity:	56 %	Atmospheric Pressure:	101 kPa
Pre test mode:	Mode1, Mode2,				
Final test mode:	Mode1, Mode2,				

6.3.2 Test Data:

Please Refer to Appendix for Details.

6.4 Number of Hopping Frequencies

Test Requirement:	Frequency hopping systems in the 2400-2483.5 MHz band shall use at least 15 channels. The average time of occupancy on any channel shall not be greater than 0.4 seconds within a period of 0.4 seconds multiplied by the number of hopping channels employed. Frequency hopping systems may avoid or suppress transmissions on a particular hopping frequency provided that a minimum of 15 channels are used.
Test Limit:	Frequency hopping systems in the 2400-2483.5 MHz band shall use at least 15 channels. The average time of occupancy on any channel shall not be greater than 0.4 seconds within a period of 0.4 seconds multiplied by the number of hopping channels employed. Frequency hopping systems may avoid or suppress transmissions on a particular hopping frequency provided that a minimum of 15 channels are used.
Test Method:	Number of hopping frequencies
Procedure:	<p>The EUT shall have its hopping function enabled. Use the following spectrum analyzer settings:</p> <ul style="list-style-type: none"> a) Span: The frequency band of operation. Depending on the number of channels the device supports, it may be necessary to divide the frequency range of operation across multiple spans, to allow the individual channels to be clearly seen. b) RBW: To identify clearly the individual channels, set the RBW to less than 30% of the channel spacing or the 20 dB bandwidth, whichever is smaller. c) VBW \geq RBW. d) Sweep: Auto. e) Detector function: Peak. f) Trace: Max hold. g) Allow the trace to stabilize. <p>It might prove necessary to break the span up into subranges to show clearly all of the hopping frequencies. Compliance of an EUT with the appropriate regulatory limit shall be determined for the number of hopping channels. A plot of the data shall be included in the test report.</p>

6.4.1 E.U.T. Operation:

Operating Environment:					
Temperature:	25 °C	Humidity:	56 %	Atmospheric Pressure:	101 kPa
Pre test mode:	Mode1, Mode2,				
Final test mode:	Mode1, Mode2,				

6.4.2 Test Data:

Please Refer to Appendix for Details.

6.5 Dwell Time

Test Requirement:	Frequency hopping systems in the 2400-2483.5 MHz band shall use at least 15 channels. The average time of occupancy on any channel shall not be greater than 0.4 seconds within a period of 0.4 seconds multiplied by the number of hopping channels employed. Frequency hopping systems may avoid or suppress transmissions on a particular hopping frequency provided that a minimum of 15 channels are used.
Test Limit:	Frequency hopping systems in the 2400-2483.5 MHz band shall use at least 15 channels. The average time of occupancy on any channel shall not be greater than 0.4 seconds within a period of 0.4 seconds multiplied by the number of hopping channels employed. Frequency hopping systems may avoid or suppress transmissions on a particular hopping frequency provided that a minimum of 15 channels are used.
Test Method:	Time of occupancy (dwell time)
Procedure:	<p>The EUT shall have its hopping function enabled. Use the following spectrum analyzer settings:</p> <p>a) Span: Zero span, centered on a hopping channel.</p> <p>b) RBW shall be \leq channel spacing and where possible RBW should be set $\gg 1 / T$, where T is the expected dwell time per channel.</p> <p>c) Sweep: As necessary to capture the entire dwell time per hopping channel; where possible use a video trigger and trigger delay so that the transmitted signal starts a little to the right of the start of the plot. The trigger level might need slight adjustment to prevent triggering when the system hops on an adjacent channel; a second plot might be needed with a longer sweep time to show two successive hops on a channel.</p> <p>d) Detector function: Peak.</p> <p>e) Trace: Max hold.</p> <p>Use the marker-delta function to determine the transmit time per hop. If this value varies with different modes of operation (data rate, modulation format, number of hopping channels, etc.), then repeat this test for each variation in transmit time.</p> <p>Repeat the measurement using a longer sweep time to determine the number of hops over the period specified in the requirements. The sweep time shall be equal to, or less than, the period specified in the requirements. Determine the number of hops over the sweep time and calculate the total number of hops in the period specified in the requirements, using the following equation:</p> $(\text{Number of hops in the period specified in the requirements}) = (\text{number of hops on spectrum analyzer}) \times (\text{period specified in the requirements} / \text{analyzer sweep time})$ <p>The average time of occupancy is calculated from the transmit time per hop multiplied by the number of hops in the period specified in the requirements. If the number of hops in a specific time varies with different modes of operation (data rate, modulation format, number of hopping channels, etc.), then repeat this test for each variation.</p> <p>The measured transmit time and time between hops shall be consistent with the values described in the operational description for the EUT.</p>

6.5.1 E.U.T. Operation:

Operating Environment:					
Temperature:	25 °C	Humidity:	56 %	Atmospheric Pressure:	101 kPa
Pre test mode:	Mode1, Mode2,				
Final test mode:	Mode1, Mode2,				

6.5.2 Test Data:

Please Refer to Appendix for Details.

6.6 Emissions in non-restricted frequency bands

Test Requirement:	In any 100 kHz bandwidth outside the frequency band in which the spread spectrum or digitally modulated intentional radiator is operating, the radio frequency power that is produced by the intentional radiator shall be at least 20 dB below that in the 100 kHz bandwidth within the band that contains the highest level of the desired power, based on either an RF conducted or a radiated measurement, provided the transmitter demonstrates compliance with the peak conducted power limits. If the transmitter complies with the conducted power limits based on the use of RMS averaging over a time interval, as permitted under paragraph (b)(3) of this section, the attenuation required under this paragraph shall be 30 dB instead of 20 dB. Attenuation below the general limits specified in § 15.209(a) is not required.
Test Limit:	In any 100 kHz bandwidth outside the frequency band in which the spread spectrum or digitally modulated intentional radiator is operating, the radio frequency power that is produced by the intentional radiator shall be at least 20 dB below that in the 100 kHz bandwidth within the band that contains the highest level of the desired power, based on either an RF conducted or a radiated measurement, provided the transmitter demonstrates compliance with the peak conducted power limits. If the transmitter complies with the conducted power limits based on the use of RMS averaging over a time interval, as permitted under paragraph (b)(3) of this section, the attenuation required under this paragraph shall be 30 dB instead of 20 dB. Attenuation below the general limits specified in § 15.209(a) is not required.
Test Method:	Conducted spurious emissions test methodology
Procedure:	Conducted spurious emissions shall be measured for the transmit frequency, per 5.5 and 5.6, and at the maximum transmit powers. Connect the primary antenna port through an attenuator to the spectrum analyzer input; in the results, account for all losses between the unlicensed wireless device output and the spectrum analyzer. The instrument shall span 30 MHz to 10 times the operating frequency in GHz, with a resolution bandwidth of 100 kHz, video bandwidth of 300 kHz, and a coupled sweep time with a peak detector. The band 30 MHz to the highest frequency may be split into smaller spans, as long as the entire spectrum is covered.

6.6.1 E.U.T. Operation:

Operating Environment:					
Temperature:	25 °C	Humidity:	56 %	Atmospheric Pressure:	101 kPa
Pre test mode:	Mode1, Mode2,				
Final test mode:	Mode1, Mode2,				

6.6.2 Test Data:

Please Refer to Appendix for Details.

6.7 Band edge emissions (Radiated)

Test Requirement:	In addition, radiated emissions which fall in the restricted bands, as defined in § 15.205(a), must also comply with the radiated emission limits specified in § 15.209(a)(see § 15.205(c)).		
Test Limit:	Frequency (MHz)	Field strength (microvolts/meter)	Measurement distance (meters)
	0.009-0.490	2400/F(kHz)	300
	0.490-1.705	24000/F(kHz)	30
	1.705-30.0	30	30
	30-88	100 **	3
	88-216	150 **	3
	216-960	200 **	3
	Above 960	500	3
	** Except as provided in paragraph (g), fundamental emissions from intentional radiators operating under this section shall not be located in the frequency bands 54-72 MHz, 76-88 MHz, 174-216 MHz or 470-806 MHz. However, operation within these frequency bands is permitted under other sections of this part, e.g., §§ 15.231 and 15.241.		
Test Method:	Radiated emissions tests		
Procedure:	ANSI C63.10-2013 section 6.10.5.2		

6.7.1 E.U.T. Operation:

Operating Environment:			
Temperature:	24 °C	Humidity:	57 %
		Atmospheric Pressure:	101 kPa
Pre test mode:	Mode1, Mode2,		
Final test mode:	All of the listed pre-test mode were tested, only the data of the worst mode (Mode2) is recorded in the report		

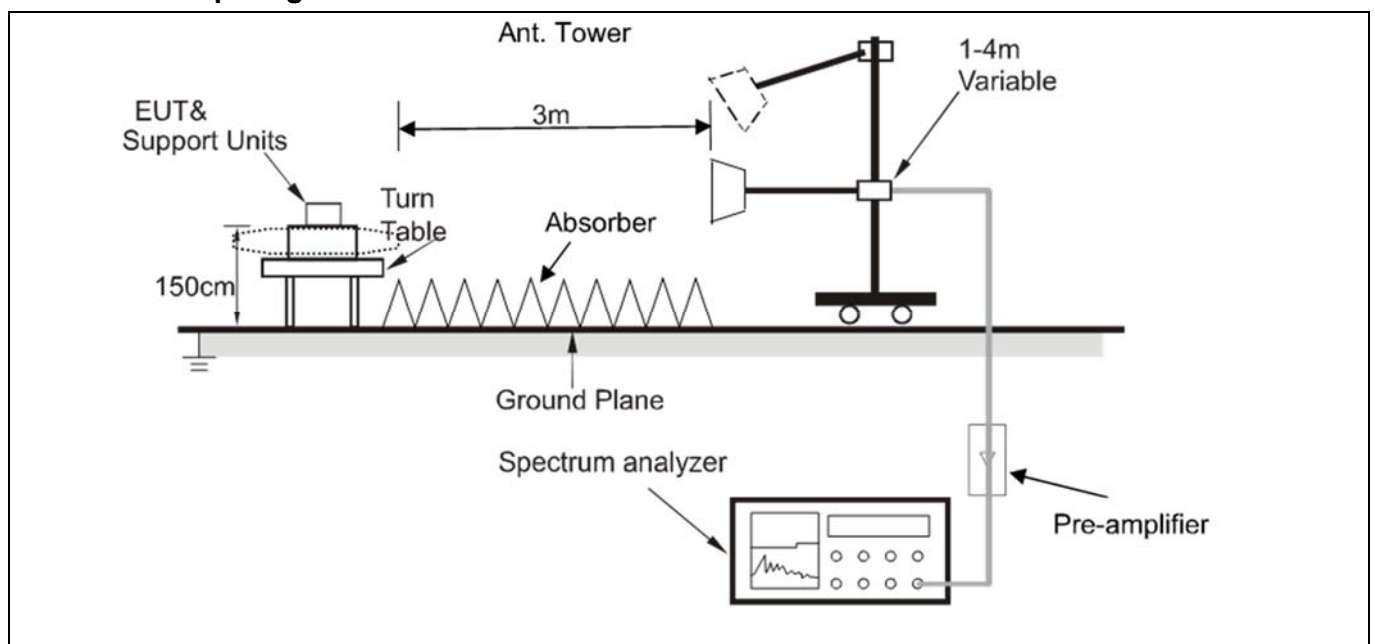
6.7.2 Test Setup Diagram:

6.7.3 Test Data:

Left earphone:

Mode2 / Polarization: Horizontal / Band: 2.4G / BW: 1 / CH: 2402

No.	Mk.	Freq.	Reading Level	Correct Factor	Measurement	Limit	Over	
		MHz	dBuV	dB	dBuV/m	dBuV/m	dB	Detector
1		2310.000	47.61	-8.08	39.53	74.00	-34.47	peak
2		2310.000	37.37	-8.08	29.29	54.00	-24.71	AVG
3		2390.000	51.26	-7.71	43.55	74.00	-30.45	peak
4	*	2390.000	39.82	-7.71	32.11	54.00	-21.89	AVG

Mode2 / Polarization: Vertical / Band: 2.4G / BW: 1 / CH: 2402

No.	Mk.	Freq.	Reading Level	Correct Factor	Measurement	Limit	Over	
		MHz	dBuV	dB	dBuV/m	dBuV/m	dB	Detector
1		2310.000	48.48	-8.08	40.40	74.00	-33.60	peak
2		2310.000	37.44	-8.08	29.36	54.00	-24.64	AVG
3		2390.000	49.66	-7.71	41.95	74.00	-32.05	peak
4	*	2390.000	38.61	-7.71	30.90	54.00	-23.10	AVG

Left earphone:

Mode2 / Polarization: Horizontal / Band: 2.4G / BW: 1 / CH: 2480

No.	Mk.	Freq.	Reading Level	Correct Factor	Measurement	Limit	Over	Detector
		MHz	dBuV	dB	dBuV/m	dBuV/m	dB	
1	*	2483.500	61.06	-7.24	53.82	74.00	-20.18	peak
2		2483.500	40.10	-7.24	32.86	54.00	-21.14	AVG
3		2500.000	50.57	-7.17	43.40	74.00	-30.60	peak
4		2500.000	39.27	-7.17	32.10	54.00	-21.90	AVG

Mode2 / Polarization: Vertical / Band: 2.4G / BW: 1 / CH: 2480

No.	Mk.	Freq.	Reading Level	Correct Factor	Measurement	Limit	Over	Detector
		MHz	dBuV	dB	dBuV/m	dBuV/m	dB	
1		2483.500	56.29	-7.24	49.05	74.00	-24.95	peak
2	*	2483.500	38.70	-7.24	31.46	54.00	-22.54	AVG
3		2500.000	49.76	-7.17	42.59	74.00	-31.41	peak
4		2500.000	38.29	-7.17	31.12	54.00	-22.88	AVG

Right earphone:

Mode2 / Polarization: Horizontal / Band: 2.4G / BW: 1 / CH: 2402

No.	Mk.	Freq.	Reading Level	Correct Factor	Measurement	Limit	Over	
		MHz	dBuV	dB	dBuV/m	dBuV/m	dB	Detector
1		2310.000	47.50	-8.08	39.42	74.00	-34.58	peak
2		2310.000	36.48	-8.08	28.40	54.00	-25.60	AVG
3		2390.000	50.34	-7.71	42.63	74.00	-31.37	peak
4	*	2390.000	38.33	-7.71	30.62	54.00	-23.38	AVG

Mode2 / Polarization: Vertical / Band: 2.4G / BW: 1 / CH: 2402

No.	Mk.	Freq.	Reading Level	Correct Factor	Measurement	Limit	Over	
		MHz	dBuV	dB	dBuV/m	dBuV/m	dB	Detector
1		2310.000	47.48	-8.08	39.40	74.00	-34.60	peak
2		2310.000	36.48	-8.08	28.40	54.00	-25.60	AVG
3		2390.000	48.66	-7.71	40.95	74.00	-33.05	peak
4	*	2390.000	37.74	-7.71	30.03	54.00	-23.97	AVG

Right earphone:

Mode2 / Polarization: Horizontal / Band: 2.4G / BW: 1 / CH: 2480

No.	Mk.	Freq.	Reading Level	Correct Factor	Measurement	Limit	Over	Detector
		MHz	dBuV	dB	dBuV/m	dBuV/m	dB	
1	*	2483.500	59.69	-7.24	52.45	74.00	-21.55	peak
2		2483.500	38.95	-7.24	31.71	54.00	-22.29	AVG
3		2500.000	50.35	-7.17	43.18	74.00	-30.82	peak
4		2500.000	38.84	-7.17	31.67	54.00	-22.33	AVG

Mode2 / Polarization: Vertical / Band: 2.4G / BW: 1 / CH: 2480

No.	Mk.	Freq.	Reading Level	Correct Factor	Measurement	Limit	Over	Detector
		MHz	dBuV	dB	dBuV/m	dBuV/m	dB	
1		2483.500	54.79	-7.24	47.55	74.00	-26.45	peak
2		2483.500	37.20	-7.24	29.96	54.00	-24.04	AVG
3		2500.000	49.26	-7.17	42.09	74.00	-31.91	peak
4	*	2500.000	37.79	-7.17	30.62	54.00	-23.38	AVG

6.8 Emissions in restricted frequency bands (below 1GHz)

Test Requirement:	In addition, radiated emissions which fall in the restricted bands, as defined in § 15.205(a), must also comply with the radiated emission limits specified in § 15.209(a)(see § 15.205(c)).`		
Test Limit:	Frequency (MHz)	Field strength (microvolts/meter)	Measurement distance (meters)
	0.009-0.490	2400/F(kHz)	300
	0.490-1.705	24000/F(kHz)	30
	1.705-30.0	30	30
	30-88	100 **	3
	88-216	150 **	3
	216-960	200 **	3
	Above 960	500	3
	** Except as provided in paragraph (g), fundamental emissions from intentional radiators operating under this section shall not be located in the frequency bands 54-72 MHz, 76-88 MHz, 174-216 MHz or 470-806 MHz. However, operation within these frequency bands is permitted under other sections of this part, e.g., §§ 15.231 and 15.241.		
Test Method:	Radiated emissions tests		
Procedure:	ANSI C63.10-2013 section 6.6.4		

6.8.1 E.U.T. Operation:

Operating Environment:			
Temperature:	26 °C	Humidity:	56 %
		Atmospheric Pressure:	101 kPa
Pre test mode:	Mode1, Mode2,		
Final test mode:	All of the listed pre-test mode were tested, only the data of the worst mode (Mode2) is recorded in the report		

6.8.2 Test Setup Diagram:

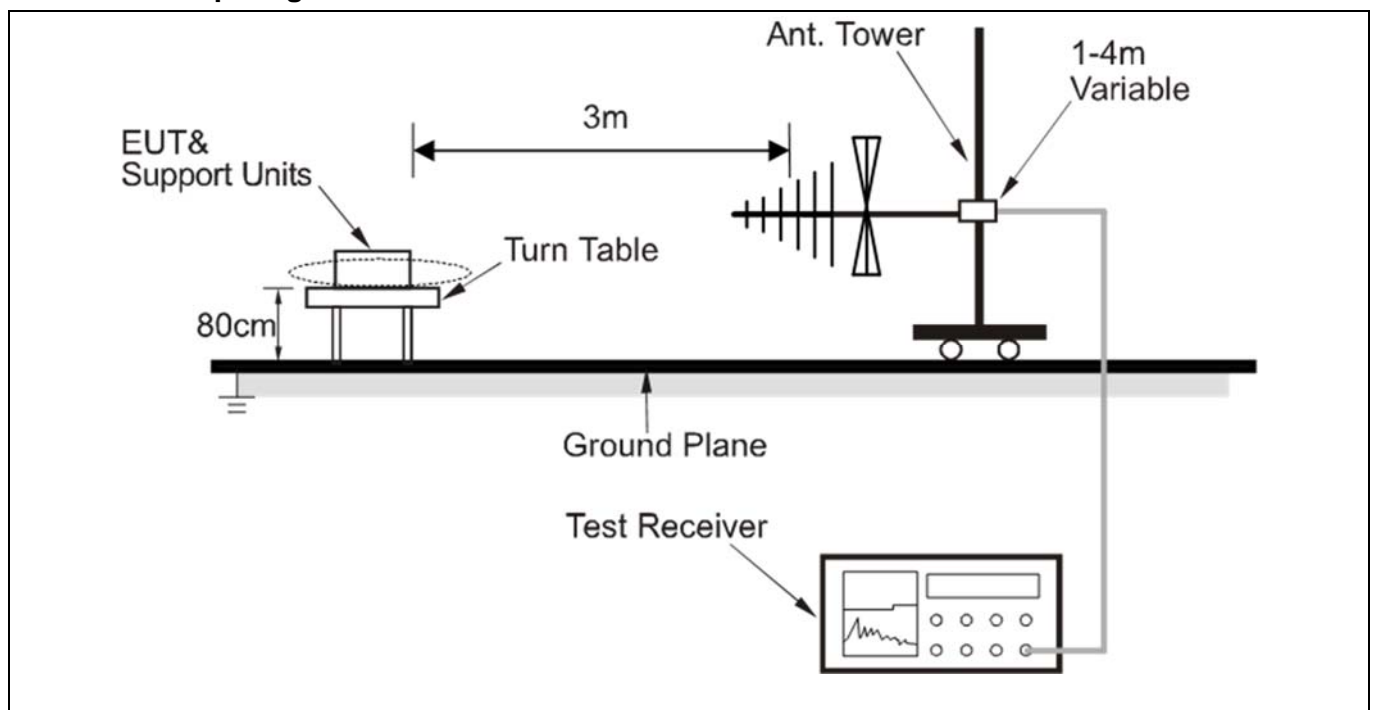

6.8.3 Test Data:

Left earphone:

Mode2 / Polarization: Horizontal / Band: 2.4G / BW: 1 / CH: 2402

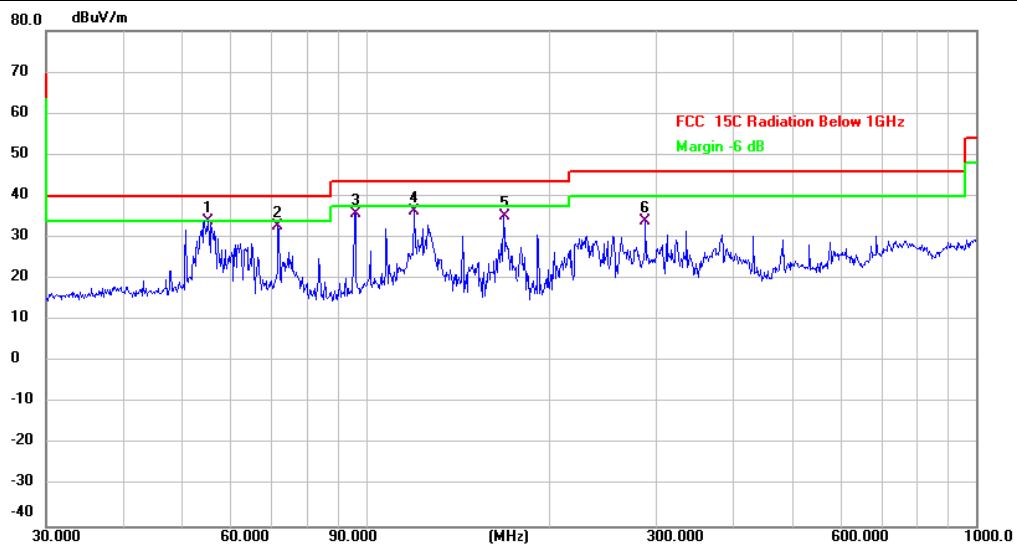

No.	Mk.	Freq. MHz	Reading Level dBuV	Correct Factor dB	Measure- ment dBuV/m	Limit dBuV/m	Over dB	Detector	Comment
1	*	55.2207	41.20	-7.16	34.04	40.00	-5.96	QP	
2		71.8320	42.89	-10.04	32.85	40.00	-7.15	QP	
3		96.0986	43.93	-8.13	35.80	43.50	-7.70	QP	
4		119.8556	46.43	-10.20	36.23	43.50	-7.27	QP	
5		167.8243	46.82	-11.57	35.25	43.50	-8.25	QP	
6		287.9904	40.74	-6.67	34.07	46.00	-11.93	QP	

Mode2 / Polarization: Vertical / Band: 2.4G / BW: 1 / CH: 2402

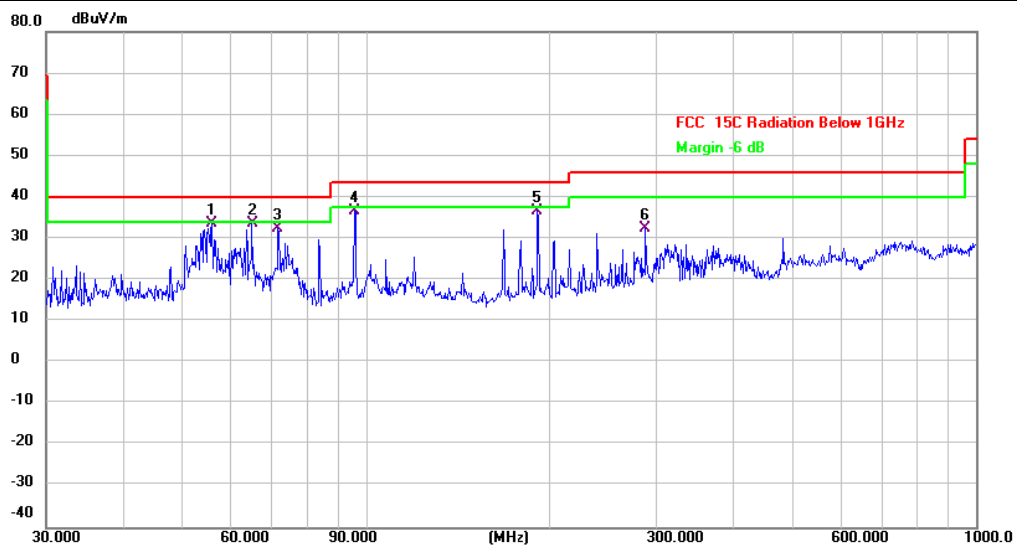

No.	Mk.	Freq. MHz	Reading Level dBuV	Correct Factor dB	Measure- ment dBuV/m	Limit dBuV/m	Over dB	Detector	Comment
1		56.0007	40.65	-7.09	33.56	40.00	-6.44	QP	
2	*	65.1145	41.96	-8.26	33.70	40.00	-6.30	QP	
3		71.8320	42.60	-10.04	32.56	40.00	-7.44	QP	
4		95.7622	44.97	-8.21	36.76	43.50	-6.74	QP	
5		191.7450	45.96	-9.41	36.55	43.50	-6.95	QP	
6		287.9904	39.12	-6.67	32.45	46.00	-13.55	QP	

Right earphone:

Mode2 / Polarization: Horizontal / Band: 2.4G / BW: 1 / CH: 2402

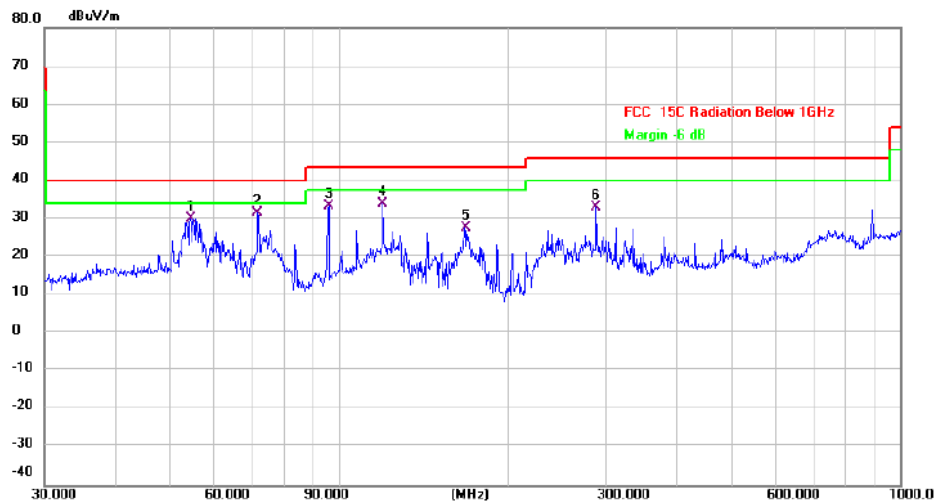

No.	Mk.	Freq. MHz	Reading Level dBuV	Correct Factor dB	Measure- ment dBuV/m	Limit dBuV/m	Over dB	Detector	Comment
1		54.4516	37.38	-7.22	30.16	40.00	-9.84	QP	
2	*	71.8320	41.62	-10.04	31.58	40.00	-8.42	QP	
3		96.0986	41.49	-8.13	33.36	43.50	-10.14	QP	
4		119.8556	44.14	-10.20	33.94	43.50	-9.56	QP	
5		167.8243	39.14	-11.57	27.57	43.50	-15.93	QP	
6		287.9904	39.83	-6.67	33.16	46.00	-12.84	QP	

Mode2 / Polarization: Vertical / Band: 2.4G / BW: 1 / CH: 2402

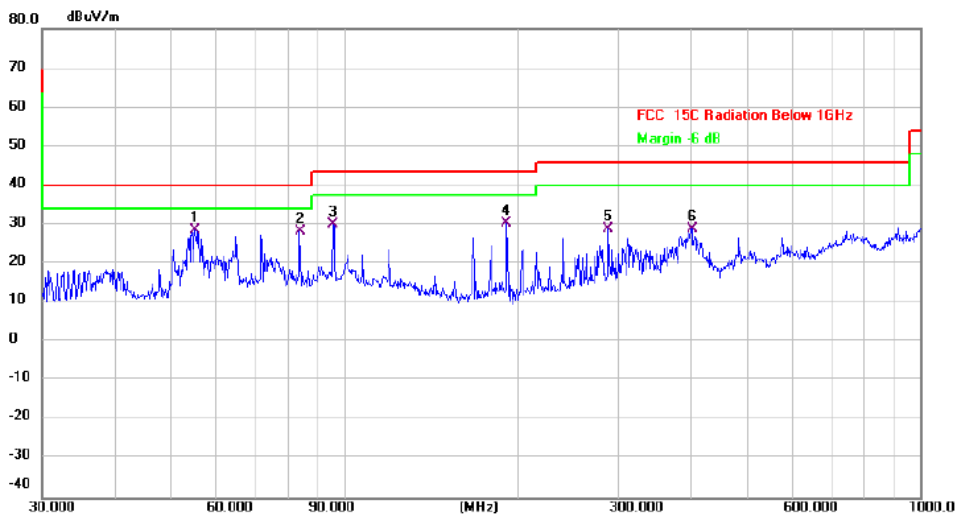

No.	Mk.	Freq. MHz	Reading Level dBuV	Correct Factor dB	Measure- ment dBuV/m	Limit dBuV/m	Over dB	Detector	Comment
1	*	55.2207	35.64	-7.16	28.48	40.00	-11.52	QP	
2		83.8156	38.95	-10.72	28.23	40.00	-11.77	QP	
3		95.7622	38.19	-8.21	29.98	43.50	-13.52	QP	
4		191.7450	39.87	-9.41	30.46	43.50	-13.04	QP	
5		287.9904	35.42	-6.67	28.75	46.00	-17.25	QP	
6		400.4319	32.70	-3.74	28.96	46.00	-17.04	QP	

6.9 Emissions in restricted frequency bands (above 1GHz)

Test Requirement:	In addition, radiated emissions which fall in the restricted bands, as defined in § 15.205(a), must also comply with the radiated emission limits specified in § 15.209(a)(see § 15.205(c)).`		
Test Limit:	Frequency (MHz)	Field strength (microvolts/meter)	Measurement distance (meters)
	0.009-0.490	2400/F(kHz)	300
	0.490-1.705	24000/F(kHz)	30
	1.705-30.0	30	30
	30-88	100 **	3
	88-216	150 **	3
	216-960	200 **	3
	Above 960	500	3
	** Except as provided in paragraph (g), fundamental emissions from intentional radiators operating under this section shall not be located in the frequency bands 54-72 MHz, 76-88 MHz, 174-216 MHz or 470-806 MHz. However, operation within these frequency bands is permitted under other sections of this part, e.g., §§ 15.231 and 15.241.		
Test Method:	Radiated emissions tests		
Procedure:	ANSI C63.10-2013 section 6.6.4		

6.9.1 E.U.T. Operation:

Operating Environment:			
Temperature:	26 °C	Humidity:	54 %
		Atmospheric Pressure:	101 kPa
Pre test mode:	Mode1, Mode2,		
Final test mode:	All of the listed pre-test mode were tested, only the data of the worst mode (Mode2) is recorded in the report		

6.9.2 Test Setup Diagram:

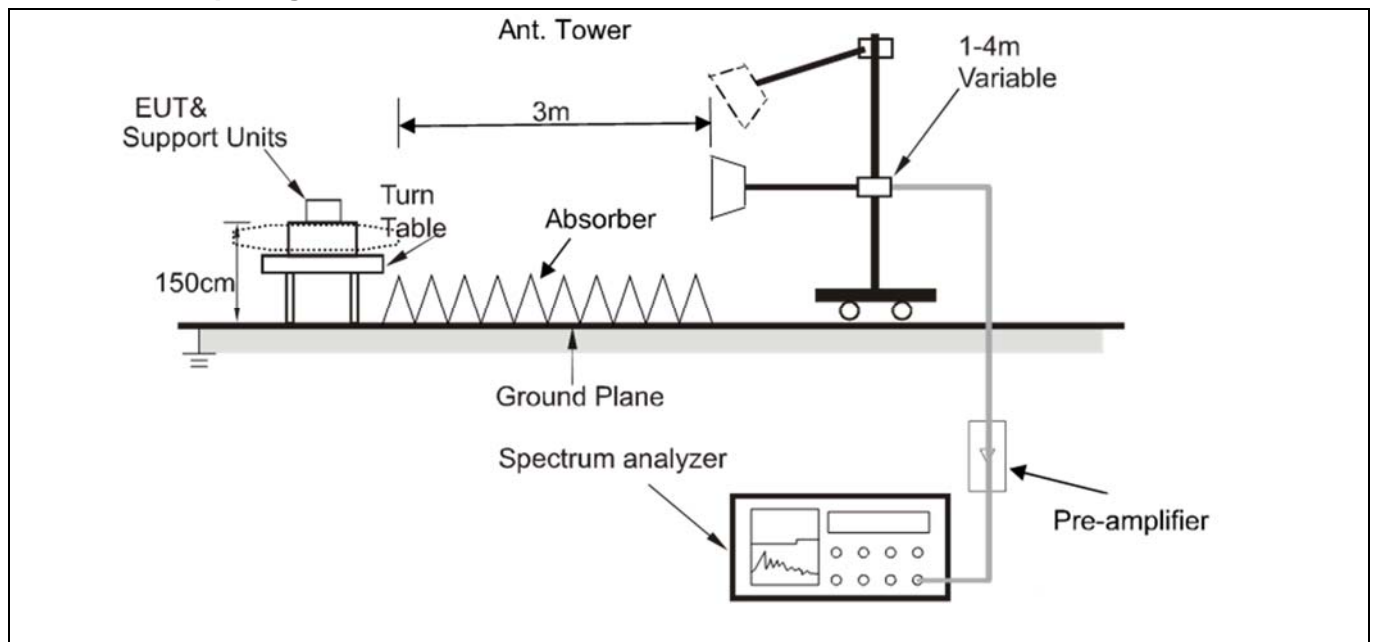

6.9.3 Test Data:

Left earphone:

Mode2 / Polarization: Horizontal / Band: 2.4G / BW: 1 / CH: 2402

No.	Mk.	Freq.	Reading Level	Correct Factor	Measurement	Limit	Over	Detector
		MHz	dBuV	dB	dBuV/m	dBuV/m	dB	
1		4804.000	51.57	0.74	52.31	74.00	-21.69	peak
2	*	4804.000	50.14	0.74	50.88	54.00	-3.12	AVG
3		7206.000	40.57	6.02	46.59	74.00	-27.41	peak
4		7206.000	34.31	6.02	40.33	54.00	-13.67	AVG
5		9608.000	40.78	5.88	46.66	74.00	-27.34	peak
6		9608.000	34.53	5.88	40.41	54.00	-13.59	AVG

Mode2 / Polarization: Vertical / Band: 2.4G / BW: 1 / CH: 2402

No.	Mk.	Freq.	Reading Level	Correct Factor	Measurement	Limit	Over	Detector
		MHz	dBuV	dB	dBuV/m	dBuV/m	dB	
1		4804.000	45.03	0.74	45.77	74.00	-28.23	peak
2	*	4804.000	42.82	0.74	43.56	54.00	-10.44	AVG
3		7206.000	40.25	6.02	46.27	74.00	-27.73	peak
4		7206.000	34.13	6.02	40.15	54.00	-13.85	AVG
5		9608.000	41.00	5.88	46.88	74.00	-27.12	peak
6		9608.000	34.38	5.88	40.26	54.00	-13.74	AVG

Left earphone:

Mode2 / Polarization: Horizontal / Band: 2.4G / BW: 1 / CH: 2441

No.	Mk.	Freq.	Reading Level	Correct Factor	Measurement	Limit	Over	Detector
		MHz	dBuV	dB	dBuV/m	dBuV/m	dB	
1		4882.000	50.47	1.05	51.52	74.00	-22.48	peak
2	*	4882.000	49.08	1.05	50.13	54.00	-3.87	AVG
3		7323.000	42.21	5.94	48.15	74.00	-25.85	peak
4		7323.000	36.18	5.94	42.12	54.00	-11.88	AVG
5		9764.000	44.53	6.55	51.08	74.00	-22.92	peak
6		9764.000	38.68	6.55	45.23	54.00	-8.77	AVG

Mode2 / Polarization: Vertical / Band: 2.4G / BW: 1 / CH: 2441

No.	Mk.	Freq.	Reading Level	Correct Factor	Measurement	Limit	Over	Detector
		MHz	dBuV	dB	dBuV/m	dBuV/m	dB	
1		4882.000	43.55	1.05	44.60	74.00	-29.40	peak
2	*	4882.000	42.07	1.05	43.12	54.00	-10.88	AVG
3		7323.000	40.08	5.94	46.02	74.00	-27.98	peak
4		7323.000	34.07	5.94	40.01	54.00	-13.99	AVG
5		9764.000	42.18	6.55	48.73	74.00	-25.27	peak
6		9764.000	35.67	6.55	42.22	54.00	-11.78	AVG

Left earphone:

Mode2 / Polarization: Horizontal / Band: 2.4G / BW: 1 / CH: 2480

No.	Mk.	Freq.	Reading Level	Correct Factor	Measurement	Limit	Over	Detector
		MHz	dBuV	dB	dBuV/m	dBuV/m	dB	
1		4960.000	49.84	1.50	51.34	74.00	-22.66	peak
2	*	4960.000	48.61	1.50	50.11	54.00	-3.89	AVG
3		7440.000	41.95	5.61	47.56	74.00	-26.44	peak
4		7440.000	35.62	5.61	41.23	54.00	-12.77	AVG
5		9920.000	42.40	6.10	48.50	74.00	-25.50	peak
6		9920.000	36.12	6.10	42.22	54.00	-11.78	AVG

Mode2 / Polarization: Vertical / Band: 2.4G / BW: 1 / CH: 2480

No.	Mk.	Freq.	Reading Level	Correct Factor	Measurement	Limit	Over	Detector
		MHz	dBuV	dB	dBuV/m	dBuV/m	dB	
1		4960.000	43.11	1.50	44.61	74.00	-29.39	peak
2	*	4960.000	41.62	1.50	43.12	54.00	-10.88	AVG
3		7440.000	39.75	5.61	45.36	74.00	-28.64	peak
4		7440.000	33.61	5.61	39.22	54.00	-14.78	AVG
5		9920.000	41.43	6.10	47.53	74.00	-26.47	peak
6		9920.000	35.16	6.10	41.26	54.00	-12.74	AVG

Right earphone:

Mode2 / Polarization: Horizontal / Band: 2.4G / BW: 1 / CH: 2402

No.	Mk.	Freq.	Reading Level	Correct Factor	Measurement	Limit	Over	Detector
		MHz	dBuV	dB	dBuV/m	dBuV/m	dB	
1		4804.000	51.29	0.74	52.03	74.00	-21.97	peak
2	*	4804.000	49.58	0.74	50.32	54.00	-3.68	AVG
3		7206.000	39.57	6.02	45.59	74.00	-28.41	peak
4		7206.000	33.20	6.02	39.22	54.00	-14.78	AVG
5		9608.000	40.86	5.88	46.74	74.00	-27.26	peak
6		9608.000	34.40	5.88	40.28	54.00	-13.72	AVG

Mode2 / Polarization: Vertical / Band: 2.4G / BW: 1 / CH: 2402

No.	Mk.	Freq.	Reading Level	Correct Factor	Measurement	Limit	Over	Detector
		MHz	dBuV	dB	dBuV/m	dBuV/m	dB	
1		4804.000	44.53	0.74	45.27	74.00	-28.73	peak
2	*	4804.000	42.41	0.74	43.15	54.00	-10.85	AVG
3		7206.000	39.95	6.02	45.97	74.00	-28.03	peak
4		7206.000	33.42	6.02	39.44	54.00	-14.56	AVG
5		9608.000	41.31	5.88	47.19	74.00	-26.81	peak
6		9608.000	35.22	5.88	41.10	54.00	-12.90	AVG

Right earphone:

Mode2 / Polarization: Horizontal / Band: 2.4G / BW: 1 / CH: 2441

No. Mk.	Freq.	Reading Level	Correct Factor	Measurement	Limit	Over	Detector
	MHz	dBuV	dB	dBuV/m	dBuV/m	dB	
1	4882.000	42.55	1.05	43.60	74.00	-30.40	peak
2	4882.000	40.69	1.05	41.74	54.00	-12.26	AVG
3	7323.000	40.67	5.94	46.61	74.00	-27.39	peak
4	7323.000	34.17	5.94	40.11	54.00	-13.89	AVG
5	9764.000	42.18	6.55	48.73	74.00	-25.27	peak
6 *	9764.000	35.74	6.55	42.29	54.00	-11.71	AVG

Mode2 / Polarization: Vertical / Band: 2.4G / BW: 1 / CH: 2441

No. Mk.	Freq.	Reading Level	Correct Factor	Measurement	Limit	Over	Detector
	MHz	dBuV	dB	dBuV/m	dBuV/m	dB	
1	4882.000	49.47	1.05	50.52	74.00	-23.48	peak
2 *	4882.000	48.17	1.05	49.22	54.00	-4.78	AVG
3	7323.000	41.21	5.94	47.15	74.00	-26.85	peak
4	7323.000	35.17	5.94	41.11	54.00	-12.89	AVG
5	9764.000	43.53	6.55	50.08	74.00	-23.92	peak
6	9764.000	37.50	6.55	44.05	54.00	-9.95	AVG

Right earphone:

Mode2 / Polarization: Horizontal / Band: 2.4G / BW: 1 / CH: 2480

No.	Mk.	Freq.	Reading Level	Correct Factor	Measurement	Limit	Over	Detector
		MHz	dBuV	dB	dBuV/m	dBuV/m	dB	
1		4960.000	48.84	1.50	50.34	74.00	-23.66	peak
2	*	4960.000	47.72	1.50	49.22	54.00	-4.78	AVG
3		7440.000	41.45	5.61	47.06	74.00	-26.94	peak
4		7440.000	34.98	5.61	40.59	54.00	-13.41	AVG
5		9920.000	41.90	6.10	48.00	74.00	-26.00	peak
6		9920.000	36.01	6.10	42.11	54.00	-11.89	AVG

Mode2 / Polarization: Vertical / Band: 2.4G / BW: 1 / CH: 2480

No.	Mk.	Freq.	Reading Level	Correct Factor	Measurement	Limit	Over	Detector
		MHz	dBuV	dB	dBuV/m	dBuV/m	dB	
1		4960.000	42.11	1.50	43.61	74.00	-30.39	peak
2	*	4960.000	40.65	1.50	42.15	54.00	-11.85	AVG
3		7440.000	40.73	5.61	46.34	74.00	-27.66	peak
4		7440.000	34.61	5.61	40.22	54.00	-13.78	AVG
5		9920.000	41.43	6.10	47.53	74.00	-26.47	peak
6		9920.000	35.29	6.10	41.39	54.00	-12.61	AVG

Photographs of the test setup

Emissions in restricted frequency bands (below 1GHz)



Emissions in restricted frequency bands (above 1GHz)



Photographs of the EUT

Appendix

Appendix A: 20dB Emission Bandwidth

Test Result

Test Mode	Antenna	Frequency [MHz]	20db EBW [MHz]
DH5	Ant1	2402	0.963
		2441	1.014
		2480	1.029
2DH5	Ant1	2402	1.290
		2441	1.350
		2480	1.311

Test Graphs

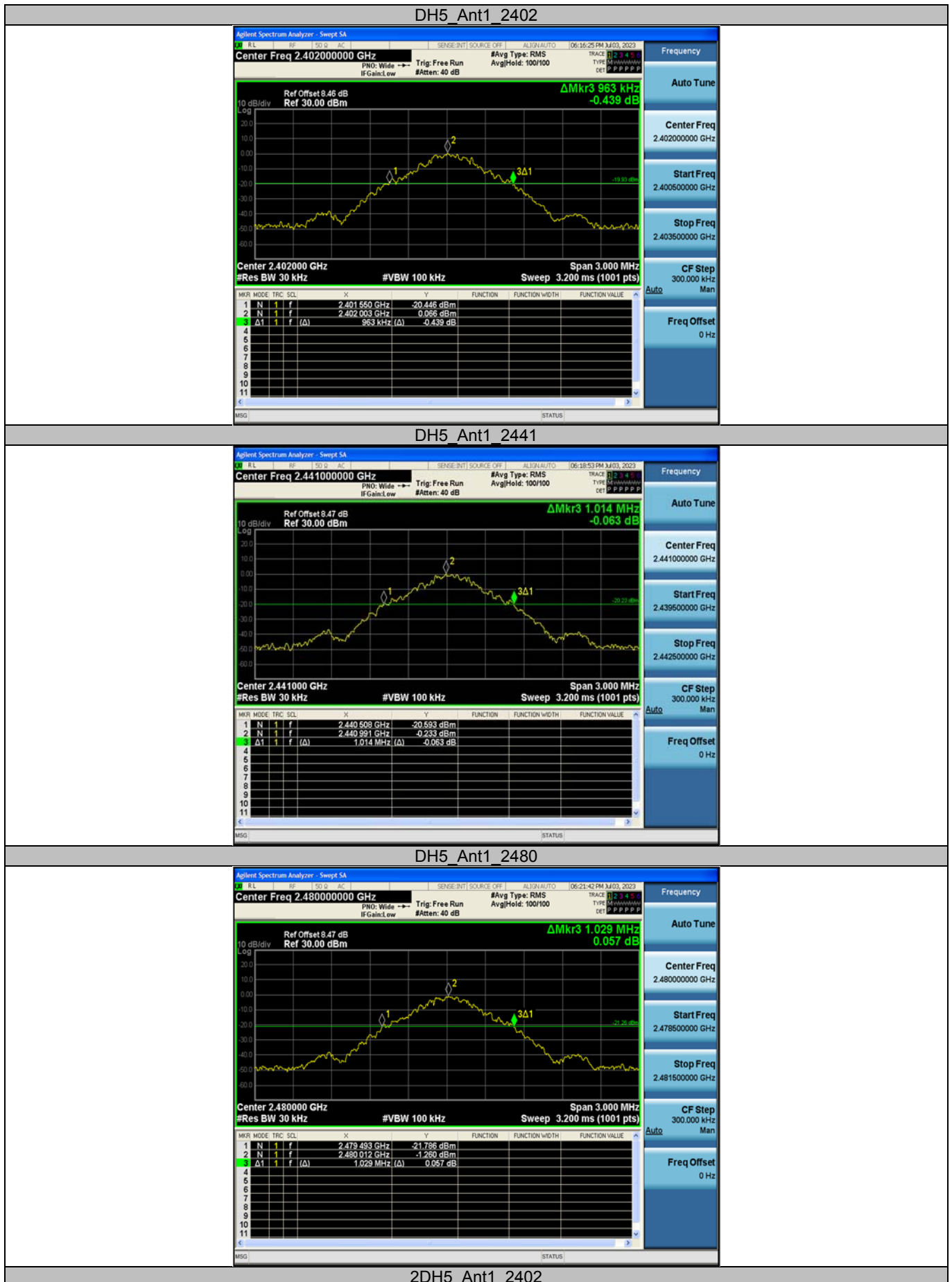



2DH5_Ant1_2441



2DH5_Ant1_2480



Appendix B: Maximum conducted output power

Test Result Peak

Test Mode	Antenna	Frequency [MHz]	Conducted Peak Power [dBm]	Limit [dBm]	Verdict
DH5	Ant1	2402	2.52	≤20.97	PASS
		2441	2.58	≤20.97	PASS
		2480	1.58	≤20.97	PASS
2DH5	Ant1	2402	3.28	≤20.97	PASS
		2441	3.24	≤20.97	PASS
		2480	2.28	≤20.97	PASS

Test Graphs

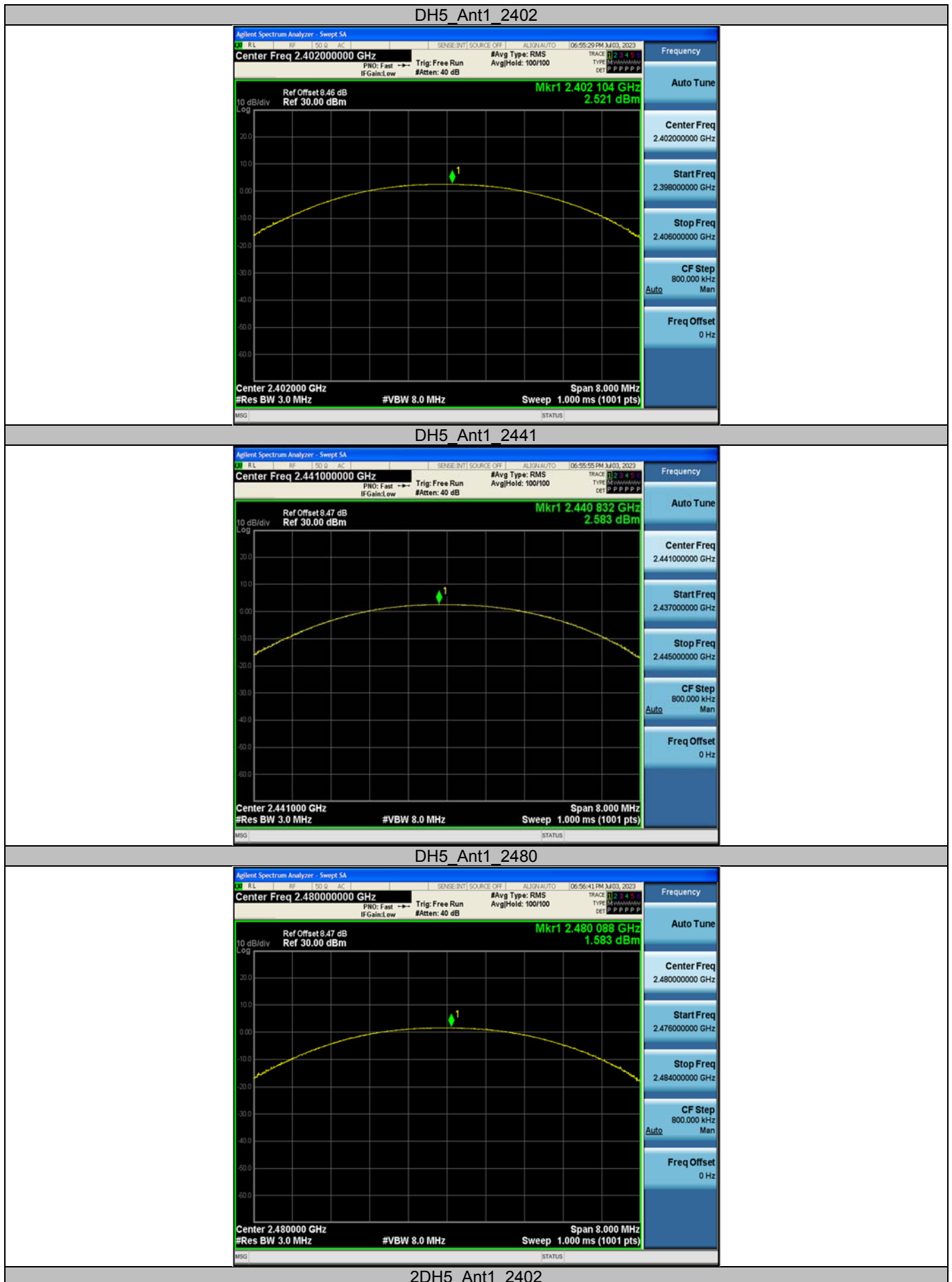

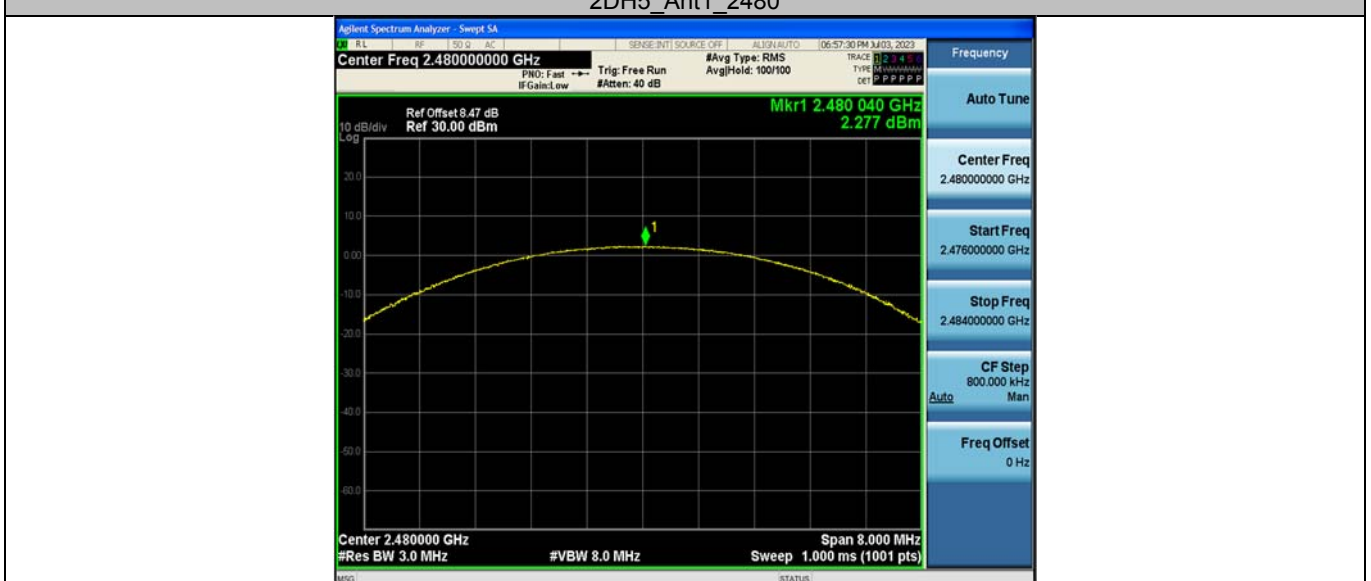
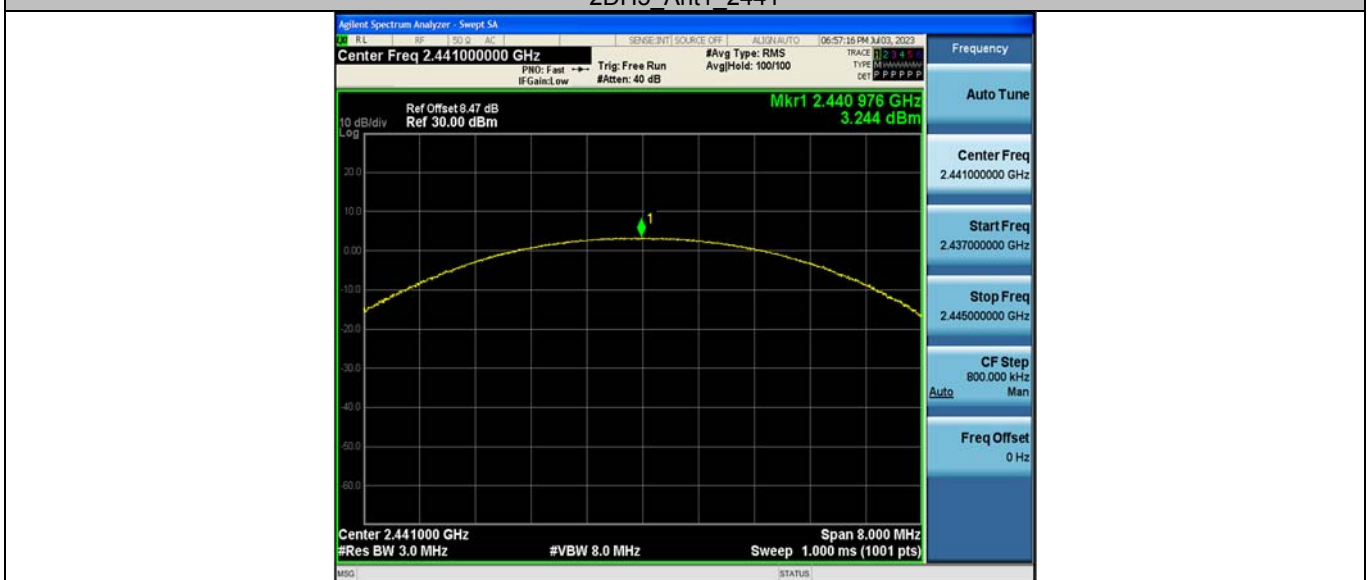

Appendix C: Carrier frequency separation

Test Result

Test Mode	Antenna	Frequency [MHz]	Result [MHz]	Limit [MHz]	Verdict
DH5	Ant1	Hop	1.002	≥ 0.686	PASS
2DH5	Ant1	Hop	0.998	≥ 0.900	PASS

Test Graphs



Appendix D: Time of occupancy

Test Result

Test Mode	Antenna	Frequency [MHz]	BurstWidth [ms]	Hops in 31.6s [Num]	Result [s]	Limit [s]	Verdict
DH1	Ant1	Hop	0.381	319	0.122	≤0.4	PASS
DH3	Ant1	Hop	1.638	153	0.251	≤0.4	PASS
DH5	Ant1	Hop	2.885	102	0.294	≤0.4	PASS
2DH1	Ant1	Hop	0.390	320	0.125	≤0.4	PASS
2DH3	Ant1	Hop	1.643	156	0.256	≤0.4	PASS
2DH5	Ant1	Hop	2.891	102	0.295	≤0.4	PASS

Notes:

1. Period time = $0.4s * 79 = 31.6s$
2. Result (Time of occupancy) = $BurstWidth[ms] * Hops\ in\ 31.6s\ [Num]$

Test Graphs

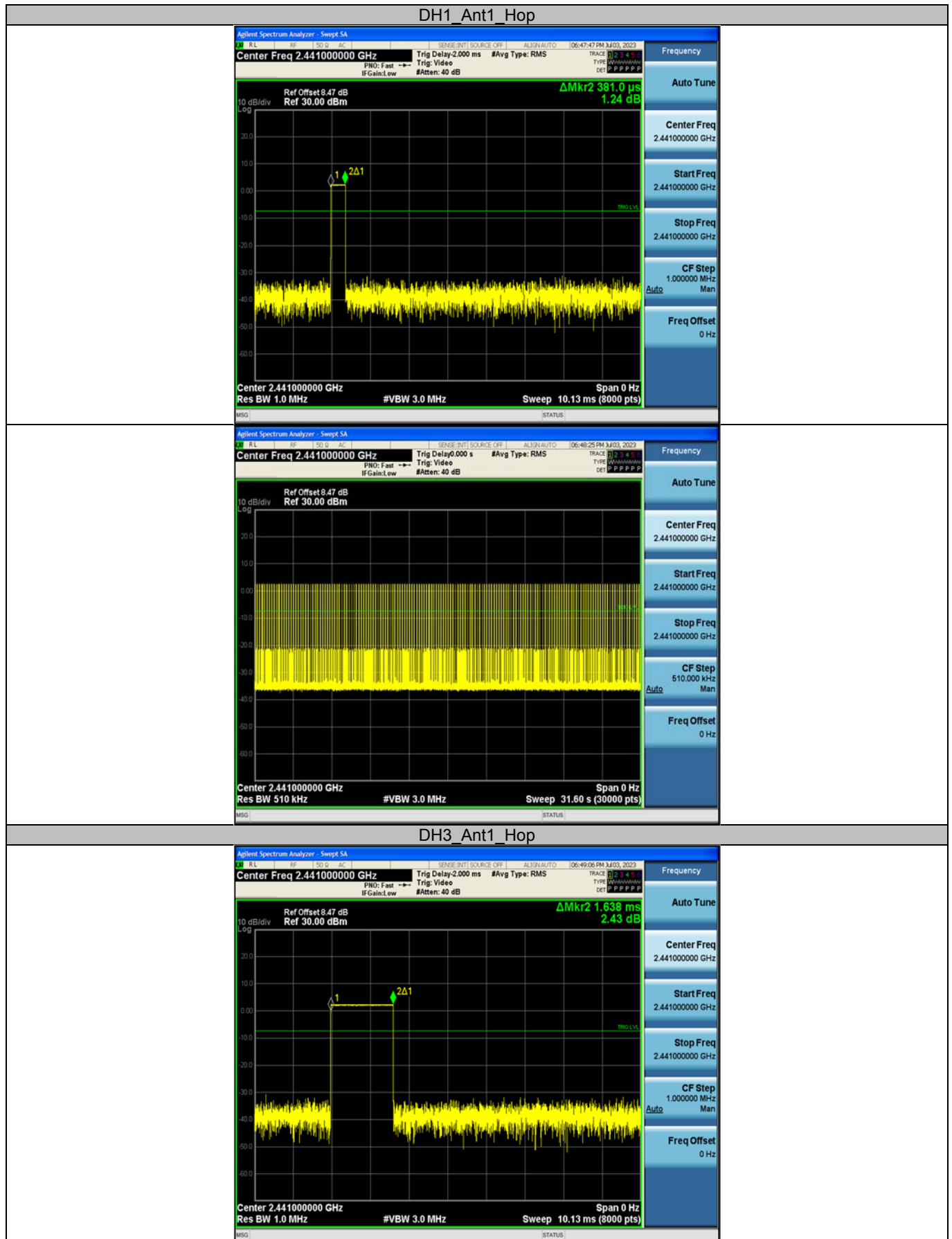

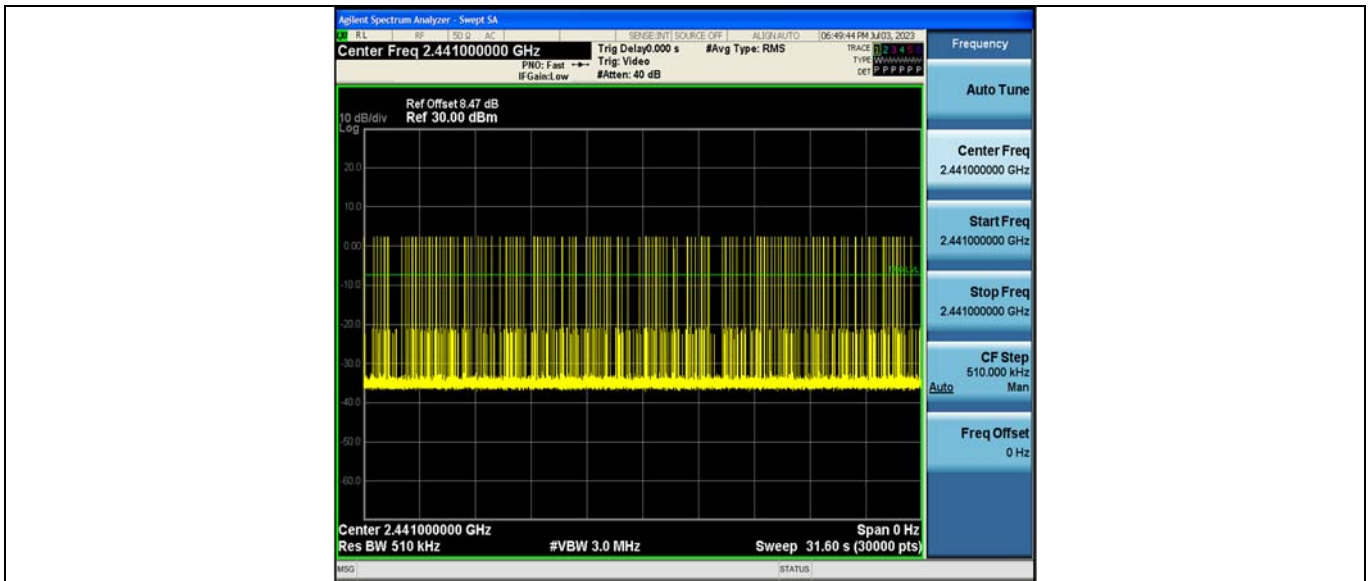

DH5_Ant1_Hop

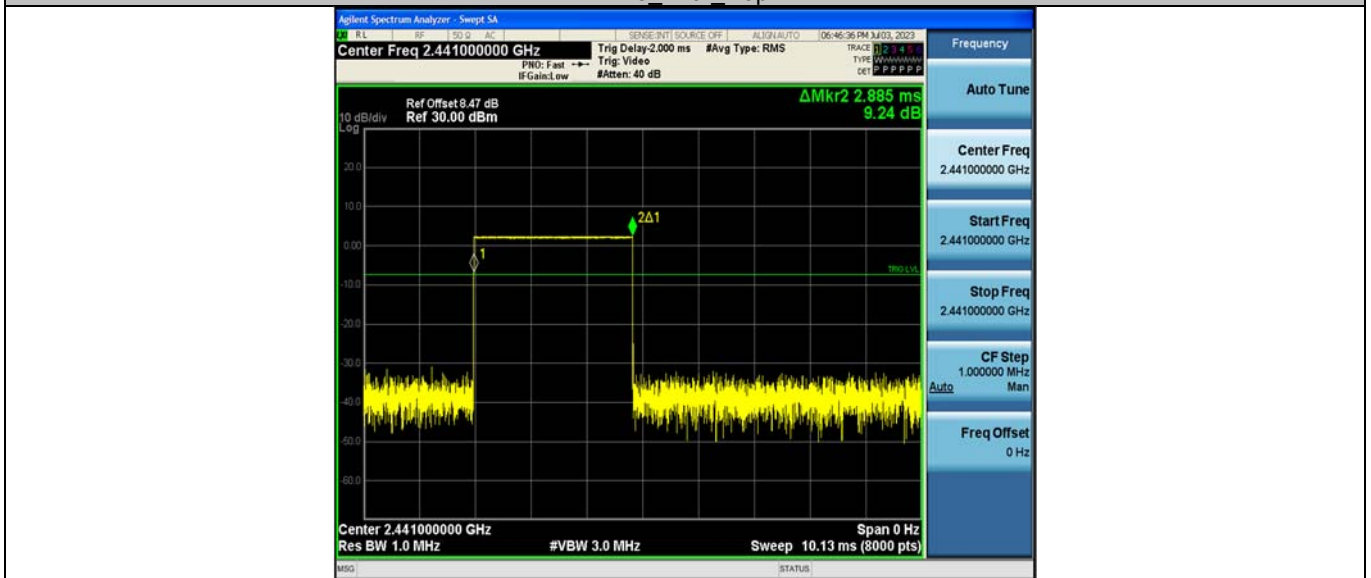

2DH1_Ant1_Hop

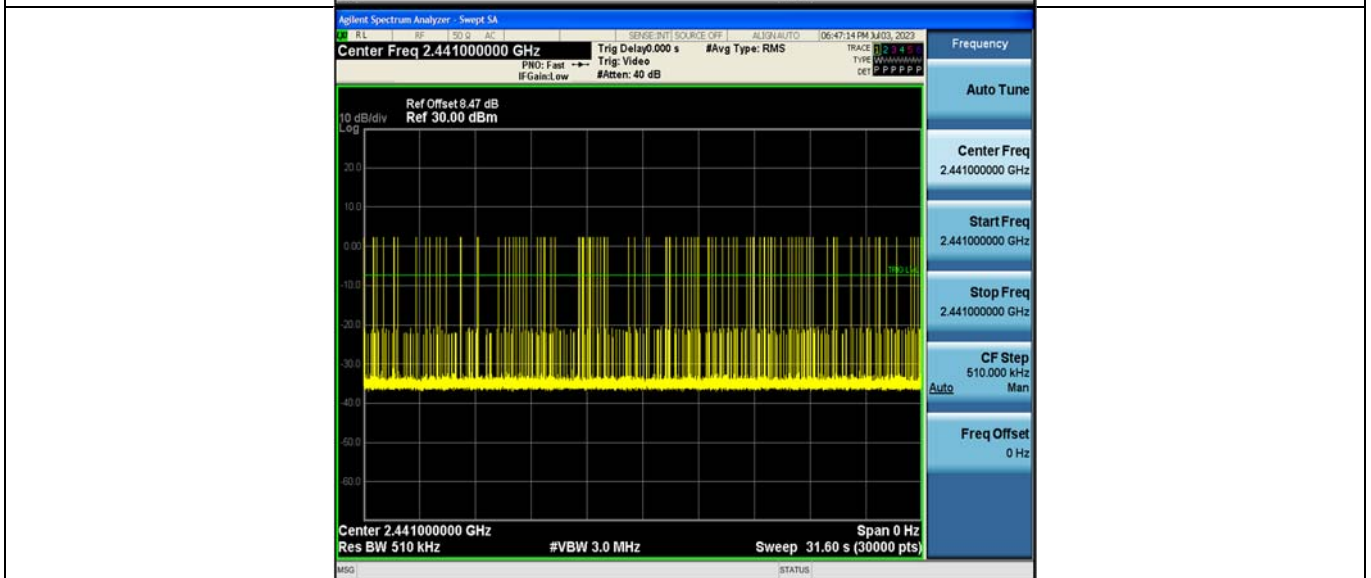

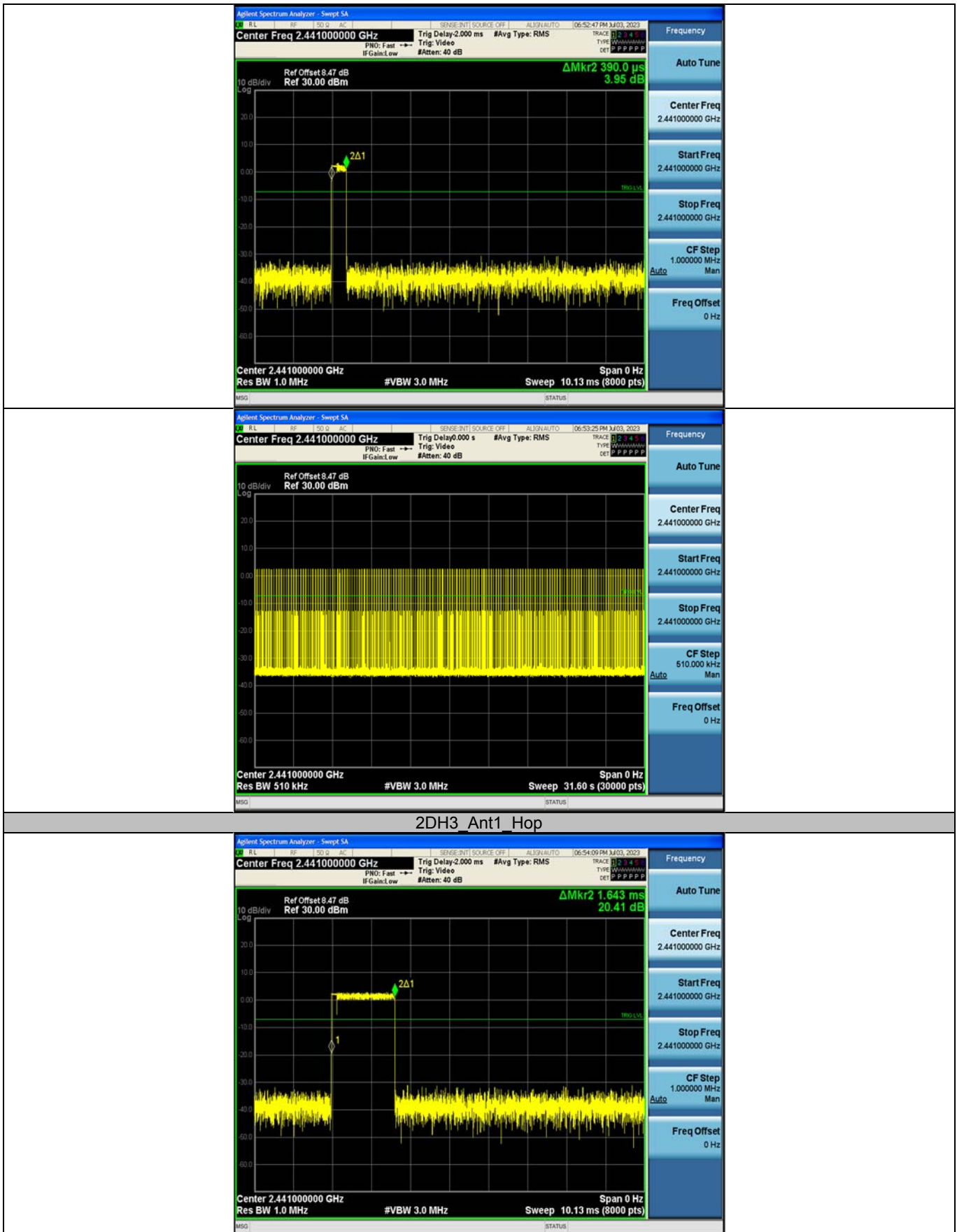

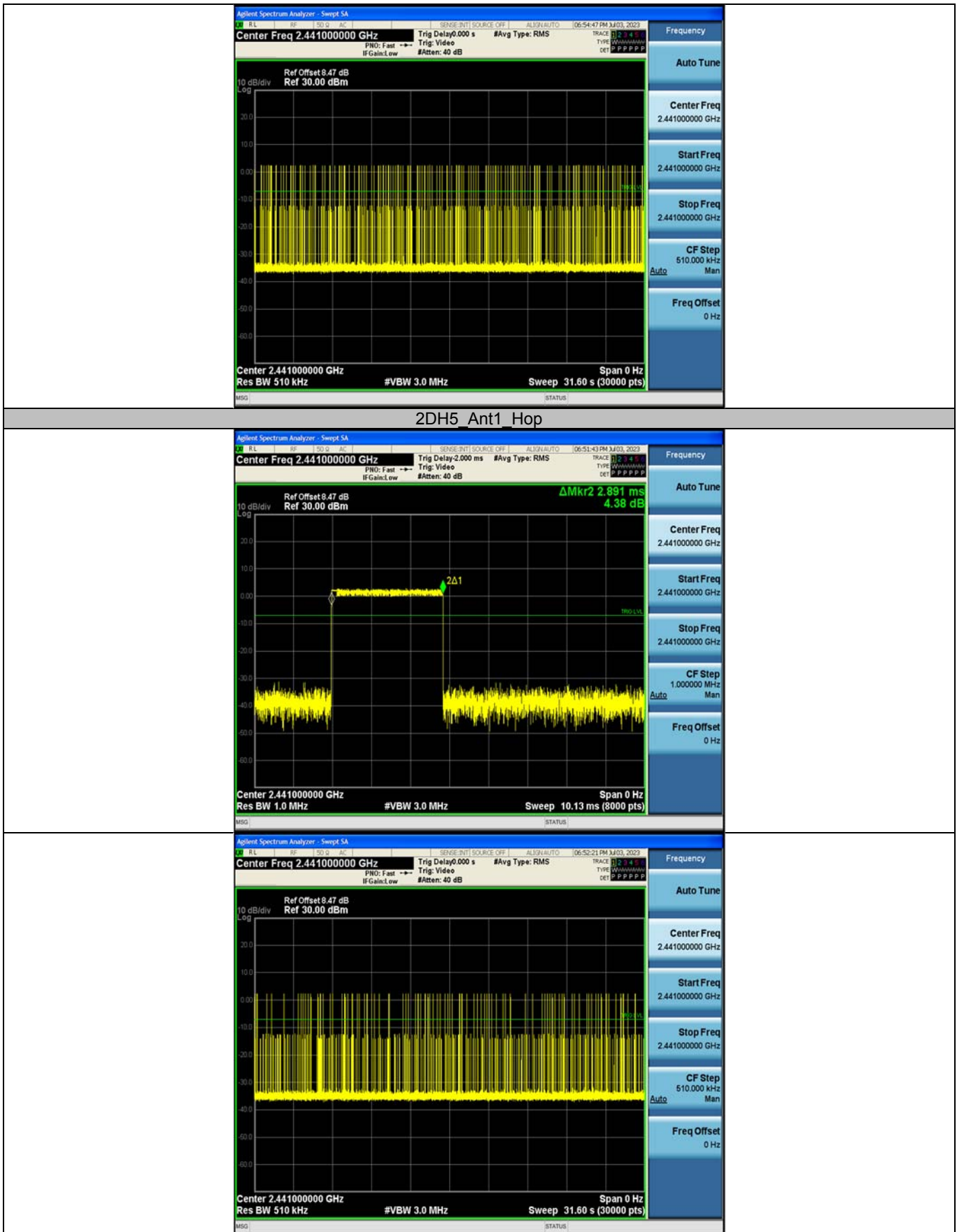

Appendix E: Number of hopping channels

Test Result

Test Mode	Antenna	Frequency [MHz]	Result [Num]	Limit [Num]	Verdict
DH5	Ant1	Hop	79	≥15	PASS
2DH5	Ant1	Hop	79	≥15	PASS

Test Graphs



Appendix F: Band edge measurements

Test Graphs



DH5_Ant1_High_Hop_2480

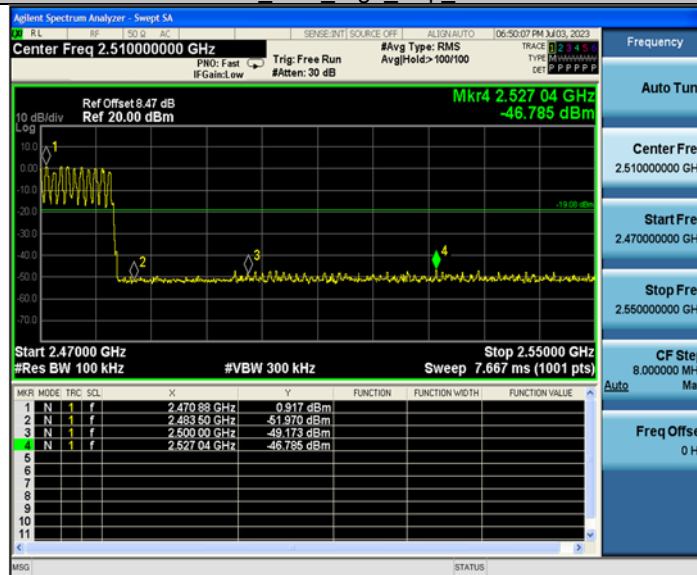

2DH5_Ant1_Low_2402

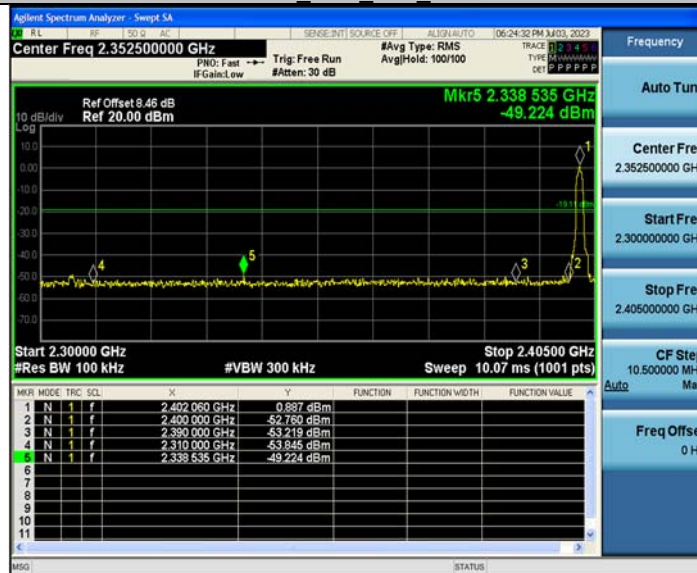

2DH5_Ant1_High_2480

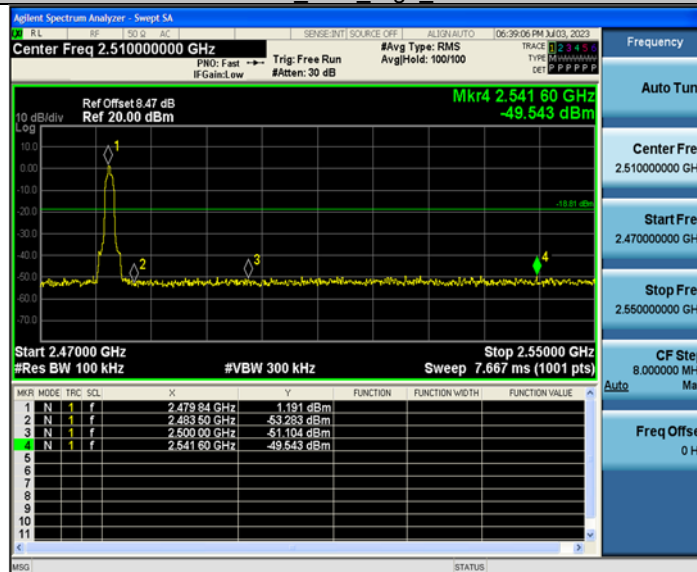

2DH5_Ant1_Low_Hop_2402

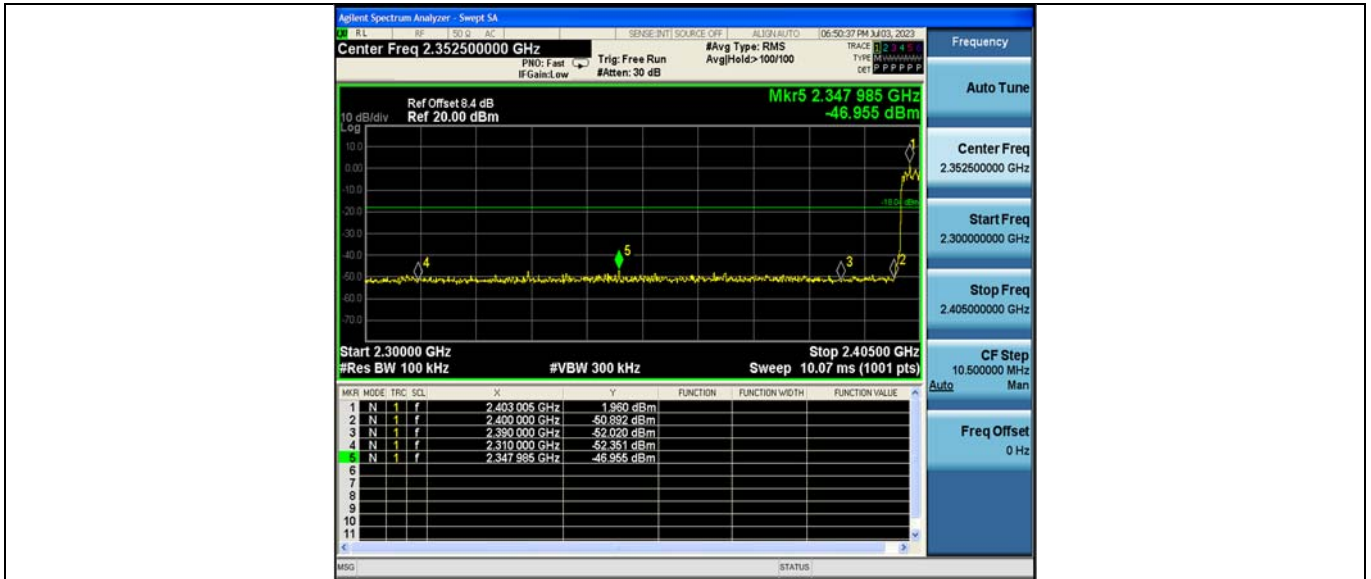

2DH5 Ant1 High Hop 2480

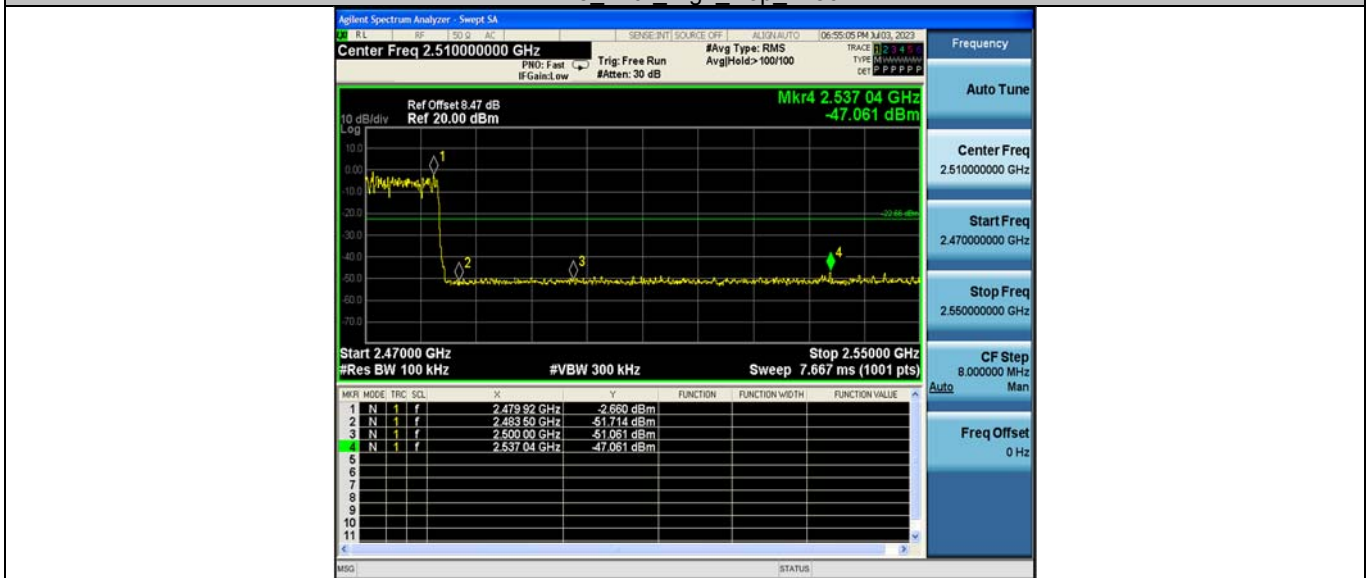

Appendix G: Conducted Spurious Emission

Test Graphs



DH5_Ant1_2441_0~Reference



DH5_Ant1_2441_30~1000

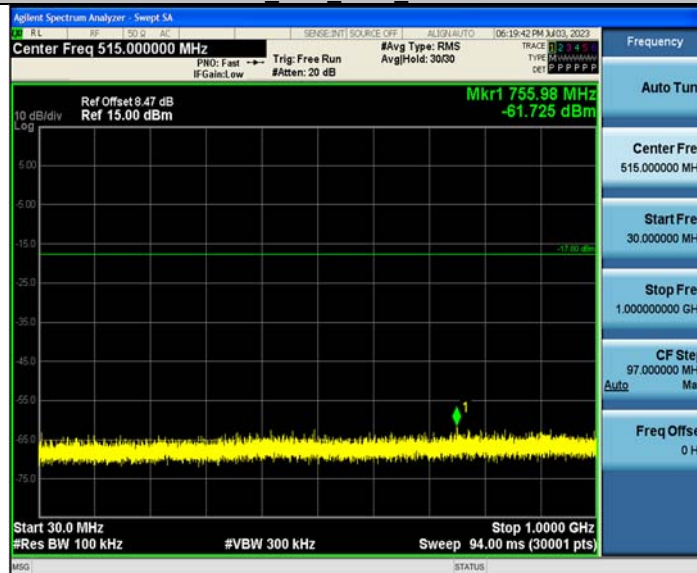

DH5_Ant1_2441_1000~26500

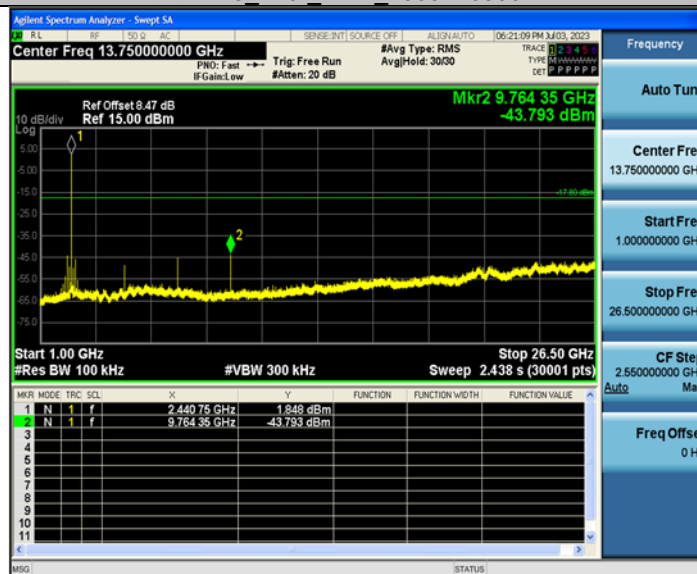

DH5_Ant1_2480_0~Reference



DH5_Ant1_2480_30~1000

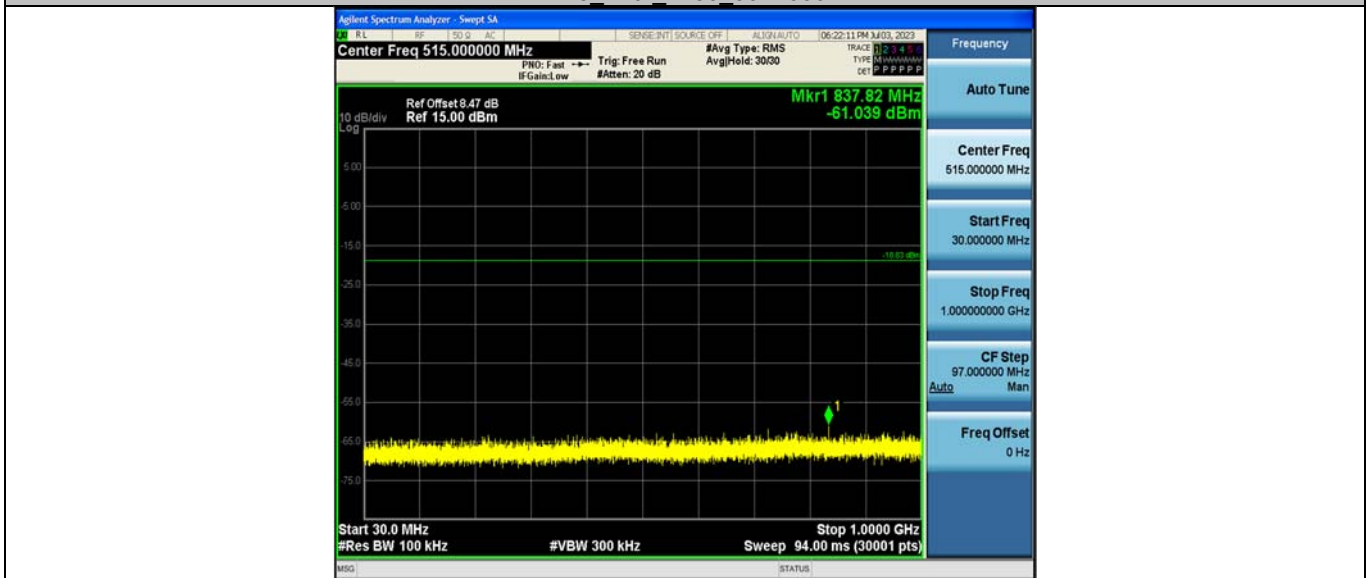

DH5_Ant1_2480_1000~26500

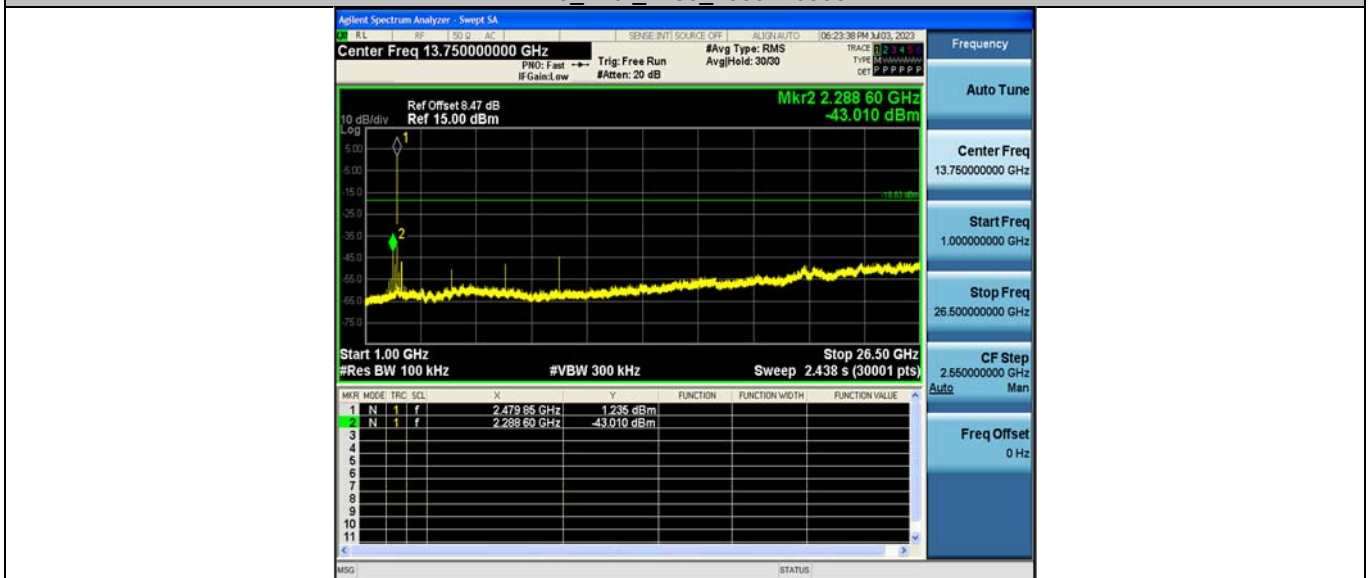

2DH5_Ant1_2402_0~Reference



2DH5_Ant1_2402_30~1000

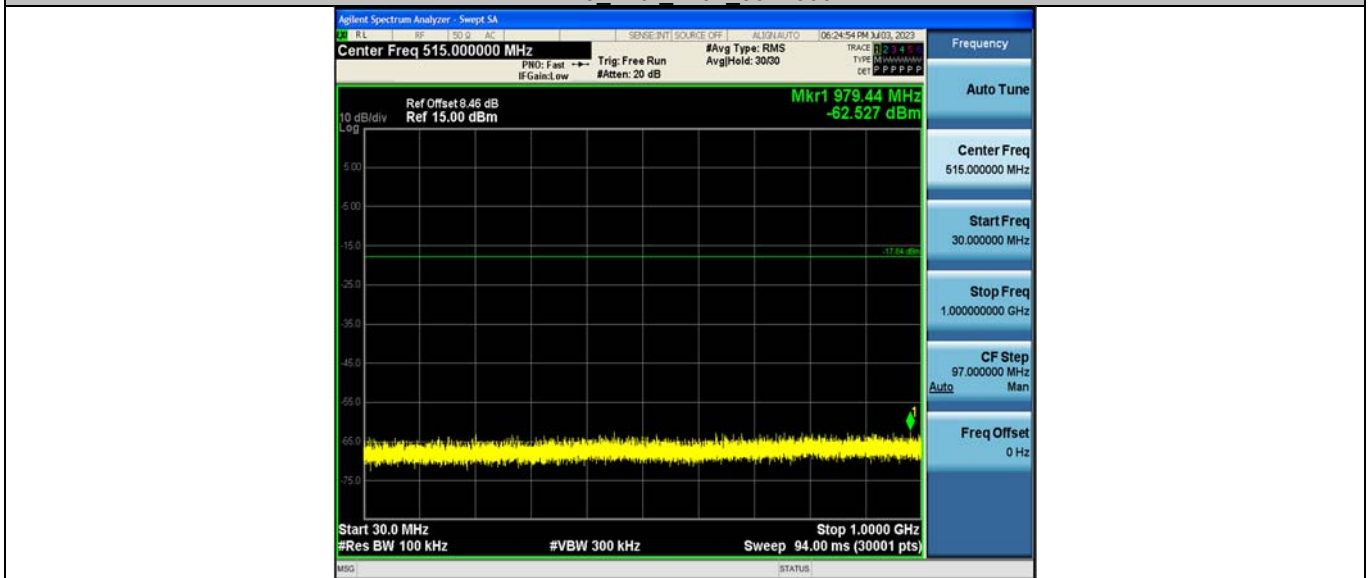

2DH5_Ant1_2402_1000~26500



2DH5_Ant1_2441_0~Reference



2DH5_Ant1_2441_30~1000

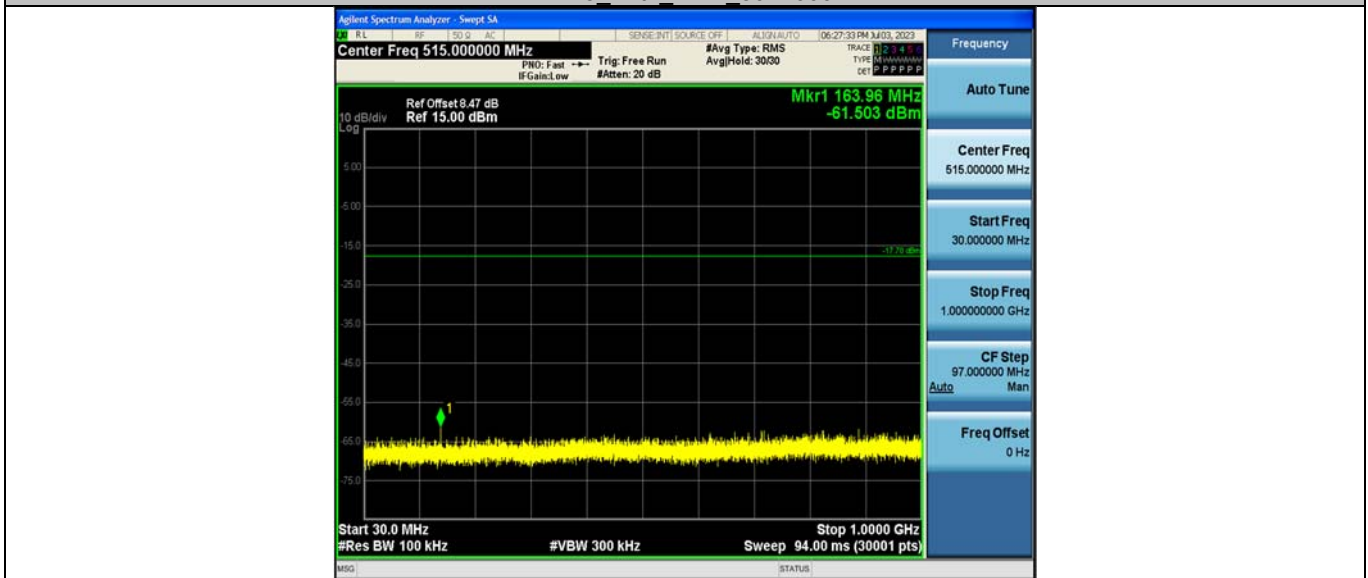

2DH5_Ant1_2441_1000~26500

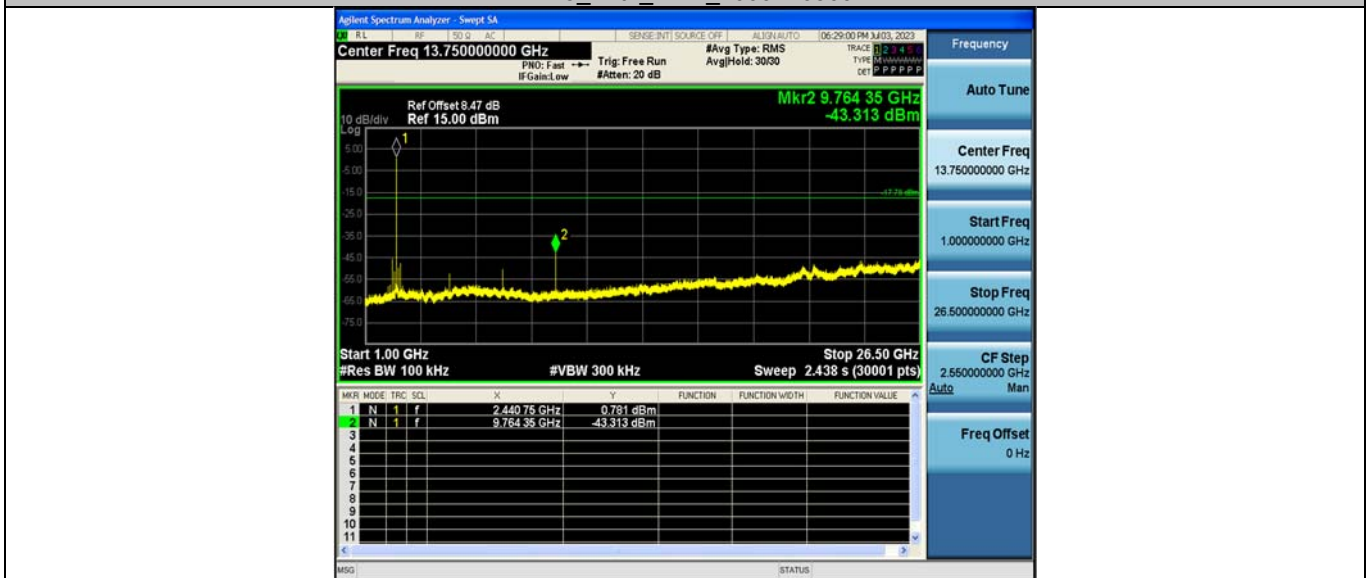

2DH5_Ant1_2480_0~Reference



2DH5_Ant1_2480_30~1000

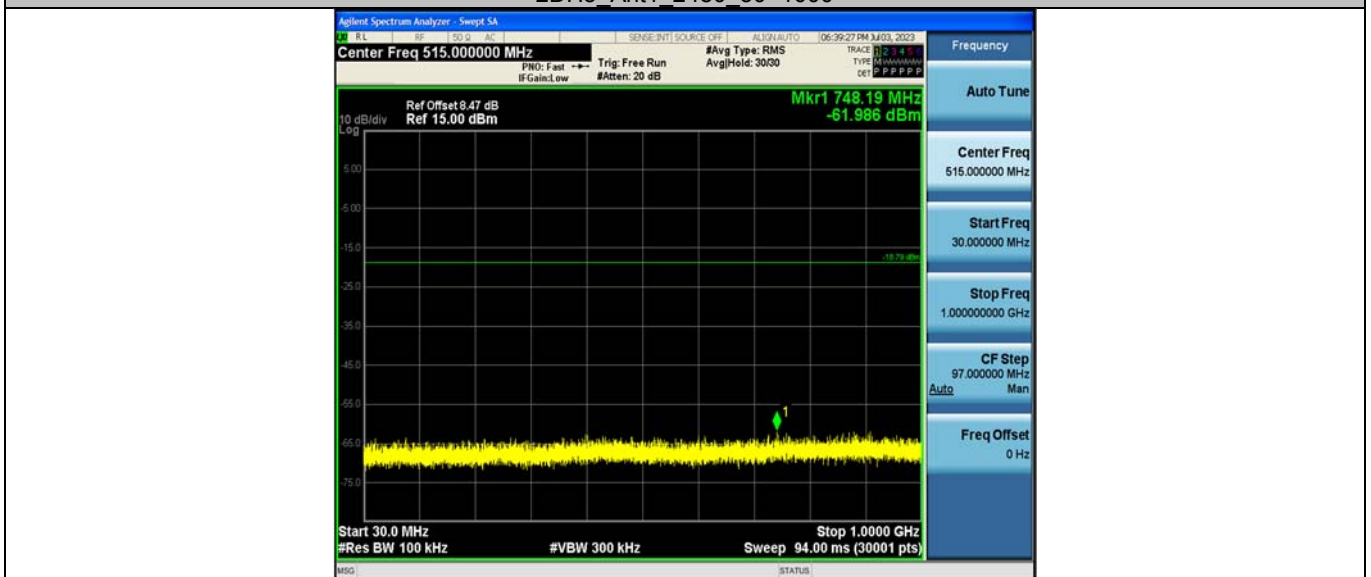

2DH5_Ant1_2480_1000~26500

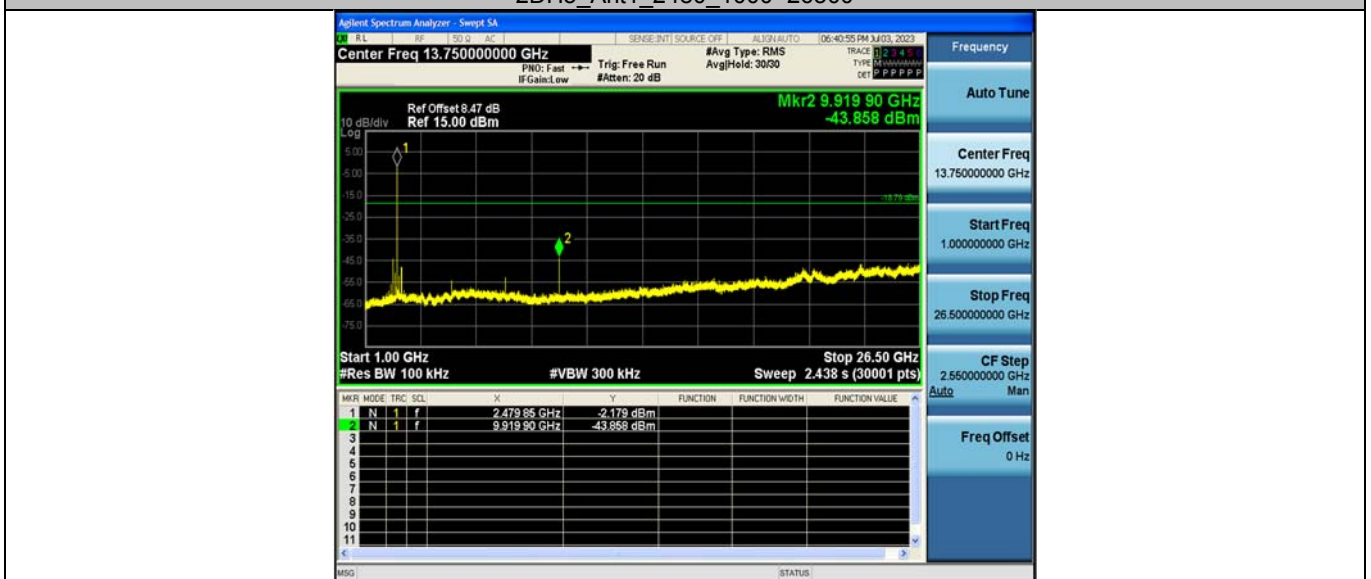

----End of Report----