

Test Report

Report No.: MTi230811002-01E1

Date of issue: 2023-08-29

Applicant: Guangzhou Havit Technology Co., Ltd.

Product: Multi-Color Ambient Light Bluetooth Speaker

Model(s): SK889BT, SK887BT

FCC ID: 2A16I-SK889BT

Shenzhen Microtest Co., Ltd.

<http://www.mtitest.com>

The test report is only used for customer scientific research, teaching, internal quality control and other purposes, and is for internal reference only.



Instructions

1. This test report shall not be partially reproduced without the written consent of the laboratory.
2. The test results in this test report are only responsible for the samples submitted
3. This test report is invalid without the seal and signature of the laboratory.
4. This test report is invalid if transferred, altered, or tampered with in any form without authorization.
5. Any objection to this test report shall be submitted to the laboratory within 15 days from the date of receipt of the report.

Table of contents

1	General Description	5
1.1	Description of the EUT	5
1.2	Description of test modes	5
1.3	Environmental Conditions	7
1.4	Description of support units	7
1.5	Measurement uncertainty	7
2	Summary of Test Result	8
3	Test Facilities and accreditations	9
3.1	Test laboratory	9
4	List of test equipment.....	10
5	Evaluation Results (Evaluation).....	11
5.1	Antenna requirement	11
6	Radio Spectrum Matter Test Results (RF)	11
6.1	Conducted Emission at AC power line	11
6.2	Occupied Bandwidth	14
6.3	Maximum Conducted Output Power.....	16
6.4	Channel Separation	18
6.5	Number of Hopping Frequencies.....	19
6.6	Dwell Time	20
6.7	RF conducted spurious emissions and band edge measurement	22
6.8	Band edge emissions (Radiated)	23
6.9	Radiated emissions (below 1GHz)	26
6.10	Radiated emissions (above 1GHz).....	30
	Photographs of the test setup	34
	Photographs of the EUT.....	35
	Appendix A: 20dB Emission Bandwidth	36
	Appendix B: Maximum conducted output power.....	39
	Appendix C: Carrier frequency separation.....	42
	Appendix D: Time of occupancy	44
	Appendix E: Number of hopping channels.....	49
	Appendix F: Band edge measurements.....	51
	Appendix G: Conducted Spurious Emission.....	54

Test Result Certification	
Applicant:	Guangzhou Havit Technology Co., Ltd.
Address:	ROOM 1307, 13F, PHASE 2 B, C BUILDING OF POLY WORLD TRADE CENTER, NO.1000, XINGANG EAST ROAD, HAIZHU GUANGDONG China
Manufacturer:	Guangzhou Havit Technology Co., Ltd.
Address:	ROOM 1307, 13F, PHASE 2 B, C BUILDING OF POLY WORLD TRADE CENTER, NO.1000, XINGANG EAST ROAD, HAIZHU GUANGDONG China
Product description	
Product name:	Multi-Color Ambient Light Bluetooth Speaker
Trademark:	HAVIT
Model name:	SK889BT
Series Model:	SK887BT
Standards:	47 CFR Part 15.247
Test Method:	ANSI C63.10-2013 KDB 558074 D01 15.247 Meas Guidance v05r02
Date of Test	
Date of test:	2023-08-23 to 2023-08-29
Test result:	Pass

Test Engineer	:	<i>Letter Lan</i>
		(Letter Lan)
Reviewed By	:	<i>Leon Chen</i>
		(Leon Chen)
Approved By	:	<i>Tom Xue</i>
		(Tom Xue)

1 General Description

1.1 Description of the EUT

Product name:	Multi-Color Ambient Light Bluetooth Speaker
Model name:	SK889BT
Series Model:	SK887BT
Model difference:	All the models are the same circuit and module, except the model name.
Electrical rating:	Input: DC 5V/1A Battery: DC 3.7V 1500mAh
Accessories:	Cable: USB-A to USB-C cable 0.5m
Hardware version:	Q56H-V1.1
Software version:	6965E4-V1.7.0
Test sample(s) number:	MTi230811002-01S1001
RF specification	
Bluetooth version:	V5.3
Operating frequency range:	2402-2480
Channel number:	79
Modulation type:	GFSK, $\pi/4$ -DQPSK
Antenna(s) type:	PCB antenna
Antenna(s) gain:	-0.58dBi

1.2 Description of test modes

No.	Emission test modes
Mode1	TX-GFSK
Mode2	TX- $\pi/4$ -DQPSK

1.2.1 Operation channel list

Channel	Frequency (MHz)	Channel	Frequency (MHz)	Channel	Frequency (MHz)	Channel	Frequency (MHz)
0	2402	20	2422	40	2442	60	2462
1	2403	21	2423	41	2443	61	2463
2	2404	22	2424	42	2444	62	2464
3	2405	23	2425	43	2445	63	2465
4	2406	24	2426	44	2446	64	2466
5	2407	25	2427	45	2447	65	2467
6	2408	26	2428	46	2448	66	2468
7	2409	27	2429	47	2449	67	2469
8	2410	28	2430	48	2450	68	2470
9	2411	29	2431	49	2451	69	2471

10	2412	30	2432	50	2452	70	2472
11	2413	31	2433	51	2453	71	2473
12	2414	32	2434	52	2454	72	2474
13	2415	33	2435	53	2455	73	2475
14	2416	34	2436	54	2456	74	2476
15	2417	35	2437	55	2457	75	2477
16	2418	36	2438	56	2458	76	2478
17	2419	37	2439	57	2459	77	2479
18	2420	38	2440	58	2460	78	2480
19	2421	39	2441	59	2461	-	-

Note: The test software provided by manufacturer is used to control EUT for working in engineering mode, that enables selectable channel, and capable of continuous transmitting mode.

Test Software: FCC Assist 1.0.2.2

For power setting, refer to below table.

Mode	2402MHz	2441MHz	2480MHz
GFSK	10	10	10
$\pi/4$ -DQPSK	10	10	10

1.3 Environmental Conditions

During the measurement the environmental conditions were within the listed ranges:

Temperature:	15°C ~ 35°C
Humidity:	20% RH ~ 75% RH
Atmospheric pressure:	98 kPa ~ 101 kPa

1.4 Description of support units

Support equipment list			
Description	Model	Serial No.	Manufacturer
Adapter	HW-090200CH0	/	Huizhou BYD Electronics Co., Ltd.
Support cable list			
Description	Length (m)	From	To
/	/	/	/

1.5 Measurement uncertainty

Measurement	Uncertainty
Conducted emissions (AMN 150kHz~30MHz)	±3.1dB
Occupied channel bandwidth	±3 %
RF output power, conducted	±1 dB
Time	±1 %
Unwanted Emissions, conducted	±1 dB
Radiated spurious emissions (above 1GHz)	±5.3dB
Radiated spurious emissions (9kHz~30MHz)	±4.3dB
Radiated spurious emissions (30MHz~1GHz)	±4.7dB
Temperature	±1 °C
Humidity	± 5 %

This uncertainty represents an expanded uncertainty expressed at approximately the 95% confidence level using a coverage factor of k=2.

2 Summary of Test Result

No.	FCC reference	Description of test	Result
1	§ 15.203	Antenna requirement	Pass
2	§ 15.207	AC power line conducted emissions	Pass
3	§ 15.247(d), 15.209, 15.205	Radiated spurious emissions	Pass
4	§ 15.247(a)(1)	20dB emission bandwidth	Pass
5	§ 15.247(b)(1)	Maximum conducted output power	Pass
6	§ 15.247(a)(1)	Carrier Frequencies Separation	Pass
7	§ 15.247(a)(1)	Time of occupancy	Pass
8	§ 15.247(a)(1)	Number of hopping channels	Pass
9	§ 15.247(d)	Band edge (Conducted)	Pass
10	§ 15.247(d)	Conducted spurious emissions	Pass

3 Test Facilities and accreditations

3.1 Test laboratory

Test laboratory:	Shenzhen Microtest Co., Ltd.
Test site location:	101, No.7, Zone 2, Xinxing Industrial Park, Fuhai Avenue, Xinhe Community, Fuhai Street, Bao'an District, Shenzhen, Guangdong, China
Telephone:	(86-755)88850135
Fax:	(86-755)88850136
CNAS Registration No.:	CNAS L5868
FCC Registration No.:	448573
IC Registration No.:	21760
CABID:	CN0093

4 List of test equipment

No.	Equipment	Manufacturer	Model	Serial No.	Cal. date	Cal. Due
Conducted Emission at AC power line						
1	EMI Test Receiver	Rohde&schwarz	ESCI3	101368	2023-04-26	2024-04-25
2	Artificial mains network	Schwarzbeck	NSLK 8127	183	2023-05-05	2024-05-04
3	Artificial Mains Network	Rohde & Schwarz	ESH2-Z5	100263	2023-06-03	2024-06-02
Number of Hopping Frequencies Dwell Time Emissions in non-restricted frequency bands Occupied Bandwidth Maximum Conducted Output Power Channel Separation						
1	Wideband Radio Communication Tester	Rohde&schwarz	CMW500	149155	2023-04-26	2024-04-25
2	ESG Series Analog Ssignal Generator	Agilent	E4421B	GB40051240	2023-04-25	2024-04-24
3	PXA Signal Analyzer	Agilent	N9030A	MY51350296	2023-04-25	2024-04-24
4	Synthesized Sweeper	Agilent	83752A	3610A01957	2023-04-25	2024-04-24
5	MXA Signal Analyzer	Agilent	N9020A	MY50143483	2023-04-26	2024-04-25
6	RF Control Unit	Tonscend	JS0806-1	19D8060152	2023-04-26	2024-04-25
7	Band Reject Filter Group	Tonscend	JS0806-F	19D8060160	2023-05-05	2024-05-04
8	ESG Vector Signal Generator	Agilent	N5182A	MY50143762	2023-04-25	2024-04-24
9	DC Power Supply	Agilent	E3632A	MY40027695	2023-05-05	2024-05-04
Band edge emissions (Radiated) Emissions in frequency bands (above 1GHz)						
1	EMI Test Receiver	Rohde&schwarz	ESCI7	101166	2023-04-26	2024-04-25
2	Double Ridged Broadband Horn Antenna	schwarabeck	BBHA 9120 D	2278	2023-05-26	2024-05-25
3	Amplifier	Agilent	8449B	3008A01120	2023-06-26	2024-06-25
4	Multi-device Controller	TuoPu	TPMDC	/	2023-05-04	2024-05-03
5	MXA signal analyzer	Agilent	N9020A	MY54440859	2023-05-05	2024-05-04
Emissions in frequency bands (below 1GHz)						
1	EMI Test Receiver	Rohde&schwarz	ESCI7	101166	2023-04-26	2024-04-25
2	TRILOG Broadband Antenna	schwarabeck	VULB 9163	9163-1338	2023-06-11	2025-06-10
3	Amplifier	Hewlett-Packard	8447F	3113A06184	2023-06-26	2024-06-25
4	Multi-device Controller	TuoPu	TPMDC	/	2023-05-04	2024-05-03
5	Active Loop Antenna	Schwarzbeck	FMZB 1519 B	00066	2021/05/30	2024/05/29

5 Evaluation Results (Evaluation)

5.1 Antenna requirement

Test Requirement:	Refer to 47 CFR Part 15.203, an intentional radiator shall be designed to ensure that no antenna other than that furnished by the responsible party shall be used with the device. The use of a permanently attached antenna or of an antenna that uses a unique coupling to the intentional radiator shall be considered sufficient to comply with the provisions of this section.
Description of the antenna of EUT:	The antenna of the EUT is permanently attached.
Conclusion:	The EUT complies with the requirement of FCC PART 15.203.

6 Radio Spectrum Matter Test Results (RF)

6.1 Conducted Emission at AC power line

Test Requirement:	Refer to 47 CFR 15.207(a), Except as shown in paragraphs (b) and (c) of this section, for an intentional radiator that is designed to be connected to the public utility (AC) power line, the radio frequency voltage that is conducted back onto the AC power line on any frequency or frequencies, within the band 150 kHz to 30 MHz, shall not exceed the limits in the following table, as measured using a 50 μ H/50 ohms line impedance stabilization network (LISN).		
Test Limit:	Frequency of emission (MHz)	Conducted limit (dB μ V)	
		Quasi-peak	Average
	0.15-0.5	66 to 56*	56 to 46*
	0.5-5	56	46
	5-30	60	50
	*Decreases with the logarithm of the frequency.		
Test Method:	ANSI C63.10-2013 section 6.2		
Procedure:	Refer to ANSI C63.10-2013 section 6.2, standard test method for ac power-line conducted emissions from unlicensed wireless devices		

6.1.1 E.U.T. Operation:

Operating Environment:			
Temperature:	22.9 °C	Humidity:	47.9 %
		Atmospheric Pressure:	100 kPa
Test mode:	Mode1, Mode2		

6.1.2 Test Setup Diagram:

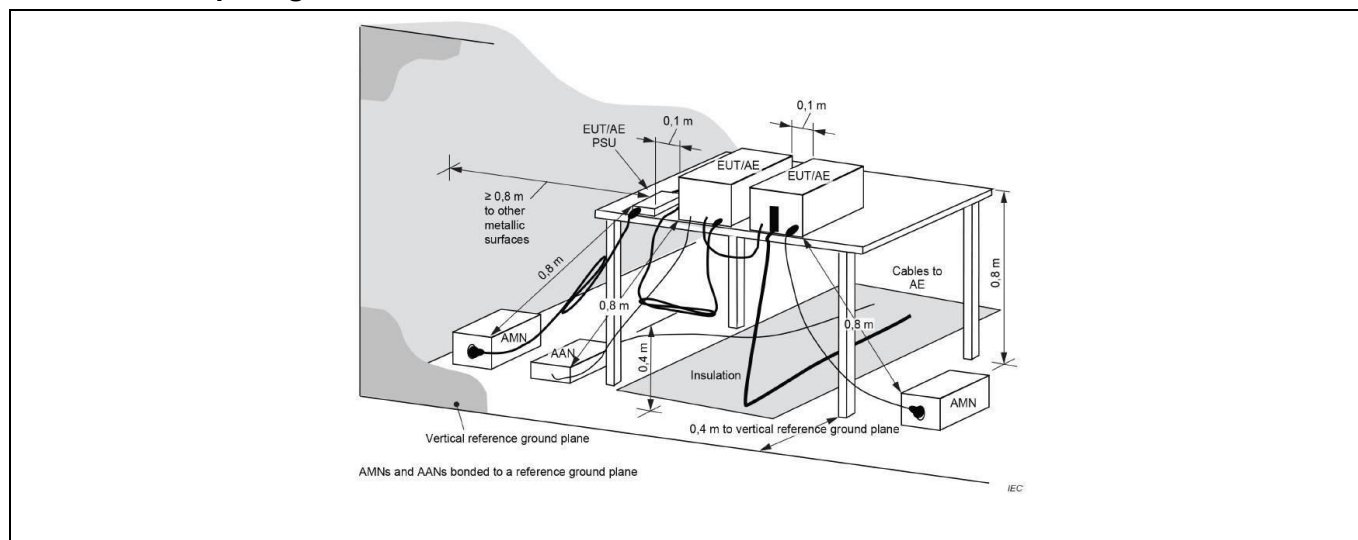

6.1.3 Test Data:

Mode1 / Line: Line / 120V/60Hz

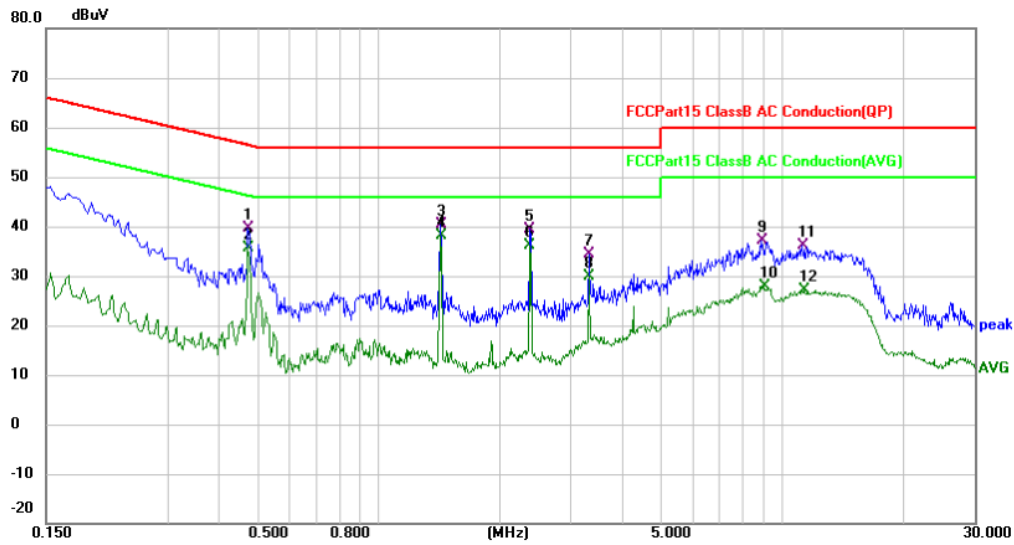

No. Mk.	Freq. MHz	Reading Level dBuV	Correct Factor dB	Measure- ment dBuV	Limit dBuV	Over dB	Detector	Comment
1	0.4740	29.59	10.05	39.64	56.44	-16.80	QP	
2	0.4740	25.57	10.05	35.62	46.44	-10.82	AVG	
3	1.4260	30.23	10.19	40.42	56.00	-15.58	QP	
4 *	1.4260	27.86	10.19	38.05	46.00	-7.95	AVG	
5	2.3740	28.91	10.39	39.30	56.00	-16.70	QP	
6	2.3740	25.76	10.39	36.15	46.00	-9.85	AVG	
7	3.3260	23.97	10.45	34.42	56.00	-21.58	QP	
8	3.3260	19.31	10.45	29.76	46.00	-16.24	AVG	
9	8.9140	26.32	10.70	37.02	60.00	-22.98	QP	
10	9.0380	17.30	10.70	28.00	50.00	-22.00	AVG	
11	11.1980	25.40	10.70	36.10	60.00	-23.90	QP	
12	11.3540	16.44	10.70	27.14	50.00	-22.86	AVG	

Mode1 / Line: Neutral / 120V/60Hz

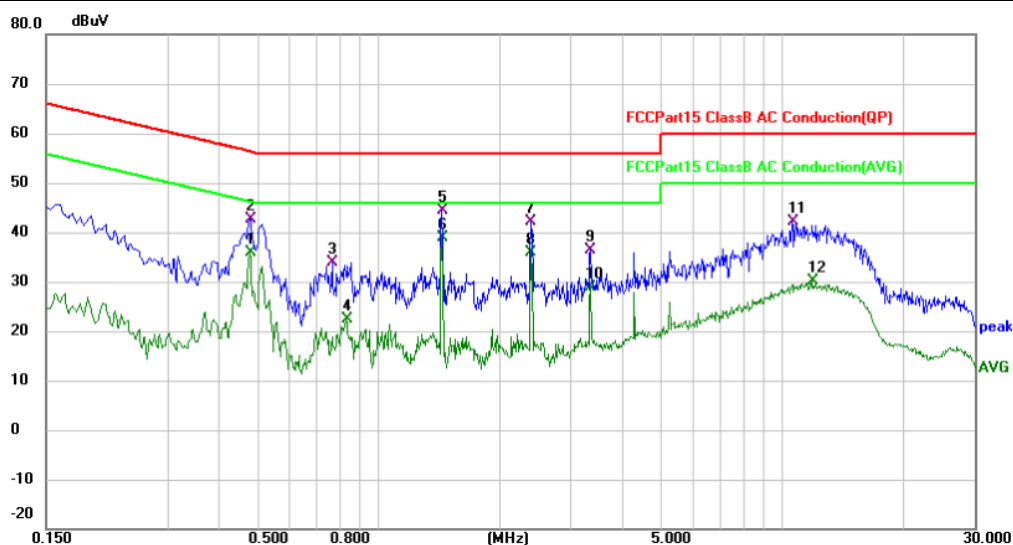

No. Mk.	Freq. MHz	Reading Level dBuV	Correct Factor dB	Measure- ment dBuV	Limit dBuV	Over dB	Detector	Comment
1	0.4780	25.70	10.23	35.93	46.37	-10.44	AVG	
2	0.4820	32.47	10.24	42.71	56.30	-13.59	QP	
3	0.7700	23.83	10.15	33.98	56.00	-22.02	QP	
4	0.8340	12.19	10.13	22.32	46.00	-23.68	AVG	
5	1.4340	34.07	10.19	44.26	56.00	-11.74	QP	
6 *	1.4340	28.81	10.19	39.00	46.00	-7.00	AVG	
7	2.3940	31.85	10.35	42.20	56.00	-13.80	QP	
8	2.3940	25.56	10.35	35.91	46.00	-10.09	AVG	
9	3.3460	26.04	10.45	36.49	56.00	-19.51	QP	
10	3.3460	18.50	10.45	28.95	46.00	-17.05	AVG	
11	10.6140	31.32	10.74	42.06	60.00	-17.94	QP	
12	11.9260	19.37	10.70	30.07	50.00	-19.93	AVG	

6.2 Occupied Bandwidth

Test Requirement:	47 CFR 15.215(c)
Test Limit:	Refer to 47 CFR 15.215(c), intentional radiators operating under the alternative provisions to the general emission limits, as contained in §§ 15.217 through 15.257 and in subpart E of this part, must be designed to ensure that the 20 dB bandwidth of the emission, or whatever bandwidth may otherwise be specified in the specific rule section under which the equipment operates, is contained within the frequency band designated in the rule section under which the equipment is operated.
Test Method:	ANSI C63.10-2013, section 7.8.7, For occupied bandwidth measurements, use the procedure in 6.9.2. KDB 558074 D01 15.247 Meas Guidance v05r02
Procedure:	<p>a) The spectrum analyzer center frequency is set to the nominal EUT channel center frequency. The span range for the EMI receiver or spectrum analyzer shall be between two times and five times the OBW.</p> <p>b) The nominal IF filter bandwidth (3 dB RBW) shall be in the range of 1% to 5% of the OBW and video bandwidth (VBW) shall be approximately three times RBW, unless otherwise specified by the applicable requirement.</p> <p>c) Set the reference level of the instrument as required, keeping the signal from exceeding the maximum input mixer level for linear operation. In general, the peak of the spectral envelope shall be more than $[10 \log (OBW/RBW)]$ below the reference level. Specific guidance is given in 4.1.5.2.</p> <p>d) Steps a) through c) might require iteration to adjust within the specified tolerances.</p> <p>e) The dynamic range of the instrument at the selected RBW shall be more than 10 dB below the target “-xx dB down” requirement; that is, if the requirement calls for measuring the -20 dB OBW, the instrument noise floor at the selected RBW shall be at least 30 dB below the reference value.</p> <p>f) Set detection mode to peak and trace mode to max hold.</p> <p>g) Determine the reference value: Set the EUT to transmit an unmodulated carrier or modulated signal, as applicable. Allow the trace to stabilize. Set the spectrum analyzer marker to the highest level of the displayed trace (this is the reference value).</p> <p>h) Determine the “-xx dB down amplitude” using $[(\text{reference value}) - xx]$. Alternatively, this calculation may be made by using the marker-delta function of the instrument.</p> <p>i) If the reference value is determined by an unmodulated carrier, then turn the EUT modulation ON, and either clear the existing trace or start a new trace on the spectrum analyzer and allow the new trace to stabilize. Otherwise, the trace from step g) shall be used for step j).</p> <p>j) Place two markers, one at the lowest frequency and the other at the highest frequency of the envelope of the spectral display, such that each marker is at or slightly below the “-xx dB down amplitude” determined in step h). If a marker is below this “-xx dB down amplitude” value, then it shall be as close as possible to this value. The occupied bandwidth is the frequency difference between the two markers. Alternatively, set a marker at the lowest frequency of the envelope of the spectral display, such that the marker is at or slightly below the “-xx dB down amplitude” determined in step h). Reset the marker-delta function and move the marker to the other side of the emission until the delta marker amplitude is at the same level as the reference marker amplitude. The marker-delta frequency reading at this point is the specified emission bandwidth.</p> <p>k) The occupied bandwidth shall be reported by providing plot(s) of the measuring instrument display; the plot axes and the scale units per division shall be clearly labeled. Tabular data may be reported in addition to the</p>

	plot(s).
--	----------

6.2.1 E.U.T. Operation:

Operating Environment:					
Temperature:	23.3 °C	Humidity:	60.7 %	Atmospheric Pressure:	100 kPa
Test mode:	Mode1, Mode2				

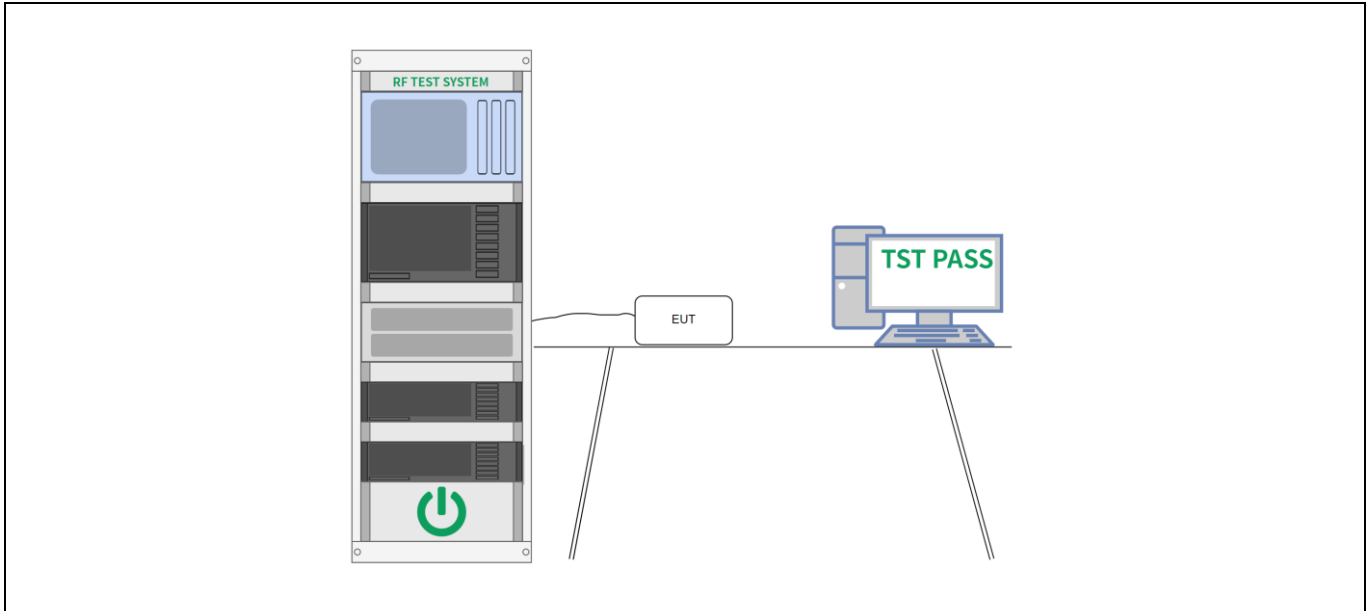
6.2.2 Test Setup Diagram:

6.2.3 Test Data:

Please Refer to Appendix for Details.

6.3 Maximum Conducted Output Power

Test Requirement:	47 CFR 15.247(b)(1)
Test Limit:	Refer to 47 CFR 15.247(b)(1), For frequency hopping systems operating in the 2400-2483.5 MHz band employing at least 75 non-overlapping hopping channels, and all frequency hopping systems in the 5725-5850 MHz band: 1 watt. For all other frequency hopping systems in the 2400-2483.5 MHz band: 0.125 watts.
Test Method:	ANSI C63.10-2013, section 7.8.5 KDB 558074 D01 15.247 Meas Guidance v05r02
Procedure:	<p>This is an RF-conducted test to evaluate maximum peak output power. Use a direct connection between the antenna port of the unlicensed wireless device and the spectrum analyzer, through suitable attenuation. The hopping shall be disabled for this test:</p> <p>a) Use the following spectrum analyzer settings:</p> <ol style="list-style-type: none"> 1) Span: Approximately five times the 20 dB bandwidth, centered on a hopping channel. 2) RBW > 20 dB bandwidth of the emission being measured. 3) VBW >= RBW. 4) Sweep: Auto. 5) Detector function: Peak. 6) Trace: Max hold. <p>b) Allow trace to stabilize.</p> <p>c) Use the marker-to-peak function to set the marker to the peak of the emission.</p> <p>d) The indicated level is the peak output power, after any corrections for external attenuators and cables.</p> <p>e) A plot of the test results and setup description shall be included in the test report.</p> <p>NOTE—A peak responding power meter may be used, where the power meter and sensor system video bandwidth is greater than the occupied bandwidth of the unlicensed wireless device, rather than a spectrum analyzer.</p>

6.3.1 E.U.T. Operation:

Operating Environment:			
Temperature:	23.3 °C	Humidity:	60.7 %
		Atmospheric Pressure:	100 kPa
Test mode:	Mode1, Mode2		

6.3.2 Test Setup Diagram:

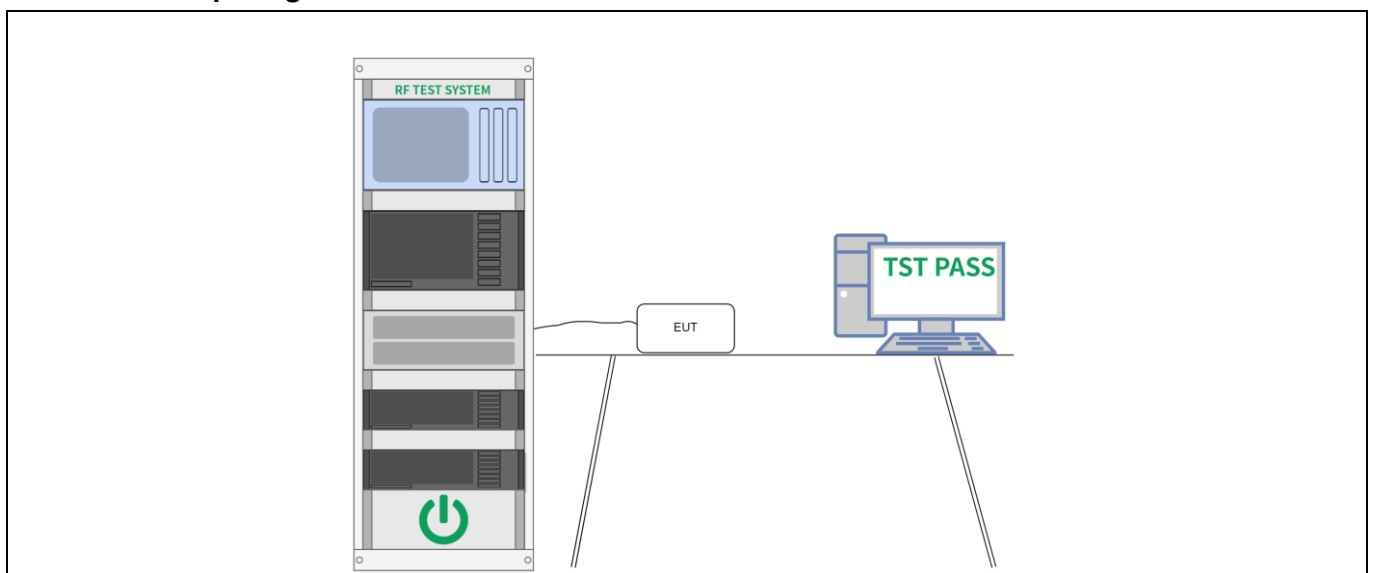

--

6.3.3 Test Data:

Please Refer to Appendix for Details.

6.4 Channel Separation

Test Requirement:	47 CFR 15.247(a)(1)
Test Limit:	Refer to 47 CFR 15.247(a)(1), Frequency hopping systems shall have hopping channel carrier frequencies separated by a minimum of 25 kHz or the 20 dB bandwidth of the hopping channel, whichever is greater. Alternatively, frequency hopping systems operating in the 2400-2483.5 MHz band may have hopping channel carrier frequencies that are separated by 25 kHz or two-thirds of the 20 dB bandwidth of the hopping channel, whichever is greater, provided the systems operate with an output power no greater than 125 mW.
Test Method:	ANSI C63.10-2013, section 7.8.2 KDB 558074 D01 15.247 Meas Guidance v05r02
Procedure:	The EUT shall have its hopping function enabled. Use the following spectrum analyzer settings: a) Span: Wide enough to capture the peaks of two adjacent channels. b) RBW: Start with the RBW set to approximately 30% of the channel spacing; adjust as necessary to best identify the center of each individual channel. c) Video (or average) bandwidth (VBW) \geq RBW. d) Sweep: Auto. e) Detector function: Peak. f) Trace: Max hold. g) Allow the trace to stabilize. Use the marker-delta function to determine the separation between the peaks of the adjacent channels. Compliance of an EUT with the appropriate regulatory limit shall be determined. A plot of the data shall be included in the test report.

6.4.1 E.U.T. Operation:

Operating Environment:					
Temperature:	23.3 °C	Humidity:	60.7 %	Atmospheric Pressure:	100 kPa
Test mode:	Mode1, Mode2				

6.4.2 Test Setup Diagram:

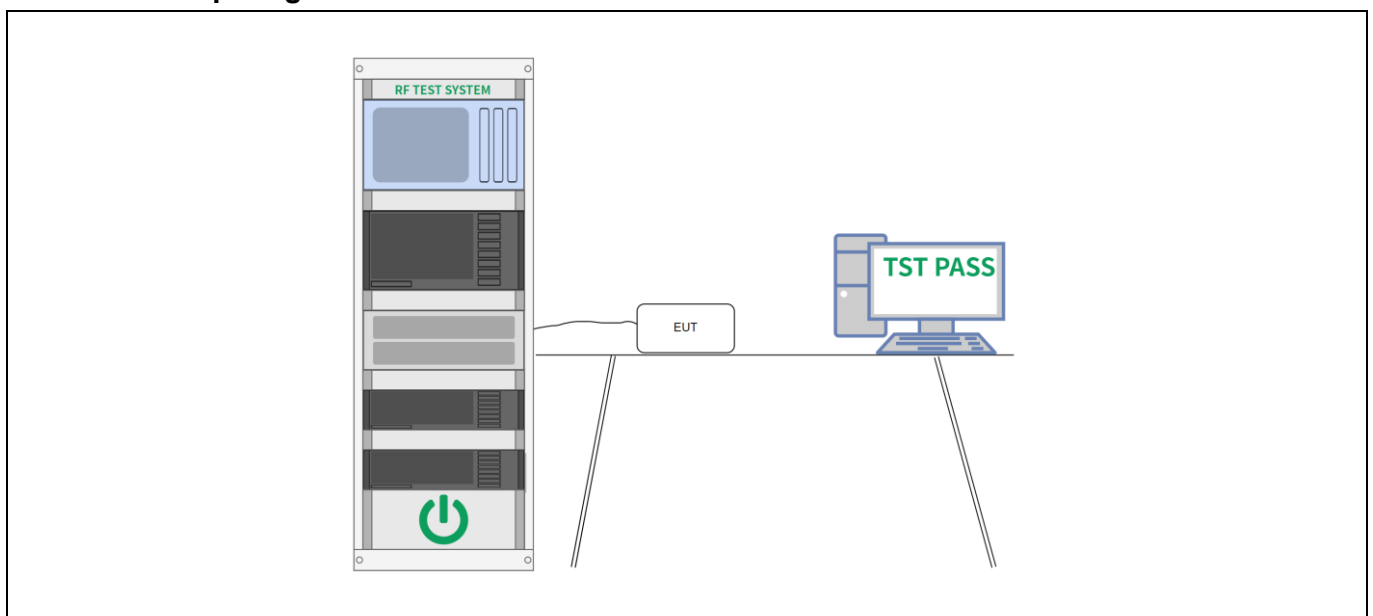

6.4.3 Test Data:

Please Refer to Appendix for Details.

6.5 Number of Hopping Frequencies

Test Requirement:	47 CFR 15.247(a)(1)(iii)
Test Limit:	Refer to 47 CFR 15.247(a)(1)(iii), Frequency hopping systems in the 2400-2483.5 MHz band shall use at least 15 channels. The average time of occupancy on any channel shall not be greater than 0.4 seconds within a period of 0.4 seconds multiplied by the number of hopping channels employed. Frequency hopping systems may avoid or suppress transmissions on a particular hopping frequency provided that a minimum of 15 channels are used.
Test Method:	ANSI C63.10-2013, section 7.8.3 KDB 558074 D01 15.247 Meas Guidance v05r02
Procedure:	<p>The EUT shall have its hopping function enabled. Use the following spectrum analyzer settings:</p> <ul style="list-style-type: none"> a) Span: The frequency band of operation. Depending on the number of channels the device supports, it may be necessary to divide the frequency range of operation across multiple spans, to allow the individual channels to be clearly seen. b) RBW: To identify clearly the individual channels, set the RBW to less than 30% of the channel spacing or the 20 dB bandwidth, whichever is smaller. c) VBW \geq RBW. d) Sweep: Auto. e) Detector function: Peak. f) Trace: Max hold. g) Allow the trace to stabilize. <p>It might prove necessary to break the span up into subranges to show clearly all of the hopping frequencies. Compliance of an EUT with the appropriate regulatory limit shall be determined for the number of hopping channels. A plot of the data shall be included in the test report.</p>

6.5.1 E.U.T. Operation:

Operating Environment:			
Temperature:	23.3 °C	Humidity:	60.7 %
Atmospheric Pressure:		100 kPa	
Test mode:	Mode1, Mode2		

6.5.2 Test Setup Diagram:

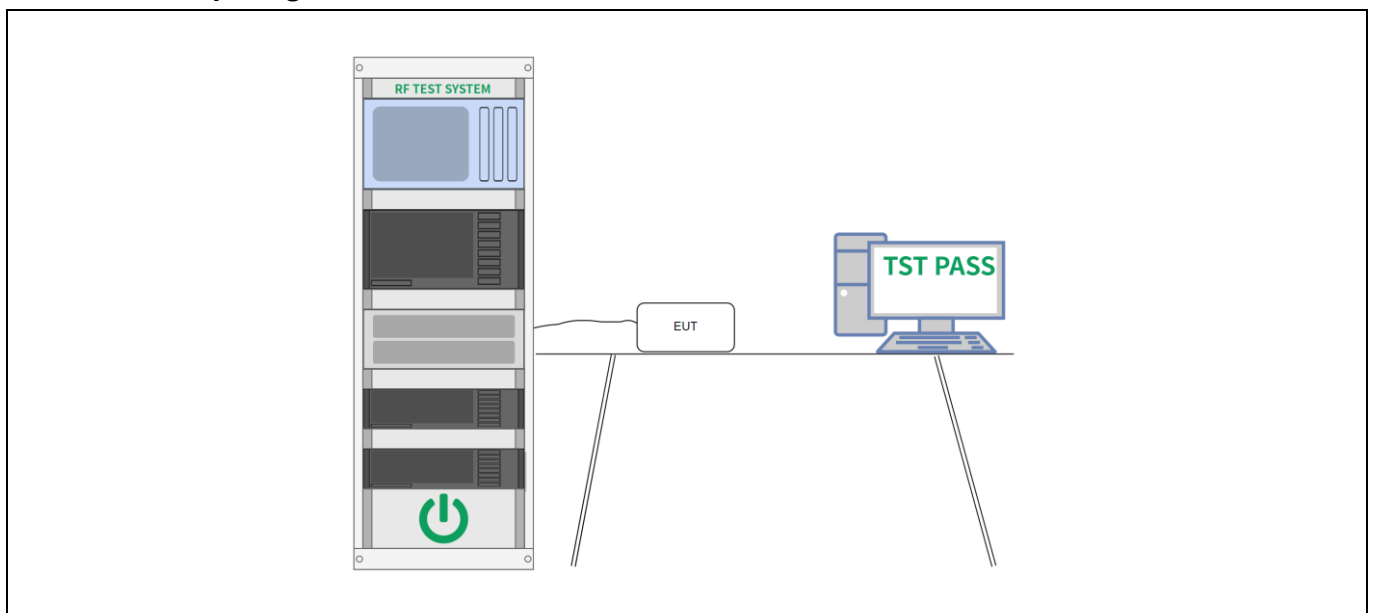

6.5.3 Test Data:

Please Refer to Appendix for Details.

6.6 Dwell Time

Test Requirement:	47 CFR 15.247(a)(1)(iii)
Test Limit:	Refer to 47 CFR 15.247(a)(1)(iii), Frequency hopping systems in the 2400-2483.5 MHz band shall use at least 15 channels. The average time of occupancy on any channel shall not be greater than 0.4 seconds within a period of 0.4 seconds multiplied by the number of hopping channels employed. Frequency hopping systems may avoid or suppress transmissions on a particular hopping frequency provided that a minimum of 15 channels are used.
Test Method:	ANSI C63.10-2013, section 7.8.4 KDB 558074 D01 15.247 Meas Guidance v05r02
Procedure:	<p>The EUT shall have its hopping function enabled. Use the following spectrum analyzer settings:</p> <p>a) Span: Zero span, centered on a hopping channel.</p> <p>b) RBW shall be \leq channel spacing and where possible RBW should be set $\gg 1 / T$, where T is the expected dwell time per channel.</p> <p>c) Sweep: As necessary to capture the entire dwell time per hopping channel; where possible use a video trigger and trigger delay so that the transmitted signal starts a little to the right of the start of the plot. The trigger level might need slight adjustment to prevent triggering when the system hops on an adjacent channel; a second plot might be needed with a longer sweep time to show two successive hops on a channel.</p> <p>d) Detector function: Peak.</p> <p>e) Trace: Max hold.</p> <p>Use the marker-delta function to determine the transmit time per hop. If this value varies with different modes of operation (data rate, modulation format, number of hopping channels, etc.), then repeat this test for each variation in transmit time.</p> <p>Repeat the measurement using a longer sweep time to determine the number of hops over the period specified in the requirements. The sweep time shall be equal to, or less than, the period specified in the requirements. Determine the number of hops over the sweep time and calculate the total number of hops in the period specified in the requirements, using the following equation:</p> $(\text{Number of hops in the period specified in the requirements}) = (\text{number of hops on spectrum analyzer}) \times (\text{period specified in the requirements} / \text{analyzer sweep time})$ <p>The average time of occupancy is calculated from the transmit time per hop multiplied by the number of hops in the period specified in the requirements. If the number of hops in a specific time varies with different modes of operation (data rate, modulation format, number of hopping channels, etc.), then repeat this test for each variation.</p> <p>The measured transmit time and time between hops shall be consistent with the values described in the operational description for the EUT.</p>

6.6.1 E.U.T. Operation:

Operating Environment:					
Temperature:	23.3 °C	Humidity:	60.7 %	Atmospheric Pressure:	100 kPa
Test mode:	Mode1, Mode2				

6.6.2 Test Setup Diagram:

--

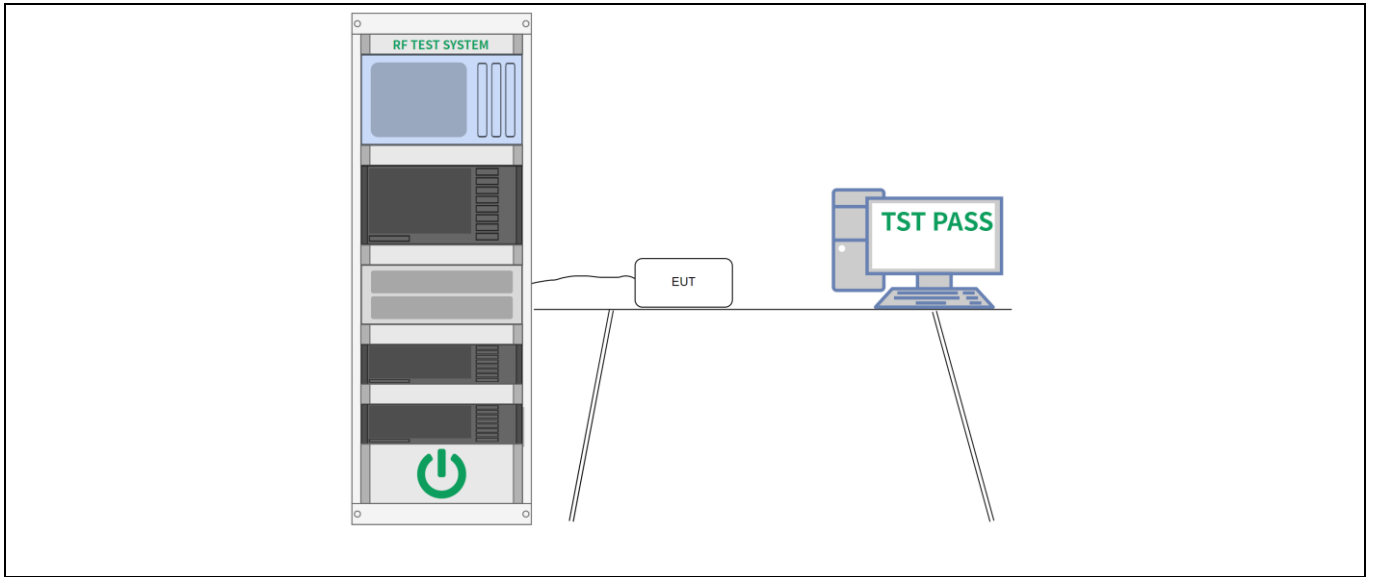

6.6.3 Test Data:

Please Refer to Appendix for Details.

6.7 RF conducted spurious emissions and band edge measurement

Test Requirement:	47 CFR 15.247(d)
Test Limit:	Refer to 47 CFR 15.247(d), In any 100 kHz bandwidth outside the frequency band in which the spread spectrum or digitally modulated intentional radiator is operating, the radio frequency power that is produced by the intentional radiator shall be at least 20 dB below that in the 100 kHz bandwidth within the band that contains the highest level of the desired power, based on either an RF conducted or a radiated measurement, provided the transmitter demonstrates compliance with the peak conducted power limits. If the transmitter complies with the conducted power limits based on the use of RMS averaging over a time interval, as permitted under paragraph (b)(3) of this section, the attenuation required under this paragraph shall be 30 dB instead of 20 dB. Attenuation below the general limits specified in § 15.209(a) is not required.
Test Method:	ANSI C63.10-2013 section 7.8.8 KDB 558074 D01 15.247 Meas Guidance v05r02
Procedure:	Conducted spurious emissions shall be measured for the transmit frequency, per 5.5 and 5.6, and at the maximum transmit powers. Connect the primary antenna port through an attenuator to the spectrum analyzer input; in the results, account for all losses between the unlicensed wireless device output and the spectrum analyzer. The instrument shall span 30 MHz to 10 times the operating frequency in GHz, with a resolution bandwidth of 100 kHz, video bandwidth of 300 kHz, and a coupled sweep time with a peak detector. The band 30 MHz to the highest frequency may be split into smaller spans, as long as the entire spectrum is covered.

6.7.1 E.U.T. Operation:

Operating Environment:					
Temperature:	23.3 °C	Humidity:	60.7 %	Atmospheric Pressure:	100 kPa
Test mode:	Mode1, Mode2				

6.7.2 Test Setup Diagram:

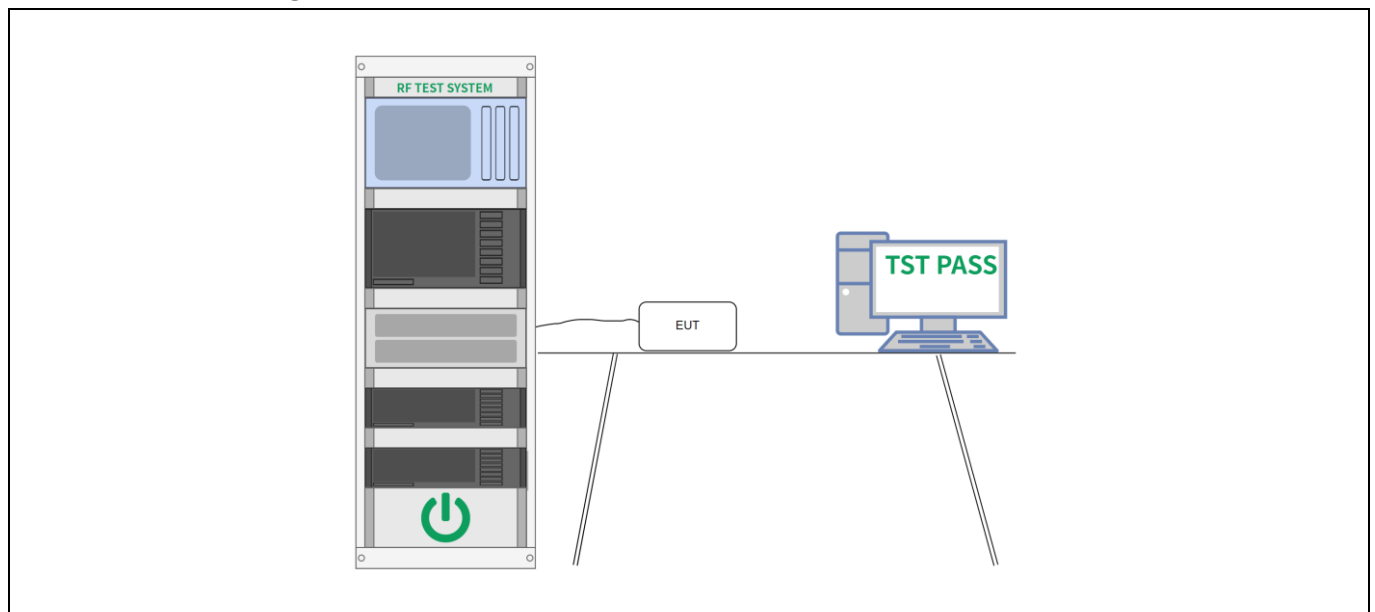

6.7.3 Test Data:

Please Refer to Appendix for Details.

6.8 Band edge emissions (Radiated)

Test Requirement:	Refer to 47 CFR 15.247(d), In addition, radiated emissions which fall in the restricted bands, as defined in § 15.205(a), must also comply with the radiated emission limits specified in § 15.209(a)(see § 15.205(c)).`		
Test Limit:	Frequency (MHz)	Field strength (microvolts/meter)	Measurement distance (meters)
	0.009-0.490	2400/F(kHz)	300
	0.490-1.705	24000/F(kHz)	30
	1.705-30.0	30	30
	30-88	100 **	3
	88-216	150 **	3
	216-960	200 **	3
	Above 960	500	3
	** Except as provided in paragraph (g), fundamental emissions from intentional radiators operating under this section shall not be located in the frequency bands 54-72 MHz, 76-88 MHz, 174-216 MHz or 470-806 MHz. However, operation within these frequency bands is permitted under other sections of this part, e.g., §§ 15.231 and 15.241.		
Test Method:	ANSI C63.10-2013 section 6.10 KDB 558074 D01 15.247 Meas Guidance v05r02		
Procedure:	ANSI C63.10-2013 section 6.10.5.2		

6.8.1 E.U.T. Operation:

Operating Environment:			
Temperature:	21.4 °C	Humidity:	21.1 %
		Atmospheric Pressure:	100 kPa
Test mode:	Mode1, Mode2		
Note: The amplitude of spurious emissions which are attenuated more than 20 dB below the limits are not reported.			

6.8.2 Test Setup Diagram:

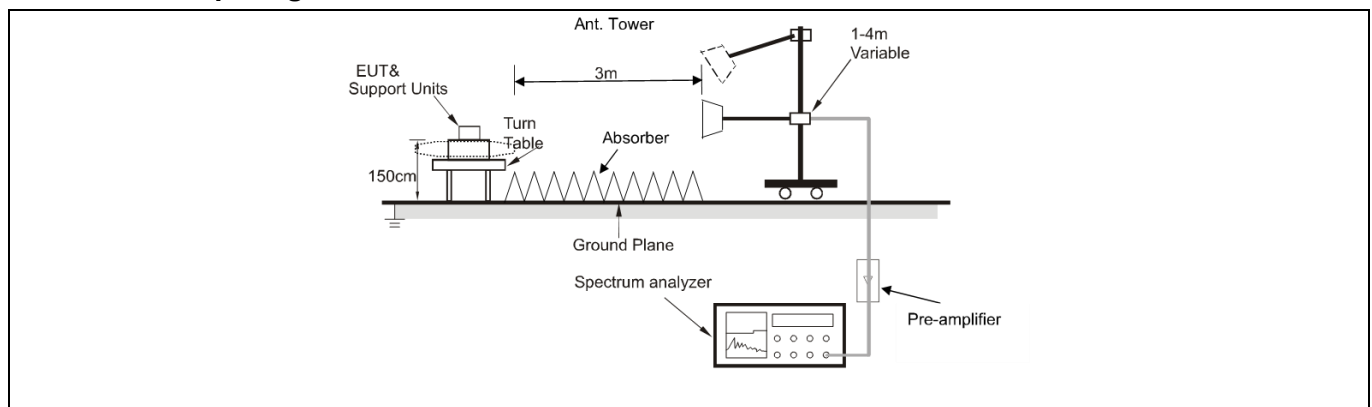

6.8.3 Test Data:

Mode1 / Polarization: Horizontal / Band: 2400-2483.5 MHz / BW: 1 / CH: 2402

No.	Mk.	Freq.	Reading Level	Correct Factor	Measurement	Limit	Over	Detector
		MHz	dBuV	dB	dBuV/m	dBuV/m	dB	
1		2310.000	49.90	-2.66	47.24	74.00	-26.76	peak
2		2310.000	40.58	-2.66	37.92	54.00	-16.08	AVG
3		2390.000	54.47	-2.03	52.44	74.00	-21.56	peak
4	*	2390.000	44.75	-2.03	42.72	54.00	-11.28	AVG

Mode1 / Polarization: Vertical / Band: 2400-2483.5 MHz / BW: 1 / CH: 2402

No.	Mk.	Freq.	Reading Level	Correct Factor	Measurement	Limit	Over	Detector
		MHz	dBuV	dB	dBuV/m	dBuV/m	dB	
1		2310.000	50.84	-2.66	48.18	74.00	-25.82	peak
2	*	2310.000	41.98	-2.66	39.32	54.00	-14.68	AVG
3		2390.000	40.93	-2.66	38.27	54.00	-15.73	AVG
4		2390.000	50.92	-2.03	48.89	74.00	-25.11	peak

Mode1 / Polarization: Horizontal / Band: 2400-2483.5 MHz / BW: 1 / CH: 2480

No.	Mk.	Freq.	Reading Level	Correct Factor	Measurement	Limit	Over	Detector
		MHz	dBuV	dB	dBuV/m	dBuV/m	dB	
1		2483.500	51.22	-1.91	49.31	74.00	-24.69	peak
2		2483.500	41.67	-1.91	39.76	54.00	-14.24	AVG
3		2500.000	51.08	-1.80	49.28	74.00	-24.72	peak
4	*	2500.000	42.14	-1.80	40.34	54.00	-13.66	AVG

Mode1 / Polarization: Vertical / Band: 2400-2483.5 MHz / BW: 1 / CH: 2480

No.	Mk.	Freq.	Reading Level	Correct Factor	Measurement	Limit	Over	Detector
		MHz	dBuV	dB	dBuV/m	dBuV/m	dB	
1		2483.500	49.63	-1.91	47.72	74.00	-26.28	peak
2	*	2483.500	41.51	-1.91	39.60	54.00	-14.40	AVG
3		2500.000	51.41	-1.80	49.61	74.00	-24.39	peak
4		2500.000	41.33	-1.80	39.53	54.00	-14.47	AVG

6.9 Radiated emissions (below 1GHz)

Test Requirement:	Refer to 47 CFR 15.247(d), In addition, radiated emissions which fall in the restricted bands, as defined in § 15.205(a), must also comply with the radiated emission limits specified in § 15.209(a)(see § 15.205(c)).`		
Test Limit:	Frequency (MHz)	Field strength (microvolts/meter)	Measurement distance (meters)
	0.009-0.490	2400/F(kHz)	300
	0.490-1.705	24000/F(kHz)	30
	1.705-30.0	30	30
	30-88	100 **	3
	88-216	150 **	3
	216-960	200 **	3
	Above 960	500	3
	** Except as provided in paragraph (g), fundamental emissions from intentional radiators operating under this section shall not be located in the frequency bands 54-72 MHz, 76-88 MHz, 174-216 MHz or 470-806 MHz. However, operation within these frequency bands is permitted under other sections of this part, e.g., §§ 15.231 and 15.241.		
Test Method:	ANSI C63.10-2013 section 6.6.4 KDB 558074 D01 15.247 Meas Guidance v05r02		
Procedure:	ANSI C63.10-2013 section 6.6.4		

6.9.1 E.U.T. Operation:

Operating Environment:			
Temperature:	28.5 °C	Humidity:	24.3 %
		Atmospheric Pressure:	100 kPa
Test mode:	Mode1, Mode2		
Note: The amplitude of spurious emissions which are attenuated more than 20 dB below the limits are not reported. All modes of operation of the EUT were investigated, and only the worst-case results are reported. There were no emissions found below 30MHz within 20dB of the limit.			

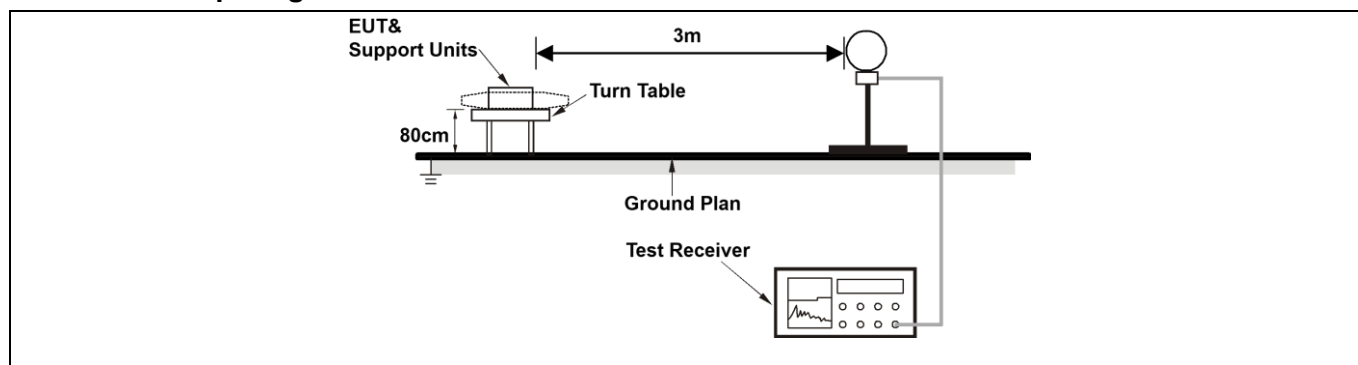
6.9.2 Test Setup Diagram:

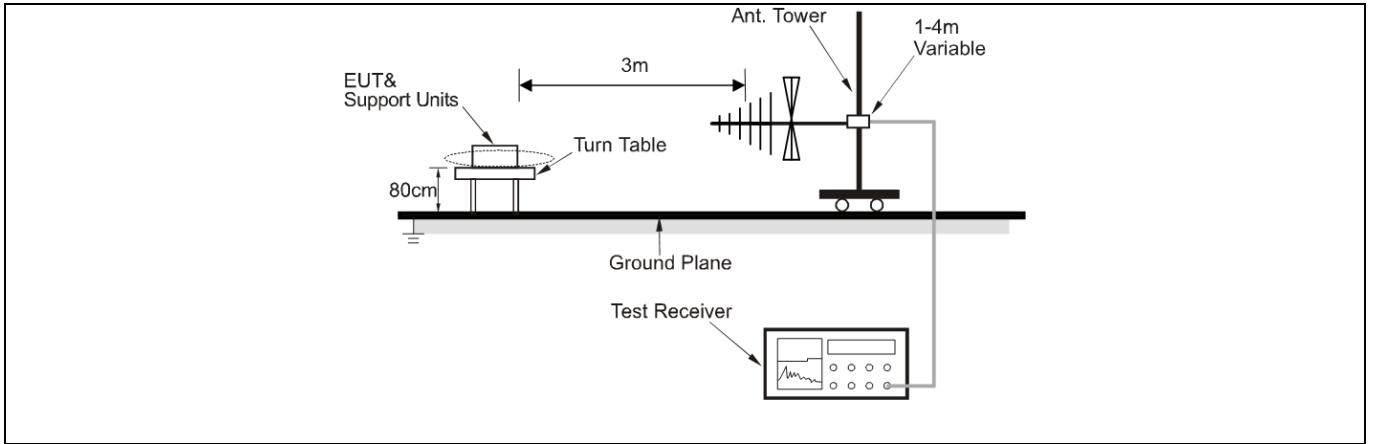

6.9.3 Test Data:

Mode1 / Polarization: Horizontal / Band: 2400-2483.5 MHz / BW: 1 / CH: 2480

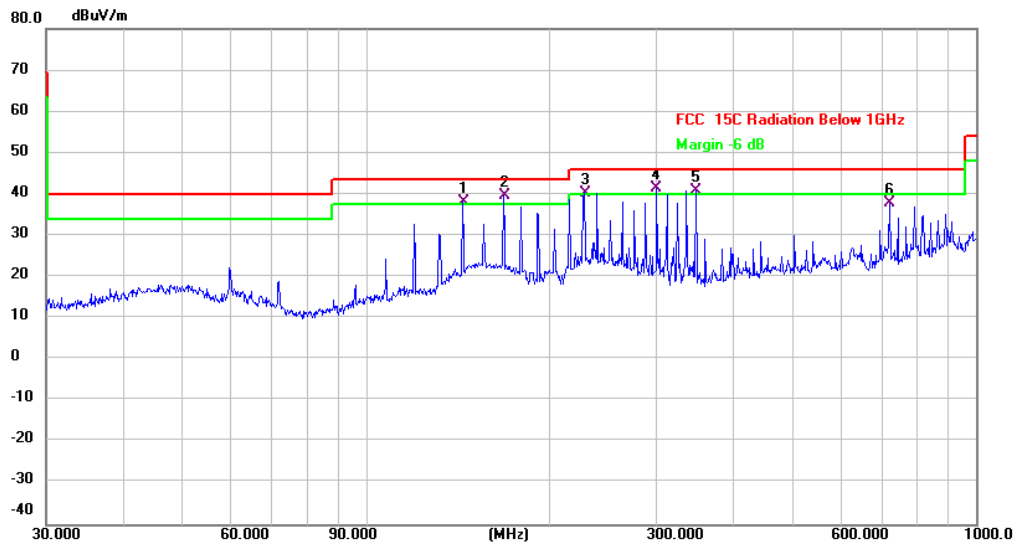

No.	Mk.	Freq. MHz	Reading Level dBuV	Correct Factor dB	Measure- ment dBuV/m	Limit dBuV/m	Over dB	Detector	Comment
1	!	143.8295	48.73	-10.56	38.17	43.50	-5.33	QP	
2	*	167.8242	50.80	-11.01	39.79	43.50	-3.71	QP	
3	!	228.4904	48.05	-7.67	40.38	46.00	-5.62	QP	
4	!	300.3672	46.33	-4.75	41.58	46.00	-4.42	QP	
5	!	348.0274	45.20	-4.37	40.83	46.00	-5.17	QP	
6		721.7258	37.26	0.47	37.73	46.00	-8.27	QP	

Mode1 / Polarization: Vertical / Band: 2400-2483.5 MHz / BW: 1 / CH: 2480

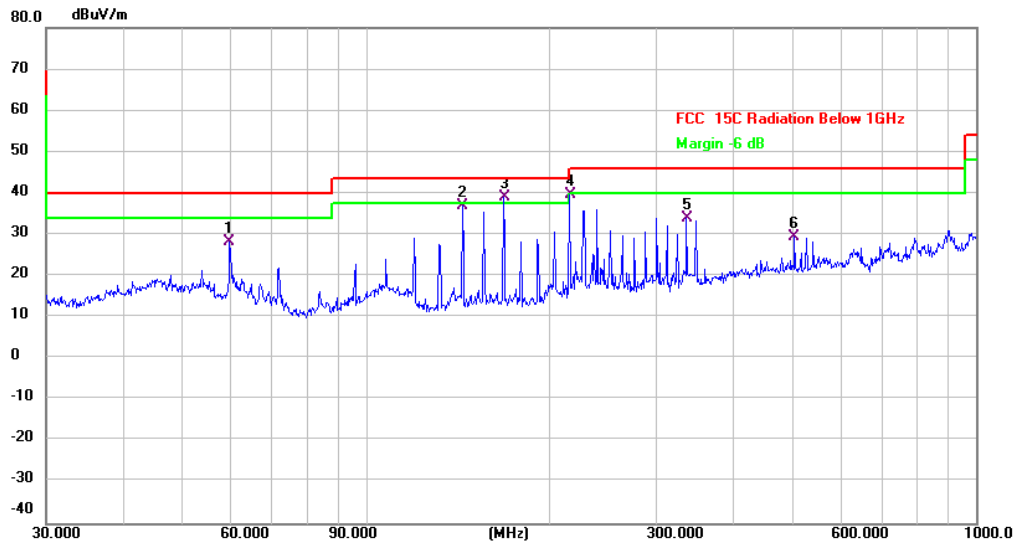

No.	Mk.	Freq. MHz	Reading Level dBuV	Correct Factor dB	Measure- ment dBuV/m	Limit dBuV/m	Over dB	Detector	Comment
1		59.8588	37.90	-9.79	28.11	40.00	-11.89	QP	
2		143.8295	47.66	-10.56	37.10	43.50	-6.40	QP	
3	*	167.8243	50.15	-11.01	39.14	43.50	-4.36	QP	
4		216.0240	48.61	-8.98	39.63	46.00	-6.37	QP	
5		336.0352	38.15	-4.13	34.02	46.00	-11.98	QP	
6		504.7062	33.06	-3.50	29.56	46.00	-16.44	QP	

6.10 Radiated emissions (above 1GHz)

Test Requirement:	In addition, radiated emissions which fall in the restricted bands, as defined in § 15.205(a), must also comply with the radiated emission limits specified in § 15.209(a)(see § 15.205(c)).`		
Test Limit:	Frequency (MHz)	Field strength (microvolts/meter)	Measurement distance (meters)
	0.009-0.490	2400/F(kHz)	300
	0.490-1.705	24000/F(kHz)	30
	1.705-30.0	30	30
	30-88	100 **	3
	88-216	150 **	3
	216-960	200 **	3
	Above 960	500	3
	** Except as provided in paragraph (g), fundamental emissions from intentional radiators operating under this section shall not be located in the frequency bands 54-72 MHz, 76-88 MHz, 174-216 MHz or 470-806 MHz. However, operation within these frequency bands is permitted under other sections of this part, e.g., §§ 15.231 and 15.241.		
Test Method:	ANSI C63.10-2013 section 6.6.4 KDB 558074 D01 15.247 Meas Guidance v05r02		
Procedure:	ANSI C63.10-2013 section 6.6.4		

6.10.1 E.U.T. Operation:

Operating Environment:			
Temperature:	28.5 °C	Humidity:	24.3 %
		Atmospheric Pressure:	100 kPa
Test mode:	Mode1, Mode2		
Note: Test frequency are from 1GHz to 25GHz, the amplitude of spurious emissions which are attenuated more than 20 dB below the limits are not reported. All modes of operation of the EUT were investigated, and only the worst-case results are reported.			

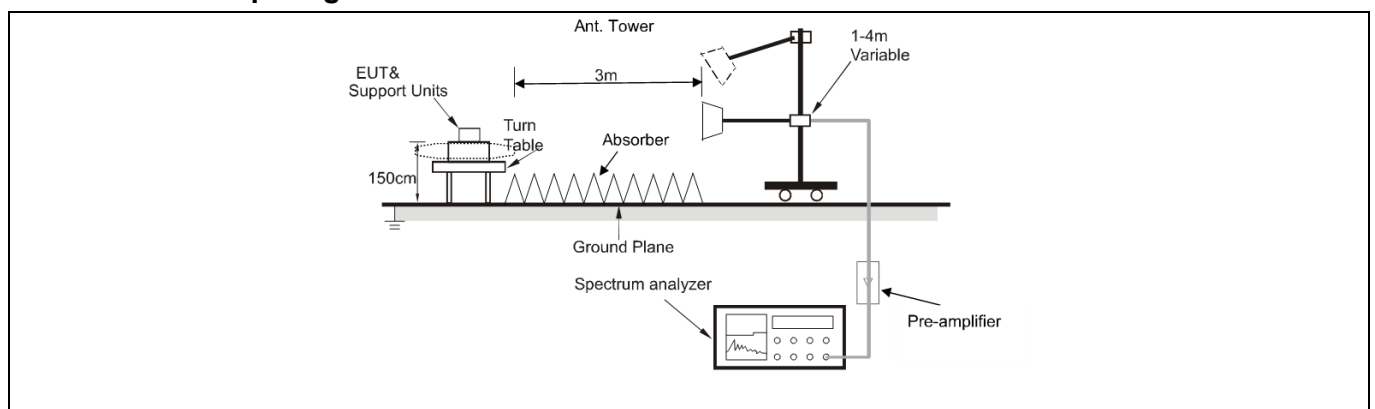
6.10.2 Test Setup Diagram:

6.10.3 Test Data:

Mode1 / Polarization: Horizontal / Band: 2400-2483.5 MHz / BW: 1 / CH: 2402

No.	Mk.	Freq.	Reading Level	Correct Factor	Measurement	Limit	Over	Detector
		MHz	dBuV	dB	dBuV/m	dBuV/m	dB	
1		4804.000	47.46	2.74	50.20	74.00	-23.80	peak
2		4804.000	41.51	2.74	44.25	54.00	-9.75	AVG
3		7206.000	45.45	9.34	54.79	74.00	-19.21	peak
4	*	7206.000	39.41	9.34	48.75	54.00	-5.25	AVG
5		9608.000	42.35	10.49	52.84	74.00	-21.16	peak
6		9608.000	36.36	10.49	46.85	54.00	-7.15	AVG

Mode1 / Polarization: Vertical / Band: 2400-2483.5 MHz / BW: 1 / CH: 2402

No.	Mk.	Freq.	Reading Level	Correct Factor	Measurement	Limit	Over	Detector
		MHz	dBuV	dB	dBuV/m	dBuV/m	dB	
1		4804.000	43.06	2.74	45.80	74.00	-28.20	peak
2		4804.000	36.72	2.74	39.46	54.00	-14.54	AVG
3		7206.000	42.76	9.34	52.10	74.00	-21.90	peak
4		7206.000	36.88	9.34	46.22	54.00	-7.78	AVG
5		9608.000	44.90	10.49	55.39	74.00	-18.61	peak
6	*	9608.000	38.79	10.49	49.28	54.00	-4.72	AVG

Mode1 / Polarization: Horizontal / Band: 2400-2483.5 MHz / BW: 1 / CH: 2441

No.	Mk.	Freq.	Reading Level	Correct Factor	Measurement	Limit	Over	Detector
		MHz	dBuV	dB	dBuV/m	dBuV/m	dB	
1		4882.000	47.53	3.07	50.60	74.00	-23.40	peak
2		4882.000	41.29	3.07	44.36	54.00	-9.64	AVG
3		7320.000	41.51	9.02	50.53	74.00	-23.47	peak
4		7320.000	35.83	9.02	44.85	54.00	-9.15	AVG
5		9764.000	44.13	12.03	56.16	74.00	-17.84	peak
6	*	9764.000	38.30	12.03	50.33	54.00	-3.67	AVG

Mode1 / Polarization: Vertical / Band: 2400-2483.5 MHz / BW: 1 / CH: 2441

No.	Mk.	Freq.	Reading Level	Correct Factor	Measurement	Limit	Over	Detector
		MHz	dBuV	dB	dBuV/m	dBuV/m	dB	
1		4882.000	43.49	3.07	46.56	74.00	-27.44	peak
2		4882.000	38.58	3.07	41.65	54.00	-12.35	AVG
3		7320.000	39.97	9.02	48.99	74.00	-25.01	peak
4		7320.000	34.83	9.02	43.85	54.00	-10.15	AVG
5		9764.000	42.88	12.03	54.91	74.00	-19.09	peak
6	*	9764.000	37.45	12.03	49.48	54.00	-4.52	AVG

Mode1 / Polarization: Horizontal / Band: 2400-2483.5 MHz / BW: 1 / CH: 2480

No.	Mk.	Freq.	Reading Level	Correct Factor	Measurement	Limit	Over	Detector
		MHz	dBuV	dB	dBuV/m	dBuV/m	dB	
1		4960.000	47.39	3.52	50.91	74.00	-23.09	peak
2		4960.000	40.44	3.52	43.96	54.00	-10.04	AVG
3		7440.000	40.85	9.16	50.01	74.00	-23.99	peak
4		7440.000	34.96	9.16	44.12	54.00	-9.88	AVG
5		9920.000	45.34	11.74	57.08	74.00	-16.92	peak
6	*	9920.000	38.28	11.74	50.02	54.00	-3.98	AVG

Mode1 / Polarization: Vertical / Band: 2400-2483.5 MHz / BW: 1 / CH: 2480

No.	Mk.	Freq.	Reading Level	Correct Factor	Measurement	Limit	Over	Detector
		MHz	dBuV	dB	dBuV/m	dBuV/m	dB	
1		4960.000	42.71	3.52	46.23	74.00	-27.77	peak
2		4960.000	36.73	3.52	40.25	54.00	-13.75	AVG
3		7440.000	39.08	9.16	48.24	74.00	-25.76	peak
4		7440.000	32.95	9.16	42.11	54.00	-11.89	AVG
5		9920.000	41.29	11.74	53.03	74.00	-20.97	peak
6	*	9920.000	34.26	11.74	46.00	54.00	-8.00	AVG

Photographs of the test setup

Refer to Appendix - test Photos

Photographs of the EUT

Refer to Appendix - EUT Photos

Appendix

Appendix A: 20dB Emission Bandwidth

Test Result

Test Mode	Antenna	Frequency [MHz]	20db EBW [MHz]
DH5	Ant1	2402	1.035
		2441	1.053
		2480	1.053
2DH5	Ant1	2402	1.302
		2441	1.338
		2480	1.353

Test Graphs

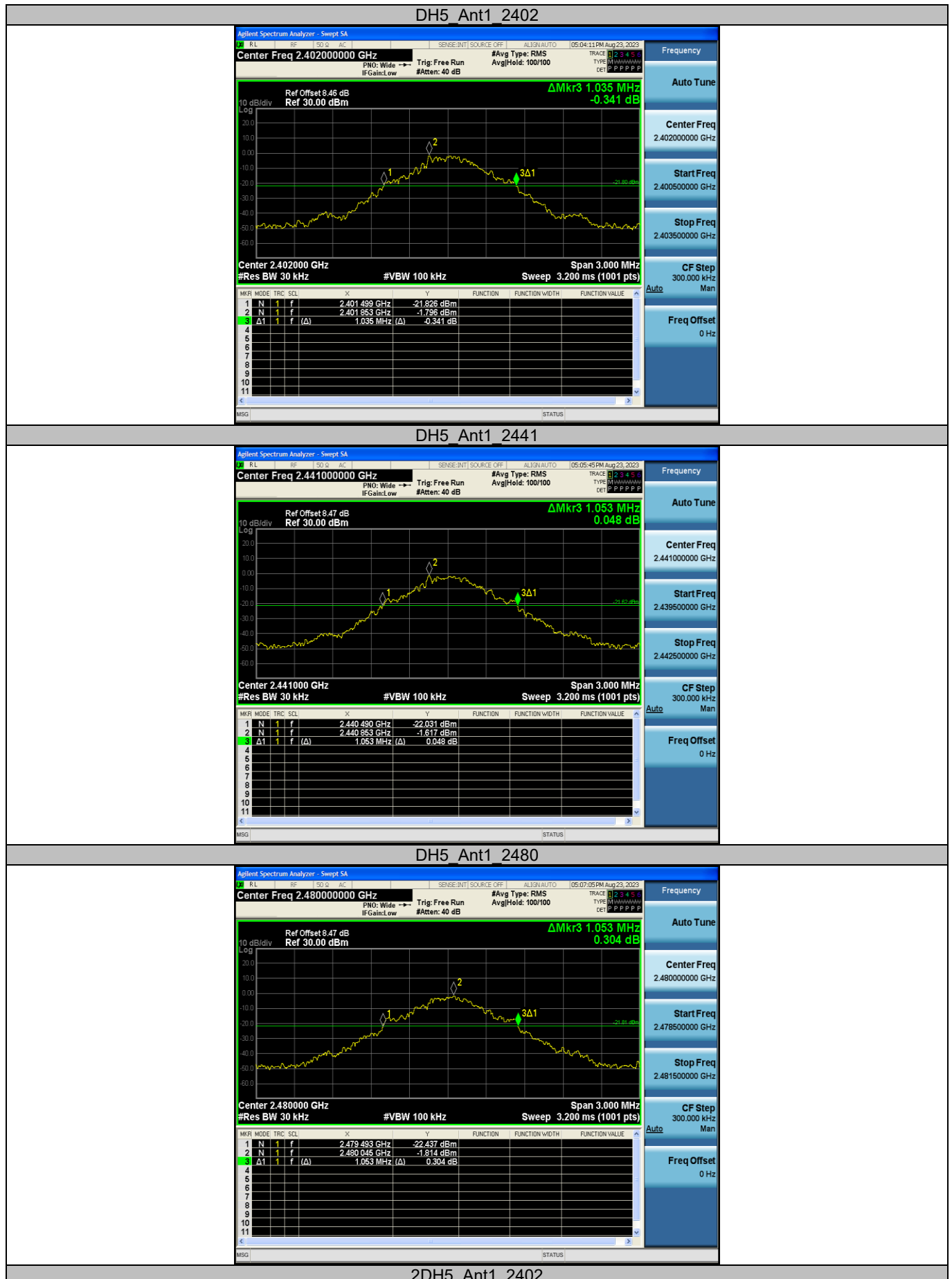



2DH5 Ant1 2441



2DH5 Ant1 2480



Appendix B: Maximum conducted output power

Test Result Peak

Test Mode	Antenna	Frequency [MHz]	Conducted Peak Power [dBm]	Limit [dBm]	Verdict
DH5	Ant1	2402	1.03	≤20.97	PASS
		2441	1.36	≤20.97	PASS
		2480	0.93	≤20.97	PASS
2DH5	Ant1	2402	1.91	≤20.97	PASS
		2441	2.06	≤20.97	PASS
		2480	1.66	≤20.97	PASS

Test Graphs

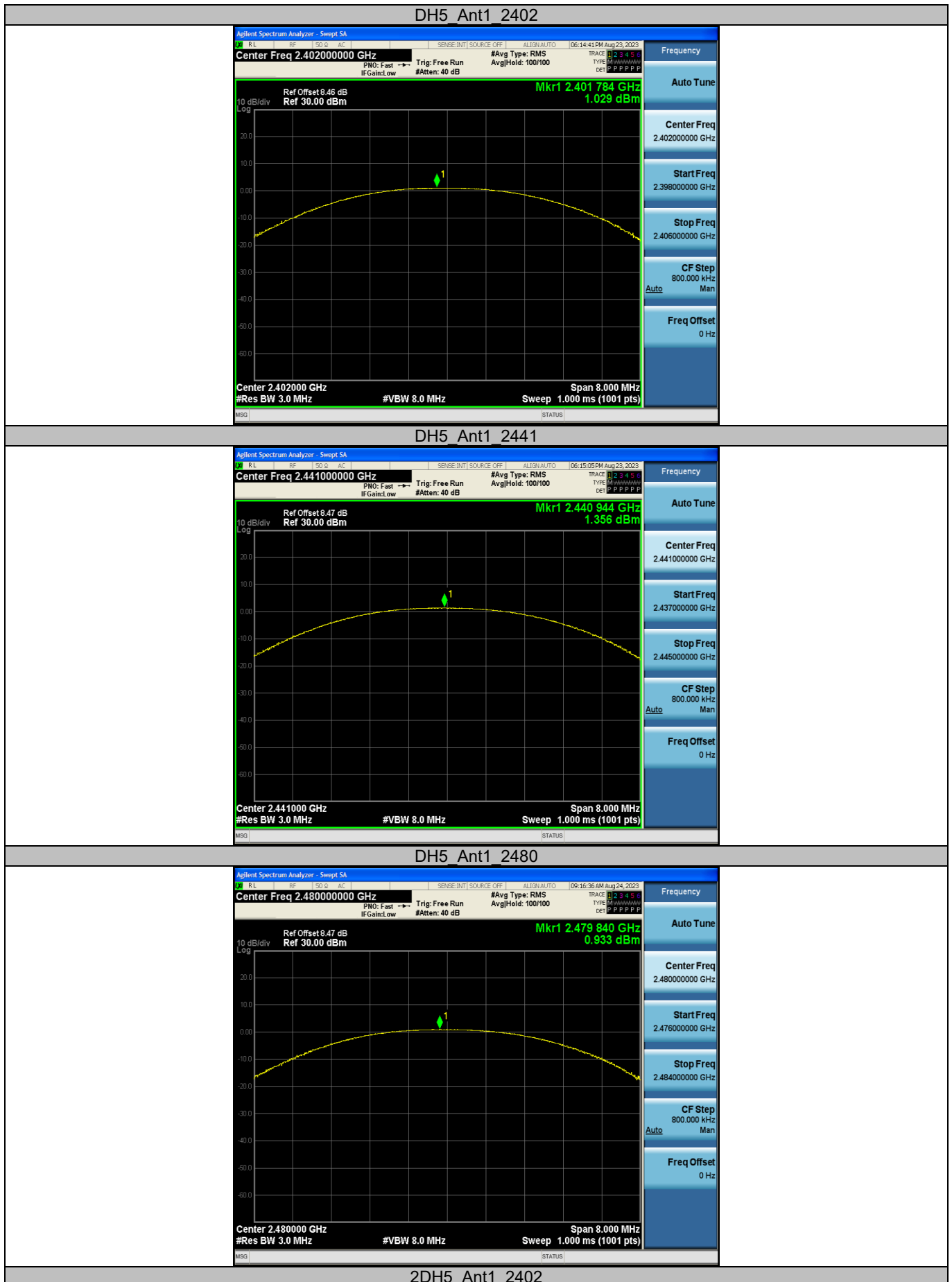

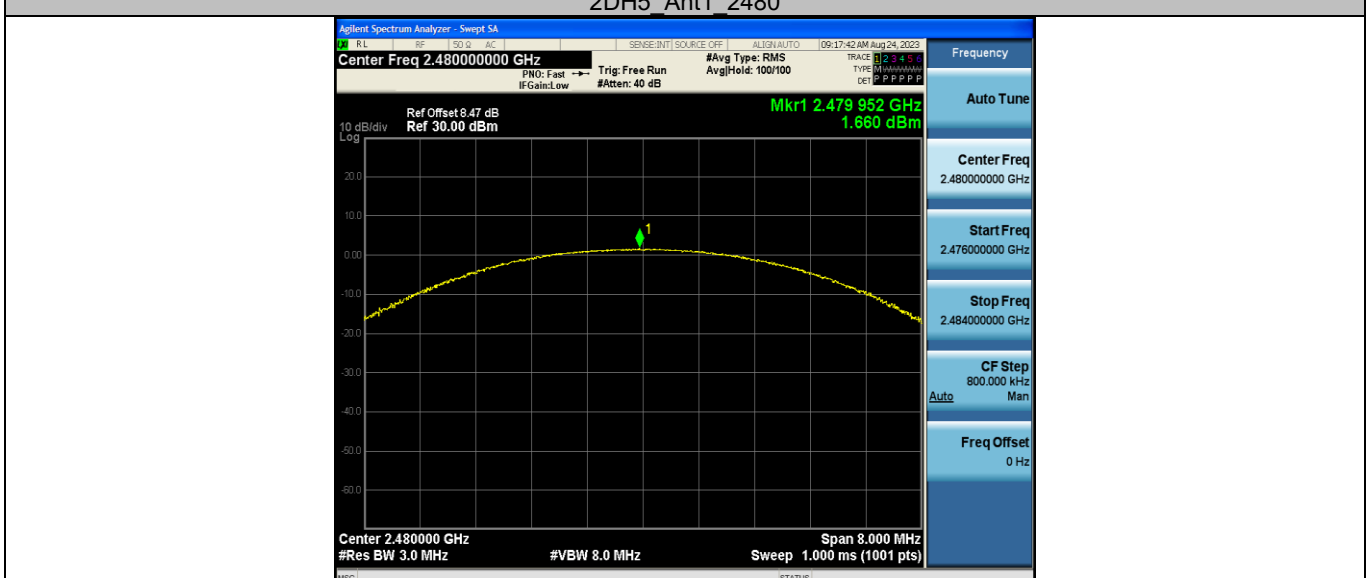
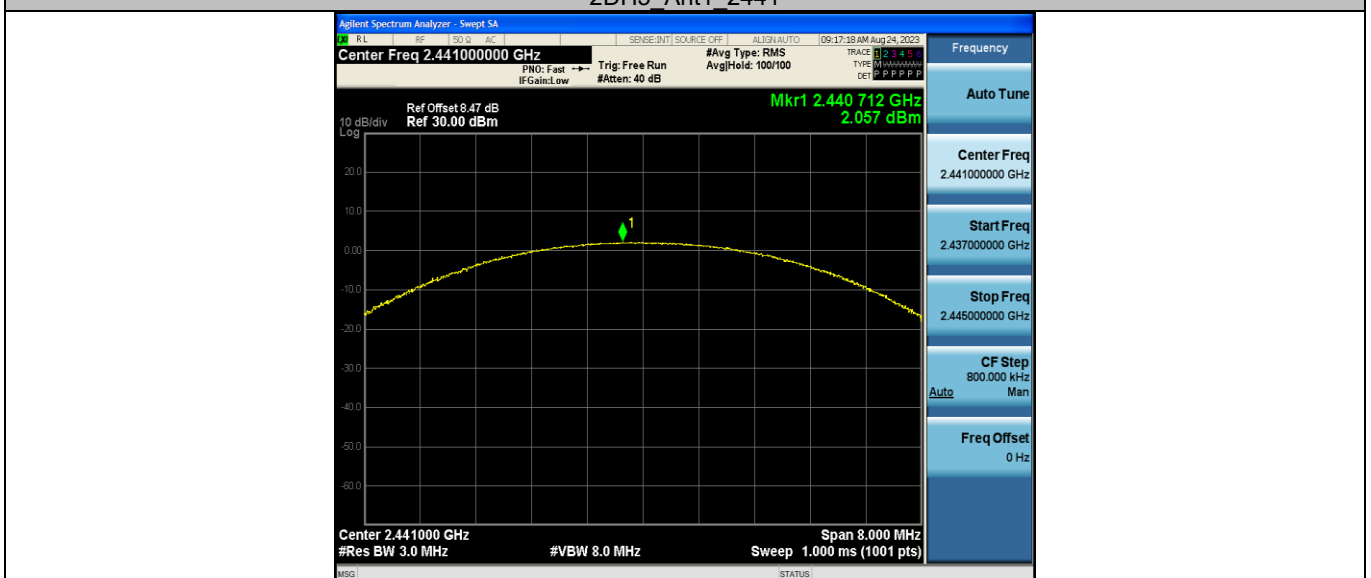
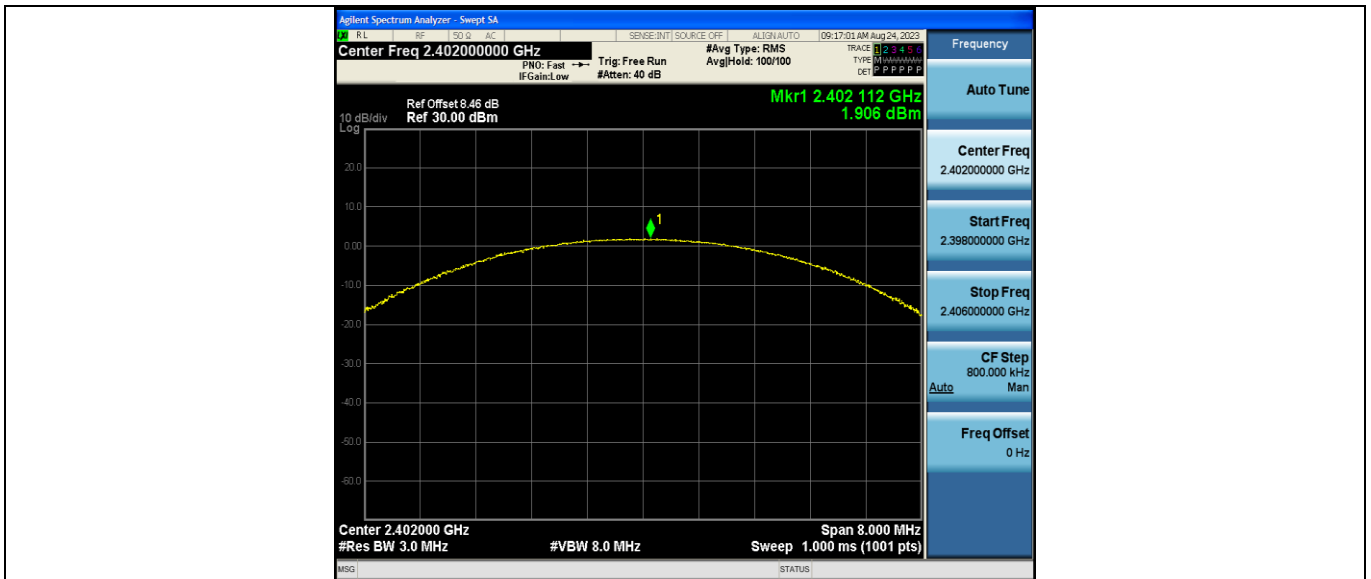

Appendix C: Carrier frequency separation

Test Result

Test Mode	Antenna	Frequency [MHz]	Result [MHz]	Limit [MHz]	Verdict
DH5	Ant1	Hop	0.994	≥ 0.702	PASS
2DH5	Ant1	Hop	0.994	≥ 0.902	PASS

Test Graphs

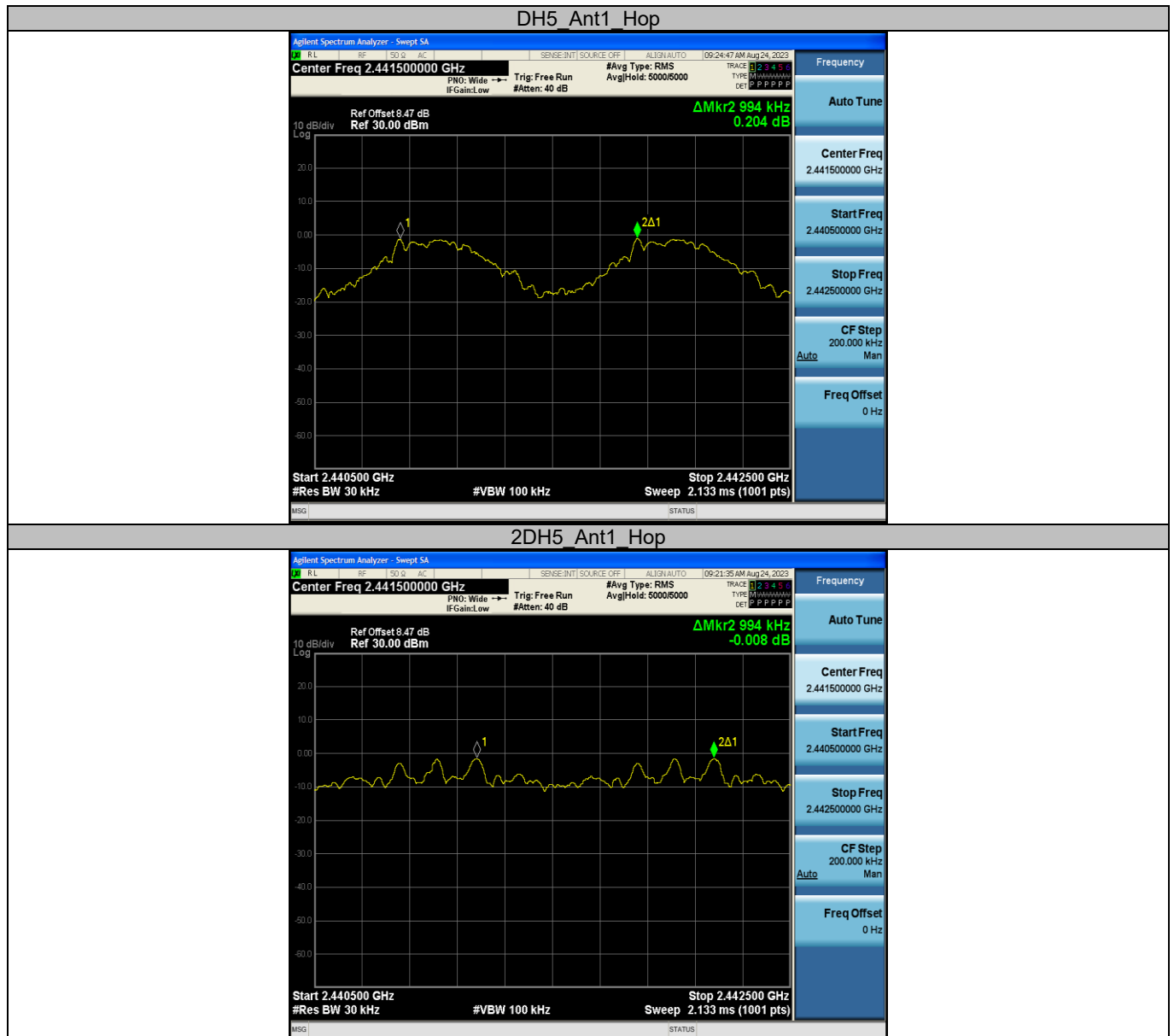

Appendix D: Time of occupancy

Test Result

Test Mode	Antenna	Frequency [MHz]	BurstWidth [ms]	Hops in 31.6s [Num]	Result [s]	Limit [s]	Verdict
DH1	Ant1	Hop	0.375	319	0.12	≤0.4	PASS
DH3	Ant1	Hop	1.631	157	0.256	≤0.4	PASS
DH5	Ant1	Hop	2.878	109	0.314	≤0.4	PASS
2DH1	Ant1	Hop	0.385	315	0.121	≤0.4	PASS
2DH3	Ant1	Hop	1.637	156	0.255	≤0.4	PASS
2DH5	Ant1	Hop	2.885	112	0.323	≤0.4	PASS

Notes:

1. Period time = $0.4s * 79 = 31.6s$
2. Result (Time of occupancy) = $BurstWidth[ms] * Hops\ in\ 31.6s\ [Num]$

Test Graphs

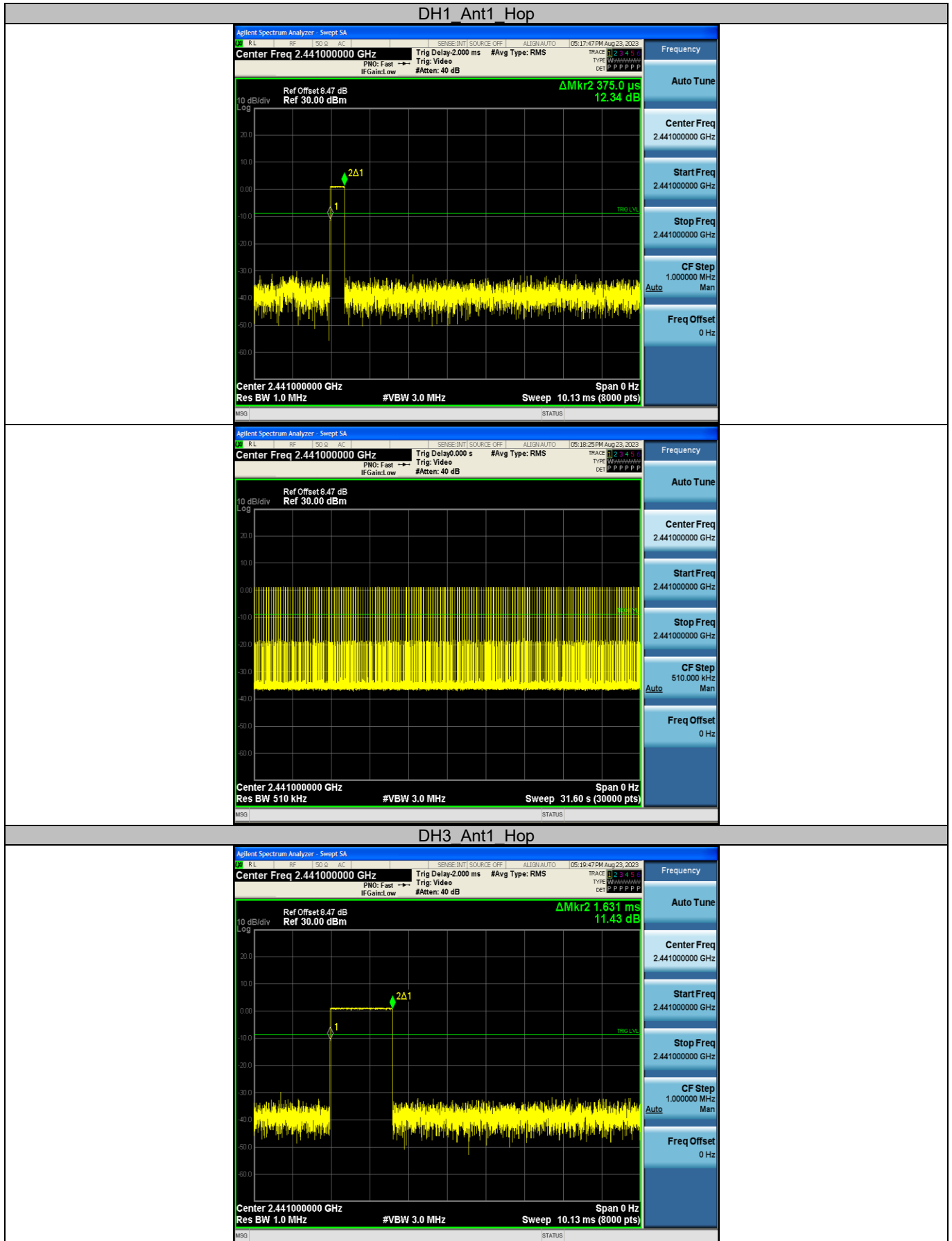

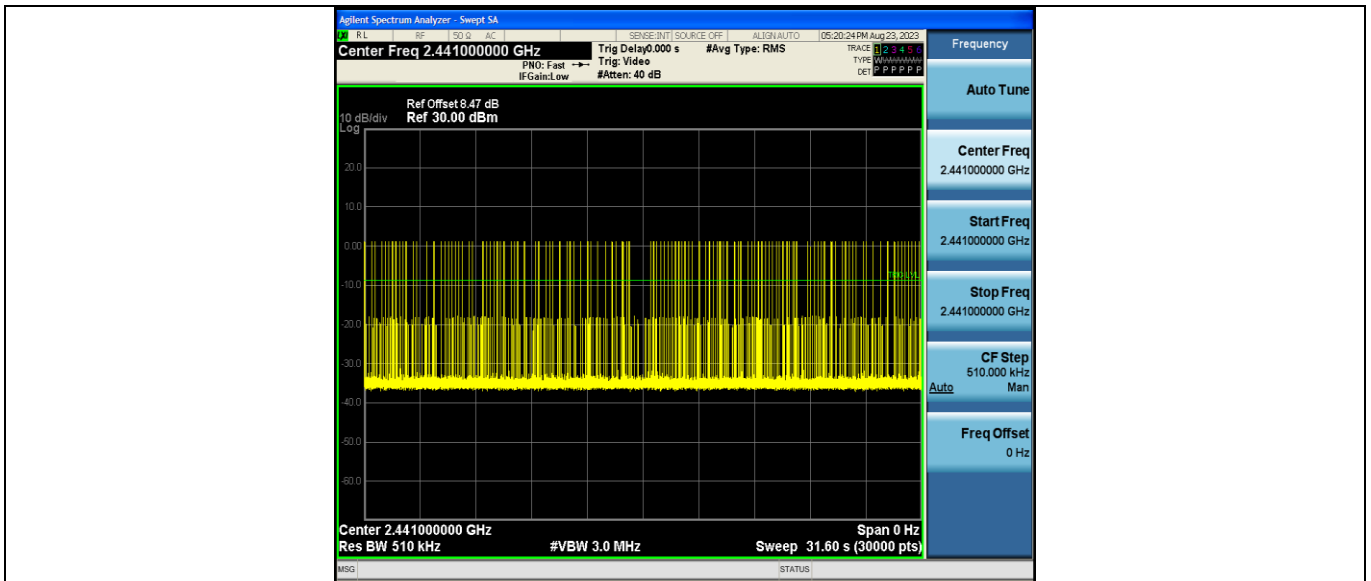

DH5_Ant1_Hop

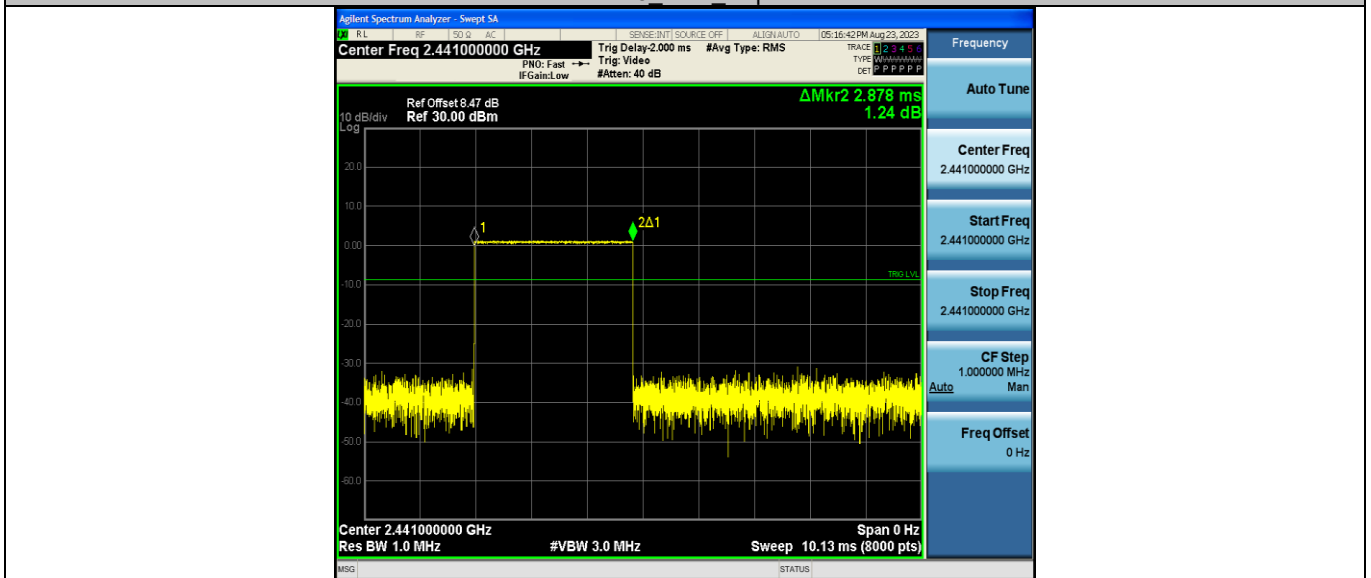

2DH1_Ant1_Hop

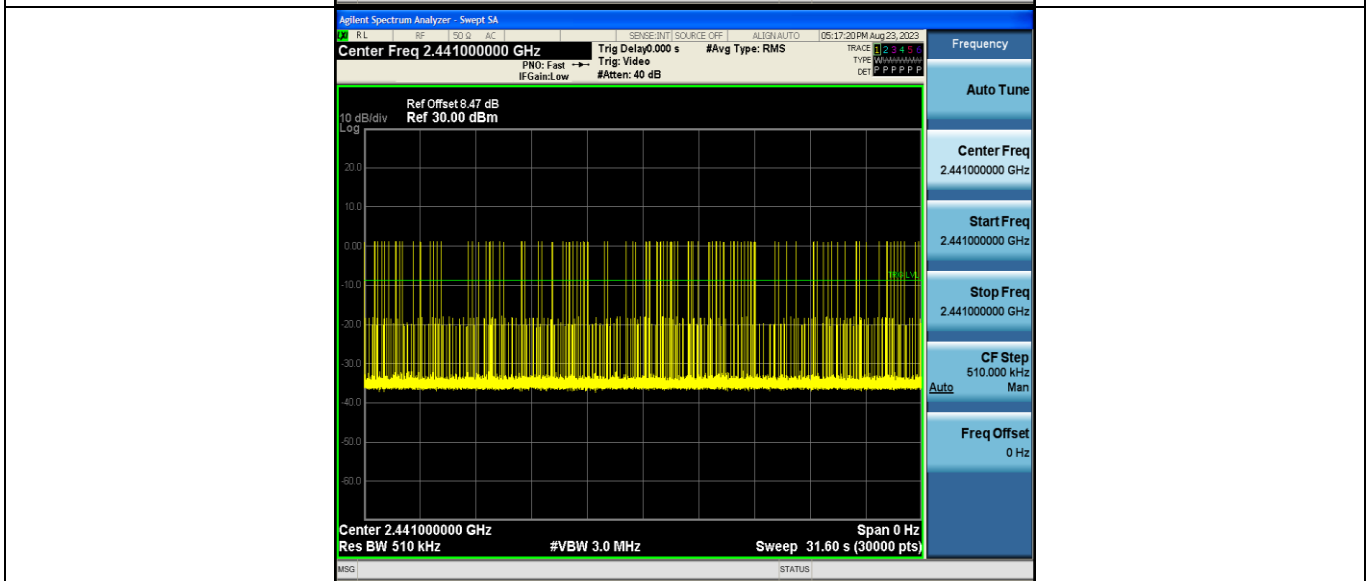

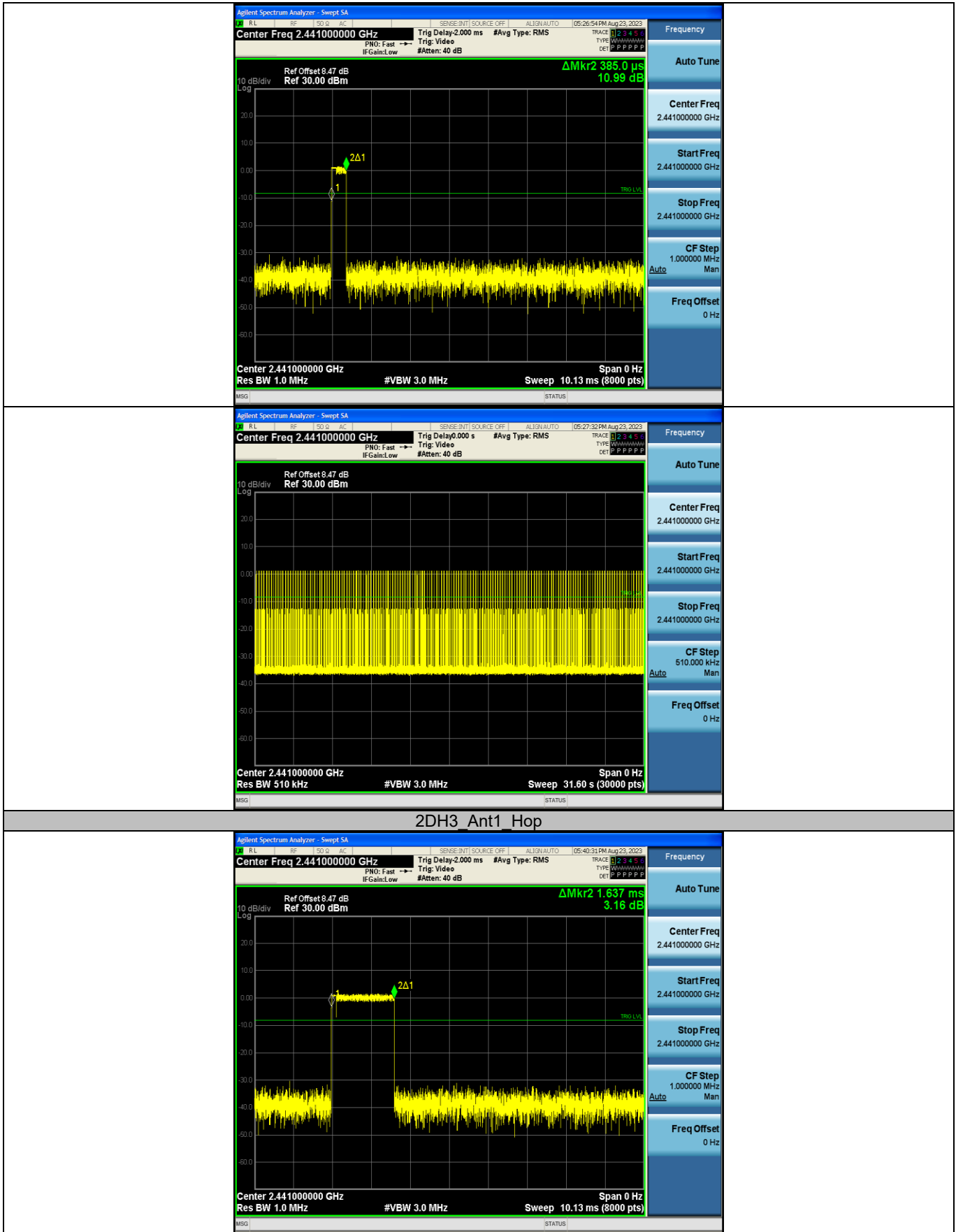

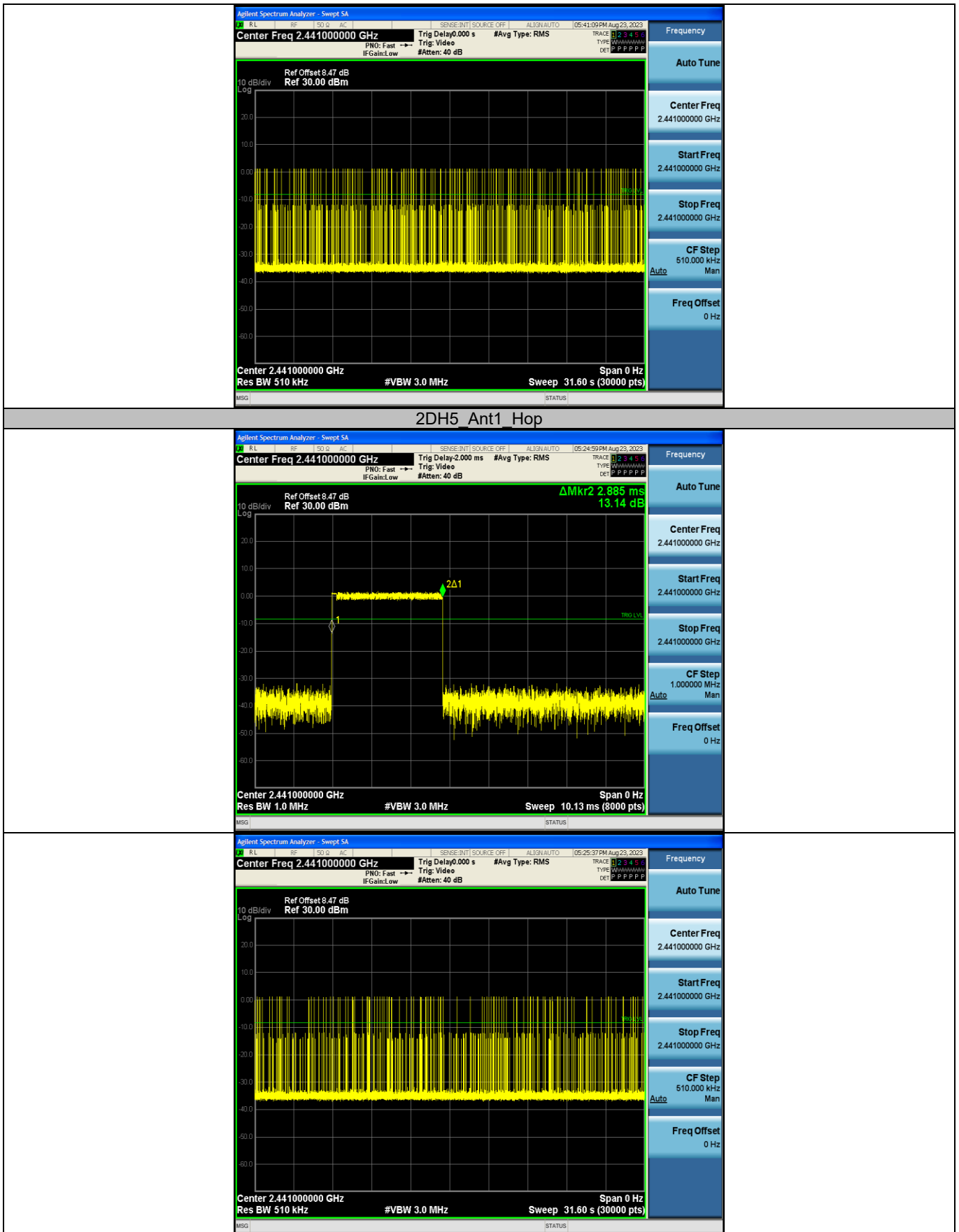

Appendix E: Number of hopping channels

Test Result

Test Mode	Antenna	Frequency [MHz]	Result [Num]	Limit [Num]	Verdict
DH5	Ant1	Hop	79	≥15	PASS
2DH5	Ant1	Hop	79	≥15	PASS

Test Graphs

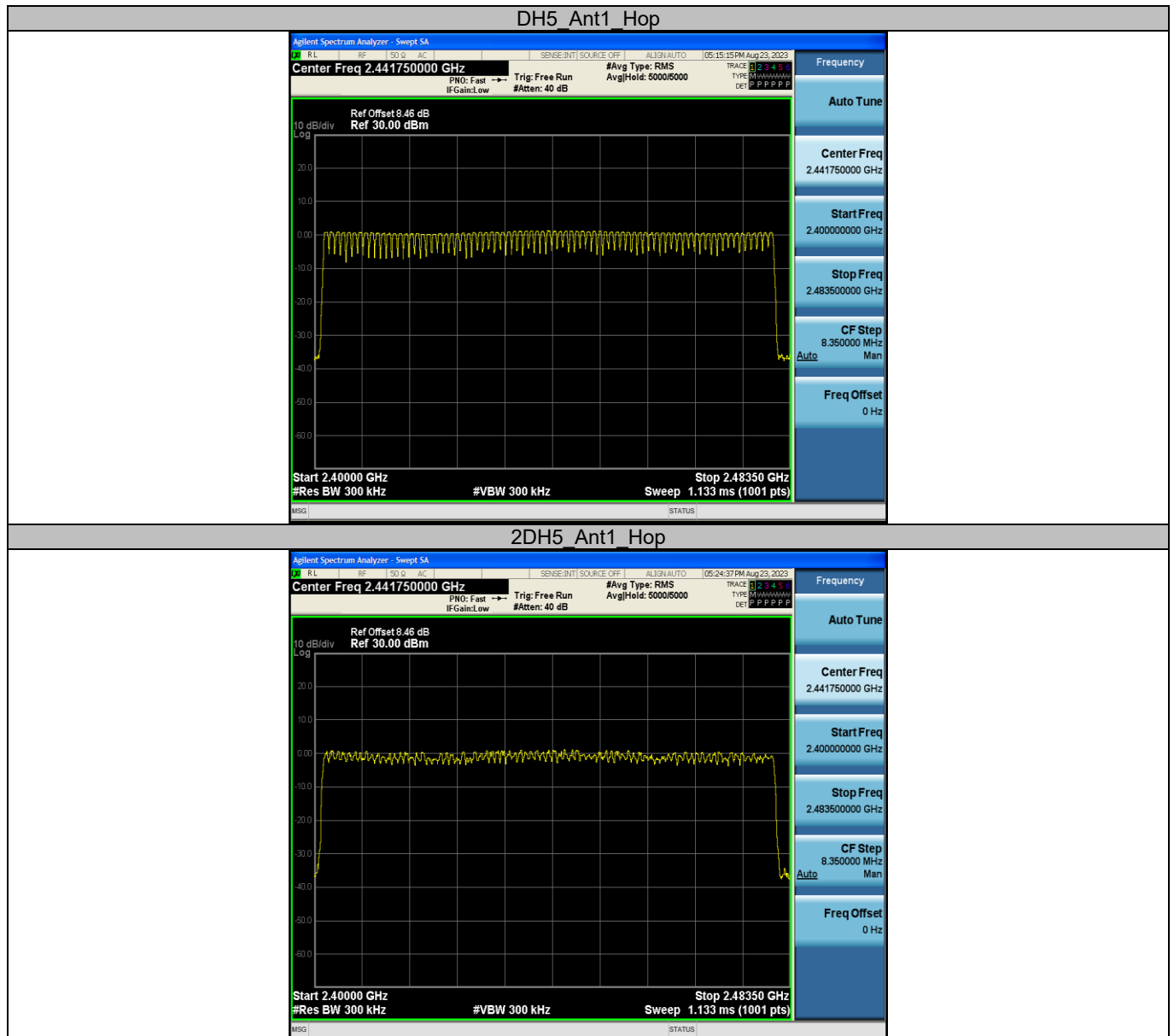

Appendix F: Band edge measurements

Test Graphs

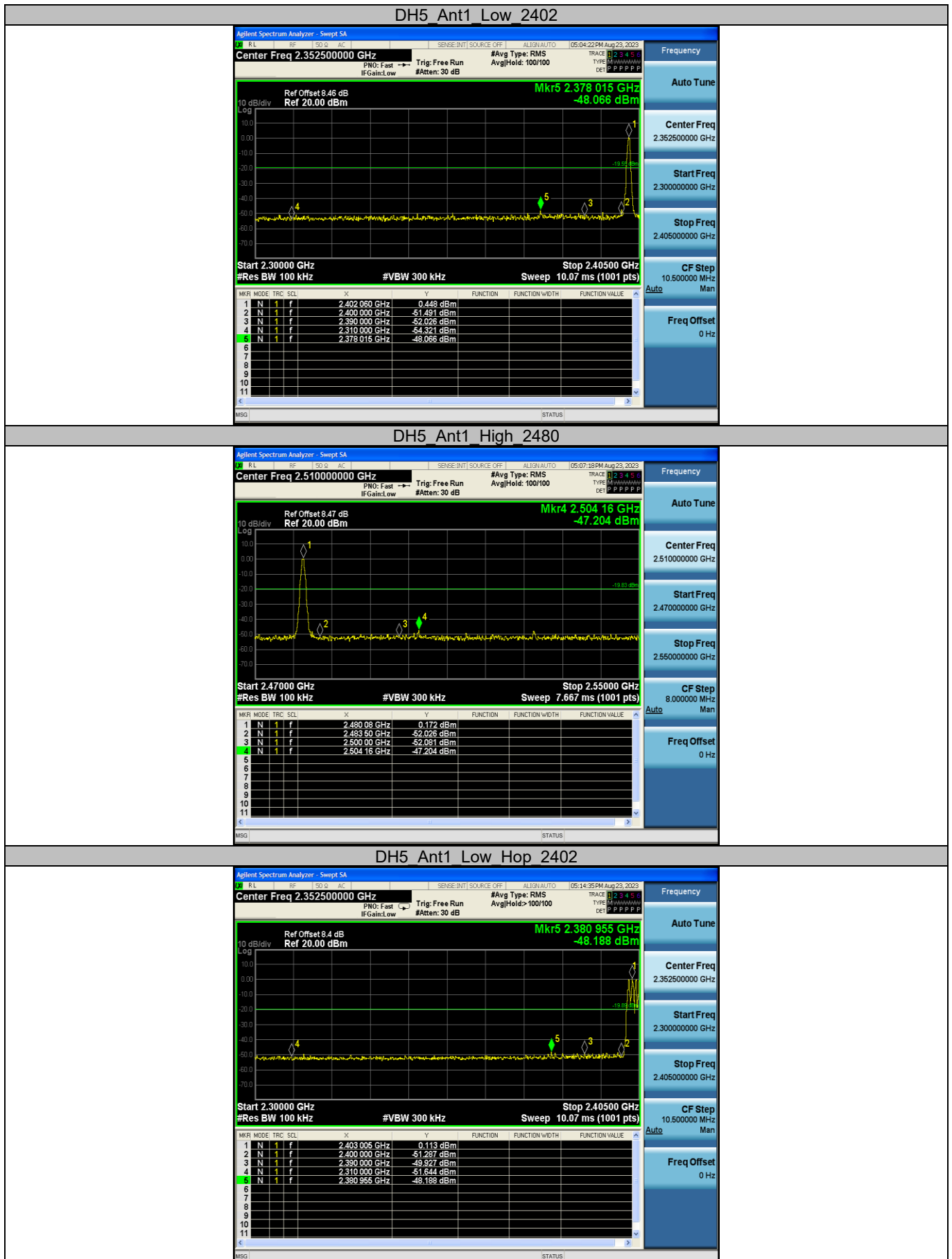

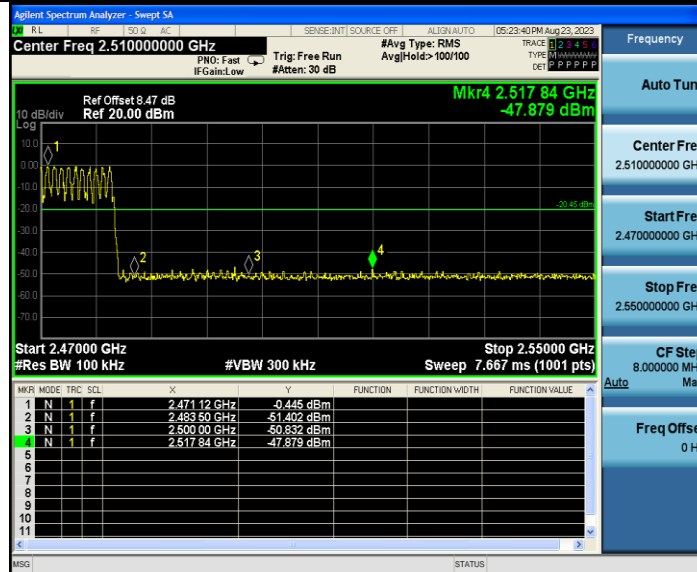
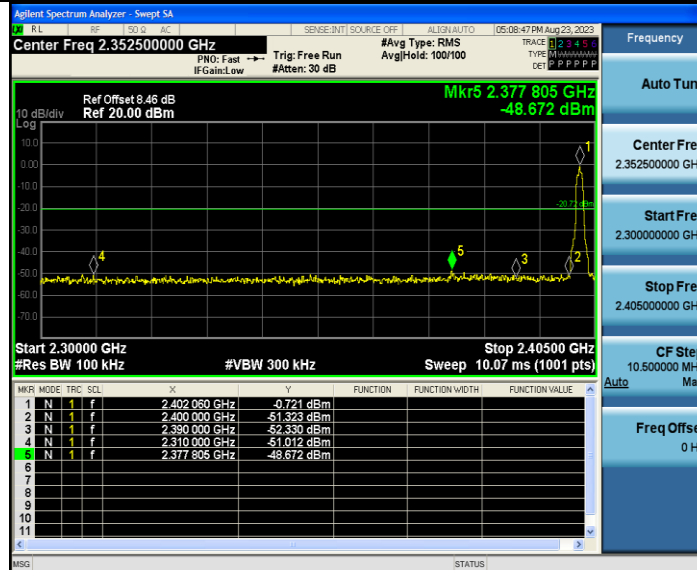
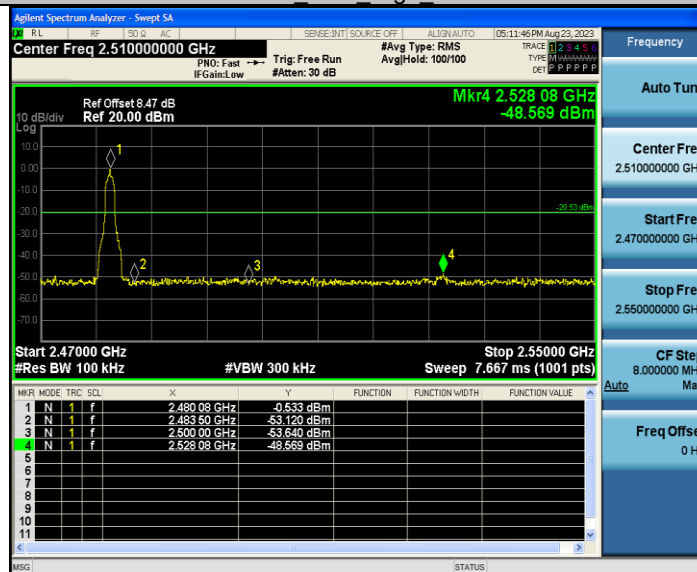
DH5 Ant1 High Hop 2480

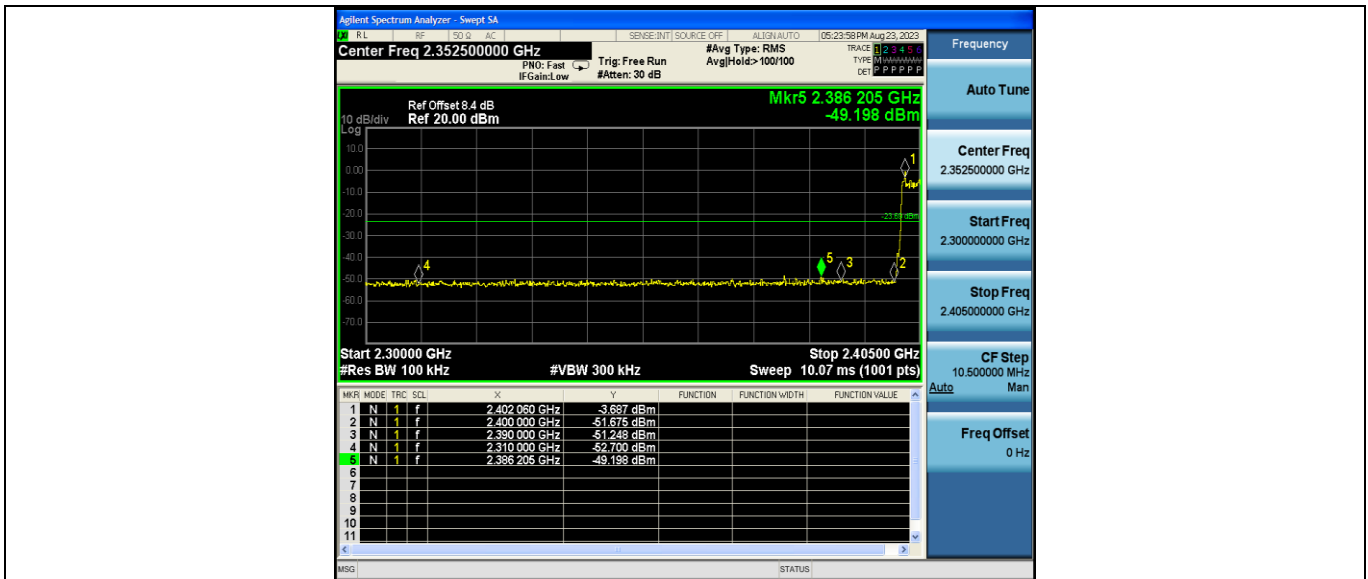
2DH5 Ant1 Low 2402

2DH5 Ant1 High 2480

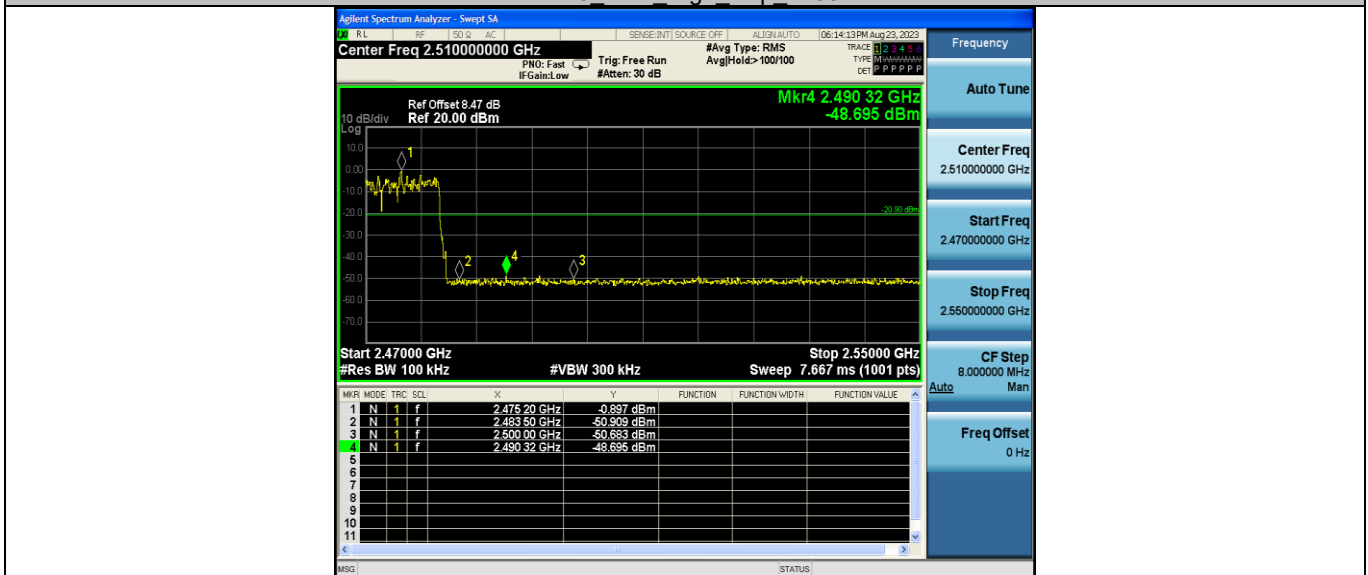
2DH5 Ant1 Low Hop 2402



2DH5 Ant1 High Hop 2480



Appendix G: Conducted Spurious Emission

Test Graphs

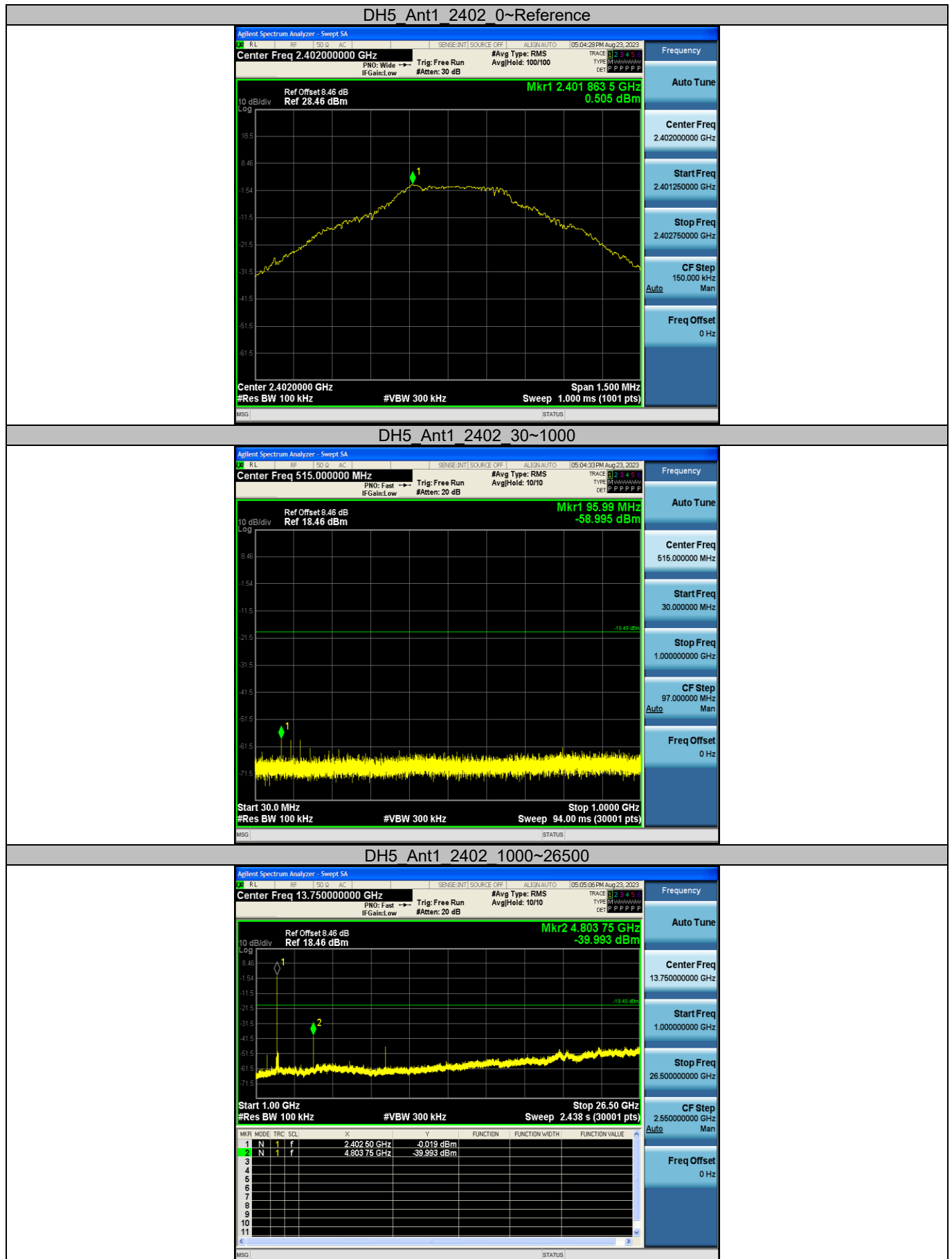

DH5_Ant1_2441_0~Reference



DH5_Ant1_2441_30~1000

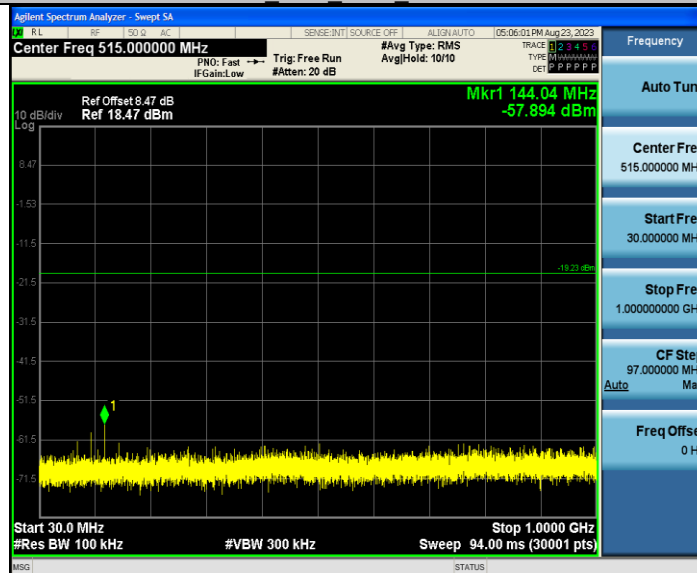

DH5_Ant1_2441_1000~26500

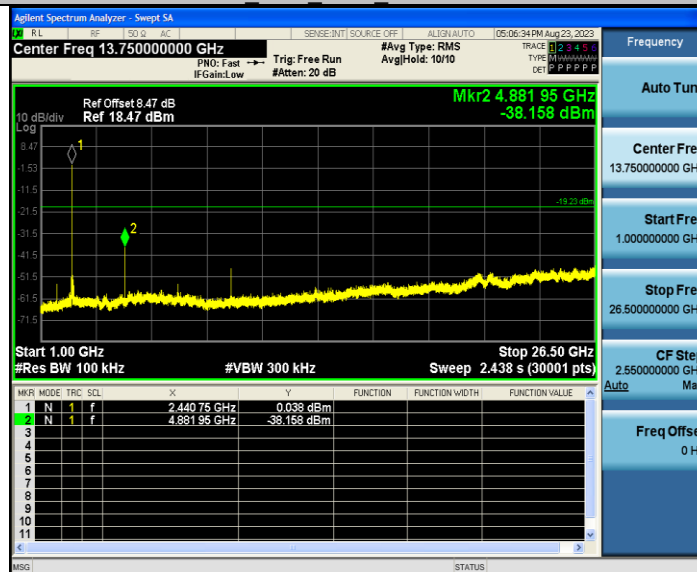

DH5_Ant1_2480_0~Reference

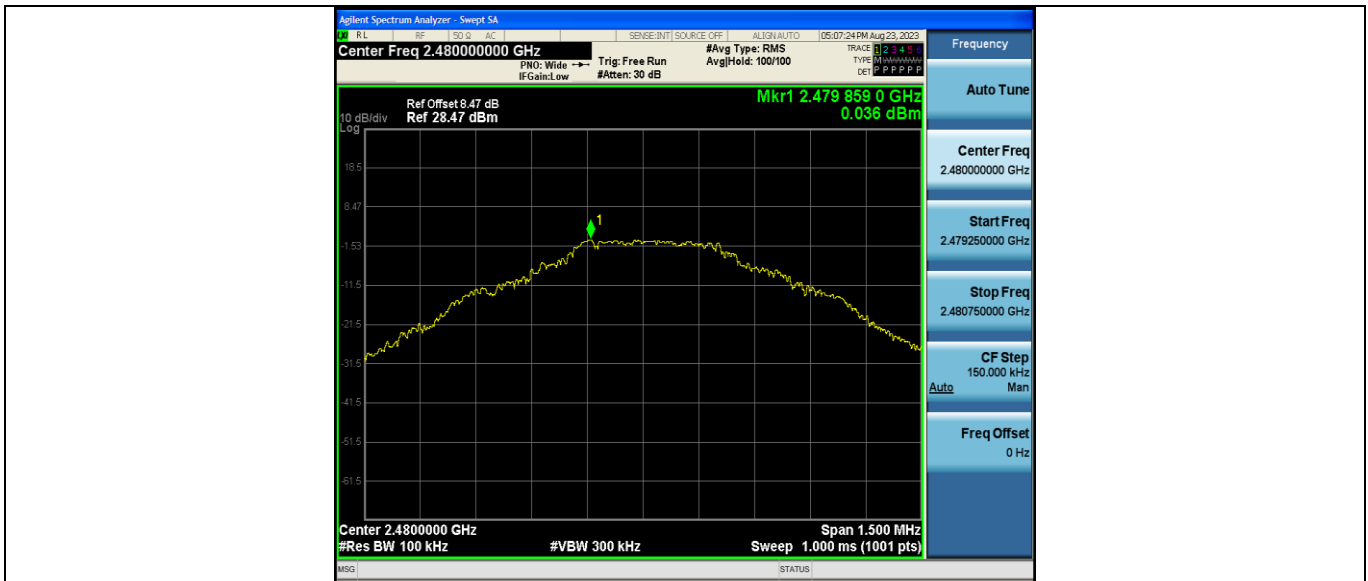

DH5 Ant1 2480 30~1000

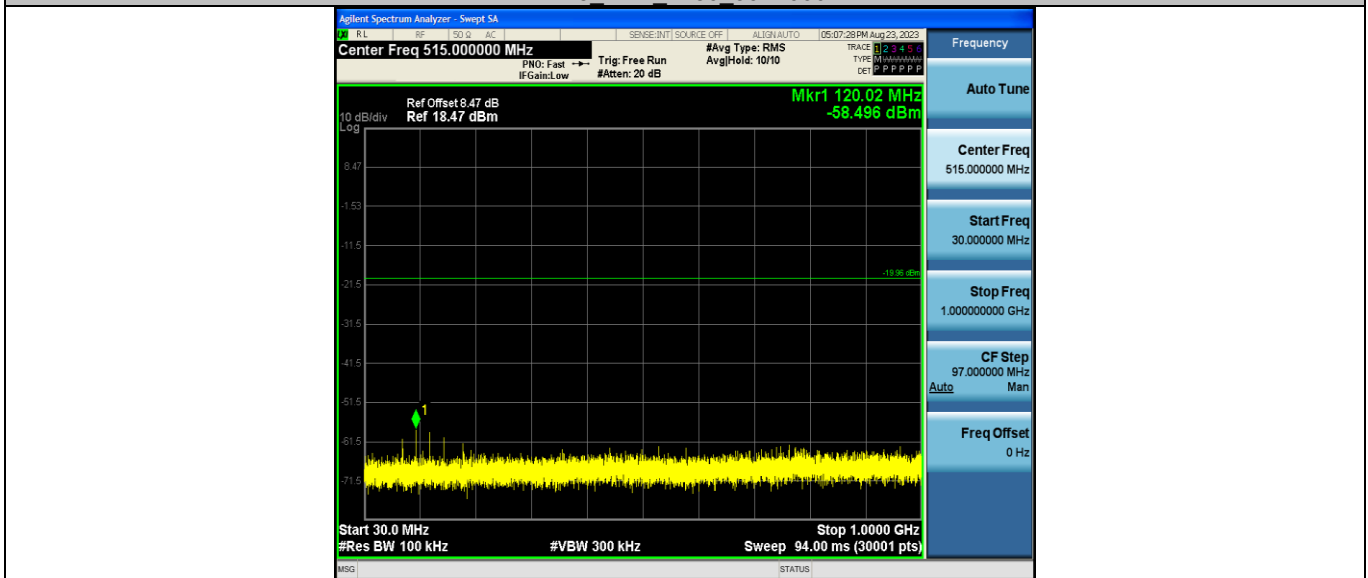

DH5 Ant1 2480 1000~26500

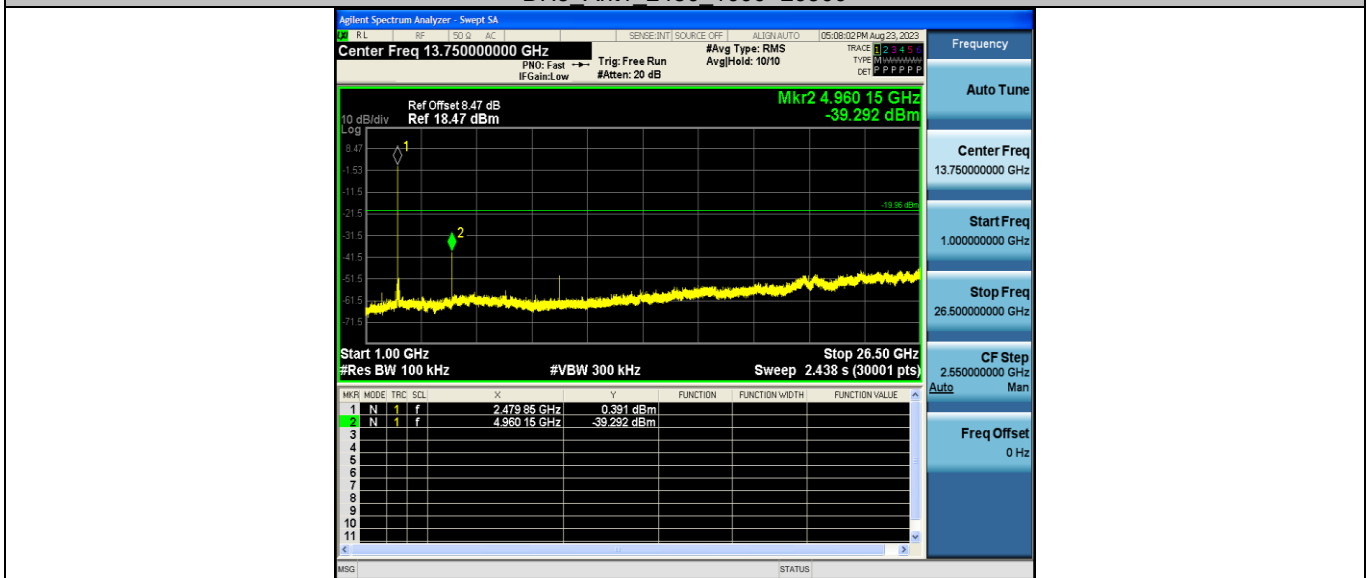

2DH5 Ant1 2402 0~Reference

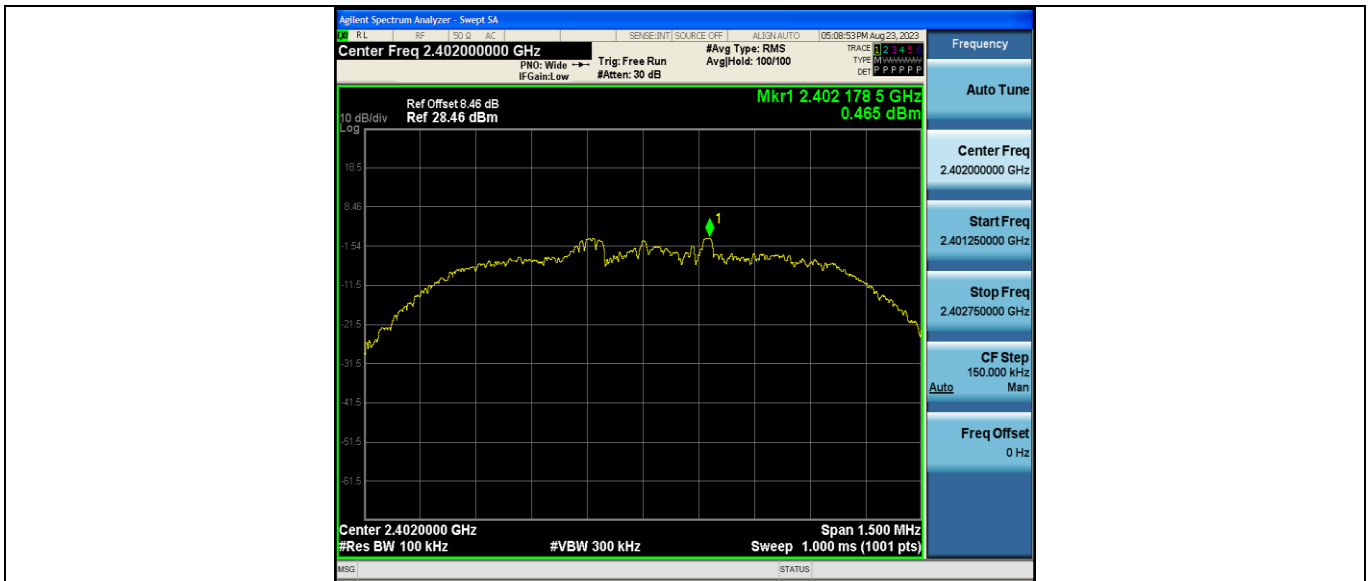

2DH5 Ant1 2402 30~1000

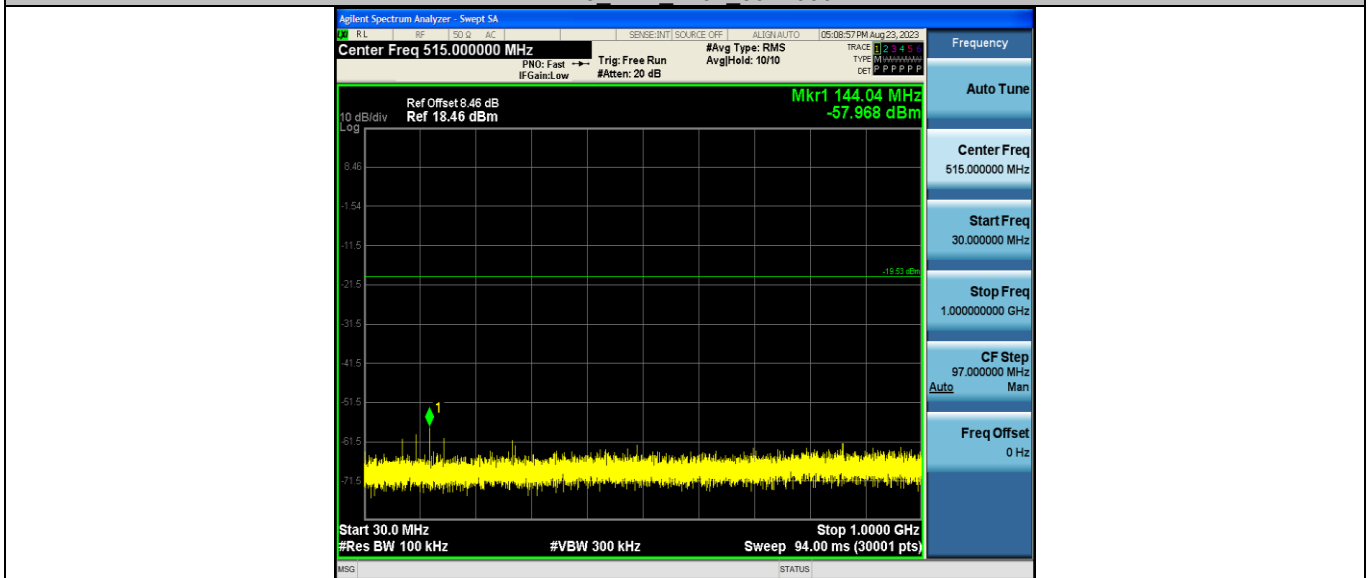

2DH5 Ant1 2402 1000~26500

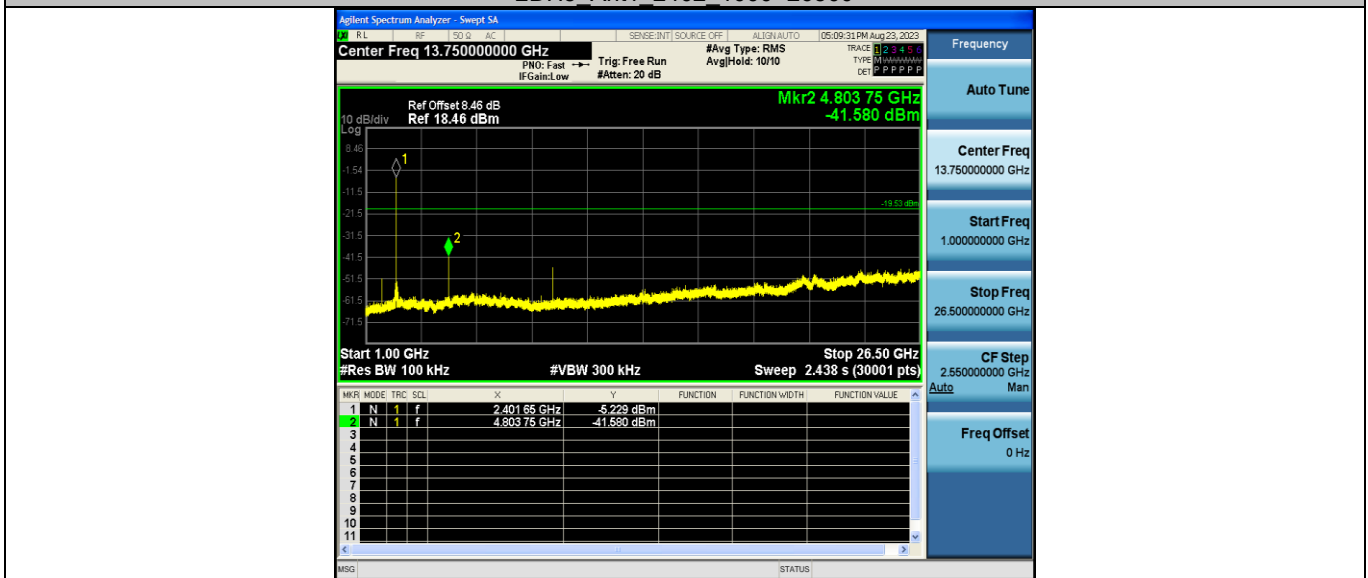

2DH5 Ant1 2441 0~Reference

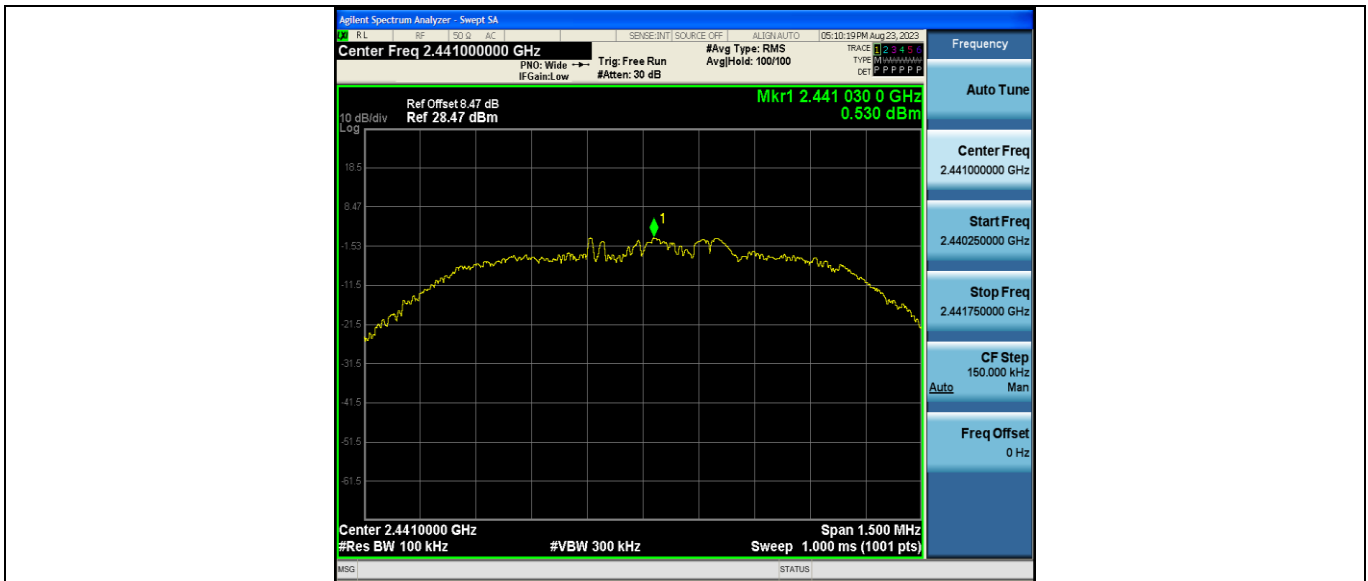

2DH5 Ant1 2441 30~1000

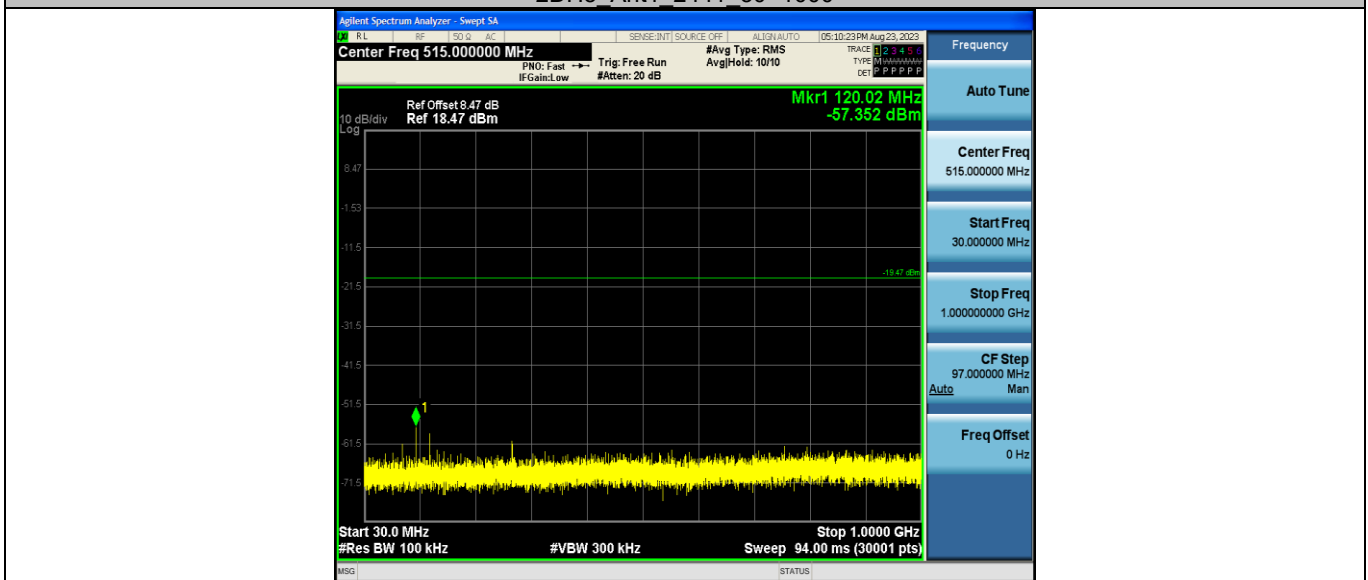

2DH5 Ant1 2441 1000~26500

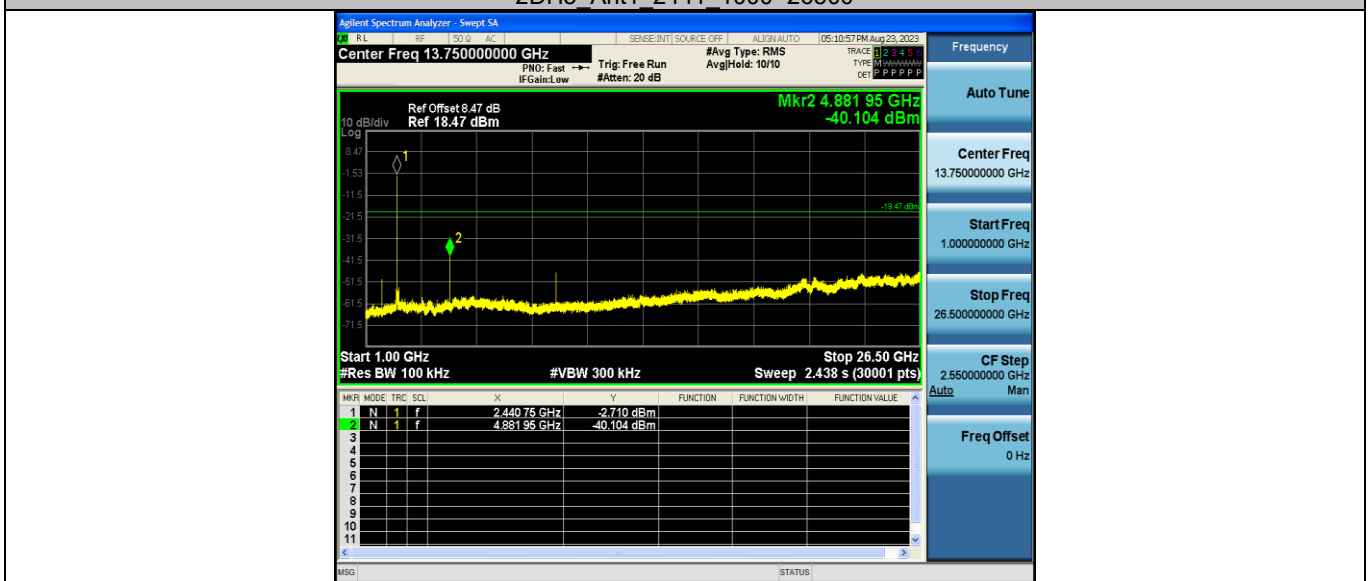

2DH5 Ant1 2480 0~Reference

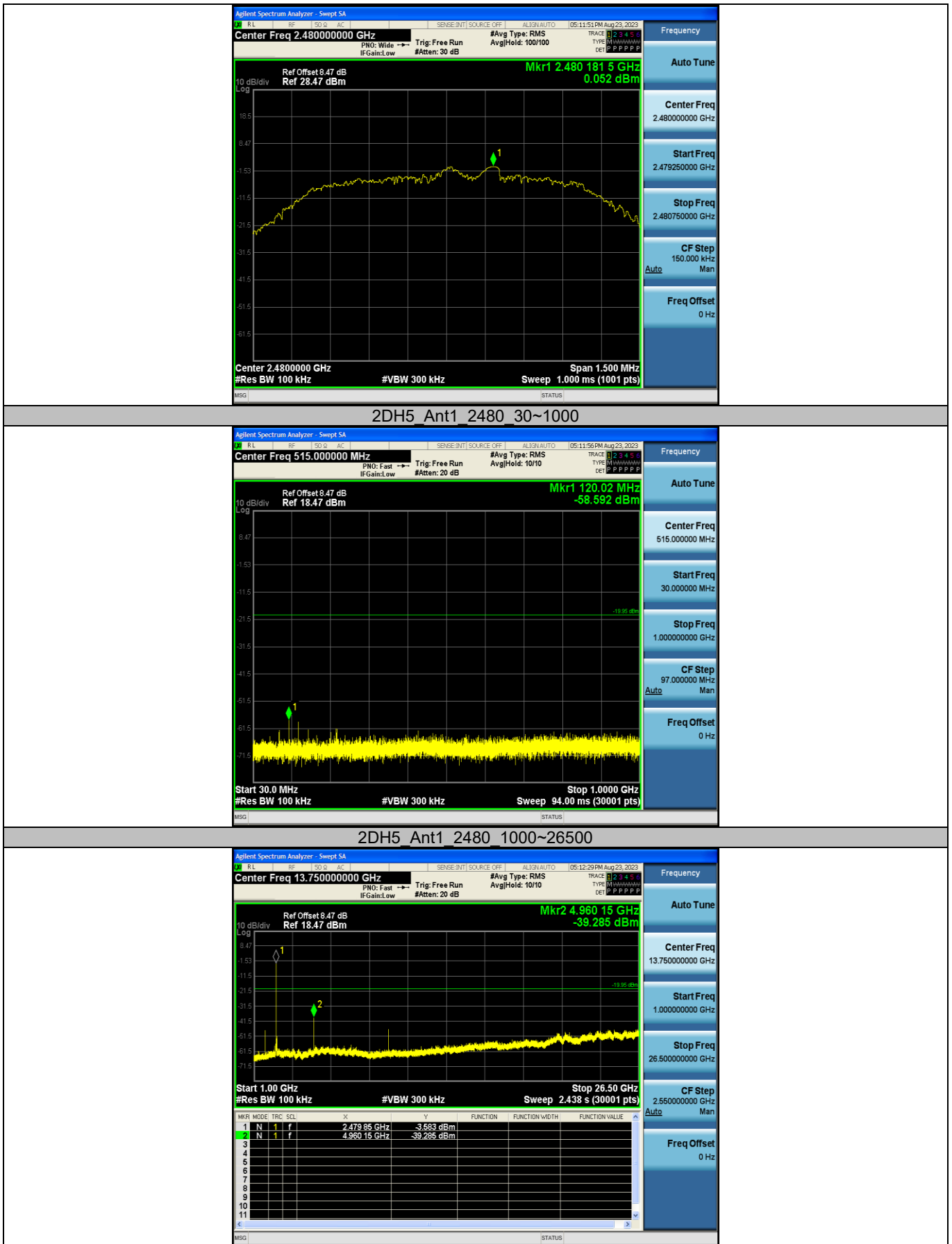

----End of Report----