



Test Report

Report No.: MTi210819013-03E1

Date of issue: Sept. 07, 2021

Applicant: Guangzhou Havit Technology
Co., LTD.

Product name: Smart WATCH

Model(s): M9006PRO, M9004, M9021,
M9013, H1113A, H1103A, M9022,
M9023, 28616VRP,
WTH-TYMPRO

FCC ID: 2A16I-M9006PRO

Shenzhen Microtest Co., Ltd.
<http://www.mtitest.com>



Instructions

1. The report shall not be partially reproduced without the written consent of the laboratory;
2. The test results of this report are only responsible for the samples submitted;
3. This report is invalid without the seal and signature of the laboratory;
4. This report is invalid if transferred, altered or tampered with in any form without authorization;
5. Any objection to this report shall be submitted to the laboratory within 15 days from the date of receipt of the report.



Table of Contents

| | |
|--|-----------|
| 1. GENERAL INFORMATION..... | 6 |
| 1.1. DESCRIPTION OF EUT | 6 |
| 1.2. OPERATION CHANNEL LIST | 6 |
| 1.3. TEST CHANNEL LIST | 7 |
| 1.4. ANCILLARY EQUIPMENT LIST | 7 |
| 1.5. DESCRIPTION OF SUPPORT UNITS | 7 |
| 2. SUMMARY OF TEST RESULTS..... | 8 |
| 3. TEST FACILITIES AND ACCREDITATIONS | 9 |
| 3.1. TEST LABORATORY | 9 |
| 3.2. ENVIRONMENTAL CONDITIONS | 9 |
| 3.3. MEASUREMENT UNCERTAINTY | 9 |
| 3.4. TEST SOFTWARE | 9 |
| 4. EQUIPMENT LIST | 10 |
| 5. TEST RESULT | 11 |
| 5.1. ANTENNA REQUIREMENT | 11 |
| 5.1.1 <i>Standard Requirement</i> | 11 |
| 5.1.2 <i>EUT Antenna</i> | 11 |
| 5.2. PEAK OUTPUT POWER TEST | 12 |
| 5.2.1 <i>Limit</i> | 12 |
| 5.2.2 <i>Test setup</i> | 12 |
| 5.2.3 <i>Test Procedure</i> | 12 |
| 5.2.4 <i>Test Results</i> | 12 |
| 5.3. CONDUCTED EMISSION | 15 |
| 5.3.1 <i>Limits</i> | 15 |
| 5.3.2 <i>Test Setup</i> | 15 |
| 5.3.3 <i>Test Procedure</i> | 16 |
| 5.3.4 <i>Test Results</i> | 16 |
| 5.4. RADIATED SPURIOUS EMISSION..... | 17 |
| 5.4.1 <i>Limits</i> | 17 |
| 5.4.2 <i>Test Setup</i> | 18 |
| 5.4.3 <i>Test Procedure</i> | 19 |
| 5.4.4 <i>Test Results</i> | 20 |
| 5.4.4.1 <i>Band edge-radiated</i> | 24 |
| 5.4.4.2 <i>Spurious Emission in Restricted Band 3260MHz-18000MHz</i> | 25 |
| 5.5. POWER SPECTRAL DENSITY TEST | 26 |
| 5.5.1 <i>Limit</i> | 26 |
| 5.5.2 <i>Test Procedure</i> | 26 |
| 5.5.3 <i>Test Setup</i> | 26 |
| 5.5.4 <i>Test Results</i> | 27 |
| 5.6. 6DB BANDWIDTH | 29 |
| 5.6.1 <i>Limit</i> | 29 |
| 5.6.2 <i>Test Procedure</i> | 29 |
| 5.6.3 <i>Test Setup</i> | 29 |
| 5.6.4 <i>Test Result</i> | 29 |
| 5.7. DUTY CYCLE | 32 |
| 5.7.1 <i>Conformance Limit</i> | 32 |
| 5.7.2 <i>Measuring Instruments</i> | 32 |
| 5.7.3 <i>Test Setup</i> | 32 |
| 5.7.4 <i>Test Procedure</i> | 32 |
| 5.7.5 <i>Test Results</i> | 33 |



| | | |
|-------|--|-----------|
| 5.8 | CONDUCTED BAND EDGE..... | 35 |
| 5.8.1 | <i>Limits</i> | 35 |
| 5.8.2 | <i>Test Setup</i> | 35 |
| 5.8.3 | <i>Test Procedure</i> | 35 |
| 5.8.4 | <i>Test Result</i> | 35 |
| 5.9 | SPURIOUS RF CONDUCTED EMISSIONS | 37 |
| 5.9.1 | <i>Conformance Limit</i> | 37 |
| 5.9.2 | <i>Measuring Instruments</i> | 37 |
| 5.9.3 | <i>Test Setup</i> | 37 |
| 5.9.4 | <i>Test Procedure</i> | 37 |
| 5.9.5 | <i>Test Results</i> | 37 |
| | PHOTOGRAPHS OF THE TEST SETUP | 40 |
| | PHOTOGRAPHS OF THE EUT | 41 |



TEST RESULT CERTIFICATION

| | |
|---------------------------|---|
| Applicant's name | Guangzhou Havit Technology Co., LTD. |
| Address | ROOM 1307, 13F, PHASE 2 B, C BUILDING OF POLY WORLD TRADE CENTER, NO.1000, XINGANG EAST ROAD, HAIZHU GUANGDONG China. |
| Manufacturer's Name | Guangzhou Havit Technology Co., LTD. |
| Address | ROOM 1307, 13F, PHASE 2 B, C BUILDING OF POLY WORLD TRADE CENTER, NO.1000, XINGANG EAST ROAD, HAIZHU GUANGDONG China. |

Product description

| | |
|----------------------|---|
| Product name | Smart WATCH |
| Trademark | HAVIT |
| Model Name | M9006PRO |
| Serial Model | M9004, M9021, M9013, H1113A, H1103A, M9022, M9023, 28616VRP, WTH-TYMPRO |
| Standards | FCC Part 15.247 |
| Test procedure | ANSI C63.10-2013 |

Date of Test

| | |
|--|-------------------------------|
| Date (s) of performance of tests | Aug. 26, 2021 ~Sept. 03, 2021 |
| Test Result | Pass |

This device described above has been tested by Shenzhen Microtest Co., Ltd. and the test results show that the equipment under test (EUT) is in compliance with the FCC requirements. And it is applicable only to the tested sample identified in the report.

Testing Engineer : 
(Danny Xu)

Technical Manager : 
(Leon Chen)

Authorized Signatory : 
(Tom Xue)



1. General Information

1.1. Description of EUT

| | |
|------------------------------|---|
| Product name: | Smart WATCH |
| Model name: | M9006PRO |
| Serial model: | M9004, M9021, M9013, H1113A, H1103A, M9022, M9023, 28616VRP, WTH-TYMPRO |
| Difference in series models: | All the model are the same circuit and RF module, except the appearance and model name. |
| Operation frequency: | 2402-2480MHz |
| Modulation type: | GFSK |
| Bit Rate of transmitter: | 1 Mbps |
| Antenna type: | metal Antenna |
| Antenna gain: | 2dBi |
| Max. output power: | 4.509dBm |
| Hardware version: | V01 |
| Software version: | MOY-GAM3-2.1.8-B6492EDB |
| Power supply: | Power by battery DC 3.7V |
| Adapter information: | N/A |
| Battery: | DC 3.7V 190mAh |
| EUT serial number: | MTi210819013-03-S0001 |

1.2. Operation channel list

| Channel No. | Frequency (MHz) | Channel No. | Frequency (MHz) | Channel No. | Frequency (MHz) | Channel No. | Frequency (MHz) |
|-------------|-----------------|-------------|-----------------|-------------|-----------------|-------------|-----------------|
| 0 | 2402 | 10 | 2422 | 20 | 2442 | 30 | 2462 |
| 1 | 2404 | 11 | 2424 | 21 | 2444 | 31 | 2464 |
| 2 | 2406 | 12 | 2426 | 22 | 2446 | 32 | 2466 |
| 3 | 2408 | 13 | 2428 | 23 | 2448 | 33 | 2468 |
| 4 | 2410 | 14 | 2430 | 24 | 2450 | 34 | 2470 |
| 5 | 2412 | 15 | 2432 | 25 | 2452 | 35 | 2472 |
| 6 | 2414 | 16 | 2434 | 26 | 2454 | 36 | 2474 |
| 7 | 2416 | 17 | 2436 | 27 | 2456 | 37 | 2476 |
| 8 | 2418 | 18 | 2438 | 28 | 2458 | 38 | 2478 |
| 9 | 2420 | 19 | 2440 | 29 | 2460 | 39 | 2480 |



1.3. Test channel list

| Channel | Channel | Frequency (MHz) |
|---------|---------|-----------------|
| Low | 00 | 2402 |
| Middle | 19 | 2440 |
| High | 39 | 2480 |

1.4. Ancillary equipment list

| Equipment | Model | S/N | Manufacturer | Certificate type |
|-----------|-------|-----|--------------|------------------|
| / | / | / | / | / |

1.5. Description of Support Units

The EUT has been tested as an independent unit together with other necessary accessories or support units. The following support units or accessories were used to form a representative test configuration during the tests.

| Item | Equipment | Brand | Model/Type No. | Series No. | Note |
|------|-----------|-------|----------------|------------|------|
| / | / | / | / | / | |

Note:

- (1)The support equipment was authorized by Declaration of Confirmation.
- (2)For detachable type I/O cable should be specified the length in cm in 『Length』 column.



2. Summary of Test Results

Test procedures according to the technical standards:

| No. | Standard Section | Test Item | Result | Remark |
|-----|--|------------------------------------|--------|--------|
| 1 | 15.203 | Antenna Requirement | Pass | |
| 2 | 15.247 (b) | Peak Output Power | Pass | |
| 3 | 15.207 | Conducted Emission | N/A | |
| 4 | 15.247 (d) & 15.209 | Radiated Spurious Emission | Pass | |
| 5 | 15.247 (e) | Power Spectral Density | Pass | |
| 6 | 15.247 (a)(2) | 6dB Bandwidth | Pass | |
| 7 | 558074 D01 15.247 Meas Guidance v05r02 Chapter 6 | Duty Cycle | Pass | |
| 8 | 15.205 | Band Edge Emission | Pass | |
| 9 | 15.247(d) | Spurious RF Conducted Emissions | Pass | |



3. Test Facilities and Accreditations

3.1. Test laboratory

| | |
|-----------------------|---|
| Test Laboratory | Shenzhen Microtest Co., Ltd |
| Location | 101, No. 7, Zone 2, Xinxing Industrial Park, Fuhai Avenue, Xinhe Community, Fuhai Street, Bao' an District, Shenzhen, Guangdong, China. |
| FCC Registration No.: | 448573 |

3.2. Environmental conditions

| | |
|----------------------|--------------|
| Temperature: | 15°C~35°C |
| Humidity | 20%~75% |
| Atmospheric pressure | 98kPa~101kPa |

3.3. Measurement uncertainty

The reported uncertainty of measurement $y \pm U$ where expanded uncertainty U is based on a standard uncertainty multiplied by a coverage factor of $k=2$ providing a level of confidence of approximately 95 %

| No. | Item | Uncertainty |
|-----|-------------------------------|-------------------------|
| 1 | Conducted Emission Test | $\pm 1.38\text{dB}$ |
| 2 | RF power, conducted | $\pm 0.16\text{dB}$ |
| 3 | Spurious emissions, conducted | $\pm 0.21\text{dB}$ |
| 4 | All emissions, radiated(<1G) | $\pm 4.68\text{dB}$ |
| 5 | All emissions, radiated(>1G) | $\pm 4.89\text{dB}$ |
| 6 | Temperature | $\pm 0.5^\circ\text{C}$ |
| 7 | Humidity | $\pm 2\%$ |

3.4. Test software

| Software Name | Manufacturer | Model | Version |
|--------------------------------|-------------------------------|----------|-------------|
| Bluetooth and WiFi Test System | Shenzhen JS tonscent co., ltd | JS1120-3 | 2.5.77.0418 |



4. Equipment list

| Equipment No. | Equipment Name | Manufacturer | Model | Serial No. | Calibration date | Due date |
|---------------|--------------------------------------|-----------------|-------------|----------------|------------------|------------|
| MTI-E043 | EMI Test Receiver | Rohde&schwarz | ESCI7 | 101166 | 2021/06/02 | 2022/06/01 |
| MTI-E044 | TRILOG Broadband Antenna | schwarzbeck | VULB 9163 | 9163-1338 | 2021/05/30 | 2023/05/29 |
| MTI-E047 | Amplifier | Hewlett-Packard | 8447F | 3113A06150 | 2021/06/02 | 2022/06/01 |
| MTI-E089 | ESG Vector Signal Generator | Agilent | N5182A | MY49060455 | 2021/06/02 | 2022/06/01 |
| MTI-E058 | ESG Series Analog Signal Generator | Agilent | E4421B | GB40051240 | 2021/06/02 | 2022/06/01 |
| MTI-E062 | PXA Signal Analyzer | Agilent | N9030A | MY51350296 | 2021/06/02 | 2022/06/01 |
| MTI-E066 | MXA Signal Analyzer | Agilent | N9020A | MY50143483 | 2021/06/02 | 2022/06/01 |
| MTI-E078 | Synthesized Sweeper | Agilent | 83752A | 3610A01957 | 2021/06/02 | 2022/06/01 |
| MTI-E079 | DC Power Supply | Agilent | E3632A | MY40027695 | 2021/06/02 | 2022/06/01 |
| MTI-E045 | Double Ridged Broadband Horn Antenna | schwarzbeck | BBHA 9120D | 9120D-2278 | 2021/05/30 | 2023/05/29 |
| MTI-E021 | EMI Test Receiver | Rohde&schwarz | ESCS30 | 100210 | 2021/06/02 | 2022/06/01 |
| MTI-E022 | Pulse Limiter | Schwarzbeck | VSTD 9561-F | 00679 | 2021/06/02 | 2022/06/01 |
| MTI-E023 | Artificial mains network | Schwarzbeck | NSLK 8127 | NSLK 8127 #841 | 2021/06/02 | 2022/06/01 |
| MTI-E046 | Active Loop Antenna | Schwarzbeck | FMZB 1519B | 00044 | 2021/05/30 | 2023/05/29 |
| MTI-E048 | Amplifier | Agilent | 8449B | 3008A02400 | 2021/06/02 | 2022/06/01 |
| MTI-E072 | Thermometer Clock Humidity Monitor | - | HTC-1 | / | 2021/06/02 | 2022/06/01 |

Note: the calibration interval of the above test instruments is 12 or 24 months and the calibrations are traceable to international system unit (SI).



5. Test Result

5.1. Antenna requirement

5.1.1 Standard Requirement

15.203 requirement: For intentional device, according to 15.203: an intentional radiator shall be designed to ensure that no antenna other than that furnished by the responsible party shall be used with the device

5.1.2 EUT Antenna

The EUT antenna is metal antenna (2dBi). It comply with the standard requirement. In case of replacement of broken antenna the same antenna type must be used.



5.2. Peak Output Power Test

5.2.1 Limit

| FCC Part15 Subpart C | | | |
|----------------------|-------------------|-----------------|-----------------------|
| Section | Test Item | Limit | Frequency Range (MHz) |
| 15.247(b)(3) | Peak output power | 1 watt or 30dBm | 2400-2483.5 |

5.2.2 Test setup

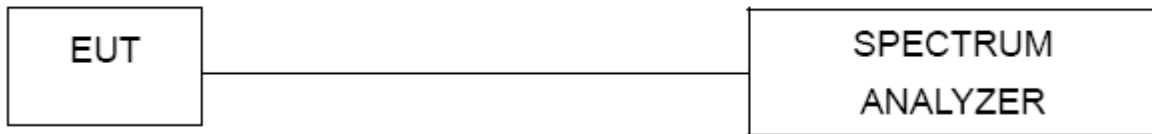

5.2.3 Test Procedure

- (1) The EUT was directly connected to the spectrum analyzer and antenna output port as show in the block diagram above.
- (2) Spectrum Setting:
 RBW=1MHz, VBW=3MHz, Detector=Peak (If 20dB BW ≤1 MHz)
 RBW=3MHz, VBW=8MHz, Detector=Peak (If 20dB BW > 1 MHz)
- (3) The EUT was set to continuously transmitting in the max power during the test.

5.2.4 Test Results

| | | | |
|------------|---------------------------|---------------|--------------------------|
| EUT: | Smart WATCH | Model Name: | M9006PRO |
| Pressure: | 1012 hPa | Test Voltage: | Power by battery DC 3.7V |
| Test Mode: | TX Mode /CH00, CH19, CH39 | | |

| Test Channel | Frequency | Maximum Conducted Output Power(PK) | Limit |
|--------------|-----------|------------------------------------|-------|
| | (MHz) | (dBm) | dBm |
| CH00 | 2402 | 4.509 | 30 |
| CH19 | 2440 | 4.448 | 30 |
| CH39 | 2480 | 4.005 | 30 |



2402MHz

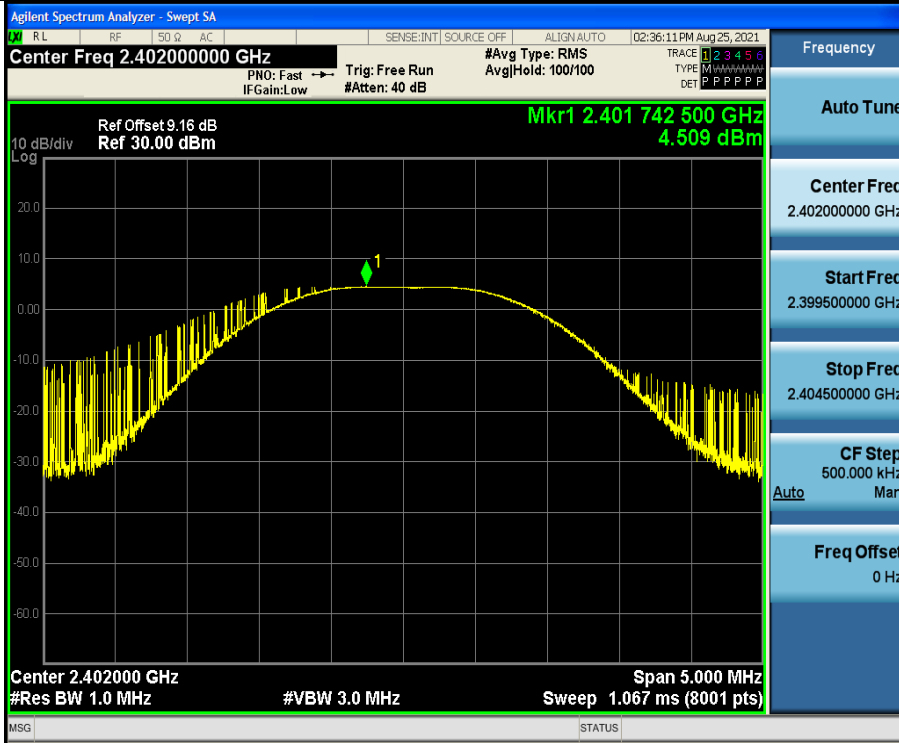

2440MHz

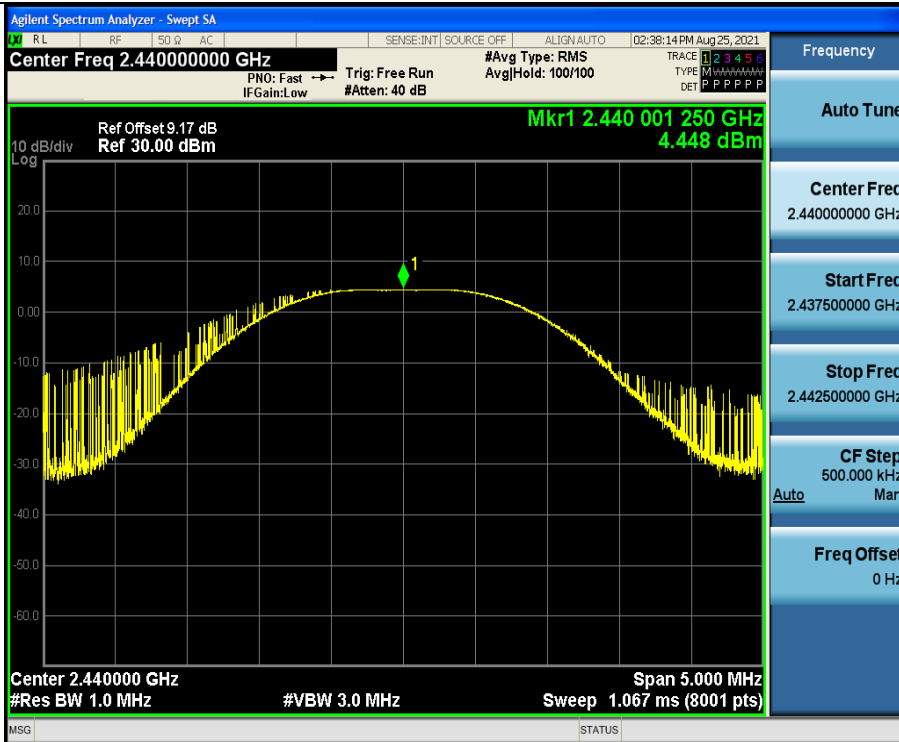



2480MHz

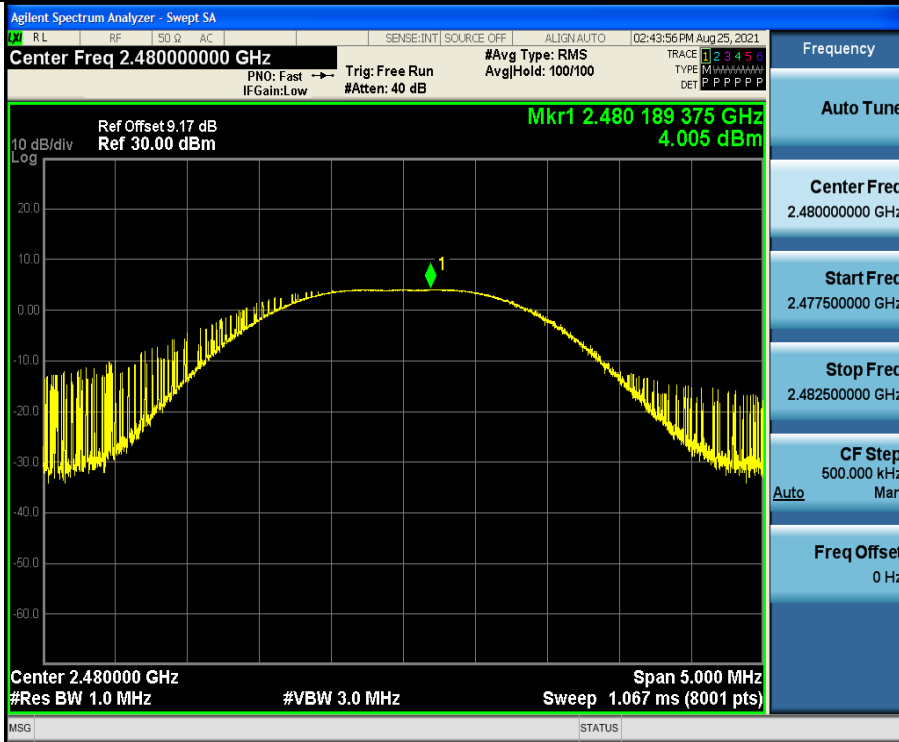



5.3. Conducted emission

5.3.1 Limits

| FREQUENCY (MHz) | Class B (dBuV) | |
|-----------------|----------------|-----------|
| | Quasi-peak | Average |
| 0.15 -0.5 | 66 - 56 * | 56 - 46 * |
| 0.50 -5.0 | 56.00 | 46.00 |
| 5.0 -30.0 | 60.00 | 50.00 |

Note: *Decreases with the logarithm of the frequency.

5.3.2 Test Setup

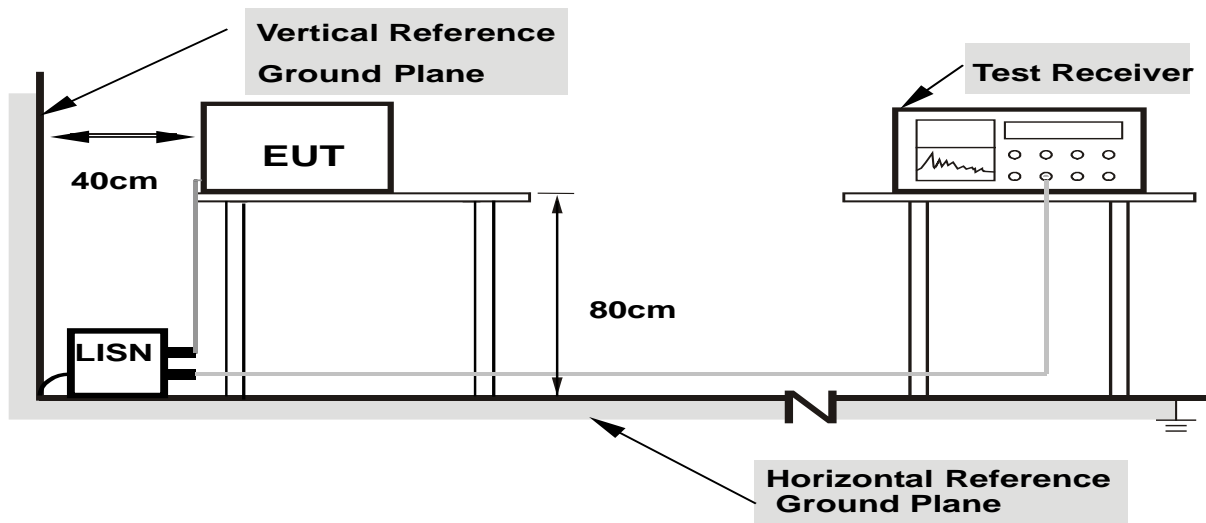

- Note: 1.Support units were connected to second LISN.**
2.Both of LISNs (AMN) are 80 cm from EUT and at least 80 from other units and other metal planes



5.3.3 Test Procedure

a. EUT Operating Conditions

The EUT was configured for testing in a typical fashion (as a customer would normally use it). The EUT has been programmed to continuously transmit during test. This operating condition was tested and used to collect the included data.

b. The following table is the setting of the receiver

| Receiver Parameters | Setting |
|---------------------|----------|
| Attenuation | 10 dB |
| Start Frequency | 0.15 MHz |
| Stop Frequency | 30 MHz |
| IF Bandwidth | 9 kHz |

c. The EUT was placed 0.8 meters from the horizontal ground plane with EUT being connected to the power mains through a line impedance stabilization network (LISN). All other support equipments powered from additional LISN(s). The LISN provide 50 Ohm/ 50uH of coupling impedance for the measuring instrument.

d. Interconnecting cables that hang closer than 40 cm to the ground plane shall be folded back and forth in the center forming a bundle 30 to 40 cm long.

e. I/O cables that are not connected to a peripheral shall be bundled in the center. The end of the cable may be terminated, if required, using the correct terminating impedance. The overall length shall not exceed 1 m.

f. LISN at least 80 cm from nearest part of EUT chassis.

For the actual test configuration, please refer to the related Item – EUT Test Photos.

5.3.4 Test Results

Note: Not applicate. Because the product does not TX when it is charged, so this item not applicate.



5.4. Radiated spurious emission

5.4.1 Limits

| Frequency (MHz) | Field Strength (micovolts/meter) | Measurement Distance (meters) |
|-----------------|----------------------------------|-------------------------------|
| 0.009~0.490 | 2400/F(kHz) | 300 |
| 0.490~1.705 | 24000/F(kHz) | 30 |
| 1.705~30.0 | 30 | 30 |
| 30~88 | 100 | 3 |
| 88~216 | 150 | 3 |
| 216~960 | 200 | 3 |
| Above 960 | 500 | 3 |

| Spectrum Parameter | Setting |
|---------------------------------------|--|
| Attenuation | Auto |
| Start Frequency | 1000 MHz |
| Stop Frequency | 10th carrier harmonic |
| RB / VB (emission in restricted band) | 1 MHz / 1 MHz for Peak, 1 MHz / 10Hz for Average |

| Receiver Parameter | Setting |
|------------------------|----------------------------------|
| Attenuation | Auto |
| Start ~ Stop Frequency | 9kHz~150kHz / RB 200Hz for QP |
| Start ~ Stop Frequency | 150kHz~30MHz / RB 9kHz for QP |
| Start ~ Stop Frequency | 30MHz~1000MHz / RB 120kHz for QP |



5.4.2 Test Setup

Radiated emission test-up frequency below 30MHz

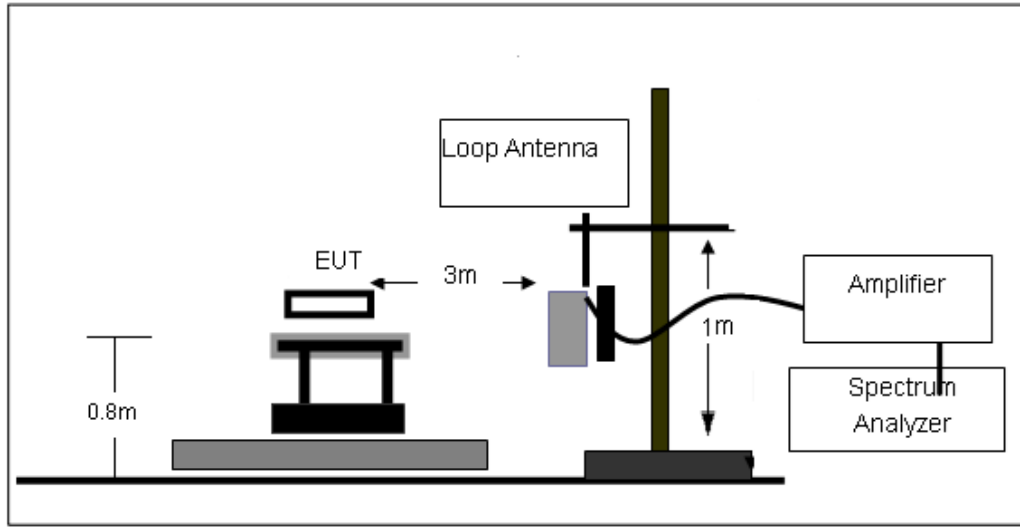

Radiated emission test-up frequency 30MHz~1GHz

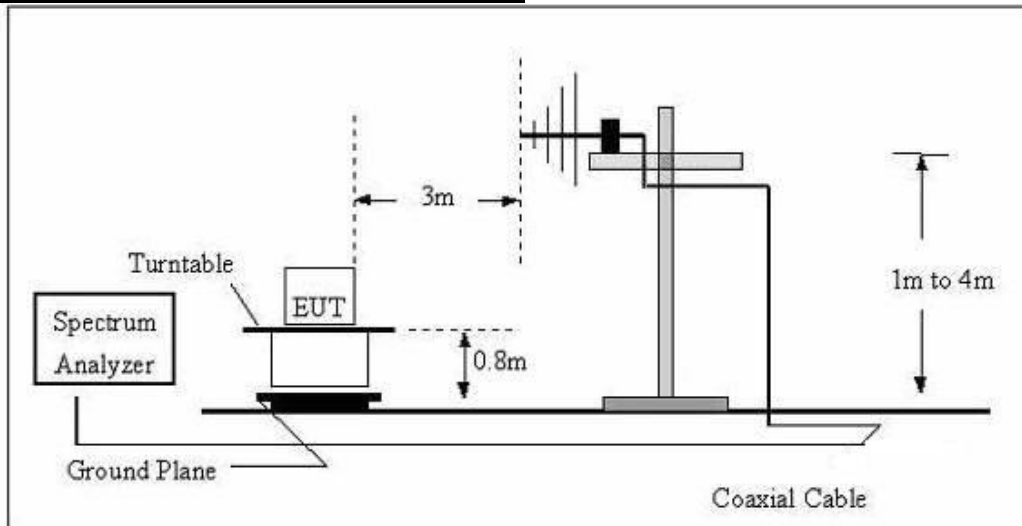

Radiated emission test-up frequency above 1GHz

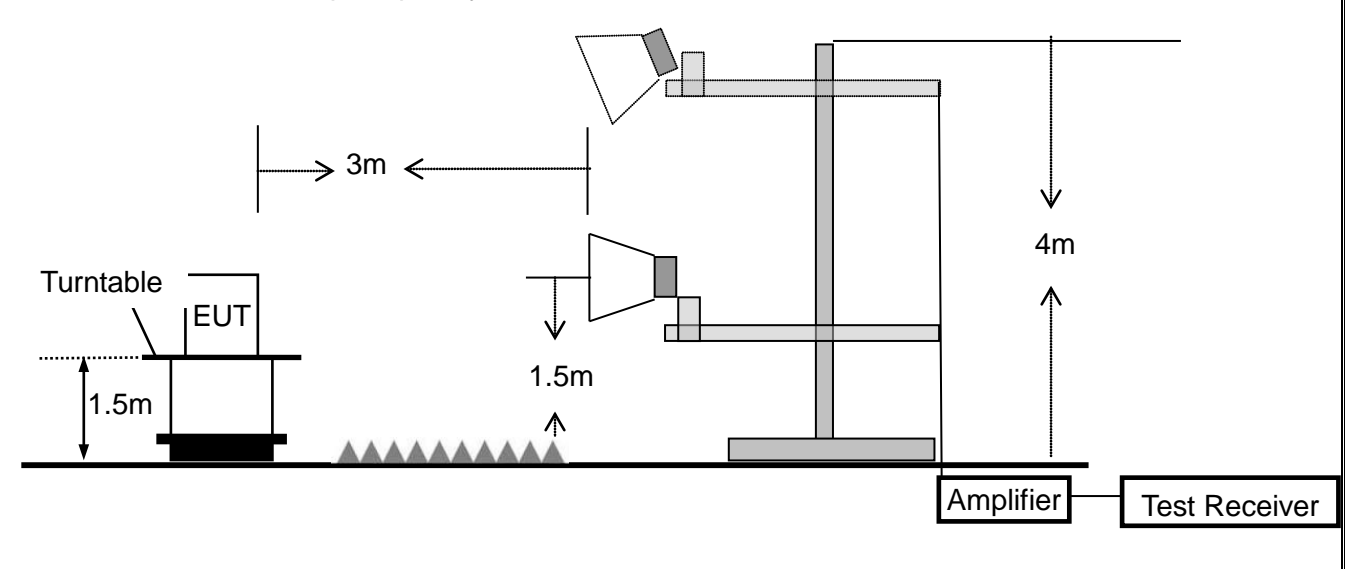



5.4.3 Test Procedure

- a. EUT operating conditions. The EUT tested system was configured as the statements of 3.2 Unless otherwise a special operating condition is specified in the follows during the testing.
- b. The measuring distance of at 3 m shall be used for measurements at frequency up to 1GHz. For frequencies above 1GHz, any suitable measuring distance may be used.
- c. The EUT was placed on the top of a rotating table 0.8 meters above the ground at a 3 meter shield area test site. The table was rotated 360 degrees to determine the position of the highest radiation.
- d. The height of the equipment or of the substitution antenna shall be 0.8 m; the height of the test antenna shall vary between 1 m to 4 m. Both horizontal and vertical polarizations of the antenna are set to make the measurement.
- e. For emission measurements above 1 GHz, the EUT shall be placed at a height of 1.5 m above the floor on a support that is RF transparent for the frequencies of interest. Final measurements for the EUT require a measurement antenna height scan of 1 m to 4 m.
- f. The initial step in collecting conducted emission data is a spectrum analyzer peak detector mode pre-scanning the measurement frequency range. Significant peaks are then marked and then Quasi Peak detector mode re-measured.
- g. If the Peak Mode measured value compliance with and lower than Quasi Peak Mode Limit, the EUT shall be deemed to meet QP Limits and then no additional QP Mode measurement performed.
- h. For the actual test configuration, please refer to the related Item –EUT Test photos.

Note: Both horizontal and vertical antenna polarities were tested. The worst case emissions were reported.

During the radiated emission test, the Spectrum Analyzer was set with the following configurations:

| Frequency Band (MHz) | Function | Resolution bandwidth | Video Bandwidth |
|----------------------|----------|----------------------|-----------------|
| 30 to 1000 | QP | 120 kHz | 300 kHz |
| Above 1000 | Peak | 1 MHz | 1 MHz |
| | Average | 1 MHz | 10 Hz |

Note: for the frequency ranges below 30 MHz, a narrower RBW is used for these ranges but the measured value should add a RBW correction factor (RBWCF) where $RBWCF [dB] = 10 \cdot \lg(100 [kHz] / \text{narrower RBW [kHz]})$. , the narrower RBW is 1 kHz and RBWCF is 20 dB for the frequency 9 kHz to 150 kHz, and the narrower RBW is 10 kHz and RBWCF is 10 dB for the frequency 150 kHz to 30 MHz.



5.4.4 Test Results

Below 30MHz

| | | | |
|------------|-------------|----------------|--------------------------|
| EUT: | Smart WATCH | Model Name: | M9006PRO |
| Pressure: | 1010 hPa | Test Voltage: | Power by battery DC 3.7V |
| Test Mode: | TX | Polarization:: | -- |

| Freq. | Reading | Limit | Margin | State |
|-------|----------|----------|--------|-------|
| (MHz) | (dBuV/m) | (dBuV/m) | (dB) | P/F |
| -- | -- | -- | -- | Pass |
| -- | -- | -- | -- | Pass |

Note:

1. For 9kHz-30MHz, the amplitude of spurious emissions which are attenuated by more than 20dB below the permissible value has no need to be reported.
2. Distance extrapolation factor = $40 \log (\text{specific distance}/\text{test distance})(\text{dB})$;
3. Limit line = specific limits (dBuV) + distance extrapolation factor.



Between 30MHz – 1GHz

| | | | |
|------------|-------------|---------------|--------------------------|
| EUT: | Smart WATCH | Model Name: | M9006PRO |
| Pressure: | 1010 hPa | Phase: | H |
| Test Mode: | TX | Test Voltage: | Power by battery DC 3.7V |

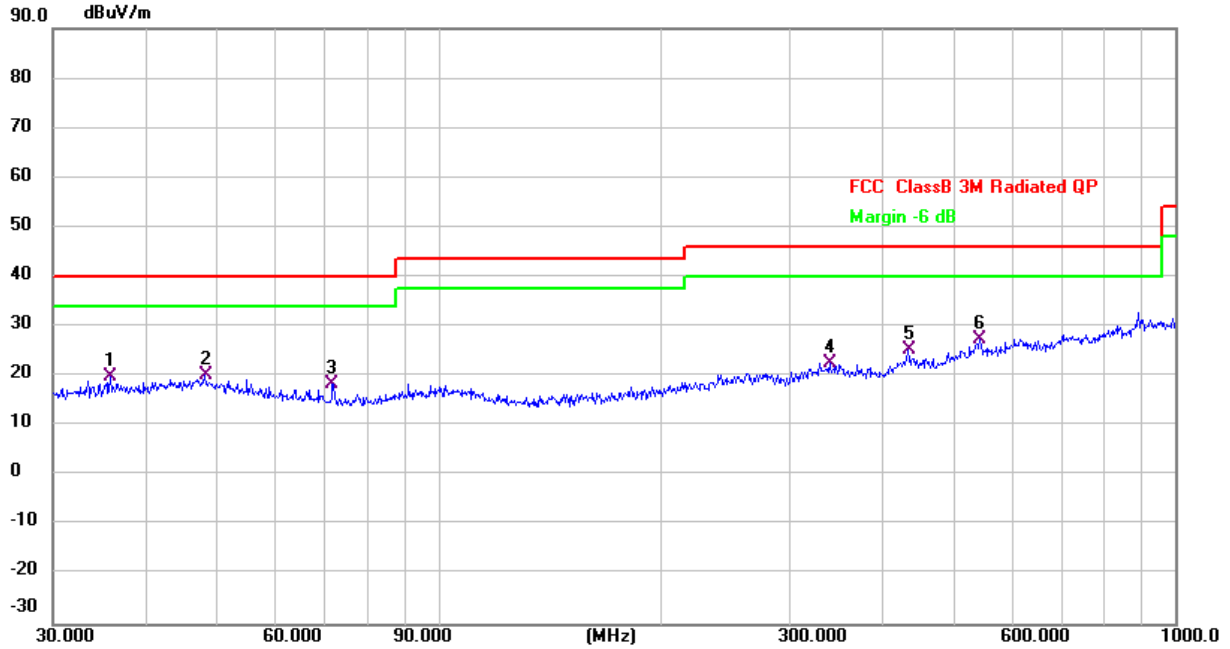

| No. | Mk. | Freq. MHz | Reading Level dBuV | Correct Factor dB | Measure- ment dBuV/m | Limit dBuV/m | Over dB | Detector |
|-----|-----|--------------|--------------------------|-------------------------|----------------------------|-----------------|------------|----------|
| 1 | | 35.8746 | 28.16 | -8.12 | 20.04 | 40.00 | -19.96 | QP |
| 2 | | 48.1626 | 27.91 | -7.54 | 20.37 | 40.00 | -19.63 | QP |
| 3 | | 71.8320 | 28.62 | -10.03 | 18.59 | 40.00 | -21.41 | QP |
| 4 | | 339.5888 | 27.30 | -4.61 | 22.69 | 46.00 | -23.31 | QP |
| 5 | | 434.0651 | 28.63 | -3.30 | 25.33 | 46.00 | -20.67 | QP |
| 6 | * | 543.2742 | 29.09 | -1.59 | 27.50 | 46.00 | -18.50 | QP |



| | | | |
|------------|-------------|---------------|--------------------------|
| EUT: | Smart WATCH | Model Name: | M9006PRO |
| Pressure: | 1010 hPa | Phase: | V |
| Test Mode: | TX | Test Voltage: | Power by battery DC 3.7V |

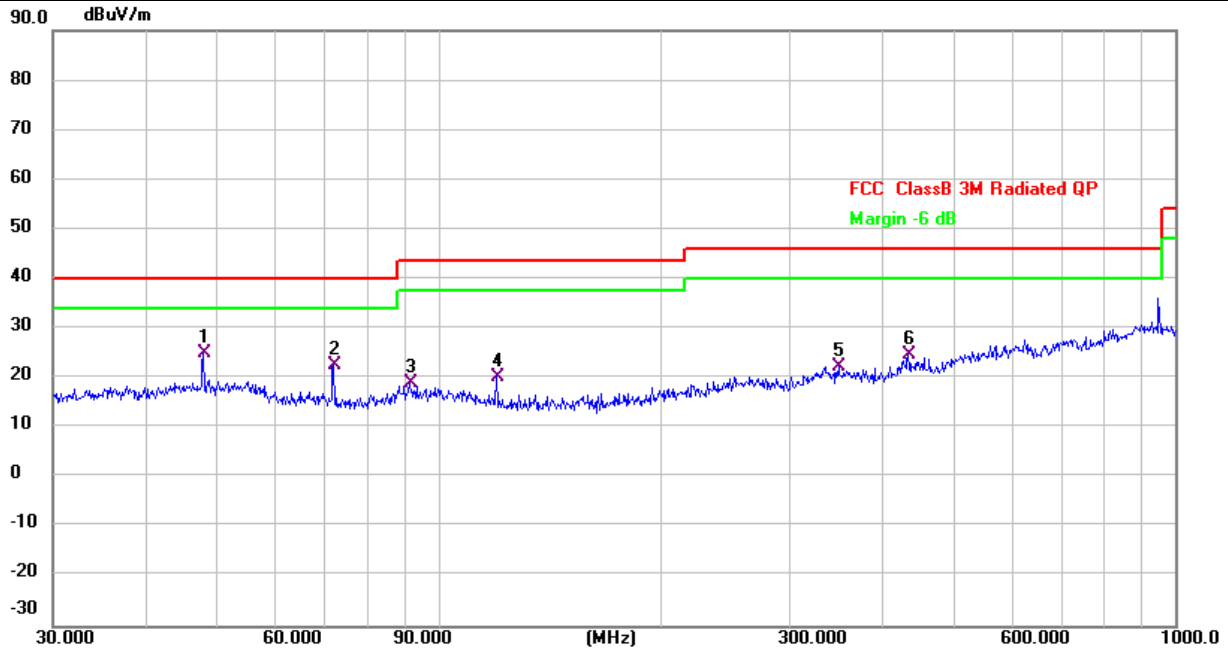

| No. | Mk. | Freq. MHz | Reading Level dBuV | Correct Factor dB | Measure- ment dBuV/m | Limit dBuV/m | Over dB | Detector |
|-----|-----|--------------|--------------------------|-------------------------|----------------------------|-----------------|------------|----------|
| 1 | * | 47.9940 | 32.63 | -7.54 | 25.09 | 40.00 | -14.91 | QP |
| 2 | | 72.0843 | 32.84 | -10.04 | 22.80 | 40.00 | -17.20 | QP |
| 3 | | 91.4949 | 27.88 | -8.85 | 19.03 | 43.50 | -24.47 | QP |
| 4 | | 119.8556 | 30.61 | -10.21 | 20.40 | 43.50 | -23.10 | QP |
| 5 | | 349.2500 | 26.94 | -4.66 | 22.28 | 46.00 | -23.72 | QP |
| 6 | | 434.0651 | 28.19 | -3.30 | 24.89 | 46.00 | -21.11 | QP |

Note:

1. Emission Level = Meter Reading + Factor, Margin= Emission Level- Limit, Factor = Antenna Factor + Cable Loss – Pre-amplifier.
2. The three modulated high, medium and low channels have been tested. The report only shows the worst mode. The worst mode is CH00.



1GHz-25GHz

| Frequency (MHz) | Read Level (dBμV) | Cable loss (dB) | Antenna Factor dB/m | Preamp Factor (dB) | Emission Level (dBμV/m) | Limits (dBμV/m) | Margin (dB) | Remark | Comment |
|-----------------------------------|-------------------------|-----------------------|---------------------------|--------------------------|-------------------------------|--------------------|----------------|--------|------------|
| Low Channel (2402 MHz)-Above 1G | | | | | | | | | |
| 4804.338 | 63.23 | 4.36 | 32.92 | 45.53 | 54.98 | 74.00 | -19.02 | Pk | Vertical |
| 4804.338 | 42.32 | 4.36 | 32.92 | 45.53 | 34.07 | 54.00 | -19.93 | AV | Vertical |
| 7206.107 | 62.01 | 5.02 | 37.63 | 45.56 | 59.10 | 74.00 | -14.90 | Pk | Vertical |
| 7206.107 | 40.73 | 5.02 | 37.63 | 45.56 | 37.82 | 54.00 | -16.18 | AV | Vertical |
| 4804.169 | 64.04 | 4.36 | 32.92 | 45.53 | 55.79 | 74.00 | -18.21 | Pk | Horizontal |
| 4804.169 | 42.14 | 4.36 | 32.92 | 45.53 | 33.89 | 54.00 | -20.11 | AV | Horizontal |
| 7206.214 | 62.19 | 5.02 | 37.63 | 45.56 | 59.28 | 74.00 | -14.72 | Pk | Horizontal |
| 7206.214 | 42.33 | 5.02 | 37.63 | 45.56 | 39.42 | 54.00 | -14.58 | AV | Horizontal |
| Mid Channel (2440 MHz)-Above 1G | | | | | | | | | |
| 4880.473 | 63.50 | 4.41 | 33.01 | 45.76 | 55.16 | 74.00 | -18.84 | Pk | Vertical |
| 4880.473 | 43.80 | 4.41 | 33.01 | 45.76 | 35.46 | 54.00 | -18.54 | AV | Vertical |
| 7320.265 | 65.64 | 5.02 | 37.68 | 45.59 | 62.75 | 74.00 | -11.25 | Pk | Vertical |
| 7320.265 | 42.06 | 5.02 | 37.68 | 45.59 | 39.17 | 54.00 | -14.83 | AV | Vertical |
| 4880.366 | 62.36 | 4.41 | 33.01 | 45.76 | 54.02 | 74.00 | -19.98 | Pk | Horizontal |
| 4880.366 | 40.90 | 4.41 | 33.01 | 45.76 | 32.56 | 54.00 | -21.44 | AV | Horizontal |
| 7320.234 | 60.36 | 5.02 | 37.68 | 45.59 | 57.47 | 74.00 | -16.53 | Pk | Horizontal |
| 7320.234 | 43.94 | 5.02 | 37.68 | 45.59 | 41.05 | 54.00 | -12.95 | AV | Horizontal |
| High Channel (2480 MHz)- Above 1G | | | | | | | | | |
| 4960.482 | 63.59 | 4.50 | 33.26 | 46.07 | 55.28 | 74.00 | -18.72 | Pk | Vertical |
| 4960.482 | 42.24 | 4.50 | 33.26 | 46.07 | 33.93 | 54.00 | -20.07 | AV | Vertical |
| 7440.131 | 64.73 | 5.02 | 37.78 | 45.77 | 61.76 | 74.00 | -12.24 | Pk | Vertical |
| 7440.131 | 49.40 | 5.02 | 37.78 | 45.77 | 46.43 | 54.00 | -7.57 | AV | Vertical |
| 4960.326 | 64.48 | 4.50 | 33.26 | 46.07 | 56.17 | 74.00 | -17.83 | Pk | Horizontal |
| 4960.326 | 45.08 | 4.50 | 33.26 | 46.07 | 36.77 | 54.00 | -17.23 | AV | Horizontal |
| 7440.199 | 64.16 | 5.02 | 37.78 | 45.77 | 61.19 | 74.00 | -12.81 | Pk | Horizontal |
| 7440.199 | 45.33 | 5.02 | 37.78 | 45.77 | 42.36 | 54.00 | -11.64 | AV | Horizontal |

Note:

1. All Readings are Peak Value (VBW=3MHz) and AV Value (VBW=10Hz).
2. Emission Level= Antenna Factor + Cable Loss + Read Level - Preamp Factor
3. All the modulation modes have been tested, and the worst results are reflected in the report.



5.4.4.1 Band edge-radiated

| Frequency | Meter Reading | Cable Loss | Antenna Factor | Preamp Factor | Emission Level | Limits | Margin | Detector | Comment |
|-----------|---------------|------------|----------------|---------------|----------------|----------------|--------|----------|------------|
| (MHz) | (dB μ V) | (dB) | dB/m | (dB) | (dB μ V/m) | (dB μ V/m) | (dB) | Type | |
| GFSK | | | | | | | | | |
| 2310.00 | 63.53 | 2.40 | 27.70 | 40.40 | 53.23 | 74 | -20.77 | Pk | Horizontal |
| 2310.00 | 42.45 | 2.40 | 27.70 | 40.40 | 32.15 | 54 | -21.85 | AV | Horizontal |
| 2310.00 | 62.10 | 2.40 | 27.70 | 40.40 | 51.80 | 74 | -22.20 | Pk | Vertical |
| 2310.00 | 41.93 | 2.40 | 27.70 | 40.40 | 31.63 | 54 | -22.37 | AV | Vertical |
| 2390.00 | 63.39 | 2.44 | 28.30 | 40.10 | 54.03 | 74 | -19.97 | Pk | Vertical |
| 2390.00 | 43.09 | 2.44 | 28.30 | 40.10 | 33.73 | 54 | -20.27 | AV | Vertical |
| 2390.00 | 65.03 | 2.44 | 28.30 | 40.10 | 55.67 | 74 | -18.33 | Pk | Horizontal |
| 2390.00 | 42.11 | 2.44 | 28.30 | 40.10 | 32.75 | 54 | -21.25 | AV | Horizontal |
| 2483.50 | 61.49 | 2.48 | 28.70 | 39.80 | 52.87 | 74 | -21.13 | Pk | Vertical |
| 2483.50 | 43.34 | 2.48 | 28.70 | 39.80 | 34.72 | 54 | -19.28 | AV | Vertical |
| 2483.50 | 66.02 | 2.48 | 28.70 | 39.80 | 57.40 | 74 | -16.60 | Pk | Horizontal |
| 2483.50 | 43.95 | 2.48 | 28.70 | 39.80 | 35.33 | 54 | -18.67 | AV | Horizontal |



5.4.4.2 Spurious Emission in Restricted Band 3260MHz-18000MHz

All the modulation modes have been tested, and the worst result was report as below:

| Frequency | Reading Level | Cable Loss | Antenna Factor | Preamp Factor | Emission Level | Limits | Margin | Detector | Comment |
|-----------|---------------|------------|----------------|---------------|----------------|----------|--------|----------|------------|
| (MHz) | (dBμV) | (dB) | dB/m | (dB) | (dBμV/m) | (dBμV/m) | (dB) | Type | |
| 3260 | 61.29 | 3.27 | 30.02 | 38.05 | 56.53 | 74 | -17.47 | Pk | Vertical |
| 3260 | 40.37 | 3.27 | 30.02 | 38.05 | 35.61 | 54 | -18.39 | AV | Vertical |
| 3260 | 64.01 | 3.27 | 30.02 | 38.05 | 59.25 | 74 | -14.75 | Pk | Horizontal |
| 3260 | 42.44 | 3.27 | 30.02 | 38.05 | 37.68 | 54 | -16.32 | AV | Horizontal |
| 3332 | 63.47 | 3.31 | 30.00 | 37.91 | 58.87 | 74 | -15.13 | Pk | Vertical |
| 3332 | 42.18 | 3.31 | 30.00 | 37.91 | 37.58 | 54 | -16.42 | AV | Vertical |
| 3332 | 64.01 | 3.31 | 30.00 | 37.91 | 59.41 | 74 | -14.59 | Pk | Horizontal |
| 3332 | 42.01 | 3.31 | 30.00 | 37.91 | 37.41 | 54 | -16.59 | AV | Horizontal |
| 17797 | 43.50 | 8.63 | 44.23 | 39.60 | 56.76 | 74 | -17.24 | Pk | Vertical |
| 17797 | 30.23 | 8.63 | 44.23 | 39.60 | 43.49 | 54 | -10.51 | AV | Vertical |
| 17788 | 43.52 | 8.63 | 44.23 | 39.60 | 56.78 | 74 | -17.22 | Pk | Horizontal |
| 17788 | 30.25 | 8.63 | 44.23 | 39.60 | 43.51 | 54 | -10.49 | AV | Horizontal |



5.5 Power spectral density test

5.5.1 Limit

| FCC Part15 (15.247) , Subpart C | | | |
|---------------------------------|------------------------|------------------------|-----------------------|
| Section | Test Item | Limit | Frequency Range (MHz) |
| 15.247 | Power Spectral Density | 8 dBm (in any 3kHz) | 2400-2483.5 |

5.5.2 Test Procedure

1. Set analyzer center frequency to DTS channel center frequency.
2. Set the span to 1.5 times the DTS channel bandwidth.
3. Set the RBW \geq 3 kHz.
4. Set the VBW \geq 3 x RBW.
5. Detector = peak.
6. Sweep time = auto couple.
7. Trace mode = max hold.
8. Allow trace to fully stabilize.
9. Use the peak marker function to determine the maximum amplitude level.
10. If measured value exceeds limit, reduce RBW (no less than 3 kHz) and repeat.

5.5.3 Test Setup

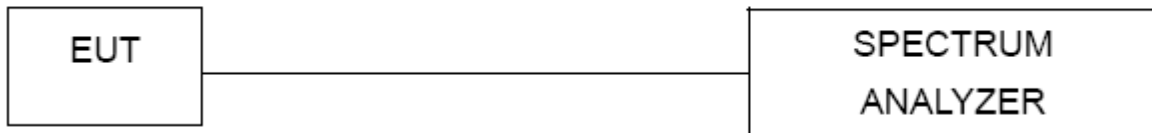



5.5.4 Test Results

| | | | |
|------------|---------------------------|---------------|--------------------------|
| EUT: | Smart WATCH | Model Name: | M9006PRO |
| Pressure: | 1015 hPa | Test Voltage: | Power by battery DC 3.7V |
| Test Mode: | TX Mode /CH00, CH19, CH39 | | |

| Frequency | Power Density (dBm/3kHz) | Limit (dBm/3kHz) | Result |
|-----------|--------------------------|------------------|--------|
| 2402 MHz | -1.621 | 8 | PASS |
| 2440 MHz | -0.248 | 8 | PASS |
| 2480 MHz | -1.750 | 8 | PASS |





TX CH19



TX CH39





5.6 6dB bandwidth

5.6.1 Limit

| FCC Part15 (15.247) , Subpart C | | | |
|---------------------------------|-----------|---|-----------------------|
| Section | Test Item | Limit | Frequency Range (MHz) |
| 15.247(a)(2) | Bandwidth | $\geq 500\text{kHz}$ (6dB bandwidth) | 2400-2483.5 |

5.6.2 Test Procedure

1. Set RBW= 100 kHz.
2. Set the video bandwidth (VBW) $\geq 3 \times$ RBW.
3. Detector = Peak.
4. Trace mode = max hold.
5. Sweep = auto couple.
6. Allow the trace to stabilize.
7. Measure the maximum width of the emission that is constrained by the frequencies associated with the two outermost amplitude points (upper and lower) that are attenuated by 6 dB relative to the maximum level measured in the fundamental emission.

5.6.3 Test Setup

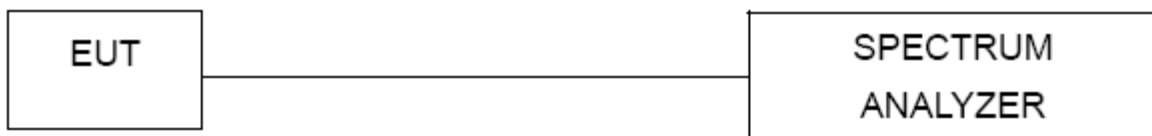

5.6.4 Test Result



| | | | |
|------------|---------------------------|---------------|--------------------------|
| EUT: | Smart WATCH | Model Name: | M9006PRO |
| Pressure: | 1012 hPa | Test Voltage: | Power by battery DC 3.7V |
| Test Mode: | TX Mode /CH00, CH19, CH39 | | |

| Channel | Frequency (MHz) | 6dB bandwidth (kHz) | Limit (kHz) | Result |
|---------|-----------------|---------------------|-------------|--------|
| Low | 2402 | 688.1 | 500 | Pass |
| Middle | 2440 | 681.7 | 500 | Pass |
| High | 2480 | 662.7 | 500 | Pass |

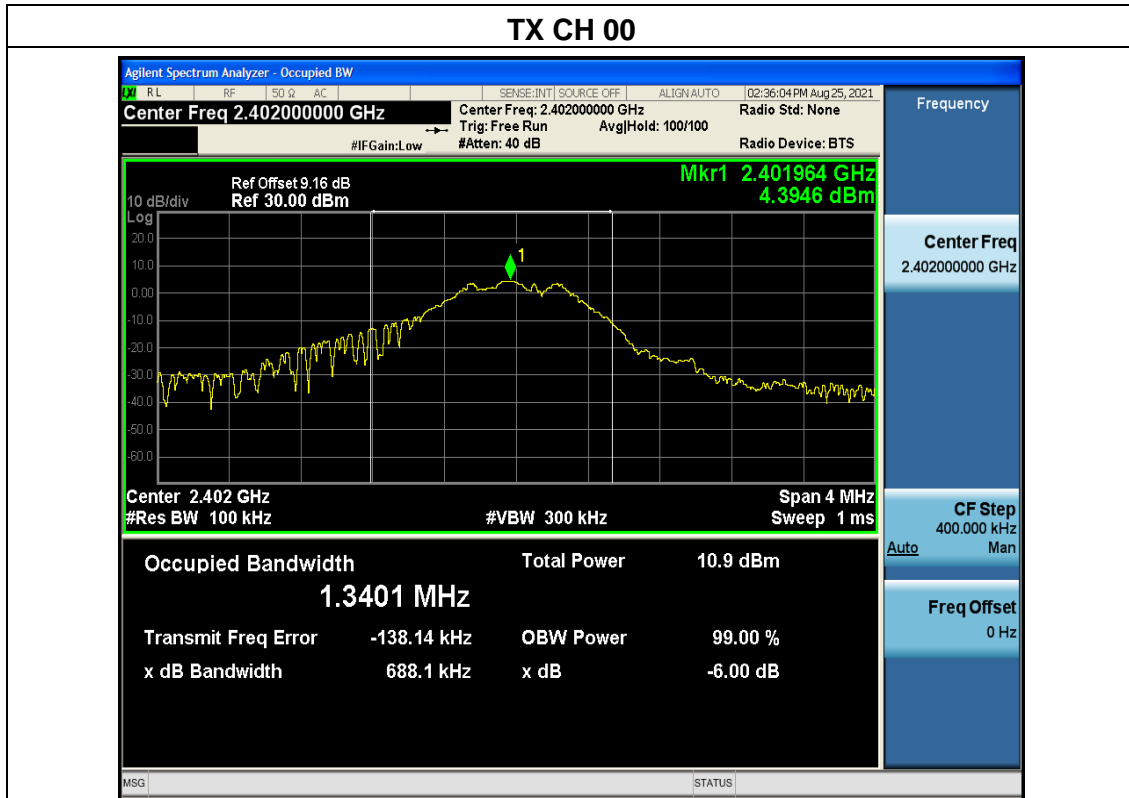

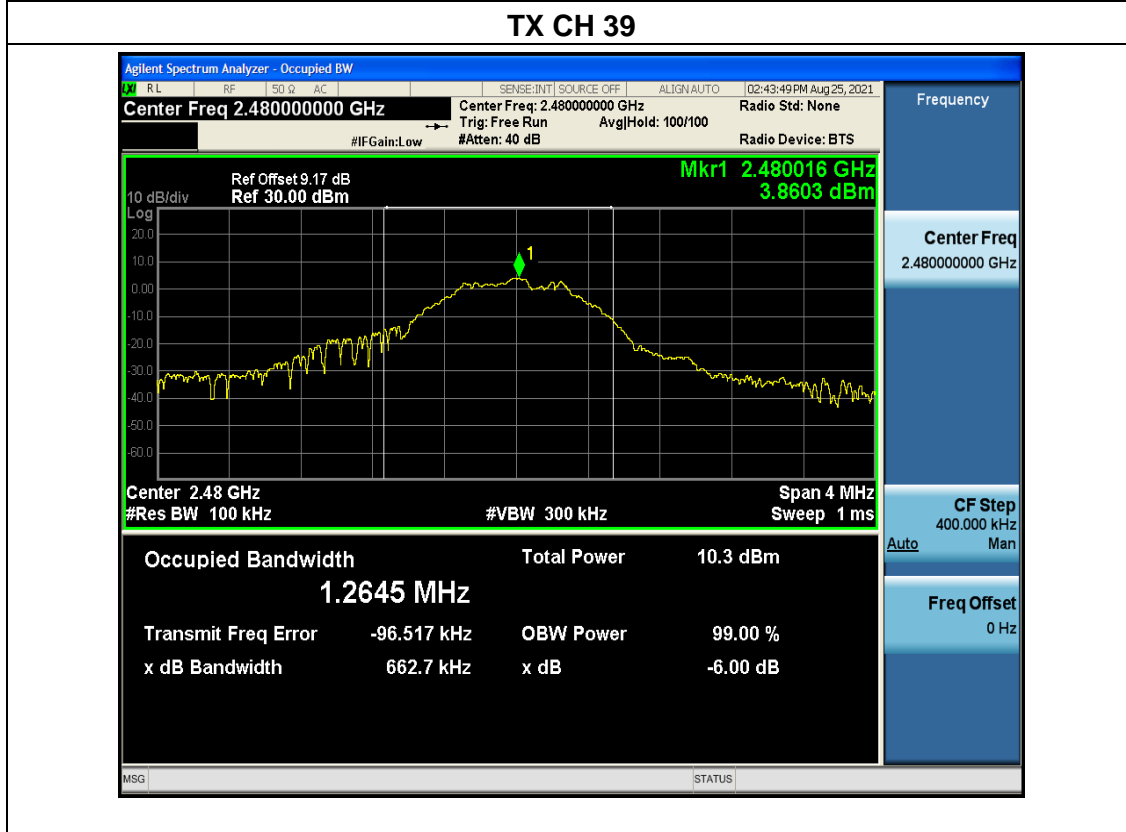
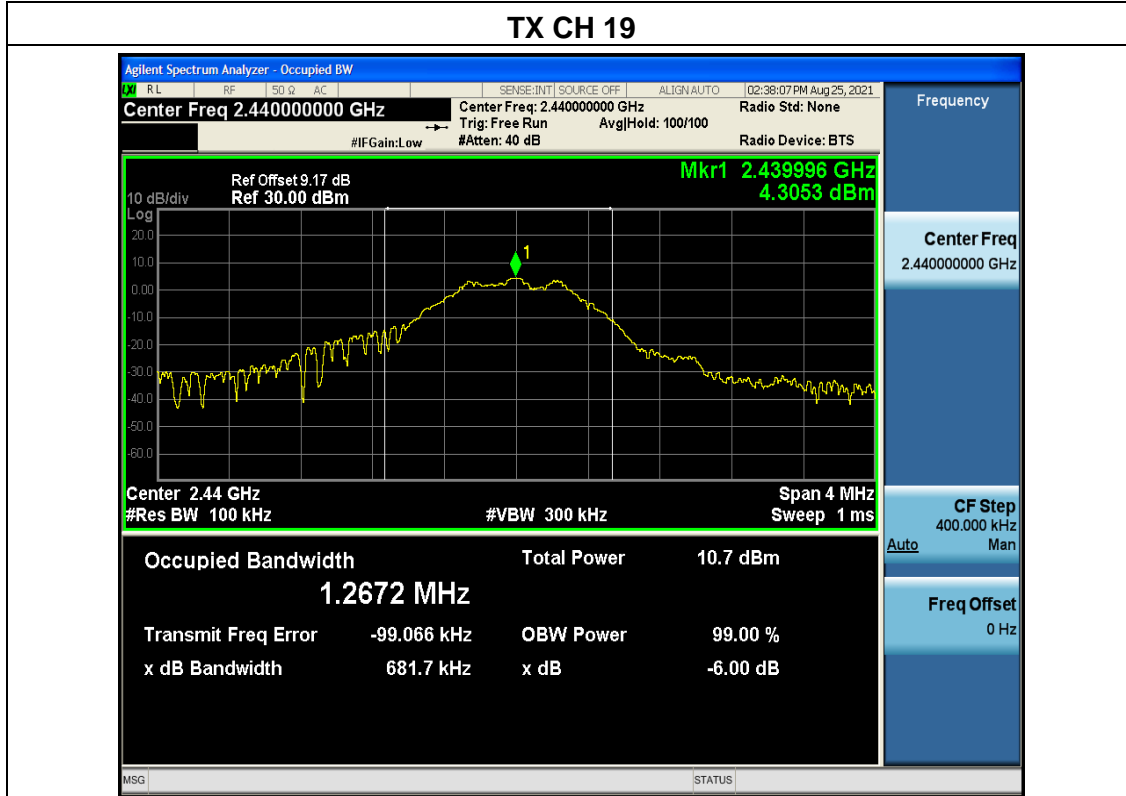



5.7 Duty Cycle

5.7.1 Conformance Limit

No limit requirement.

5.7.2 Measuring Instruments

The Measuring equipment is listed in the section 4 of this test report.

5.7.3 Test Setup



5.7.4 Test Procedure

The zero-span mode on a spectrum analyzer or EMI receiver if the response time and spacing between bins on the sweep are sufficient to permit accurate measurements of the on and off times of the transmitted signal. Set the center frequency of the instrument to the center frequency of the transmission. Set $RBW \geq OBW$ if possible; otherwise, set RBW to the largest available value. Set $VBW \geq RBW$. Set detector = peak or average. The zero-span measurement method shall not be used unless both RBW and VBW are $> 50/T$ and the number of sweep points across duration T exceeds 100. (For example, if VBW and/or RBW are limited to 3 MHz, then the zero-span method of measuring duty cycle shall not be used if $T \leq 16.7$ microseconds.)

The transmitter output is connected to the Spectrum Analyzer. We tested according to the zero-span measurement method, 6.0(b) in KDB 558074 D01 DTS Meas Guidance v05r02.

The largest available value of RBW is 8 MHz and VBW is 50 MHz. The zero-span method of measuring duty cycle shall not be used if $T \leq 6.25$ microseconds. ($50/6.25 = 8$)

The zero-span method was used because all measured T data are > 6.25 microseconds and both RBW and VBW are $> 50/T$.

The RF output of EUT was connected to the spectrum analyzer by RF cable and attenuator.

The path loss was compensated to the results for each measurement.

Set to the maximum power setting and enable the EUT transmit continuously.

The EUT was operating in controlled its channel.

Use the following spectrum analyzer settings:

Span = Zero Span

RBW = 8MHz (the largest available value)

VBW = 8MHz (\geq RBW)

Number of points in Sweep >100

Detector function = peak

Trace = Clear write

Measure Total and Ton

Calculate Duty Cycle = $Ton / Total$



5.7.5 Test Results

| | | | |
|------------|---------------------------|---------------|--------------------------|
| EUT: | Smart WATCH | Model Name: | M9006PRO |
| Pressure: | 1012 hPa | Test Voltage: | Power by battery DC 3.7V |
| Test Mode: | TX Mode /CH00, CH19, CH39 | | |

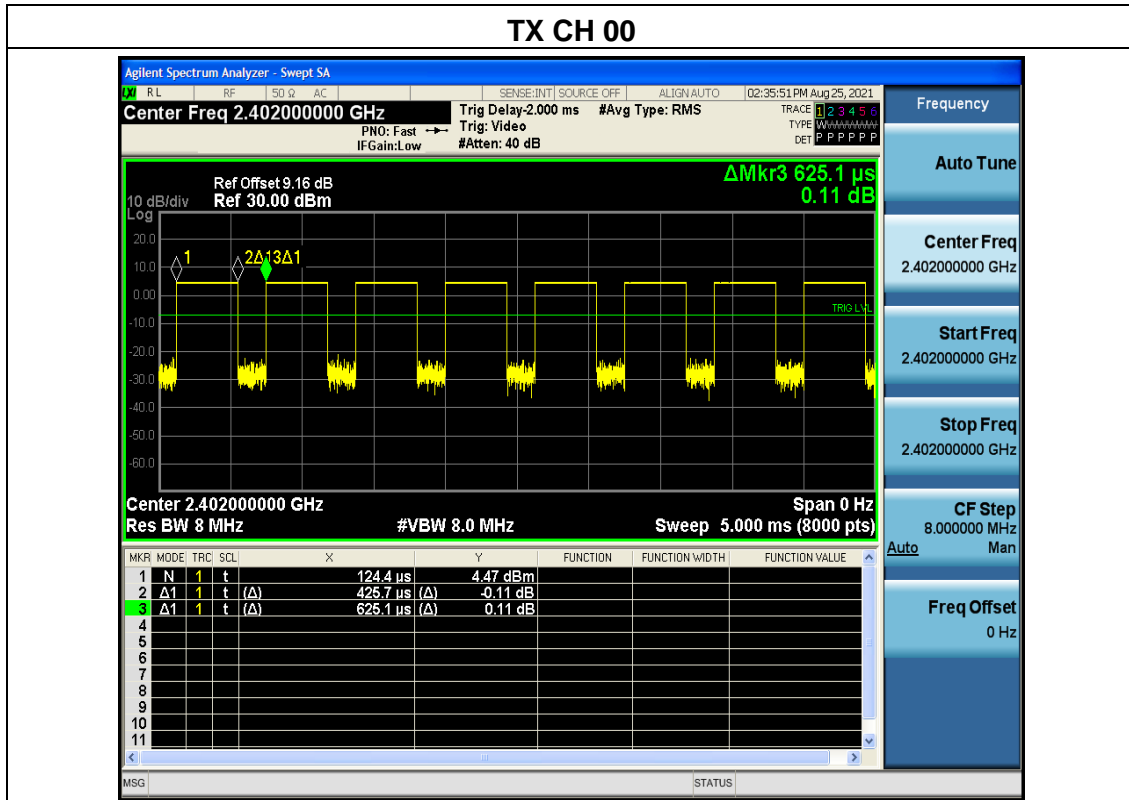



TX CH 19

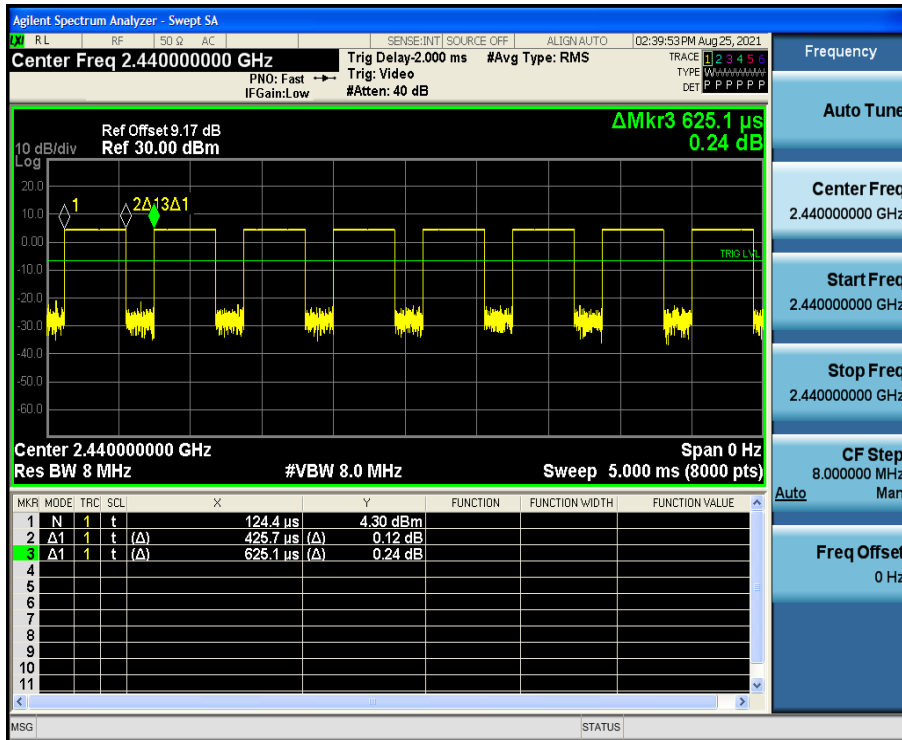

TX CH 39

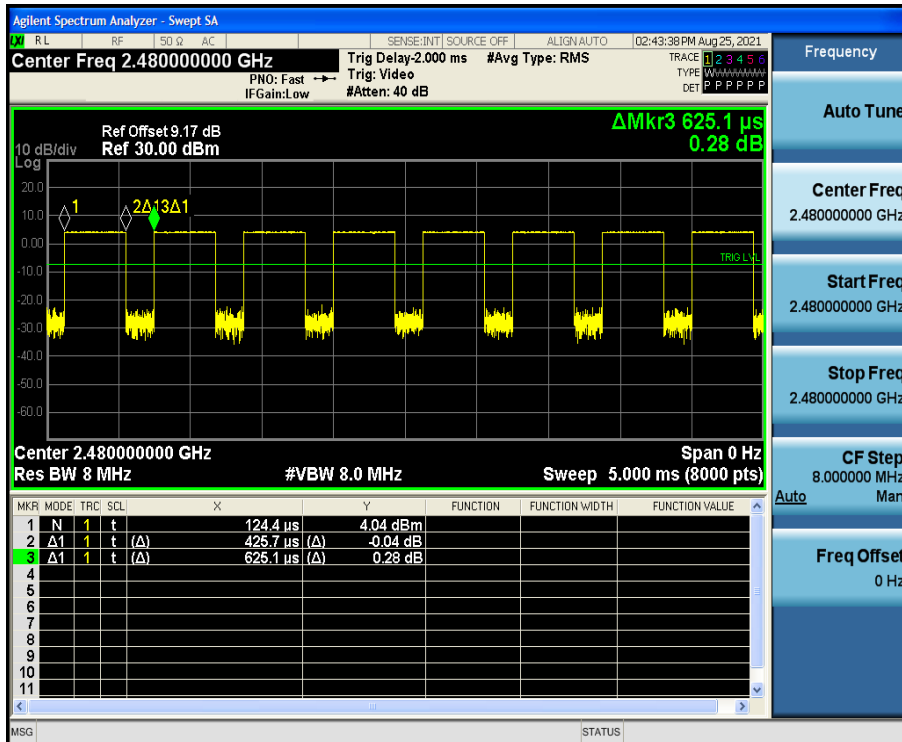



5.8 Conducted band edge

5.8.1 Limits

In any 100 kHz bandwidth outside the frequency band in which the spread spectrum or digitally modulated intentional radiator is operating, the radio frequency power that is produced by the intentional radiator shall be at least 20 dB below that in the 100 kHz bandwidth within the band that contains the highest level of the desired power, based on either an RF conducted or a radiated measurement, provided the transmitter demonstrates compliance with the peak conducted power limits. If the transmitter complies with the conducted power limits based on the use of RMS averaging over a time interval, as permitted under paragraph (b)(3) of this section, the attenuation required under this paragraph shall be 30 dB instead of 20 dB. Attenuation below the general limits specified in §15.209(a) is not required. In addition, radiated emissions which fall in the restricted bands, as defined in §15.205(a), must also comply with the radiated emission limits specified in §15.209(a) (see §15.205(c)).

5.8.2 Test Setup



5.8.3 Test Procedure

- a) Check the calibration of the measuring instrument using either an internal calibrator or a known signal from an external generator.
- b) Position the EUT without connection to measurement instrument. Turn on the EUT and connect its antenna terminal to measurement instrument via a low loss cable. Then set it to any one measured frequency within its operating range, and make sure the instrument is operated in its linear range.
- c) Set RBW to 100 kHz and VBW of spectrum analyzer to 300 kHz with a convenient frequency span including 100 kHz bandwidth from band edge.
- d) Measure the highest amplitude appearing on spectral display and set it as a reference level. Plot the graph with marking the highest point and edge frequency.
- e) Repeat above procedures until all measured frequencies were complete.

5.8.4 Test Result



| | | | |
|------------|---------------------|---------------|--------------------------|
| EUT: | Smart WATCH | Model Name: | M9006PRO |
| Pressure: | 1012 hPa | Test Voltage: | Power by battery DC 3.7V |
| Test Mode: | TX Mode /CH00, CH39 | | |

BLE: Band Edge, Left Side

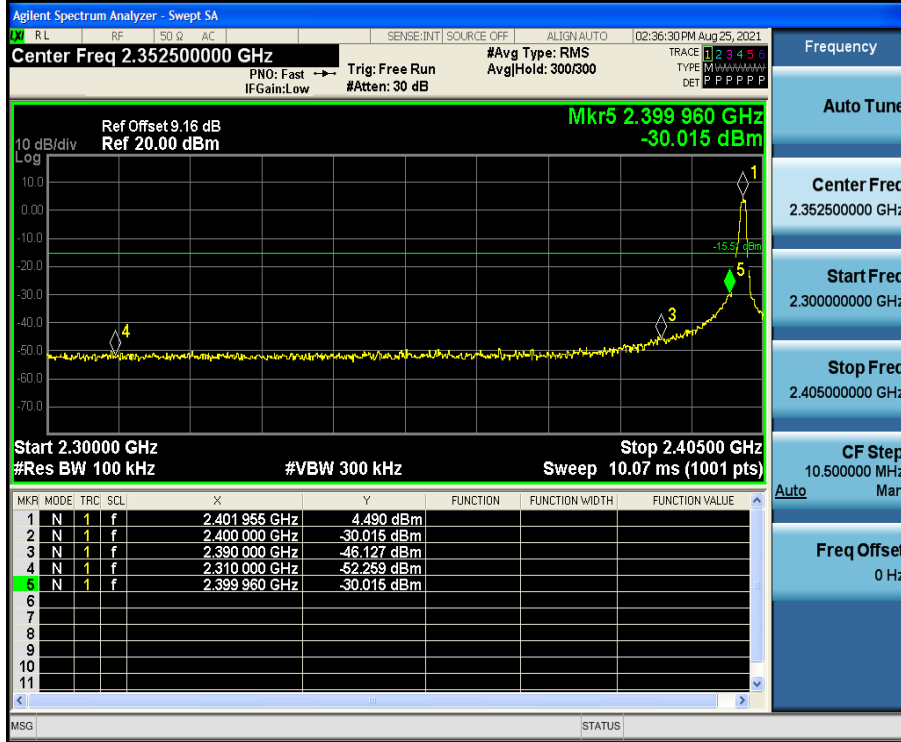

BLE: Band Edge, Right Side

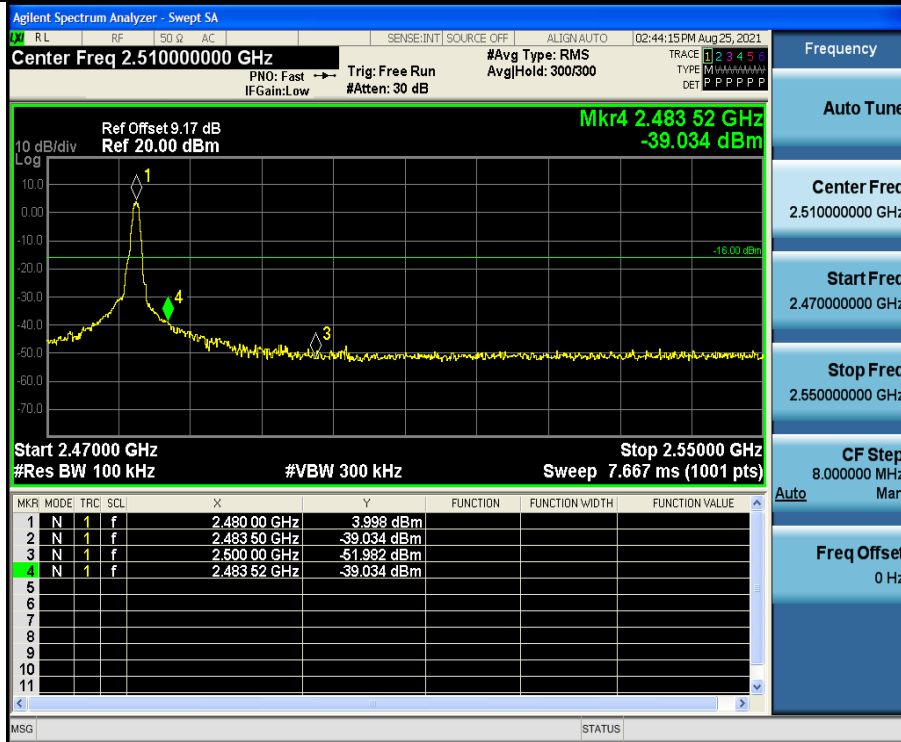



5.9 Spurious RF Conducted Emissions

5.9.1 Conformance Limit

Below -20dB of the highest emission level in operating band.

5.9.2 Measuring Instruments

The Measuring equipment is listed in the section 6.3 of this test report.

5.9.3 Test Setup

Please refer to Section 6.1 of this test report.

5.9.4 Test Procedure

The Spurious RF conducted emissions compliance of RF radiated emission should be measured by following the guidance in ANSI C63.10-2013 with respect to maximizing the emission by rotating the EUT, measuring the emission while the EUT is situated in three orthogonal planes (if appropriate), adjusting the measurement antenna height and polarization etc. Set RBW=100kHz and VBW= 300kHz to measure the peak field strength, and measure frequency range from 9kHz to 26.5GHz.

5.9.5 Test Results

Note: The measurement frequency range is from 9kHz to the 10th harmonic of the fundamental frequency. The lowest, middle and highest channels are tested to verify the spurious emissions and band edge measurement data.

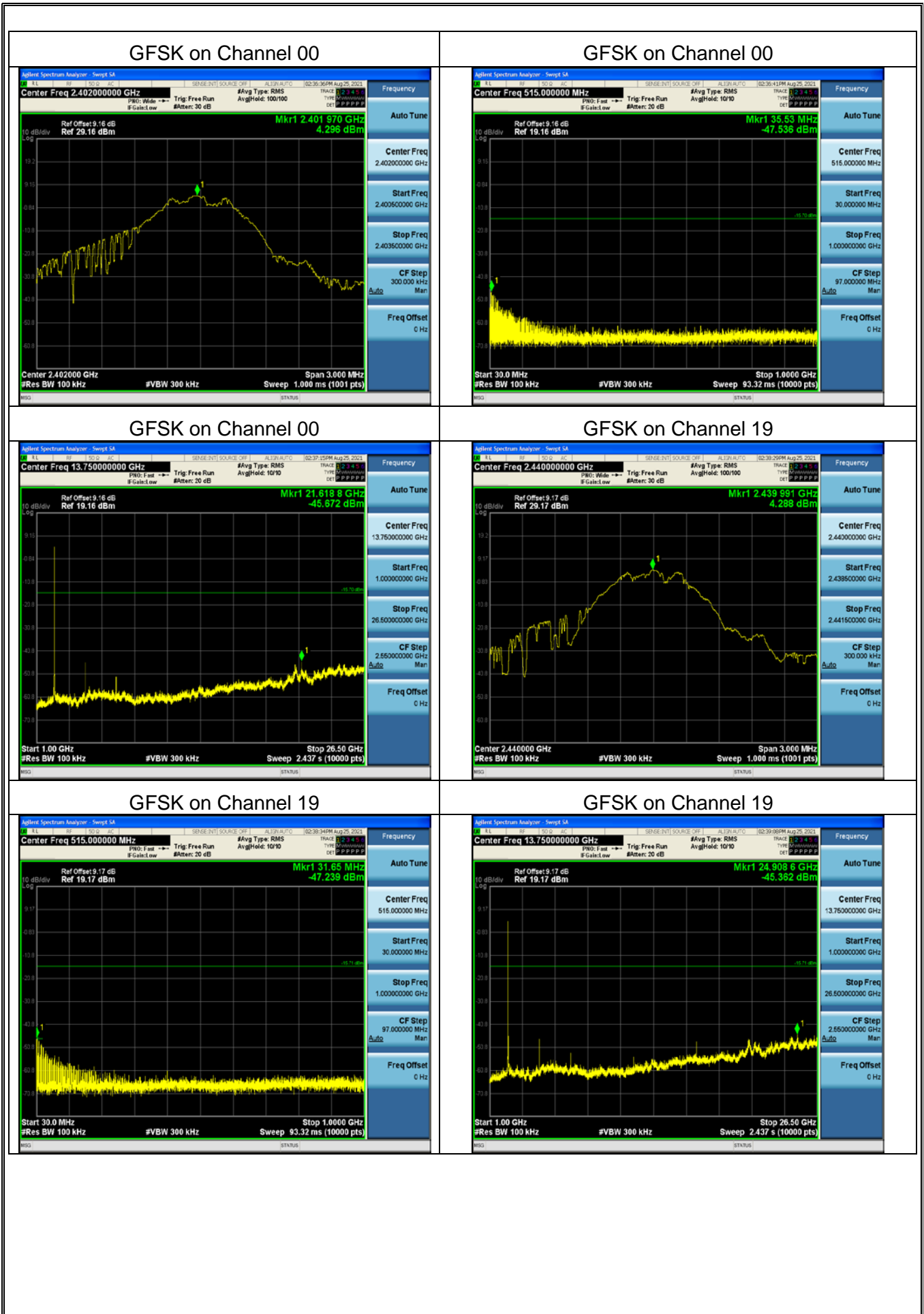



GFSK on Channel 39



GFSK on Channel 39

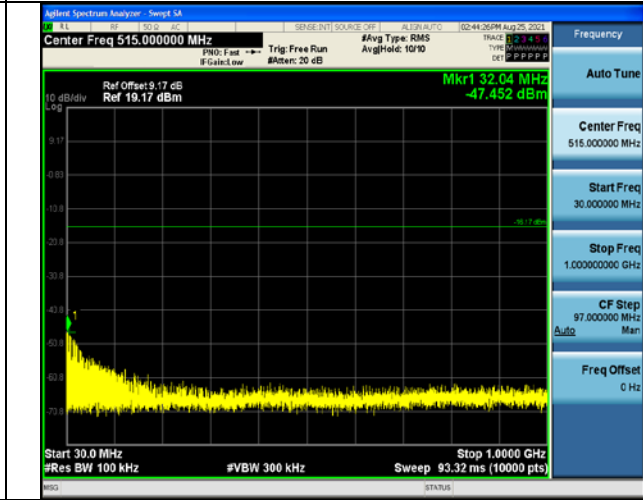

GFSK on Channel 39

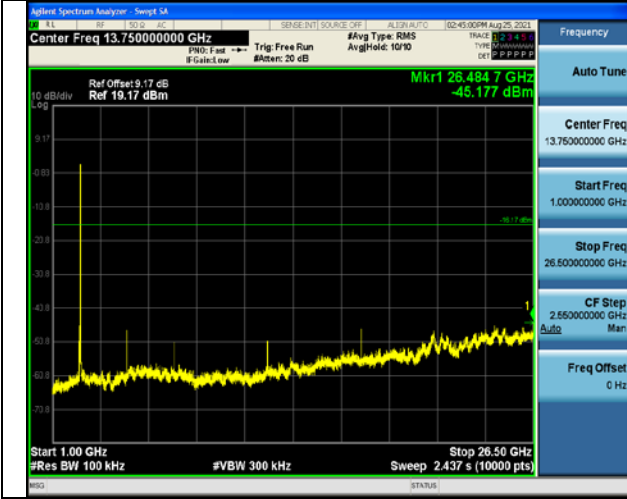



Photographs of the Test Setup

Radiated emission





Photographs of the EUT

See the APPENDIX 1- EUT PHOTO.

----END OF REPORT----