

Bluetooth Radio FCC Test Report

Equipment : Norton Core Secure WiFi Router
Brand Name : Norton Core
Model No. : 517
FCC ID : 2A16F-517
Standard : 47 CFR FCC Part 15.247
Operating Band : 2400 MHz – 2483.5 MHz
Applicant : Symantec Corporation
350 Ellis Street Mountain View, CA 94043 United States
Manufacturer : CyberTAN Technology Inc.
No. 99, Park Avenue III, Science-based Industrial Park,
Hsinchu, 308 Taiwan

The product sample received on Aug. 18, 2016 and completely tested on Mar. 14, 2017. We, SPORTON, would like to declare that the tested sample has been evaluated in accordance with the procedures given inanes and shown compliance with the applicable technical standards.

The test results in this report apply exclusively to the tested model / sample. Without written approval of SPORTON INTERNATIONALINC., the test report shall not be reproduced except in full.

Cliff Chang
SPORTON INTERNATIONAL INC.



Table of Contents

1	GENERAL DESCRIPTION	5
1.1	Information.....	5
1.2	Testing Applied Standards	7
1.3	Testing Location Information	7
1.4	Measurement Uncertainty	7
2	TEST CONFIGURATION OF EUT	8
2.1	Test Channel Mode	8
2.2	The Worst Case Measurement Configuration.....	9
2.3	EUT Operation during Test	9
2.4	Accessories	10
2.5	Support Equipment.....	10
2.6	Test Setup Diagram	11
3	TRANSMITTER TEST RESULT	14
3.1	AC Power-line Conducted Emissions	14
3.2	20dB Bandwidth and Carrier Frequency Separation	16
3.3	Maximum Conducted Output Power	17
3.4	Number of Hopping Frequencies and Hopping Bandedge	18
3.5	Time of Occupancy (Dwell Time)	19
3.6	Emissions in Non-restricted Frequency Bands	20
3.7	Emissions in Restricted Frequency Bands.....	21
4	TEST EQUIPMENT AND CALIBRATION DATA	24
APPENDIX A. TEST RESULTS OF AC POWER-LINE CONDUCTED EMISSIONS		
APPENDIX B. TEST RESULTS OF 20DB BANDWIDTH AND CARRIER FREQUENCY SEPARATION		
APPENDIX C. TEST RESULTS OF MAXIMUM CONDUCTED OUTPUT POWER		
APPENDIX D. TEST RESULTS OF NUMBER OF HOPPING FREQUENCIES AND HOPPING BANDEDGE		
APPENDIX E. TEST RESULTS OF TIME OF OCCUPANCY (DWELL TIME)		
APPENDIX F. TEST RESULTS OF EMISSIONS IN NON-RESTRICTED FREQUENCY BANDS		
APPENDIX G. TEST RESULTS OF EMISSIONS IN RESTRICTED FREQUENCY BANDS		
APPENDIX H. TEST RESULTS OF RADIATED EMISSION CO-LOCATION		
APPENDIX I. TEST PHOTOS		
PHOTOGRAPHS OF EUT V01		

Summary of Test Result

Conformance Test Specifications				
Report Clause	Ref. Std. Clause	Description	Limit	Result
1.1.2	15.203	Antenna Requirement	FCC 15.203	Complied
3.1	15.207	AC Power-line Conducted Emissions	FCC 15.207	Complied
3.2	15.247(a)	20dB Bandwidth	15.247(a)	Complied
3.2	15.247(a)	Carrier Frequency Separation	15.247(a)	Complied
3.3	15.247(b)	Maximum Conducted Output Power	15.247(b)	Complied
3.4	15.247(a)	Number of Hopping Frequencies and Hopping Band edge	15.247(a)	Complied
3.5	15.247(a)	Time of Occupancy (Dwell Time)	15.247(a)	Complied
3.6	15.247(d)	Emissions in Non-restricted Frequency Bands	15.247(d)	Complied
3.7	15.247(d)	Emissions in Restricted Frequency Bands	Restricted Bands: FCC 15.209	Complied

1 General Description

1.1 Information

1.1.1 RF General Information

Frequency Range (MHz)	Bluetooth Version	Ch. Frequency (MHz)	Channel Number
2400-2483.5	BR / EDR	2402-2480	0-78 [79]

Band	Mode	BWch (MHz)	Nant
2.4-2.4835GHz	BT-BR(1Mbps)	1	1
2.4-2.4835GHz	BT-EDR(2Mbps)	1	1
2.4-2.4835GHz	BT-EDR(3Mbps)	1	1

Note:

- ♦ 2.4G is the 2.4GHz Band (2.4-2.4835GHz).
- ♦ Bluetooth BR uses a GFSK (1Mbps).
- ♦ Bluetooth EDR uses a combination of $\pi/4$ -DQPSK (2Mbps) and 8DPSK (3Mbps).
- ♦ Bluetooth BR/EDR uses as a system using FHSS modulation.
- ♦ BWch is the channel separation
- ♦ Nss-Min is the minimum number of spatial streams.
- ♦ Nant is the number of outputs. e.g., 2(2, 3) means have 2 outputs for port 2 and port 3. 2 means have 2 outputs for port 1 and port 2.

1.1.2 Antenna Information

Ant.	Brand	Model Name P/N	Antenna Type	Connector	Gain (dBi)			
					2.4GHz	5GHz B1	5GHz B4	BT
1	Airgain	M2410DCR-UV-G1XST125BU	Dual-band Dipole	I-PEX	1.5	2.3	3.3	-
2	Airgain	M2410DCR-UV-B1XST135BU	Dual-band Dipole	I-PEX	1.5	2.3	3.3	-
3	Airgain	M2410DCR-UV-A1XST115BU	Dual-band Dipole	I-PEX	1.5	2.3	3.3	-
4	Airgain	M2410DCR-UV-G1XST125BU	Dual-band Dipole	I-PEX	1.5	2.3	3.3	-
5	PSA	RFMTA271200NNAB003	PIFA Antenna	N/A	-	-	-	2.54

Note: The EUT has five antennas.

Ant.1 = Chain 1(port 1), Ant.2 = Chain 2(port 2), Ant.3 = Chain 3(port 3), Ant.4 = Chain 4(port 4), Ant.5= Chain 5(port 1).

For WLAN function (4TX, 4RX):

Chain 1 ~ Chain 4 can be used as transmitting/receiving antenna.

Chain 1 ~ Chain 4 could transmit/receive simultaneously.

For Bluetooth function (1TX, 1RX):

Only Chain 5 can be used as transmitting/receiving functions.



1.1.3 Mode Test Duty Cycle

Mode	DC	DCF(dB)
BT-BR(1Mbps)	0.825	0.835
BT-EDR(2Mbps)	0.839	0.762
BT-EDR(3Mbps)	0.856	0.675

1.1.4 EUT Operational Condition

EUT Power Type	From Power Adapter
----------------	--------------------

1.1.5 Table for Multiple Listing

The EUT has two exterior which are identical to each other in all aspects except for the following table:

Brand Name	Model Name	EUT	Color
Norton Core	517	1	Granite Gray
		2	Titanium Gold

1.2 Testing Applied Standards

According to the specifications of the manufacturer, the EUT must comply with the requirements of the following standards:

- ◆ 47 CFR FCC Part 15
- ◆ FCC Public Notice DA 00-705
- ◆ FCC KDB 412172 D01 v01r01

1.3 Testing Location Information

Testing Location		
<input type="checkbox"/>	HWA YA	ADD : No. 52, Hwa Ya 1st Rd., Kwei-Shan Hsiang, Tao Yuan Hsien, Taiwan, R.O.C. TEL : 886-3-327-3456 FAX : 886-3-318-0055
<input checked="" type="checkbox"/>	JHUBEI	ADD : No.8, Lane 724, Bo-ai St., Jhubei City, HsinChu County 302, Taiwan, R.O.C. TEL : 886-3-656-9065 FAX : 886-3-656-9085

Test Condition	Test Site No.	Test Engineer	Test Environment	Test Date
RF Conducted	TH01-CB	Serway Li	20°C / 60%	Mar. 07, 2017 Mar. 08, 2017
Radiated	03CH01-CB	Zero Chen, Nyle, Chang, Justin Lin	22°C / 54%	Dec. 26, 2016 Mar. 14, 2017
AC Conduction	CO01-CB	Ryo Fan	23°C / 61%	Dec. 28, 2016

Test site Designation No. TW0006 with FCC.

Test site registered number IC 4086D with Industry Canada.

1.4 Measurement Uncertainty

ISO/IEC 17025 requires that an estimate of the measurement uncertainties associated with the emissions test results be included in the report. The measurement uncertainties given below are based on a 95% confidence level (based on a coverage factor (k=2))

Test Items	Uncertainty	Remark
Conducted Emission (150kHz ~ 30MHz)	3.2 dB	Confidence levels of 95%
Radiated Emission (30MHz ~ 1,000MHz)	3.6 dB	Confidence levels of 95%
Radiated Emission (1GHz ~ 18GHz)	3.7 dB	Confidence levels of 95%
Radiated Emission (18GHz ~ 40GHz)	3.5 dB	Confidence levels of 95%
Conducted Emission	1.7 dB	Confidence levels of 95%
Output Power Measurement	1.33 dB	Confidence levels of 95%
Bandwidth Measurement	9.74×10^{-8}	Confidence levels of 95%

2 Test Configuration of EUT

2.1 Test Channel Mode

Mode	Power Setting
BT-BR(1Mbps)	-
2402MHz	63
2440MHz	63
2480MHz	63
BT-EDR(2Mbps)	-
2402MHz	63
2440MHz	63
2480MHz	63
BT-EDR(3Mbps)	-
2402MHz	63
2440MHz	63
2480MHz	63

2.2 The Worst Case Measurement Configuration

The Worst Case Mode for Following Conformance Tests	
Tests Item	AC power-line conducted emissions
Condition	AC power-line conducted measurement for line and neutral
Operating Mode	Normal Link

The Worst Case Mode for Following Conformance Tests	
Tests Item	20dB Bandwidth Carrier Frequency Separation Maximum Conducted Output Power Number of Hopping Frequencies Hopping Bandedge Time of Occupancy (Dwell Time) Emissions in Non-restricted Frequency Bands
Test Condition	Conducted measurement at transmit chains

The Worst Case Mode for Following Conformance Tests	
Tests Item	Emissions in Restricted Frequency Bands
Test Condition	Radiated measurement If EUT consist of multiple antenna assembly (multiple antenna are used in EUT regardless of spatial multiplexing MIMO configuration), the radiated test should be performed with highest antenna gain of each antenna type.
Operating Mode < 1GHz	Normal Link
Operating Mode > 1GHz	CTX

The Worst Case Mode for Following Conformance Tests	
Tests Item	Simultaneous Transmission Analysis - Co-location RF Exposure Evaluation
Operating Mode	
1	Bluetooth+WLAN 2.4GHz+WLAN 5GHz
Refer to Sporton Test Report No.: FA681620 for Co-location RF Exposure Evaluation.	

Note: 1. The EUT can only be used at Z axis position.

2.3 EUT Operation during Test

For CTX Mode:

The EUT was programmed to be in continuously transmitting mode.

For Normal Link:

During the test, the EUT operation to normal function.

2.4 Accessories

Accessories			
Equipment Name	Brand Name	Model Name	Rating
Adapter	Delta	ADP-360DW B2A	Input: 100-120V ~ 60Hz 0.9A Output: 12V, 3.0A
RJ-45 cable*1: Non-shielded 1.8m			

2.5 Support Equipment

For Test Site No: CO01-CB

Support Equipment				
No.	Equipment	Brand Name	Model Name	FCC ID
1	NB*4	DELL	E6430	DoC
2	iPhone 4	Apple	A1332	BCG-E2380a
3	Flash Disk3.0*2	ADATA	C103	DoC

For Test Site No: 03CH01-CB (below 1GHz)

Support Equipment				
No.	Equipment	Brand Name	Model Name	FCC ID
1	NB*2	DELL	E4300	DoC
2	NB*2	Apple	Mac Book	DoC
3	iPhone 4	Apple	A1332	BCG-E2380a
4	Flash Disk3.0*2	Silicon Power	B06	DoC

For Test Site No: 03CH01-CB (above 1GHz)

Support Equipment				
No.	Equipment	Brand Name	Model Name	FCC ID
1	NB	DELL	E4300	DoC

For Test Site No: TH01-CB

Support Equipment				
No.	Equipment	Brand Name	Model Name	FCC ID
1	NB	DELL	E4300	DoC

2.6 Test Setup Diagram

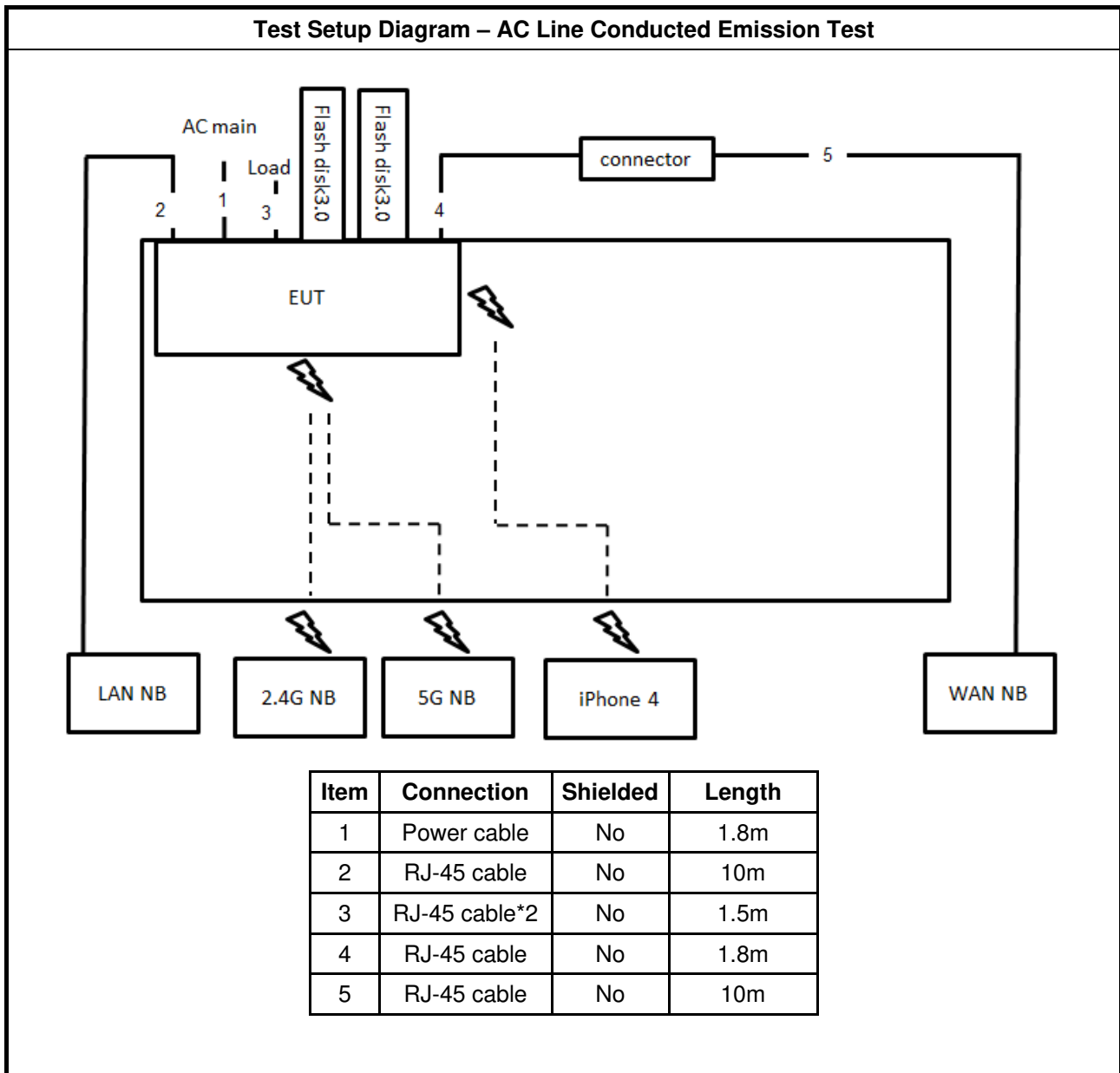

Test Setup Diagram - Radiated Test < 1GHz

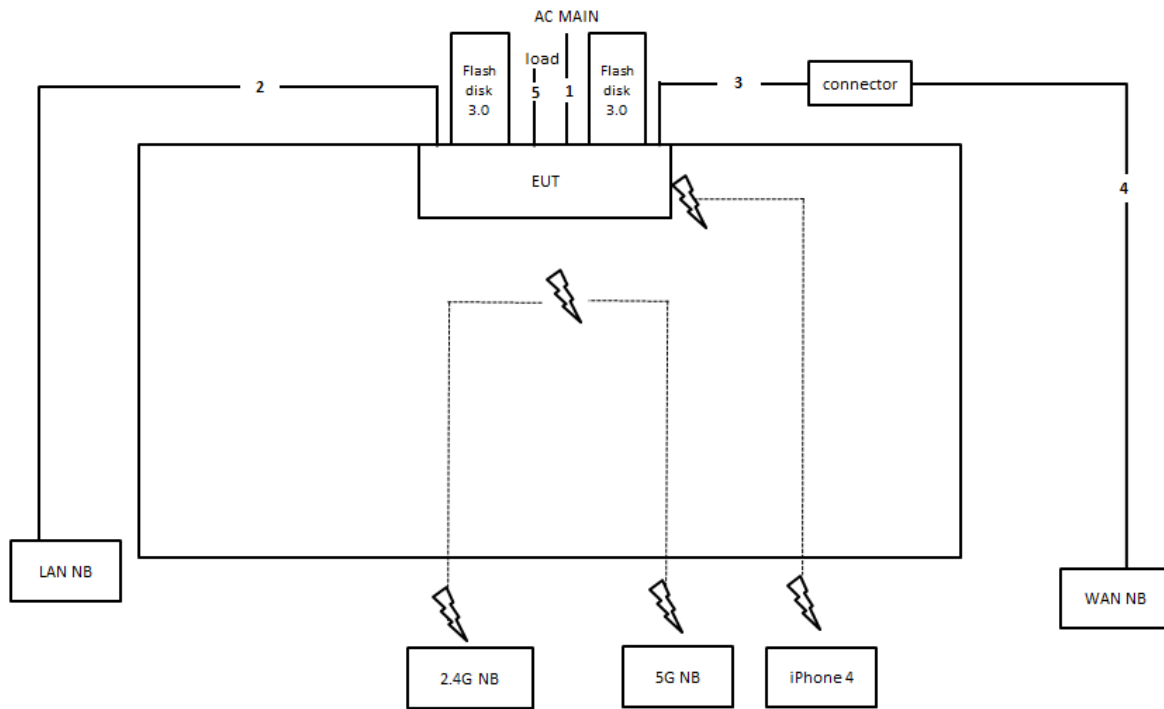

Item	Connection	Shielded	Length
1	Power cable	No	1.8m
2	RJ-45 cable	No	10m
3	RJ-45 cable	No	1.8m
4	RJ-45 cable	No	10m
5	RJ-45 cable*2	No	1m

Test Setup Diagram - Radiated Test > 1GHz

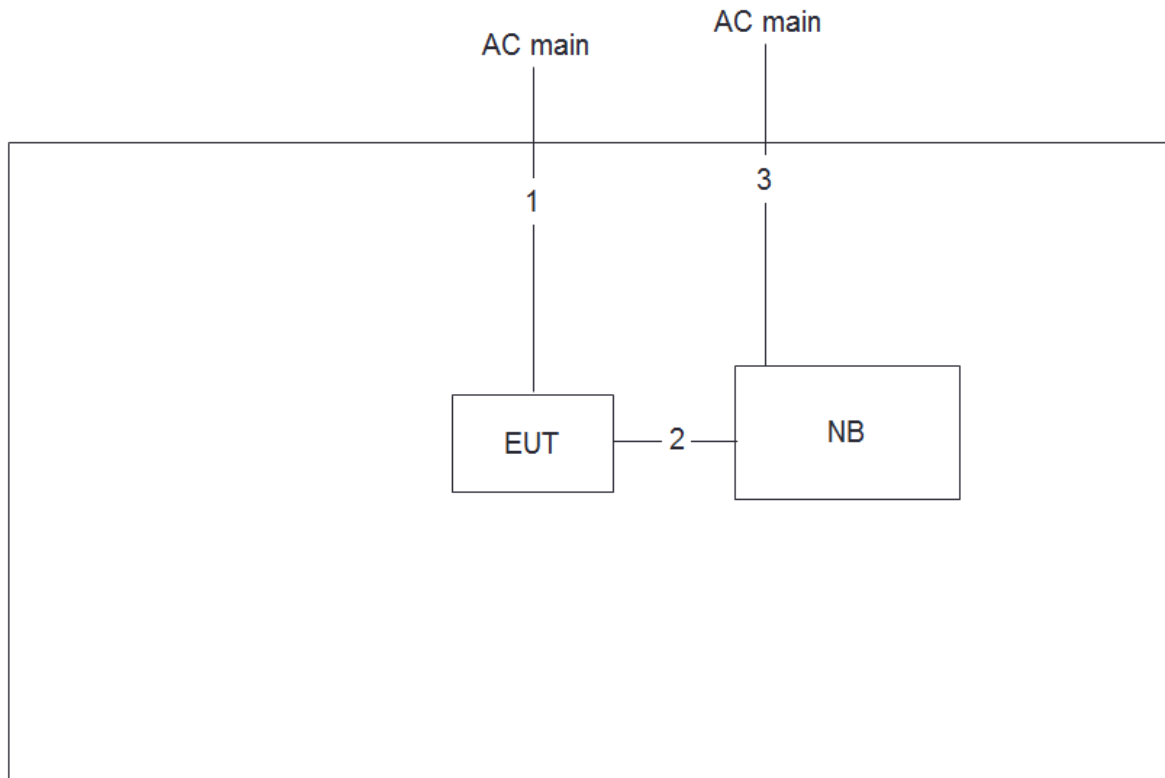

Item	Connection	Shielded	Length
1	Power cable	No	1.8m
2	Console Cable	No	1.97m
3	Power cable	No	2.6m

3 Transmitter Test Result

3.1 AC Power-line Conducted Emissions

3.1.1 AC Power-line Conducted Emissions Limit

AC Power-line Conducted Emissions Limit		
Frequency Emission (MHz)	Quasi-Peak	Average
0.15-0.5	66 - 56 *	56 - 46 *
0.5-5	56	46
5-30	60	50

Note 1: * Decreases with the logarithm of the frequency.

3.1.2 Measuring Instruments

Refer a test equipment and calibration data table in this test report.

3.1.3 Test Procedures

Test Method
<ul style="list-style-type: none"> Refer as ANSI C63.10-2013, clause 6.2 foray power-line conducted emissions.

3.1.4 Test Setup

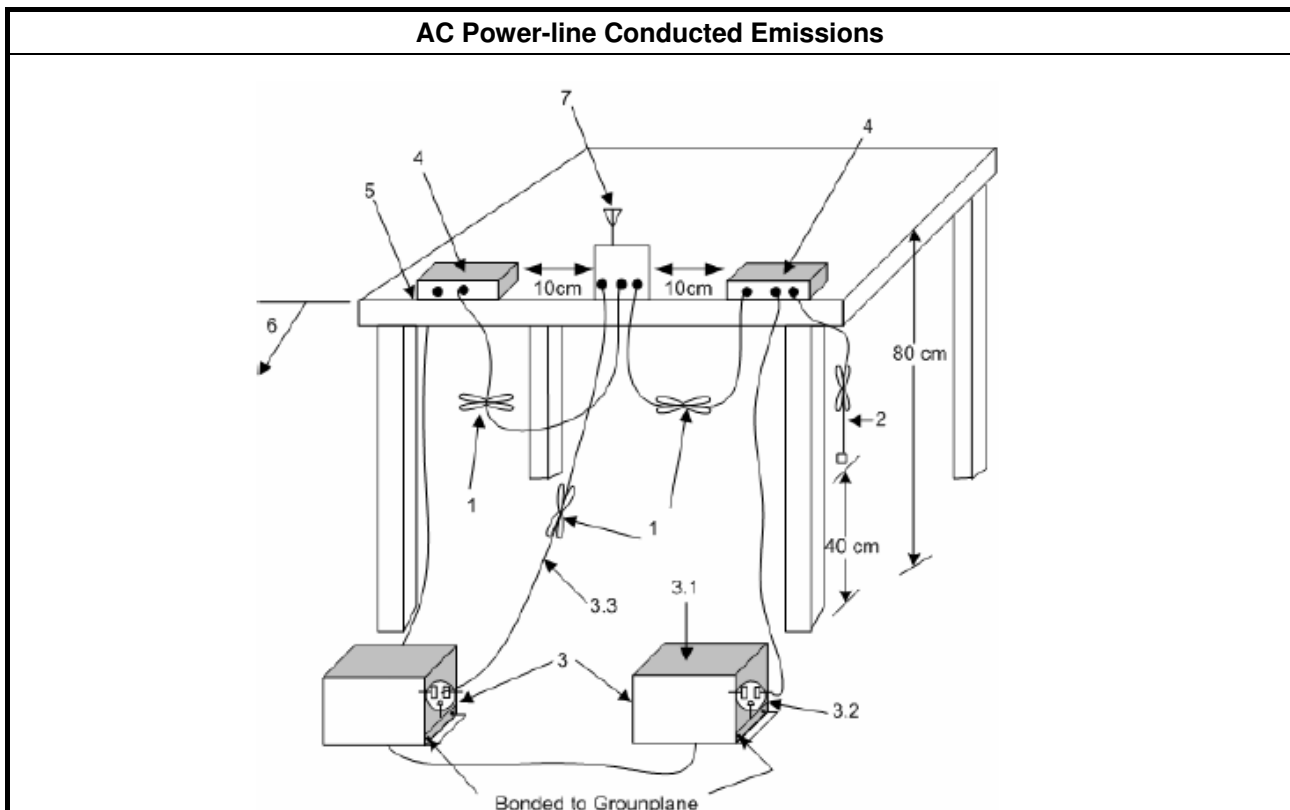



3.1.5 Test Result of AC Power-line Conducted Emissions

Refer as Appendix A

3.2 20dB Bandwidth and Carrier Frequency Separation

3.2.1 20dB Bandwidth and Carrier Frequency Separation Limit

20dB Bandwidth and Carrier Frequency Separation Limit for Frequency Hopping Systems	
<ul style="list-style-type: none"> 902-928 MHz Band: <ul style="list-style-type: none"> $N \geq 50$ and $ChS \geq \text{MAX}$ (20 dB bandwidth, 25 kHz); 20 dB bandwidth \leq 250 kHz. $50 > N \geq 25$ and $ChS \geq \text{MAX}$ (20 dB bandwidth, 25 kHz); 20 dB bandwidth $>$ 250 kHz. 	
<ul style="list-style-type: none"> 2400-2483.5 MHz Band: <ul style="list-style-type: none"> $N \geq 75$ and $ChS \geq \text{MAX}$ (20 dB bandwidth, 25 kHz). $75 > N \geq 15$ and $ChS \geq \text{MAX}$ (20 dB bandwidth 2/3, 25 kHz). 	
<ul style="list-style-type: none"> 5725-5850 MHz Band: <ul style="list-style-type: none"> $N \geq 75$ and $ChS \geq \text{MAX}$ (20 dB bandwidth, 25 kHz); 20 dB bandwidth \leq 1 MHz. 	
N: Number of Hopping Frequencies; ChS: Hopping Channel Separation	

3.2.2 Measuring Instruments

Refer a test equipment and calibration data table in this test report.

3.2.3 Test Procedures

Test Method
<ul style="list-style-type: none"> Refer as ANSI C63.10-2013, clause 6.9.1 for 20 dB bandwidth measurement.
<ul style="list-style-type: none"> Refer as ANSI C63.10-2013, clause 7.8.2 for carrier frequency separation measurement.

3.2.4 Test Setup

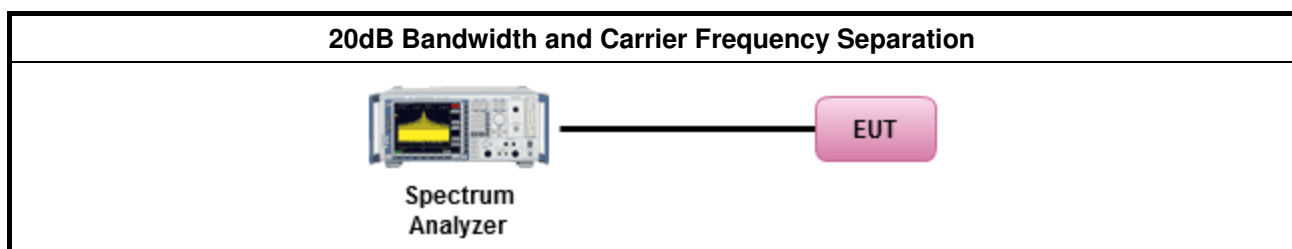

3.2.5 Test Result of 20dB Bandwidth

Refer as Appendix B

3.2.6 Test Result of Carrier Frequency Separation

Refer as Appendix B

3.3 Maximum Conducted Output Power

3.3.1 Maximum Conducted Output Power Limit

Maximum Conducted Output Power Limit	
<ul style="list-style-type: none"> ▪ 902-928 MHz Band: 	
	<ul style="list-style-type: none"> ▪ $N \geq 50$; Power 30dBm; EIRP 36dBm
	<ul style="list-style-type: none"> ▪ $50 > N \geq 25$; Power 24dBm; EIRP 30dBm
<ul style="list-style-type: none"> ▪ 2400-2483.5 MHz Band: 	
	<ul style="list-style-type: none"> ▪ $N \geq 75$; Power 30dBm; EIRP 36dBm
	<ul style="list-style-type: none"> ▪ $75 > N \geq 15$; Power 21dBm; EIRP 27dBm
<ul style="list-style-type: none"> ▪ 5725-5850 MHz Band: 	
	<ul style="list-style-type: none"> ▪ $N \geq 75$; Power 30dBm; EIRP 36dBm
<p>N:Number of Hopping Frequencies</p>	

3.3.2 Measuring Instruments

Refer a test equipment and calibration data table in this test report.

3.3.3 Test Procedures

Test Method
<ul style="list-style-type: none"> ▪ Refer as ANSI C63.10-2013, clause 7.8.5 for output power measurement.

3.3.4 Test Setup

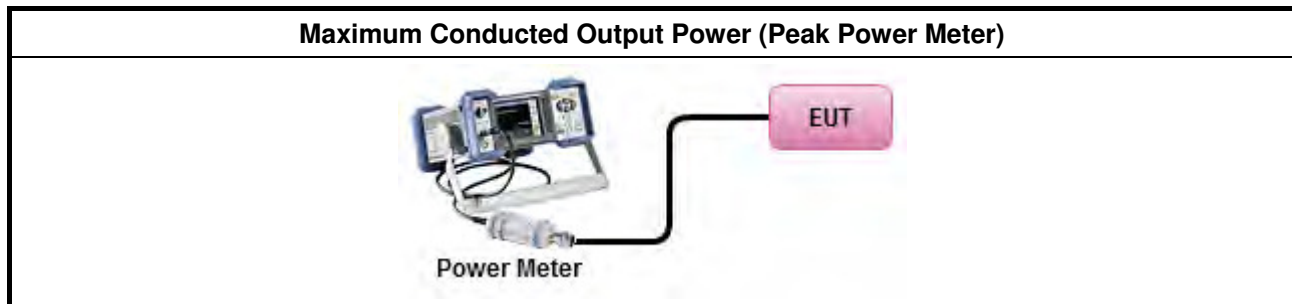

3.3.5 Test Result of Maximum Conducted Output Power

Refer as Appendix C

3.4 Number of Hopping Frequencies and Hopping Bandedge

3.4.1 Number of Hopping Frequencies Limit

Number of Hopping Frequencies Limit	
▪ 902-928 MHz Band:	
	▪ $N \geq 50$ and $ChS \geq MAX$ (20 dB bandwidth, 25 kHz); 20 dB bandwidth \leq 250 kHz.
	▪ $50 > N \geq 25$ and $ChS \geq MAX$ (20 dB bandwidth, 25 kHz); 20 dB bandwidth $>$ 250 kHz.
▪ 2400-2483.5 MHz Band:	
	▪ $N \geq 75$ and $ChS \geq MAX$ (20 dB bandwidth, 25 kHz).
	▪ $75 > N \geq 15$ and $ChS \geq MAX$ (20 dB bandwidth 2/3, 25 kHz).
▪ 5725-5850 MHz Band:	
	▪ $N \geq 75$ and $ChS \geq MAX$ (20 dB bandwidth, 25 kHz); 20 dB bandwidth \leq 1 MHz.
N: Number of Hopping Frequencies; ChS : Hopping Channel Separation	

3.4.2 Hopping Bandedge Limit

Refer clause 3.6.1 and clause 3.7.1

3.4.3 Measuring Instruments

Refer a test equipment and calibration data table in this test report.

3.4.4 Test Procedures

Test Method
▪ Refer as ANSI C63.10-2013, clause 7.8.3 for number of hopping frequencies measurement.
▪ Refer as ANSI C63.10-2013, clause 7.8.6 for hopping frequencies Bandedge measurement.

3.4.5 Test Setup

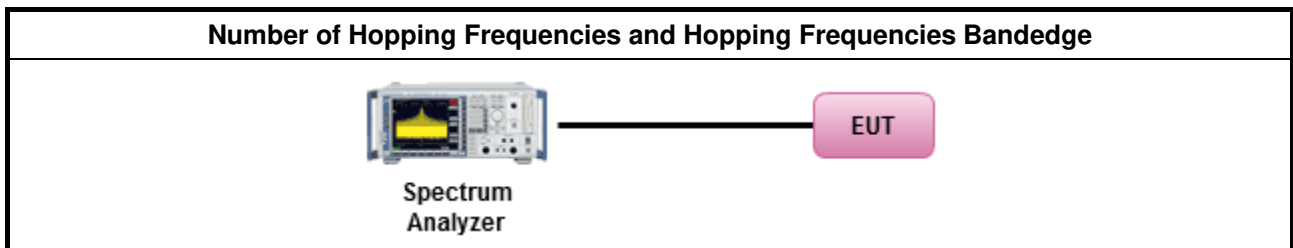

3.4.6 Test Result of Number of Hopping Frequencies

Refer as Appendix D

3.4.7 Test Result of Number of Hopping Frequencies Bandedge

Refer as Appendix D

3.5 Time of Occupancy (Dwell Time)

3.5.1 Time of Occupancy (Dwell Time) Limit

20dB Bandwidth and Carrier Frequency Separation Limit for Frequency Hopping Systems	
<ul style="list-style-type: none"> 902-928 MHz Band: 	
	<ul style="list-style-type: none"> N ≥ 50; 0.4s in 20s period
	<ul style="list-style-type: none"> 50 > N ≥ 25; 0.4s in 10s period
<ul style="list-style-type: none"> 2400-2483.5 MHz Band: 	
	<ul style="list-style-type: none"> N ≥ 75; 0.4s in N x 0.4 period
	<ul style="list-style-type: none"> 75 > N ≥ 15; 0.4s in N x 0.4 period
<ul style="list-style-type: none"> 5725-5850 MHz Band: 	
	<ul style="list-style-type: none"> N ≥ 75; 0.4s in 30s period
N: Number of Hopping Frequencies	

3.5.2 Measuring Instruments

Refer a test equipment and calibration data table in this test report.

3.5.3 Test Procedures

Test Method	
<ul style="list-style-type: none"> Refer as ANSI C63.10-2013, clause 7.8.4 for dwell time measurement. 	
<ul style="list-style-type: none"> Bluetooth ACL packets can be 1, 3, or 5 time slots. Following as dwell time. Operate DH5 at maximum dwell time and maximum duty cycle. 	
	<ul style="list-style-type: none"> The DH5 packet can cover up to 5 time slots. Operate DH5 at maximum dwell time and maximum duty cycle. A maximum length packet has duration of 5 time slots. The hopping rate is 1600 hops/second so the maximum dwell time is 5/1600 seconds, or 3.125ms. DH5 Packet permit maximum 1600/ 79 / 6 = 3.37 hops per second in each channel.

3.5.4 Test Setup

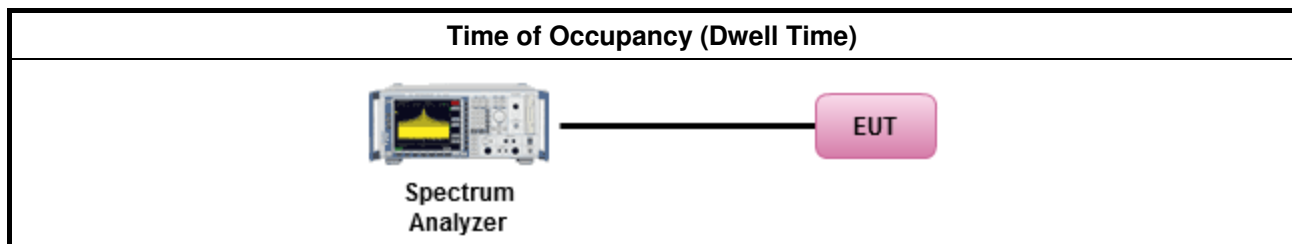

3.5.5 Test Result of Time of Occupancy (Dwell Time)

Refer as Appendix E

3.6 Emissions in Non-restricted Frequency Bands

3.6.1 Emissions in Non-restricted Frequency Bands Limit

Un-restricted Band Emissions Limit	
RF output power procedure	Limit (dB)
Peak output power procedure	20
Note 1: If the peak output power procedure is used to measure the fundamental emission power to demonstrate compliance to requirements, then the peak conducted output power measured within any 100 kHz outside the authorized frequency band shall be attenuated by at least 20 dB relative to the maximum measured in-band peak PSD level.	

3.6.2 Measuring Instruments

Refer a test equipment and calibration data table in this test report.

3.6.3 Test Procedures

Test Method
<ul style="list-style-type: none"> Refer as ANSI C63.10-2013, clause 7.8.8 for unwanted emissions into non-restricted bands.

3.6.4 Test Setup

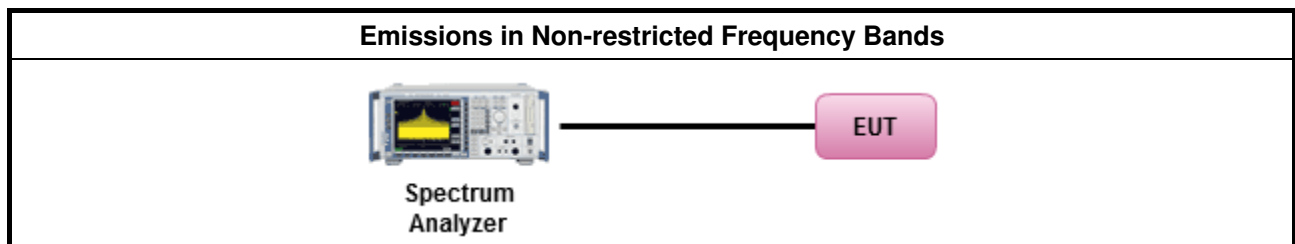

3.6.5 Test Result of Emissions in Non-restricted Frequency Bands

Refer as Appendix F

3.7 Emissions in Restricted Frequency Bands

3.7.1 Emissions in Restricted Frequency Bands Limit

Restricted Band Emissions Limit			
Frequency Range (MHz)	Field Strength (uV/m)	Field Strength (dBuV/m)	Measure Distance (m)
0.009~0.490	2400/F(kHz)	48.5 - 13.8	300
0.490~1.705	24000/F(kHz)	33.8 - 23	30
1.705~30.0	30	29	30
30~88	100	40	3
88~216	150	43.5	3
216~960	200	46	3
Above 960	500	54	3

Note 1: Test distance for frequencies at or above 30 MHz, measurements may be performed at a distance other than the limit distance provided they are not performed in the near field and the emissions to be measured can be detected by the measurement equipment. When performing measurements at a distance other than that specified, the results shall be extrapolated to the specified distance using an extrapolation factor of 20 dB/decade (inverse of linear distance for field-strength measurements, inverse of linear distance-squared for power-density measurements).

Note 2: Test distance for frequencies at below 30 MHz, measurements may be performed at a distance closer than the EUT limit distance; however, an attempt should be made to avoid making measurements in the near field. When performing measurements below 30 MHz at a closer distance than the limit distance, the results shall be extrapolated to the specified distance by either making measurements at a minimum of two or more distances on at least one radial to determine the proper extrapolation factor or by using the square of an inverse linear distance extrapolation factor (40 dB / decade). The test report shall specify the extrapolation method used to determine compliance of the EUT.

3.7.2 Measuring Instruments

Refer a test equipment and calibration data table in this test report.

3.7.3 Test Procedures

Test Method							
	<ul style="list-style-type: none"> ▪ The average emission levels shall be measured in [hopping duty factor]. 						
	<ul style="list-style-type: none"> ▪ Refer as ANSI C63.10; clause 6.9.2.2 band-edge testing shall be performed at the lowest frequency channel and highest frequency channel within the allowed operating band. 						
	<ul style="list-style-type: none"> ▪ For the transmitter unwanted emissions shall be measured using following options below: <table border="1" style="width: 100%; margin-top: 5px;"> <tbody> <tr> <td style="width: 5%;"></td> <td> <ul style="list-style-type: none"> ▪ Refer as ANSI C63.10, clause 4.1.4.2.1 QP value. </td> </tr> <tr> <td style="width: 5%;"></td> <td> <ul style="list-style-type: none"> ▪ Refer as ANSI C63.10, clause 4.1.4.2.2 measurement procedure peak. </td> </tr> <tr> <td style="width: 5%;"></td> <td> <ul style="list-style-type: none"> ▪ Refer as ANSI C63.10, clause 4.1.4.2.4 average value of hopping pulsed emissions. </td> </tr> </tbody> </table> 		<ul style="list-style-type: none"> ▪ Refer as ANSI C63.10, clause 4.1.4.2.1 QP value. 		<ul style="list-style-type: none"> ▪ Refer as ANSI C63.10, clause 4.1.4.2.2 measurement procedure peak. 		<ul style="list-style-type: none"> ▪ Refer as ANSI C63.10, clause 4.1.4.2.4 average value of hopping pulsed emissions.
	<ul style="list-style-type: none"> ▪ Refer as ANSI C63.10, clause 4.1.4.2.1 QP value. 						
	<ul style="list-style-type: none"> ▪ Refer as ANSI C63.10, clause 4.1.4.2.2 measurement procedure peak. 						
	<ul style="list-style-type: none"> ▪ Refer as ANSI C63.10, clause 4.1.4.2.4 average value of hopping pulsed emissions. 						

3.7.4 Test Setup

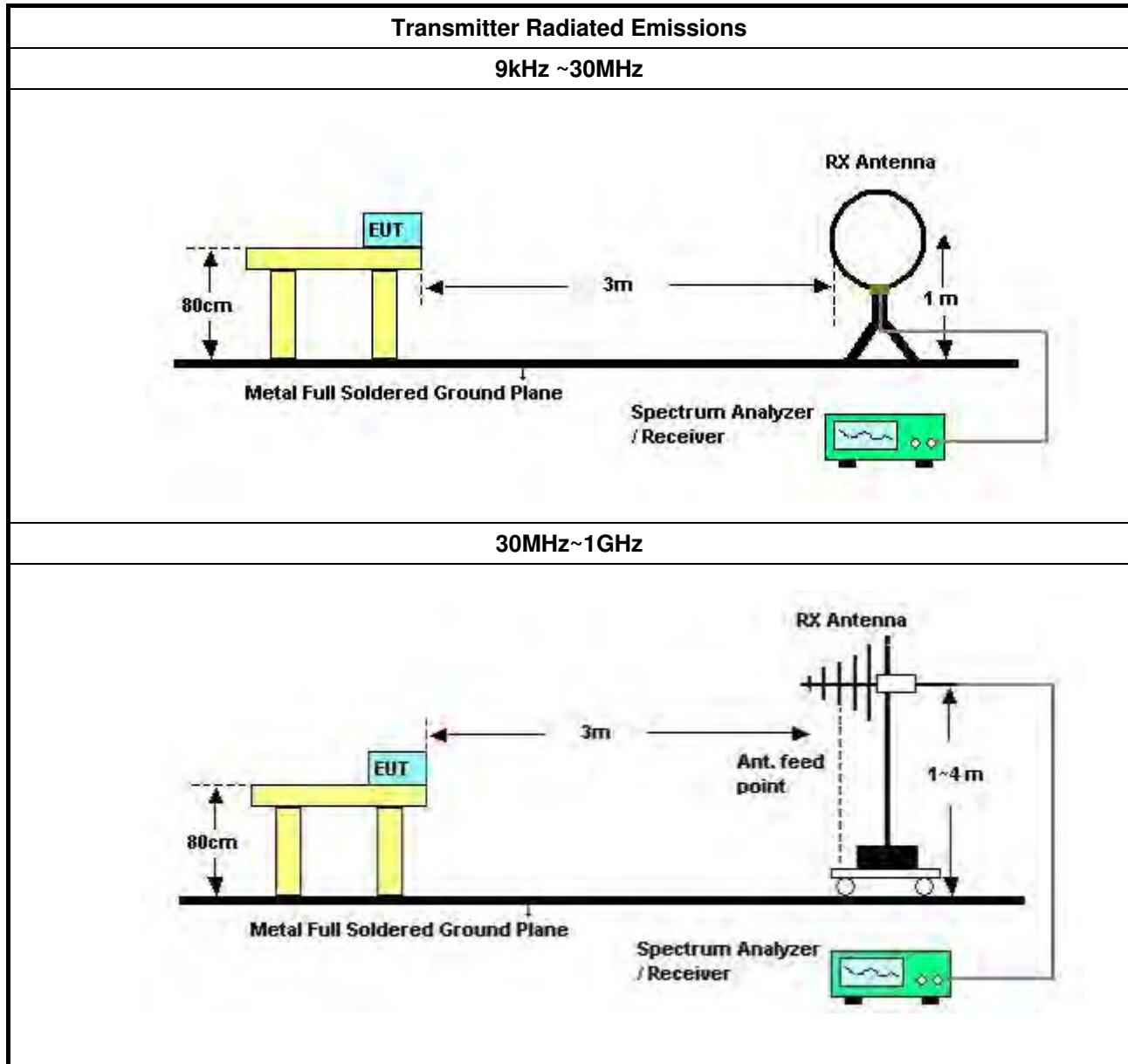

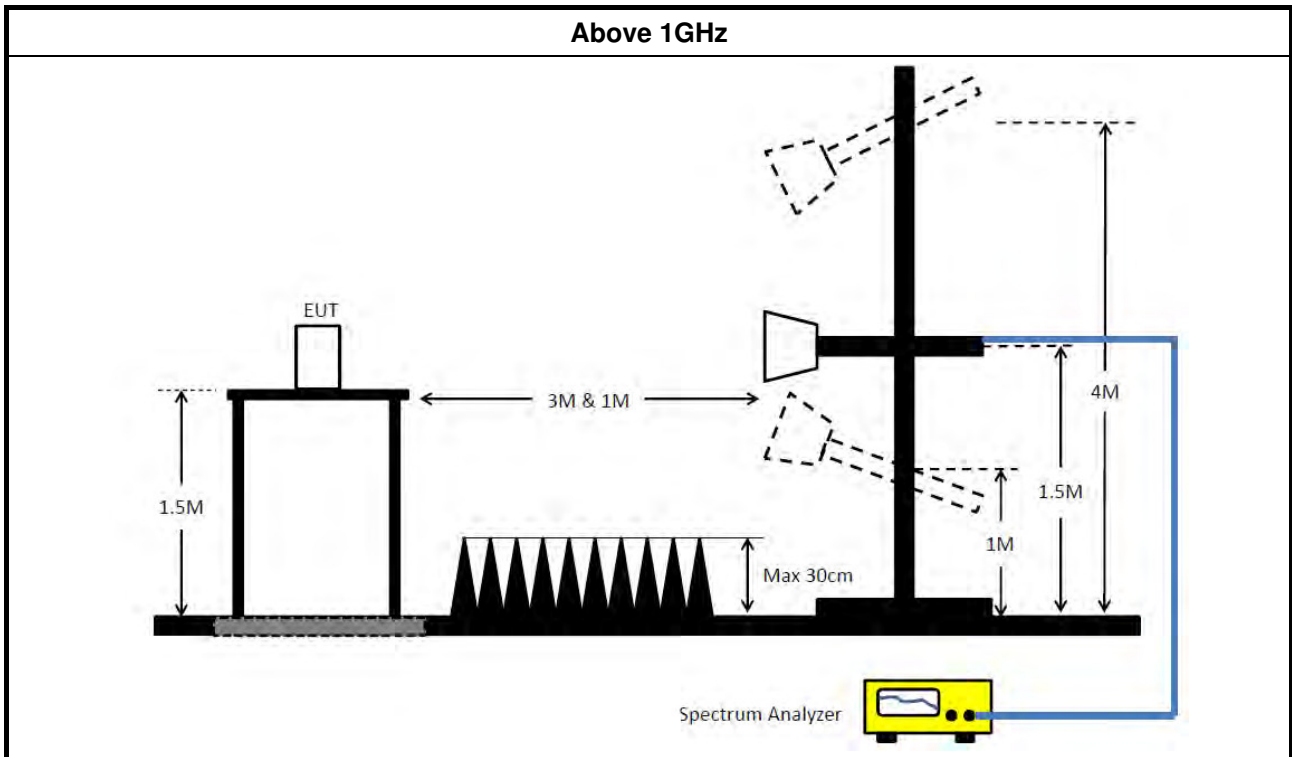

3.7.5 Transmitter Radiated Unwanted Emissions (Below 30MHz)

All amplitude of spurious emissions that are attenuated by more than 20 dB below the permissible value has no need to be reported.

3.7.6 Transmitter Radiated Unwanted Emissions

Refer as Appendix G

4 Test Equipment and Calibration Data

Instrument	Manufacturer	Model No.	Serial No.	Characteristics	Calibration Date	Remark
EMI Receiver	Agilent	N9038A	My52260123	9kHz ~ 8.45GHz	Jan. 27, 2016	Conduction (CO01-CB)
LISN	F.C.C.	FCC-LISN-50-16-2	04083	150kHz ~ 100MHz	Dec. 14, 2016	Conduction (CO01-CB)
LISN	Schwarzbeck	NSLK 8127	8127647	9kHz ~ 30MHz	Dec. 21, 2016	Conduction (CO01-CB)
COND Cable	Woken	Cable	01	150kHz ~ 30MHz	May 24, 2016	Conduction (CO01-CB)
Software	Audix	E3	6.120210n	-	N.C.R.	Conduction (CO01-CB)
BILOG ANTENNA with 6dB Attenuator	TESEQ & EMCI	CBL6112D & N-6-06	37880 & AT-N0609	20MHz ~ 2GHz	Aug. 30, 2016	Radiation (03CH01-CB)
Horn Antenna	EMCO	3115	00075790	750MHz ~ 18GHz	Nov. 10, 2016	Radiation (03CH01-CB)
Horn Antenna	Schwarzbeck	BBHA 9170	BBHA9170252	15GHz ~ 40GHz	Jul. 25, 2016	Radiation (03CH01-CB)
Pre-Amplifier	Agilent	8447D	2944A10991	0.1MHz ~ 1.3GHz	Mar. 15, 2016	Radiation (03CH01-CB)
Pre-Amplifier	Agilent	8449B	3008A02310	1GHz ~ 26.5GHz	Jan. 18, 2016	Radiation (03CH01-CB)
Pre-Amplifier	Agilent	8449B	3008A02310	1GHz ~ 26.5GHz	Jan. 16, 2017	Radiation (03CH01-CB)
Pre-Amplifier	MITEQ	TTA1840-35-HG	1864479	18GHz ~ 40GHz	Jun. 28, 2016	Radiation (03CH01-CB)
Spectrum Analyzer	R&S	FSP40	100056	9kHz ~ 40GHz	Nov. 21, 2016	Radiation (03CH01-CB)
EMI Test	R&S	ESCS	100355	9kHz ~ 2.75GHz	May 16, 2016	Radiation (03CH01-CB)
RF Cable-low	Woken	Low Cable-16+17	N/A	30 MHz ~ 1 GHz	Oct. 24, 2016	Radiation (03CH01-CB)
RF Cable-high	Woken	High Cable-16	N/A	1 GHz ~ 18 GHz	Oct. 24, 2016	Radiation (03CH01-CB)
RF Cable-high	Woken	High Cable-16+17	N/A	1 GHz ~ 18 GHz	Oct. 24, 2016	Radiation (03CH01-CB)
RF Cable-high	Woken	High Cable-40G#1	N/A	18GHz ~ 40 GHz	Oct. 24, 2016	Radiation (03CH01-CB)
RF Cable-high	Woken	High Cable-40G#2	N/A	18GHz ~ 40 GHz	Oct. 24, 2016	Radiation (03CH01-CB)
Test Software	Audix	E3	6.2009-10-7	N/A	N/A	Radiation (03CH01-CB)
Loop Antenna	Teseq	HLA 6120	24155	9kHz - 30 MHz	Mar. 16, 2016*	Radiation (03CH01-CB)
Spectrum analyzer	R&S	FSV40	100979	9kHz-40GHz	Dec. 26, 2016	Conducted (TH01-CB)



Instrument	Manufacturer	Model No.	Serial No.	Characteristics	Calibration Date	Remark
RF Cable-high	Woken	RG402	High Cable-6	1 GHz – 26.5 GHz	Oct. 24, 2016	Conducted (TH01-CB)
RF Cable-high	Woken	RG402	High Cable-7	1 GHz –26.5 GHz	Oct. 24, 2016	Conducted (TH01-CB)
RF Cable-high	Woken	RG402	High Cable-8	1 GHz –26.5 GHz	Oct. 24, 2016	Conducted (TH01-CB)
RF Cable-high	Woken	RG402	High Cable-9	1 GHz –26.5 GHz	Oct. 24, 2016	Conducted (TH01-CB)
RF Cable-high	Woken	RG402	High Cable-10	1 GHz –26.5 GHz	Oct. 24, 2016	Conducted (TH01-CB)
Power Sensor	Agilent	U2021XA	MY53410001	50MHz~18GHz	Nov. 22, 2016	Conducted (TH01-CB)
Power Sensor	Agilent	U2021XA	MY53410002	50MHz~18GHz	Nov. 22, 2016	Conducted (TH01-CB)
Power Sensor	Agilent	U2021XA	MY54320014	50MHz~18GHz	Apr. 20, 2016	Conducted (TH01-CB)
Power Sensor	Agilent	U2021XA	MY54320015	50MHz~18GHz	Apr. 20, 2016	Conducted (TH01-CB)

Note: Calibration Interval of instruments listed above is one year.

“**” Calibration Interval of instruments listed above is two years.

N.C.R means Non-Calibration required.



AC Power-line Conducted Emissions Result

Appendix A

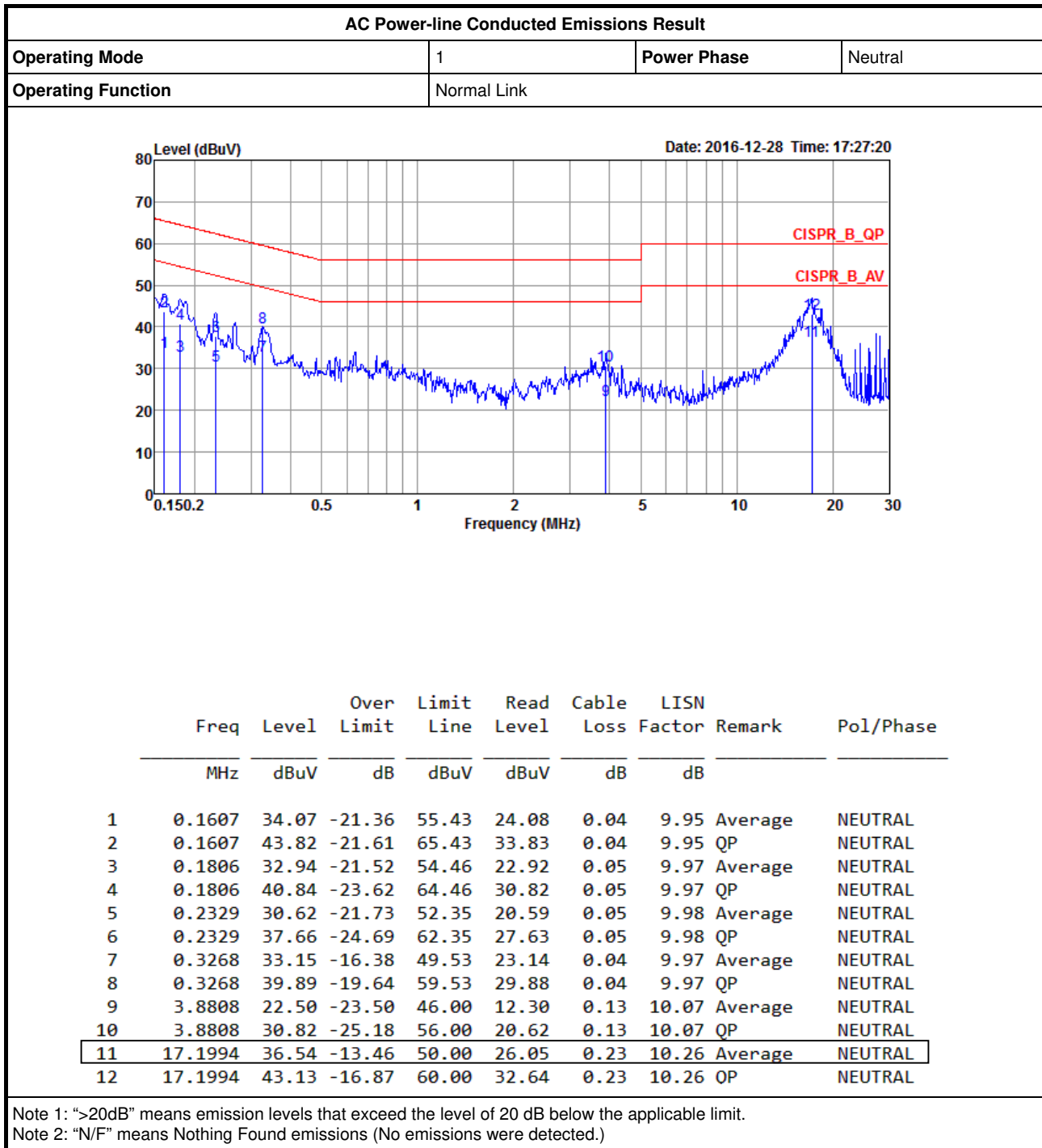



AC Power-line Conducted Emissions Result

Appendix A

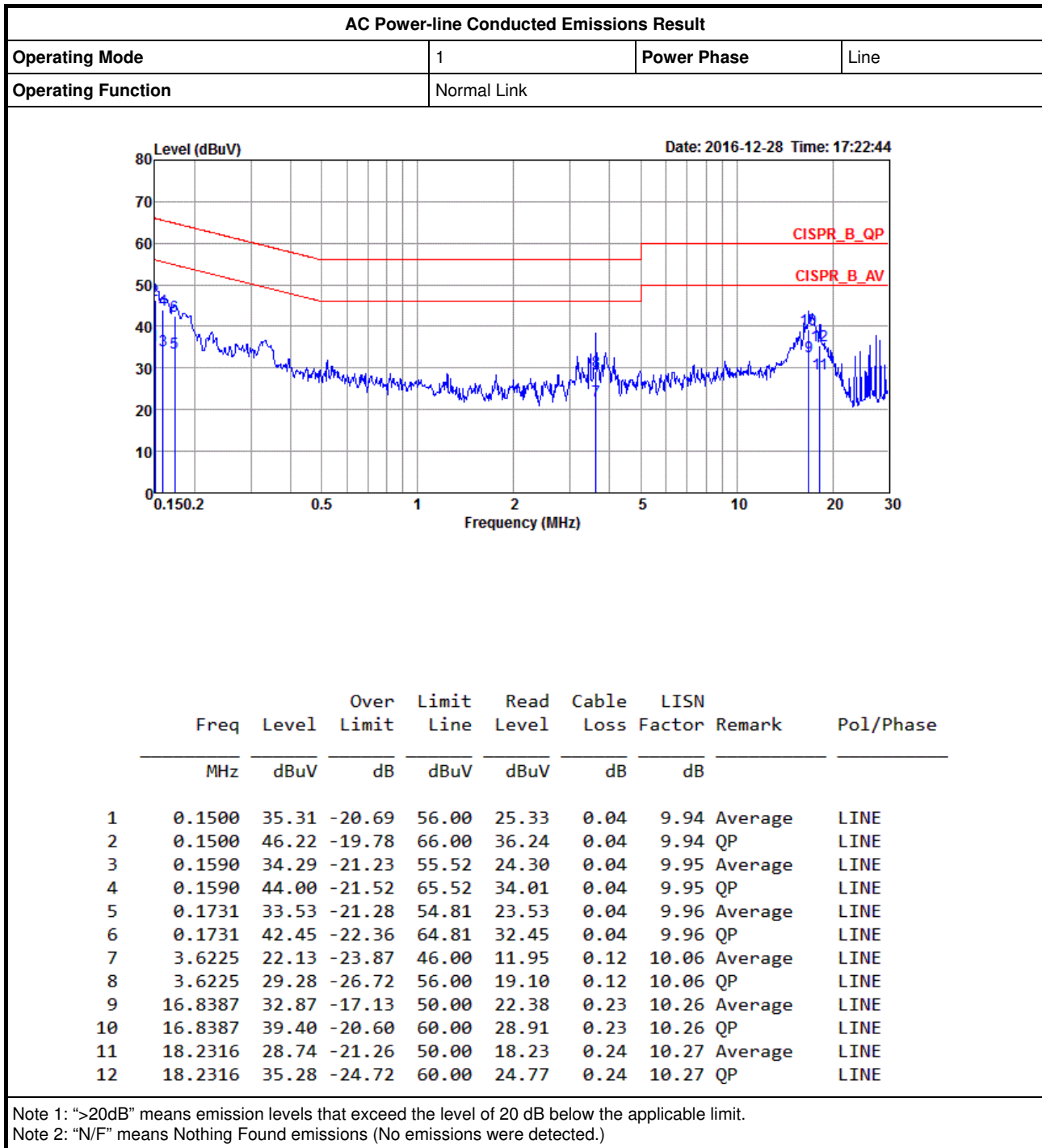



Summary

Mode	Max-N dB (Hz)	Max-OBW (Hz)	ITU-Code	Min-N dB (Hz)	Min-OBW (Hz)
BT-BR(1Mbps)	-	-	-	-	-
2.4-2.4835GHz	920k	877.061k	877kF1D	915k	870.815k
BT-EDR(2Mbps)	-	-	-	-	-
2.4-2.4835GHz	1.315M	1.206M	1M21G1D	1.313M	1.193M
BT-EDR(3Mbps)	-	-	-	-	-
2.4-2.4835GHz	1.264M	1.216M	1M22G1D	1.26M	1.198M

Max-N dB = Maximum 20dB down bandwidth; **Max-OBW** = Maximum 99% occupied bandwidth;
Min-N dB = Minimum 20dB down bandwidth; **Min-OBW** = Minimum 99% occupied bandwidth;

Result

Mode	Result	Limit (Hz)	Port 1-N dB (Hz)	Port 1-OBW (Hz)
BT-BR(1Mbps)	-	-	-	-
2402MHz	Pass	Inf	920k	875.812k
2440MHz	Pass	Inf	916.25k	870.815k
2480MHz	Pass	Inf	915k	877.061k
BT-EDR(2Mbps)	-	-	-	-
2402MHz	Pass	Inf	1.315M	1.193M
2440MHz	Pass	Inf	1.313M	1.197M
2480MHz	Pass	Inf	1.315M	1.206M
BT-EDR(3Mbps)	-	-	-	-
2402MHz	Pass	Inf	1.26M	1.198M
2440MHz	Pass	Inf	1.264M	1.201M
2480MHz	Pass	Inf	1.264M	1.216M

Port X-N dB = Port X 20dB down bandwidth; **Port X-OBW** = Port X 99% occupied bandwidth;

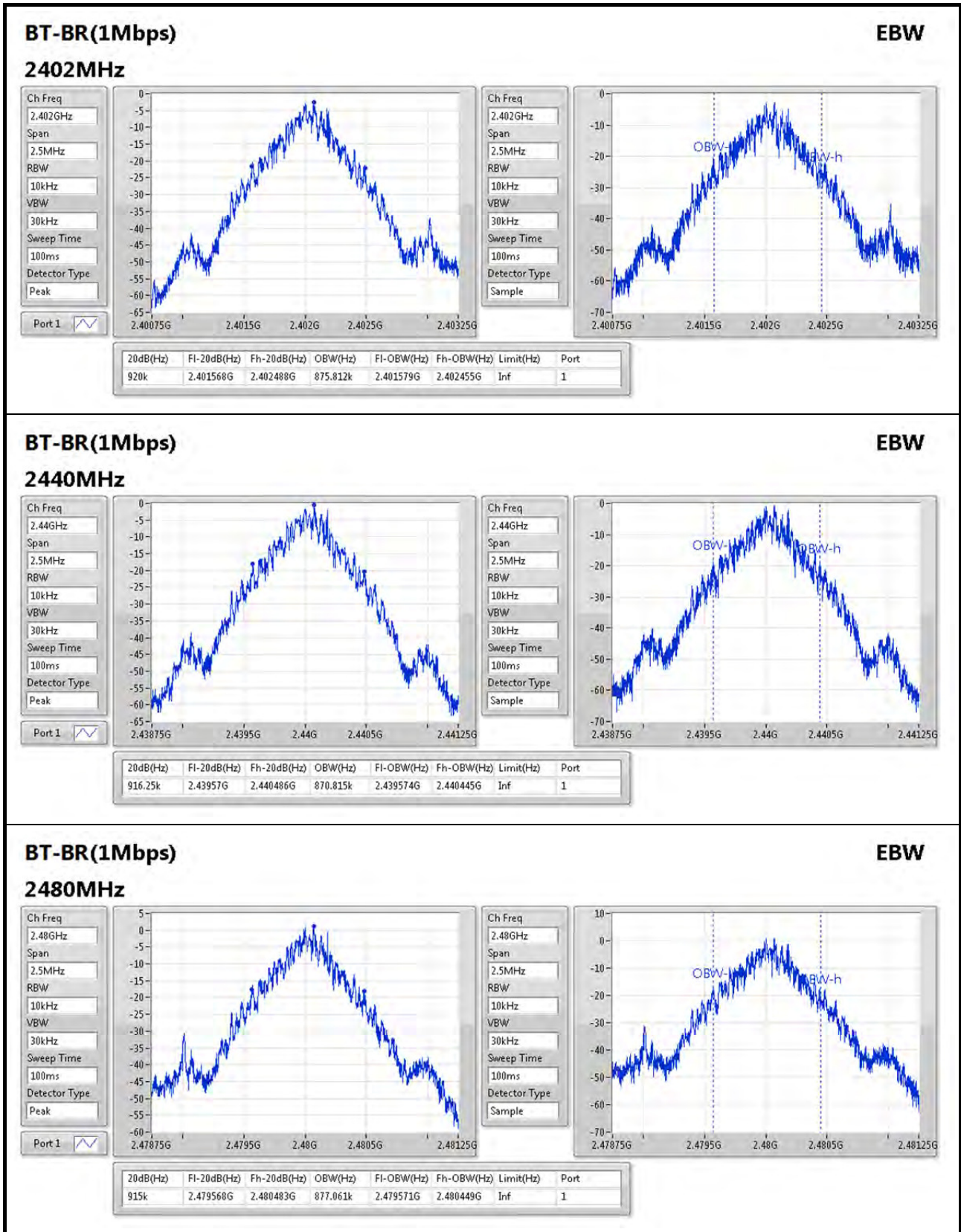

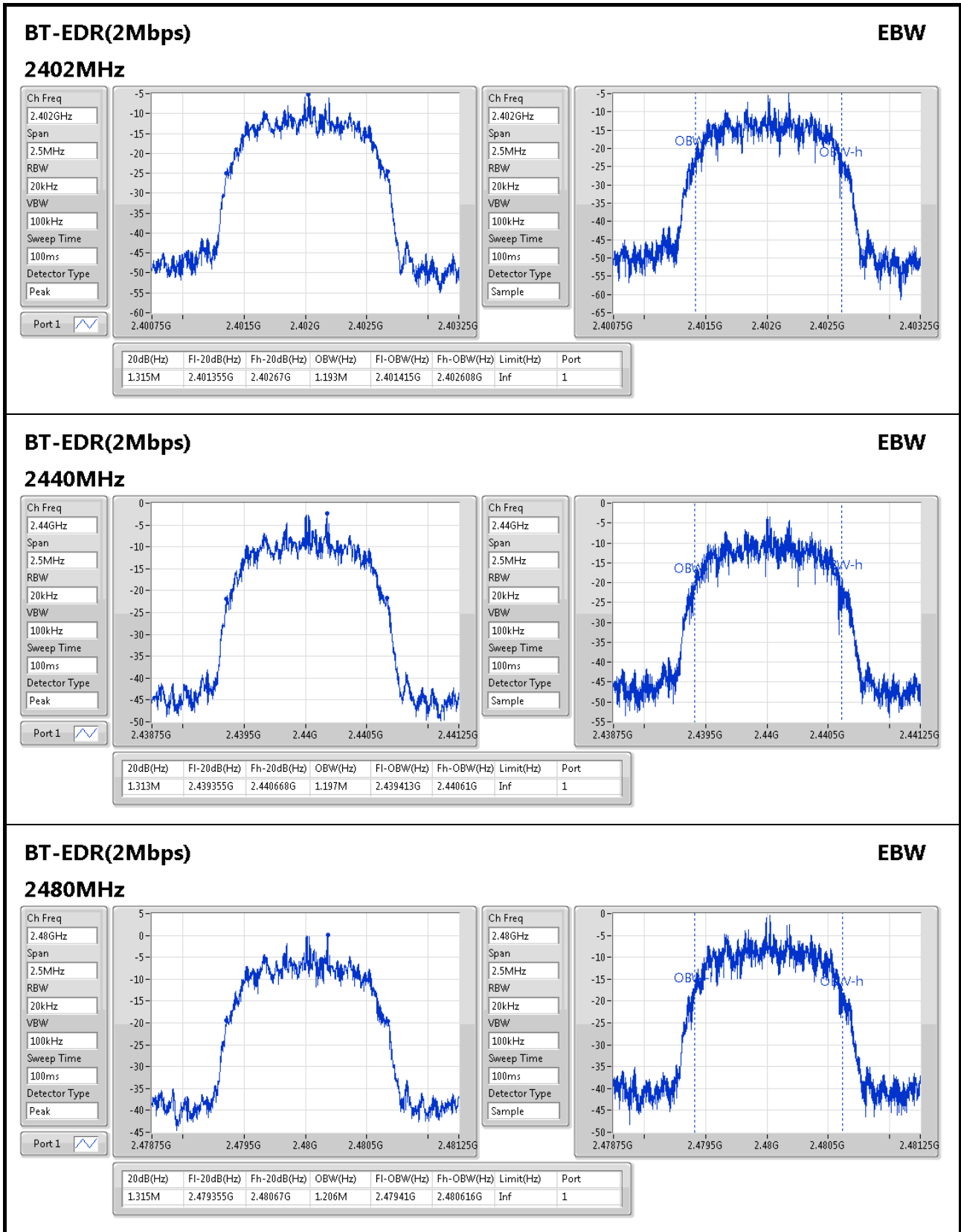

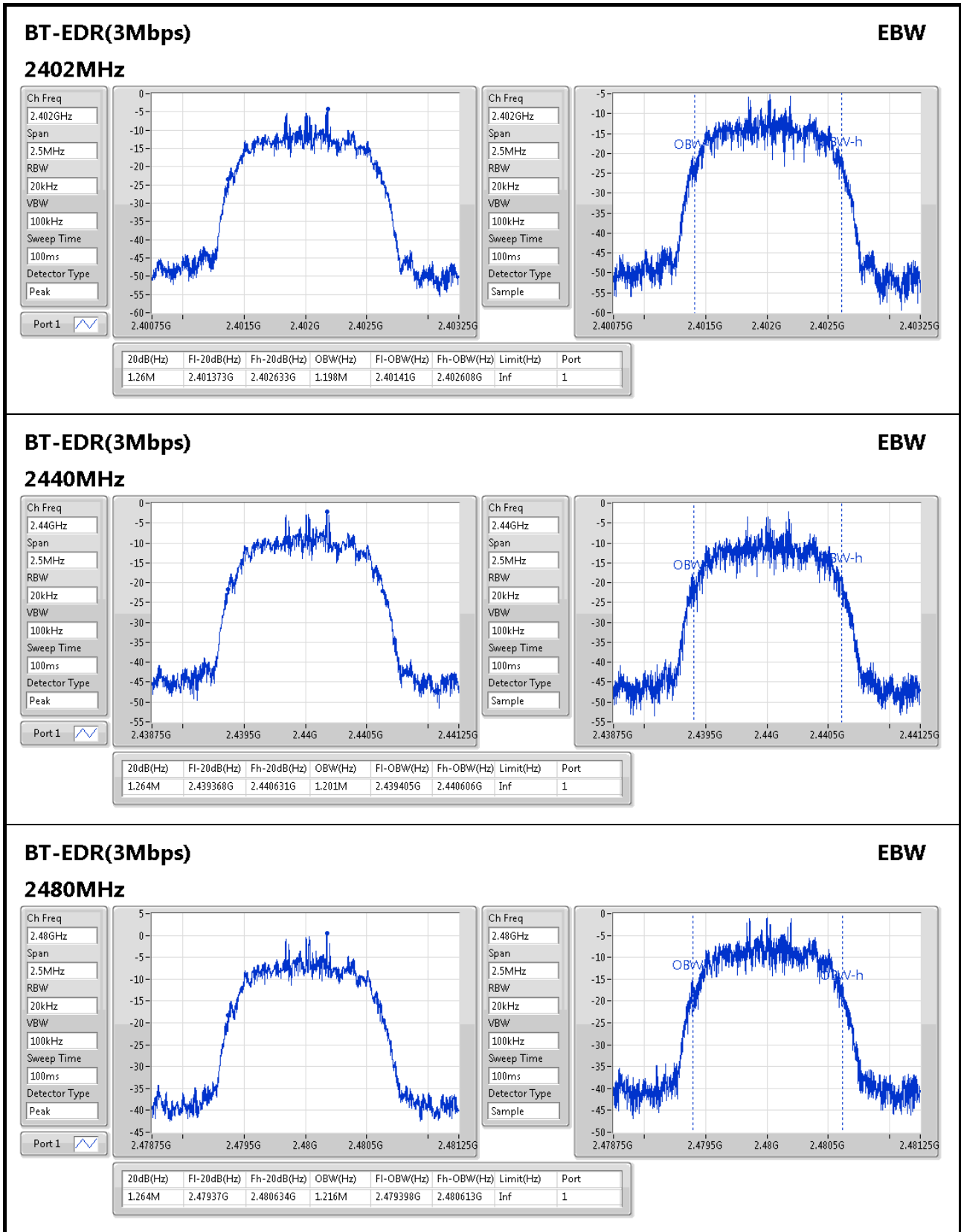



Summary

Mode	Max-Space (Hz)	Min-Space (Hz)
BT-BR(1Mbps)	-	-
2.4-2.4835GHz	1.0005M	669k
BT-EDR(2Mbps)	-	-
2.4-2.4835GHz	1.002M	997.5k
BT-EDR(3Mbps)	-	-
2.4-2.4835GHz	1.0005M	999k

Result

Mode	Result	Fl (Hz)	Fh (Hz)	Ch.Space (Hz)	Limit (Hz)
BT-BR(1Mbps)	-	-	-	-	-
2402MHz	Pass	2.402182G	2.403183G	1.0005M	612.72k
2440MHz	Pass	2.440182G	2.440851G	669k	610.2225k
2480MHz	Pass	2.479181G	2.480181G	1.0005M	666k
BT-EDR(2Mbps)	-	-	-	-	-
2402MHz	Pass	2.40202G	2.403019G	999k	875.79k
2440MHz	Pass	2.44002G	2.441018G	997.5k	874.458k
2480MHz	Pass	2.479019G	2.480021G	1.002M	666k
BT-EDR(3Mbps)	-	-	-	-	-
2402MHz	Pass	2.402179G	2.40318G	1.0005M	839.16k
2440MHz	Pass	2.440178G	2.441178G	1.0005M	666k
2480MHz	Pass	2.479179G	2.480178G	999k	666k

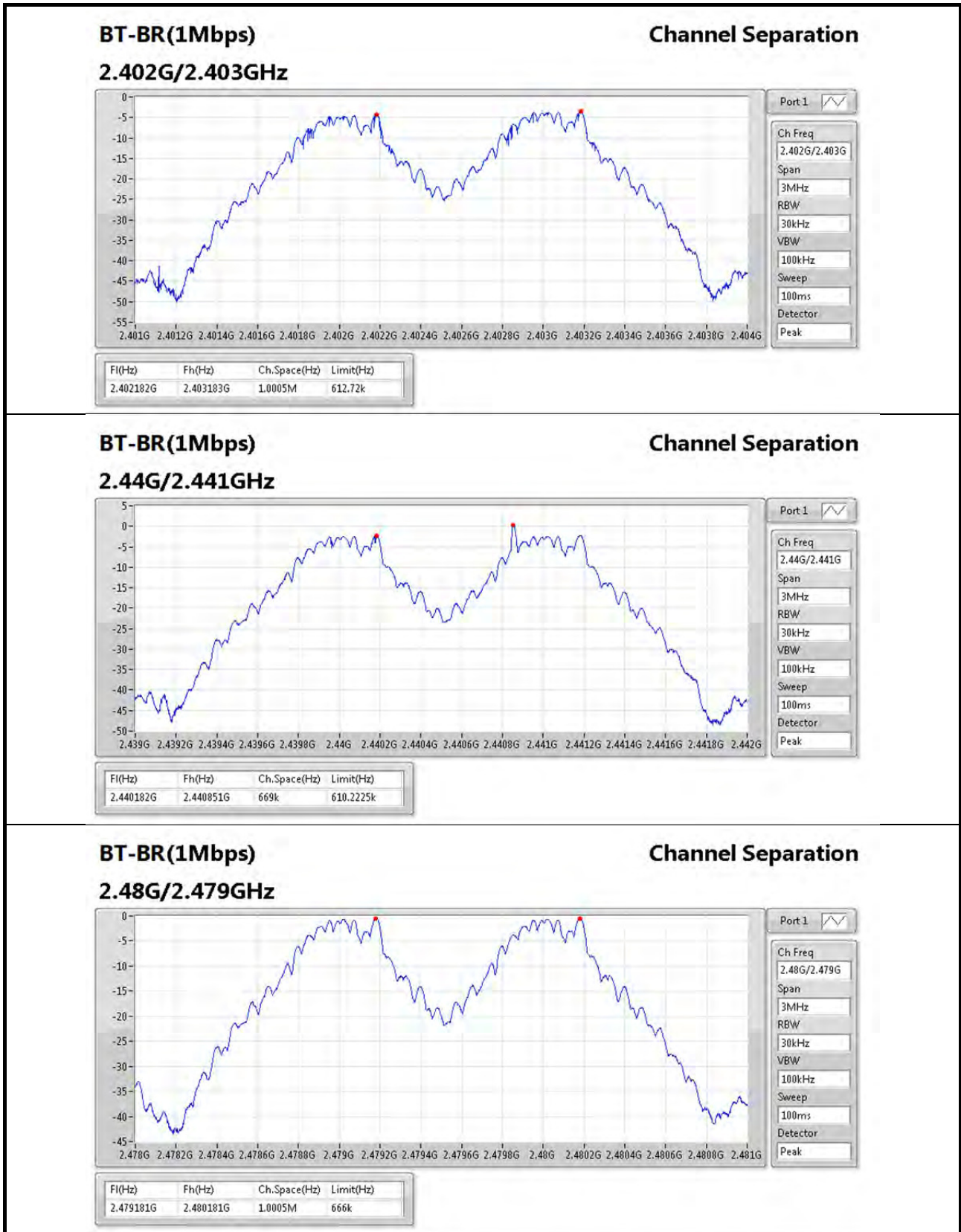

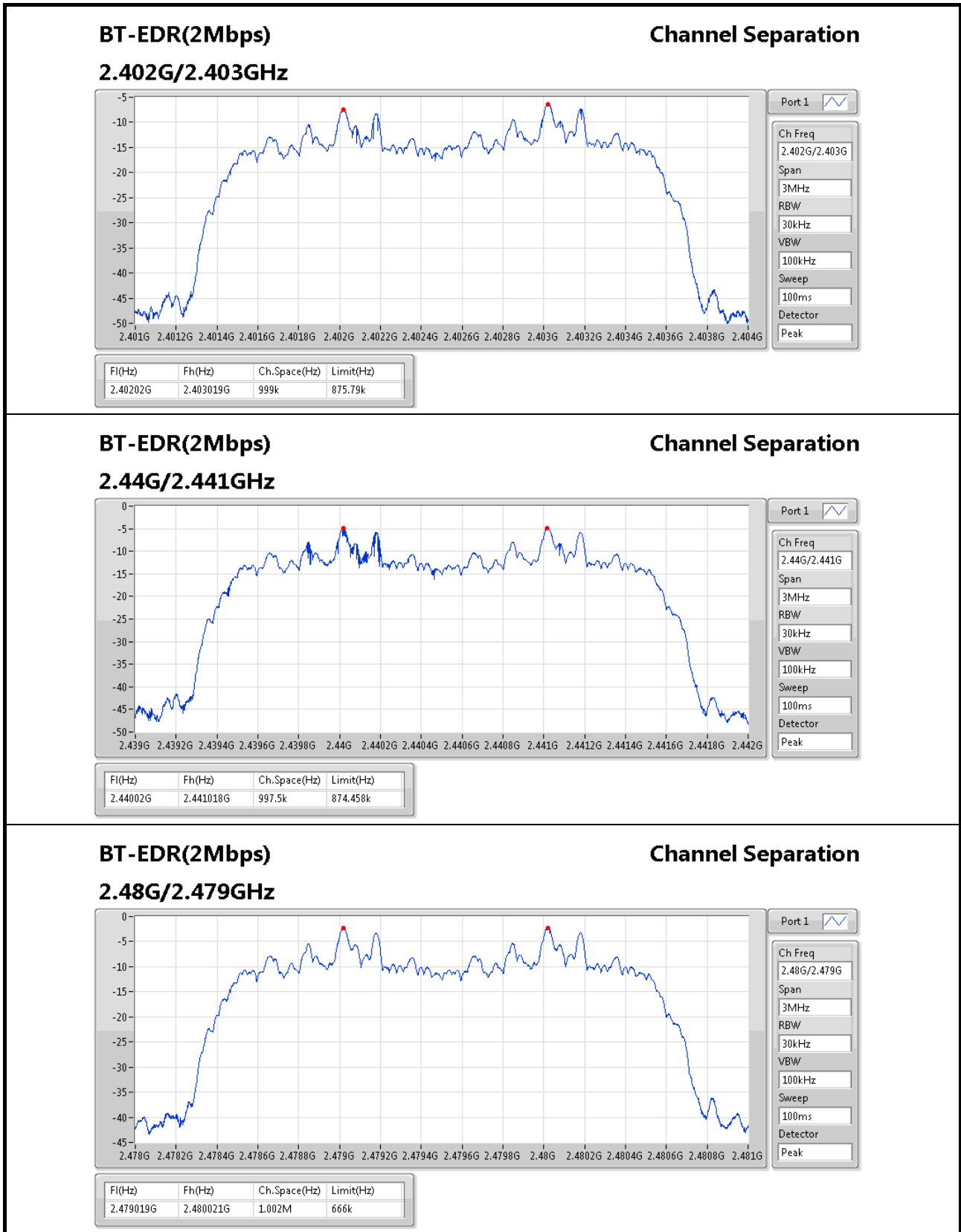



BT-EDR(3Mbps)

Channel Separation

2.402G/2.403GHz

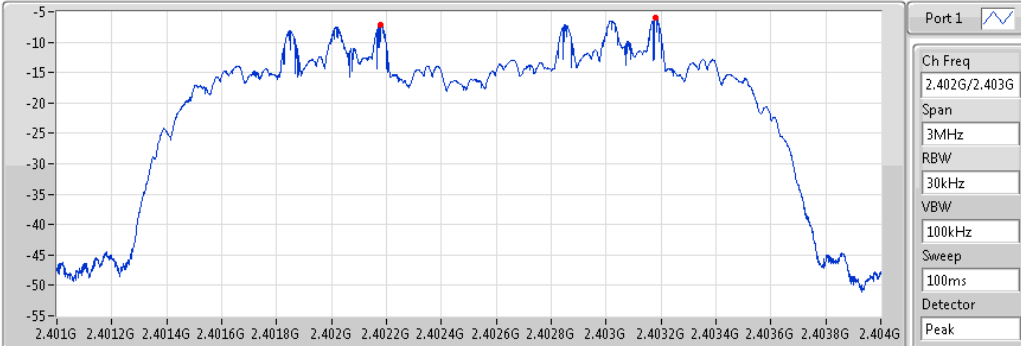

Ff(Hz)	Fh(Hz)	Ch.Space(Hz)	Limit(Hz)
2.402179G	2.40318G	1.0005M	839.16k

BT-EDR(3Mbps)

Channel Separation

2.44G/2.441GHz

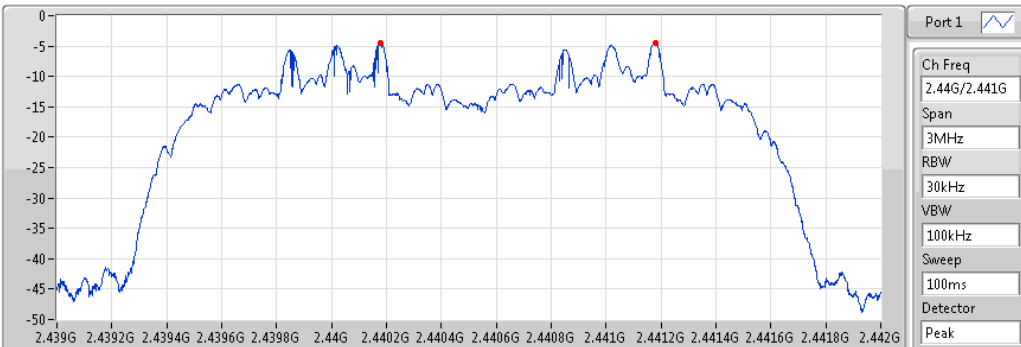

Ff(Hz)	Fh(Hz)	Ch.Space(Hz)	Limit(Hz)
2.440178G	2.441178G	1.0005M	666k

BT-EDR(3Mbps)

Channel Separation

2.48G/2.479GHz

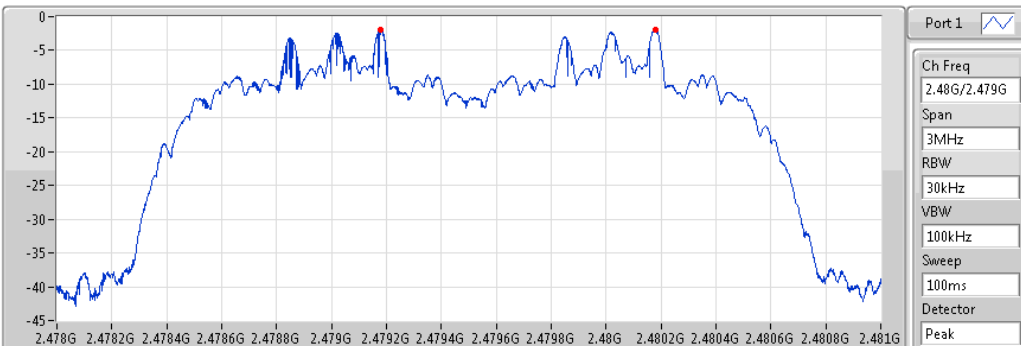

Ff(Hz)	Fh(Hz)	Ch.Space(Hz)	Limit(Hz)
2.479179G	2.480178G	999k	666k



Summary

Mode	Power (dBm)	Power (W)
BT-BR(1Mbps)	-	-
2.4-2.4835GHz	7.35	0.00543
BT-EDR(2Mbps)	-	-
2.4-2.4835GHz	4.37	0.00274
BT-EDR(3Mbps)	-	-
2.4-2.4835GHz	4.33	0.00271

Result

Mode	Result	Gain (dBi)	Power (dBm)	Power Limit (dBm)
BT-BR(1Mbps)	-	-	-	-
2402MHz	Pass	2.54	3.44	21.00
2440MHz	Pass	2.54	5.59	21.00
2480MHz	Pass	2.54	7.35	21.00
BT-EDR(2Mbps)	-	-	-	-
2402MHz	Pass	2.54	-1.01	21.00
2440MHz	Pass	2.54	1.70	21.00
2480MHz	Pass	2.54	4.37	21.00
BT-EDR(3Mbps)	-	-	-	-
2402MHz	Pass	2.54	-0.93	21.00
2440MHz	Pass	2.54	1.66	21.00
2480MHz	Pass	2.54	4.33	21.00



Summary

Mode	Power (dBm)	Power (W)
BT-BR(1Mbps)	-	-
2.4-2.4835GHz	7.20	0.00525
BT-EDR(2Mbps)	-	-
2.4-2.4835GHz	6.19	0.00416
BT-EDR(3Mbps)	-	-
2.4-2.4835GHz	6.32	0.00429

Result

Mode	Result	Gain (dBi)	Power (dBm)	Power Limit (dBm)
BT-BR(1Mbps)	-	-	-	-
2402MHz	Pass	2.54	3.57	21.00
2440MHz	Pass	2.54	5.64	21.00
2480MHz	Pass	2.54	7.20	21.00
BT-EDR(2Mbps)	-	-	-	-
2402MHz	Pass	2.54	1.47	21.00
2440MHz	Pass	2.54	3.96	21.00
2480MHz	Pass	2.54	6.19	21.00
BT-EDR(3Mbps)	-	-	-	-
2402MHz	Pass	2.54	1.76	21.00
2440MHz	Pass	2.54	4.25	21.00
2480MHz	Pass	2.54	6.32	21.00



Summary

Mode	Max-Hop No
BT-BR(1Mbps)	-
2.4-2.4835GHz	79
BT-EDR(2Mbps)	-
2.4-2.4835GHz	79
BT-EDR(3Mbps)	-
2.4-2.4835GHz	79

Result

Mode	Result	Hopping No	Limit
BT-BR(1Mbps)	-	-	-
2402MHz	Pass	79	15
2440MHz	Pass	79	15
2480MHz	Pass	79	15
BT-EDR(2Mbps)	-	-	-
2402MHz	Pass	79	15
2440MHz	Pass	79	15
2480MHz	Pass	79	15
BT-EDR(3Mbps)	-	-	-
2402MHz	Pass	79	15
2440MHz	Pass	79	15
2480MHz	Pass	79	15

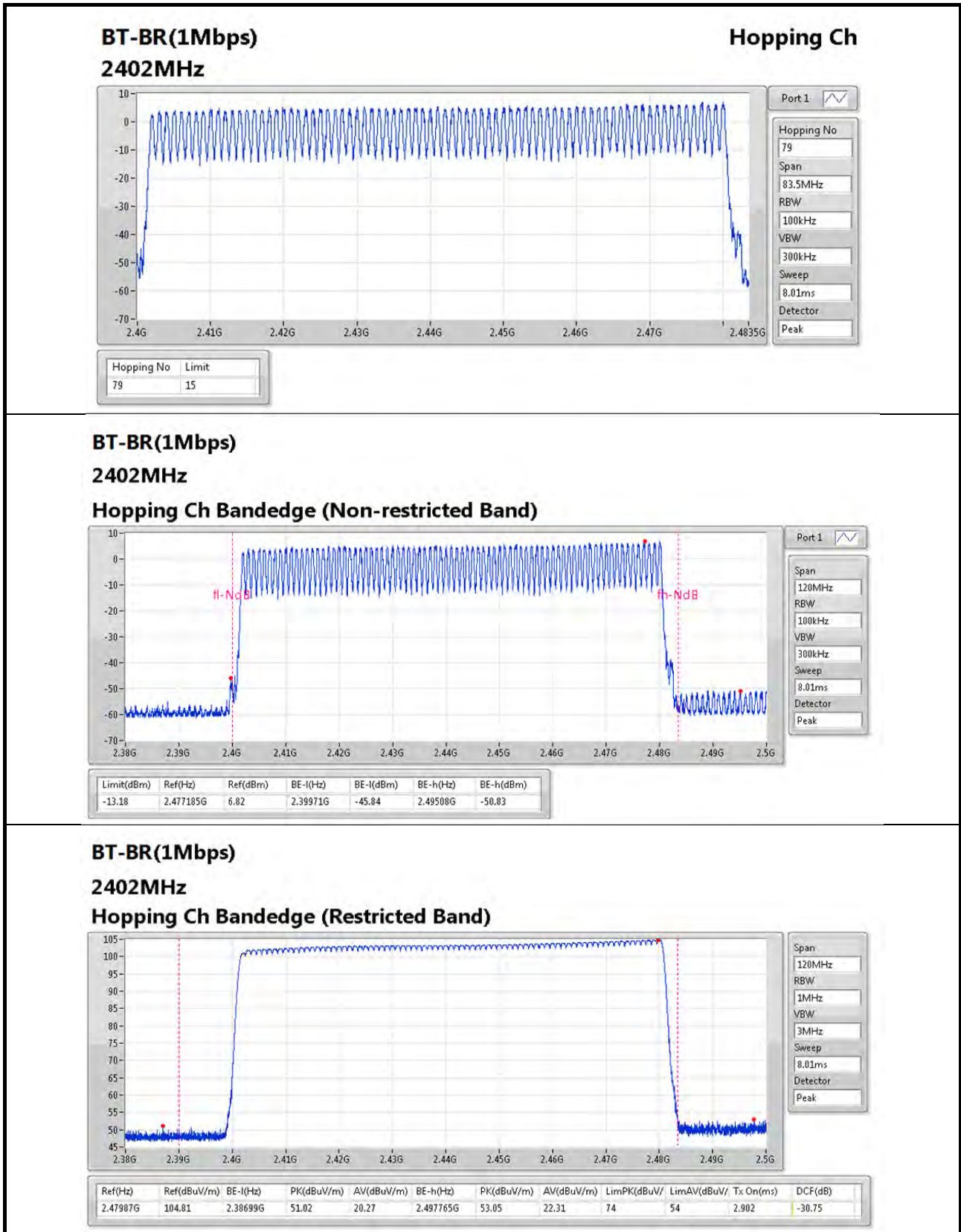

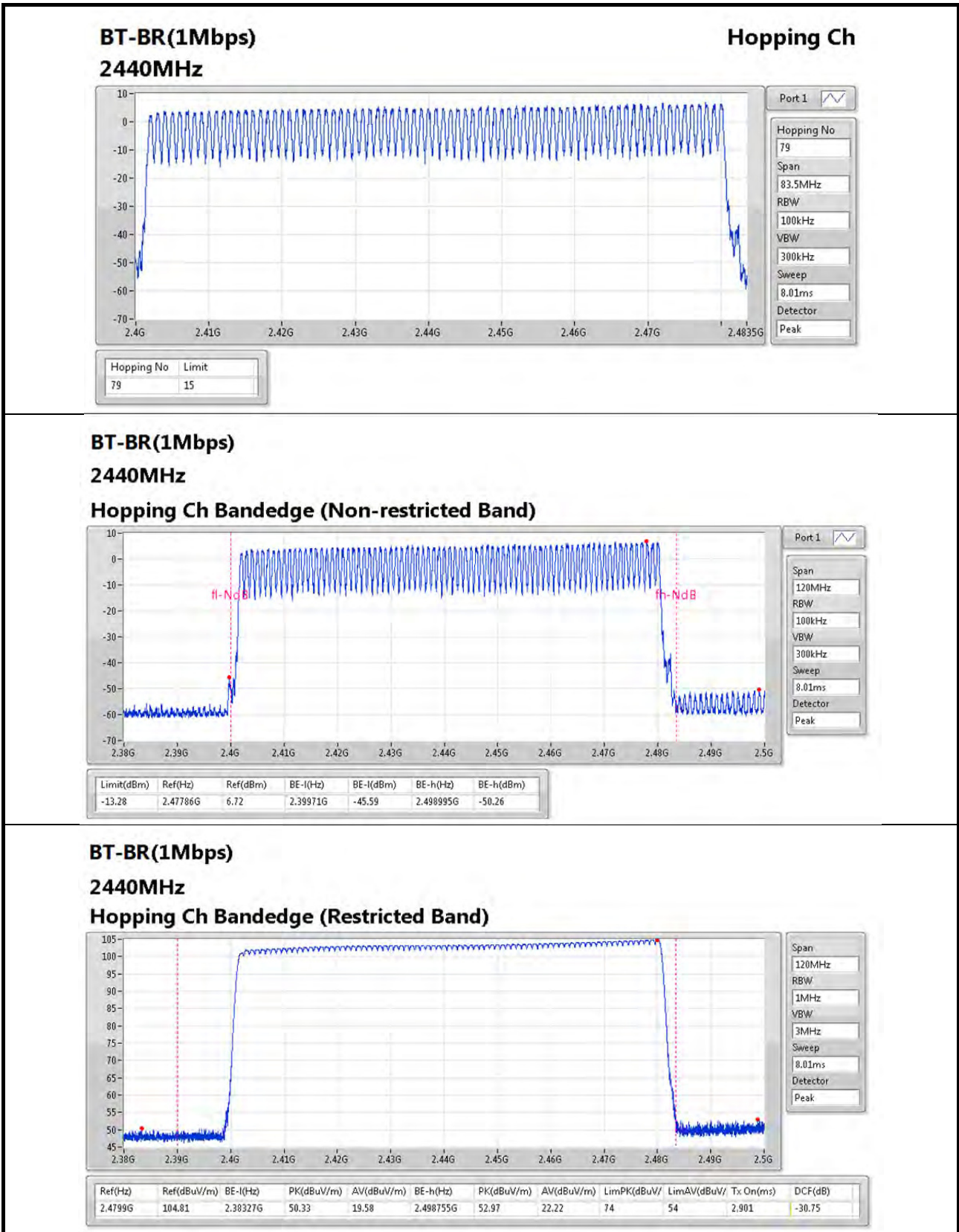

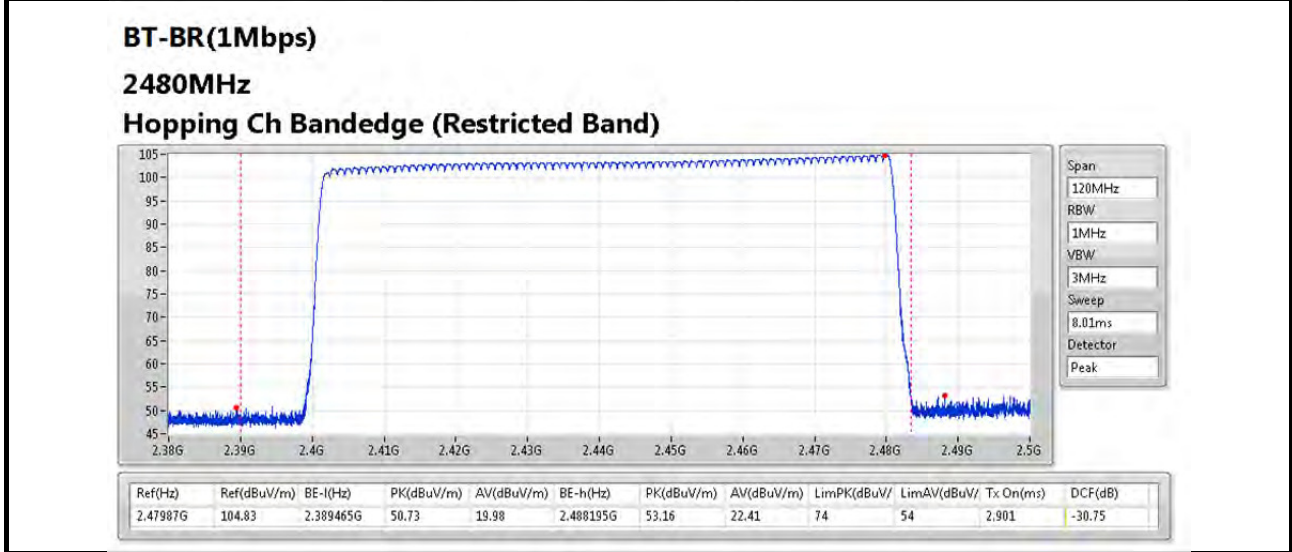
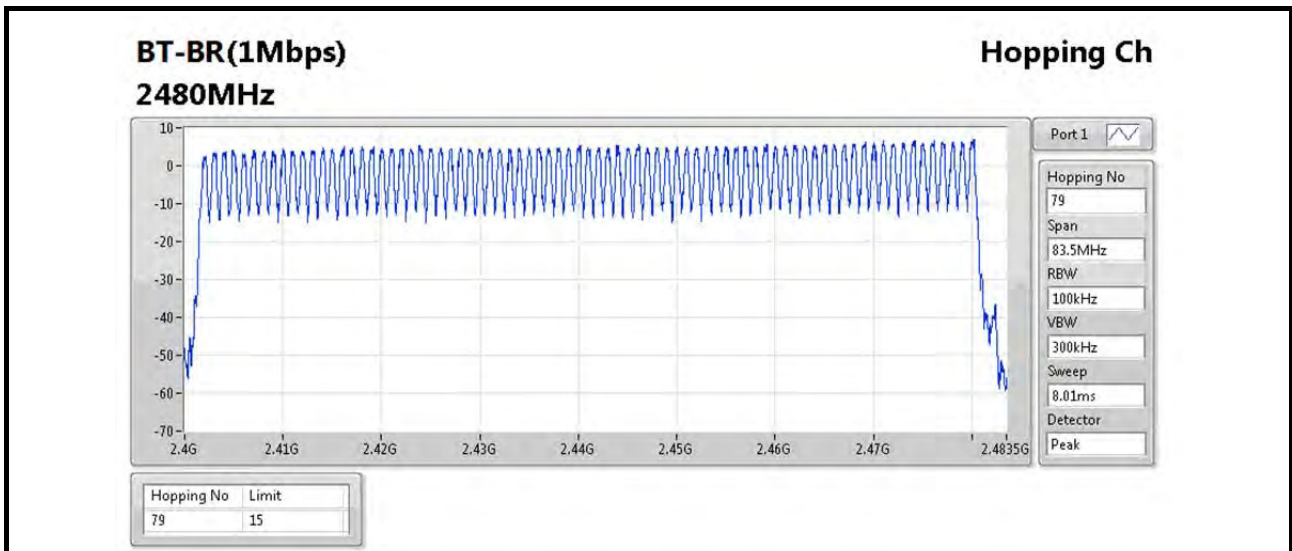

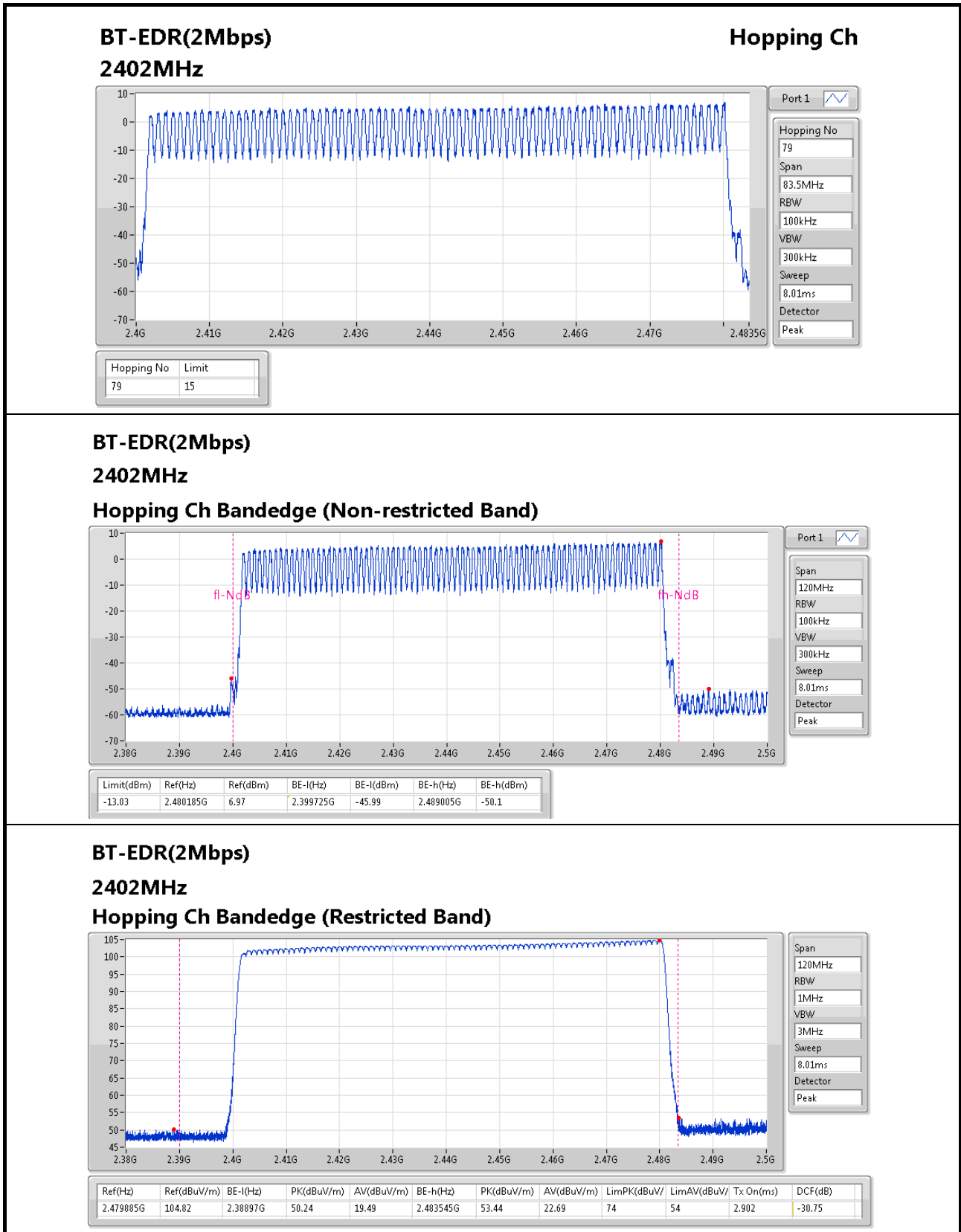

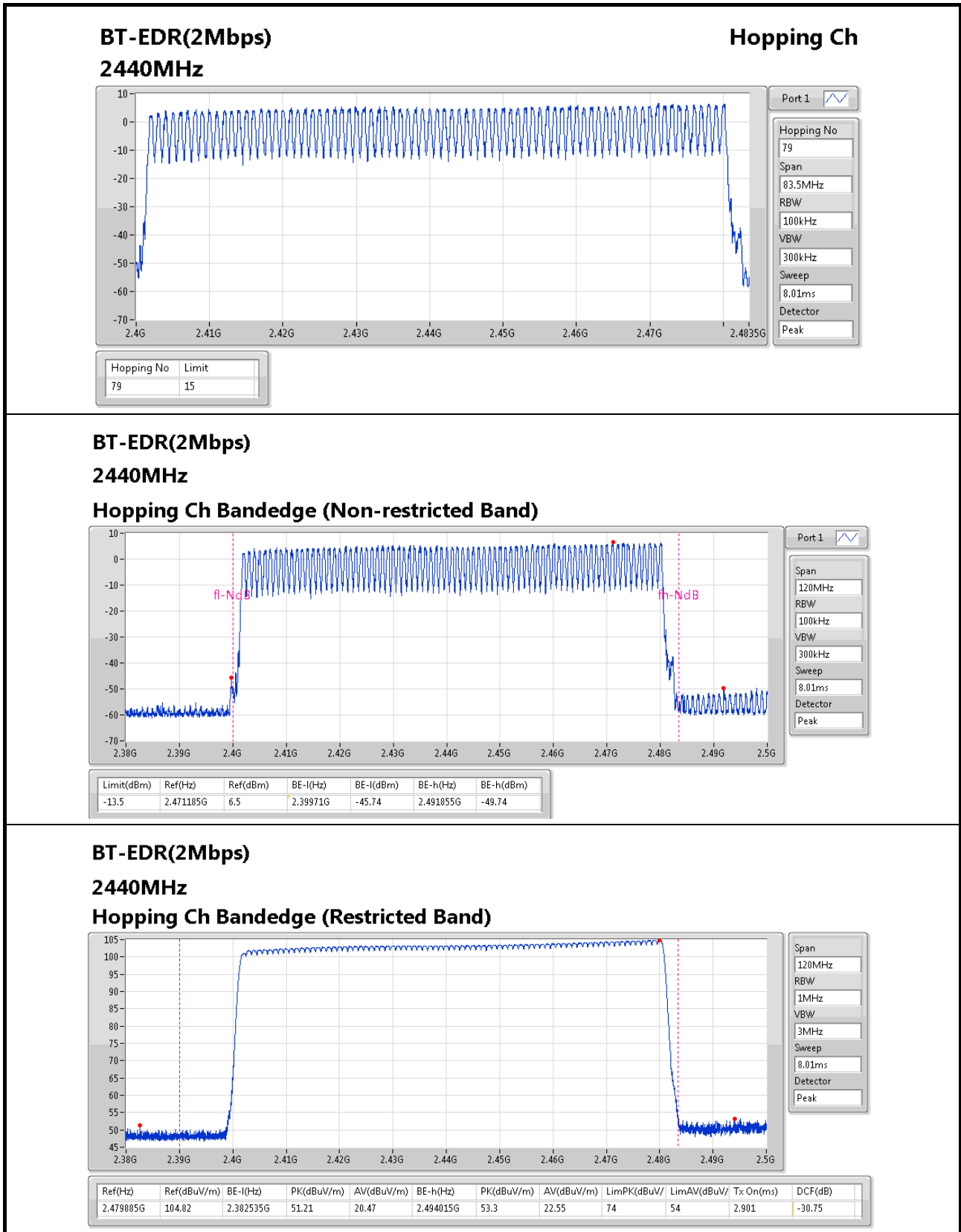

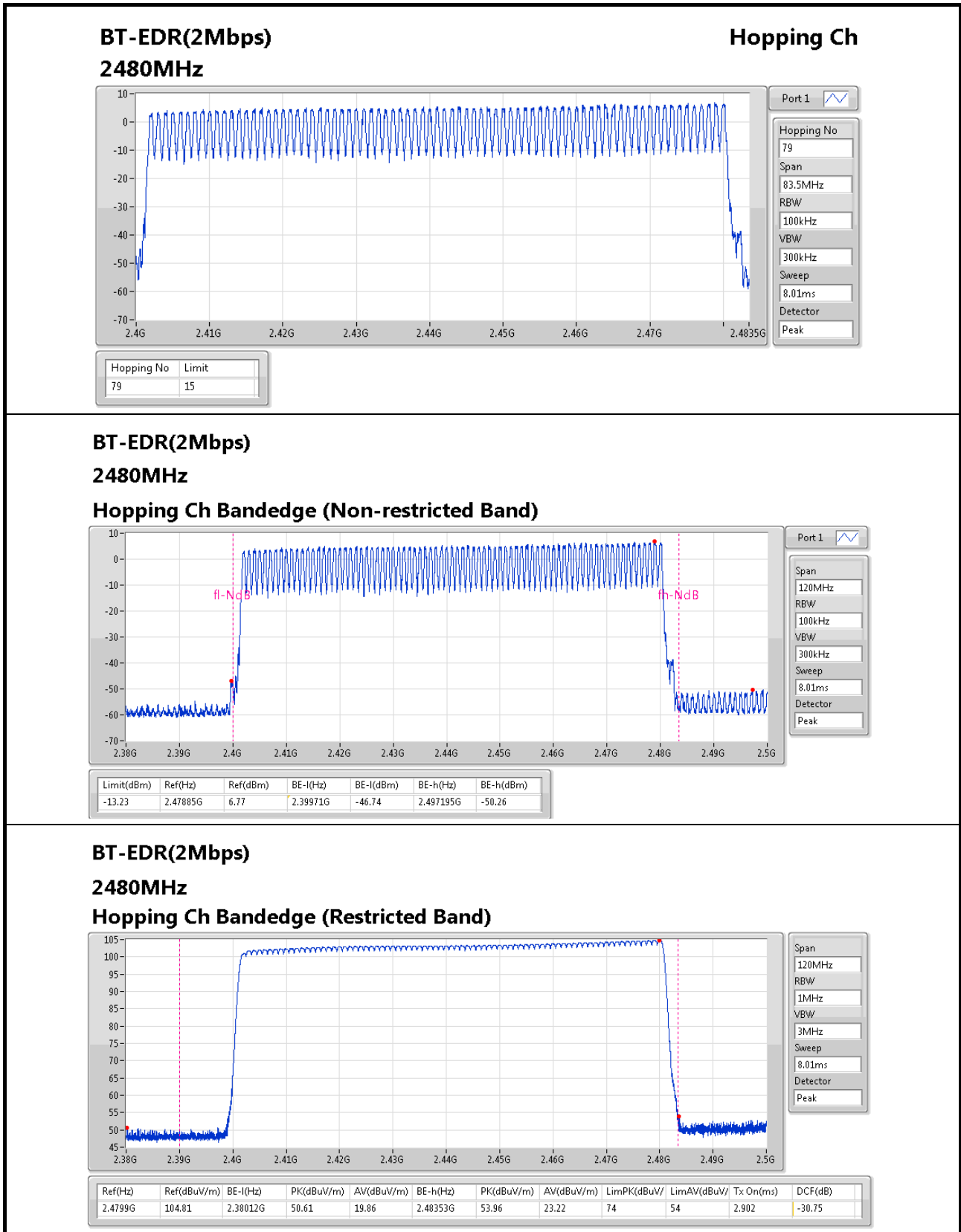

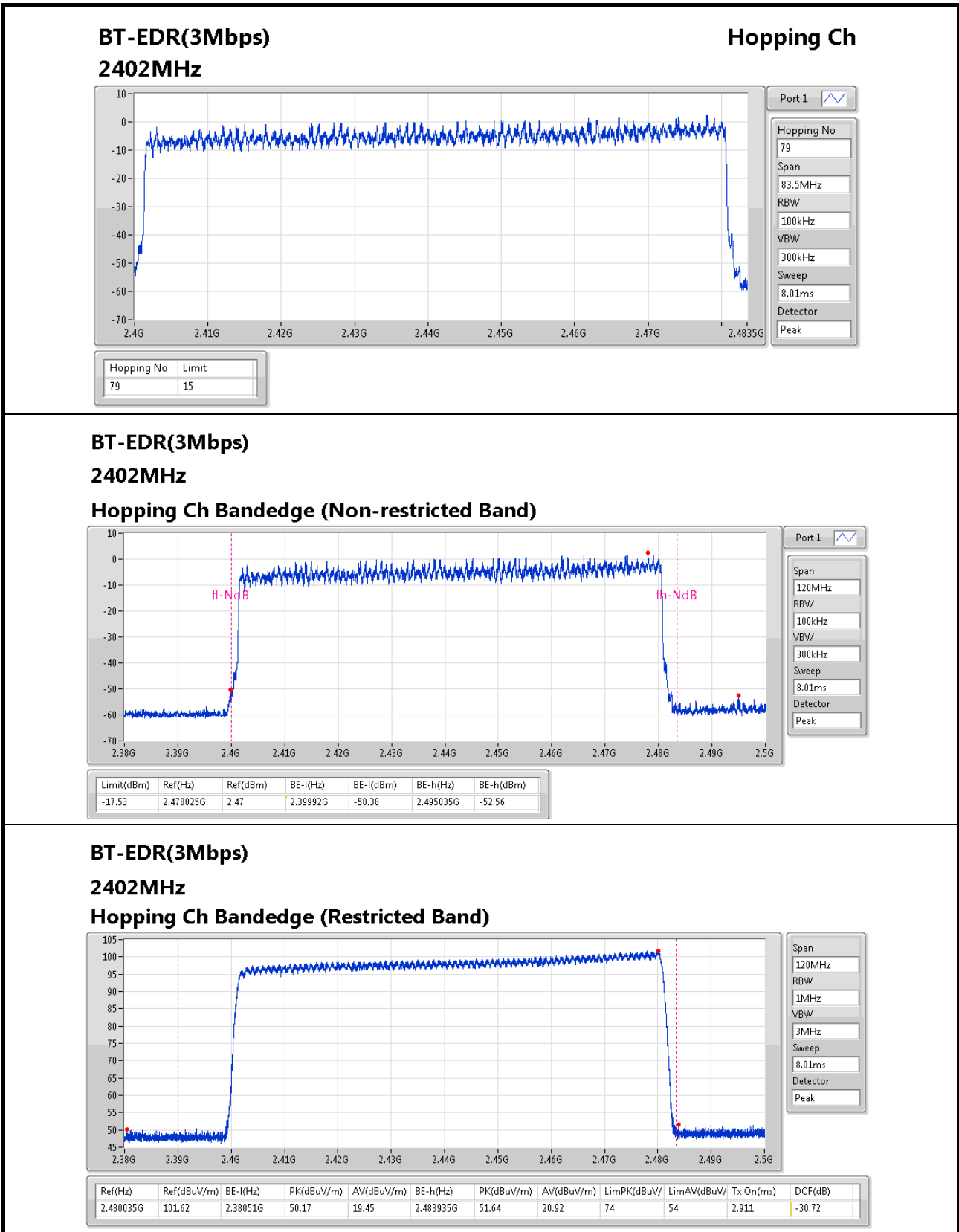

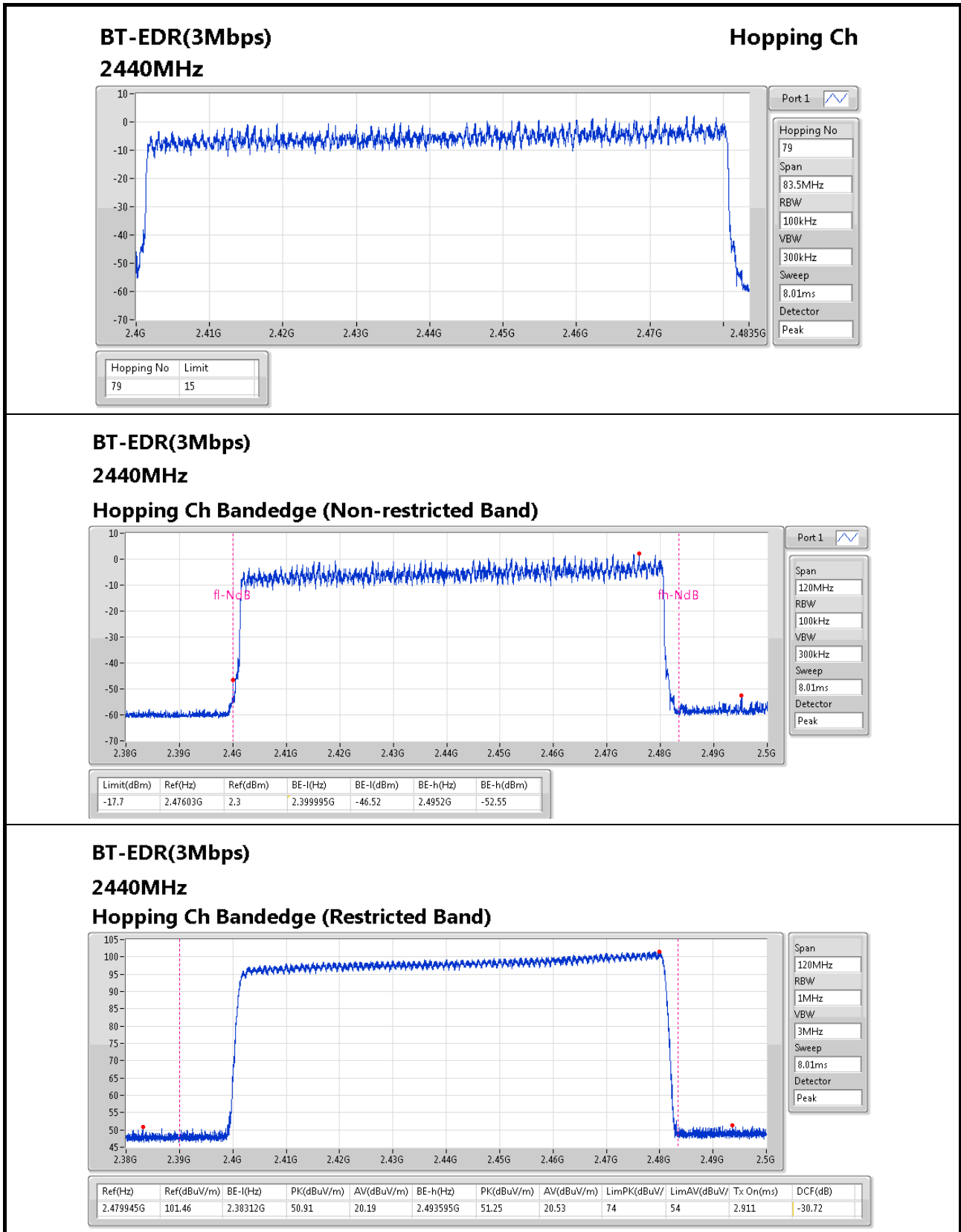

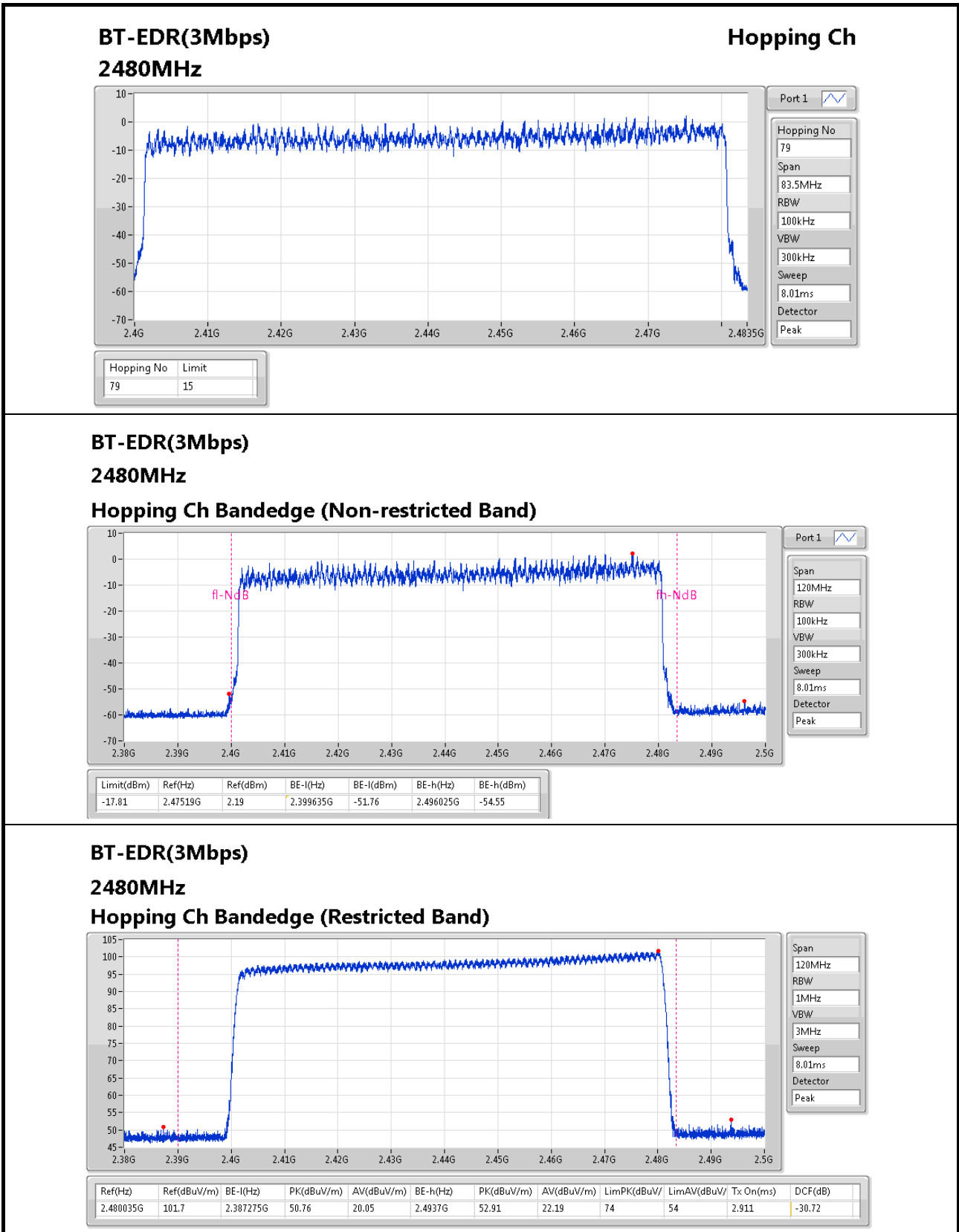

BT-EDR(3Mbps)

2480MHz

Hopping Ch Bandedge (Restricted Band)

Hopping Ch



Summary

Mode	Max-Dwell (s)
BT-BR(1Mbps)	-
2.4-2.4835GHz	309.3532m
BT-EDR(2Mbps)	-
2.4-2.4835GHz	309.3532m
BT-EDR(3Mbps)	-
2.4-2.4835GHz	310.3126m

Result

Mode	Result	Period (s)	Dwell (s)	Limit (s)	Tx On (s)
BT-BR(1Mbps)	-	-	-	-	-
2402MHz	Pass	31.6	309.3532m	400m	2.902m
2440MHz	Pass	31.6	309.2466m	400m	2.901m
2480MHz	Pass	31.6	309.2466m	400m	2.901m
BT-EDR(2Mbps)	-	-	-	-	-
2402MHz	Pass	31.6	309.3532m	400m	2.902m
2440MHz	Pass	31.6	309.2466m	400m	2.901m
2480MHz	Pass	31.6	309.3532m	400m	2.902m
BT-EDR(3Mbps)	-	-	-	-	-
2402MHz	Pass	31.6	310.3126m	400m	2.911m
2440MHz	Pass	31.6	310.3126m	400m	2.911m
2480MHz	Pass	31.6	310.3126m	400m	2.911m

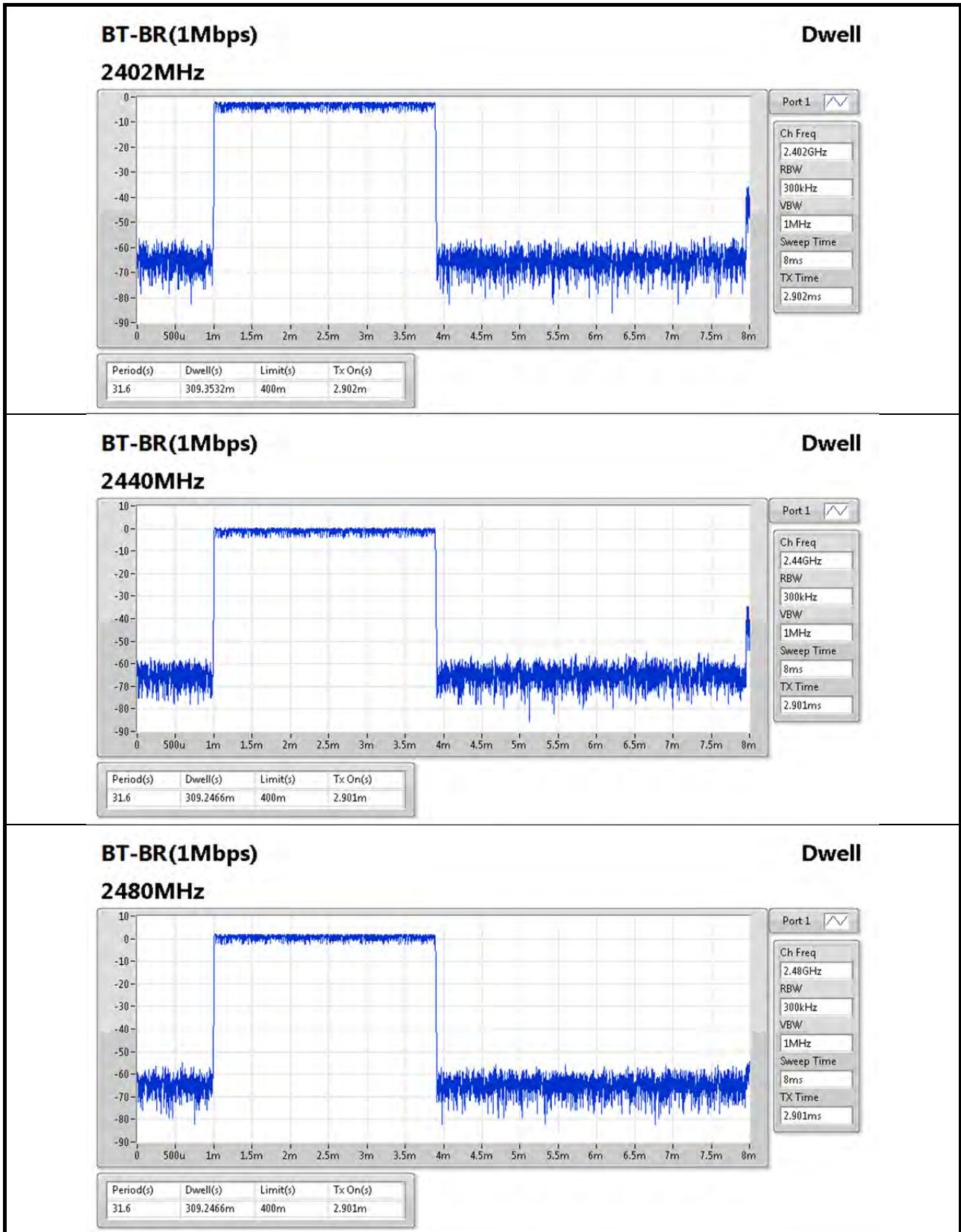

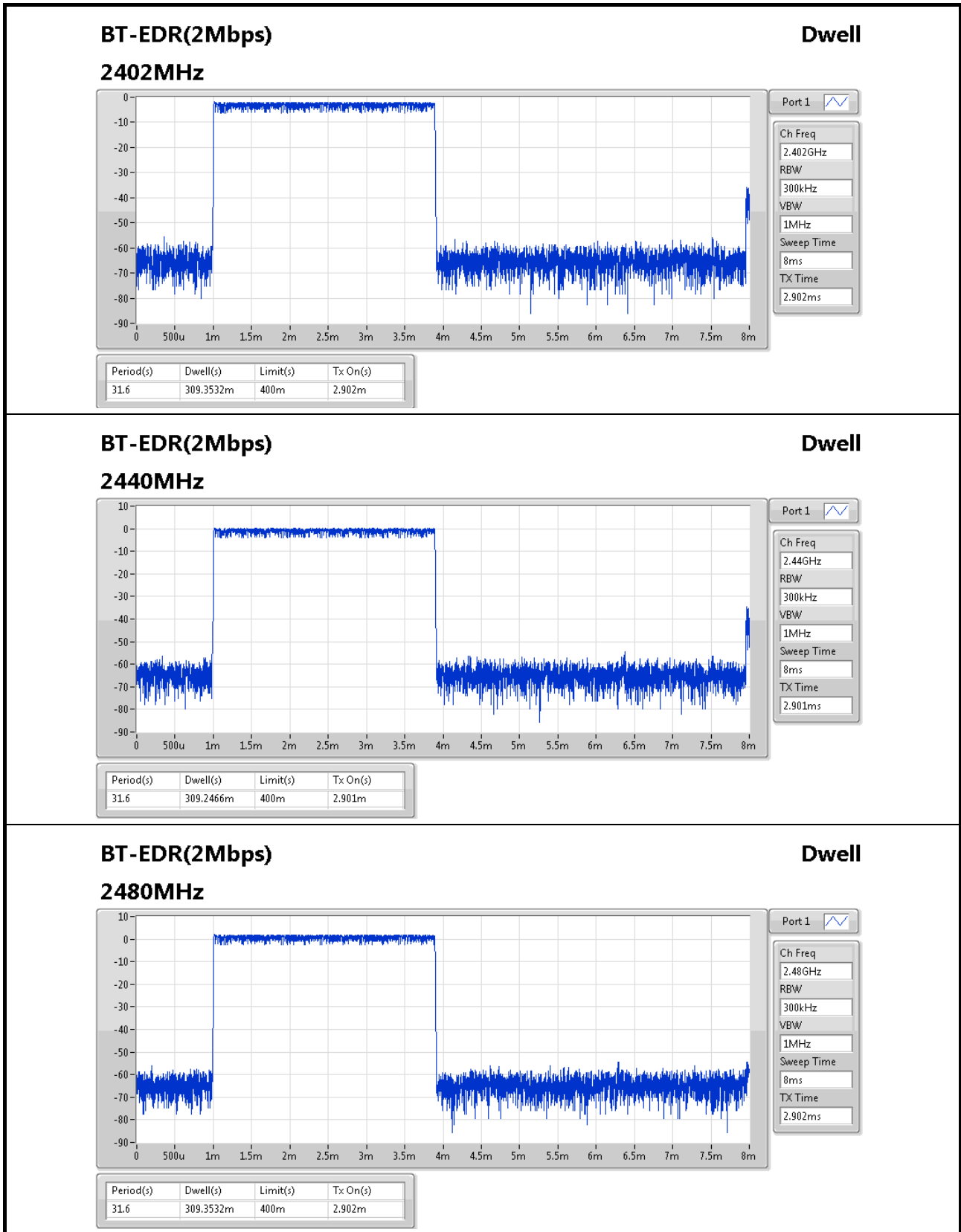

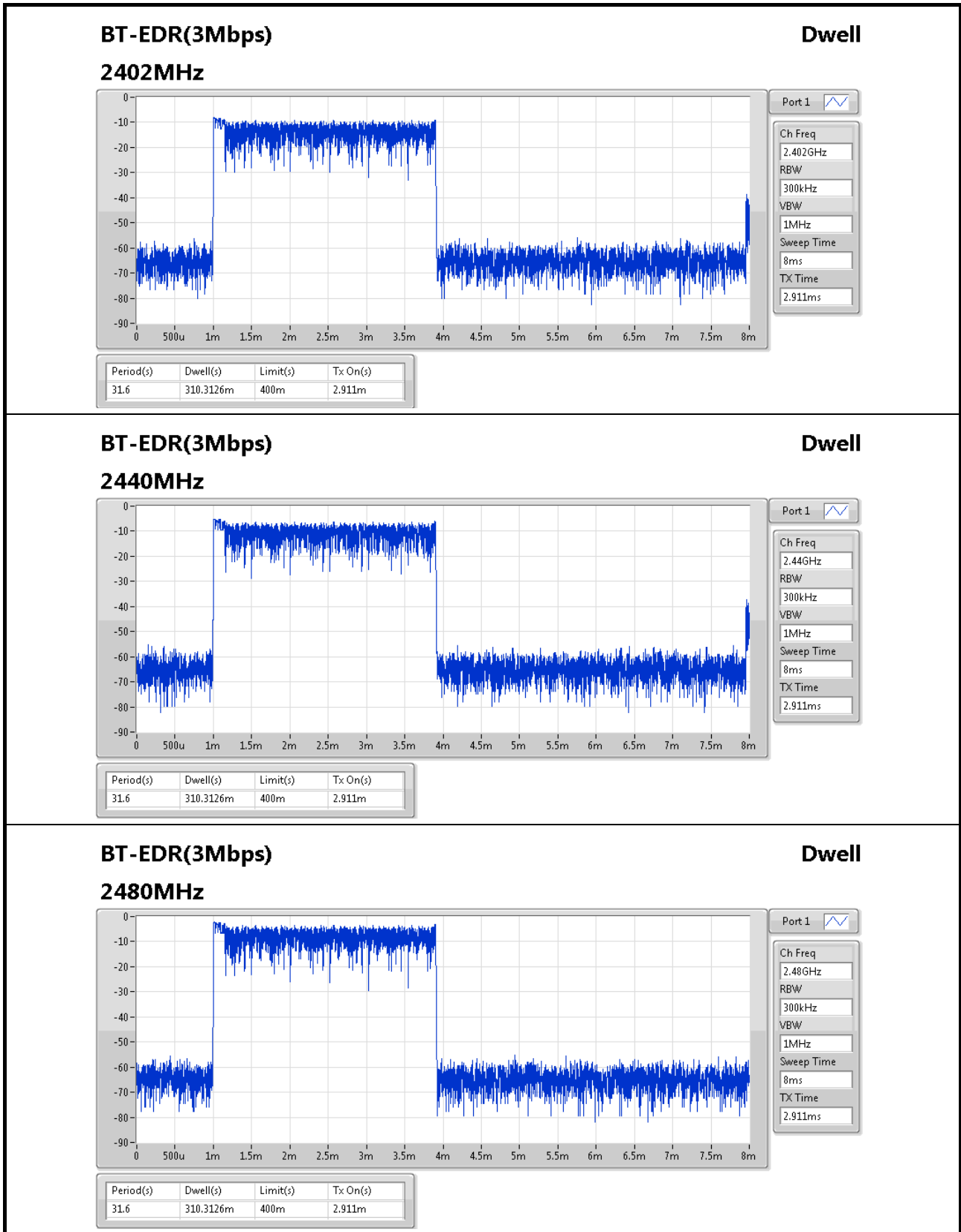



Summary

Mode	Result	Ref (Hz)	Ref (dBm)	Limit (dBm)	Freq (Hz)	Level (dBm)	Freq (Hz)	Level (dBm)	Freq (Hz)	Level (dBm)	Freq (Hz)	Level (dBm)	Port
2402MHz	Pass	2.401837G	-8.67	-28.67	1.933872G	-53.69	2.39998G	-48.12	2.485288G	-53.02	24.881799G	-35.81	1

Result

Mode	Result	Ref (Hz)	Ref (dBm)	Limit (dBm)	Freq (Hz)	Level (dBm)	Freq (Hz)	Level (dBm)	Freq (Hz)	Level (dBm)	Freq (Hz)	Level (dBm)	Port
BT-BR(1Mbps)	-	-	-	-	-	-	-	-	-	-	-	-	-
2402MHz	Pass	2.402004G	-2.82	-22.82	2.197904G	-53.81	2.399692G	-48.23	2.483588G	-51.94	17.440757G	-36.18	1
2480MHz	Pass	2.479993G	-0.01	-20.01	2.395632G	-53.03	2.398412G	-53.20	2.485436G	-52.39	17.536443G	-35.48	1
BT-EDR(2Mbps)	-	-	-	-	-	-	-	-	-	-	-	-	-
2402MHz	Pass	2.401837G	-8.67	-28.67	1.933872G	-53.69	2.39998G	-48.12	2.485288G	-53.02	24.881799G	-35.81	1
2480MHz	Pass	2.479993G	-4.50	-24.50	2.156464G	-52.99	2.399616G	-52.57	2.485104G	-52.04	23.587215G	-35.86	1
BT-EDR(3Mbps)	-	-	-	-	-	-	-	-	-	-	-	-	-
2402MHz	Pass	2.402171G	-8.40	-28.40	1.879408G	-53.46	2.399976G	-47.96	2.48416G	-52.91	24.805812G	-34.70	1
2480MHz	Pass	2.479993G	-4.13	-24.13	915.632M	-53.82	2.39844G	-52.25	2.485296G	-53.53	24.907128G	-35.47	1

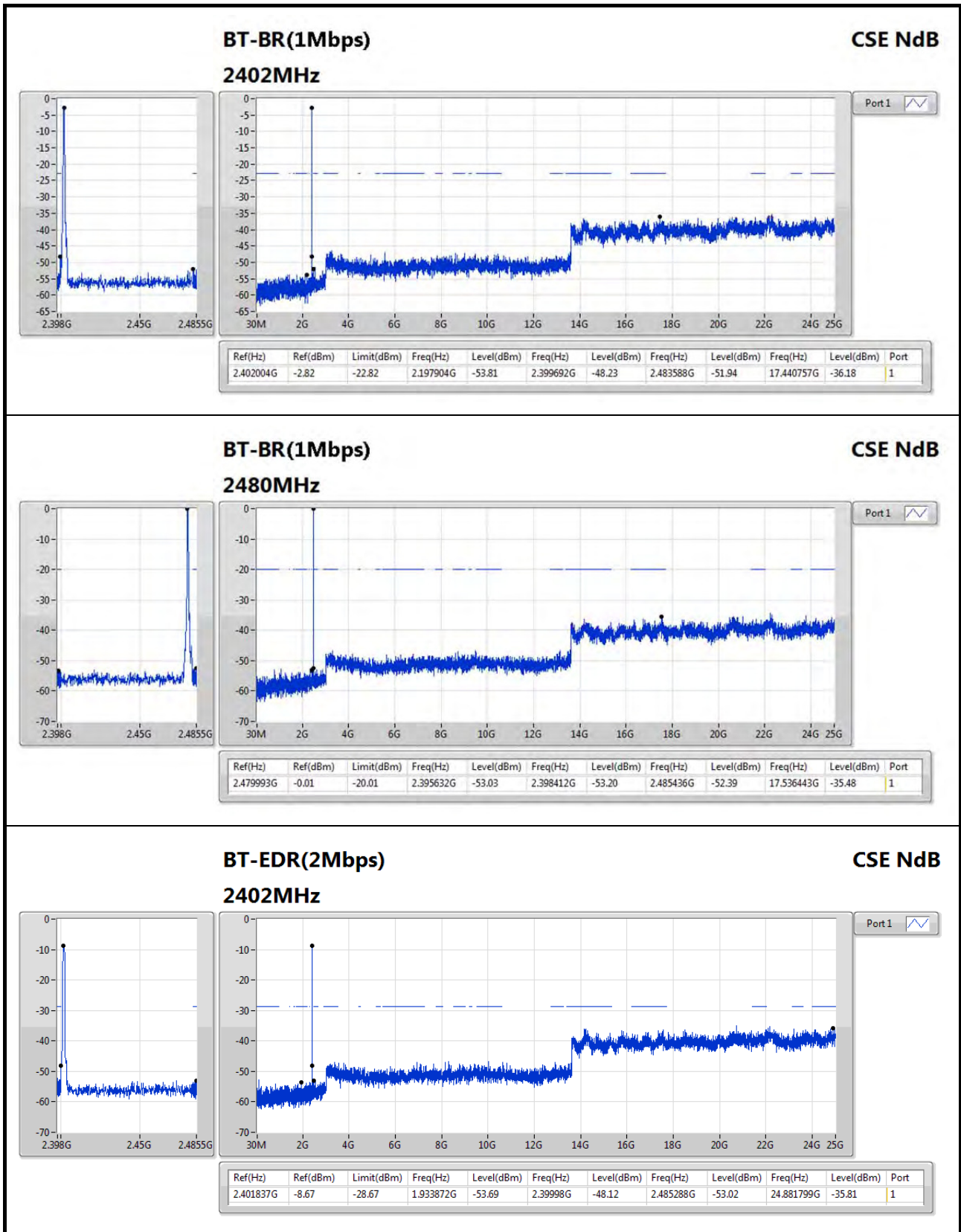

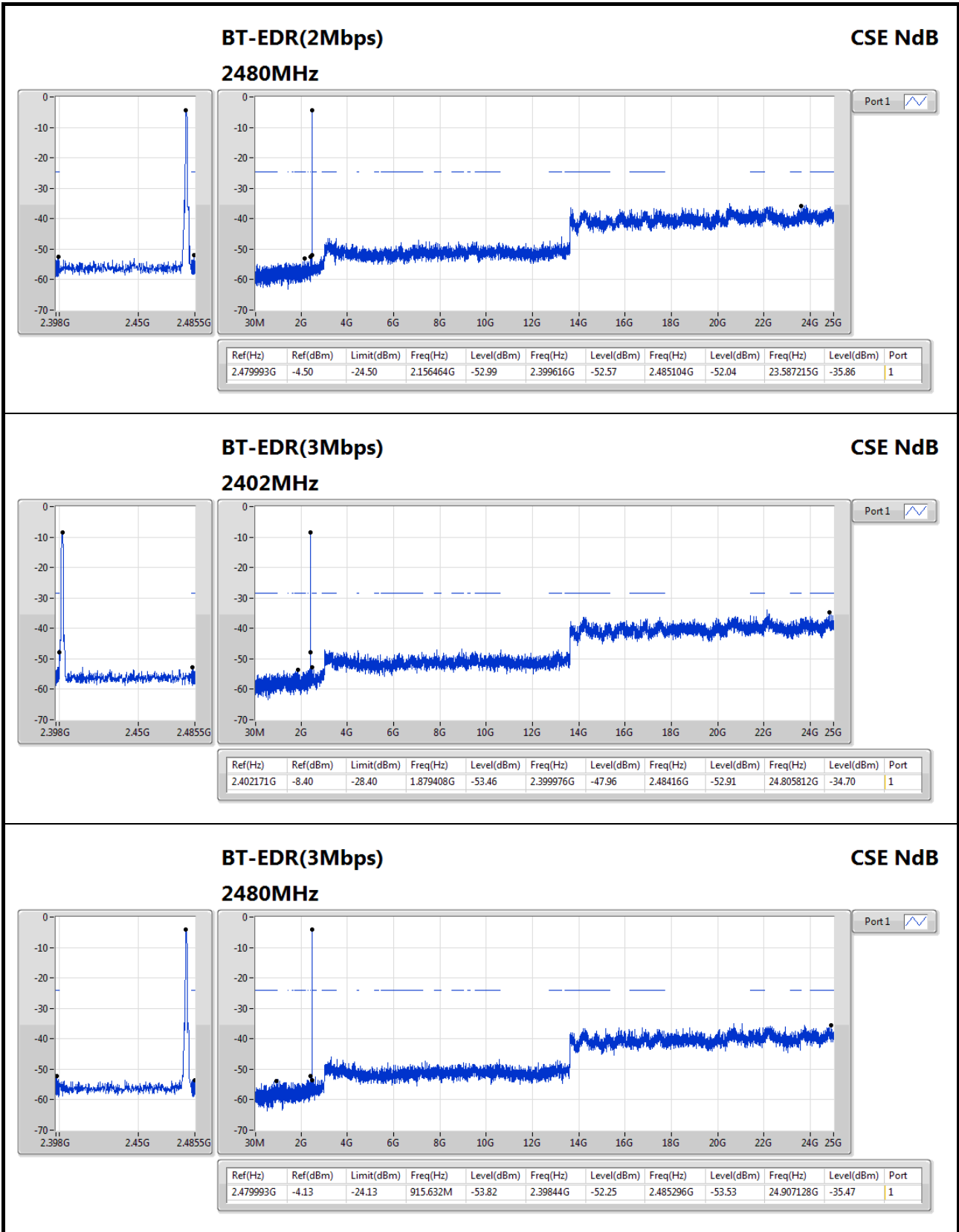



RSE below 1GHz Result

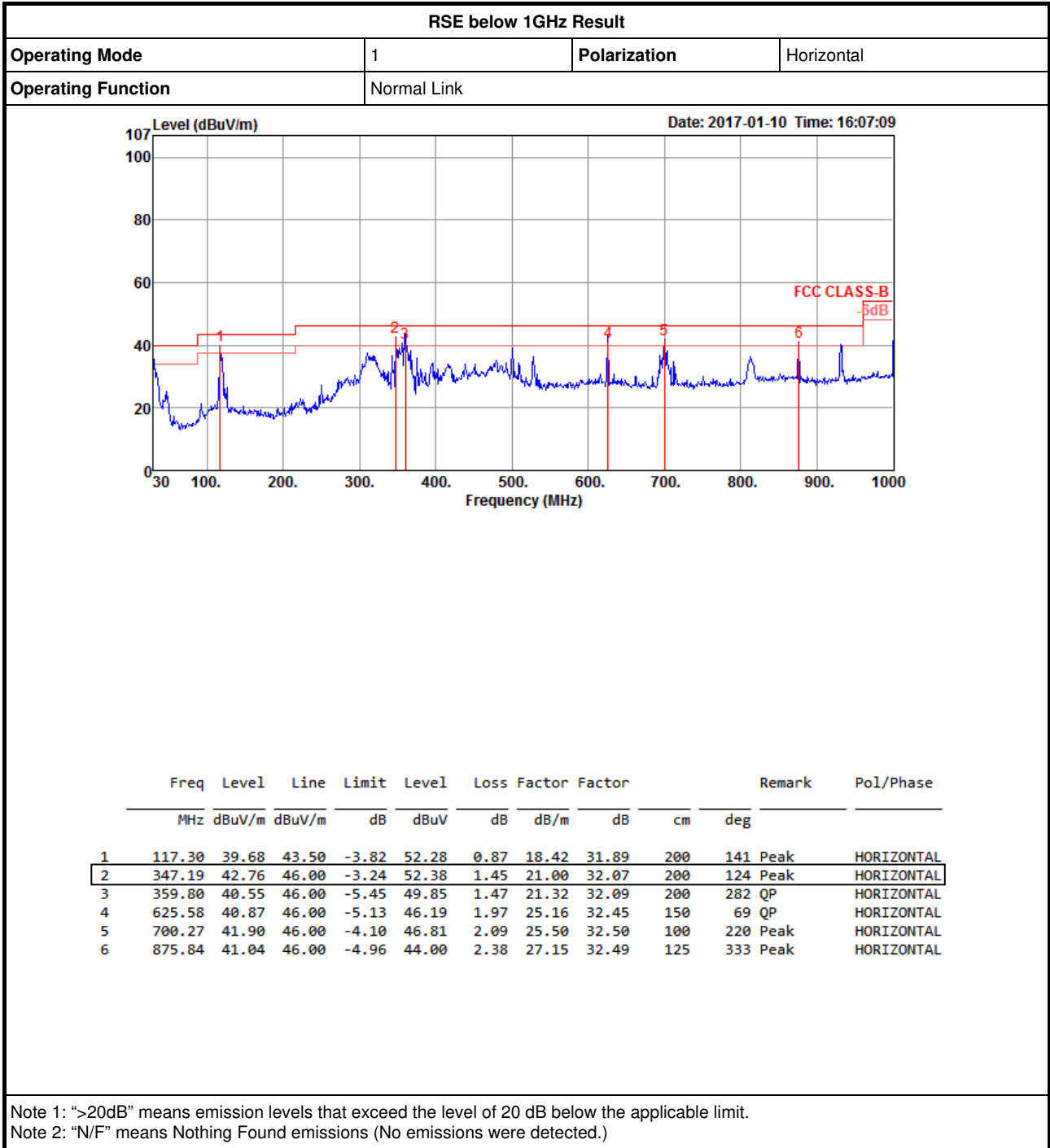



RSE below 1GHz Result

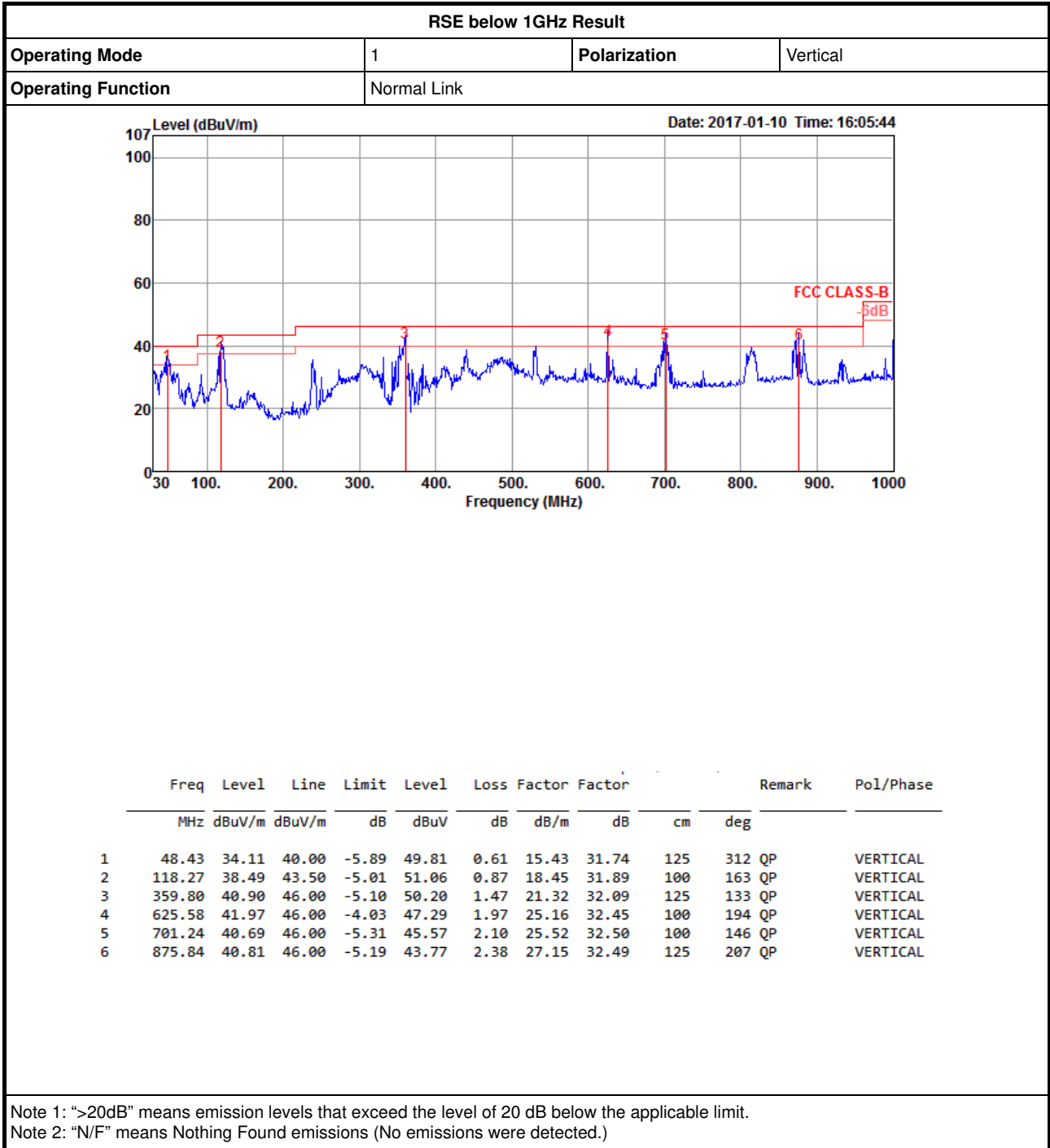



Radiated Emissions (1GHz~10th Harmonic)

Configurations	BR (GFSK) CH 0 / Chain 5
-----------------------	--------------------------

Horizontal

	Freq	Level	Limit Line	Over Limit	Read Level	CableAntenna Loss	Preamp Factor	A/Pos	T/Pos	Remark	Pol/Phase	
	MHz	dBuV/m	dBuV/m	dB	dBuV	dB	dB/m	dB	cm	deg		
1	4804.04	21.95	54.00	-32.05	18.64	5.22	32.62	34.53	102	110	Average	HORIZONTAL
2	4804.04	52.76	74.00	-21.24	49.45	5.22	32.62	34.53	102	110	Peak	HORIZONTAL

Vertical

	Freq	Level	Limit Line	Over Limit	Read Level	CableAntenna Loss	Preamp Factor	A/Pos	T/Pos	Remark	Pol/Phase	
	MHz	dBuV/m	dBuV/m	dB	dBuV	dB	dB/m	dB	cm	deg		
1	4804.01	21.21	54.00	-32.79	17.90	5.22	32.62	34.53	101	112	Average	VERTICAL
2	4804.01	52.02	74.00	-21.98	48.71	5.22	32.62	34.53	101	112	Peak	VERTICAL

Configurations	BR (GFSK) CH 38 / Chain 5
-----------------------	---------------------------

Horizontal

	Freq	Level	Limit Line	Over Limit	Read Level	CableAntenna Loss	Preamp Factor	A/Pos	T/Pos	Remark	Pol/Phase	
	MHz	dBuV/m	dBuV/m	dB	dBuV	dB	dB/m	dB	cm	deg		
1	4880.02	21.93	54.00	-32.07	18.39	5.28	32.76	34.50	116	188	Average	HORIZONTAL
2	4880.02	52.74	74.00	-21.26	49.20	5.28	32.76	34.50	116	188	Peak	HORIZONTAL

Vertical

	Freq	Level	Limit Line	Over Limit	Read Level	CableAntenna Loss	Preamp Factor	A/Pos	T/Pos	Remark	Pol/Phase	
	MHz	dBuV/m	dBuV/m	dB	dBuV	dB	dB/m	dB	cm	deg		
1	4880.02	20.52	54.00	-33.48	16.98	5.28	32.76	34.50	108	165	Average	VERTICAL
2	4880.02	51.33	74.00	-22.67	47.79	5.28	32.76	34.50	108	165	Peak	VERTICAL



Configurations	BR (GFSK) CH 78 / Chain 5
-----------------------	---------------------------

Horizontal

	Freq	Level	Limit Line	Over Limit	Read Level	CableAntenna Loss	Preamp Factor	A/Pos	T/Pos	Remark	Pol/Phase
	MHz	dBuV/m	dBuV/m	dB	dBuV	dB	dB/m	dB	cm	deg	
1	4959.97	20.55	54.00	-33.45	16.76	5.35	32.92	34.48	159	194 Average	HORIZONTAL
2	4959.97	51.36	74.00	-22.64	47.57	5.35	32.92	34.48	159	194 Peak	HORIZONTAL

Vertical

	Freq	Level	Limit Line	Over Limit	Read Level	CableAntenna Loss	Preamp Factor	A/Pos	T/Pos	Remark	Pol/Phase
	MHz	dBuV/m	dBuV/m	dB	dBuV	dB	dB/m	dB	cm	deg	
1	4960.03	20.20	54.00	-33.80	16.41	5.35	32.92	34.48	209	64 Average	VERTICAL
2	4960.03	51.01	74.00	-22.99	47.22	5.35	32.92	34.48	209	64 Peak	VERTICAL

Note:

The amplitude of spurious emissions which are attenuated by more than 20dB below the permissible value has no need to be reported.

Emission level (dBuV/m) = 20 log Emission level (uV/m).

Corrected Reading: Antenna Factor + Cable Loss + Read Level - Preamp Factor = Level.



Emissions in Restricted Frequency Bands Result

Appendix G.2

Configurations	EDR (8DPSK) CH 0 / Chain 5
-----------------------	----------------------------

Horizontal

	Freq	Level	Limit Line	Over Limit	Read Level	CableAntenna Loss	Antenna Factor	Preamp Factor	A/Pos	T/Pos	Remark	Pol/Phase
	MHz	dBuV/m	dBuV/m	dB	dBuV	dB	dB/m	dB	cm	deg		
1	4804.00	19.42	54.00	-34.58	16.11	5.22	32.62	34.53	107	192	Average	HORIZONTAL
2	4804.00	50.48	74.00	-23.52	47.17	5.22	32.62	34.53	107	192	Peak	HORIZONTAL

Vertical

	Freq	Level	Limit Line	Over Limit	Read Level	CableAntenna Loss	Antenna Factor	Preamp Factor	A/Pos	T/Pos	Remark	Pol/Phase
	MHz	dBuV/m	dBuV/m	dB	dBuV	dB	dB/m	dB	cm	deg		
1	4804.04	21.10	54.00	-32.90	17.79	5.22	32.62	34.53	110	232	Average	VERTICAL
2	4804.04	52.16	74.00	-21.84	48.85	5.22	32.62	34.53	110	232	Peak	VERTICAL

Configurations	EDR (8DPSK) CH 38 / Chain 5
-----------------------	-----------------------------

Horizontal

	Freq	Level	Limit Line	Over Limit	Read Level	CableAntenna Loss	Antenna Factor	Preamp Factor	A/Pos	T/Pos	Remark	Pol/Phase
	MHz	dBuV/m	dBuV/m	dB	dBuV	dB	dB/m	dB	cm	deg		
1	4879.90	19.41	54.00	-34.59	15.87	5.28	32.76	34.50	118	60	Average	HORIZONTAL
2	4879.90	50.47	74.00	-23.53	46.93	5.28	32.76	34.50	118	60	Peak	HORIZONTAL

Vertical

	Freq	Level	Limit Line	Over Limit	Read Level	CableAntenna Loss	Antenna Factor	Preamp Factor	A/Pos	T/Pos	Remark	Pol/Phase
	MHz	dBuV/m	dBuV/m	dB	dBuV	dB	dB/m	dB	cm	deg		
1	4880.06	21.77	54.00	-32.23	18.23	5.28	32.76	34.50	106	234	Average	VERTICAL
2	4880.06	52.83	74.00	-21.17	49.29	5.28	32.76	34.50	106	234	Peak	VERTICAL



Configurations	EDR (8DPSK) CH 78 / Chain 5
-----------------------	-----------------------------

Horizontal

	Freq	Level	Limit Line	Over Limit	Read Level	Cable Loss	Antenna Factor	Preamp Factor	A/Pos	T/Pos	Remark	Pol/Phase
	MHz	dBuV/m	dBuV/m	dB	dBuV	dB	dB/m	dB	cm	deg		
1	4960.02	17.63	54.00	-36.37	13.84	5.35	32.92	34.48	256	213	Average	HORIZONTAL
2	4960.02	48.69	74.00	-25.31	44.90	5.35	32.92	34.48	256	213	Peak	HORIZONTAL

Vertical

	Freq	Level	Limit Line	Over Limit	Read Level	Cable Loss	Antenna Factor	Preamp Factor	A/Pos	T/Pos	Remark	Pol/Phase
	MHz	dBuV/m	dBuV/m	dB	dBuV	dB	dB/m	dB	cm	deg		
1	4960.10	18.74	54.00	-35.26	14.95	5.35	32.92	34.48	118	184	Average	VERTICAL
2	4960.10	49.80	74.00	-24.20	46.01	5.35	32.92	34.48	118	184	Peak	VERTICAL

Note:

The amplitude of spurious emissions which are attenuated by more than 20dB below the permissible value has no need to be reported.

Emission level (dBuV/m) = 20 log Emission level (uV/m).

Corrected Reading: Antenna Factor + Cable Loss + Read Level - Preamp Factor = Level.



Band Edge Emissions

Configurations	BR (GFSK) CH 0, 38, 78 / Chain 5
----------------	----------------------------------

Channel 0

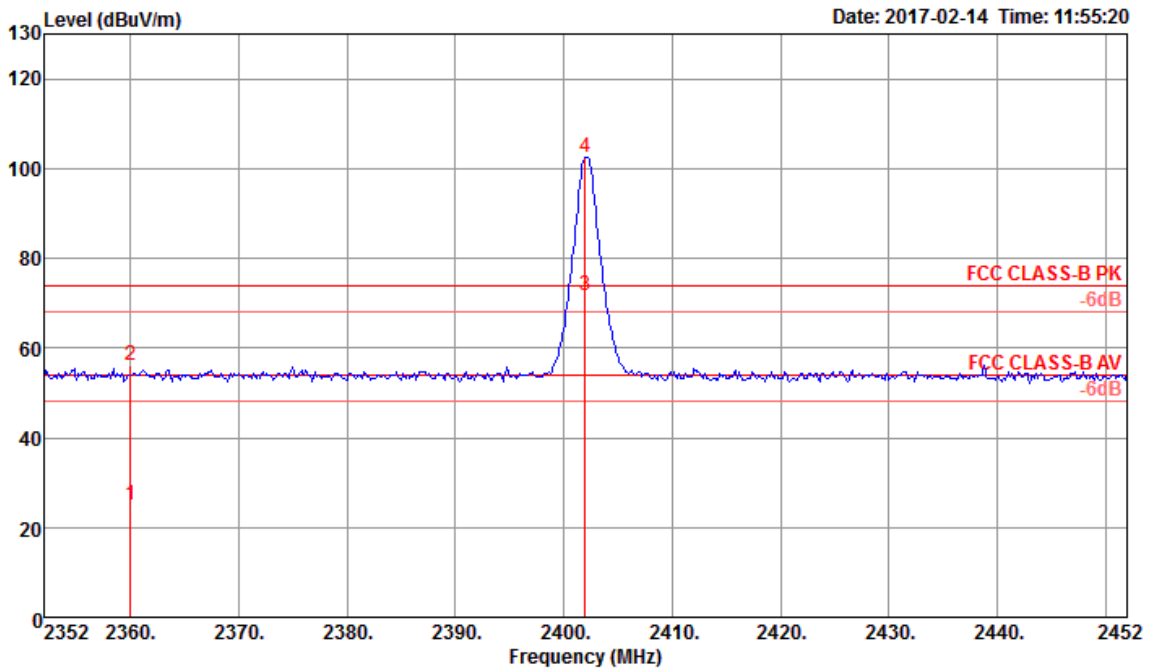

	Freq	Level	Limit Line	Over Limit	Read Level	Cable Loss	Antenna Factor	Preamp Factor	A/Pos	T/Pos	Remark	Pol/Phase
	MHz	dBuV/m	dBuV/m	dB	dBuV	dB	dB/m	dB	cm	deg		
1	2360.00	25.15	54.00	-28.85	-6.59	3.68	28.06	0.00	278	160	Average	VERTICAL
2	2360.00	55.96	74.00	-18.04	24.22	3.68	28.06	0.00	278	160	Peak	VERTICAL
3 @	2402.00	71.72			40.03	3.71	27.98	0.00	278	160	Average	VERTICAL
4 @	2402.00	102.53			70.84	3.71	27.98	0.00	278	160	Peak	VERTICAL

Item 3, 4 are the fundamental frequency at 2402 MHz.



Channel 38

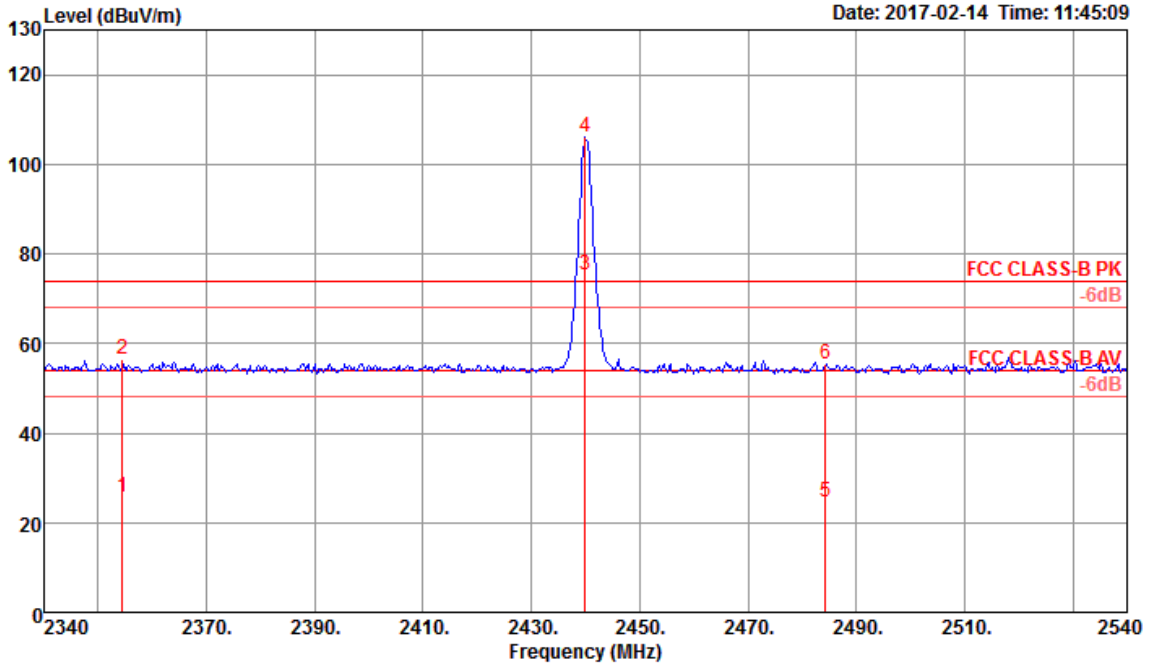

	Freq	Level	Limit Line	Over Limit	Read Level	Cable Loss	Antenna Factor	Preamp Factor	A/Pos	T/Pos	Remark	PoI/Phase
	MHz	dBuV/m	dBuV/m	dB	dBuV	dB	dB/m	dB	cm	deg		
1	2354.40	25.59	54.00	-28.41	-6.15	3.67	28.07	0.00	297	162	Average	VERTICAL
2	2354.40	56.40	74.00	-17.60	24.66	3.67	28.07	0.00	297	162	Peak	VERTICAL
3 @	2440.00	75.14			43.50	3.74	27.90	0.00	297	162	Average	VERTICAL
4 @	2440.00	105.95			74.31	3.74	27.90	0.00	297	162	Peak	VERTICAL
5	2484.30	24.73	54.00	-29.27	-6.87	3.77	27.83	0.00	297	162	Average	VERTICAL
6	2484.30	55.54	74.00	-18.46	23.94	3.77	27.83	0.00	297	162	Peak	VERTICAL

Item 3, 4 are the fundamental frequency at 2440 MHz.



Channel 78

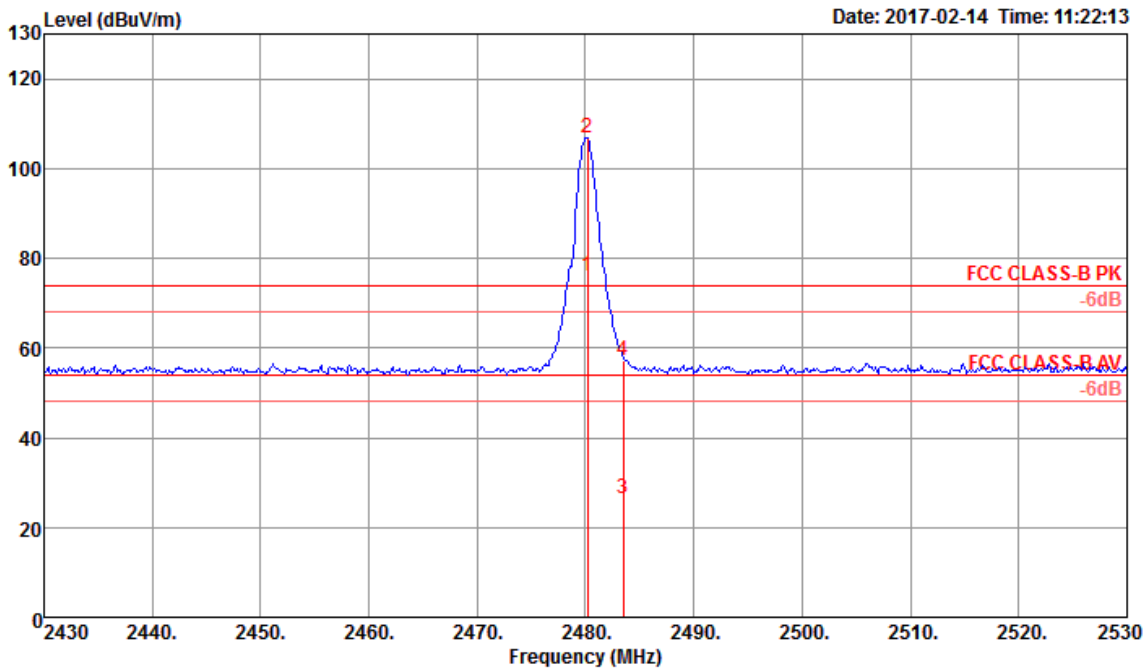

	Freq	Level	Limit	Over	Read	CableAntenna	Preamp	A/Pos	T/Pos	Remark	PoI/Phase
	MHz	dBuV/m	dBuV/m	dB	dBuV	dB	dB/m	dB	cm	deg	
1 @	2480.20	75.95			44.34	3.77	27.84	0.00	284	162 Average	VERTICAL
2 @	2480.20	106.76			75.15	3.77	27.84	0.00	284	162 Peak	VERTICAL
3	2483.50	26.34	54.00	-27.66	-5.26	3.77	27.83	0.00	284	162 Average	VERTICAL
4	2483.50	57.15	74.00	-16.85	25.55	3.77	27.83	0.00	284	162 Peak	VERTICAL

Item 1, 2 are the fundamental frequency at 2480 MHz.

Note:

Emission level (dBuV/m) = 20 log Emission level (uV/m).

Corrected Reading: Antenna Factor + Cable Loss + Read Level - Preamp Factor = Level.



Configurations	EDR (8DPSK) CH 0, 38, 78 / Chain 5
-----------------------	------------------------------------

Channel 0

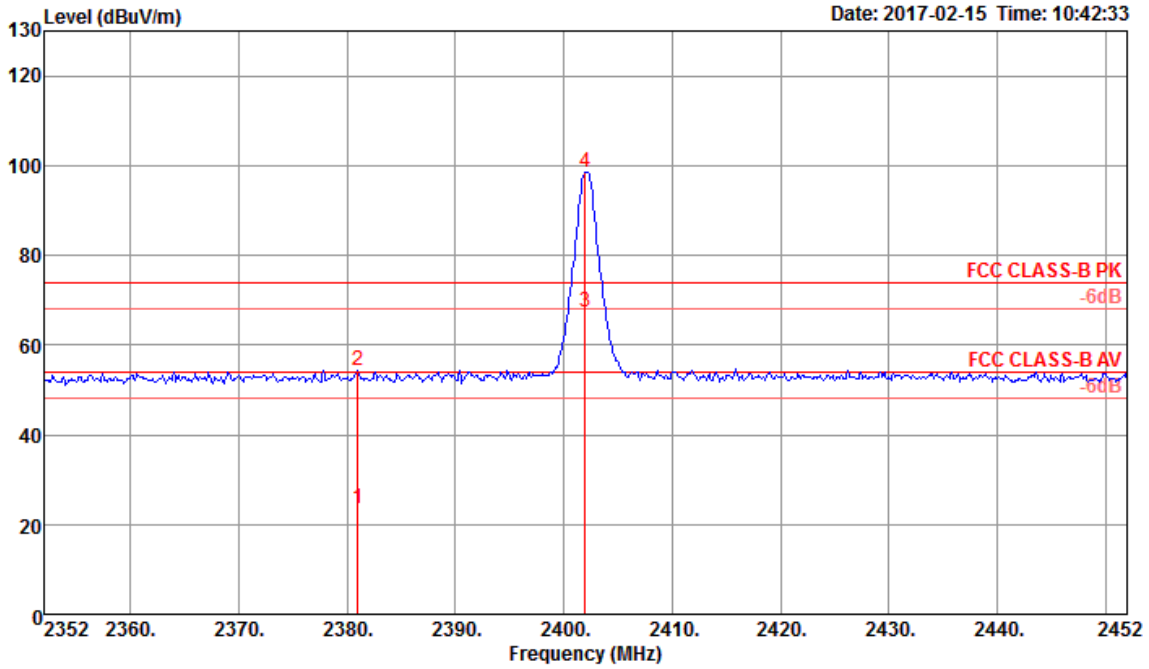

	Freq	Level	Limit Line	Over Limit	Read Level	CableAntenna Loss	Preamp Factor	A/Pos	T/Pos	Remark	Pol/Phase
	MHz	dBuV/m	dBuV/m	dB	dBuV	dB	dB/m	dB	cm	deg	
1	2381.00	23.40	54.00	-30.60	-7.65	3.03	28.02	0.00	150	52 Average	HORIZONTAL
2	2381.00	54.46	74.00	-19.54	23.41	3.03	28.02	0.00	150	52 Peak	HORIZONTAL
3 @	2402.00	67.52			36.50	3.04	27.98	0.00	150	52 Average	HORIZONTAL
4 @	2402.00	98.58			67.56	3.04	27.98	0.00	150	52 Peak	HORIZONTAL

Item 3, 4 are the fundamental frequency at 2402 MHz.



Channel 38

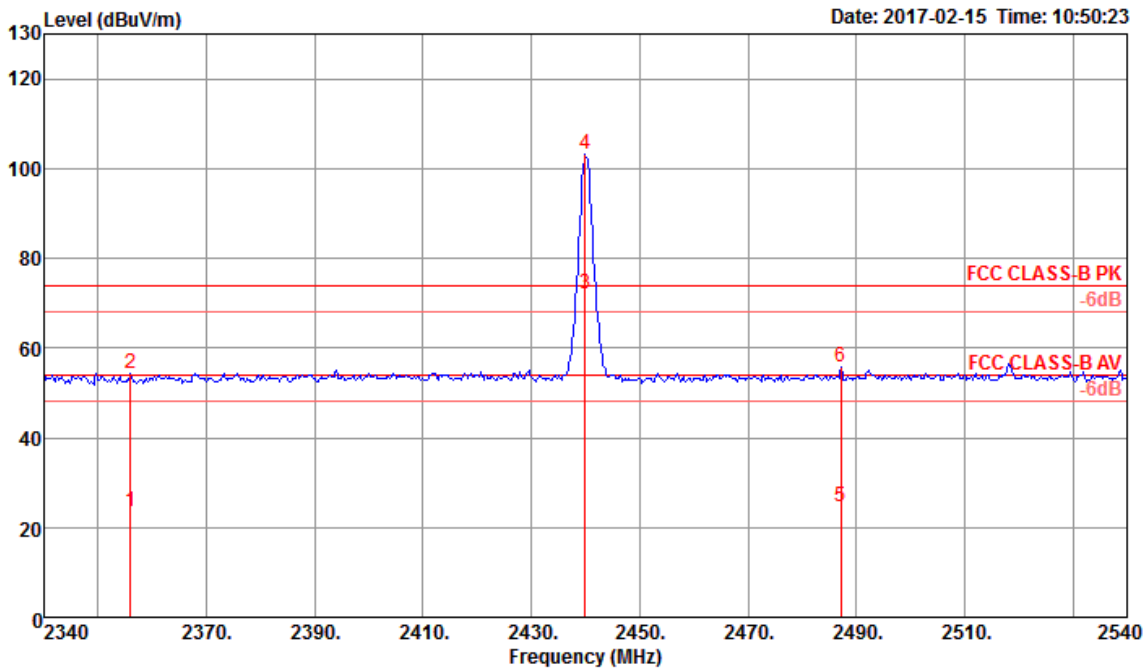

	Freq	Level	Limit Line	Over Limit	Read Level	CableAntenna Loss	Preamp Factor	A/Pos	T/Pos	Remark	Pol/Phase
	MHz	dBuV/m	dBuV/m	dB	dBuV	dB	dB/m	dB	cm	deg	
1	2356.00	23.36	54.00	-30.64	-7.72	3.01	28.07	0.00	270	277 Average	VERTICAL
2	2356.00	54.42	74.00	-19.58	23.34	3.01	28.07	0.00	270	277 Peak	VERTICAL
3 @	2440.00	72.02			41.05	3.07	27.90	0.00	270	277 Average	VERTICAL
4 @	2440.00	103.08			72.11	3.07	27.90	0.00	270	277 Peak	VERTICAL
5	2487.20	24.56	54.00	-29.44	-6.36	3.09	27.83	0.00	270	277 Average	VERTICAL
6	2487.20	55.62	74.00	-18.38	24.70	3.09	27.83	0.00	270	277 Peak	VERTICAL

Item 3, 4 are the fundamental frequency at 2440 MHz.



Channel 78

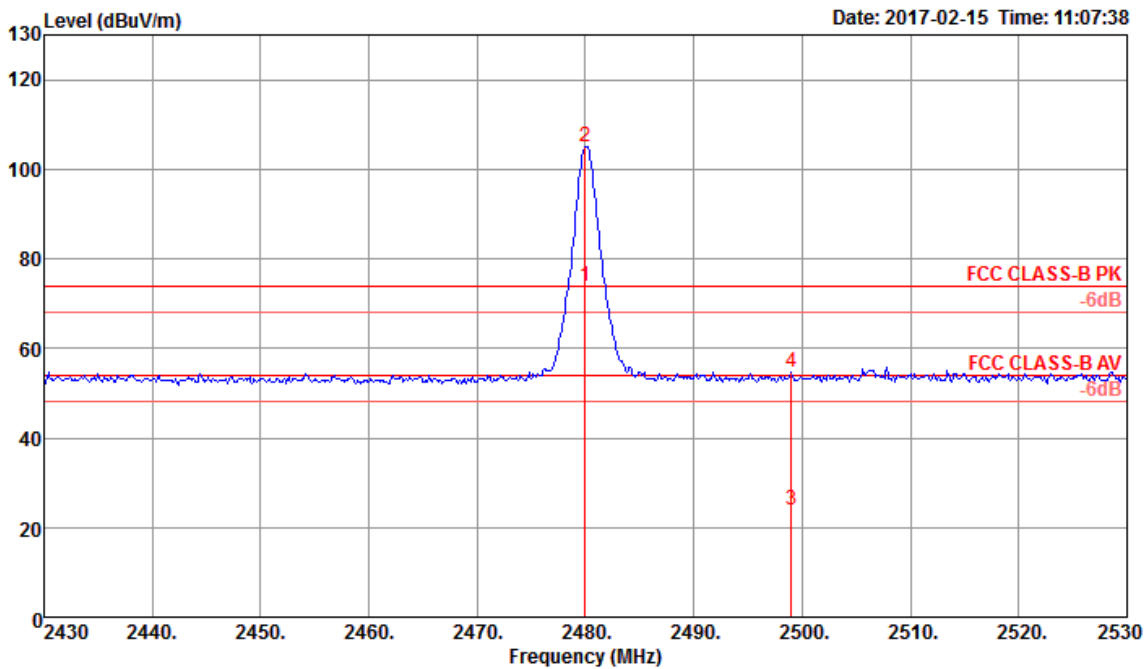

	Freq	Level	Limit Line	Over Limit	Read Level	CableAntenna Loss	Preamp Factor	A/Pos	T/Pos	Remark	Pol/Phase
	MHz	dBuV/m	dBuV/m	dB	dBuV	dB	dB/m	dB	cm	deg	
1 @	2480.00	74.04			43.11	3.09	27.84	0.00	269	277 Average	VERTICAL
2 @	2480.00	105.10			74.17	3.09	27.84	0.00	269	277 Peak	VERTICAL
3	2499.00	23.76	54.00	-30.24	-7.14	3.10	27.80	0.00	269	277 Average	VERTICAL
4	2499.00	54.82	74.00	-19.18	23.92	3.10	27.80	0.00	269	277 Peak	VERTICAL

Item 1, 2 are the fundamental frequency at 2480 MHz.

Note:

Emission level (dBuV/m) = 20 log Emission level (uV/m).

Corrected Reading: Antenna Factor + Cable Loss + Read Level - Preamp Factor = Level.



RSE Co-location Result

