



Bluetooth Radio FCC Test Report

Equipment : Norton Core Secure WiFi Router
Brand Name : Norton Core
Model No. : 517
FCC ID : 2A16F-517
Standard : 47 CFR FCC Part 15.247
Frequency : 2400 MHz – 2483.5 MHz
Function : Point-to-multipoint; Point-to-point
Applicant : Symantec Corporation
350 Ellis Street Mountain View, CA 94043 United States
Manufacturer : CyberTAN Technology Inc.
No. 99, Park Avenue III, Science-based Industrial Park, Hsinchu, 308 Taiwan

The product sample received on Aug. 18, 2016 and completely tested on Mar. 14, 2017. We, SPORTON, would like to declare that the tested sample has been evaluated in accordance with the procedures given in ANSI C63.10-2013 and shown compliance with the applicable technical standards.

The test results in this report apply exclusively to the tested model / sample. Without written approval of SPORTON INTERNATIONAL INC., the test report shall not be reproduced except in full.

Cliff Chang
SPORTON INTERNATIONAL INC.





Table of Contents

1	GENERAL DESCRIPTION	5
1.1	Information.....	5
1.2	Testing Applied Standards	7
1.3	Testing Location Information	7
1.4	Measurement Uncertainty	8
2	TEST CONFIGURATION OF EUT	9
2.1	Test Channel Mode.....	9
2.2	The Worst Case Measurement Configuration.....	10
2.3	EUT Operation during Test	10
2.4	Accessories	11
2.5	Support Equipment.....	11
2.6	Test Setup Diagram	12
3	TRANSMITTER TEST RESULT	15
3.1	AC Power-line Conducted Emissions	15
3.2	DTS Bandwidth	17
3.3	Maximum Conducted Output Power	18
3.4	Power Spectral Density	20
3.5	Emissions in Non-restricted Frequency Bands	22
3.6	Emissions in Restricted Frequency Bands.....	23
4	TEST EQUIPMENT AND CALIBRATION DATA	27

APPENDIX A. TEST RESULTS OF AC POWER-LINE CONDUCTED EMISSIONS

APPENDIX B. TEST RESULTS OF DTS BANDWIDTH

APPENDIX C. TEST RESULTS OF MAXIMUM CONDUCTED OUTPUT POWER

APPENDIX D. TEST RESULTS OF POWER SPECTRAL DENSITY

APPENDIX E. TEST RESULTS OF EMISSIONS IN NON-RESTRICTED FREQUENCY BANDS

APPENDIX F. TEST RESULTS OF EMISSIONS IN RESTRICTED FREQUENCY BANDS

APPENDIX G. TEST RESULTS OF RADIATED EMISSION CO-LOCATION

APPENDIX H. TEST PHOTOS

PHOTOGRAPHS OF EUT V01



Summary of Test Result

Conformance Test Specifications				
Report Clause	Ref. Std. Clause	Description	Limit	Result
1.1.2	15.203	Antenna Requirement	FCC 15.203	Complied
3.1	15.207	AC Power-line Conducted Emissions	FCC 15.207	Complied
3.2	15.247(a)	DTS Bandwidth	≥500kHz	Complied
3.3	15.247(b)	Maximum Conducted Output Power	Power [dBm]:30	Complied
3.4	15.247(e)	Power Spectral Density	PSD [dBm/3kHz]:8	Complied
3.5	15.247(d)	Emissions in Non-restricted Frequency Bands	Non-Restricted Bands: >30 dBc	Complied
3.6	15.247(d)	Emissions in Restricted Frequency Bands	Restricted Bands: FCC 15.209	Complied



Revision History

Report No.	Version	Description	Issued Date
FR681620AD	Rev. 01	Initial issue of report	Mar. 31, 2017



1 General Description

1.1 Information

1.1.1 RF General Information

Frequency Range (MHz)	Bluetooth Mode	Ch. Frequency (MHz)	Channel Number
2400-2483.5	LE	2402-2480	0-39 [40]

Band	Mode	BWch (MHz)	Nant
2.4-2.4835GHz	BT-LE(1Mbps)	1	1

Note:

- ♦ 2.4G is the 2.4GHz Band (2.4-2.4835GHz).
- ♦ Bluetooth LE uses a GFSK (1Mbps) modulation for DSSS.
- ♦ BWch is the channel separation
- ♦ Nss-Min is the minimum number of spatial streams.
- ♦ Nant is the number of outputs. e.g., 2(2, 3) means have 2 outputs for port 2 and port 3. 2 means have 2 outputs for port 1 and port 2.

1.1.2 Antenna Information

Ant.	Brand	Model Name P/N	Antenna Type	Connector	Gain (dBi)			
					2.4GHz	5GHz B1	5GHz B4	BT
1	Airgain	M2410DCR-UV-G1XST125BU	Dual-band Dipole	I-PEX	1.5	2.3	3.3	-
2	Airgain	M2410DCR-UV-B1XST135BU	Dual-band Dipole	I-PEX	1.5	2.3	3.3	-
3	Airgain	M2410DCR-UV-A1XST115BU	Dual-band Dipole	I-PEX	1.5	2.3	3.3	-
4	Airgain	M2410DCR-UV-G1XST125BU	Dual-band Dipole	I-PEX	1.5	2.3	3.3	-
5	PSA	RFMTA271200NNAB003	PIFA Antenna	N/A	-	-	-	2.54

Note: The EUT has five antennas.

Ant.1 = Chain 1(port 1), Ant.2 = Chain 2(port 2), Ant.3 = Chain 3(port 3), Ant.4 = Chain 4(port 4), Ant.5= Chain 5(port 1).

For WLAN function (4TX, 4RX):

Chain 1 ~ Chain 4 can be used as transmitting/receiving antenna.

Chain 1 ~ Chain 4 could transmit/receive simultaneously.

For Bluetooth function (1TX, 1RX):

Only Chain 5 can be used as transmitting/receiving functions.



1.1.3 Mode Test Duty Cycle

Mode	DC	DCF(dB)
BT-LE(1Mbps)	0.62	2.076

1.1.4 EUT Operational Condition

EUT Power Type	From Power Adapter
-----------------------	--------------------

1.1.5 Table for Multiple Listing

The EUT has two exterior which are identical to each other in all aspects except for the following table:

Brand Name	Model Name	EUT	Color
Norton Core	517	1	Granite Gray
		2	Titanium Gold



1.2 Testing Applied Standards

According to the specifications of the manufacturer, the EUT must comply with the requirements of the following standards:

- ◆ 47 CFR FCC Part 15
- ◆ ANSI C63.10-2013
- ◆ FCC KDB 558074 D01 v03r05
- ◆ FCC KDB 412172 D01 v01r01

1.3 Testing Location Information

Testing Location		
<input type="checkbox"/>	HWA YA	ADD : No. 52, Hwa Ya 1st Rd., Kwei-Shan Hsiang, Tao Yuan Hsien, Taiwan, R.O.C. TEL : 886-3-327-3456 FAX : 886-3-318-0055
<input checked="" type="checkbox"/>	JHUBEI	ADD : No.8, Lane 724, Bo-ai St., Jhubei City, HsinChu County 302, Taiwan, R.O.C. TEL : 886-3-656-9065 FAX : 886-3-656-9085

Test Condition	Test Site No.	Test Engineer	Test Environment	Test Date
RF Conducted	TH01-CB	Serway Li	20°C / 60%	Mar. 07, 2017 Mar. 08, 2017
Radiated	03CH01-CB	Zero Chen, Nyle, Chang, Justin Lin	22°C / 54%	Dec. 26, 2016 Mar. 14, 2017
AC Conduction	CO01-CB	Ryo Fan	23°C / 61%	Dec. 28, 2016

Test site Designation No. TW0006 with FCC.

Test site registered number IC 4086D with Industry Canada.



1.4 Measurement Uncertainty

ISO/IEC 17025 requires that an estimate of the measurement uncertainties associated with the emissions test results be included in the report. The measurement uncertainties given below are based on a 95% confidence level (based on a coverage factor (k=2))

Test Items	Uncertainty	Remark
Conducted Emission (150kHz ~ 30MHz)	3.2 dB	Confidence levels of 95%
Radiated Emission (30MHz ~ 1,000MHz)	3.6 dB	Confidence levels of 95%
Radiated Emission (1GHz ~ 18GHz)	3.7 dB	Confidence levels of 95%
Radiated Emission (18GHz ~ 40GHz)	3.5 dB	Confidence levels of 95%
Conducted Emission	1.7 dB	Confidence levels of 95%
Output Power Measurement	1.33 dB	Confidence levels of 95%
Power Density Measurement	1.27 dB	Confidence levels of 95%
Bandwidth Measurement	9.74×10^{-8}	Confidence levels of 95%



2 Test Configuration of EUT

2.1 Test Channel Mode

Mode	Power Setting
BT-LE(1Mbps)	-
2402MHz	0
2440MHz	0
2480MHz	0



2.2 The Worst Case Measurement Configuration

The Worst Case Mode for Following Conformance Tests	
Tests Item	AC power-line conducted emissions
Condition	AC power-line conducted measurement for line and neutral
Operating Mode	Normal Link

The Worst Case Mode for Following Conformance Tests	
Tests Item	DTS Bandwidth Maximum Conducted Output Power Power Spectral Density Emissions in Non-restricted Frequency Bands
Test Condition	Conducted measurement at transmit chains

The Worst Case Mode for Following Conformance Tests	
Tests Item	Emissions in Restricted Frequency Bands
Test Condition	Radiated measurement If EUT consist of multiple antenna assembly (multiple antenna are used in EUT regardless of spatial multiplexing MIMO configuration), the radiated test should be performed with highest antenna gain of each antenna type.
Operating Mode < 1GHz	Normal Link
Operating Mode > 1GHz	CTX

The Worst Case Mode for Following Conformance Tests	
Tests Item	Simultaneous Transmission Analysis - Co-location RF Exposure Evaluation
Operating Mode	
1	Bluetooth+WLAN 2.4GHz +WLAN 5GHz
Refer to Sporton Test Report No.: FA681620 for Co-location RF Exposure Evaluation.	

Note: 1. The EUT can only be used at Z axis position.

2.3 EUT Operation during Test

For CTX Mode:

The EUT was programmed to be in continuously transmitting mode.

For Normal Link:

During the test, the EUT operation to normal function.



2.4 Accessories

Accessories			
Equipment Name	Brand Name	Model Name	Rating
Adapter	Delta	ADP-360DW B2A	Input: 100-120V ~ 60Hz 0.9A Output: 12V, 3.0A
RJ-45 cable*1: Non-shielded 1.8m			

2.5 Support Equipment

For Test Site No: CO01-CB

Support Equipment				
No.	Equipment	Brand Name	Model Name	FCC ID
1	NB*4	DELL	E6430	DoC
2	iPhone 4	Apple	A1332	BCG-E2380a
3	Flash Disk3.0*2	ADATA	C103	DoC

For Test Site No: 03CH01-CB (below 1GHz)

Support Equipment				
No.	Equipment	Brand Name	Model Name	FCC ID
1	NB*2	DELL	E4300	DoC
2	NB*2	Apple	Mac Book	DoC
3	iPhone 4	Apple	A1332	BCG-E2380a
4	Flash Disk3.0*2	Silicon Power	B06	DoC

For Test Site No: 03CH01-CB (above 1GHz)

Support Equipment				
No.	Equipment	Brand Name	Model Name	FCC ID
1	NB	DELL	E4300	DoC

For Test Site No: TH01-CB

Support Equipment				
No.	Equipment	Brand Name	Model Name	FCC ID
1	NB	DELL	E4300	DoC

2.6 Test Setup Diagram

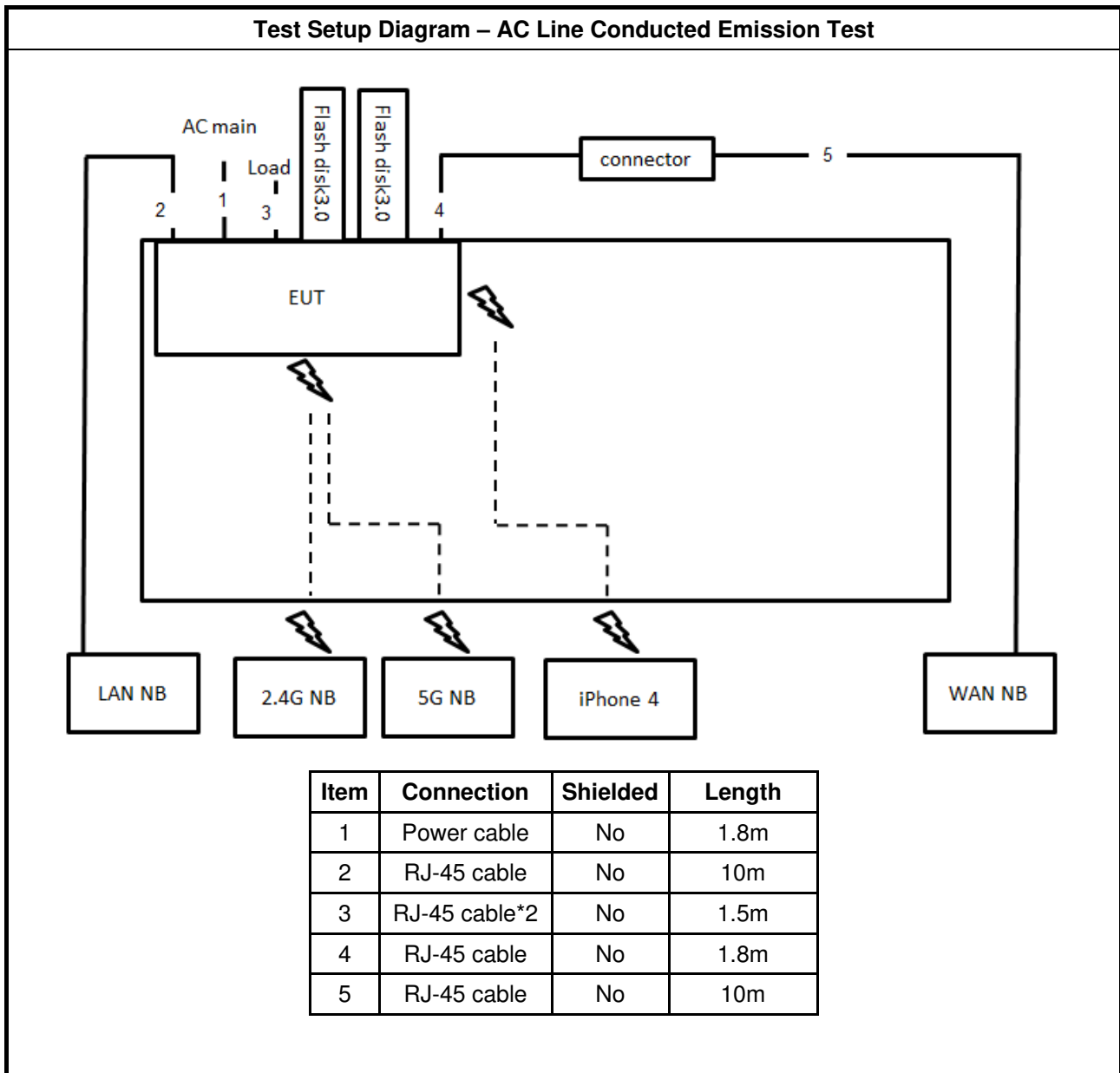

Test Setup Diagram - Radiated Test < 1GHz

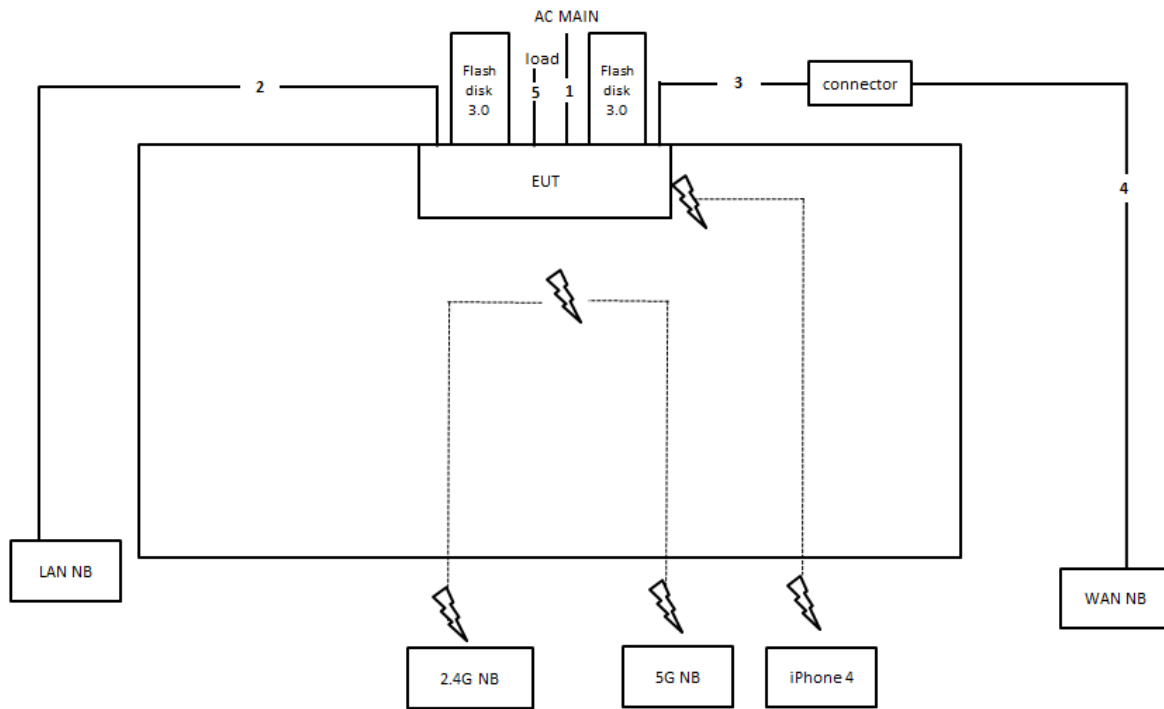

Item	Connection	Shielded	Length
1	Power cable	No	1.8m
2	RJ-45 cable	No	10m
3	RJ-45 cable	No	1.8m
4	RJ-45 cable	No	10m
5	RJ-45 cable*2	No	1m

Test Setup Diagram - Radiated Test > 1GHz

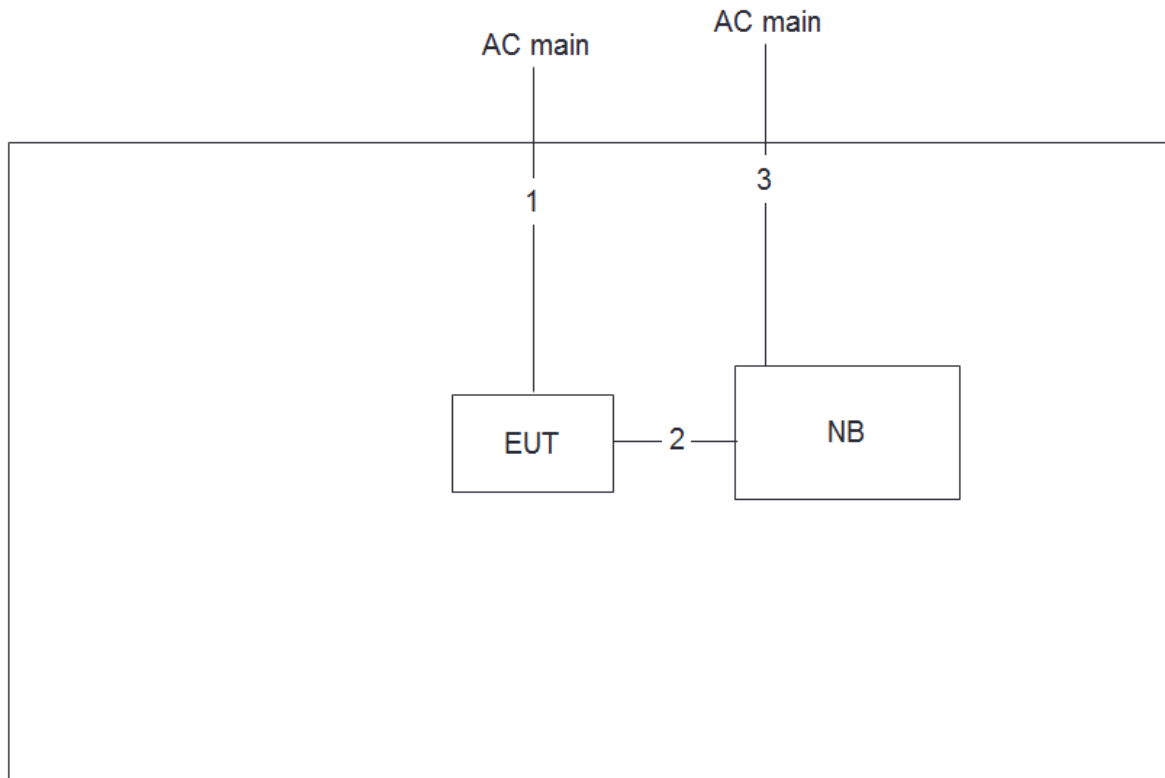

Item	Connection	Shielded	Length
1	Power cable	No	1.8m
2	Console Cable	No	1.97m
3	Power cable	No	2.6m

3 Transmitter Test Result

3.1 AC Power-line Conducted Emissions

3.1.1 AC Power-line Conducted Emissions Limit

AC Power-line Conducted Emissions Limit		
Frequency Emission (MHz)	Quasi-Peak	Average
0.15-0.5	66 - 56 *	56 - 46 *
0.5-5	56	46
5-30	60	50

Note 1: * Decreases with the logarithm of the frequency.

3.1.2 Measuring Instruments

Refer a test equipment and calibration data table in this test report.

3.1.3 Test Procedures

Test Method
<ul style="list-style-type: none"> Refer as ANSI C63.10-2013, clause 6.2 foray power-line conducted emissions.

3.1.4 Test Setup

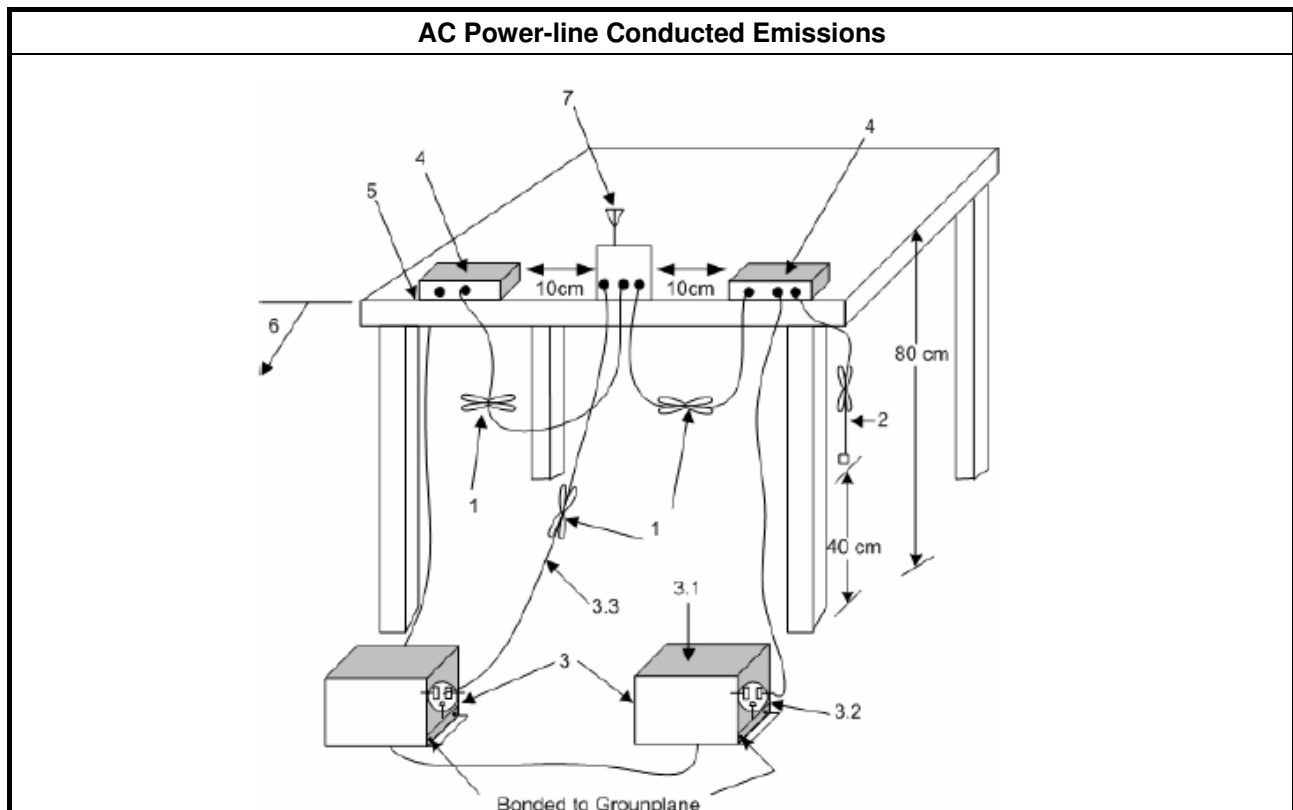



3.1.5 Test Result of AC Power-line Conducted Emissions

Refer as Appendix A

3.2 DTS Bandwidth

3.2.1 6dB Bandwidth Limit

6dB Bandwidth Limit
Systems using digital modulation techniques:
<ul style="list-style-type: none"> ▪ 6 dB bandwidth \geq 500 kHz.

3.2.2 Measuring Instruments

Refer a test equipment and calibration data table in this test report.

3.2.3 Test Procedures

Test Method
<ul style="list-style-type: none"> ▪ For the emission bandwidth shall be measured using one of the options below:
<input checked="" type="checkbox"/> Refer as FCC KDB 558074, clause 8.1 Option 1 for 6 dB bandwidth measurement.
<input type="checkbox"/> Refer as FCC KDB 558074, clause 8.2 Option 2 for 6 dB bandwidth measurement.
<input type="checkbox"/> Refer as ANSI C63.10, clause 6.9.1 for occupied bandwidth testing.

3.2.4 Test Setup

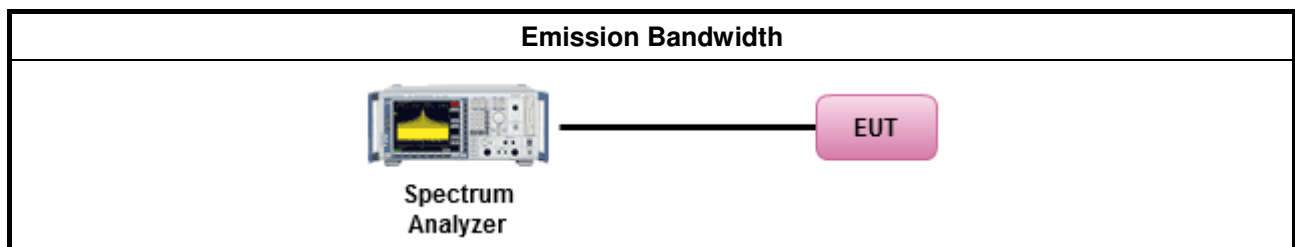

3.2.5 Test Result of Emission Bandwidth

Refer as Appendix B



3.3 Maximum Conducted Output Power

3.3.1 Maximum Conducted Output Power Limit

Maximum Conducted Output Power Limit	
	▪ If $G_{TX} \leq 6$ dBi, then $P_{Out} \leq 30$ dBm (1 W)
	▪ Point-to-multipoint systems (P2M): If $G_{TX} > 6$ dBi, then $P_{Out} = 30 - (G_{TX} - 6)$ dBm
	▪ Point-to-point systems (P2P): If $G_{TX} > 6$ dBi, then $P_{Out} = 30 - (G_{TX} - 6)/3$ dBm
	▪ Smart antenna system (SAS):
	- Single beam: If $G_{TX} > 6$ dBi, then $P_{Out} = 30 - (G_{TX} - 6)/3$ dBm
	- Overlap beam: If $G_{TX} > 6$ dBi, then $P_{Out} = 30 - (G_{TX} - 6)/3$ dBm
	- Aggregate power on all beams: If $G_{TX} > 6$ dBi, then $P_{Out} = 30 - (G_{TX} - 6)/3 + 8$ dB dBm
P_{Out} = maximum peak conducted output power or maximum conducted output power in dBm, G_{TX} = the maximum transmitting antenna directional gain in dBi.	

3.3.2 Measuring Instruments

Refer a test equipment and calibration data table in this test report.

3.3.3 Test Procedures

Test Method	
<ul style="list-style-type: none"> ▪ Maximum Peak Conducted Output Power 	
<input type="checkbox"/>	Refer as FCC KDB 558074, clause 9.1.1 Option 1 (RBW ≥ EBW method).
<input type="checkbox"/>	Refer as FCC KDB 558074, clause 9.1.2 Option 2 (peak power meter for VBW ≥ DTS BW)
<ul style="list-style-type: none"> ▪ Maximum Conducted Output Power 	
[duty cycle ≥ 98% or external video / power trigger]	
<input type="checkbox"/>	Refer as FCC KDB 558074, clause 9.2.2.2 Method AVGSA-1 (spectral trace averaging).
<input type="checkbox"/>	Refer as FCC KDB 558074, clause 9.2.2.3 Method AVGSA-1 Alt. (slow sweep speed)
duty cycle < 98% and average over on/off periods with duty factor	
<input type="checkbox"/>	Refer as FCC KDB 558074, clause 9.2.2.4 Method AVGSA-2 (spectral trace averaging).
<input type="checkbox"/>	Refer as FCC KDB 558074, clause 9.2.2.5 Method AVGSA-2 Alt. (slow sweep speed)
RF power meter and average over on/off periods with duty factor or gated trigger	
<input checked="" type="checkbox"/>	Refer as FCC KDB 558074, clause 9.2.3 Method AVGPM-G (using an RF average power meter).
<ul style="list-style-type: none"> ▪ For conducted measurement. 	
<ul style="list-style-type: none"> ▪ If the EUT supports multiple transmit chains using options given below: Refer as FCC KDB 662911, In-band power measurements. Using the measure-and-sum approach, measured all transmit ports individually. Sum the power (in linear power units e.g., mW) of all ports for each individual sample and save them. 	
<ul style="list-style-type: none"> ▪ If multiple transmit chains, EIRP calculation could be following as methods: $P_{total} = P_1 + P_2 + \dots + P_n$ (calculated in linear unit [mW] and transfer to log unit [dBm]) $EIRP_{total} = P_{total} + DG$ 	

3.3.4 Test Setup

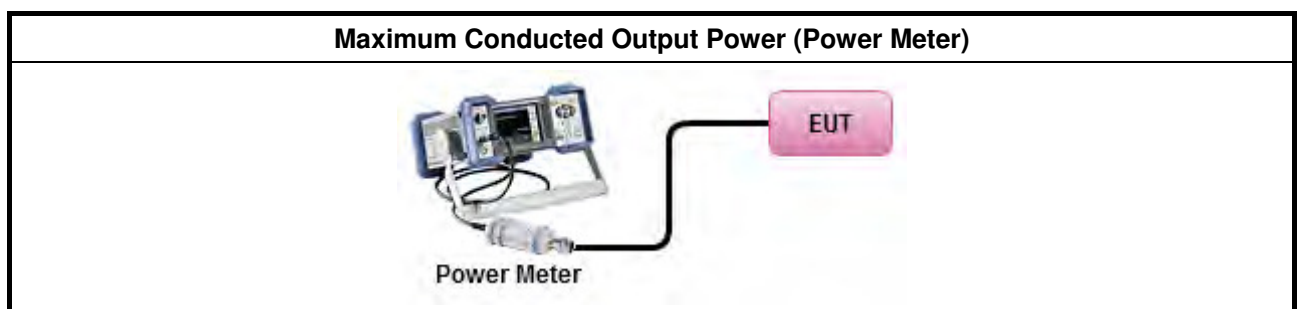

3.3.5 Test Result of Maximum Conducted Output Power

Refer as Appendix C

3.4 Power Spectral Density

3.4.1 Power Spectral Density Limit

Power Spectral Density Limit
<ul style="list-style-type: none"> ▪ Power Spectral Density (PSD) ≤ 8 dBm/3kHz

3.4.2 Measuring Instruments

Refer a test equipment and calibration data table in this test report.

3.4.3 Test Procedures

Test Method
<ul style="list-style-type: none"> ▪ Peak power spectral density procedures that the same method as used to determine the conducted output power. If maximum peak conducted output power was measured to demonstrate compliance to the output power limit, then the peak PSD procedure below (Method PKPSD) shall be used. If maximum conducted output power was measured to demonstrate compliance to the output power limit, then one of the average PSD procedures shall be used, as applicable based on the following criteria (the peak PSD procedure is also an acceptable option).
<input checked="" type="checkbox"/> Refer as FCC KDB 558074, clause 10.2 Method PKPSD (RBW=3-100kHz; Detector=peak). [duty cycle ≥ 98% or external video / power trigger]
<input type="checkbox"/> Refer as FCC KDB 558074, clause 10.3 Method AVGPSD-1 (spectral trace averaging).
<input type="checkbox"/> Refer as FCC KDB 558074, clause 10.4 Method AVGPSD-2 (slow sweep speed) duty cycle < 98% and average over on/off periods with duty factor
<input type="checkbox"/> Refer as FCC KDB 558074, clause 10.5 Method AVGPSD-1 Alt (spectral trace averaging).
<input type="checkbox"/> Refer as FCC KDB 558074, clause 10.6 Method AVGPSD-2 Alt. (slow sweep speed)
<ul style="list-style-type: none"> ▪ For conducted measurement.
<ul style="list-style-type: none"> ▪ If The EUT supports multiple transmit chains using options given below: <ul style="list-style-type: none"> <input checked="" type="checkbox"/> Option 1: Measure and sum the spectra across the outputs. Refer as FCC KDB 662911, In-band power spectral density (PSD). Sample all transmit ports simultaneously using a spectrum analyzer for each transmit port. Where the trace bin-by-bin of each transmit port summing can be performed. (i.e., in the first spectral bin of output 1 is summed with that in the first spectral bin of output 2 and that from the first spectral bin of output 3, and so on up to the NTX output to obtain the value for the first frequency bin of the summed spectrum.). Add up the amplitude (power) values for the different transmit chains and use this as the new data trace. <input type="checkbox"/> Option 2: Measure and sum spectral maxima across the outputs. With this technique, spectra are measured at each output of the device at the required resolution bandwidth. The maximum value (peak) of each spectrum is determined. These maximum values are then summed mathematically in linear power units across the outputs. These operations shall be performed separately over frequency spans that have different out-of-band or spurious emission limits, <input type="checkbox"/> Option 3: Measure and add 10 log(N) dB, where N is the number of transmit chains. Refer as FCC KDB 662911, In-band power spectral density (PSD). Performed at each transmit chains and each transmit chains shall be compared with the limit have been reduced with 10 log(N). Or each transmit chains shall be add 10 log(N) to compared with the limit.

3.4.4 Test Setup

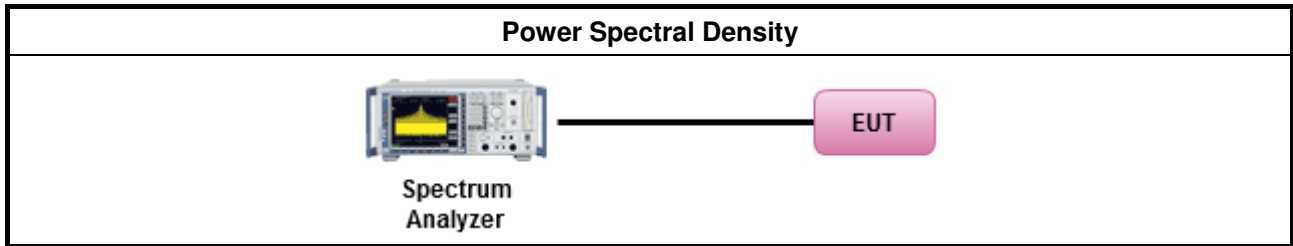

3.4.5 Test Result of Power Spectral Density

Refer as Appendix D

3.5 Emissions in Non-restricted Frequency Bands

3.5.1 Emissions in Non-restricted Frequency Bands Limit

Un-restricted Band Emissions Limit	
RF output power procedure	Limit (dB)
Peak output power procedure	20
Average output power procedure	30

Note 1: If the peak output power procedure is used to measure the fundamental emission power to demonstrate compliance to requirements, then the peak conducted output power measured within any 100 kHz outside the authorized frequency band shall be attenuated by at least 20 dB relative to the maximum measured in-band peak PSD level.

Note 2: If the average output power procedure is used to measure the fundamental emission power to demonstrate compliance to requirements, then the power in any 100 kHz outside of the authorized frequency band shall be attenuated by at least 30 dB relative to the maximum measured in-band average PSD level.

3.5.2 Measuring Instruments

Refer a test equipment and calibration data table in this test report.

3.5.3 Test Procedures

Test Method
<ul style="list-style-type: none"> Refer as FCC KDB 558074, clause 11 for unwanted emissions into non-restricted bands.

3.5.4 Test Setup

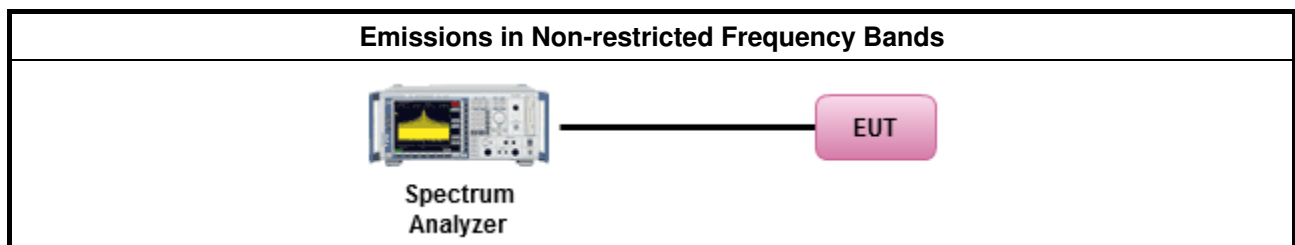

3.5.5 Test Result of Emissions in Non-restricted Frequency Bands

Refer as Appendix E



3.6 Emissions in Restricted Frequency Bands

3.6.1 Emissions in Restricted Frequency Bands Limit

Restricted Band Emissions Limit			
Frequency Range (MHz)	Field Strength (uV/m)	Field Strength (dBuV/m)	Measure Distance (m)
0.009~0.490	2400/F(kHz)	48.5 - 13.8	300
0.490~1.705	24000/F(kHz)	33.8 - 23	30
1.705~30.0	30	29	30
30~88	100	40	3
88~216	150	43.5	3
216~960	200	46	3
Above 960	500	54	3

Note 1: Test distance for frequencies at or above 30 MHz, measurements may be performed at a distance other than the limit distance provided they are not performed in the near field and the emissions to be measured can be detected by the measurement equipment. When performing measurements at a distance other than that specified, the results shall be extrapolated to the specified distance using an extrapolation factor of 20 dB/decade (inverse of linear distance for field-strength measurements, inverse of linear distance-squared for power-density measurements).

Note 2: Test distance for frequencies at below 30 MHz, measurements may be performed at a distance closer than the EUT limit distance; however, an attempt should be made to avoid making measurements in the near field. When performing measurements below 30 MHz at a closer distance than the limit distance, the results shall be extrapolated to the specified distance by either making measurements at a minimum of two or more distances on at least one radial to determine the proper extrapolation factor or by using the square of an inverse linear distance extrapolation factor (40 dB / decade). The test report shall specify the extrapolation method used to determine compliance of the EUT.

3.6.2 Measuring Instruments

Refer a test equipment and calibration data table in this test report.



3.6.3 Test Procedures

Test Method	
<ul style="list-style-type: none"> ▪ The average emission levels shall be measured in [duty cycle \geq 98 or duty factor]. 	
<ul style="list-style-type: none"> ▪ Refer as ANSI C63.10, clause 6.9.2.2 band-edge testing shall be performed at the lowest frequency channel and highest frequency channel within the allowed operating band. 	
<ul style="list-style-type: none"> ▪ For the transmitter unwanted emissions shall be measured using following options below: 	
	<ul style="list-style-type: none"> ▪ Refer as FCC KDB 558074, clause 12 for unwanted emissions into restricted bands.
	<input type="checkbox"/> Refer as FCC KDB 558074, clause 12.2.5.1 Option 1 (trace averaging for duty cycle \geq 98%)
	<input type="checkbox"/> Refer as FCC KDB 558074, clause 12.2.5.2 Option 2 (trace averaging + duty factor).
	<input checked="" type="checkbox"/> Refer as FCC KDB 558074, clause 12.2.5.3 Option 3 (Reduced VBW \geq 1/T).
	<input type="checkbox"/> Refer as ANSI C63.10, clause 4.2.3.2.3 (Reduced VBW). VBW \geq 1/T, where T is pulse time.
	<input type="checkbox"/> Refer as ANSI C63.10, clause 4.2.3.2.4 average value of pulsed emissions.
	<input checked="" type="checkbox"/> Refer as FCC KDB 558074, clause 12.2.4 measurement procedure peak limit.
<ul style="list-style-type: none"> ▪ For the transmitter band-edge emissions shall be measured using following options below: 	
	<ul style="list-style-type: none"> ▪ Refer as FCC KDB 558074 clause 13.1, When the performing peak or average radiated measurements, emissions within 2 MHz of the authorized band edge may be measured using the marker-delta method described below.
	<ul style="list-style-type: none"> ▪ Refer as FCC KDB 558074, clause 13.2 (ANSI C63.10, clause 6.9.3) for marker-delta method for band-edge measurements.
	<ul style="list-style-type: none"> ▪ Refer as FCC KDB 558074, clause 13.3 for narrower resolution bandwidth (100kHz) using the band power and summing the spectral levels (i.e., 1 MHz).
<ul style="list-style-type: none"> ▪ For conducted and cabinet radiation measurement, refer as FCC KDB 558074, clause 12.2.2. 	
	<ul style="list-style-type: none"> ▪ For conducted unwanted emissions into restricted bands (absolute emission limits). Devices with multiple transmit chains using options given below: (1) Measure and sum the spectra across the outputs or (2) Measure and add 10 log(N) dB
	<ul style="list-style-type: none"> ▪ For FCC KDB 662911 The methodology described here may overestimate array gain, thereby resulting in apparent failures to satisfy the out-of-band limits even if the device is actually compliant. In such cases, compliance may be demonstrated by performing radiated tests around the frequencies at which the apparent failures occurred.

3.6.4 Test Setup

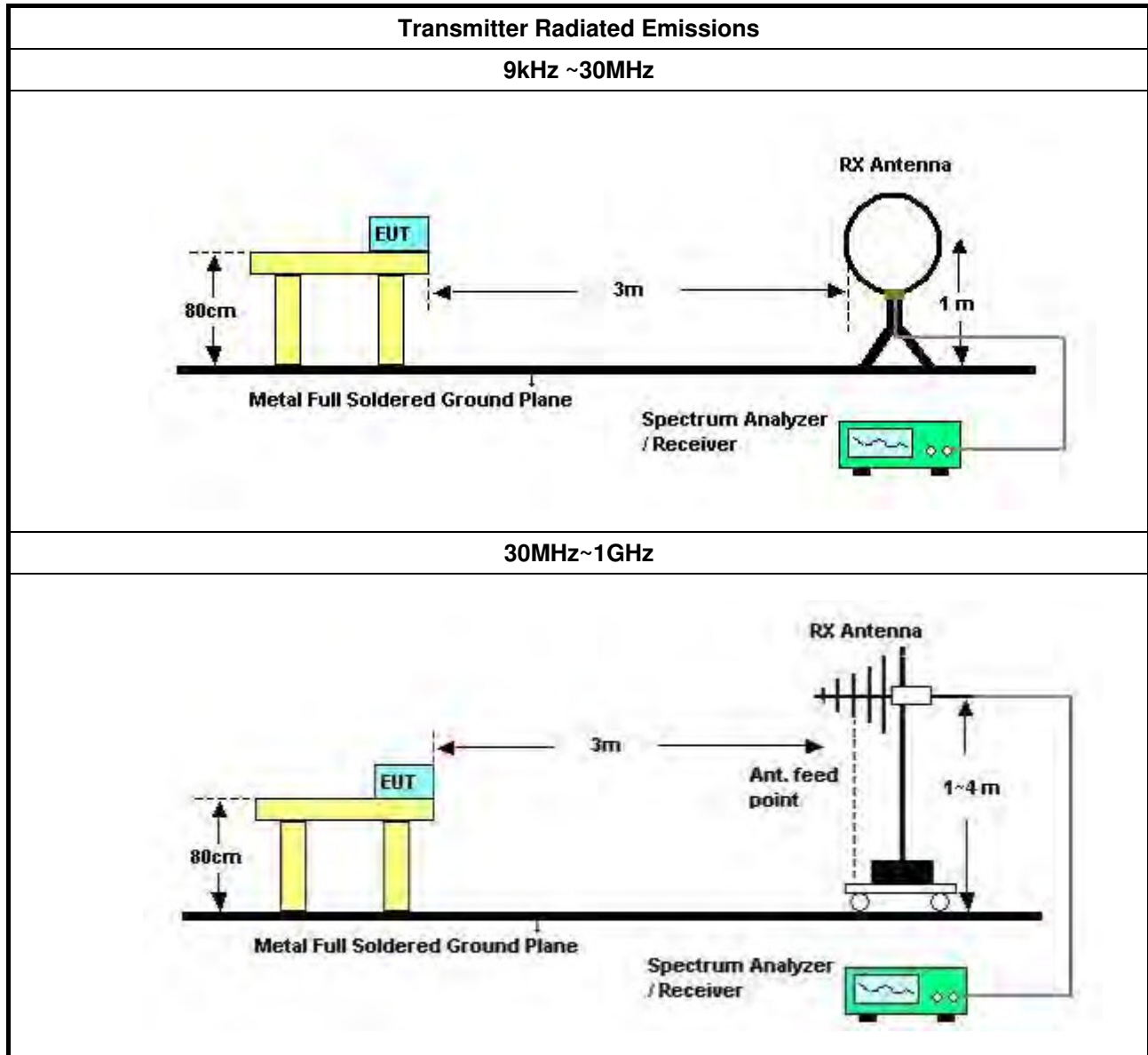

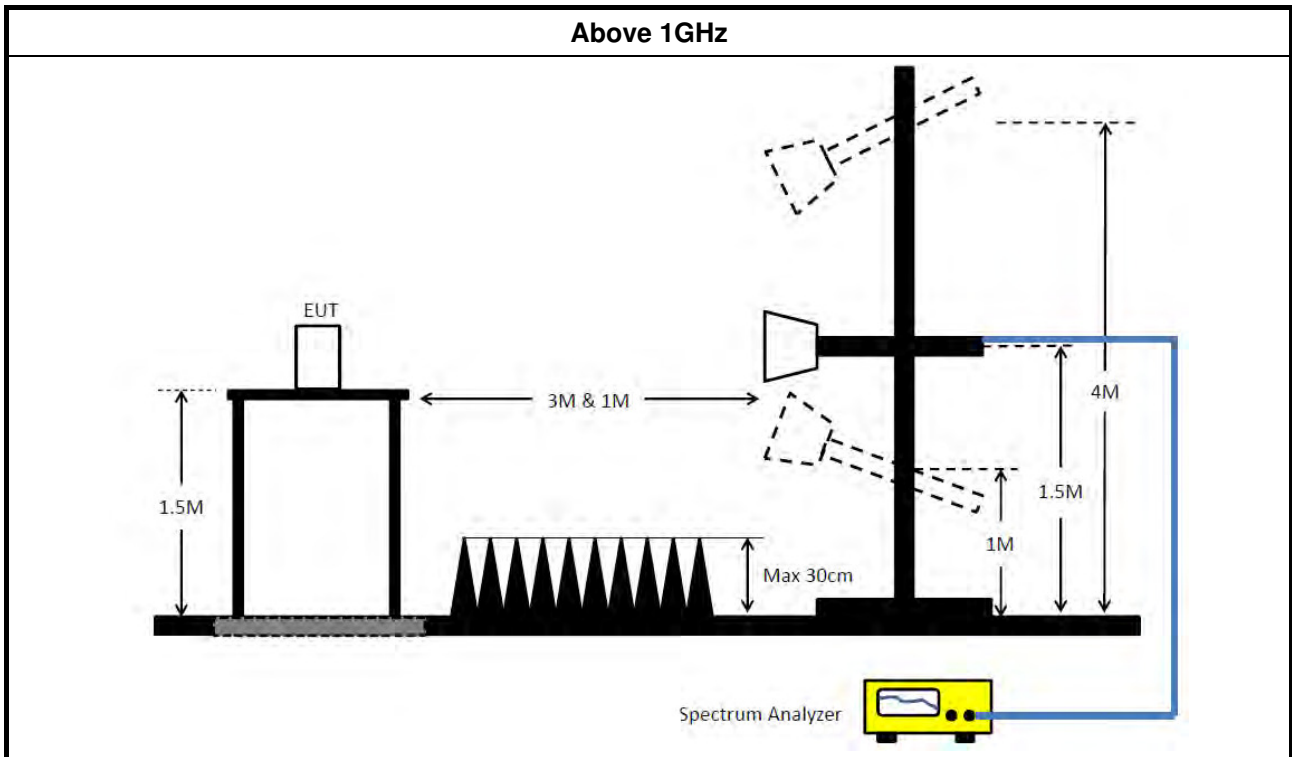

3.6.5 Transmitter Radiated Unwanted Emissions (Below 30MHz)

All amplitude of spurious emissions that are attenuated by more than 20 dB below the permissible value has no need to be reported.

3.6.6 Transmitter Radiated Unwanted Emissions

Refer as Appendix F



4 Test Equipment and Calibration Data

Instrument	Manufacturer	Model No.	Serial No.	Characteristics	Calibration Date	Remark
EMI Receiver	Agilent	N9038A	My52260123	9kHz ~ 8.45GHz	Jan. 27, 2016	Conduction (CO01-CB)
LISN	F.C.C.	FCC-LISN-50-16-2	04083	150kHz ~ 100MHz	Dec. 14, 2016	Conduction (CO01-CB)
LISN	Schwarzbeck	NSLK 8127	8127647	9kHz ~ 30MHz	Dec. 21, 2016	Conduction (CO01-CB)
COND Cable	Woken	Cable	01	150kHz ~ 30MHz	May 24, 2016	Conduction (CO01-CB)
Software	Audix	E3	6.120210n	-	N.C.R.	Conduction (CO01-CB)
BILOG ANTENNA with 6dB Attenuator	TESEQ & EMCI	CBL6112D & N-6-06	37880 & AT-N0609	20MHz ~ 2GHz	Aug. 30, 2016	Radiation (03CH01-CB)
Horn Antenna	EMCO	3115	00075790	750MHz ~ 18GHz	Nov. 10, 2016	Radiation (03CH01-CB)
Horn Antenna	Schwarzbeck	BBHA 9170	BBHA9170252	15GHz ~ 40GHz	Jul. 25, 2016	Radiation (03CH01-CB)
Pre-Amplifier	Agilent	8447D	2944A10991	0.1MHz ~ 1.3GHz	Mar. 15, 2016	Radiation (03CH01-CB)
Pre-Amplifier	Agilent	8449B	3008A02310	1GHz ~ 26.5GHz	Jan. 18, 2016	Radiation (03CH01-CB)
Pre-Amplifier	Agilent	8449B	3008A02310	1GHz ~ 26.5GHz	Jan. 16, 2017	Radiation (03CH01-CB)
Pre-Amplifier	MITEQ	TTA1840-35-HG	1864479	18GHz ~ 40GHz	Jun. 28, 2016	Radiation (03CH01-CB)
Spectrum Analyzer	R&S	FSP40	100056	9kHz ~ 40GHz	Nov. 21, 2016	Radiation (03CH01-CB)
EMI Test	R&S	ESCS	100355	9kHz ~ 2.75GHz	May 16, 2016	Radiation (03CH01-CB)
RF Cable-low	Woken	Low Cable-16+17	N/A	30 MHz ~ 1 GHz	Oct. 24, 2016	Radiation (03CH01-CB)
RF Cable-high	Woken	High Cable-16	N/A	1 GHz ~ 18 GHz	Oct. 24, 2016	Radiation (03CH01-CB)
RF Cable-high	Woken	High Cable-16+17	N/A	1 GHz ~ 18 GHz	Oct. 24, 2016	Radiation (03CH01-CB)
RF Cable-high	Woken	High Cable-40G#1	N/A	18GHz ~ 40 GHz	Oct. 24, 2016	Radiation (03CH01-CB)
RF Cable-high	Woken	High Cable-40G#2	N/A	18GHz ~ 40 GHz	Oct. 24, 2016	Radiation (03CH01-CB)
Test Software	Audix	E3	6.2009-10-7	N/A	N/A	Radiation (03CH01-CB)
Loop Antenna	Teseq	HLA 6120	24155	9kHz - 30 MHz	Mar. 16, 2016*	Radiation (03CH01-CB)
Spectrum analyzer	R&S	FSV40	100979	9kHz-40GHz	Dec. 26, 2016	Conducted (TH01-CB)



Instrument	Manufacturer	Model No.	Serial No.	Characteristics	Calibration Date	Remark
RF Cable-high	Woken	RG402	High Cable-6	1 GHz – 26.5 GHz	Oct. 24, 2016	Conducted (TH01-CB)
RF Cable-high	Woken	RG402	High Cable-7	1 GHz –26.5 GHz	Oct. 24, 2016	Conducted (TH01-CB)
RF Cable-high	Woken	RG402	High Cable-8	1 GHz –26.5 GHz	Oct. 24, 2016	Conducted (TH01-CB)
RF Cable-high	Woken	RG402	High Cable-9	1 GHz –26.5 GHz	Oct. 24, 2016	Conducted (TH01-CB)
RF Cable-high	Woken	RG402	High Cable-10	1 GHz –26.5 GHz	Oct. 24, 2016	Conducted (TH01-CB)
Power Sensor	Agilent	U2021XA	MY53410001	50MHz~18GHz	Nov. 22, 2016	Conducted (TH01-CB)
Power Sensor	Agilent	U2021XA	MY53410002	50MHz~18GHz	Nov. 22, 2016	Conducted (TH01-CB)
Power Sensor	Agilent	U2021XA	MY54320014	50MHz~18GHz	Apr. 20, 2016	Conducted (TH01-CB)
Power Sensor	Agilent	U2021XA	MY54320015	50MHz~18GHz	Apr. 20, 2016	Conducted (TH01-CB)

Note: Calibration Interval of instruments listed above is one year.

“**” Calibration Interval of instruments listed above is two years.

N.C.R means Non-Calibration required.



AC Power-line Conducted Emissions Result

Appendix A

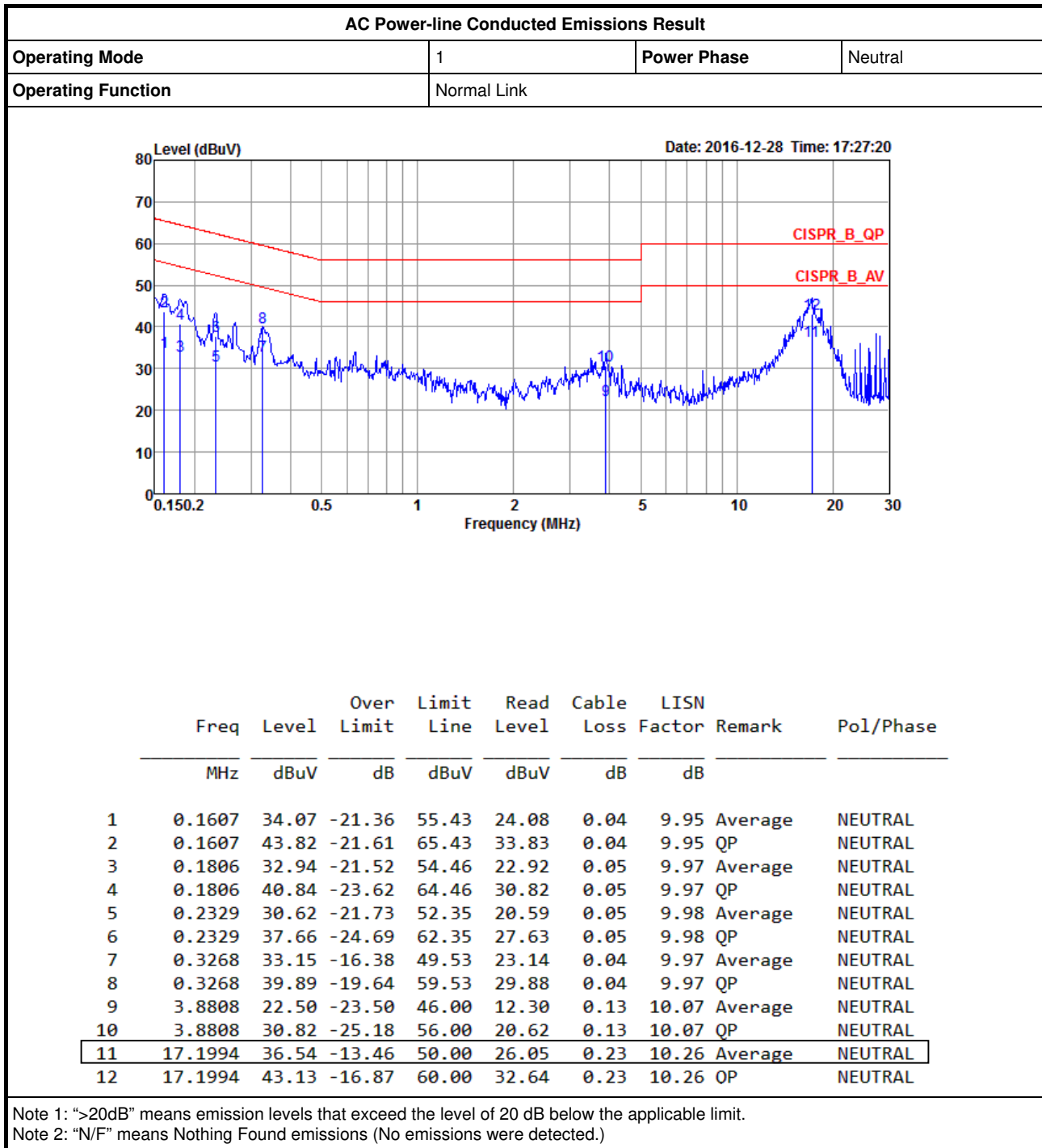



AC Power-line Conducted Emissions Result

Appendix A

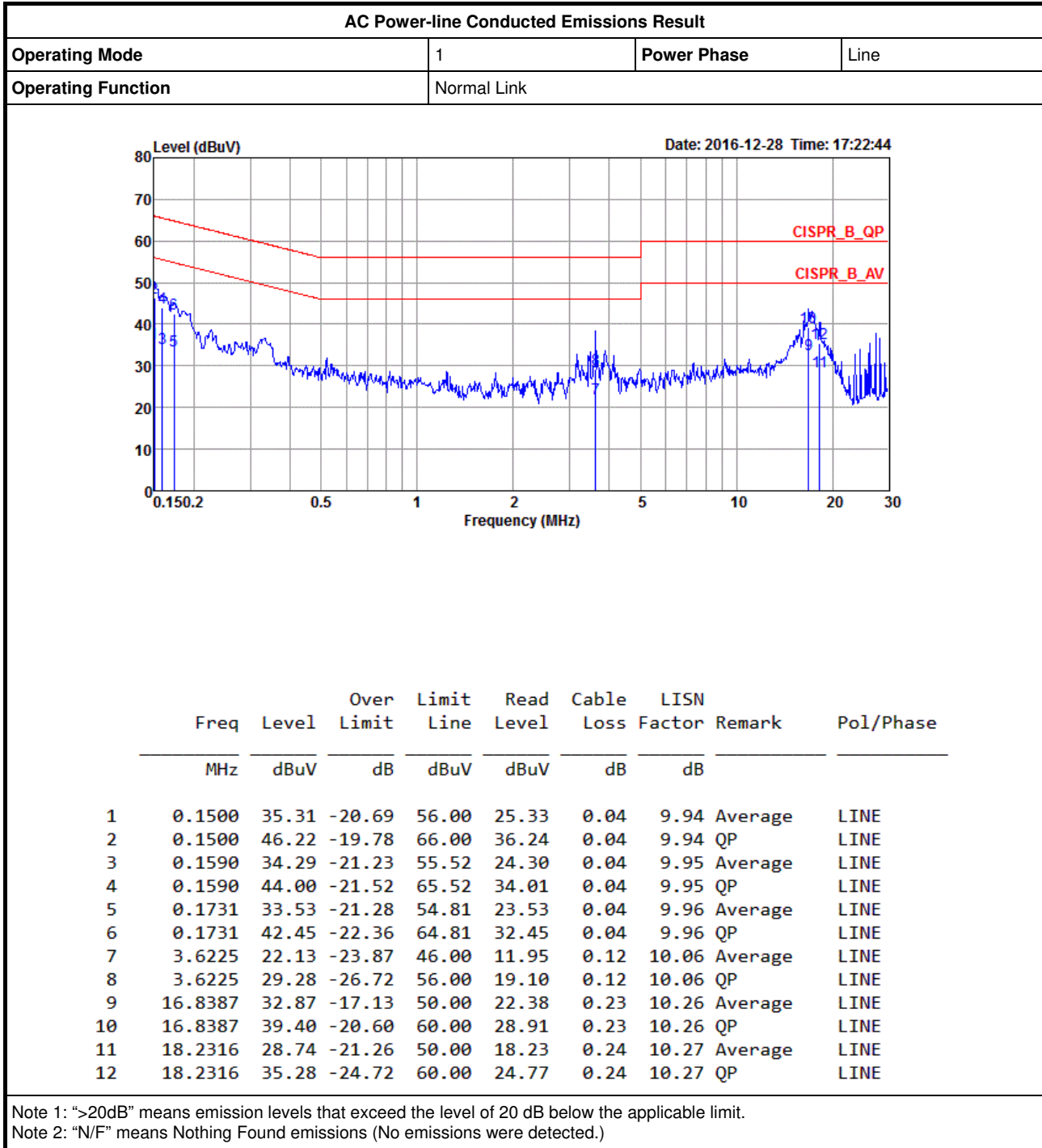



Summary

Mode	Max-N dB (Hz)	Max-OBW (Hz)	ITU-Code	Min-N dB (Hz)	Min-OBW (Hz)
BT-LE(1Mbps)	-	-	-	-	-
2.4-2.4835GHz	707.5k	1.036M	1M04F1D	693.75k	1.03M

Max-N dB = Maximum 6dB down bandwidth; **Max-OBW** = Maximum 99% occupied bandwidth;
Min-N dB = Minimum 6dB down bandwidth; **Min-OBW** = Minimum 99% occupied bandwidth;

Result

Mode	Result	Limit (Hz)	Port 1-N dB (Hz)	Port 1-OBW (Hz)
BT-LE(1Mbps)	-	-	-	-
2402MHz	Pass	500k	693.75k	1.036M
2440MHz	Pass	500k	702.5k	1.03M
2480MHz	Pass	500k	707.5k	1.033M

Port X-N dB = Port X 6dB down bandwidth; **Port X-OBW** = Port X 99% occupied bandwidth;

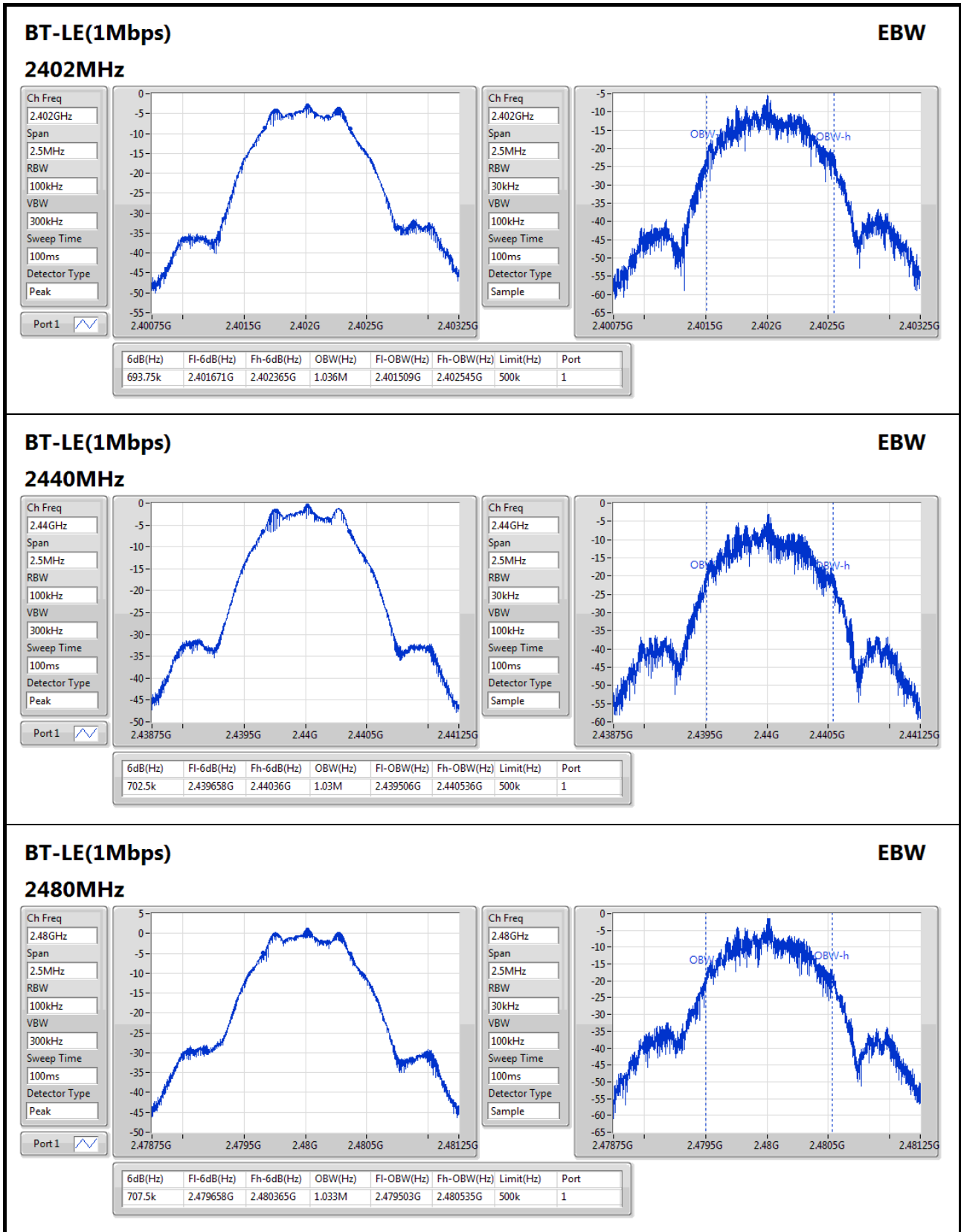
BT-LE(1Mbps)
EBW

2480MHz

Ch Freq: 2.48GHz
Span: 2.5MHz
RBW: 100kHz
VBW: 300kHz
Sweep Time: 100ms
Detector Type: Peak

Ch Freq: 2.48GHz
Span: 2.5MHz
RBW: 30kHz
VBW: 100kHz
Sweep Time: 100ms
Detector Type: Sample



Summary

Mode	Power (dBm)	Power (W)
BT-LE(1Mbps)	-	-
2.4-2.4835GHz	7.23	0.00528

Result

Mode	Result	Gain (dBi)	Power (dBm)	Power Limit (dBm)
BT-LE(1Mbps)	-	-	-	-
2402MHz	Pass	2.54	3.19	30.00
2440MHz	Pass	2.54	5.46	30.00
2480MHz	Pass	2.54	7.23	30.00



Summary

Mode	PD (dBm/RBW)
BT-LE(1Mbps)	-
2.4-2.4835GHz	-6.72

RBW=3kHz.

Result

Mode	Result	Gain (dBi)	PD (dBm/RBW)	PD Limit (dBm/RBW)
BT-LE(1Mbps)	-	-	-	-
2402MHz	Pass	2.54	-10.67	8.00
2440MHz	Pass	2.54	-8.47	8.00
2480MHz	Pass	2.54	-6.72	8.00

RBW=3kHz.

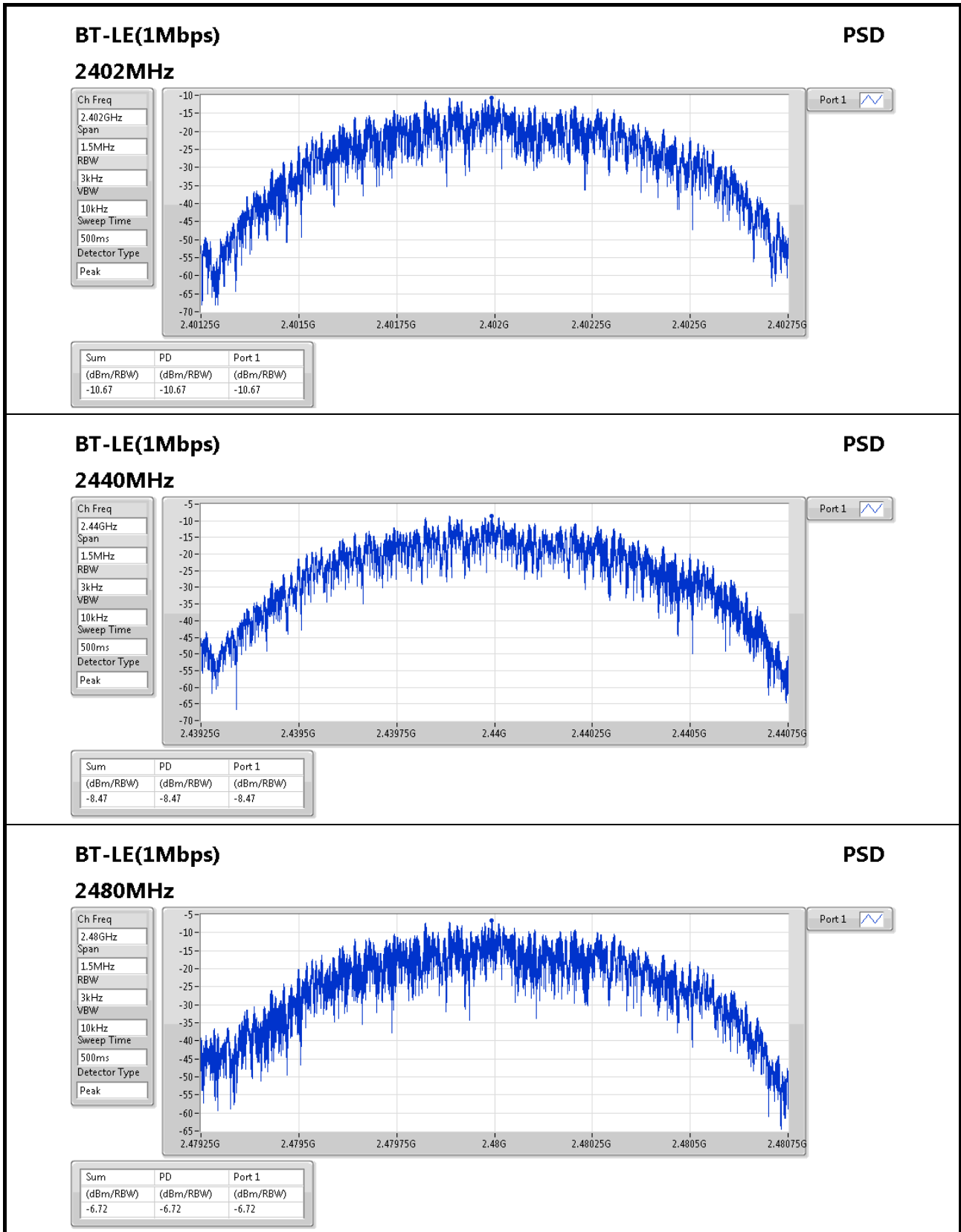



Summary

Mode	Result	Ref (Hz)	Ref (dBm)	Limit (dBm)	Freq (Hz)	Level (dBm)	Freq (Hz)	Level (dBm)	Freq (Hz)	Level (dBm)	Freq (Hz)	Level (dBm)	Port
BT-LE(1Mbps)	-	-	-	-	-	-	-	-	-	-	-	-	-
2.4-2.4835GHz	Pass	2.402171G	1.94	-28.06	67.888M	-54.89	2.399224G	-45.71	2.48544G	-57.32	2.555858G	-48.00	1

Result

Mode	Result	Ref (Hz)	Ref (dBm)	Limit (dBm)	Freq (Hz)	Level (dBm)	Freq (Hz)	Level (dBm)	Freq (Hz)	Level (dBm)	Freq (Hz)	Level (dBm)	Port
BT-LE(1Mbps)	-	-	-	-	-	-	-	-	-	-	-	-	-
2402MHz	Pass	2.402171G	1.94	-28.06	67.888M	-54.89	2.399224G	-45.71	2.48544G	-57.32	2.555858G	-48.00	1
2440MHz	Pass	2.44008G	4.68	-25.32	921.552M	-59.02	2.39812G	-57.28	2.484728G	-55.92	2.595258G	-49.59	1
2480MHz	Pass	2.48016G	6.86	-23.14	71.44M	-52.91	2.3992G	-58.44	2.485372G	-54.46	2.584001G	-50.99	1

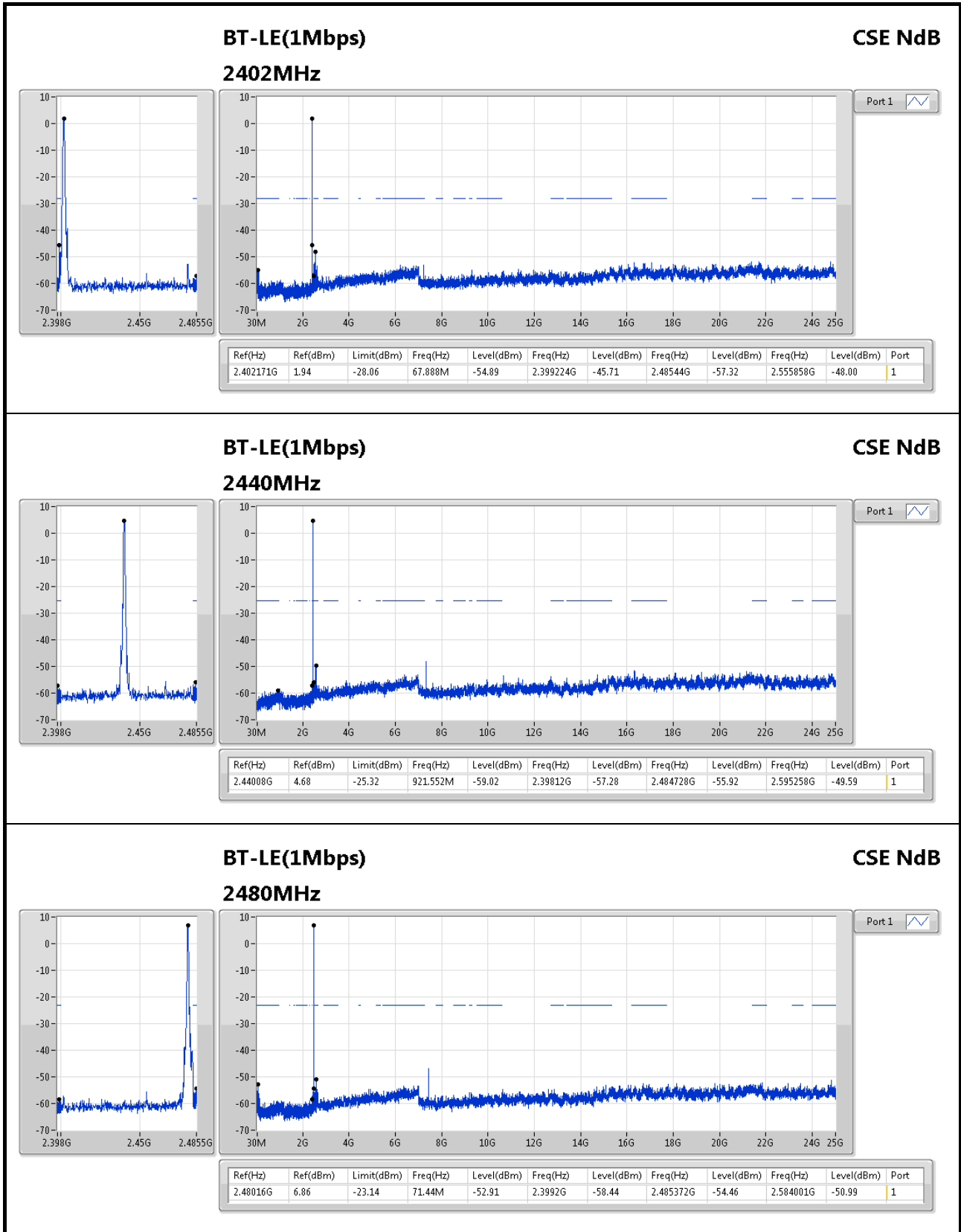



RSE below 1GHz Result

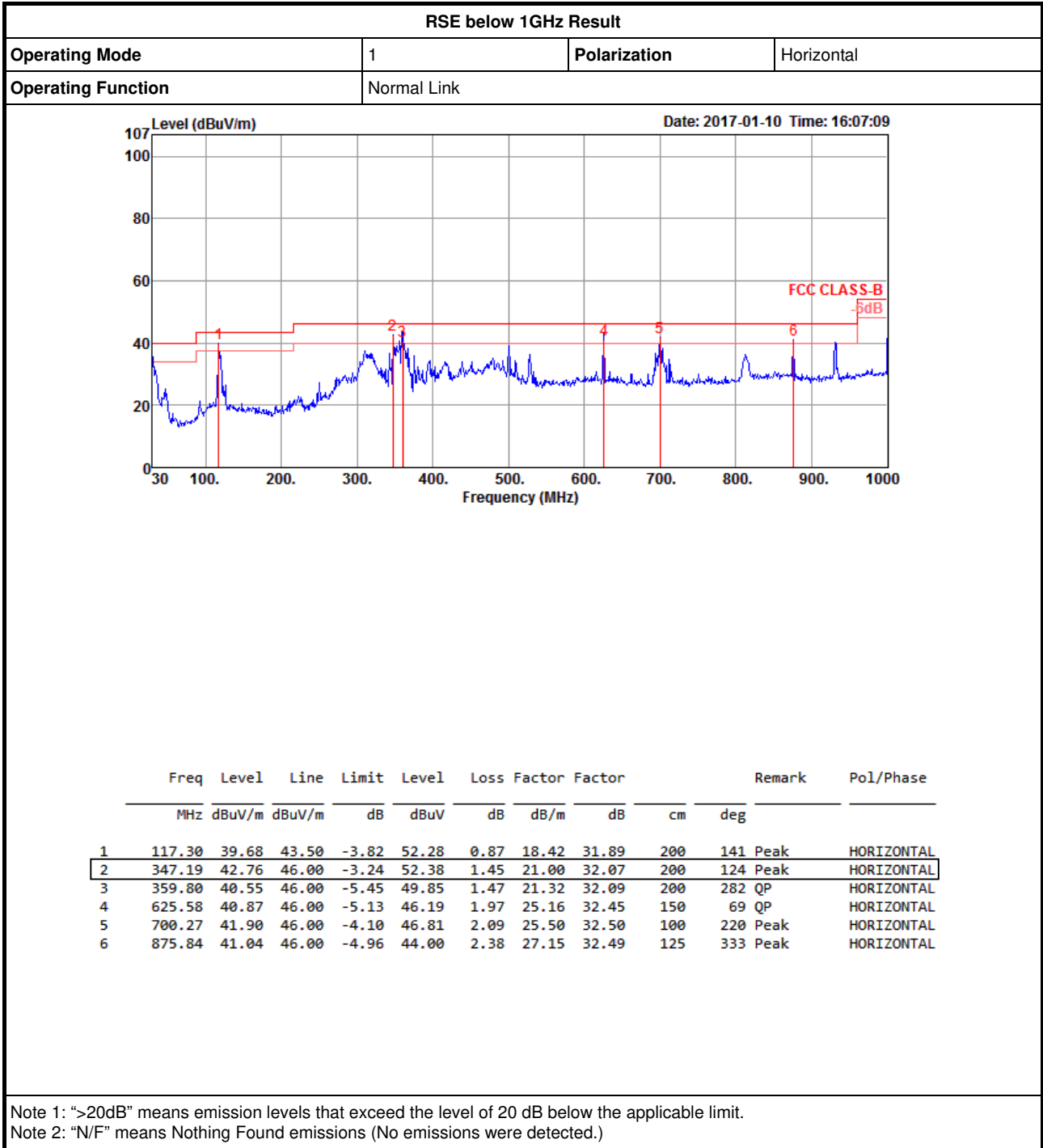



RSE below 1GHz Result

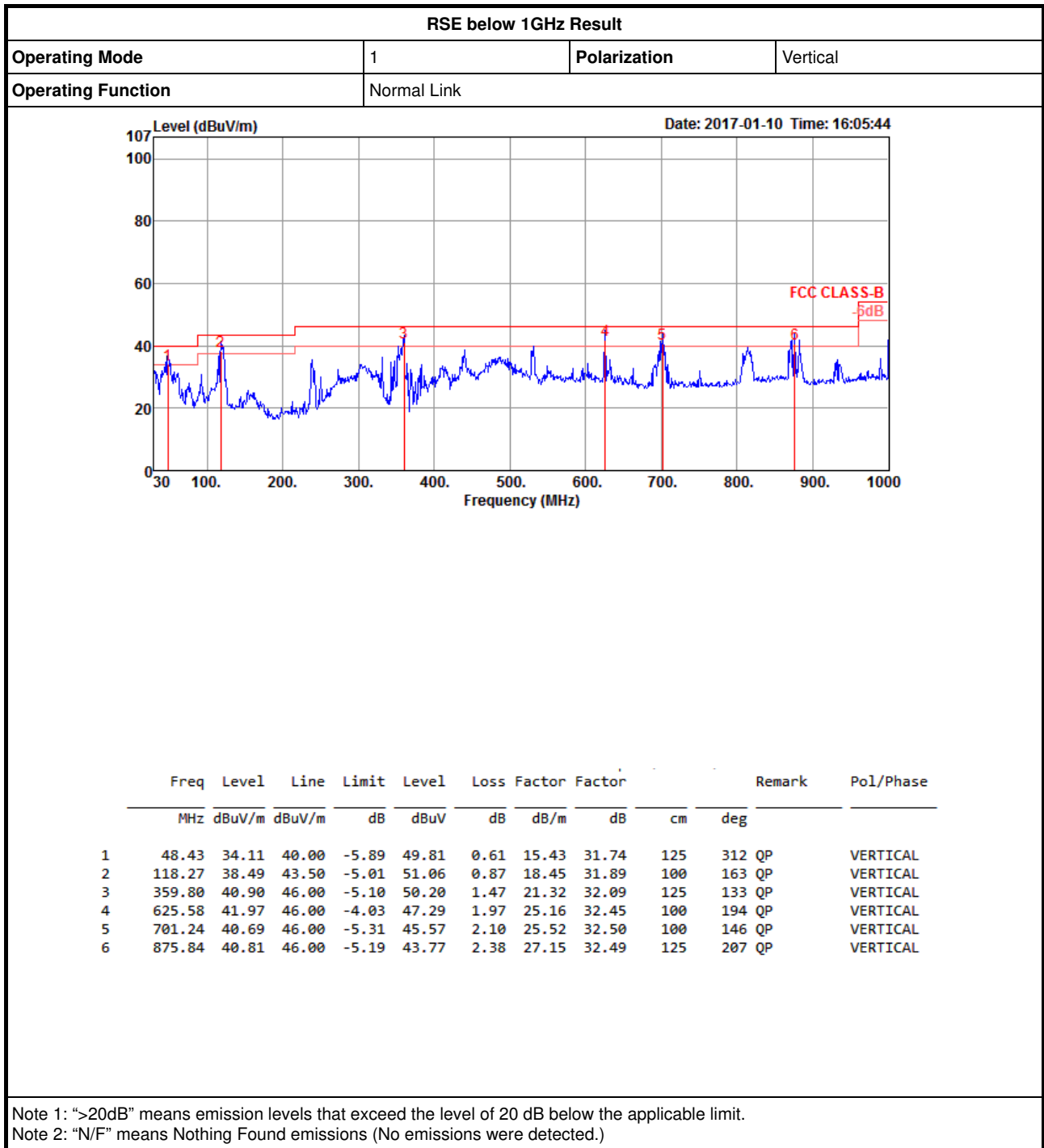



Radiated Emissions (1GHz~10th Harmonic)

Configurations	GFSK CH 0 / Chain 5
-----------------------	---------------------

Horizontal

	Freq	Level	Limit Line	Over Limit	Read Level	CableAntenna Loss	Antenna Factor	Preamp Factor	A/Pos	T/Pos	Remark	Pol/Phase
	MHz	dBuV/m	dBuV/m	dB	dBuV	dB	dB/m	dB	cm	deg		
1	4803.92	40.70	54.00	-13.30	37.39	5.22	32.62	34.53	106	190	Average	HORIZONTAL
2	4803.92	48.68	74.00	-25.32	45.37	5.22	32.62	34.53	106	190	Peak	HORIZONTAL

Vertical

	Freq	Level	Limit Line	Over Limit	Read Level	CableAntenna Loss	Antenna Factor	Preamp Factor	A/Pos	T/Pos	Remark	Pol/Phase
	MHz	dBuV/m	dBuV/m	dB	dBuV	dB	dB/m	dB	cm	deg		
1	4804.02	42.51	54.00	-11.49	39.20	5.22	32.62	34.53	108	232	Average	VERTICAL
2	4804.64	51.50	74.00	-22.50	48.19	5.22	32.62	34.53	108	232	Peak	VERTICAL

Configurations	GFSK CH 19 / Chain 5
-----------------------	----------------------

Horizontal

	Freq	Level	Limit Line	Over Limit	Read Level	CableAntenna Loss	Antenna Factor	Preamp Factor	A/Pos	T/Pos	Remark	Pol/Phase
	MHz	dBuV/m	dBuV/m	dB	dBuV	dB	dB/m	dB	cm	deg		
1	4879.96	39.83	54.00	-14.17	36.29	5.28	32.76	34.50	118	62	Average	HORIZONTAL
2	4879.96	49.12	74.00	-24.88	45.58	5.28	32.76	34.50	118	62	Peak	HORIZONTAL

Vertical

	Freq	Level	Limit Line	Over Limit	Read Level	CableAntenna Loss	Antenna Factor	Preamp Factor	A/Pos	T/Pos	Remark	Pol/Phase
	MHz	dBuV/m	dBuV/m	dB	dBuV	dB	dB/m	dB	cm	deg		
1	4879.96	42.85	54.00	-11.15	39.31	5.28	32.76	34.50	126	246	Average	VERTICAL
2	4879.96	50.44	74.00	-23.56	46.90	5.28	32.76	34.50	126	246	Peak	VERTICAL



Configurations	GFSK CH 39 / Chain 5
-----------------------	----------------------

Horizontal

	Freq	Level	Limit Line	Over Limit	Read Level	CableAntenna Loss	Antenna Factor	Preamp Factor	A/Pos	T/Pos	Remark	Pol/Phase
	MHz	dBuV/m	dBuV/m	dB	dBuV	dB	dB/m	dB	cm	deg		
1	4959.96	39.62	54.00	-14.38	35.83	5.35	32.92	34.48	260	84	Average	HORIZONTAL
2	4959.98	48.71	74.00	-25.29	44.92	5.35	32.92	34.48	260	84	Peak	HORIZONTAL

Vertical

	Freq	Level	Limit Line	Over Limit	Read Level	CableAntenna Loss	Antenna Factor	Preamp Factor	A/Pos	T/Pos	Remark	Pol/Phase
	MHz	dBuV/m	dBuV/m	dB	dBuV	dB	dB/m	dB	cm	deg		
1	4960.02	40.60	54.00	-13.40	36.81	5.35	32.92	34.48	116	182	Average	VERTICAL
2	4960.50	49.89	74.00	-24.11	46.10	5.35	32.92	34.48	116	182	Peak	VERTICAL

Note:

The amplitude of spurious emissions which are attenuated by more than 20dB below the permissible value has no need to be reported.

Emission level (dBuV/m) = 20 log Emission level (uV/m).

Corrected Reading: Antenna Factor + Cable Loss + Read Level - Preamp Factor = Level.



Band Edge Emissions

Configurations	GFSK CH 0, 19, 39 / Chain 5
----------------	-----------------------------

Channel 0

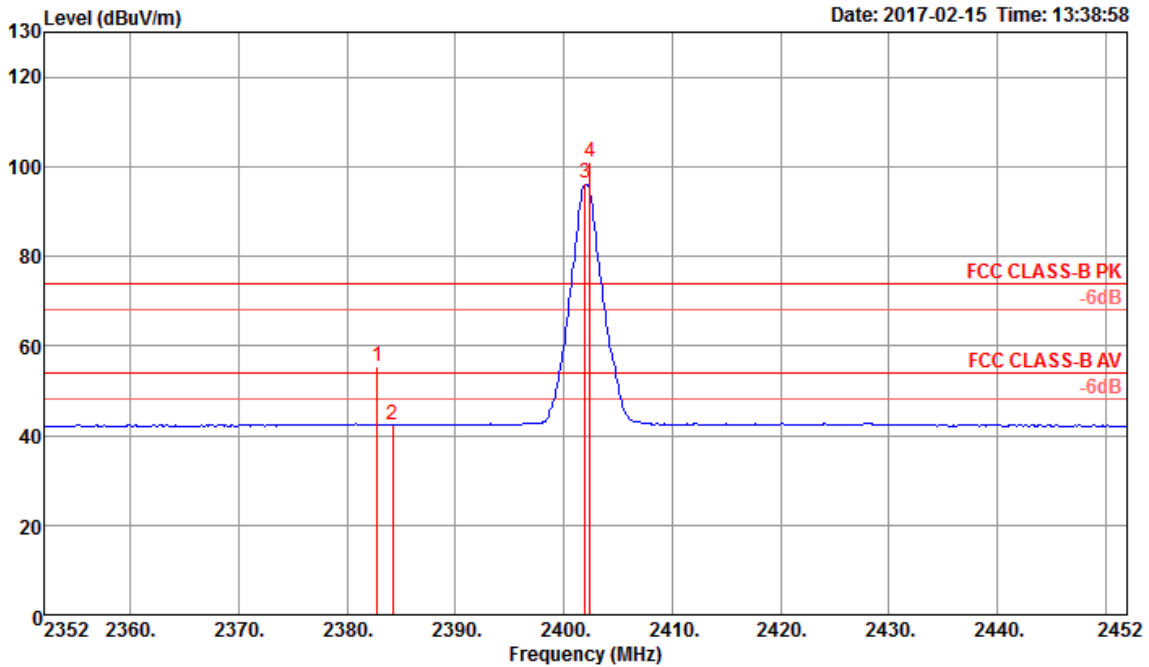

	Freq	Level	Limit Line	Over Limit	Read Level	Cable Loss	Antenna Factor	Preamp Factor	A/Pos	T/Pos	Remark	Pol/Phase
	MHz	dBuV/m	dBuV/m	dB	dBuV	dB	dB/m	dB	cm	deg		
1	2382.80	55.50	74.00	-18.50	24.45	3.03	28.02	0.00	280	266	Peak	VERTICAL
2	2384.20	42.51	54.00	-11.49	11.47	3.03	28.01	0.00	280	266	Average	VERTICAL
3 @	2402.00	96.14			65.12	3.04	27.98	0.00	280	266	Average	VERTICAL
4 @	2402.40	101.17			70.15	3.04	27.98	0.00	280	266	Peak	VERTICAL

Item 3, 4 are the fundamental frequency at 2402 MHz.



Channel 19

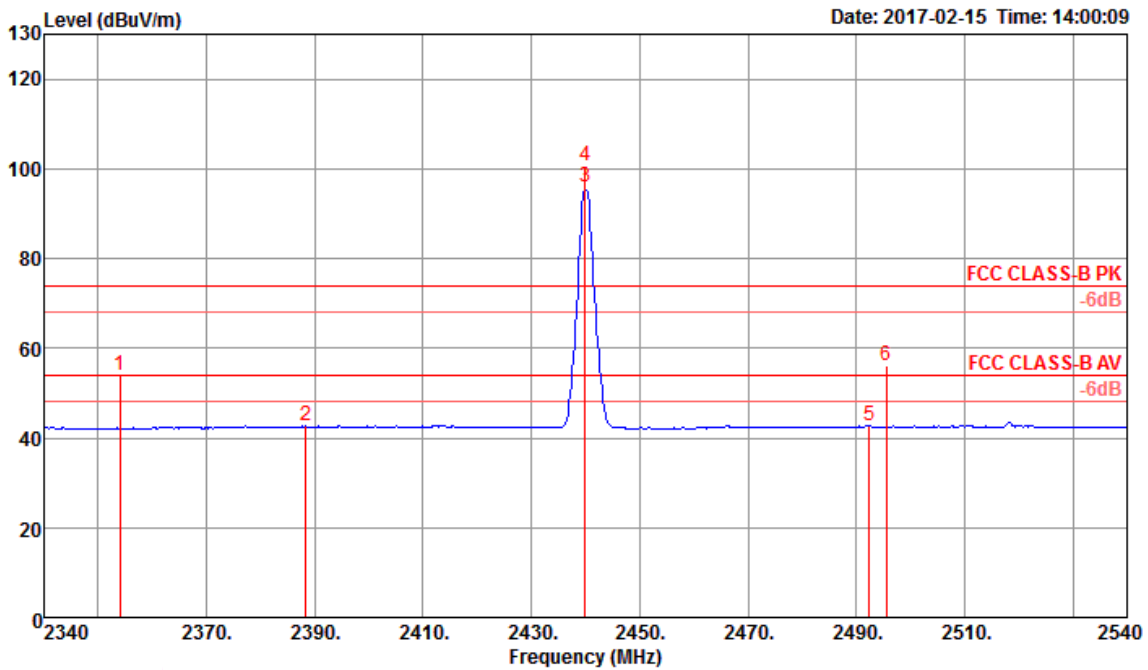

	Freq	Level	Limit Line	Over Limit	Read Level	Cable Loss	Antenna Factor	Preamp Factor	A/Pos	T/Pos	Remark	Pol/Phase
	MHz	dBuV/m	dBuV/m	dB	dBuV	dB	dB/m	dB	cm	deg		
1	2354.00	54.01	74.00	-19.99	22.93	3.01	28.07	0.00	276	246	Peak	HORIZONTAL
2	2388.40	42.57	54.00	-11.43	11.53	3.03	28.01	0.00	276	246	Average	HORIZONTAL
3 @	2440.00	95.79			64.82	3.07	27.90	0.00	276	246	Average	HORIZONTAL
4 @	2440.00	100.68			69.71	3.07	27.90	0.00	276	246	Peak	HORIZONTAL
5	2492.40	42.66	54.00	-11.34	11.75	3.10	27.81	0.00	276	246	Average	HORIZONTAL
6	2495.60	56.01	74.00	-17.99	25.10	3.10	27.81	0.00	276	246	Peak	HORIZONTAL

Item 3, 4 are the fundamental frequency at 2440 MHz.



Channel 39

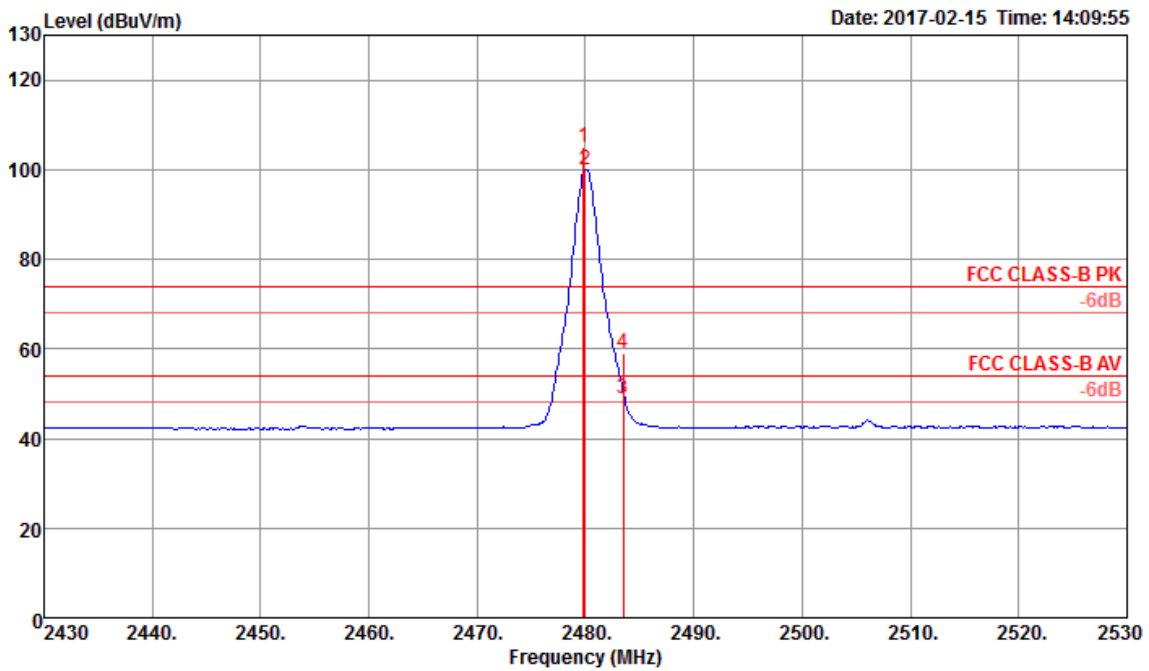

	Freq	Level	Limit Line	Over Limit	Read Level	Cable Loss	Antenna Factor	Preamp Factor	A/Pos	T/Pos	Remark	Pol/Phase
	MHz	dBuV/m	dBuV/m	dB	dBuV	dB	dB/m	dB	cm	deg		
1 @	2479.80	105.03			74.10	3.09	27.84	0.00	267	278	Peak	VERTICAL
2 @	2480.00	99.99			69.06	3.09	27.84	0.00	267	278	Average	VERTICAL
3	2483.50	48.84	54.00	-5.16	17.92	3.09	27.83	0.00	267	278	Average	VERTICAL
4	2483.50	59.05	74.00	-14.95	28.13	3.09	27.83	0.00	267	278	Peak	VERTICAL

Item 1, 2 are the fundamental frequency at 2480 MHz.

Note:

Emission level (dBUV/m) = 20 log Emission level (uV/m).

Corrected Reading: Antenna Factor + Cable Loss + Read Level - Preamp Factor = Level.



RSE Co-location Result

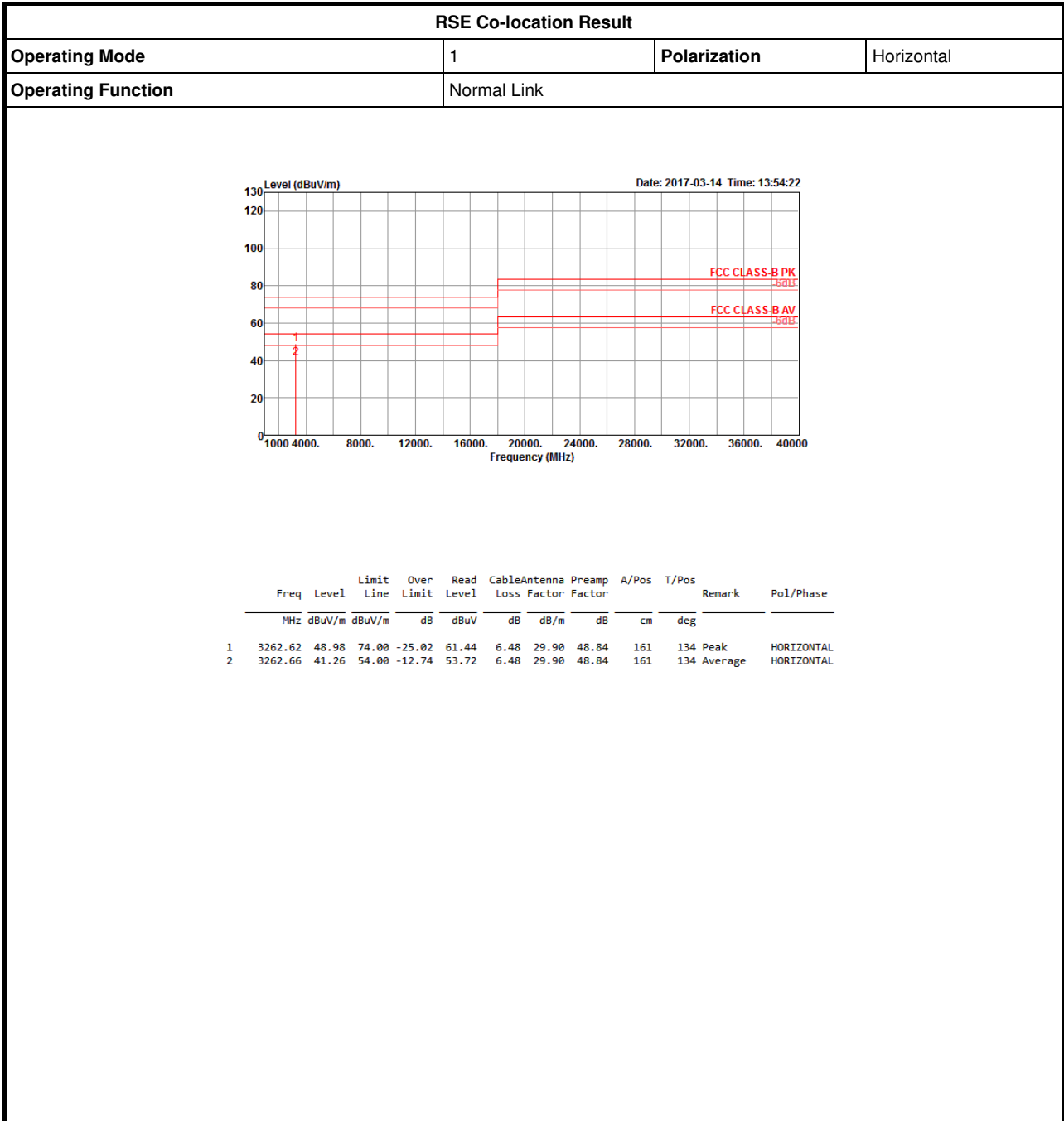



RSE Co-location Result																																																			
Operating Mode	1	Polarization	Vertical																																																
Operating Function	Normal Link																																																		
<div style="display: flex; justify-content: space-between; align-items: flex-start;"> <div style="text-align: center;"> <p>The plot shows a single peak at 3262.63 MHz. The y-axis ranges from 0 to 130 dBuV/m, and the x-axis ranges from 1000 to 40000 MHz. Two horizontal red lines represent FCC Class-B limits: PK at 80 dBuV/m and AV at 60 dBuV/m. A vertical red line at 3262.63 MHz indicates the peak level, which is significantly above the AV limit.</p> </div> <div style="text-align: right;"> <p>Date: 2017-03-14 Time: 13:54:00</p> </div> </div>																																																			
<table border="1" style="width: 100%; border-collapse: collapse; font-size: small;"> <thead> <tr> <th></th> <th>Freq</th> <th>Level</th> <th>Limit</th> <th>Over</th> <th>Read</th> <th>CableAntenna</th> <th>Preamp</th> <th>A/Pos</th> <th>T/Pos</th> <th>Remark</th> <th>Pol/Phase</th> </tr> <tr> <th></th> <th>MHz</th> <th>dBuV/m</th> <th>dBuV/m</th> <th>dB</th> <th>dBuV</th> <th>dB</th> <th>dB/m</th> <th>dB</th> <th>cm</th> <th>deg</th> <th></th> </tr> </thead> <tbody> <tr> <td>1</td> <td>3262.61</td> <td>45.98</td> <td>54.00</td> <td>-8.02</td> <td>58.44</td> <td>6.48</td> <td>29.90</td> <td>48.84</td> <td>176</td> <td>149 Average</td> <td>VERTICAL</td> </tr> <tr> <td>2</td> <td>3262.63</td> <td>55.44</td> <td>74.00</td> <td>-18.56</td> <td>67.90</td> <td>6.48</td> <td>29.90</td> <td>48.84</td> <td>176</td> <td>149 Peak</td> <td>VERTICAL</td> </tr> </tbody> </table>					Freq	Level	Limit	Over	Read	CableAntenna	Preamp	A/Pos	T/Pos	Remark	Pol/Phase		MHz	dBuV/m	dBuV/m	dB	dBuV	dB	dB/m	dB	cm	deg		1	3262.61	45.98	54.00	-8.02	58.44	6.48	29.90	48.84	176	149 Average	VERTICAL	2	3262.63	55.44	74.00	-18.56	67.90	6.48	29.90	48.84	176	149 Peak	VERTICAL
	Freq	Level	Limit	Over	Read	CableAntenna	Preamp	A/Pos	T/Pos	Remark	Pol/Phase																																								
	MHz	dBuV/m	dBuV/m	dB	dBuV	dB	dB/m	dB	cm	deg																																									
1	3262.61	45.98	54.00	-8.02	58.44	6.48	29.90	48.84	176	149 Average	VERTICAL																																								
2	3262.63	55.44	74.00	-18.56	67.90	6.48	29.90	48.84	176	149 Peak	VERTICAL																																								