

User Manual

Package Contents

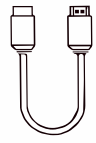

Device x1



HDMI Cable x1



Remote Control x1



Power Adapter x1

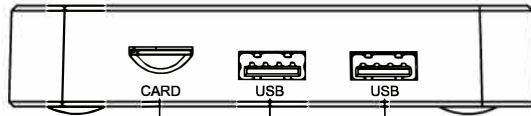
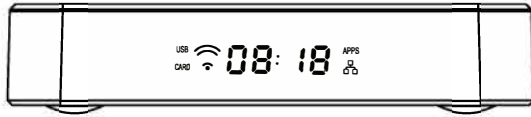

CARD

USB

USB

Connection Diagram

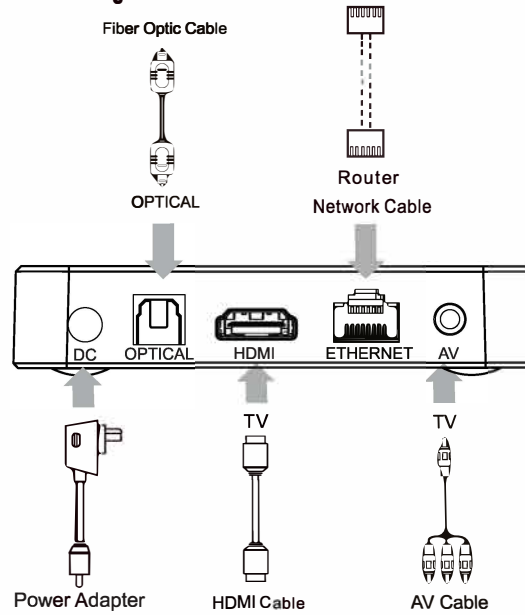

Installation Steps

- 01** Connect the TV Box with the power supply.
- 02** Connect the TV Box to your TV with an HDMI cable or AV cable.
- 03** For a wired connection, plug in Ethernet cable from the TV Box to your modem or router. For wireless, choose your Wi-Fi network and input your Wi-Fi password.

Multi-screen Interaction

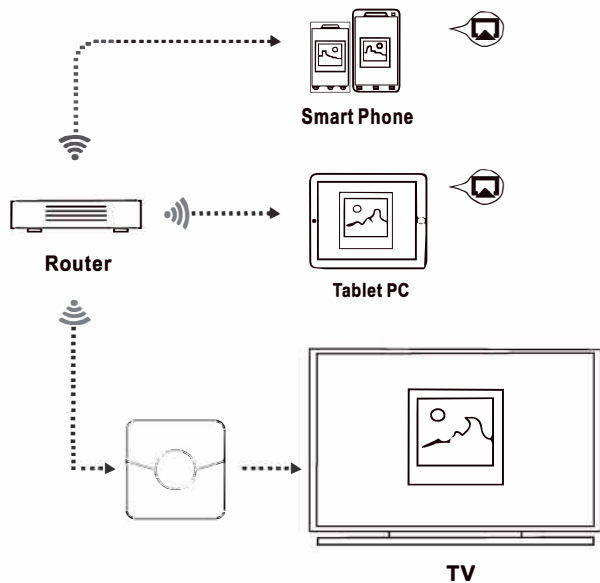

The Screen Casting



Introduction:

The TV Box lets you play photos, music, and videos from your smart phone or tablet computer on your TV.

Preparation:

Make sure your device(s) and TV Box are connected to the same network.

How to use:

After your device(s) and TV Box are connected to the same network, the logo  will show up in the related applications of your device(s). Click the  and share the photos, music and videos on TV.

Key Features



CPU: 64-bit quad core ARM® Cortex™ A35
GPU: ARM G31™ MP2



HW UHD 4K H.265/VP9 60fps 10-bit, 4K AV1 60fps, video decoder.



Wireless Support: 2.4G WiFi / 5 G WiFi



Android 11 OS, OTA upgrade support.

FCC WARNING

This device complies with part 15 of the FCC Rules. Operation is subject to the following two conditions: (1) this device may not cause harmful interference, and (2) this device must accept any interference received, including interference that may cause undesired operation.

Any changes or modifications not expressly approved by the party responsible for compliance could void the user's authority to operate the equipment.

NOTE: This equipment has been tested and found to comply with the limits for a Class B digital device, pursuant to Part 15 of the FCC Rules. These limits are designed to provide reasonable protection against harmful interference in a residential installation. This equipment generates, uses and can radiate radio frequency energy and, if not installed and used in accordance with the instructions, may cause harmful interference to radio communications. However, there is no guarantee that interference will not occur in a particular installation.

If this equipment does cause harmful interference to radio or television reception, which can be determined by turning the equipment off and on, the user is encouraged to try to correct the interference by one or more of the following measures:

- Reorient or relocate the receiving antenna.
- Increase the separation between the equipment and receiver.
- Connect the equipment into an outlet on a circuit different from that to which the receiver is connected.
- Consult the dealer or an experienced radio/TV technician for help.

To maintain compliance with FCC's RF Exposure guidelines, This equipment should be installed and operated with minimum 20cm distance between the radiator and your body: Use only the supplied antenna.