



Android 9.0



User Manual

Package Contents

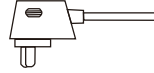
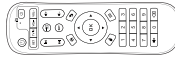
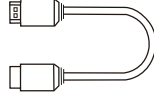

Device x1

HD Cable x1

Remote Control x1

Power Adaptor x1

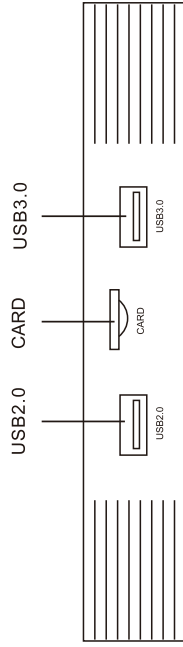
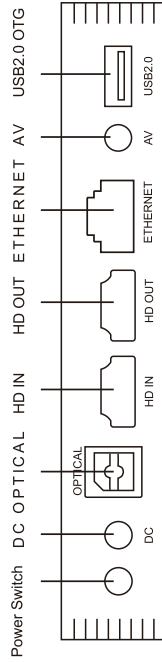

Connection Diagram

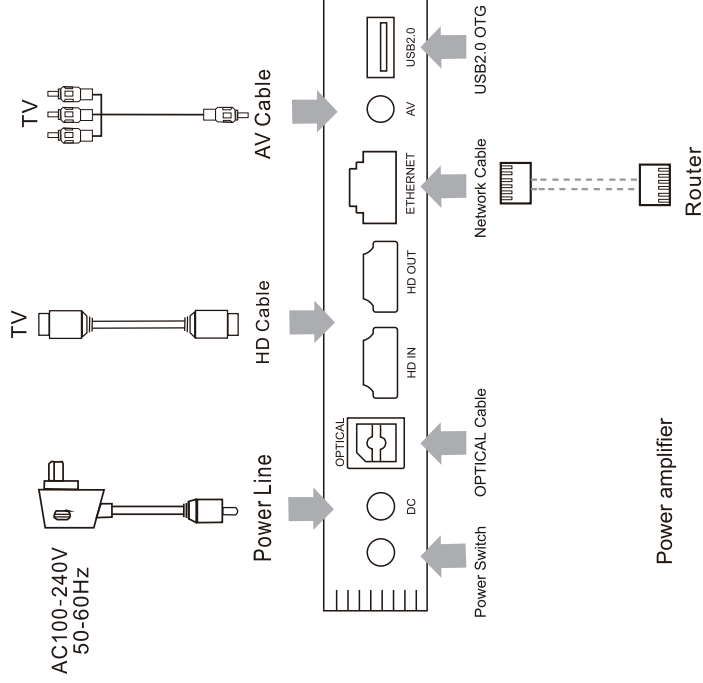

Power amplifier

Installation Steps

- 01** Connect the TV Box with the power supply.
- 02** Connect the TV Box to your TV with an HD cable or AV cable.
- 03** For a wired connection, plug in Ethernet cable from the TV Box to your modem or router. For wireless, choose your Wi-Fi network and input your Wi-Fi password

The Screen Casting



Introduction:

The TV Box lets you play photos, music, and videos from your smart phone or tablet computer on your TV.

Preparation:

Make sure your device(s) and TV Box are connected to the same network

How to use:

After your device(s) and TV Box are connected to the same network, the logo  will show up in the related applications of your device(s). Click the  and share the photos, music and videos on TV.

Multi-screen Interaction

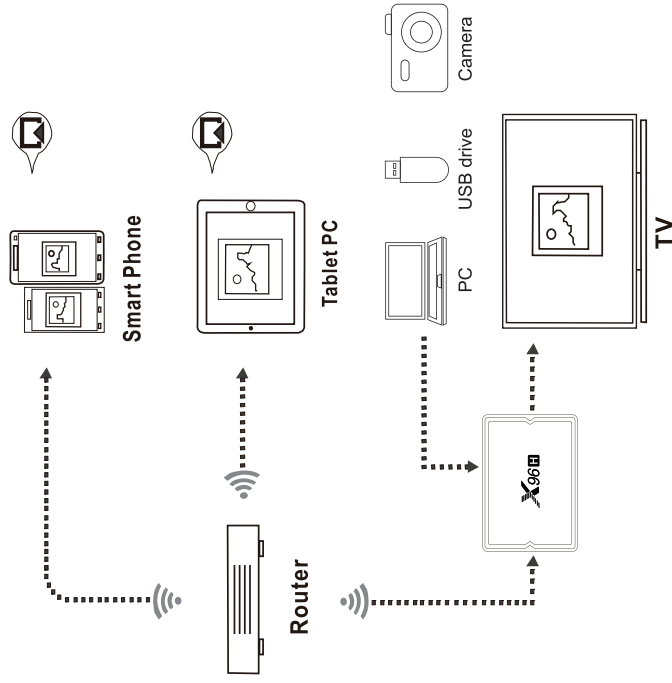

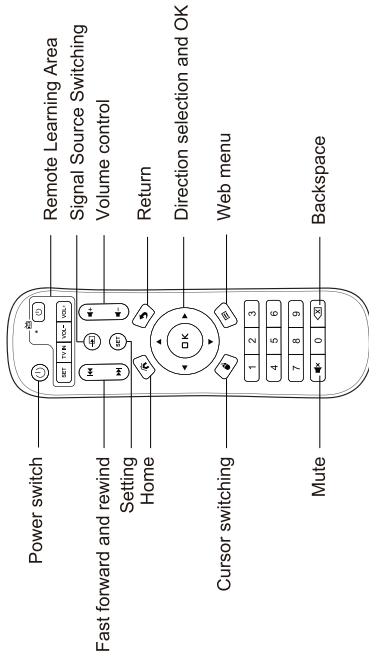

Key Features



Allwinner H603, Quad core ARM Cortex-A53@CPU,Mali-T720 @GPU



3GP, 6K, 4K, AVI, DIVX / DIVX., FLV, H.264, H.265, M4V, MPEG2, MPEG4, PMP, Real 8/9/10, RM, VC-1, VOB, WMV



10 / 100 Ethernet, 802.11b/g/n 2.4G WiFi.



Android 9.0 OS, OTA upgrade support.

FCC INFORMATION (additional)

This device complies with Part 15 of the FCC Rules. Operation is subject to the following two conditions:

1. This device may not cause harmful interference, and 2. This device must accept any interference received, including interference that may cause undesired operation.

Note: This equipment has been tested and found to comply with the limits for a Class B digital device, pursuant to part 15 of the FCC Rules. These limits are designed to provide reasonable protection against harmful interference in a residential installation. This equipment does not create or use radio frequency energy. However, if you experience interference with other electronic equipment while using this equipment, you may wish to take the following steps: (a) Turn the equipment off and on. (b) Increase the separation between the equipment and you. (c) Consult the dealer or an experienced radio/TV technician for help.

- Reorient or relocate the receiving antenna.
- Increase the separation between the equipment and receiver.
- Connect the equipment into a different outlet that to which the receiver is connected.
- Consult the dealer or an experienced radio/TV technician for help.

Caution: Any changes or modifications not expressly approved by the party responsible for compliance could void the user's authority to operate this equipment.

This equipment complies with the FCC RF radiation exposure limits set forth for an uncontrolled environment. This equipment should be installed and operated with a minimum distance of 20cm between the radiator and any part of your body.

TV Learning Functions

1. Press the blue power key for 5 seconds until the LED indicator light is solid
2. Press the desired key found in the blue section that you wish to program(LED will begin to flash indicating that it is ready to be programmed).
3. While both remotes face one another, press and hold the desired programming key on the original TV remote for 1-2 seconds.
4. LED will flash and the key has been programmed. YOU can choose another key by repeating steps 2&3.
5. Once complete, simply press OK at centre of this remote to exit learning mode.

Руководство пользователя

Содержание пакета

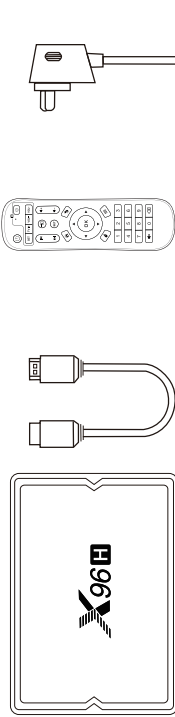

Установка x1
 HD кабель x1
 Телеуправление x1
 адаптер питания x1



Схема включения



Монтажные шаги:

- 01** Соединить телевизорный ящик с источником питания
- 02** Соединить телевизорный ящик с вашим телевизором с помощью hd кабеля AVкабеля
- 03** Для проводного соединения, вставляя кабель эфирной сети из телевизорного ящика в модем или маршрутизатор. Для беспроводного соединения, выберите вашу Wi-Fi сеть и введите ваш Wi-Fi код

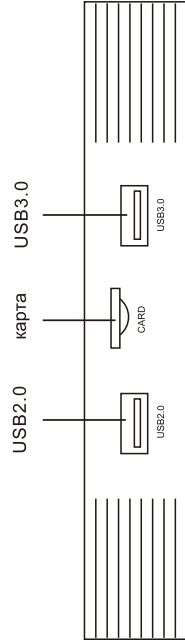
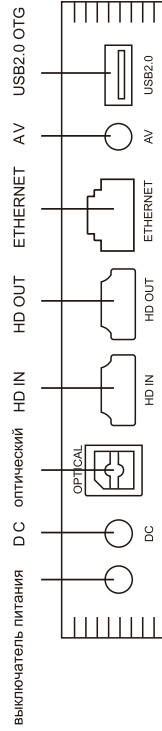
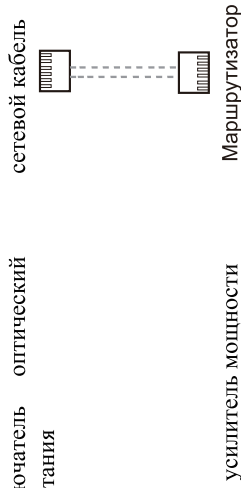
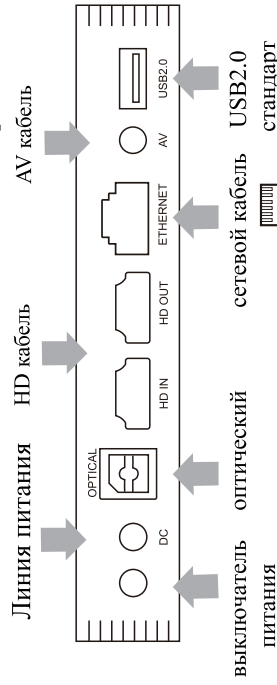
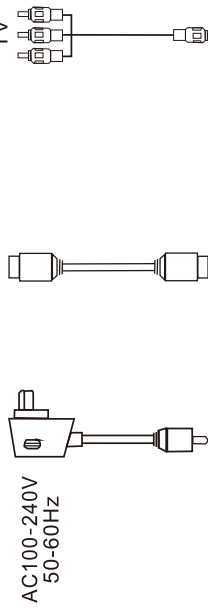
Экранный кастинг:



Рекомендация:

С помощью телевизорного ящика может по вашему телевизору передавать ваши фото, музыки и видео во вашем смартфоне или планшетном компьютере.

Подготовка:

Утвердите, что ваша установка и телевизорный ящик одинаковой сети. подключается к одинаковой сети.

Как использовать:

После того как ваша установка и телевизорный ящик подключены к одинаковой сети, значок  будет показаться в соответствующей прикладной программе установки. Кликните значок  затем поделитесь фото, музыки и видео на телевизоре.

Многоанодное взаимодействие

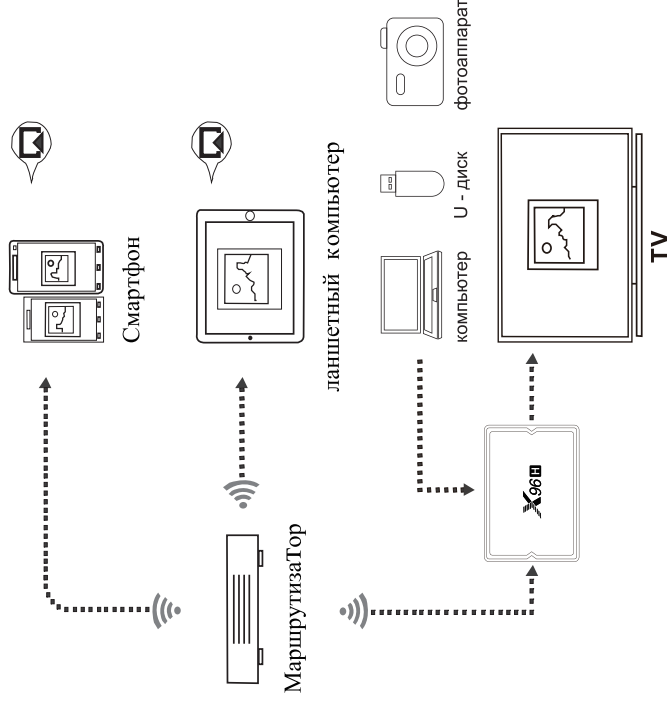

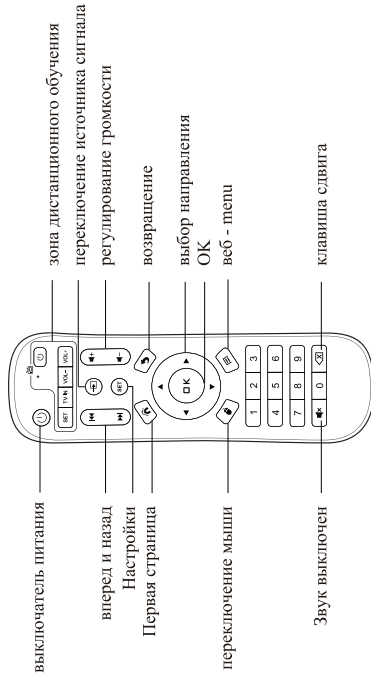

функция телеобучения

1. нажать на клавишу Blue Energy в течение 5 секунд, пока светодиодный индикатор не зажжётся.
2. нажать необходимую клавишу в синей части программы (LED)начнётся мерцание, означающее готовность к программированию.
3. если два пульта управления находятся лицом к лицу, удерживайте необходимую программу.Включите оригинальный телеуправляемый аппарат на 1 - 2 секунды.
4. LED будет мерцать, ключ запрограммирован. вы можете выбрать другой.
- 5.Повторяю шаги 2 и 3.
- 5.После завершения просто нажмите ОК в центре пульта, чтобы выйти из режима обучения.

Основные функции



Allwinner H603, Cortex - A53@CPU.Mali -T720@GPU.



3GP,6K,4K,AVI,DIVD / DIVX,.,FLV,H,264,H,265,M4V,MPEG2, MPEG4,MPMP,Real 8/9/10,RM,VC-1,VOB,WMV.



10 /100м эфирнаясеть , 802.11 b/g/n 2.4 G WiFi.



Android 9.0 OS, OTA поддержка обновления .

Manuel de l'utilisateur Contenu des colis

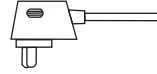
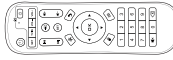
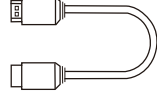

Dispositif × 1 HD câble × 1 Télécommande × 1 Adaptateur d'alimentation × 1



Schéma de connexion



Mesures d'installation

- 01** Brancher la boîte à télé avec l'alimentation électrique
- 02** Relier la boîte à télé à votre télé avec un HD câble ou avec AV câble
- 03** Pour une connexion câblée, brancher câble Ethernet de la télé ou la boîte à télé à votre modem routeur. Pour le sans-fil, choisir votre WIFI réseau et saisir votre mot de passe du WIFI

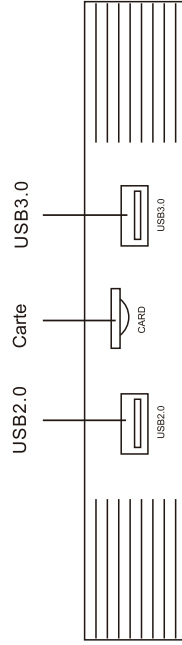
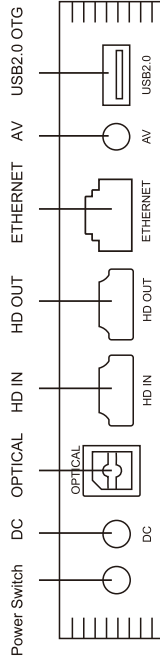
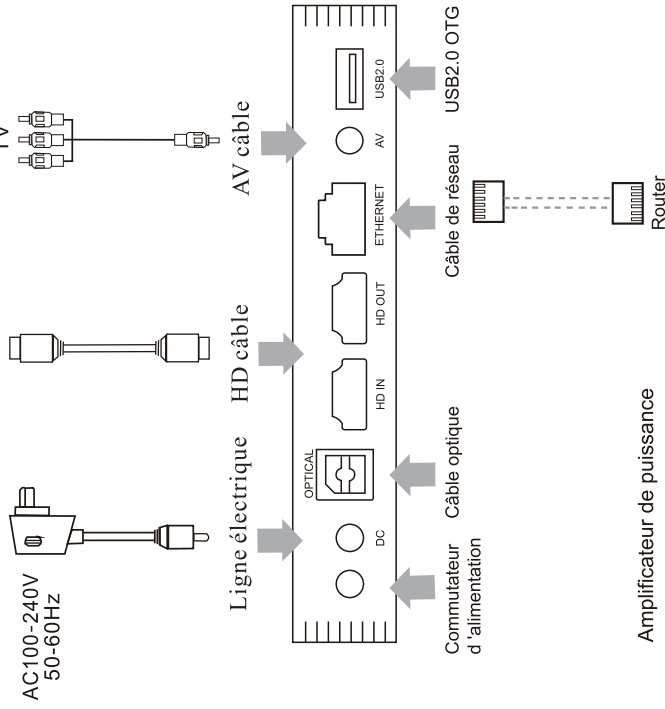
L'écran de coulé

Introduction :

La boîte à télé vous permet de jouer des photos, musiques et vidéos de votre téléphone intelligent ou d'une tablette sur votre télé.

Préparation :

Rassurez - vous que votre (vos) dispositif(s) et la boîte à télé sont reliés au même réseau.

Comment utiliser :

Après votre (vos) dispositif(s) et la boîte à télé sont reliés au même réseau, le symbole apparaît dans applications connectées de votre(vos) dispositif(s). Cliquez et partagez des photos, musiques et vidéos à la télé.

Multi -écran interaction

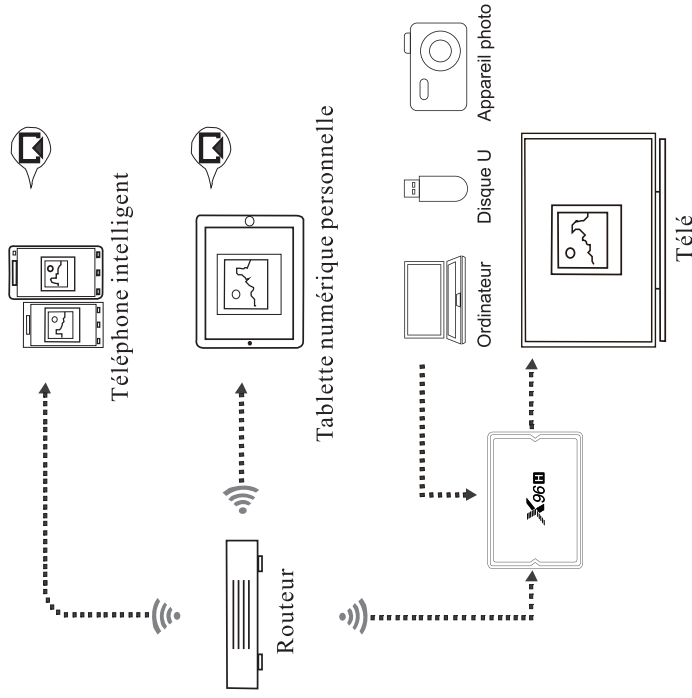

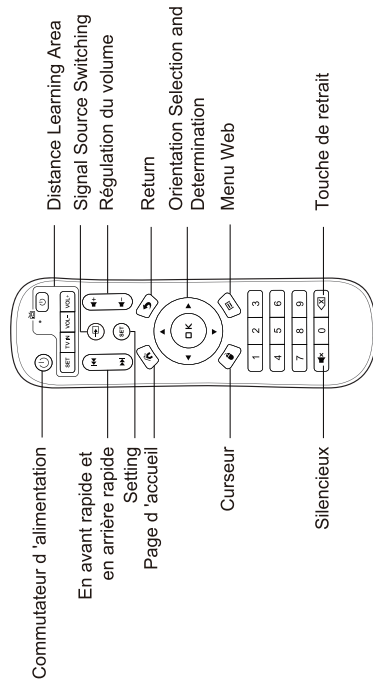

Television Learning Function

- 1.Appuyez sur la touche d'alimentation bleue pendant 5 secondes jusqu'à ce que le voyant reste allumé.
- 2.Appuyez sur la touche souhaitée dans la section bleue que vous souhaitez programmer (DELcommence à clignoter pour indiquer qu'il est prêt à être programmé).
- 3.Tandis que les deux télécommandes se font face, maintenez la programmation désirée enfoncée sur la télécommande d'origine du téléviseur pendant 1 à 2 secondes.
- 4.LED clignotera et la clé a été programmée. Vous pouvez choisir un autre clé en répétant les étapes 2 et 3.
5. Une fois terminé, appuyez simplement sur OK au centre de cette télécommande pour quitter le mode apprentissage.

Principales caractéristiques



Allwinner H603, quatre bras nucléaires Cortex - A53
< CPU.Mali - T720@GPU >



3GP,6K,4K,AVI,DIVD / DIVX,,FLV,H,264,H,265,M4V,MPEG2,
MPEG4,PMP,Real 8/9/10,RM,VC-1,VOB,WMV



10/100M Ethernet, 802.11 b/g/n 2.4G/WiFi.



Android 9.0 OS, OTA-Upgrade-Unterstützung.

Manuale Utente

Contenuto della Confezione

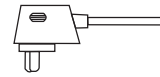
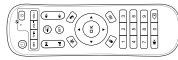
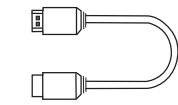

Dispositivo *1

Cavo HD*1 Telecomando*1 Adattatore di Alimentazione*1

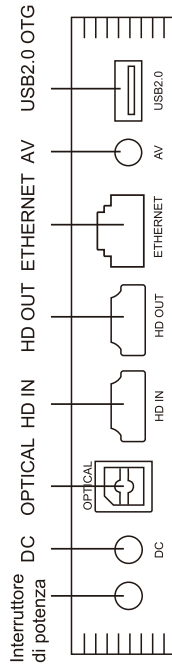

USB2.0 CARD USB3.0

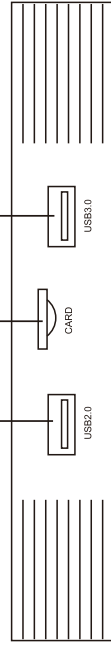

Schema di Collegamento

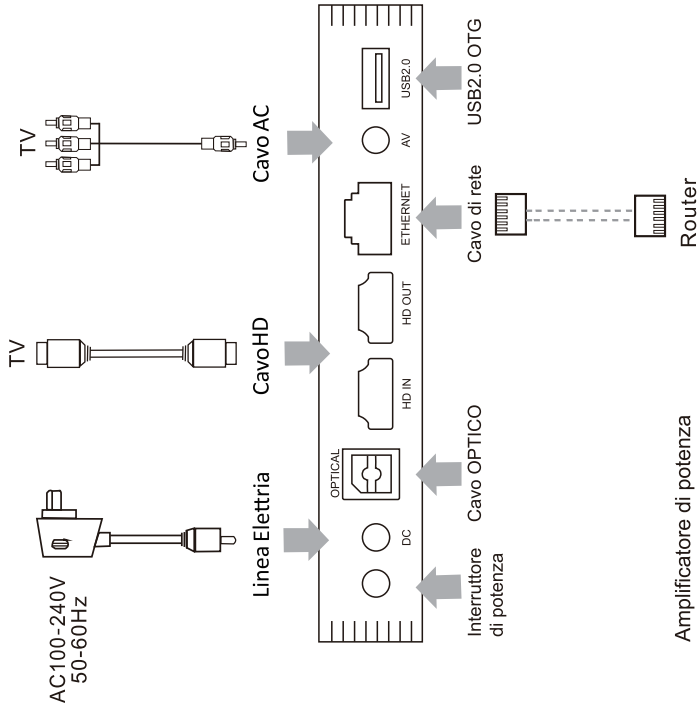

Passaggi di Installazione

- 01** Collegare la TV Box all'alimentazione.
- 02** Collegare la TV al televisore con il cavo HD o AV.
- 03** Per una connessione cablata, collegare il cavo Ethernet dal box TV al modem o router. Per wireless, seleziona la tua rete Wi-Fi e inserisci la tua password Wi-Fi.

La trasmissione dello schermo

Introduzione:

La TV Box ti consente di riprodurre foto, musica e video dallo smartphone o dal desktop sul televisore.

Preparazione:

Assicurati che il tuo dispositivo o TV Box siano collegati alla stessa rete.

Come Usare:

Dopo che il dispositivo o il TV Box sono collegati alla stessa rete, il logo  apparirà nell'applicazione per fine te dei dispositivi o fai clic su  e condividi foto, musica e video sul televisore.

Interazione a Più Stadi

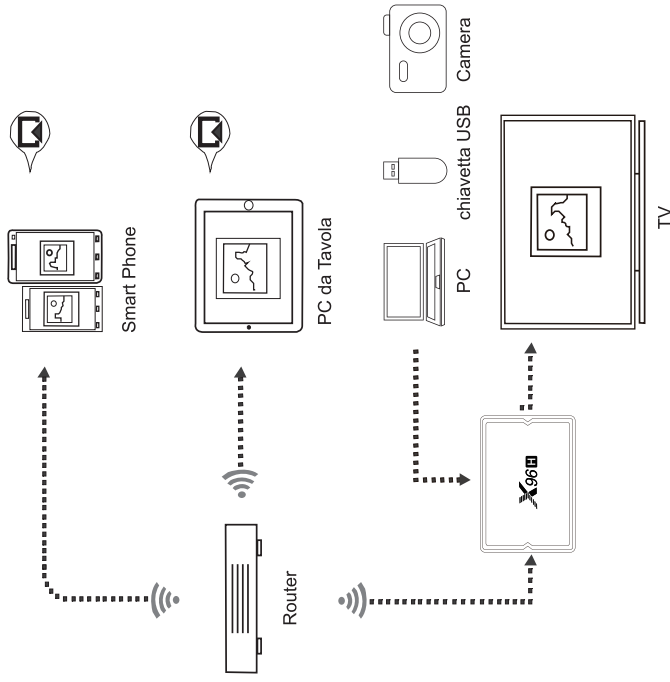

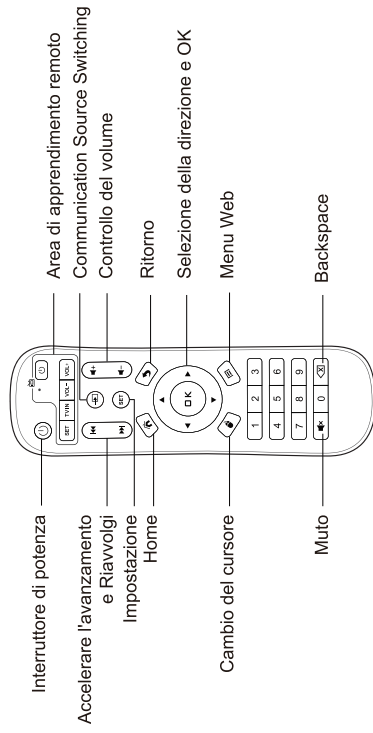

Funzioni di apprendimento TV

1. Premere il tasto di potenza blu per cinque secondi fino a quando l'indicatore LED non sia solido
2. Premere il tasto desiderato trovato nella sezione blu che si desidera programmare (LED inizierà a lampeggiare indicando che è pronto per essere programmato).
3. Mentre entrambi i telecomandi si affrontano a vicenda, premere e tenere la chiave di programmazione desiderata sul telecomando originale della TV per 1 -2 secondi.
4. LED lampeggerà e la chiave è stata programmata. You può scegliere un'altra chiave ripetendo i passi 2 &3.
5. Una volta completato, basta premere OK al centro di questo remoto per uscire dalla modalità di apprendimento.

Caratteristiche Chiave



Allwinner H603, Quad core ARM Cortex -A53@CPU.
Mali - T720 @GPU



3GP,6K,4K,AVI,DIVD / DIVX.,FLV,H.264,H.265,M4V,MPEG2,
MPEG4,PMP,Real 8/9/10,RM,VC-1,VOB,WMV



10/100M Ethernet,802.11b/g/n 2.4G /WiFi



Sistema operati o Android 9.0, supporto per l'aggiornamento OTA