

TEST REPORT

of

FCC PART 15 SUBPART E

New Application; Class I PC; Class II PC

Product : Display Unit
Brand: Aulisa
Model: GA-DU0003, GA-DU0003HDMI
Model Difference: For market segmentation
FCC ID: 2AI5QGA-DU0003
FCC Rule Part: §15.407, Cat:NII
Applicant: Taiwan Aulisa Medical Devices Technologies Inc
Address: 10F., No.3-2, YuanQu St., Nangang Dist., Taipei City, Taiwan 115

Test Performed by:

International Standards Laboratory

<LT Lab.>

*Site Registration No.

BSMI: SL2-IN-E-0013; MRA TW0997; TAF: 0997; IC: IC4067B-3;

*Address:

No. 120, Lane 180, Hsin Ho Rd., Lung-Tan Dist., Tao Yuan City 325, Taiwan

*Tel : 886-3-407-1718; Fax: 886-3-407-1738

Report No.: **ISL-18LR287FE**

Issue Date : **2018/11/05**



Test results given in this report apply only to the specific sample(s) tested and are traceable to national or international standard through calibration of the equipment and evaluating measurement uncertainty herein.

This report MUST not be used to claim product endorsement by TAF, NVLAP or any agency of the Government.

This test report shall not be reproduced except in full, without the written approval of International Standards Laboratory.



VERIFICATION OF COMPLIANCE

Applicant: Taiwan Aulisa Medical Devices Technologies Inc
Product Description: Display Unit
Brand Name: Aulisa
Model No.: GA-DU0003, GA-DU0003HDMI
Model Difference: For market segmentation
FCC ID: 2AI5QGA-DU0003
Date of test: 2018/09/13 ~ 2018/10/30
Date of EUT Received: 2018/09/13

We hereby certify that:

All the tests in this report have been performed and recorded in accordance with the standards described above and performed by an independent electromagnetic compatibility consultant, International Standards Laboratory.

The test results contained in this report accurately represent the measurements of the characteristics and the energy generated by sample equipment under test at the time of the test. The sample equipment tested as described in this report is in compliance with the limits of above standards.

Test By:		Date:	2018/11/05
	<hr/> <i>Barry Lee / Senior Engineer</i>		<hr/>
Prepared By:		Date:	2018/11/05
	<hr/> <i>Gigi Yeh / Senior Engineer</i>		<hr/>
Approved By:		Date:	2018/11/05
	<hr/> <i>Dino Chen / Senior Engineer</i>		<hr/>

Version

Version No.	Date	Description
00	2018/11/05	Initial creation of document

Uncertainty of Measurement

Description Of Test	Uncertainty
Conducted Emission (AC power line)	2.586 dB
Field Strength of Spurious Radiation	$\leq 30\text{MHz}$: 2.96dB 30-1GHz: 4.22 dB 1-40 GHz: 4.08 dB
Conducted Power	2.412 GHz: 1.30 dB 5.805 GHz: 1.55 dB
Power Density	2.412 GHz: 1.30 dB 5.805 GHz: 1.67 dB
Frequency	0.0032%
Time	0.01%
DC Voltage	1%

Table of Contents

1. General Information.....	6
1.1. Product Description	6
1.2. Related Submittal(s) / Grant (s)	8
1.3. Test Methodology	8
1.4. Test Facility.....	8
1.5. Special Accessories	8
1.6. Equipment Modifications.....	8
2. System Test Configuration.....	9
2.1. EUT Configuration	9
2.2. EUT Exercise	9
2.3. Test Procedure.....	9
2.4. Configuration of Tested System.....	10
3. Summary of Test Results.....	11
4. Description of Test Modes.....	12
5. Conduced Emission Test	13
5.1. Standard Applicable	13
5.2. Measurement Equipment Used:	13
5.3. EUT Setup:.....	13
5.4. Measurement Procedure:	14
5.5. Measurement Result:	14
6. OUTPUT POWER / EIRP /SPECTRAL DENSITY MEASUREMENT.....	17
6.1. Standard Applicable	17
6.2. Measurement Procedure.....	19
6.3. Measurement Equipment Used:	20
6.4. Measurement Equipment Used:	20
6.5. Measurement Result.....	21
7. 26dB /99% Emission Bandwidth Measurement.....	38
7.1. Standard Applicable	38
7.2. Measurement Procedure.....	38
7.3. Measurement Equipment Used:	38
7.4. Test Set-up:	38
7.5. Measurement Result.....	39
8. 6dB Emission Bandwidth Measurement.....	50
8.1. Standard Applicable	50
8.2. Measurement Procedure.....	50
8.3. Measurement Equipment Used:	50
8.4. Test Set-up:	50

8.5.	Measurement Result.....	51
9.	Undesirable emission – Radiated Measurement	56
9.1.	Standard Applicable	56
9.2.	EUT Setup.....	58
9.3.	Measurement Procedure.....	59
9.4.	Test SET-UP (Block Diagram of Configuration)	60
9.5.	Measurement Equipment Used:	61
9.6.	Field Strength Calculation	62
9.7.	Measurement Result.....	62
10.	Transmission in the Absence of Data	71
10.1.	Standard Applicable	71
10.2.	Result:	71
11.	Frequency Stability	72
11.1.	Standard Applicable	72
11.2.	Result	72
12.	Antenna Requirement	73
12.1.	Standard Applicable	73
12.2.	Antenna Connected Construction	73
13.	TPC and DFS MEASUREMENT	74
13.1.	TPC: Standard Applicable.....	74
13.2.	DFS: Standard Applicable.....	74
13.3.	Test Equipment Used:	80
13.4.	Test results	81
14.	Maximum Permissible Exposure (MPE)	84
14.1	Standard Applicable	84
14.2	Maximum Permissible Exposure (MPE) Evaluation	85

1. General Information

1.1. Product Description

General:

Product Name	Display Unit	
Brand Name	Aulisa	
Model Name	GA-DU0003, GA-DU0003HDMI	
Model Difference	For market segmentation	
Power Supply	12Vdc from AC/DC adapter	
	Adapter:	1. Model : MPU12A-102

Bluetooth:

Frequency Range:	2402 – 2480MHz	
Bluetooth Version:	V2.1 + EDR	V4.0
Channel number:	79 channels	40 channels, 2MHz step
Modulation type	GFSK $+\pi$ / 4DQPSK + 8DPSK	Wide band Modulation (GFSK)
Tune up power:	7.07 dBm Peak, +/- 1 dB	7.37 dBm (Peak), +/- 1 dB
Dwell Time:	$\leq 0.4s$	N/A
Antenna Designation:	Fixed Antenna Type: PIFA, 0.5Bi	

2.4GHz WLAN: 1TX/1RX SM-MIM; 5GHz WLAN: 1TX/1RX SM-MIMO

Wi-Fi	Frequency Range (MHz)	Channels	Peak / Average Rated Power	Modulation Technology
802.11b	2412 – 2462(DTS)	11	22.75dBm (PK)	DSSS
802.11g	2412 – 2462(DTS)	11	25.20dBm (PK)	OFDM
802.11n (2.4G)	HT20 2412 – 2462(DTS)	11	25.01dBm (PK)	
	HT40 2422 – 2452(DTS)	7	25.12dBm (PK)	
802.11a	5150 – 5350(NII)	8	12.01dBm (AV)	
	5470 – 5725(NII)	8	11.63dBm (AV)	
	5725 – 5850(NII)	5	9.15dBm (AV)	
802.11n(5G)	HT20 5150 – 5350(NII)	8	11.69dBm (AV)	
	HT20 5470 – 5725(NII)	8	11.30dBm (AV)	
	HT20 5725 – 5850(NII)	5	8.95dBm (AV)	
	HT40 5150 – 5350(NII)	7	12.15dBm (AV)	
	HT40 5470 – 5725(NII)	6	12.09dBm (AV)	
	HT40 5725 – 5850(NII)	2	9.24dBm (AV)	
Modulation type		CCK, DQPSK, DBPSK for DSSS 256QAM.64QAM. 16QAM, QPSK, BPSK for OFDM		
Antenna Designation		Fixed PIFA Antenna WiFi 2.4G Antenna 1 : 0.5dBi WiFi 5G Antenna : 0.5 dBi According to KDB662911 D01 SM-MIMO signals could be considered uncorrelated for purposes of directional gain computation. Directional gain = GANT		

The EUT is compliance with IEEE 802.11 a/n/ac Standard.

This report applies for Wifi frequency band 5150 MHz– 5250 MHz, 5725 MHz– 5850 MHz

Remark: The above DUT's information was declared by manufacturer. Please refer to the specifications or user's manual for more detailed description.

1.2. Related Submittal(s) / Grant (s)

This submittal(s) (test report) is intended for **FCC ID: 2AI5QGA-DU0003** filing to comply with Section 15.407 of the FCC Part 15, Subpart E Rules.

1.3. Test Methodology

Both conducted and radiated testing were performed according to the procedures in ANSI C63.10: 2013. Radiated testing was performed at an antenna to EUT distance 3 meters.

KDB Document: 789033 D02 General U-NII Test Procedures New Rules v02r01

FCC 14-30 Revision UNII

594280 D02 U-NII Device Security v01r03

1.4. Test Facility

The measurement facilities used to collect the 3m Radiated Emission and AC power line conducted data are located on the address of International Standards Laboratory <LT Lab.> No. 120, Lane 180, Hsin Ho Rd., Lung-Tan Dist., Tao Yuan City 325, Taiwan which are constructed and calibrated to meet the FCC requirements in documents ANSI C63.10: 2013. FCC Registration Number is: 487532; Designation Number is: TW0997, Canada Registration Number: 4067B-4.

1.5. Special Accessories

Not available for this EUT intended for grant.

1.6. Equipment Modifications

Not available for this EUT intended for grant.

2. System Test Configuration

2.1. EUT Configuration

The EUT configuration for testing is installed on RF field strength measurement to meet the Commissions requirement and operating in a manner which intends to maximize its emission characteristics in a continuous normal application.

2.2. EUT Exercise

The EUT (Transmitter) was operated in the engineering mode to fix the Tx frequency that was for the purpose of the measurements.

2.3. Test Procedure

2.3.1 Conducted Emissions

The EUT is a placed on as turn table which is 0.8 m above ground plane. According to the requirements in Section 6 of ANSI C63.10: 2013. Con-ducted emissions from the EUT measured in the frequency range between 0.15 MHz and 30MHz using CISPR 16-1-1 Quasi-Peak and Average detector mode.

2.3.2 Radiated Emissions

The EUT is a placed on as turn table which is 0.8 m/1.5m(Frequency above 1GHz) above ground plane. The turn table shall rotate 360 degrees to determine the position of maximum emission level. EUT is set 3m away from the receiving antenna which varied from 1m to 4m to find out the highest emission. And also, each emission was to be maximized by changing the polarization of receiving antenna both horizontal and vertical. In order to find out the max. emission, the relative positions of this hand-held transmitter (EUT) was rotated through three orthogonal axes and measurement procedures for electric field radiated emissions above 1 GHz the EUT measurement is to be made “while keeping the antenna in the ‘cone of radiation’ from that area and pointed at the area both in azimuth and elevation, with polarization oriented for maximum response.” is still within the 3dB illumination BW of the measurement antenna. according to the requirements in Section 6 and 11 of ANSI C63.10: 2013

2.4. Configuration of Tested System

Fig. 2-1 Configuration of Tested System

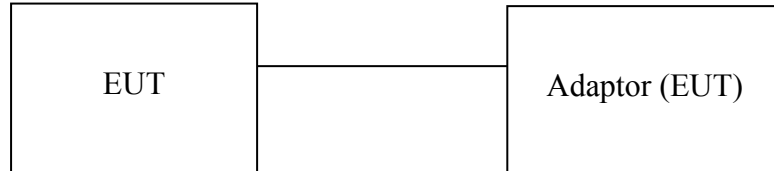

Table 1-1 Equipment Used in Tested System

Item	Equipment	Mfr/Brand	Model/ Type No.	Series No.	Data Cable	Power Cord
1	N/A					

3. Summary of Test Results

FCC Rules	Description Of Test	Result
§15.207	AC Power Line Conducted Emission	Compliant
§15.407(a)(2)	Output Power/ EIRP/ Spectral Density Measurement	Compliant
§15.407(a)	26dB Emission Bandwidth	Compliant
§15.407(e)	6dB Emission Bandwidth	Compliant
§15.407(b)	Undesirable Emission – Radiated Measurement	Compliant
§15.407(c)	Transmission in case of Absence of Information	Compliant
§15.407(g)	Frequency Stability	Compliant
§15.407(a)	Antenna Requirement	Compliant
§15.407(d)	TPC and DFS Measurement	Compliant
§15.407(i)	Device Security	Compliant

4. Description of Test Modes

The EUT has been tested under operating condition.

Test program used to control the EUT for staying in continuous transmitting mode is programmed.

5150MHz-5350MHz:

802.11a mode: Channel low (5180MHz)、 mid (5260MHz) and high (5320MHz) with 6Mbps lowest data rate are chosen for pre-test testing of radiated emissions.

802.11 n HT20: Channel low (5180MHz)、 mid (5260MHz) and high (5320MHz) with 6.5Mbps lowest data rate are chosen for pre-test testing of radiated emissions.

802.11 n HT40: Channel low (5190MHz)、 mid (5270MHz)and high (5310MHz) with 13.5Mbps lowest data rate are chosen for pre-test testing of radiated emissions.

The worst case Band 1, 802.11a was reported for Radiated Emission.

5470MHz-5725MHz:

802.11a mode: Channel low (5500MHz)、 mid (5600MHz) and high (5700MHz) with 6Mbps lowest data rate are chosen for pre-test testing of radiated emissions.

802.11 n HT20: Channel low (5500MHz)、 mid (5600MHz) and high (5700MHz) with 6.5Mbps lowest data rate are chosen for pre-test testing of radiated emissions.

802.11 n HT40: Channel low (5510MHz) 、 mid (5550MHz) and high (5670MHz) with 13.5Mbps lowest data rate are chosen for pre-test testing of radiated emissions.

The worst case Band 3, 802.11 n HT40 was reported for Radiated Emission.

5725MHz-5850MHz:

802.11a mode: Channel low (5745MHz), mid (5785MHz) and high (5825MHz) with 6Mbps lowest data rate are chosen for pre-test testing of radiated emissions.

802.11 n HT20: Channel low (5745MHz), mid (5785MHz) and high (5825MHz) with 6.5Mbps lowest data rate are chosen for pre-test testing of radiated emissions.

802.11 n HT40: Channel low (5755MHz) and high (5795MHz) with 13.5Mbps lowest data rate are chosen for pre-test testing of radiated emissions.

The worst case Band 4, 802.11 n HT40 was reported for Radiated Emission.

5. Conduced Emission Test

5.1. Standard Applicable

According to §15.207, frequency range within 150kHz to 30MHz shall not exceed the Limit table as below.

Frequency range MHz	Limits dB(uV)	
	Quasi-peak	Average
0.15 to 0.50	66 to 56	56 to 46
0.50 to 5	56	46
5 to 30	60	50

Note

- 1.The lower limit shall apply at the transition frequencies
- 2.The limit decreases linearly with the logarithm of the frequency in the range 0.15 MHz to 0.50 MHz.

5.2. Measurement Equipment Used:

Conducted Emission Test Site					
Equipment Type	MFR	Model Number	Serial Number	Last Cal.	Cal Due.
Conduction 04-3 Cable	WOKEN	CFD 300-NL	Conduction 04-3	09/11/2018	09/10/2019
EMI Receiver 16	Rohde & Schwarz	ESCI	101221	10/23/2018	10/22/2019
LISN 18	ROHDE & SCHWARZ	ENV216	101424	02/04/2018	02/03/2019
LISN 19	ROHDE & SCHWARZ	ENV216	101425	03/06/2018	03/05/2019
Test Software	Farad	EZEMC Ver:ISL-03A2	N/A	N/A	N/A

5.3. EUT Setup:

1. The conducted emission tests were performed in the test site, using the setup in accordance with the ANSI C63.10: 2013
2. The AC/DC Power adaptor of EUT was plug-in LISN. The EUT was placed flushed with the rear of the table.
3. The LISN was connected with 120Vac/60Hz power source.

5.4. Measurement Procedure:

1. The EUT was placed on a table which is 0.8m above ground plane.
2. Maximum procedure was performed on the six highest emissions to ensure EUT compliance.
3. Repeat above procedures until all frequency measured were complete.

5.5. Measurement Result:

The initial step in collecting conducted data is a spectrum analyzer peak scan of the measurement range. Significant peaks are then marked as shown on the following data page, and these signals are then quasi-peaked.

Note: Refer to next page for measurement data and plots.

AC POWER LINE CONDUCTED EMISSION TEST DATA

Operation Mode:	Normal Operation	Test Date:	2018/10/16
Test By:	Barry		



Address: No. 120, Lane 180, Hsin Ho Rd., Lung-Tan Dist.,
Tao Yuan City 325, Taiwan.
Tel: 03-4071718

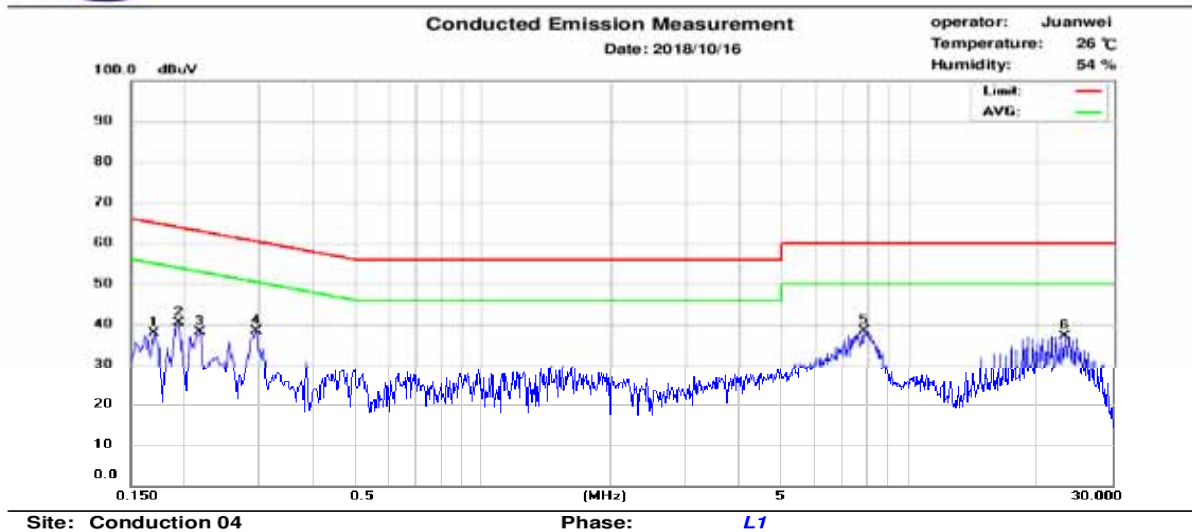

No.	Frequency (MHz)	QP_R (dBuV)	AVG_R (dBuV)	Correct Factor (dB)	QP Emission (dBuV)	QP Limit (dBuV)	QP Margin (dB)	AVG Emission (dBuV)	AVG Limit (dBuV)	AVG Margin (dB)
1	0.170	31.22	13.07	9.70	40.92	64.96	-24.04	22.77	54.96	-32.19
2	0.194	27.01	9.64	9.69	36.70	63.86	-27.16	19.33	53.86	-34.53
3	0.218	24.14	9.92	9.69	33.83	62.89	-29.06	19.61	52.89	-33.28
4	0.294	27.71	18.82	9.70	37.41	60.41	-23.00	28.52	50.41	-21.89
5	7.830	24.69	17.67	9.90	34.59	60.00	-25.41	27.57	50.00	-22.43
6	23.066	25.08	19.10	10.13	35.21	60.00	-24.79	29.23	50.00	-20.77



Address: No. 120, Lane 180, Hsin Ho Rd., Lung-Tan Dist.,
Tao Yuan City 325, Taiwan.
Tel: 03-4071718

Conducted Emission Measurement

operator: Juanwei
Temperature: 26 °C
Humidity: 54 %

Date: 2018/10/16

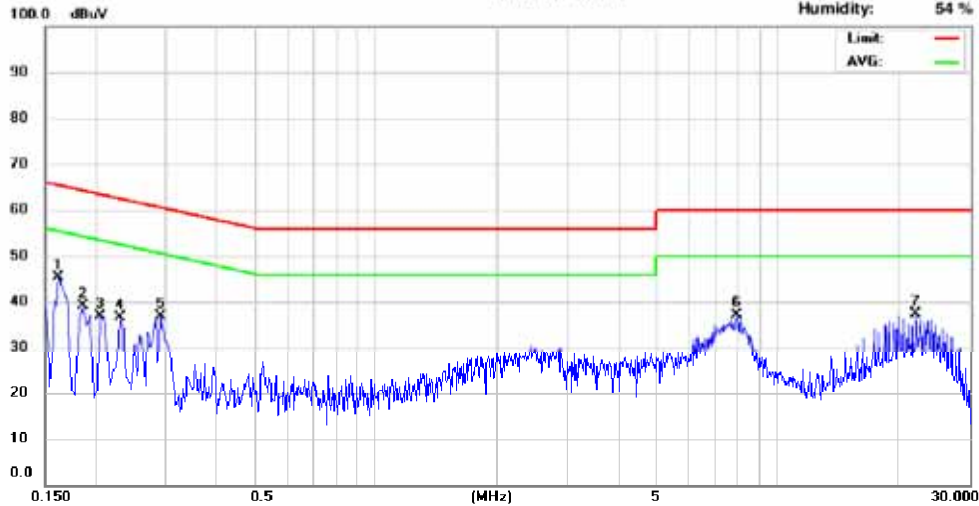

Site: Conduction 04

Phase: N

No.	Frequency (MHz)	QP_R (dBuV)	AVG_R (dBuV)	Correct Factor (dB)	QP Emission (dBuV)	QP Limit (dBuV)	QP Margin (dB)	AVG Emission (dBuV)	AVG Limit (dBuV)	AVG Margin (dB)
1	0.162	32.31	13.71	9.70	42.01	65.36	-23.35	23.41	55.36	-31.95
2	0.186	28.15	11.05	9.69	37.84	64.20	-26.36	20.74	54.20	-33.46
3	0.206	24.85	9.67	9.69	34.54	63.37	-28.83	19.36	53.37	-34.01
4	0.230	22.56	10.80	9.69	32.25	62.45	-30.20	20.49	52.45	-31.96
5	0.290	26.62	18.49	9.70	36.32	60.52	-24.20	28.19	50.52	-22.33
6	7.854	24.49	17.46	9.91	34.40	60.00	-25.60	27.37	50.00	-22.63
7	22.010	23.40	16.64	10.22	33.62	60.00	-26.38	26.86	50.00	-23.14

6. OUTPUT POWER / EIRP /SPECTRAL DENSITY MEASUREMENT

6.1. Standard Applicable

According to §15.407(a) Power limits:

(1) For the band 5.15-5.25 GHz.

(i) For an outdoor access point operating in the band 5.15 – 5.25 GHz, the maximum conducted output power over the frequency band of operation shall not exceed 1 W provided the maximum antenna gain does not exceed 6 dBi. In addition, the maximum power spectral density shall not exceed 17 dBm in any 1 megahertz band. If transmitting antennas of directional gain greater than 6 dBi are used, both the maximum conducted output power and the maximum power spectral density shall be reduced by the amount in dB that the directional gain of the antenna exceeds 6 dBi. The maximum e.i.r.p. at any elevation angle above 30 degrees as measured from the horizon must not exceed 125 mW (21 dBm).

(ii) For an indoor access point operating in the band 5.15 – 5.25 GHz, the maximum conducted output power over the frequency band of operation shall not exceed 1 W provided the maximum antenna gain does not exceed 6 dBi. In addition, the maximum power spectral density shall not exceed 17 dBm in any 1 megahertz band. If transmitting antennas of directional gain greater than 6 dBi are used, both the maximum conducted output power and the maximum power spectral density shall be reduced by the amount in dB that the directional gain of the antenna exceeds 6 dBi.

(iii) For fixed point-to-point access points operating in the band 5.15 – 5.25 GHz, the maximum conducted output power over the frequency band of operation shall not exceed 1 W. Fixed point-to-point U-NII devices may employ antennas with directional gain up to 23 dBi without any corresponding reduction in the maximum conducted output power or maximum power spectral density. For fixed point-to-point transmitters that employ a directional antenna gain greater than 23 dBi, a 1 dB reduction in maximum conducted output power and maximum power spectral density is required for each 1 dB of antenna gain in excess of 23 dBi. Fixed, point-to-point operations exclude the use of point-to-multipoint systems, omnidirectional applications, and multiple collocated transmitters transmitting the same information. The operator of the U-NII device, or if the equipment is professionally installed, the installer, is responsible for ensuring that systems employing high gain directional antennas are used exclusively for fixed, point-to-point operations.

(iv) For mobile and portable client devices in the 5.15 – 5.25 GHz band, the maximum conducted output power over the frequency band of operation shall not exceed 250 mW provided the maximum antenna gain does not exceed 6 dBi. In addition, the maximum power spectral density shall not exceed 11 dBm in any 1 megahertz band. If transmitting antennas of directional gain greater than 6 dBi are used, both the maximum conducted output power and the maximum power spectral density shall be reduced by the amount in dB that the directional gain of the antenna exceeds 6 dBi.

(2) For the 5.25-5.35 GHz and 5.47-5.725 GHz bands, the maximum conducted output power over the frequency bands of operation shall not exceed the lesser of 250 mW or $11 \text{ dBm} + 10 \log B$, where B is the 26 dB emission bandwidth in megahertz. In addition, the maximum power spectral density shall not exceed 11 dBm in any 1 megahertz band. If transmitting antennas of directional gain greater than 6 dBi are used, both the maximum conducted output power and the maximum power spectral density shall be reduced by the amount in dB that the directional gain of the antenna exceeds 6 dBi.

(3) For the band 5.725-5.85 GHz, the maximum conducted output power over the frequency band of operation shall not exceed 1 W. In addition, the maximum power spectral density shall not exceed 30 dBm in any 500 kHz band. If transmitting antennas of directional gain greater than 6 dBi are used, both the maximum conducted output power and the maximum power spectral density shall be reduced by the amount in dB that the directional gain of the antenna exceeds 6 dBi. However, fixed point-to-point U-NII devices operating in this band may employ transmitting antennas with directional gain greater than 6 dBi without any corresponding reduction in transmitter conducted power. Fixed, point-to-point operations exclude the use of point-to-multipoint systems, omnidirectional applications, and multiple collocated transmitters transmitting the same information. The operator of the U-NII device, or if the equipment is professionally installed, the installer, is responsible for ensuring that systems employing high gain directional antennas are used exclusively for fixed, point-to-point operations.

6.2. Measurement Procedure

For Output Power

1. Place the EUT on the table and set it in transmitting mode.
2. Remove the antenna from the EUT and then connect a low loss RF cable from the antenna port to the power meter
3. Record the max. reading.
4. Repeat above procedures until all frequency measured were complete.

For Power Spectral Density

1. Place the EUT on the table and set it in transmitting mode.
2. Remove the antenna from the EUT and then connect a low loss RF cable from the antenna port to Spectrum.
3. Set RBW=1MHz,VBW=3MHz, Span=50MHz (Base Mode), Sweep time = Auto, traces 100 sweeps of video averaging for 5150-5725MHz;
4. Set RBW=500kHz,VBW=1.5MHz, Span=60MHz (Base Mode), Sweep time = Auto, traces 100 sweeps of video averaging for 5725-5850MHz;
5. Record the max. reading.
6. Repeat above procedures until all frequency measured were complete.

Refer to section E3 of KDB Document: KDB 789033 D02 General UNII Test Procedures New Rules v01r03

6.3. Measurement Equipment Used:

Conducted Emission Test Site					
Equipment Type	MFR	Model Number	Serial Number	Last Cal.	Cal Due.
Power Meter 05	Anritsu	ML2495A	1116010	09/07/2018	09/06/2019
Power Sensor 05	Anritsu	MA2411B	34NKF50	09/07/2018	09/06/2019
Power Sensor 06	DARE	RPR3006W	13I00030SN O33	12/12/2017	12/11/2018
Power Sensor 07	DARE	RPR3006W	13I00030SN O34	12/12/2017	12/11/2018
Temperature Chamber	KSON	THS-B4H100	2287	12/02/2017	12/01/2018
DC Power supply	ABM	8185D	N/A	11/06/2017	11/05/2018
AC Power supply	EXTECH	CFC105W	NA	12/25/2017	12/24/2018
Attenuator	Woken	Watt-65m3502	11051601	NA	NA
Splitter	MCLI	PS4-199	12465	12/26/2017	12/25/2019
Spectrum analyzer	keysight	N9010A	MY56070257	07/07/2018	07/06/2019
Spectrum analyzer	R&S	FSP40	100143	11/02/2017	11/01/2018
Test Software	DARE	Radimation Ver:2013.1.23	NA	NA	NA

6.4. Measurement Equipment Used:

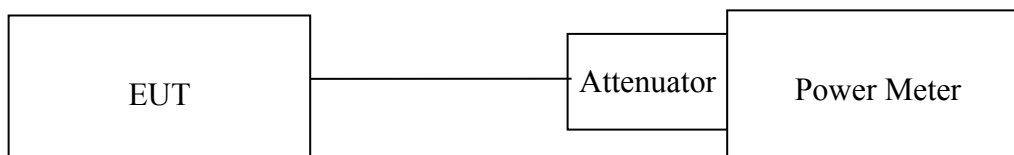

6.5. Measurement Result

According to §15.407(a)

(iii) For fixed point-to-point access points, Power limit is 1W.

Average Power Measurement:

802.11a

Mode	Channel	power (dBm)	limit(dBm)	result
802.11a	5180	11.34	23.97	pass
	5260	12.01	23.97	pass
	5320	11.91	23.97	pass
	5500	11.20	23.97	pass
	5600	11.63	23.97	pass
	5700	11.05	23.97	pass
	5745	8.67	30	pass
	5785	9.15	30	pass
	5825	8.05	30	pass

802.11n HT20

Mode	Freq(MHz)	power (dBm)	limit(dBm)	result
802.11n HT20	5180	10.66	23.97	pass
	5260	11.69	23.97	pass
	5320	11.56	23.97	pass
	5500	10.82	23.97	pass
	5580	11.3	23.97	pass
	5700	10.6	23.97	pass
	5745	8.47	30	pass
	5785	8.95	30	pass
	5825	8.02	30	pass

802.11n HT40

Mode	Freq(MHz)	power (dBm)	limit(dBm)	result
802.11n HT40	5190	10.15	23.97	pass
	5230	10.62	23.97	pass
	5270	11.02	23.97	pass
	5290	12.15	23.97	pass
	5310	11.26	23.97	pass
	5510	10.52	23.97	pass
	5690	12.09	23.97	pass
	5755	9.32	30	pass
	5795	9.24	30	pass

Power Spectral Density Measurement:

802.11a Mode

Frequency MHz	RF Power Density Reading (dBm/MHz)	Cable loss (dB)	Maximum Limit (dBm/MHz)
5180	6.67	0.00	11
5260	6.78	0.00	11
5320	6.85	0.00	11
5500	5.70	0.00	11
5600	6.33	0.00	11
5700	5.67	0.00	11
Frequency MHz	RF Power Density Reading (dBm/500KHz)	Cable loss (dB)	Maximum Limit (dBm/500KHz)
5745	1.12	0.00	30
5785	0.33	0.00	30
5825	0.45	0.00	30

802.11n HT20

Frequency MHz	RF Power Density Reading (dBm/MHz)	Cable loss (dB)	Maximum Limit (dBm/MHz)
5180	6.57	0.00	11
5260	6.47	0.00	11
5320	6.67	0.00	11
5500	5.62	0.00	11
5580	6.04	0.00	11
5700	5.35	0.00	11
Frequency MHz	RF Power Density Reading (dBm/500KHz)	Cable loss (dB)	Maximum Limit (dBm/500KHz)
5745	0.77	0.00	30
5785	1.87	0.00	30
5825	0.63	0.00	30

802.11n HT40 Mode

Frequency MHz	RF Power Density Reading (dBm/MHz)	Cable loss (dB)	Maximum Limit (dBm/MHz)
5190	2.29	0.00	11
5270	2.35	0.00	11
5310	2.09	0.00	11
5510	1.40	0.00	11
5550	1.86	0.00	11
5670	1.56	0.00	11
Frequency MHz	RF Power Density Reading (dBm/500KHz)	Cable loss (dB)	Maximum Limit (dBm/500KHz)
5755	0.33	0.00	30
5795	0.13	0.00	30

BAND 1, 2

802.11a

Power Spectral Density Data Plot (CH Low)



Power Spectral Density Data Plot (CH Mid)

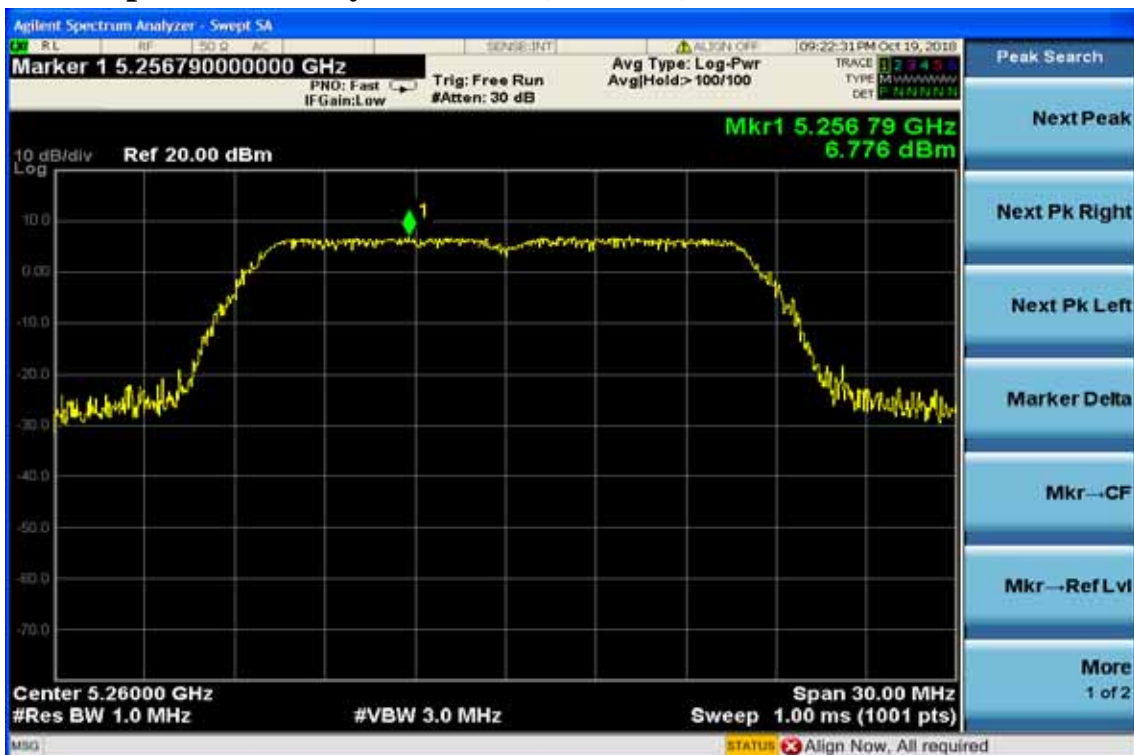

Power Spectral Density Data Plot (CH High)

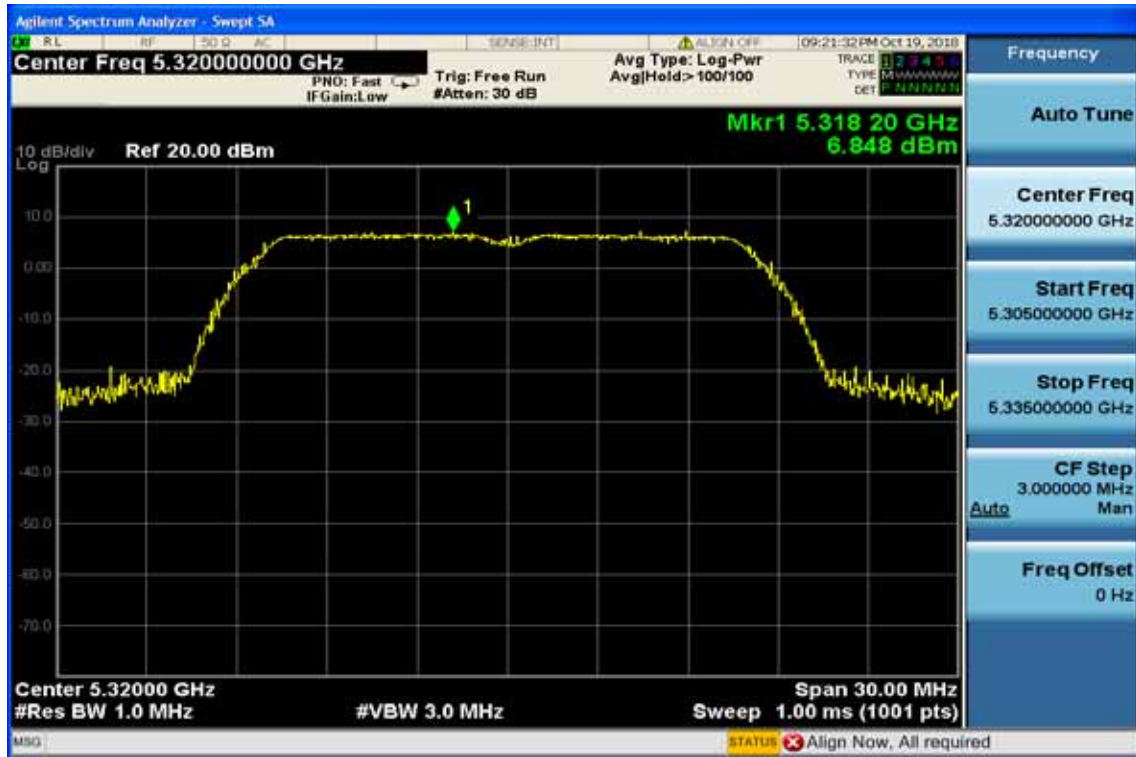

802.11n HT20,

Power Spectral Density Test Plot (CH-Low)



Power Spectral Density Test Plot (CH-Mid)

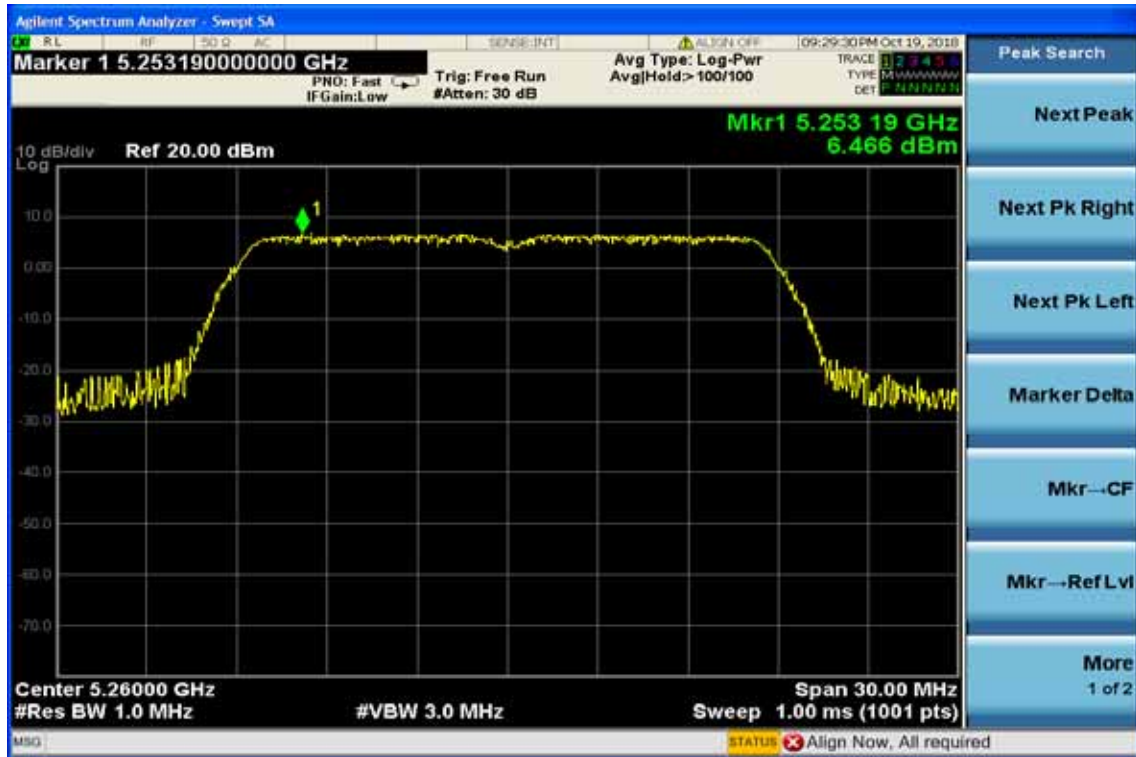

Power Spectral Density Test Plot (CH-High)



802.11n HT40,
Power Spectral Density Test Plot (CH-Low)



Power Spectral Density Test Plot (CH-Mid)



Power Spectral Density Test Plot (CH-High)



BAND 3 802.11a Power Spectral Density Data Plot (CH Low)



Power Spectral Density Data Plot (CH Mid)



Power Spectral Density Data Plot (CH High)



802.11n HT20,
Power Spectral Density Test Plot (CH-Low)



Power Spectral Density Test Plot (CH-Mid)

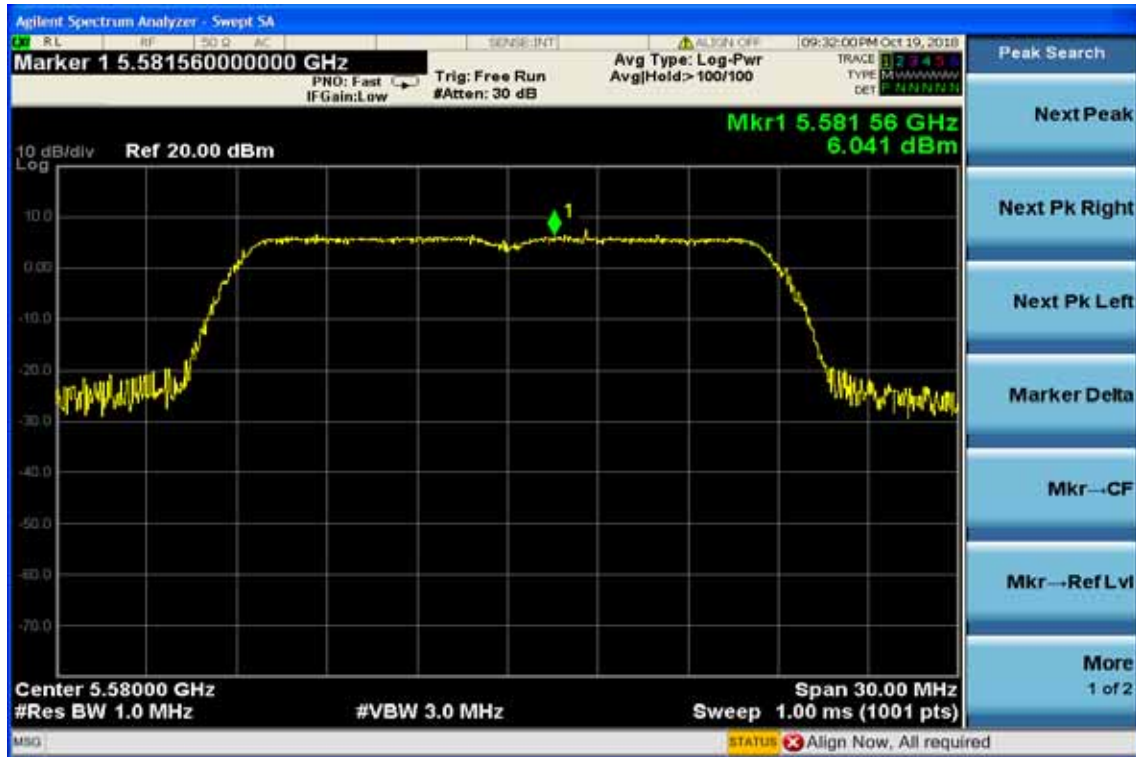

Power Spectral Density Test Plot (CH-High)



802.11n HT40, Power Spectral Density Test Plot (CH-Low)



Power Spectral Density Test Plot (CH-Mid)



Power Spectral Density Test Plot (CH-High)



BAND 4
802.11a
Power Spectral Density Data Plot (CH Low)



Power Spectral Density Data Plot (CH Mid)

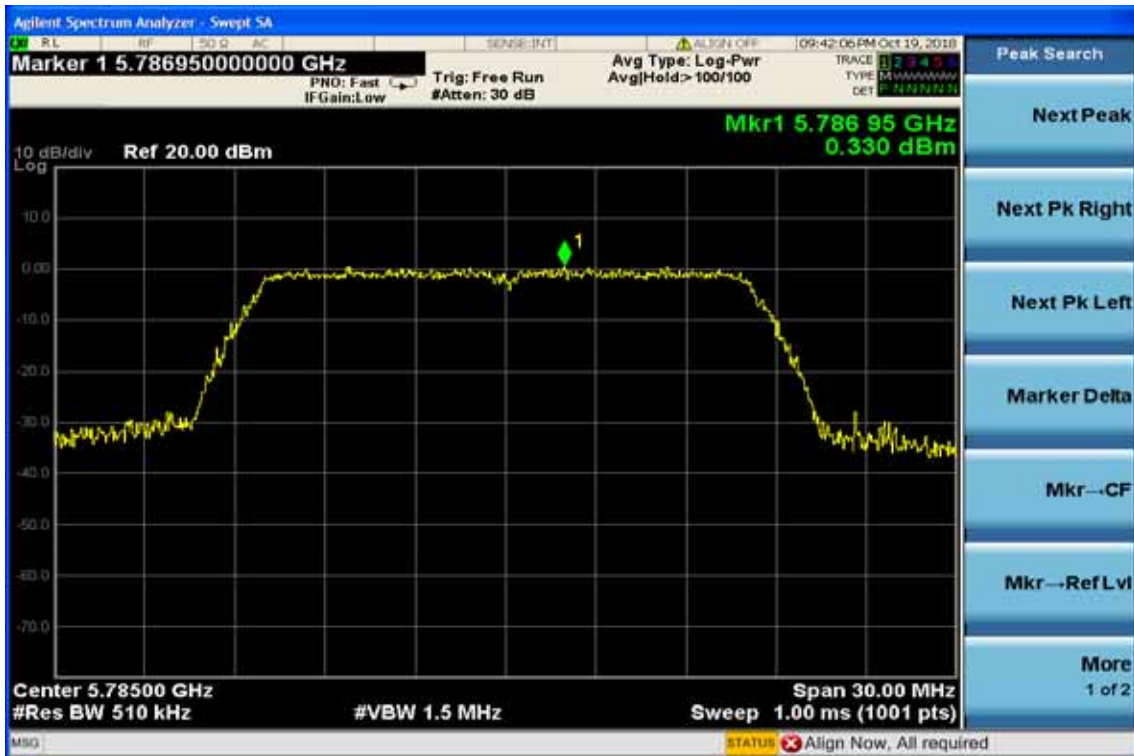

Power Spectral Density Data Plot (CH High)



802.11n HT20, Power Spectral Density Test Plot (CH-Low)

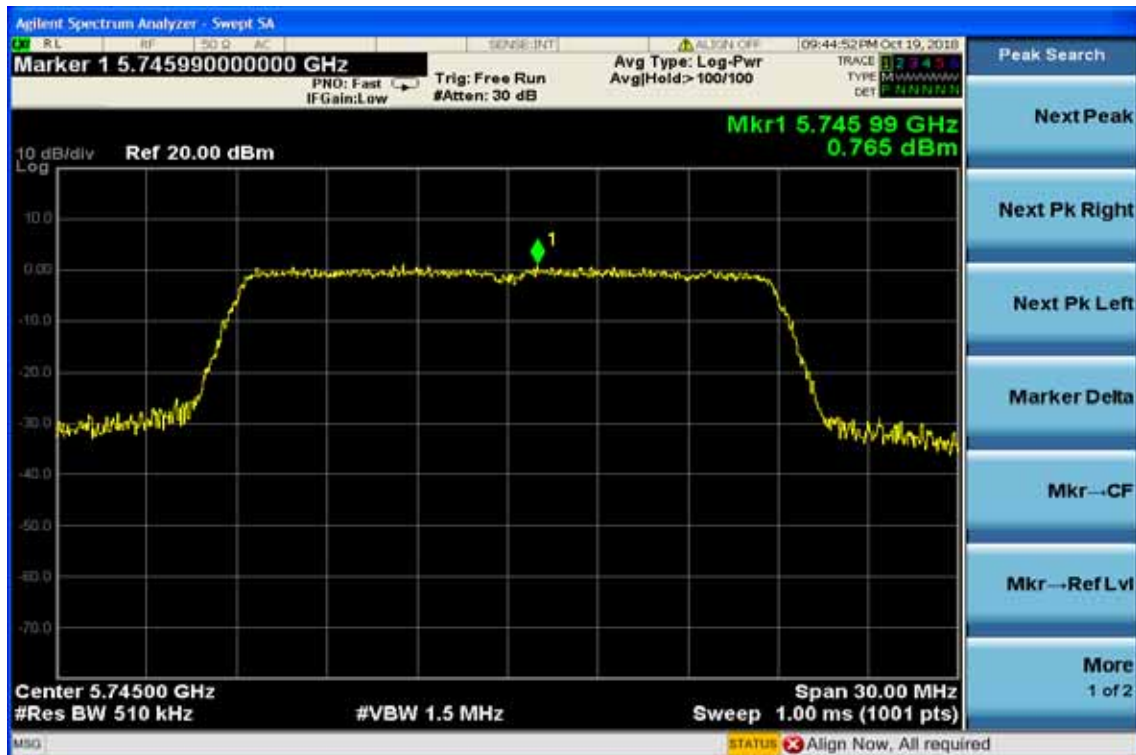

Power Spectral Density Test Plot (CH-Mid)



Power Spectral Density Test Plot (CH-High)



**802.11n HT40,
Power Spectral Density Test Plot (CH-Low)**



Power Spectral Density Test Plot (CH-High)



7. 26dB /99% Emission Bandwidth Measurement

7.1. Standard Applicable

According to §15.407(a) for band 1,2,3. No Limit required.

7.2. Measurement Procedure

1. Place the EUT on the table and set it in transmitting mode.
2. Remove the antenna from the EUT and then connect a low loss RF cable from the antenna port to the spectrum analyzer.
3. Set the spectrum analyzer as RBW=300kHz, VBW =1MHz, Span= 50MHz, Sweep=auto
4. Mark the peak frequency and -26dB (upper and lower) frequency.
5. Repeat above procedures until all frequency measured were complete.

Refer to section D of KDB Document: KDB 789033 D02 General UNII Test Procedures New Rules v01r03

7.3. Measurement Equipment Used:

Refer to section 6.3 for details.

7.4. Test Set-up:

Refer to section 6.4 for details.

7.5. Measurement Result

802.11a Mode

Frequency (MHz)	26dB Bandwidth (MHz)	99% Bandwidth (MHz)
5180	21.060	16.713
5260	20.840	16.782
5320	19.630	16.668
5500	22.150	16.743
5600	20.670	16.676
5700	19.860	16.652

802.11n HT20 Mode

Frequency (MHz)	26dB Bandwidth (MHz)	99% Bandwidth (MHz)
5180	22.430	17.690
5260	20.480	17.656
5320	20.650	17.623
5500	20.600	17.658
5600	22.580	17.667
5700	19.820	17.631

802.11n HT40 Mode

Frequency (MHz)	26dB Bandwidth (MHz)	99% Bandwidth (MHz)
5190	39.800	35.960
5270	45.060	35.995
5310	42.020	35.974
5510	47.230	36.028
5550	46.610	36.046
5670	46.870	35.993

Band 1, 2

802.11a

26dB / 99% Band Width Test Data CH-Low

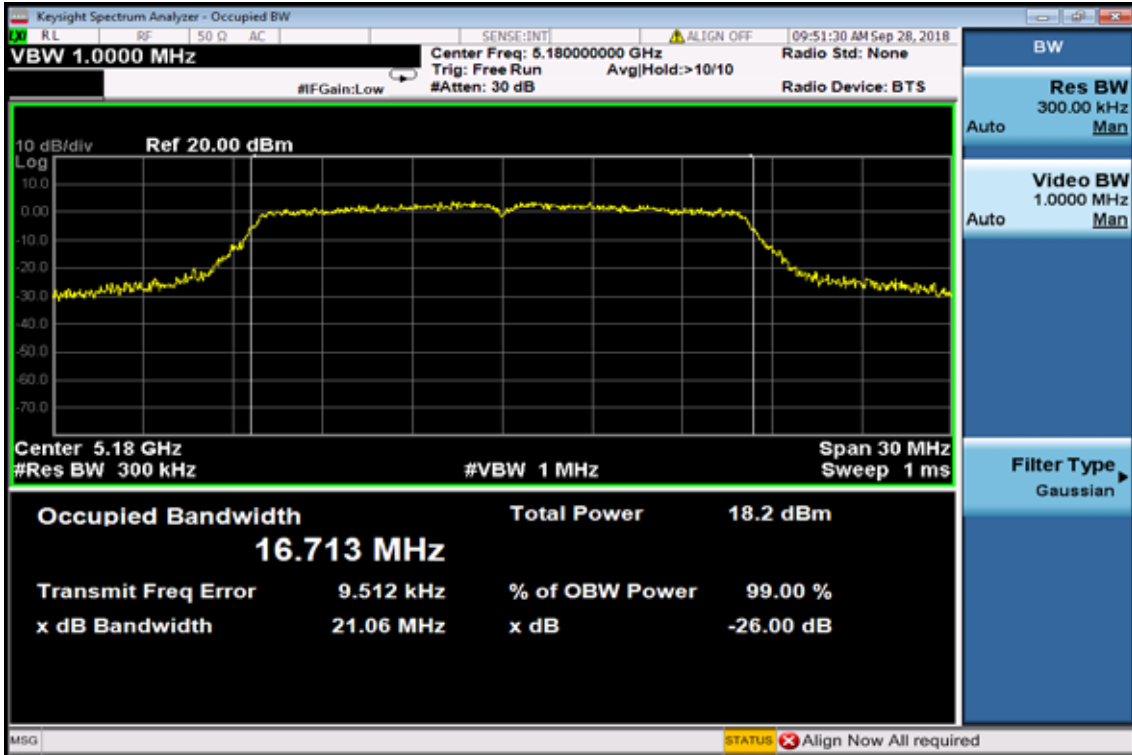

26dB / 99% Band Width Test Data CH-Mid

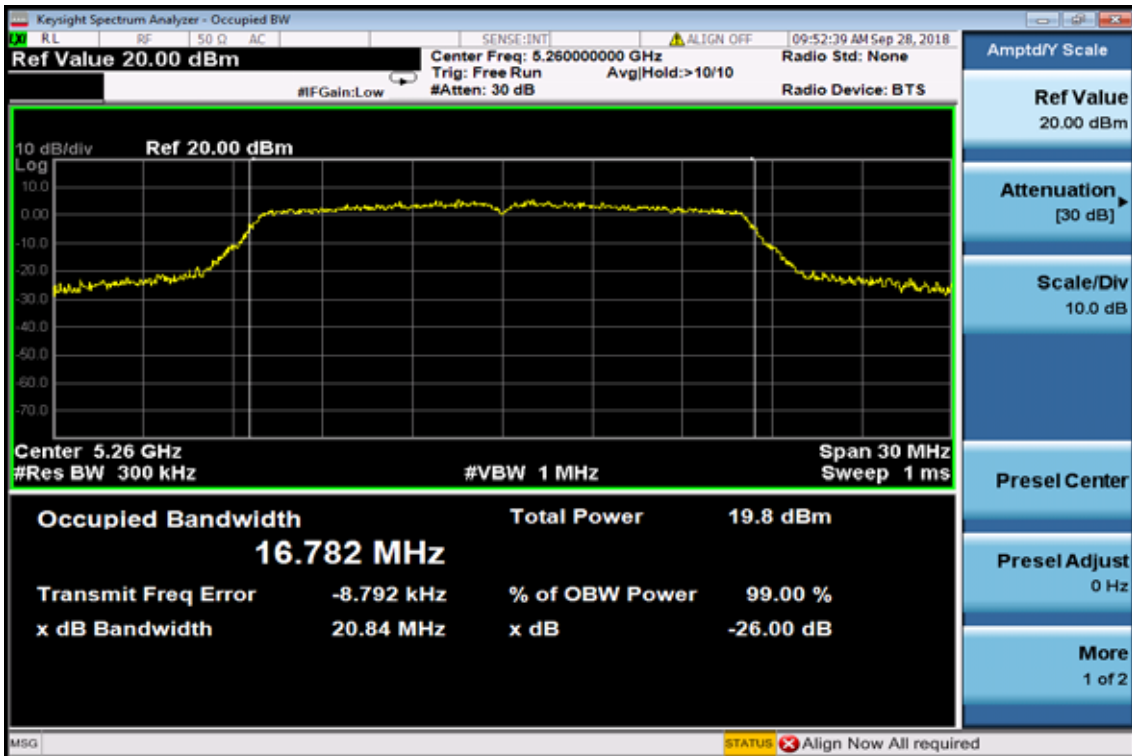

26dB / 99% Band Width Test Data CH-High

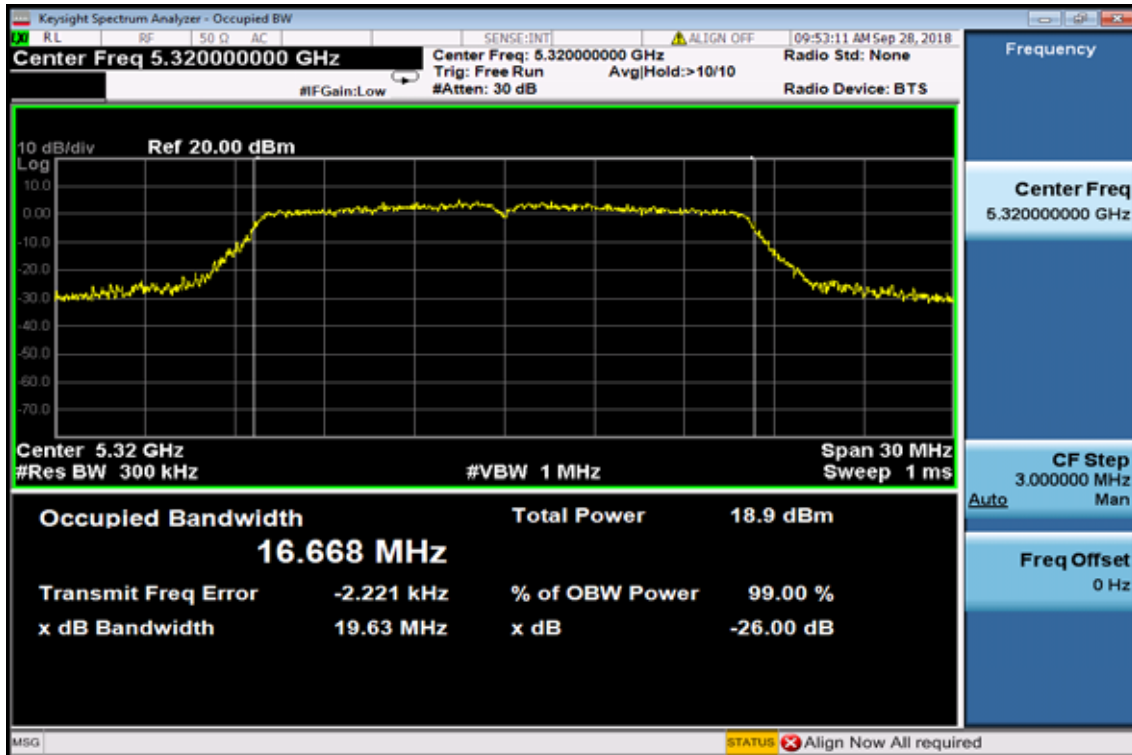

802.11n HT20

26dB / 99% Band Width Test Data CH-Low

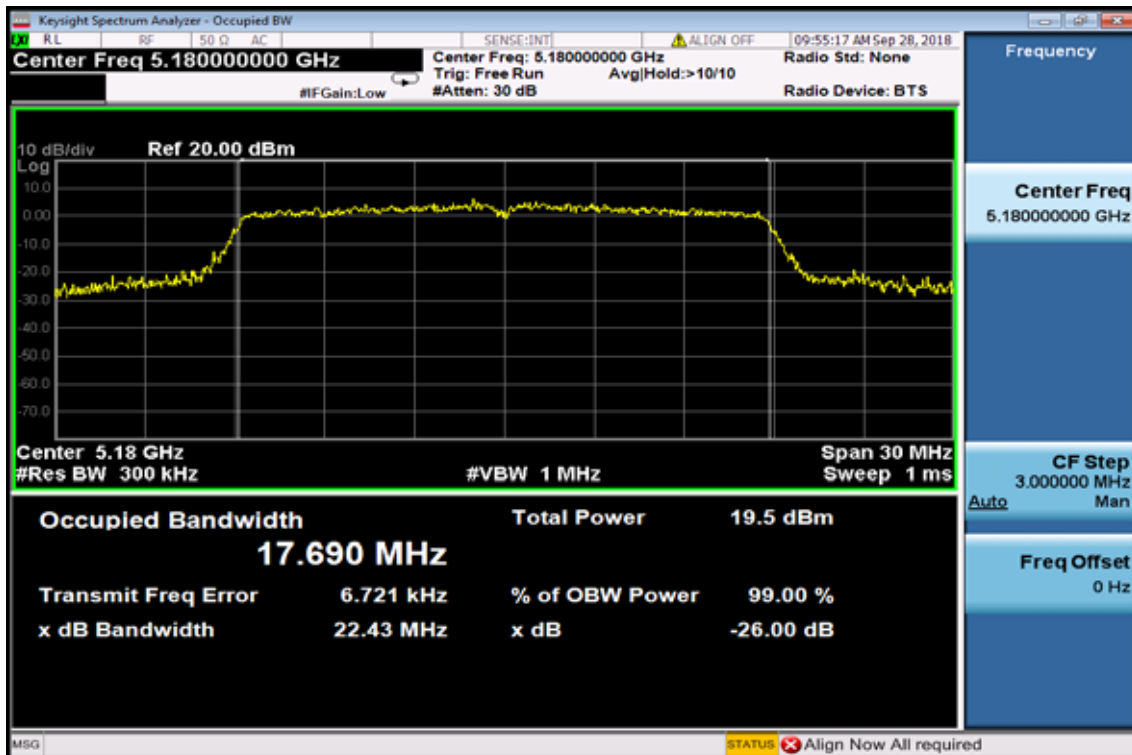

26dB / 99% Band Width Test Data CH-Mid

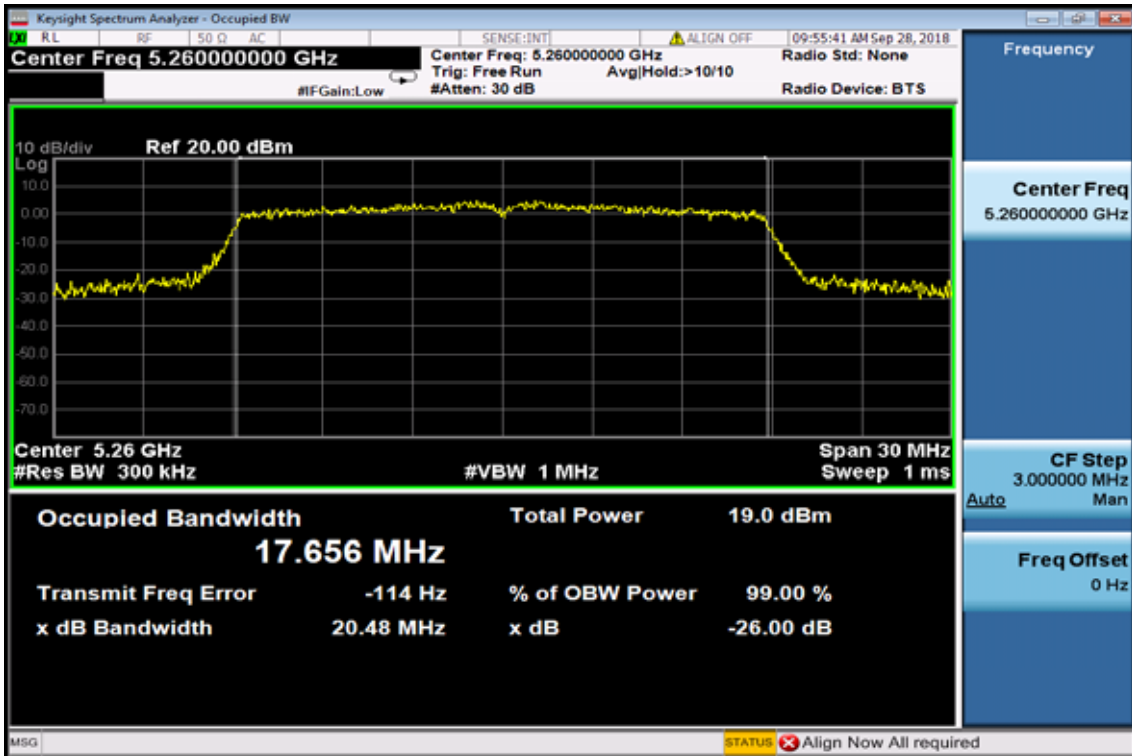

26dB / 99% Band Width Test Data CH-High

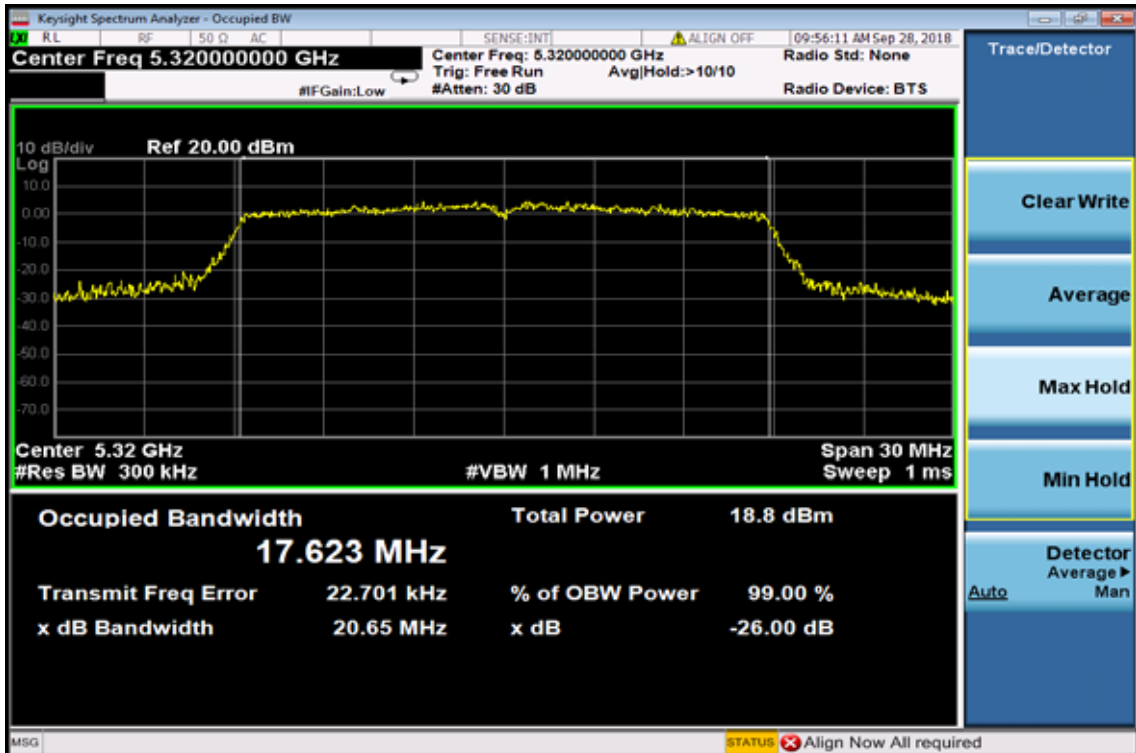

802.11n HT40

26dB / 99% Band Width Test Data CH-Low

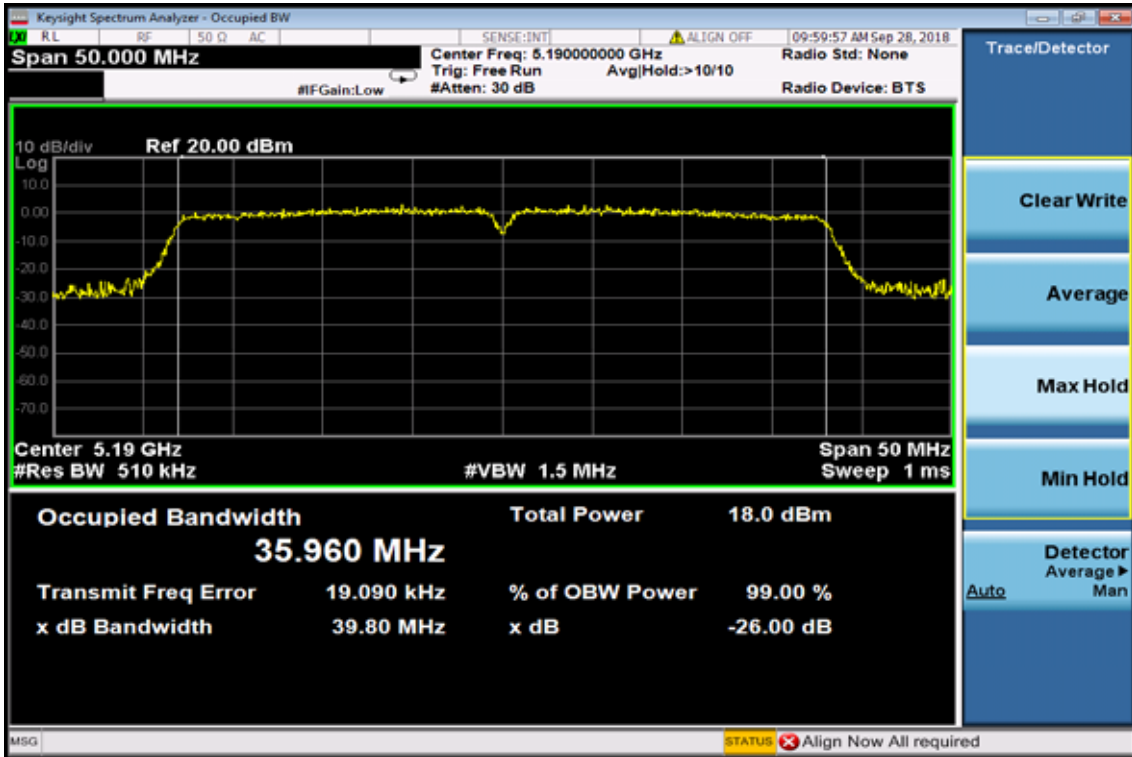

26dB / 99% Band Width Test Data CH-Mid

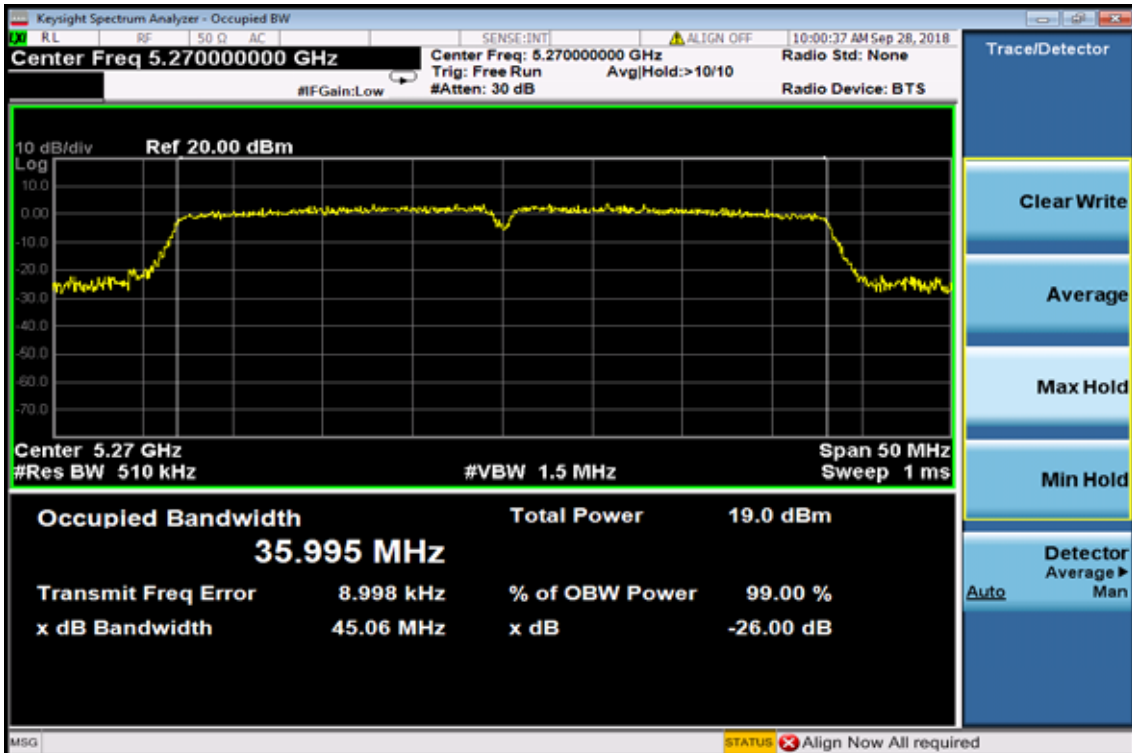

26dB / 99% Band Width Test Data CH-High

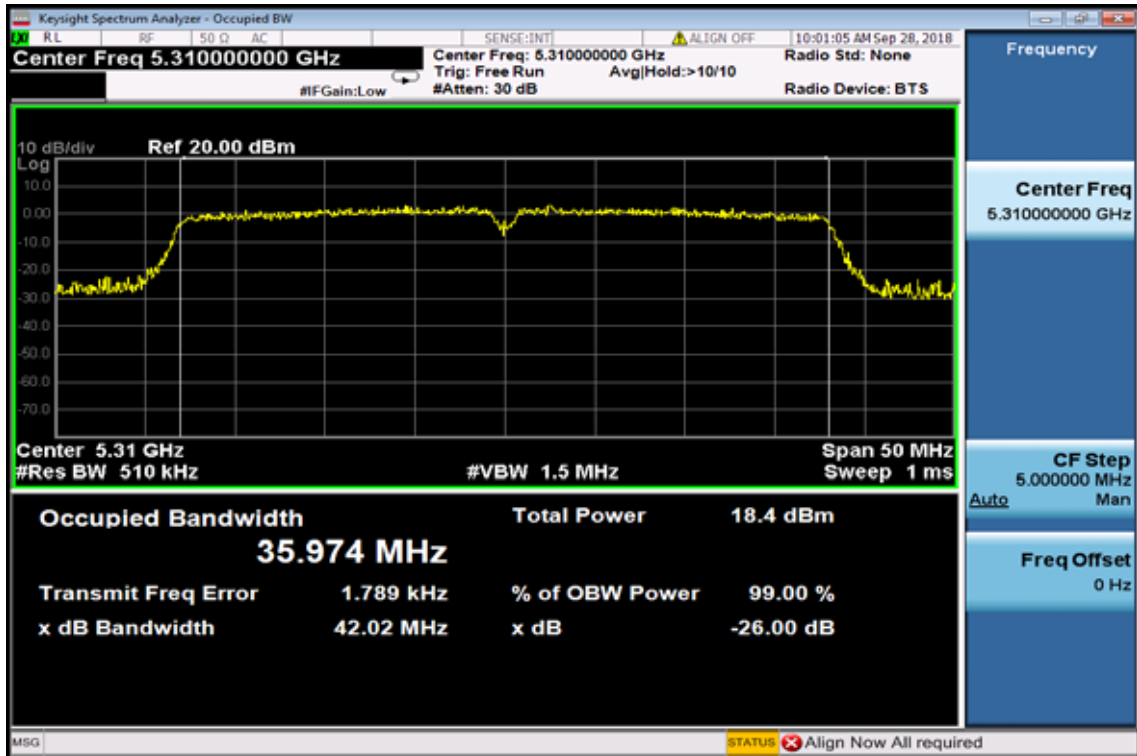

Band 3

802.11a

26dB / 99% Band Width Test Data CH-Low

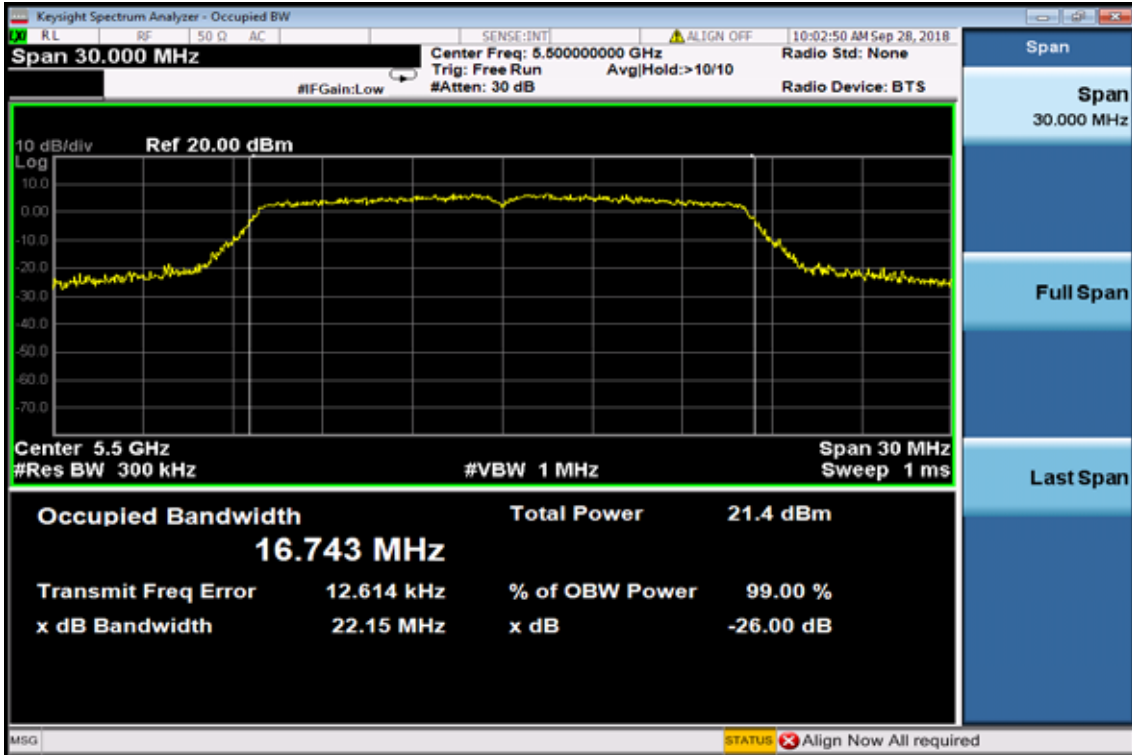

26dB / 99% Band Width Test Data CH-Mid

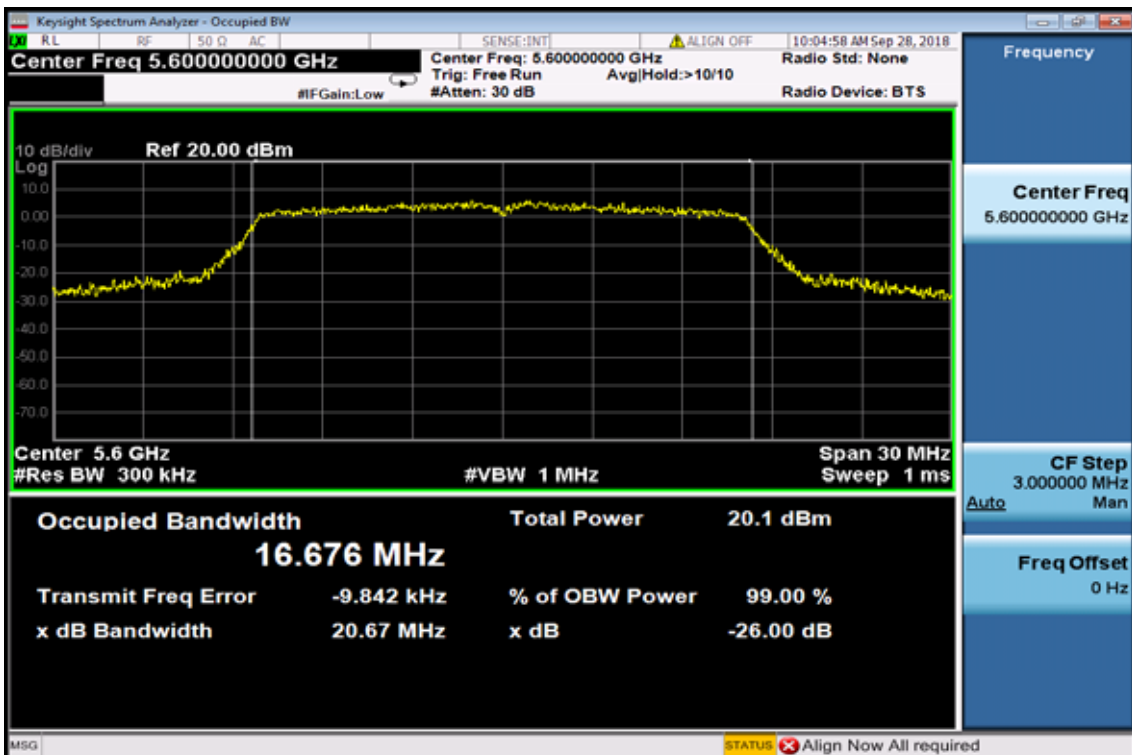

26dB / 99% Band Width Test Data CH-High

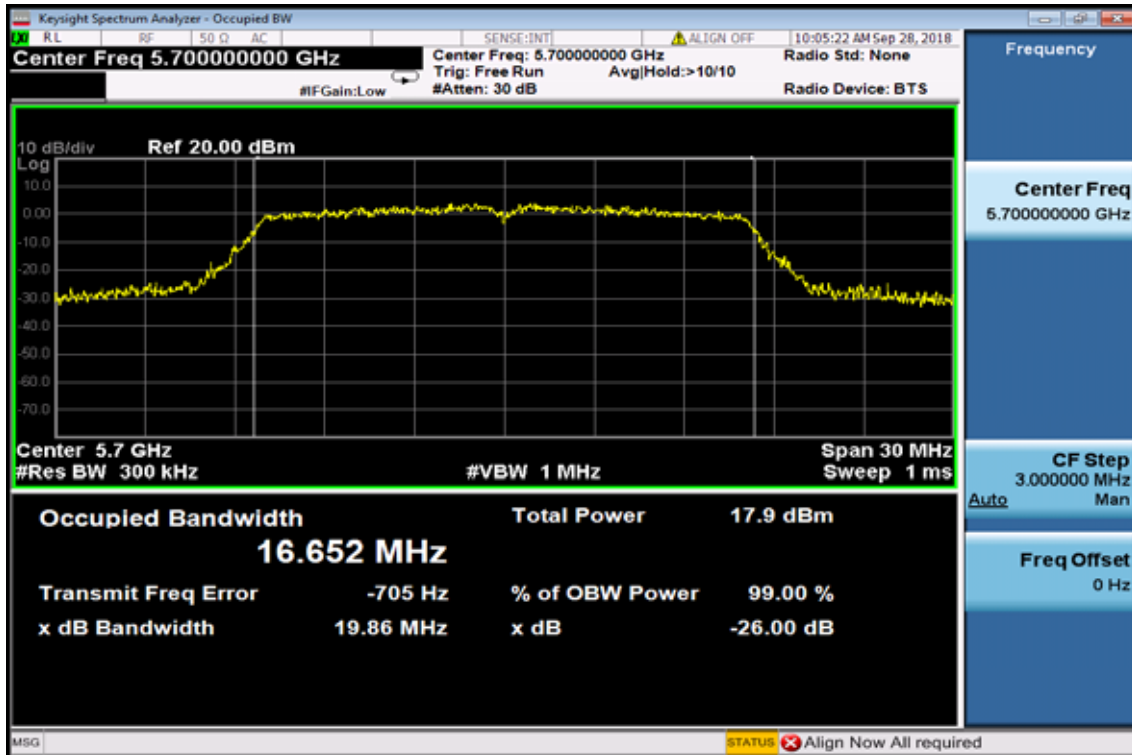

802.11n HT20

26dB / 99% Band Width Test Data CH-Low

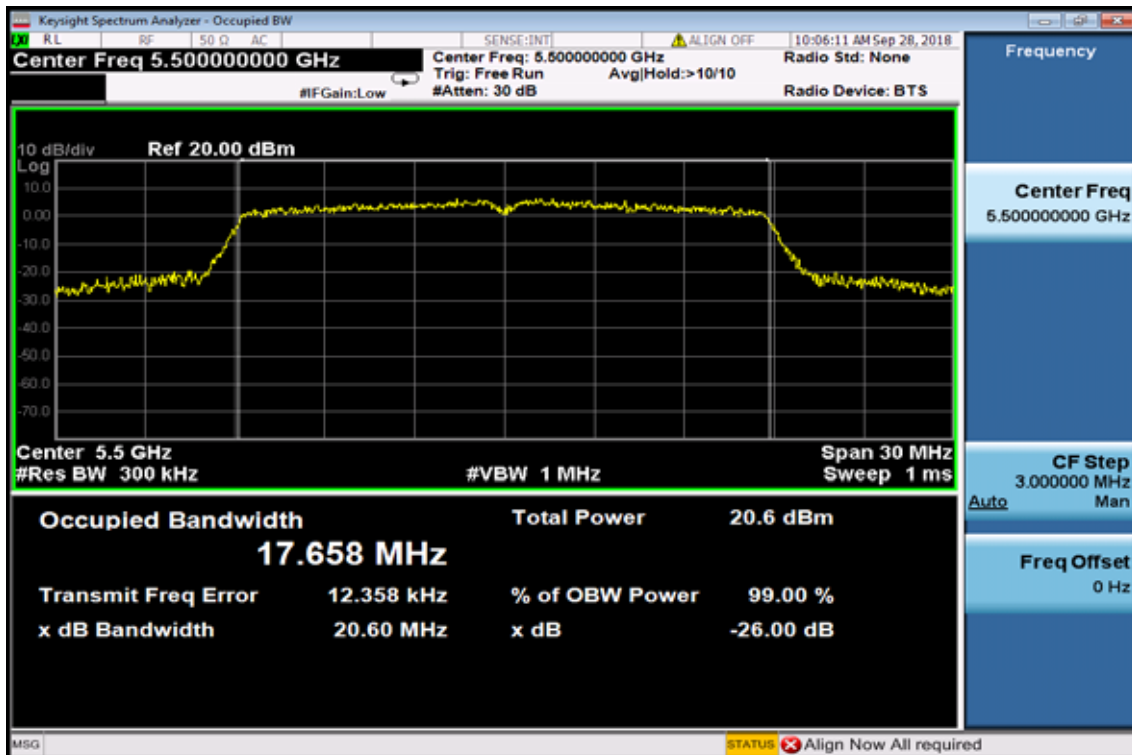

26dB / 99% Band Width Test Data CH-Mid

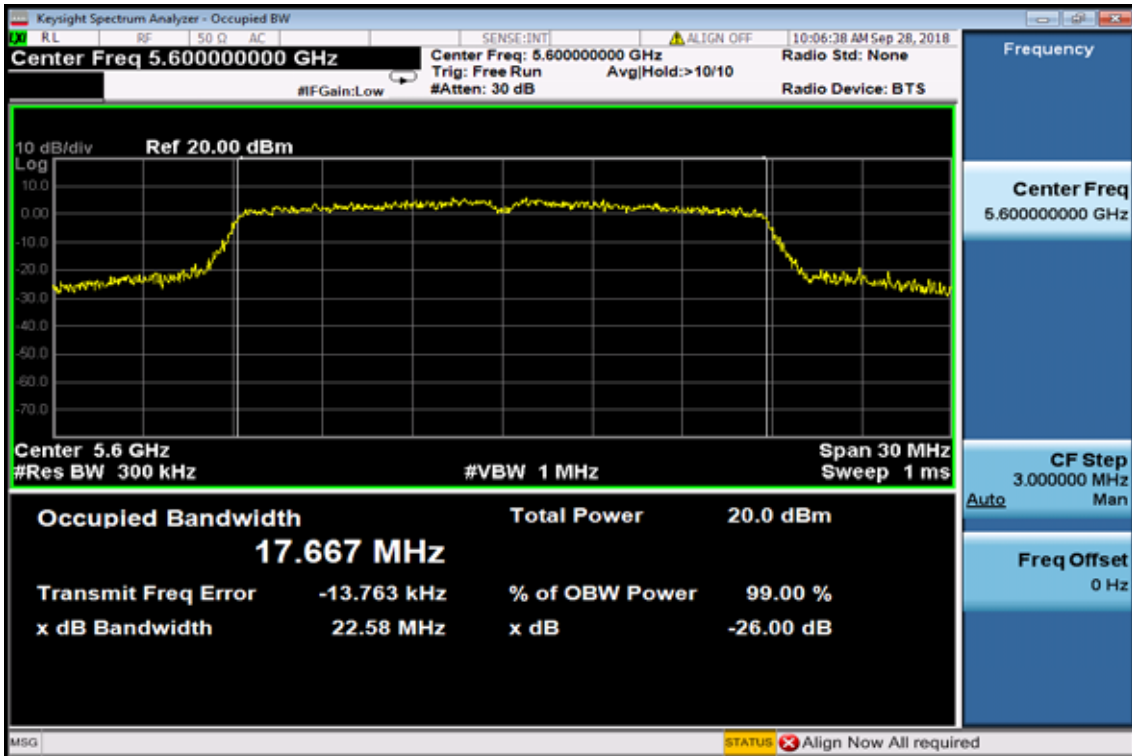

26dB / 99% Band Width Test Data CH-High

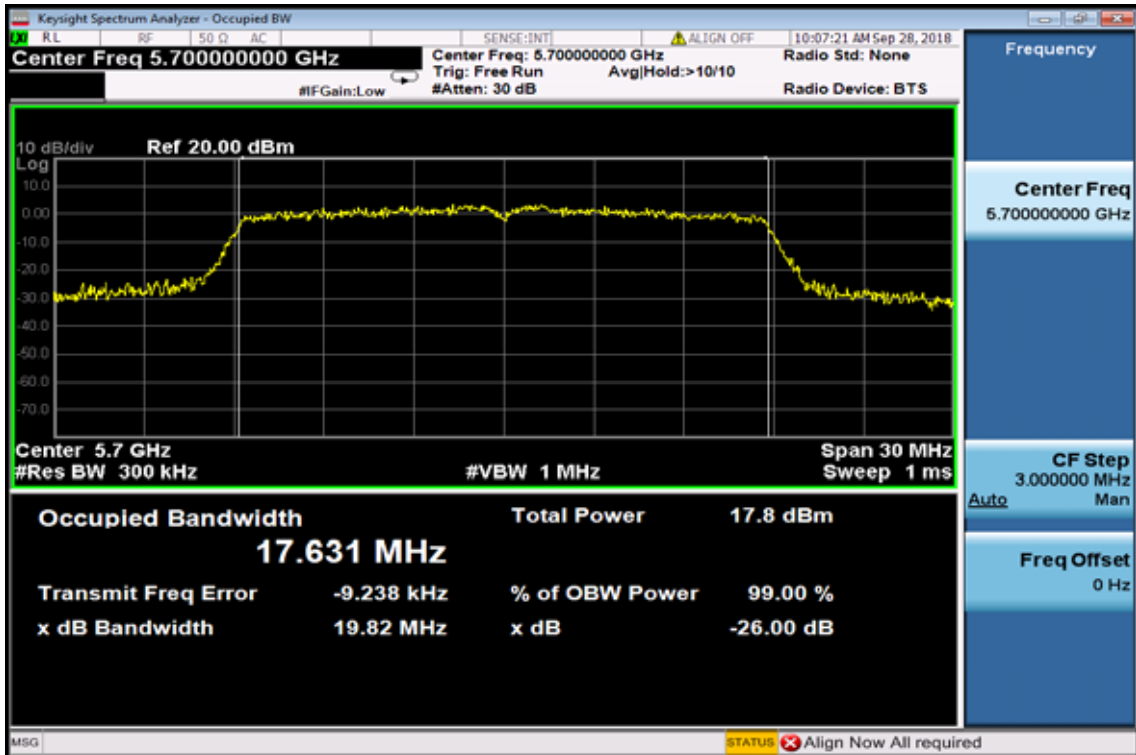

802.11n HT40

26dB / 99% Band Width Test Data CH-Low

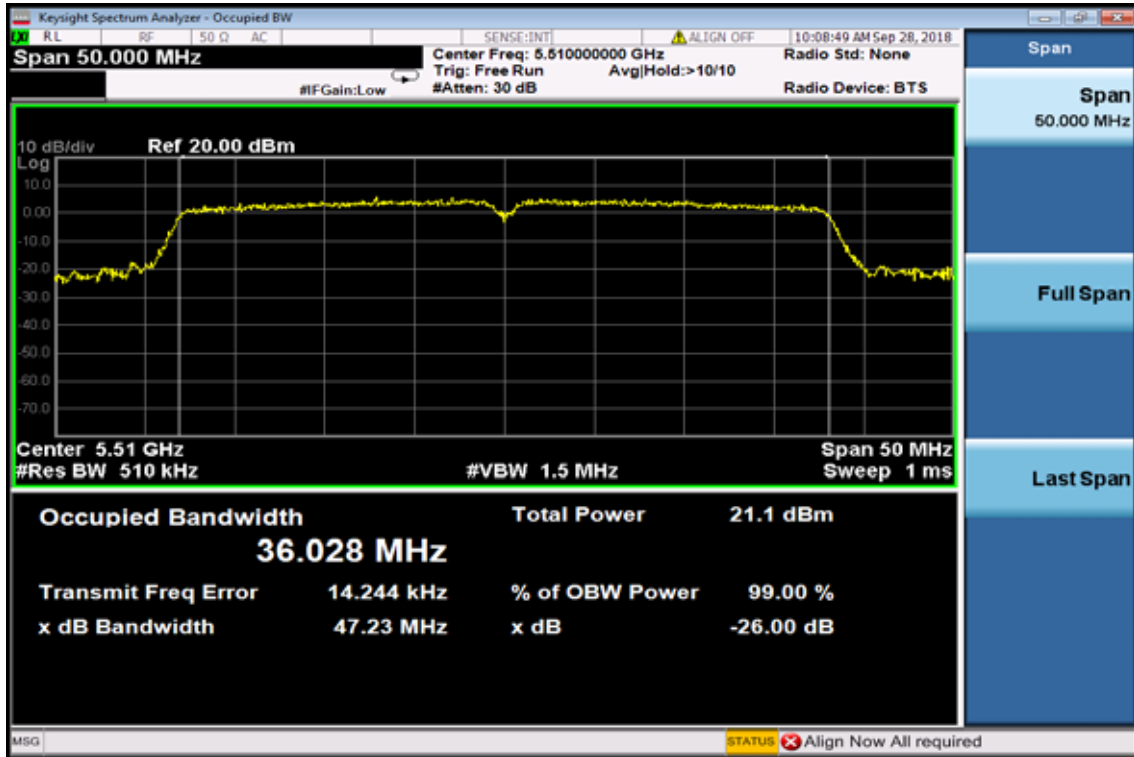

26dB / 99% Band Width Test Data CH-Mid

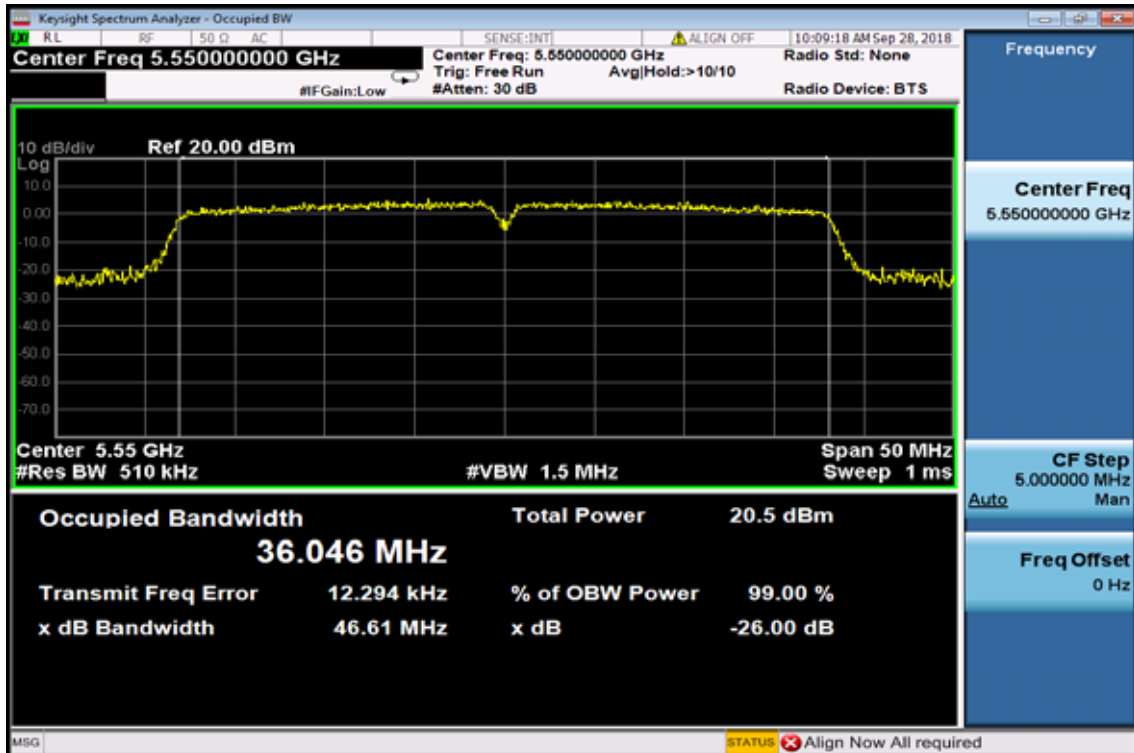

26dB / 99%Band Width Test Data CH-High

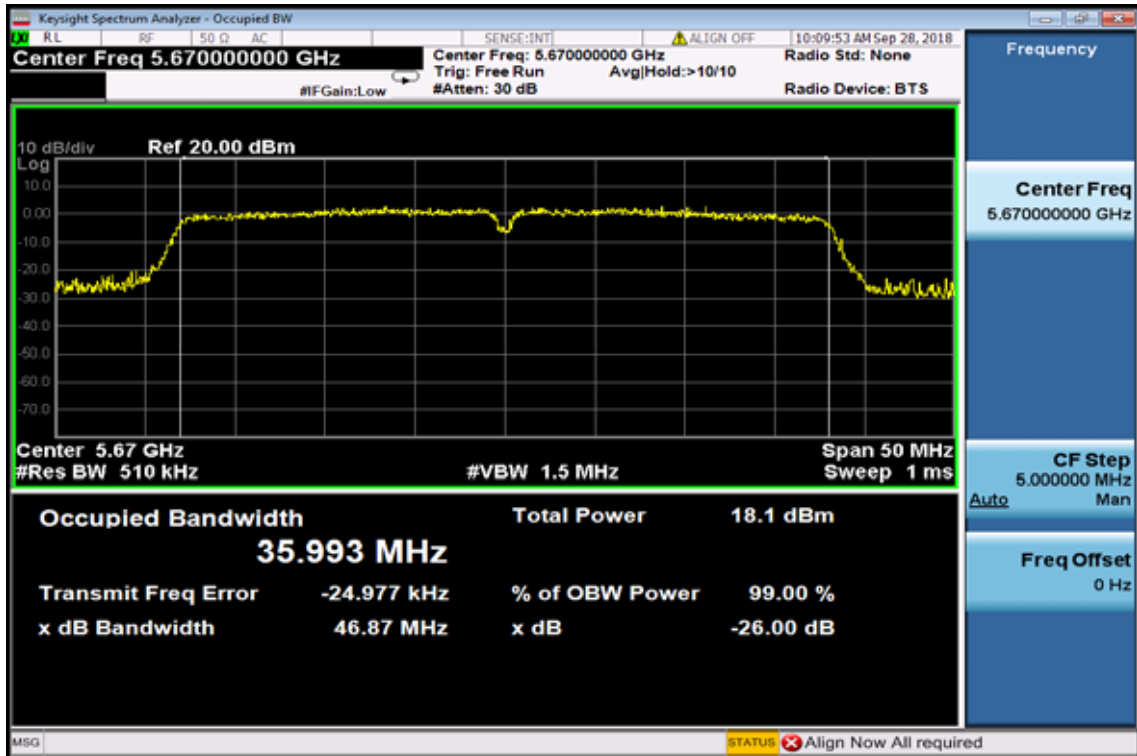

8. 6dB Emission Bandwidth Measurement

8.1. Standard Applicable

According to §15.407 (e) Within the 5.725-5.85 GHz band, the minimum 6 dB bandwidth of U-NII devices shall be at least 500 kHz.

8.2. Measurement Procedure

1. Place the EUT on the table and set it in transmitting mode.
2. Remove the antenna from the EUT and then connect a low loss RF cable from the antenna port to the spectrum analyzer.
3. Set the spectrum analyzer as RBW=100kHz, VBW =300MHz, Span= 50MHz, Sweep=auto
4. Mark the peak frequency and -6dB (upper and lower) frequency.
5. Repeat above procedures until all frequency measured were complete.

Refer to section D of KDB Document: KDB 789033 D02 General UNII Test Procedures New Rules v01r03

8.3. Measurement Equipment Used:

Refer to section 6.3 for details.

8.4. Test Set-up:

Refer to section 6.4 for details.

8.5. Measurement Result

802.11a Mode

Frequency (MHz)	6dB Bandwidth (MHz)	99% Bandwidth (MHz)	Limit (kHz)
5745	15.120	16.395	>500
5785	16.020	16.397	>500
5825	15.450	16.387	>500

802.11n HT20 Mode

Frequency (MHz)	6dB Bandwidth (MHz)	99% Bandwidth (MHz)	Limit (kHz)
5745	15.080	17.556	>500
5785	15.120	17.549	>500
5825	15.120	17.559	>500

802.11n HT40 Mode

Frequency (MHz)	6dB Bandwidth (MHz)	99% Bandwidth (MHz)	Limit (kHz)
5755	35.170	35.807	>500
5795	35.100	35.851	>500

5725-5850 MHz

802.11a

6dB Band Width Test Data CH-Low

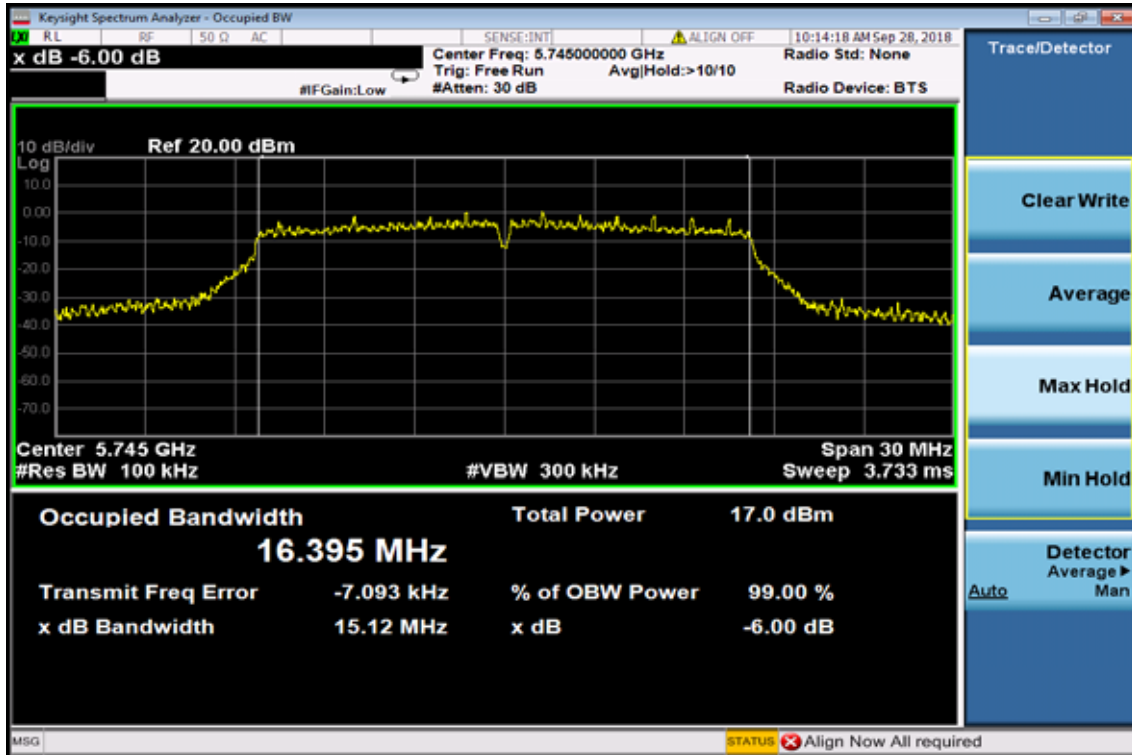

6dB Band Width Data CH-Mid

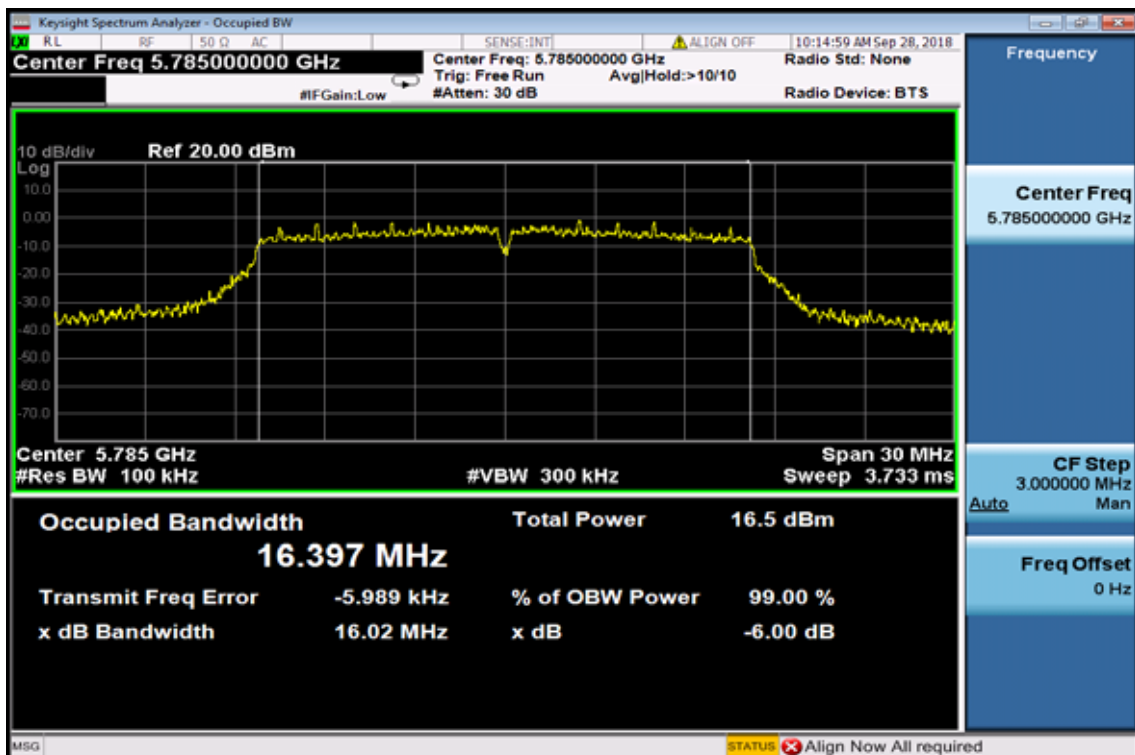

6dB Band Width Data CH-High

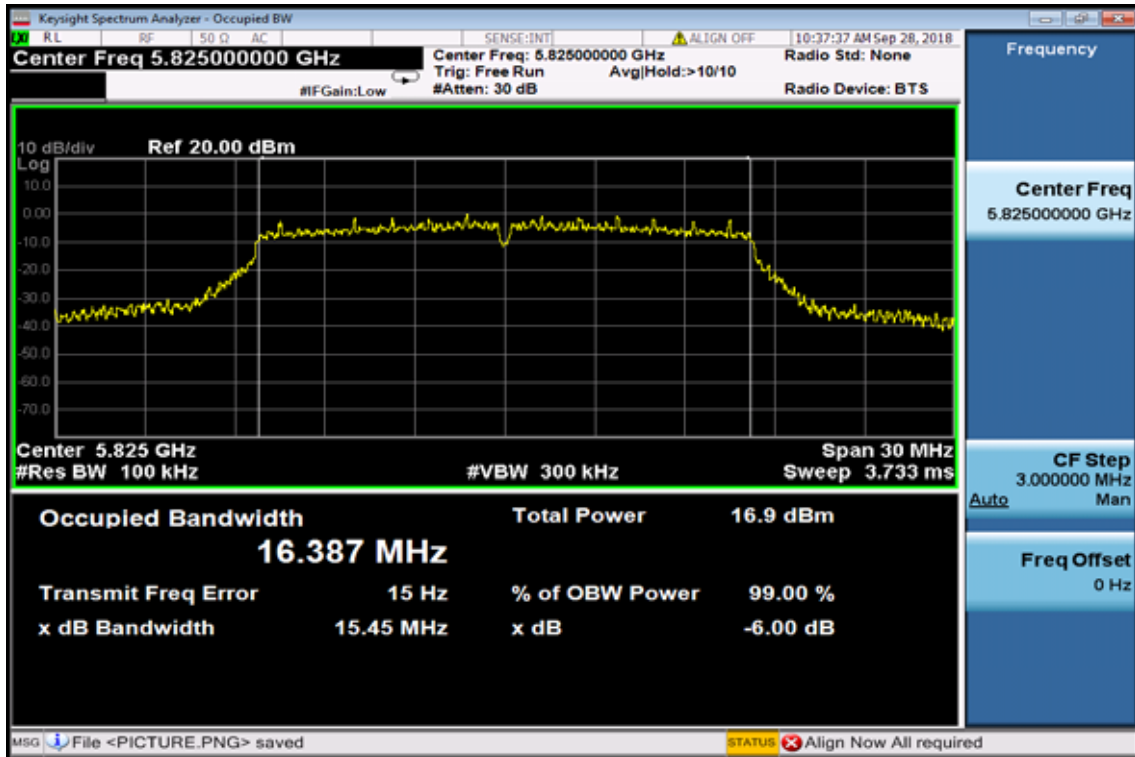

802.11n HT20

6dB Band Width Data CH-Low

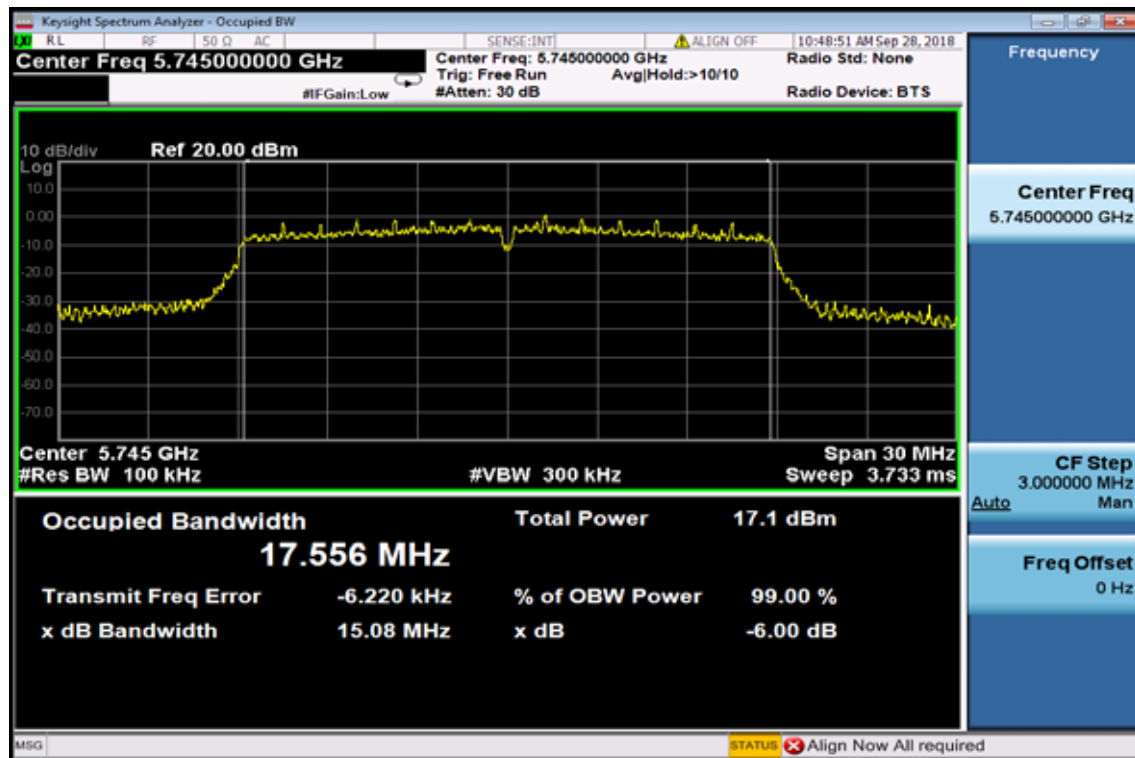

6dB Band Width Data CH-Mid

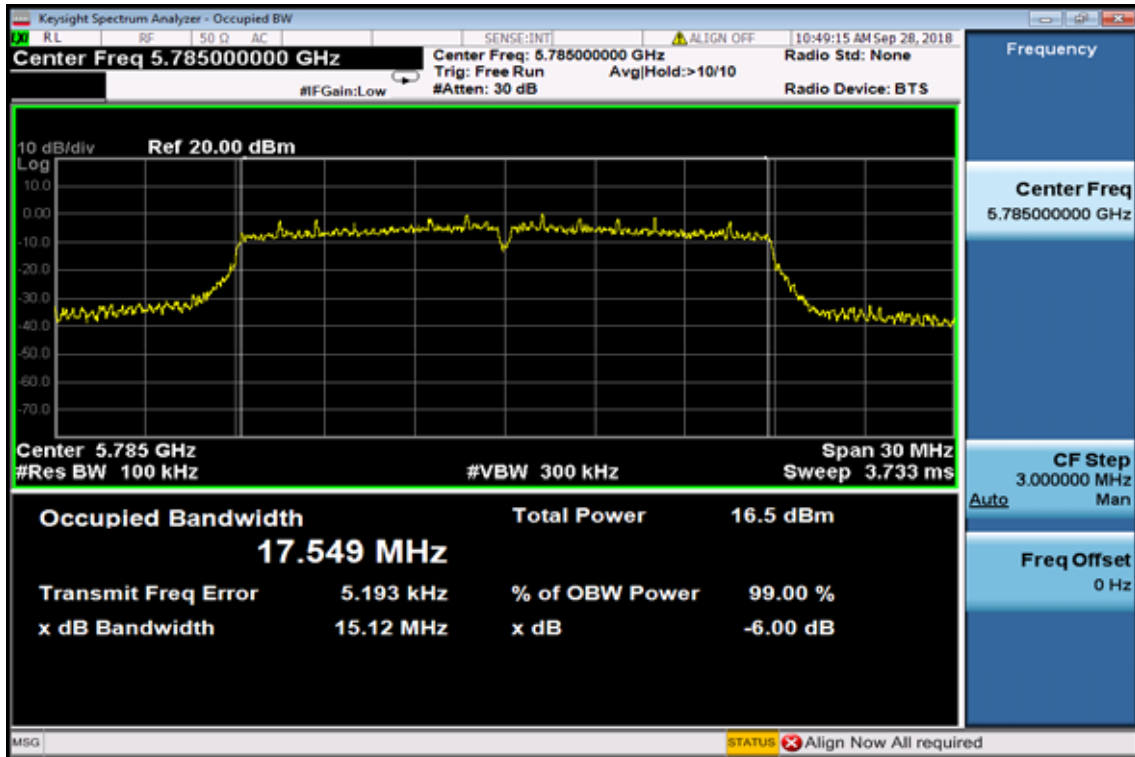

6dB Band Width Data CH-High

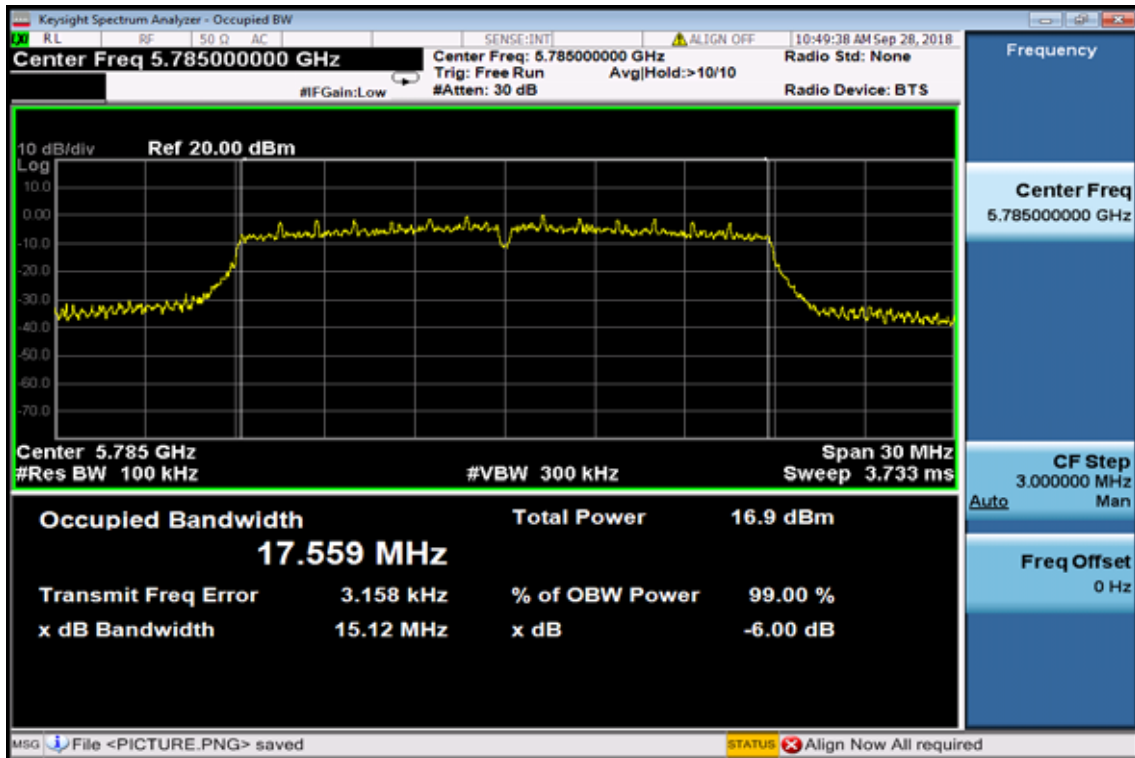

802.11n HT40

6dB Band Width Data CH-Low

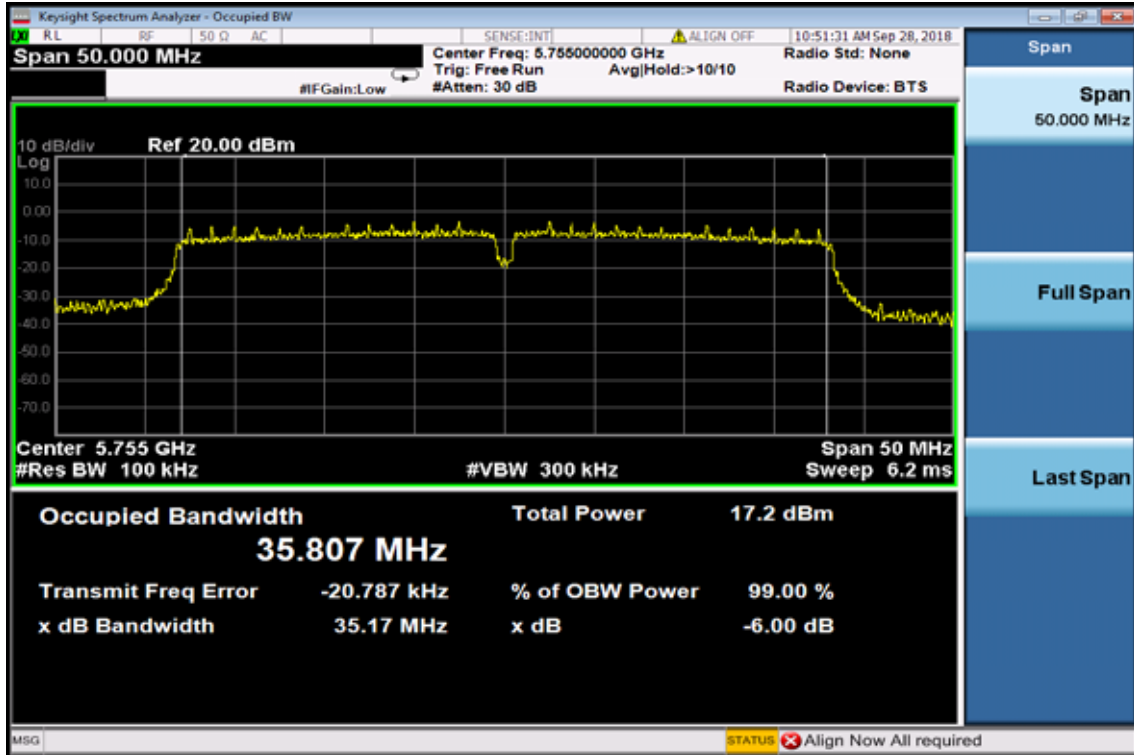

6dB Band Width Data CH-High

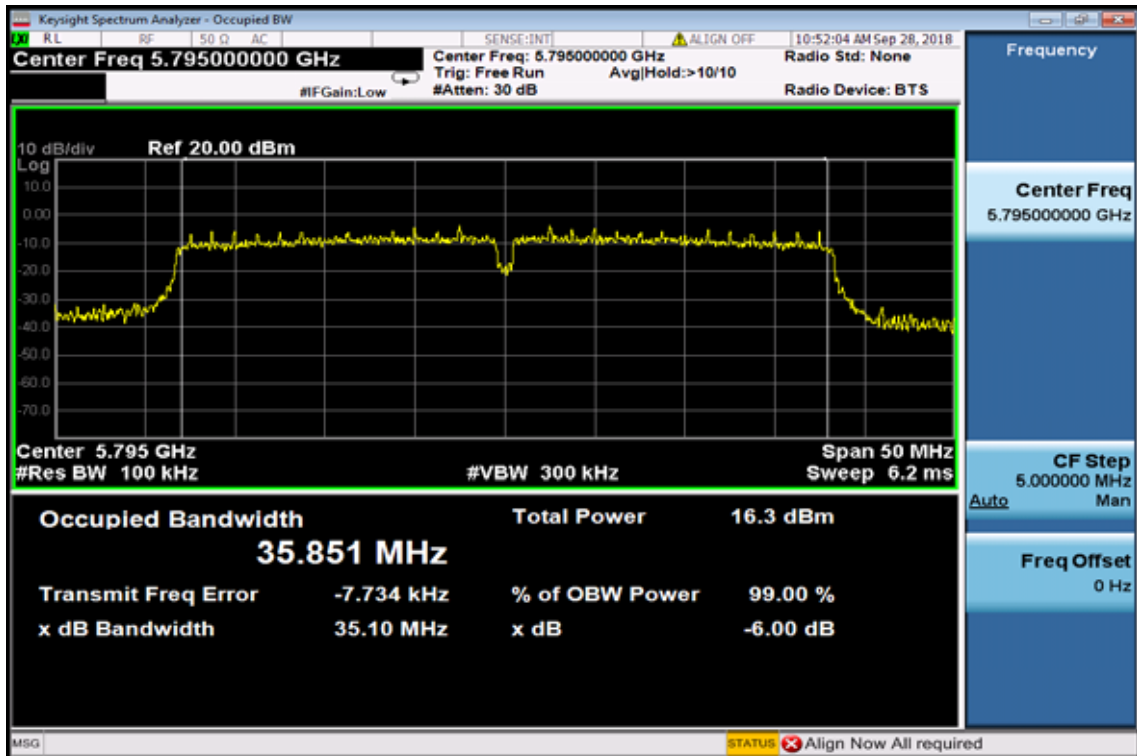

9. Undesirable emission – Radiated Measurement

9.1. Standard Applicable

According to §15.407(b), Undesirable Emission Limits: Except as shown in Paragraph (b)(7) of this section, the peak emissions outside of the frequency bands of operation shall be attenuated in accordance with the following limits:

- (1) For transmitters operating in the 5.15-5.25 GHz band: all emissions outside of the 5.15-5.35 GHz band shall not exceed an e.i.r.p. of -27 dBm/MHz.
- (2) For transmitters operating in the 5.25-5.35 GHz band: all emissions outside of the 5.15-5.35 GHz band shall not exceed an e.i.r.p. of -27 dBm/MHz.
- (3) For transmitters operating in the 5.47-5.725 GHz band: all emissions outside of the 5.47-5.725 GHz band shall not exceed an e.i.r.p. of -27 dBm/MHz.
- (4) For transmitters operating in the 5.725-5.85 GHz band: all emissions within the frequency range from the band edge to 10 MHz above or below the band edge shall not exceed an e.i.r.p. of -17dBm/MHz; for frequencies 10 MHz or greater above or below the band edge, emissions shall not exceed an e.i.r.p. of -27 dBm/MHz.
- (5) The above emission measurements shall be performed using a minimum resolution bandwidth of 1 MHz. A lower resolution bandwidth may be employed near the band edge, when necessary, provided the measured energy is integrated to show the total power over 1 MHz.
- (6) Unwanted emissions below 1 GHz must comply with the general field strength limits set forth in Section 15.209. Further, any U-NII devices using an AC power line are required to comply also with the conducted limits set forth in Section 15.207.
- (7) The provisions of Section 15.205 of this part apply to intentional radiators operating under this section.
- (8) When measuring the emission limits, the nominal carrier frequency shall be adjusted as close to the upper and lower frequency band edges as the design of the equipment permits.

§15.205- RESTRICTED BANDS OF OPERATIONS

(a) Except as shown in paragraph (d) of this section, only spurious emissions are permitted in any of the frequency bands listed below:

MHz	MHz	MHz	GHz
0.090 - 0.110	16.42 - 16.423	399.9 - 410	4.5 - 5.15
¹ 0.495 - 0.505	16.69475 - 16.69525	608 - 614	5.35 - 5.46
2.1735 - 2.1905	16.80425 - 16.80475	960 - 1240	7.25 - 7.75
4.125 - 4.128	25.5 - 25.67	1300 - 1427	8.025 - 8.5
4.17725 - 4.17775	37.5 - 38.25	1435 - 1626.5	9.0 - 9.2
4.20725 - 4.20775	73 - 74.6	1645.5 - 1646.5	9.3 - 9.5
6.215 - 6.218	74.8 - 75.2	1660 - 1710	10.6 - 12.7
6.26775 - 6.26825	108 - 121.94	1718.8 - 1722.2	13.25 - 13.4
6.31175 - 6.31225	123 - 138	2200 - 2300	14.47 - 14.5
8.291 - 8.294	149.9 - 150.05	2310 - 2390	15.35 - 16.2
8.362 - 8.366	156.52475 -	2483.5 - 2500	17.7 - 21.4
8.37625 - 8.38675	156.52525	2655 - 2900	22.01 - 23.12
8.41425 - 8.41475	156.7 - 156.9	3260 - 3267	23.6 - 24.0
12.29 - 12.293	162.0125 - 167.17	3332 - 3339	31.2 - 31.8
12.51975 - 12.52025	167.72 - 173.2	3345.8 - 3358	36.43 - 36.5
12.57675 - 12.57725	240 - 285	3600 - 4400	(²)
13.36 - 13.41	322 - 335.4		

¹ Until February 1, 1999, this restricted band shall be 0.490-0.510 MHz.

² Above 38.6

(b) Except as provided in paragraphs (d) and (e), the field strength of emissions appearing within these frequency bands shall not exceed the limits shown in Section 15.209. At frequencies equal to or less than 1000 MHz, compliance with the limits in Section 15.209 shall be demonstrated using measurement instrumentation employing a CISPR quasi-peak detector. Above 1000 MHz, compliance with the emission limits in Section 15.209 shall be demonstrated based on the average value of the measured emissions. The provisions in Section 15.35 apply to these measurements.

§15.209- RADIATED EMISSION LIMITS: GENERAL REQUIREMENTS

FCC PART 15.209

MEASURING DISTANCE OF 3 METER		
FREQUENCY RANGE (MHz)	FIELD STRENGTH (Microvolts/m)	FIELD STRENGTH (dBuV/m)
30-88	100	40
88-216	150	43.5
216-960	200	46
Above 960	500	54

9.2. EUT Setup

1. The radiated emission tests were performed in the 3 meter open-test site, using the setup in accordance with the ANSI C63.10: 2013
2. The EUT was put in the front of the test table. The host PC system was placed on the center of the back edge on the test table. The peripherals like modem, monitor printer, K/B, and mouse were placed on the side of the host PC system. The rear of the EUT and peripherals were placed flushed with the rear of the tabletop.
3. The keyboard was placed directly in the front of the monitor, flushed with the front tabletop. The mouse was placed next to the Keyboard, flushed with the back of keyboard.
4. The spacing between the peripherals was 10 centimeters.
5. External I/O cables were draped along the edge of the test table and bundle when necessary.
6. The host PC system was connected with 120Vac/60Hz power source.

9.3. Measurement Procedure

1. The EUT was placed on a turn table which is 0.8m above ground plane.
2. The turn table shall rotate 360 degrees to determine the position of maximum emission level.
3. EUT is set 3m away from the receiving antenna which varied from 1m to 4m to find out the highest emissions.
4. Maximum procedure was performed on the six highest emissions to ensure EUT compliance.
5. And also, each emission was to be maximized by changing the polarization of receiving antenna both horizontal and vertical.
6. Repeat above procedures until all frequency measured were complete.

Refer to section F of KDB Document: KDB 789033 D02 General U-NII Test Procedures New Rules v02r01

9.4. Test SET-UP (Block Diagram of Configuration)

(A) Radiated Emission Test Set-Up, Frequency Below 1000MHz

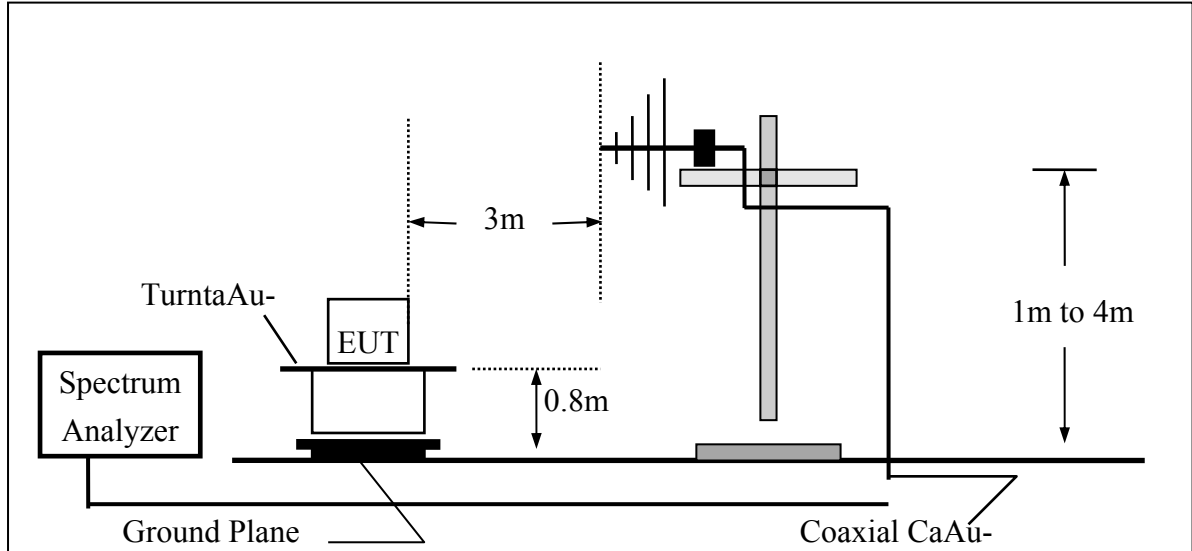

(B) Radiated Emission Test Set-Up Frequency Over 1 GHz

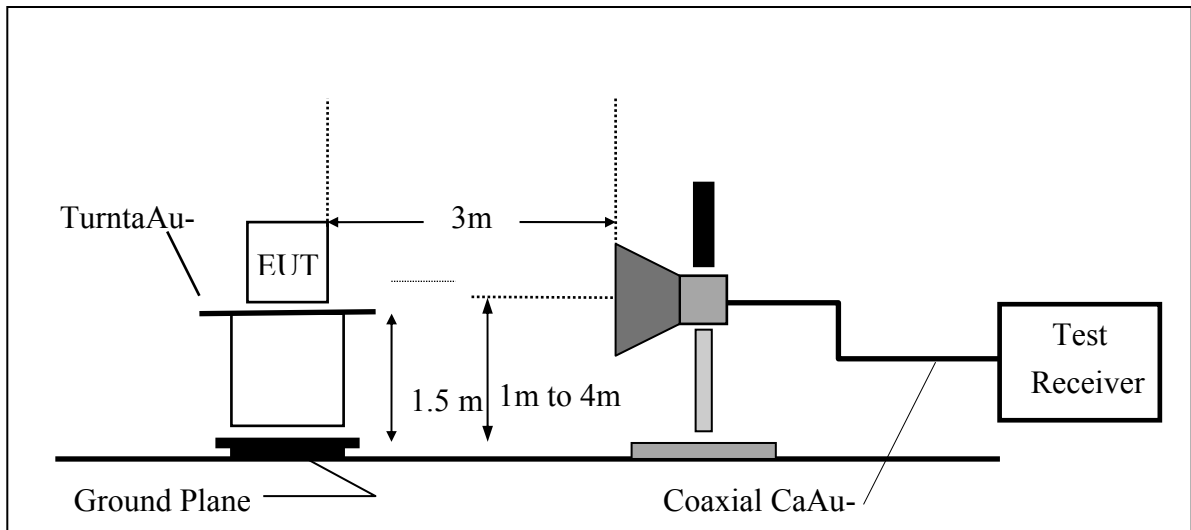

9.5. Measurement Equipment Used:

Chamber 19(966)					
Equipment Type	MFR	Model Number	Serial Number	Last Cal.	Cal Due.
966 Chamber	Chance Most	Chamber 19	N/A	08/13/2018	08/12/2019
Spectrum Analyzer 21(3Hz-44GHz)	Agilent	N9030A	MY51360021	11/20/2017	11/19/2018
EMI Receiver	SCHWARZBECK	FCVU1534	1534149	12/07/2017	12/06/2018
Loop Antenna(9K-30M)	EM	EM-6879	271	06/06/2018	06/05/2020
Bilog Antenna (30M-1G)	SCHWARZBECK	VULB9168 w 5dB Att	736	11/16/2017	11/25/2018
Horn antenna (1G-18G)	SCHWARZBECK	9120D	9120D-1627	11/27/2017	11/26/2019
Horn antenna (18G-26G)	Com-power	AH-826	081001	11/21/2017	11/20/2019
Horn antenna (26G-40G)	Com-power	AH-640	100A	02/22/2017	02/21/2019
Preamplifier (9k-1000M)	HP	8447F	3113A04621	12/08/2017	12/07/2018
Preamplifier(1G-26G)	Agilent	8449B	3008A02471	08/23/2018	08/22/2019
Preamplifier (26G-40G)	MITEQ	JS4-26004000- 27-5A	818471	11/20/2017	07/21/2019
RF Cable (9k-18G)	HUBER SUHNER	SUCOFLEX 104A	MY1397/4A	11/02/2017	11/01/2018
RF cable (18G~40G)	HUBER SUHNER	Sucoflex 102	27963/2&37421/2	11/02/2017	11/01/2018
Turn Table	MF	Turn Table-19	Turn Table-19	N/A	N/A
Mast Tower	MF	JSDS-15A	1308283	N/A	N/A
Controller	MF	MF-7802BS	MF780208460	N/A	N/A
AC power source	T-Power	TFC-1005	40006471	N/A	N/A
Signal Generator	R&S	SMU200A	102330	03/14/2018	03/13/2019
Signal Generator	Anritsu	MG3692A	20311	12/07/2017	12/06/2018
2.4G Filter	Micro-Tronics	Brm50702	76	12/25/2017	12/24/2018
5G Filter	Micro-Tronics	Brm50716	005	12/25/2017	12/24/2018
Test Software	Audix	E3 Ver:6.12023	N/A	N/A	N/A

9.6. Field Strength Calculation

The field strength is calculated by adding the Antenna Factor and Cable Factor and subtracting the Amplifier Gain and Duty Cycle Correction Factor(if any) from the measured reading. The basic equation with a sample calculation is as follows:

$$FS = RA + AF + CL - AG$$

Where	FS = Field Strength	CL = Cable Attenuation Factor (Cable Loss)
	RA = Reading Amplitude	AG = Amplifier Gain
	AF = Antenna Factor	

9.7. Measurement Result

Refer to attach tabular data sheets.

NOTE:

The resolution bandwidth and video bandwidth of test receiver/spectrum analyzer is 100kHz for Peak detection (PK) and Quasi-peak detection (QP) at frequency below 1GHz. And RBW 1MHz for frequency above 1GHz.

Radiated Spurious Emission Measurement Result (below 1GHz)

(Worst case: Band 1&2, 802.11a mode)

Operation Mode	TX MODE	Test Date	2018/11/03
Channel Number	CH Low	Test By	Barry
Temperature	25	Pol	Ver./Hor
Humidity	65 %		

No	Freq MHz	Reading dBuV	Factor dB	Level dBuV/m	Limit dBuV/m	Over Limit dB	Remark	Pol V/H
1	64.92	35.36	-8.63	26.73	40.00	-13.27	Peak	VERTICAL
2	148.34	28.81	-7.08	21.73	43.50	-21.77	Peak	VERTICAL
3	261.83	28.29	-7.33	20.96	46.00	-25.04	Peak	VERTICAL
4	343.31	30.16	-5.15	25.01	46.00	-20.99	Peak	VERTICAL
5	630.43	28.66	-0.06	28.60	46.00	-17.40	Peak	VERTICAL
6	716.76	28.44	1.41	29.85	46.00	-16.15	Peak	VERTICAL
1	64.92	33.39	-8.63	24.76	40.00	-15.24	Peak	HORIZONTAL
2	95.96	39.72	-12.70	27.02	43.50	-16.48	Peak	HORIZONTAL
3	147.37	33.79	-7.12	26.67	43.50	-16.83	Peak	HORIZONTAL
4	178.41	32.83	-8.41	24.42	43.50	-19.08	Peak	HORIZONTAL
5	532.46	31.91	-1.90	30.01	46.00	-15.99	Peak	HORIZONTAL
6	742.95	30.85	2.03	32.88	46.00	-13.12	Peak	HORIZONTAL

Remark:

- 1 emission is 20dB lower, so that emission as measured between 9kHz to 30MHz is not reported
- 2 Measuring frequencies from the lowest internal frequency to the 1GHz.
- 3 Radiated emissions measured in frequency range from 9MHz to 1000MHz were made with an instrument detector setting 9-90kHz/110-490kHz using PK/AV and other Frequency Band using PK/QP
- 4 Measurement result within this frequency range shown “ - ” in the table above means the reading of emissions are attenuated more than 20dB below the permissible limits or the field strength is too small to be measured.
- 5 The IF bandwidth of SPA between 9kHz to 30MHz was 10kHz, VBW= 30kHz; between 30MHz to 1GHz was 100kHz, VBW=300kHz.

Radiated Spurious Emission Measurement Result (below 1GHz)

Operation Mode	TX MODE	Test Date	2018/11/03
Channel Number	CH Mid	Test By	Barry
Temperature	25	Pol	Ver./Hor
Humidity	65 %		

No	Freq MHz	Reading dBuV	Factor dB	Level dBuV/m	Limit dBuV/m	Over Limit dB	Remark	Pol V/H
1	30.00	41.98	-8.12	33.86	40.00	-6.14	Peak	VERTICAL
2	63.95	37.77	-8.45	29.32	40.00	-10.68	Peak	VERTICAL
3	106.63	31.70	-11.00	20.70	43.50	-22.80	Peak	VERTICAL
4	159.01	28.95	-6.95	22.00	43.50	-21.50	Peak	VERTICAL
5	606.18	29.76	-0.33	29.43	46.00	-16.57	Peak	VERTICAL
6	770.11	27.77	2.40	30.17	46.00	-15.83	Peak	VERTICAL
1	64.92	33.42	-8.63	24.79	40.00	-15.21	Peak	HORIZONTAL
2	95.96	37.59	-12.70	24.89	43.50	-18.61	Peak	HORIZONTAL
3	142.52	32.08	-7.35	24.73	43.50	-18.77	Peak	HORIZONTAL
4	387.93	29.47	-4.19	25.28	46.00	-20.72	Peak	HORIZONTAL
5	532.46	31.13	-1.90	29.23	46.00	-16.77	Peak	HORIZONTAL
6	853.53	29.94	3.48	33.42	46.00	-12.58	Peak	HORIZONTAL

Remark:

- 1 emission is 20dB lower, so that emission as measured between 9kHz to 30MHz is not reported
- 2 Measuring frequencies from the lowest internal frequency to the 1GHz.
- 3 Radiated emissions measured in frequency range from 9MHz to 1000MHz were made with an instrument detector setting 9-90kHz/110-490kHz using PK/AV and other Frequency Band using PK/QP
- 4 Measurement result within this frequency range shown “ - ” in the table above means the reading of emissions are attenuated more than 20dB below the permissible limits or the field strength is too small to be measured.
- 5 The IF bandwidth of SPA between 9kHz to 30MHz was 10kHz, VBW= 30kHz; between 30MHz to 1GHz was 100kHz, VBW=300kHz.

Radiated Spurious Emission Measurement Result (below 1GHz)

Operation Mode	TX MODE	Test Date	2018/11/03
Channel Number	CH High	Test By	Barry
Temperature	25	Pol	Ver./Hor
Humidity	65 %		

No	Freq MHz	Reading dBuV	Factor dB	Level dBuV/m	Limit dBuV/m	Over Limit dB	Remark	Pol V/H
1	30.00	42.73	-8.12	34.61	40.00	-5.39	Peak	VERTICAL
2	63.95	36.17	-8.45	27.72	40.00	-12.28	Peak	VERTICAL
3	316.15	29.87	-5.62	24.25	46.00	-21.75	Peak	VERTICAL
4	352.04	29.80	-4.99	24.81	46.00	-21.19	Peak	VERTICAL
5	500.45	30.72	-2.42	28.30	46.00	-17.70	Peak	VERTICAL
6	515.97	35.38	-2.16	33.22	46.00	-12.78	Peak	VERTICAL
1	64.92	33.39	-8.63	24.76	40.00	-15.24	Peak	HORIZONTAL
2	95.96	37.85	-12.70	25.15	43.50	-18.35	Peak	HORIZONTAL
3	140.58	31.10	-7.44	23.66	43.50	-19.84	Peak	HORIZONTAL
4	371.44	30.84	-4.55	26.29	46.00	-19.71	Peak	HORIZONTAL
5	445.16	30.27	-3.03	27.24	46.00	-18.76	Peak	HORIZONTAL
6	532.46	30.03	-1.90	28.13	46.00	-17.87	Peak	HORIZONTAL

Remark:

- 1 emission is 20dB lower, so that emission as measured between 9kHz to 30MHz is not reported
- 2 Measuring frequencies from the lowest internal frequency to the 1GHz.
- 3 Radiated emissions measured in frequency range from 9MHz to 1000MHz were made with an instrument detector setting 9-90kHz/110-490kHz using PK/AV and other Frequency Band using PK/QP
- 4 Measurement result within this frequency range shown “ - ” in the table above means the reading of emissions are attenuated more than 20dB below the permissible limits or the field strength is too small to be measured.
- 5 The IF bandwidth of SPA between 9kHz to 30MHz was 10kHz, VBW= 30kHz; between 30MHz to 1GHz was 100kHz, VBW=300kHz.

Radiated Spurious Emission Measurement Result (above 1GHz)

(Worst case: Band 1&2, 802.11a mode)

Operation Mode	TX MODE	Test Date	2018/11/03
Channel Number	CH Low	Test By	Barry
Temperature	25	Humidity	60 %

No	Freq MHz	Reading dBuV	Factor dB	Level dBuV/m	Limit dBuV/m	Over Limit dB	Remark	Pol V/H
1	2148.00	58.95	-16.06	42.89	74.00	-31.11	Peak	VERTICAL
2	2652.00	53.24	-15.33	37.91	74.00	-36.09	Peak	VERTICAL
3	10360.00	30.87	4.29	35.16	74.00	-38.84	Peak	VERTICAL
4	15540.00	31.17	8.02	39.19	74.00	-34.81	Peak	VERTICAL
1	1854.00	57.19	-18.54	38.65	74.00	-35.35	Peak	HORIZONTAL
2	2127.00	57.96	-16.21	41.75	74.00	-32.25	Peak	HORIZONTAL
3	10360.00	30.39	4.29	34.68	74.00	-39.32	Peak	HORIZONTAL
4	15540.00	30.87	8.02	38.89	74.00	-35.11	Peak	HORIZONTAL

Remark:

- 1 Field strength limits for frequency above 1000MHz are based on average limits. However, Peak mode field strength shall not exceed the average limits specified plus 20dB.
- 2 Measurement of data within this frequency range shown “ - ” in the table above means the reading of emissions are attenuated more than 20dB below the permissible limits or the field strength is too small to be measured.
- 3 Spectrum Peak mode IF bandwidth Setting : 1GHz- 26GHz, RBW= 1MHz, Sweep time= 200 ms., the VBW setting was 3 MHz.
- 4 Spectrum AV mode if bandwidth Setting : 1GHz- 26GHz, RBW= 1MHz, VBW= 10Hz, Sweep time= 200 ms.

Radiated Spurious Emission Measurement Result (above 1GHz)

Operation Mode	TX MODE	Test Date	2018/11/03
Channel Number	CH Mid	Test By	Barry
Temperature	25	Humidity	60 %

No	Freq MHz	Reading dBuV	Factor dB	Level dBuV/m	Limit dBuV/m	Over Limit dB	Remark	Pol V/H
1	2148.00	59.56	-16.06	43.50	74.00	-30.50	Peak	VERTICAL
2	2645.00	52.03	-15.34	36.69	74.00	-37.31	Peak	VERTICAL
3	10520.00	32.29	4.74	37.03	74.00	-36.97	Peak	VERTICAL
4	15780.00	32.35	7.25	39.60	74.00	-34.40	Peak	VERTICAL
1	1812.00	57.36	-18.72	38.64	74.00	-35.36	Peak	HORIZONTAL
2	2155.00	55.29	-16.00	39.29	74.00	-34.71	Peak	HORIZONTAL
3	10520.00	32.42	4.74	37.16	74.00	-36.84	Peak	HORIZONTAL
4	15780.00	31.68	7.25	38.93	74.00	-35.07	Peak	HORIZONTAL

Remark:

- 1 Field strength limits for frequency above 1000MHz are based on average limits. However, Peak mode field strength shall not exceed the average limits specified plus 20dB.
- 2 Measurement of data within this frequency range shown “ - ” in the table above means the reading of emissions are attenuated more than 20dB below the permissible limits or the field strength is too small to be measured.
- 3 Spectrum Peak mode IF bandwidth Setting : 1GHz- 26GHz, RBW= 1MHz, Sweep time= 200 ms., the VBW setting was 3 MHz.
- 4 Spectrum AV mode if bandwidth Setting : 1GHz- 26GHz, RBW= 1MHz, VBW= 10Hz, Sweep time= 200 ms.

Radiated Spurious Emission Measurement Result (above 1GHz) (worst case)

Operation Mode	TX MODE	Test Date	2018/11/03
Channel Number	CH High	Test By	Barry
Temperature	25	Humidity	60 %

No	Freq MHz	Reading dBuV	Factor dB	Level dBuV/m	Limit dBuV/m	Over Limit dB	Remark	Pol V/H
1	1812.00	64.10	-18.72	45.38	74.00	-28.62	Peak	VERTICAL
2	2148.00	59.17	-16.06	43.11	74.00	-30.89	Peak	VERTICAL
3	10640.00	32.22	5.11	37.33	74.00	-36.67	Peak	VERTICAL
4	15960.00	31.99	6.67	38.66	74.00	-35.34	Peak	VERTICAL
1	1812.00	57.71	-18.72	38.99	74.00	-35.01	Peak	HORIZONTAL
2	2155.00	58.24	-16.00	42.24	74.00	-31.76	Peak	HORIZONTAL
3	10640.00	33.33	5.11	38.44	74.00	-35.56	Peak	HORIZONTAL
4	15960.00	31.97	6.67	38.64	74.00	-35.36	Peak	HORIZONTAL

Remark:

- 1 Field strength limits for frequency above 1000MHz are based on average limits. However, Peak mode field strength shall not exceed the average limits specified plus 20dB.
- 2 Measurement of data within this frequency range shown “ - ” in the table above means the reading of emissions are attenuated more than 20dB below the permissible limits or the field strength is too small to be measured.
- 3 Spectrum Peak mode IF bandwidth Setting : 1GHz- 26GHz, RBW= 1MHz, Sweep time= 200 ms., the VBW setting was 3 MHz.
- 4 Spectrum AV mode if bandwidth Setting : 1GHz- 26GHz, RBW= 1MHz, VBW= 10Hz, Sweep time= 200 ms.

Band Edges test (worst case: Band 1&2 802.11a) -Radiated

Operation Mode	TX CH Low	Test Date	2018/11/03
Channel Number	5170 MHz	Test By	Barry
Temperature	25	Humidity	65 %

No	Freq MHz	Reading dBuV	Factor dB	Level dBuV/m	Limit dBuV/m	Over Limit dB	Remark	Pol V/H
1	4620.40	10.83	37.98	48.81	54.00	-5.19	Average	VERTICAL
2	4620.40	30.65	37.98	68.63	74.00	-5.37	Peak	VERTICAL
3	5150.00	10.95	39.18	50.13	54.00	-3.87	Average	VERTICAL
4	5150.00	28.94	39.18	68.12	74.00	-5.88	Peak	VERTICAL
5	5181.10	62.70	39.22	101.92	74.00	27.92	Peak	VERTICAL
1	4595.20	10.21	37.89	48.10	54.00	-5.90	Average	HORIZONTAL
2	4595.20	31.40	37.89	69.29	74.00	-4.71	Peak	HORIZONTAL
3	5150.00	13.23	39.18	52.41	54.00	-1.59	Average	HORIZONTAL
4	5150.00	28.40	39.18	67.58	74.00	-6.42	Peak	HORIZONTAL
5	5181.80	70.19	39.22	109.41	74.00	35.41	Peak	HORIZONTAL

Remark:

- 1 Measuring frequencies from the lowest internal frequency to the 10th of fundamental frequency
- 2 Field strength limits for frequency above 1000MHz are based on average limits. However, Peak mode field strength shall not exceed the average limits specified plus 20dB.
- 3 Measurement of data within this frequency range shown “ - ” in the table above means the reading of emissions are attenuated more than 20dB below the permissible limits or the field strength is too small to be measured.
- 4 Spectrum Peak mode IF bandwidth Setting : 1GHz- 26GHz, RBW= 1MHz, Sweep time= 200 ms., the VBW setting was 3 MHz.
- 5 Spectrum AV mode if bandwidth Setting : 1GHz- 26GHz, RBW= 1MHz, VBW= 10Hz, Sweep time= 200 ms.

Operation Mode TX CH High
 Channel Number 5240MHz
 Temperature 25

Test Date 2018/11/03
 Test By Barry
 Humidity 65 %

No	Freq MHz	Reading dBuV	Factor dB	Level dBuV/m	Limit dBuV/m	Over Limit dB	Remark	Pol V/H
1	5320.95	61.38	39.38	100.76	74.00	26.76	Peak	VERTICAL
2	5350.00	10.24	39.40	49.64	54.00	-4.36	Average	VERTICAL
3	5350.00	28.71	39.40	68.11	74.00	-5.89	Peak	VERTICAL
4	5402.85	10.00	39.46	49.46	54.00	-4.54	Average	VERTICAL
5	5402.85	30.81	39.46	70.27	74.00	-3.73	Peak	VERTICAL
1	5317.80	71.49	39.38	110.87	74.00	36.87	Peak	HORIZONTAL
2	5350.00	8.05	39.40	47.45	54.00	-6.55	Average	HORIZONTAL
3	5350.00	27.80	39.40	67.20	74.00	-6.80	Peak	HORIZONTAL
4	5390.85	9.21	39.45	48.66	54.00	-5.34	Average	HORIZONTAL
5	5390.85	30.91	39.45	70.36	74.00	-3.64	Peak	HORIZONTAL

Remark:

- 1 Measuring frequencies from the lowest internal frequency to the 10th of fundamental frequency
- 2 Field strength limits for frequency above 1000MHz are based on average limits. However, Peak mode field strength shall not exceed the average limits specified plus 20dB.
- 3 Measurement of data within this frequency range shown “ - ” in the table above means the reading of emissions are attenuated more than 20dB below the permissible limits or the field strength is too small to be measured.
- 4 Spectrum Peak mode IF bandwidth Setting : 1GHz- 26GHz, RBW= 1MHz, Sweep time= 200 ms., the VBW setting was 3 MHz.
- 5 Spectrum AV mode if bandwidth Setting : 1GHz- 26GHz, RBW= 1MHz, VBW= 10Hz, Sweep time= 200 ms.

10. Transmission in the Absence of Data

10.1. Standard Applicable

According to §15.407(c)

The device shall automatically discontinue transmission in case of either absence of information to transmit or operational failure. These provisions are not intended to preclude the transmission of control or signaling information or the use of repetitive codes used by certain digital technologies to complete frame or burst intervals. Applicants shall include in their application for equipment authorization a description of how this requirement is met.

10.2. Result:

Pass, the device is compliance with 802.11 a/ b/g/n ac standard, the short control signal is appear during no transmission period.

11. Frequency Stability

11.1. Standard Applicable

According to §15.407 (g) Manufacturers of U-NII devices are responsible for ensuring frequency stability such that an emission is maintained within the band of operation under all conditions of normal operation as specified in the user’s manual.

11.2. Result

Test frequency : 5260 MHz

Temperature test				
Power Supply	Environment	Frequency	Delta (MHz)	frequency drift (PPM)
Vdc	Temperature ()	(MHz)		
5	-20	5260.321600	0.321600	61.14
	-10	5260.138100	0.138100	26.25
	0	5260.066300	0.066300	12.60
	10	5260.042000	0.042000	7.98
	20	5260.048700	0.048700	9.26
	30	5260.038900	0.038900	7.40
	40	5260.042100	0.042100	8.00
	50	5260.042100	0.042100	8.00

Voltage test				
Power Supply	Environment	Frequency	Delta (kHz)	frequency drift (PPM)
Vdc	Temperature ()	(MHz)		
5	20	5260.034400	0.03440	6.54
5.5	20	5260.017800	0.01780	3.38
4.5	20	5260.030600	0.03060	5.82

12. Antenna Requirement

12.1. Standard Applicable

According to §15.203, Antenna requirement.

An intentional radiator shall be designed to ensure that no antenna other than that furnished by the responsible party shall be used with the device. The use of a permanently attached antenna or of an antenna that uses a unique coupling to the intentional radiator shall be considered sufficient to comply with the provisions of this Section. The manufacturer may design the unit so that a broken antenna can be replaced by the user, but the use of a standard antenna jack or electrical connector is prohibited. This requirement does not apply to carrier current devices or to devices operated under the provisions of Sections 15.211, 15.213, 15.217, 15.219, or 15.221. Further, this requirement does not apply to intentional radiators that must be professionally installed, such as perimeter protection systems and some field disturbance sensors, or to other intentional radiators which, in accordance with Section 15.31(d), must be measured at the installation site. However, the installer shall be responsible for ensuring that the proper antenna is employed so that the limits in this Part are not exceeded.

12.2. Antenna Connected Construction

The directional gains of antenna used for transmitting is 0.5 dBi, and the antenna type is PIFA antenna which is designed with permanent attachment and no consideration of replacement. Please see EUT photo for details.

13. TPC and DFS MEASUREMENT

13.1. TPC: Standard Applicable

According to §15.407(h)(1), Transmit power control (TPC). U-NII devices operating in the 5.25-5.35 GHz band and the 5.47-5.725 GHz band shall employ a TPC mechanism. The U-NII device is required to have the capability to operate at least 6 dB below the mean EIRP value of 30 dBm. A TPC mechanism is not required for systems with an e.i.r.p. of less than 500 mW.

According to RSS 210 A9.2 (3), The maximum conducted output power shall not exceed 250mW or $11 + 10 \log_{10} B$, dBm, whichever power is less. The power spectral density shall not exceed 11dBm in any 1.0 MHz band. The maximum e.i.r.p. shall not exceed 1.0 W or $17 + 10 \log_{10} B$, dBm, whichever power is less. B is the 99% emission bandwidth in MHz. Note that devices with a maximum e.i.r.p. greater than 500mW shall implement TPC in order to have the capability to operate at least 6 dB below the maximum permitted e.i.r.p. of 1 W.

15.1.1. Result: N/A, The output power is less than 500mW(27dBm).

13.2. DFS: Standard Applicable

According to §15.407(h)(2), Radar Detection Function of Dynamic Frequency Selection (DFS). U-NII devices operating in the 5.25-5.35 GHz and 5.47-5.725 GHz bands shall employ a DFS radar detection.

According to RSS 210 A9.3), Note: For the band 5600-5650 MHz, no operation is permitted. Until further notice, devices subject to this annex shall not be capable of transmitting in the band 5600-5650 MHz. This restriction is for the protection of Environment Canada weather radars operating in this band.

Devices operating in the bands 5250-5350 MHz, 5470-5600 MHz and 5650-5725 MHz band shall comply with the following:

(a) Devices shall employ a DFS radar detection mechanism to detect the presence of radar systems and to avoid co-channel operation with radar systems (see Note below). The minimum DFS radar signal detection threshold is -62dBm for devices with a maximum e.i.r.p. less than 200mW, and -64dBm for devices with a maximum e.i.r.p. of 200mW to 1 W. The detection threshold power is the received power, averaged over a 1-microsecond reference to a 0dBi antenna. The DFS process shall provide a uniform spreading of the loading over all the available channels.

Note: Test procedures for demonstrating compliance with the DFS radar detection requirements set out in this section are being evaluated by Industry Canada. As an interim measure, the Department will, until further notice, accept utilization of the DFS test procedures published by the U.S. Federal Communications Commission (FCC) 3 to demonstrate compliance with the requirements of this section.

(b) Operational requirements: the requirement for channel availability check time applies in the master operational mode. The requirement for channel move time applies in both the master and slave operational modes.

(i) In-service monitoring: an LE-LAN device should be able to monitor the operating channel to check that a co-channel radar has not moved or started operation within range of the LE-LAN device. During in-service monitoring, the LE-LAN radar detection function continuously searches for radar signals between normal LE-LAN transmissions.

(ii) Channel availability check time: the device shall check if there is a radar system already operating on the channel before it initiates a transmission on a channel and when it moves to a channel. The device may start using the channel if no radar signals with a power level greater than the interference threshold value specified in A9.3 (a) above is detected within 60 seconds.

(iii) Channel move time: after a radar's signal is detected, the device shall cease all transmissions on the operating channel within 10 seconds. Transmission during this period shall consist of normal traffic for a maximum of 200 ms after detection of the radar signal. Intermittent management and control signals may also be sent during the remaining time to facilitate vacating the operating channel.

(iv) Channel closing time: the maximum channel closing time is 260 ms.

(v) Non-occupancy period: a channel that has been flagged as containing a radar signal, either by a channel availability check or in-service monitoring, is subject to a 30-minute non-occupancy period where the channel cannot be used by the LE-LAN device. The non-occupancy period starts from the time that the radar signal is detected.

13.2.1. Limit

Table 1: Applicability of DFS requirements prior to use of a channel

Requirement	Operational Mode		
	Slave	Client(without radar detection)	Client(with radar detection)
Non-occupancy Period	Yes	Not required	Yes
DFS Detection Threshold	Yes	Not required	Yes
Channel Availability Check Time	Yes	Not required	Not required
Uniform Spreading	Yes	Not required	Not required
U-NII Detection Bandwidth	Yes	Not required	Yes

Table 2: Applicability of DFS requirements during normal operation

Requirement	Operational Mode		
	Slave	Client(without radar detection)	Client(with radar detection)
DFS Detection Threshold	Yes	Not required	Yes
Channel Closing Transmission Time	Yes	Yes	Yes
Channel Move Time	Yes	Yes	Yes
U-NII Detection Bandwidth	Yes	Not required	Yes

Refer to KDB Number: 848637

Refer to KDB Number: 905462 APPENDIX B COMPLIANCE MEASUREMENT PROCEDURES FOR UNLICENSED-NATIONAL INFORMATION INFRASTRUCTURE DEVICES OPERATING IN THE 5.25-5.35 GHz AND 5.47-5.725 GHz BANDS INCORPORATING DYNAMIC FREQUENCY SELECTION.

Table 3: Interference Threshold values, Master or Client incorporating In-Service Monitoring

Maximum Transmit Power	Value (see note)
≥ 200 milliwatt	-64 dBm
< 200 milliwatt	-62 dBm

Note 1: This is the level at the input of the receiver assuming a 0 dBi receive antenna
 Note 2: Throughout these test procedures an additional 1 dB has been added to the amplitude of the test transmission waveforms to account for variations in measurement equipment. This will ensure that the test signal is at or above the detection threshold level to trigger a DFS response.

Table 4: DFS Response requirement values

Parameter	Value
<i>Non-occupancy period</i>	Minimum 30 minutes
<i>Channel Availability Check Time</i>	60 seconds
<i>Channel Move Time</i>	10 seconds See Note 1.
<i>Channel Closing Transmission Time</i>	200 milliseconds + an aggregate of 60 milliseconds over remaining 10 second period. See Notes 1 and 2.
<i>U-NII Detection Bandwidth</i>	Minimum 80% of the U-NII 99% transmission power bandwidth. See Note 3.

Note 1: The instant that the *Channel Move Time* and the *Channel Closing Transmission Time* begins is as follows:

- For the Short Pulse Radar Test Signals this instant is the end of the *Burst*.
- For the Frequency Hopping radar Test Signal, this instant is the end of the last radar *Burst* generated.
- For the Long Pulse Radar Test Signal this instant is the end of the 12 second period defining the *Radar Waveform*.

Note 2: The *Channel Closing Transmission Time* is comprised of 200 milliseconds starting at the beginning of the *Channel Move Time* plus any additional intermittent control signals required to facilitate a *Channel* move (an aggregate of 60 milliseconds) during the remainder of the 10 second period. The aggregate duration of control signals will not count quiet periods in between transmissions.

Note 3: During the *U-NII Detection Bandwidth* detection test, radar type 1 is used and for each frequency step the minimum percentage of detection is 90 percent. Measurements are performed with no data traffic.

Table 5: Radar Test Waveforms

Short Pulse Radar

Radar Type	Pulse Width (μsec)	PRI (μsec)	Number of Pulses	Minimum Percentage of Successful Detection	Minimum Trials
1	1	1428	18	60%	30
2	1-5	150-230	23-29	60%	30
3	6-10	200-500	16-18	60%	30
4	11-20	200-500	12-16	60%	30
Aggregate (Radar Types 1-4)				80%	120

A minimum of 30 unique waveforms are required for each of the Short Pulse Radar Types 2 through 4. For Short Pulse Radar Type 1, the same waveform is used a minimum of 30 times. If more than 30 waveforms are used for Short Pulse Radar Types 2 through 4, then each additional waveform must also be unique and not repeated from the previous waveforms

Long Pulse Radar

Radar Type	Pulse Width (μsec)	Chirp Width (MHz)	PRI (μsec)	Number of Pulses per Burst	Number of Bursts	Minimum Percentage of Successful Detection	Minimum Trials
5	50-100	5-20	1000-2000	1-3	8-20	80%	30

The parameters for this waveform are randomly chosen. Thirty unique waveforms are required for the Long Pulse Radar Type waveforms. If more than 30 waveforms are used for the Long Pulse Radar Type waveforms, then each additional waveform must also be unique and not repeated from the previous waveforms.

Frequency Hopping Radar

Radar Type	Pulse Width (μsec)	PRI (μsec)	Pulses per Hop	Hopping Rate (kHz)	Hopping Sequence Length (msec)	Minimum Percentage of Successful Detection	Minimum Trials
6	1	333	9	.333	300	70%	30

For the Frequency Hopping Radar Type, the same *Burst* parameters are used for each waveform. The hopping sequence is different for each waveform and a 100-length segment is selected from the hopping sequence defined by the following algorithm: 3

The first frequency in a hopping sequence is selected randomly from the group of 475 integer frequencies from 5250 – 5724 MHz. Next, the frequency that was just chosen is removed from the group and a frequency is randomly selected from the remaining 474 frequencies in the group. This process continues until all 475 frequencies are chosen for the set. For selection of a random frequency, the frequencies remaining within the group are always treated as equally likely.

13.2.2. Test Setup

Setup for Master with injection at the Master

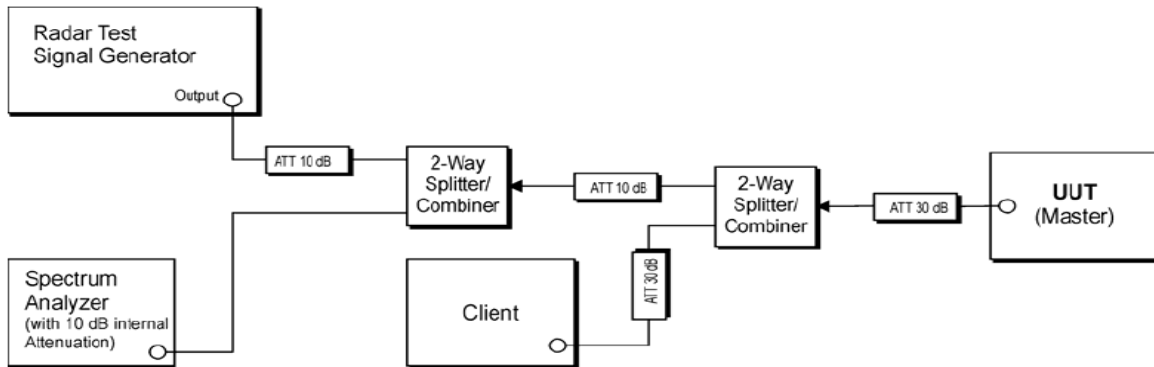

Setup for Client with injection at the Master

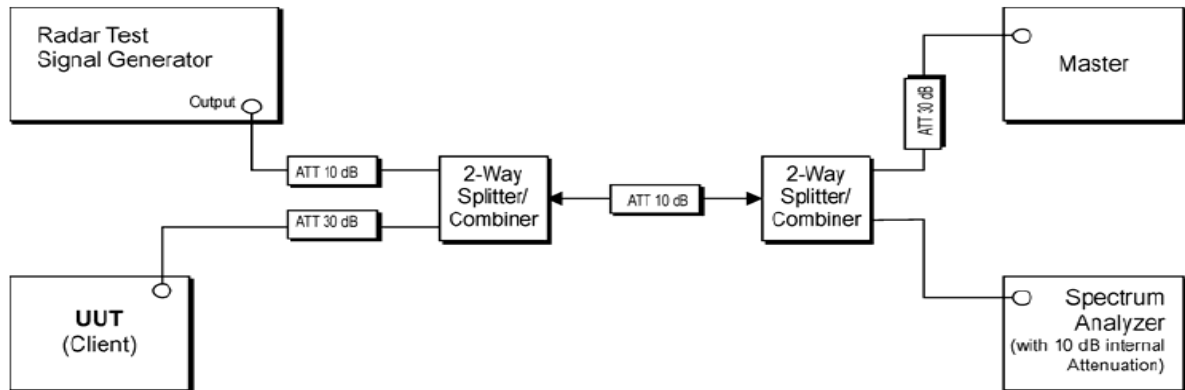

Setup for Client with injection at the Client

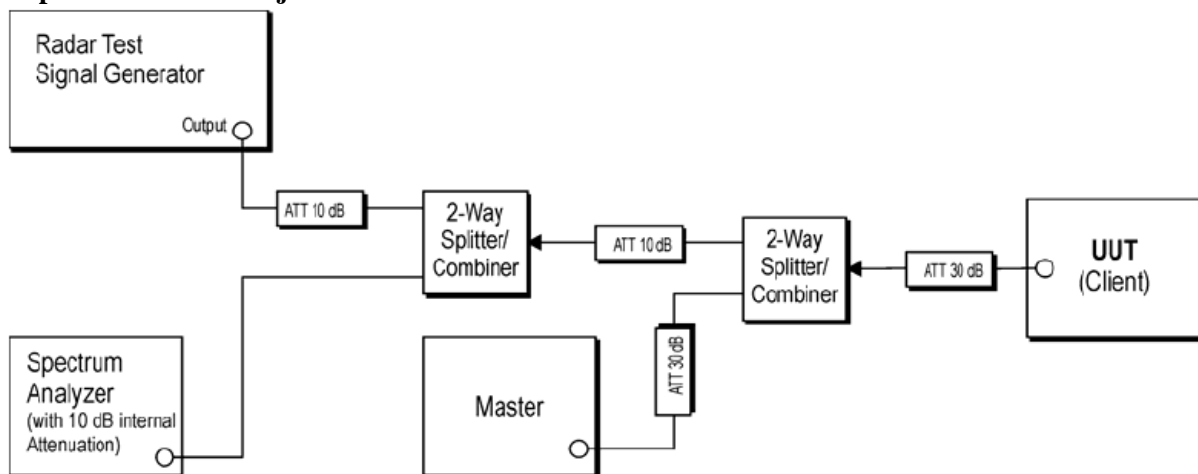

13.3. Test Equipment Used:

Conducted DFS Test Site					
Equipment Type	MFR	Model Number	Serial Number	Last Cal.	Cal Due.
Signal Generator	Agilent	E4438C	MY49071550	11/16/2017	11/15/2018
Signal Generator	keysight	N5182B	MY53052399	12/07/2017	12/06/2018
Spectrum analyzer	keysight	N9010A	MY56070257	07/07/2018	07/06/2019
AP Router	ASUS	RTAC66U	FTX1220905D	NA	NA
Usb Adapter	D-Link	DWA-182	QBYS1D8000073	NA	NA
Test Box	keysight	AD211A	NA	NA	NA
Test Box	keysight	AD191A	NA	NA	NA
Direction Coupler	Krytar	1821S	1461	NA	NA
Splitter	Mini-Circuits	ZN2PD-63-S	UU97201111	NA	NA
Attenuator	Woken	Watt-65m3502	11051601	NA	NA
Software	Agilent	Adaptive TEST	NA	NA	NA
Cable	Draka	NA	NA	NA	NA
Test Software	Keysight	N9607B DFS Radar Profiles	NA	NA	NA
Test Software	Keysight	ETSI Standard test system	NA	NA	NA

13.3.1. Description of EUT :

EUT operates over the 5250-5350MHz and 5470-5725MHz ranges and EUT is a slave device (client equipment) w/o radar detection and DFS capability. EUT has a gain of -0.03 and 0.25dBi in the 5GHz Band.

The EUT utilizes the 802.11a architecture, with a nominal channel bandwidth of 20MHz WLAN traffic is generated by streaming the mpeg file from the master to slave in full monitor video mode using the media player.

The rated output power of the master unit is >23dBm(EIRP).therefore the required interference threshold level is -64dBm.after correction for antenna gain and procedural adjustments, the required conducted threshold at the antenna port is -64+6=-58, and the master device as employed for the applicable DFS test is CISCO router whose FCC ID= LDK102061

13.4. Test results

Applicability of DFS requirements prior to use of a channel

Requirement	Operational Mode: Client(without radar detection)	
	Test Result	Remark
Non-occupancy Period	N/A	Pass
DFS Detection Threshold	N/A	Pass
Channel Availability Check Time	N/A	Pass
Uniform Spreading	N/A	Pass
U-NII Detection Bandwidth	N/A	Pass

Applicability of DFS requirements during normal operation

Requirement	Operational Mode: Client(without radar detection)	
	Test Result	Remark
DFS Detection Threshold	N/A	Pass
Channel Closing Transmission Time	Less than 200ms, Refer to next page for plots.	Pass
Channel Move Time	Less than 10s, Refer to next page for plots.	Pass
U-NII Detection Bandwidth	N/A	Pass

Input Level to Master AP= -62dBm

5250MHz ~ 5350MHz

Radar Type 1 Channel Move & Closing Transmission Time



Channel Move Time

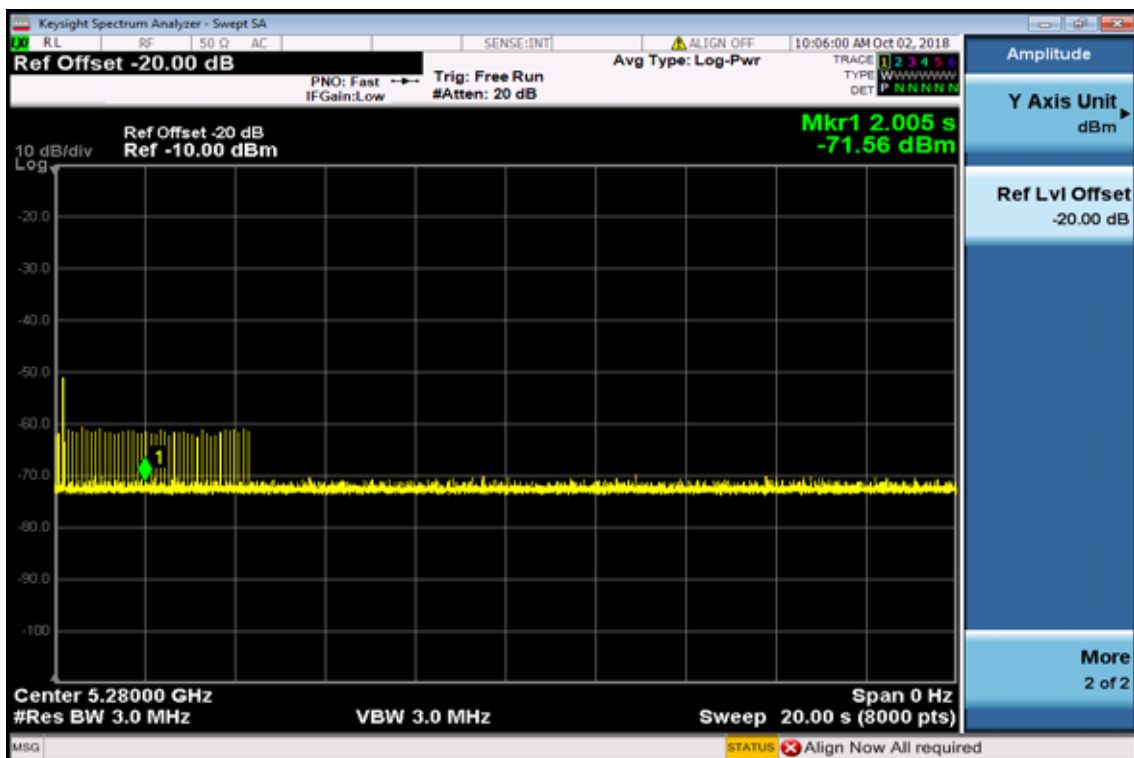

5500MHz ~ 5700MHz

Radar Type 1 Channel Move & Closing Transmission Time



Channel Move Time

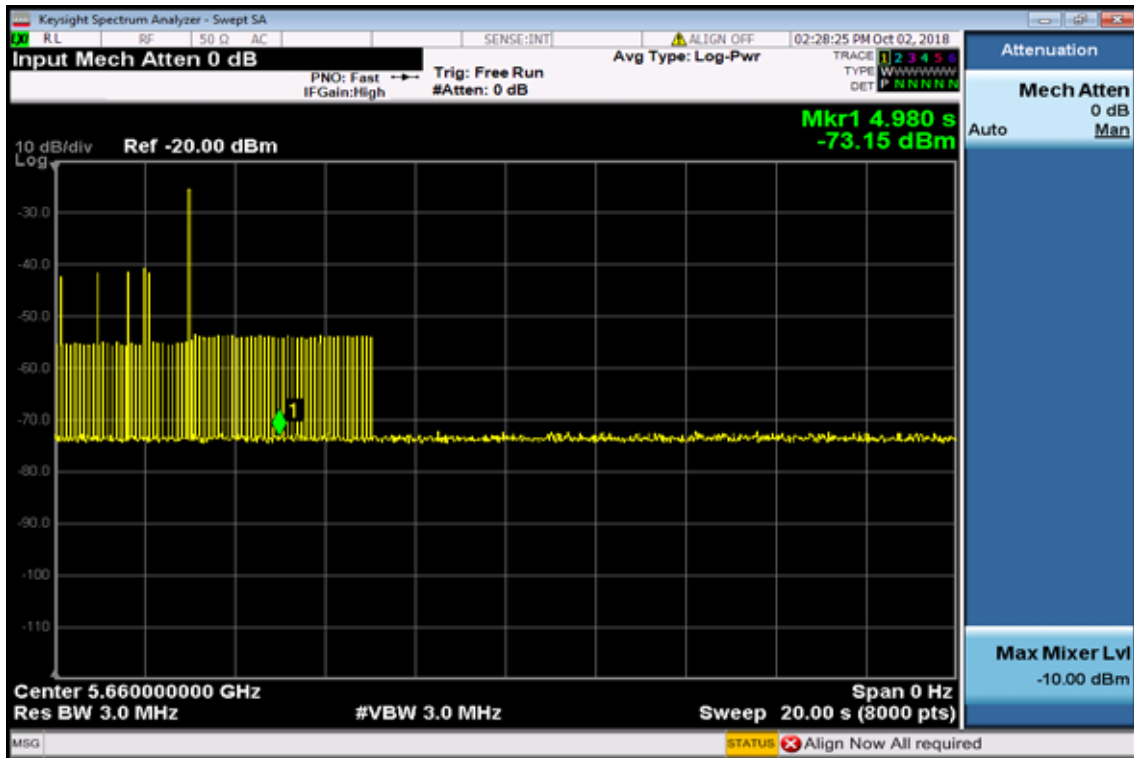

14. Maximum Permissible Exposure (MPE)

14.1 Standard Applicable

According to §1.1307(b)(1), systems operating under the provisions of this section shall be operated in a manner that ensure that the public is not exposed to radio frequency energy level in excess of the Commission's guideline.

This is a Mobile device, the MPE is required.

According to §1.1310 and §2.1093 RF exposure is calculated.

Limits for Maximum Permissive Exposure (MPE)

Frequency Range (MHz)	Electric Field Strength (V/m)	Magnetic Field Strength (A/m)	Power Density (mW/cm ²)	Averaging Time (minute)
Limits for General Population/Uncontrolled Exposure				
0.3-1.34	614	1.63	*(100)	30
1.34-30	824/f	2.19/f	*(180/f ²)	30
30-300	27.5	0.073	0.2	30
300-1500	/	/	F/1500	30
1500-15000	/	/	1.0	30

F = frequency in MHz

* = Plane-wave equipment power density

14.2 Maximum Permissible Exposure (MPE) Evaluation

MPE Prediction (802.11a) (worst case)

Mode	Channel	power (dBm)	limit(dBm)	result
802.11a	5180	11.34	23.97	pass
	5260	12.01	23.97	pass
	5320	11.91	23.97	pass
	5500	11.20	23.97	pass
	5600	11.63	23.97	pass
	5700	11.05	23.97	pass
	5745	8.67	30	pass
	5785	9.15	30	pass
	5825	8.05	30	pass

Prediction of MPE limit at a given distance

Equation from page 18 of OET Bulletin 65, Edition 97-01

$$S = \frac{P \cdot G}{4 \cdot R^2}$$

Where: S = Power density

P = Power input to antenna

G = Power gain of the antenna in the direction of interest relative to an isotropic radiator

R = Distance to the center of radiation of the antenna

Maximum peak output power at antenna input terminal:	12.01	(dBm)
Maximum peak output power at antenna input terminal:	15.88546749	(mW)
Duty cycle:	100	(%)
Maximum Pav :	15.88546749	(mW)
Antenna gain (typical):	0.5	(dBi)
Maximum antenna gain:	1.122018454	(numeric)
Prediction distance:	20	(cm)
Prediction frequency:	5260	(MHz)
MPE limit for uncontrolled exposure at prediction	1	(mW/cm ²)
Power density at predication frequency at 20 (cm)	0.0035477	(mW/cm ²)

Measurement Result

The predicted power density level at 20 cm is 0.0035477 mW/cm². This is below the uncontrolled exposure limit of 1 mW/cm² at 5260MHz.