

# SAR EVALUATION REPORT

For

## CHUNGHSIN INTERNATIONAL ELECTRONICS CO.,LTD

618 GONGREN WEST ROAD,JIAOJIANG AREA TAIZHOU ZHEJIANG 318000 China

**FCC ID: 2A15MN1186Q**

|   |                                  |
|---|----------------------------------|
| <b>Report Type:</b><br>Original Report  | <b>Product Type:</b><br>Notebook |
| <b>Test Engineer:</b> Rocky Xiao  | <i>Rocky Xiao</i>                |
| <b>Report Number:</b> RDG160622804-20   |                                  |
| <b>Report Date:</b> 2016-07-27  |                                  |
| <b>Reviewed By:</b> Jerry Zhang<br>EMC Manager  | <i>Jerry Zhang</i>               |
| <b>Test Laboratory:</b> Bay Area Compliance Laboratories Corp. (Dongguan)<br>No.69 Pulongcun, Puxinhu Industrial Zone,<br>Tangxia, Dongguan, Guangdong, China<br>Tel: +86-769-86858888<br>Fax: +86-769-86858891<br><a href="http://www.baclcorp.com.cn">www.baclcorp.com.cn</a> |                                  |

| Attestation of Test Results  |  |   |                    |
|--|--|---|--------------------|
| <b>EUT Information</b>   | <b>Company Name</b>  | CHUNGHSIN INTERNATIONAL ELECTRONICS CO.,LTD |                    |
|  | <b>EUT Description</b>   | MI1166R                                     |                    |
|  | <b>FCC ID</b>  | 2AI5MN1186Q                                 |                    |
|  | <b>Serial Number</b>   | 160622804                                   |                    |
|  | <b>Test Date</b>   | 2016-07-08                                  |                    |
| <b>MODE</b>  |  | <b>Max. SAR Level(s) Reported(W/Kg)</b>     | <b>Limit(W/Kg)</b> |
| <b>WLAN</b>  | 1g Body SAR  | <b>1.46</b>                                 | <b>1.6</b>         |
| <b>Applicable Standards</b>  | <b>ANSI / IEEE C95.1 : 2005</b><br>IEEE Standard for Safety Levels with Respect to Human Exposure to Radio Frequency Electromagnetic Fields,3 kHz to 300 GHz.  |   |                    |
|  | <b>ANSI / IEEE C95.3 : 2002</b><br>IEEE Recommended Practice for Measurements and Computations of Radio Frequency Electromagnetic Fields With Respect to Human Exposure to SuchFields,100 kHz—300 GHz.   |   |                    |
|  | <b>FCC 47 CFR part 2.1093</b><br>Radiofrequency radiation exposure evaluation: portable devices  |   |                    |
|  | <b>IEEE1528:2013</b><br>IEEE Recommended Practice for Determining the Peak Spatial-Average Specific Absorption Rate (SAR) in the Human Head from Wireless Communications Devices: Measurement Techniques   |   |                    |
|  | <b>IEC 62209-2:2010</b><br>Human exposure to radio frequency fields from hand-held and body-mounted wireless communication devices-Human models, instrumentation, and procedures-Part 2: Procedure to determine the specific absorption rate (SAR) for wireless communication devices used in close proximity to the human body (frequency range of 30 MHz to 6 GHz) |   |                    |
|  | <b>KDB procedures</b><br>KDB 447498 D01 General RF Exposure Guidance v06.<br>KDB 865664 D01 SAR Measurement 100 MHz to 6 GHz v01r04<br>KDB 865664 D02 RF Exposure Reporting v01r02<br>KDB 248227 D01 802 11 Wi-Fi SAR v02r02   |   |                    |
| <p><b>Note:</b> This wireless device has been shown to be capable of compliance for localized specific absorption rate (SAR) for General Population/Uncontrolled Exposure limits specified in ANSI/IEEE Standards and has been tested in accordance with the measurement procedures specified in IEEE 1528-2013 and RF exposure KDB procedures.</p> <p><b>The results and statements contained in this report pertain only to the device(s) evaluated.</b></p> |  |   |                    |

## TABLE OF CONTENTS

|   |           |
|---|-----------|
| <b>DOCUMENT REVISION HISTORY .....</b>                          | <b>4</b>  |
| <b>EUT DESCRIPTION .....</b>                                    | <b>5</b>  |
| TECHNICAL SPECIFICATION .....                                   | 5         |
| <b>REFERENCE, STANDARDS, AND GUIDELINES .....</b>               | <b>6</b>  |
| SAR LIMITS .....  | 7         |
| <b>FACILITIES.....</b>  | <b>8</b>  |
| <b>DESCRIPTION OF TEST SYSTEM .....</b>                         | <b>9</b>  |
| <b>EQUIPMENT LIST AND CALIBRATION .....</b>                     | <b>14</b> |
| EQUIPMENTS LIST & CALIBRATION INFORMATION .....                 | 14        |
| <b>SAR MEASUREMENT SYSTEM VERIFICATION .....</b>                | <b>15</b> |
| LIQUID VERIFICATION .....                                       | 15        |
| SYSTEM ACCURACY VERIFICATION .....                              | 16        |
| <b>EUT TEST STRATEGY AND METHODOLOGY .....</b>                  | <b>18</b> |
| TEST POSITIONS FOR DEVICE OPERATING NEXT TO A PERSON’S EAR..... | 18        |
| CHEEK/TOUCH POSITION .....                                      | 19        |
| EAR/TILT POSITION .....   | 19        |
| TEST POSITIONS FOR BODY-WORN AND OTHER CONFIGURATIONS .....     | 20        |
| SAR EVALUATION PROCEDURE.....                                   | 21        |
| TEST METHODOLOGY .....  | 21        |
| <b>CONDUCTED OUTPUT POWER MEASUREMENT .....</b>                 | <b>22</b> |
| PROVISION APPLICABLE .....                                      | 22        |
| MAXIMUM TARGET OUTPUT POWER .....                               | 22        |
| TEST RESULTS: .....   | 23        |
| <b>STANDALONE SAR DESCRIPTION.....</b>                          | <b>24</b> |
| <b>SAR MEASUREMENT RESULTS .....</b>                            | <b>25</b> |
| ANTENNA LOCATION .....  | 25        |
| ANTENNA DISTANCE TO EDGE .....                                  | 25        |
| SAR TEST EXCLUSION FOR THE EUT EDGE CONSIDERATIONS RESULT ..... | 25        |
| SAR TEST DATA.....  | 27        |
| <b>SAR MEASUREMENT VARIABILITY .....</b>                        | <b>28</b> |
| <b>SAR PLOTS (SUMMARY OF THE HIGHEST SAR VALUES).....</b>       | <b>29</b> |
| <b>APPENDIX A MEASUREMENT UNCERTAINTY .....</b>                 | <b>31</b> |
| <b>APPENDIX B – PROBE CALIBRATION CERTIFICATES.....</b>         | <b>33</b> |
| <b>APPENDIX C DIPOLE CALIBRATION CERTIFICATES.....</b>          | <b>44</b> |
| <b>APPENDIX D EUT TEST POSITION PHOTOS .....</b>                | <b>52</b> |
| LIQUID DEPTH ≥ 15CM.....  | 52        |
| BODY BACK(LCD) (0 MM) .....                                     | 52        |
| BODY TOP (0MM).....   | 53        |

**DOCUMENT REVISION HISTORY**

| <b>Revision Number</b> | <b>Report Number</b> | <b>Description of Revision</b> | <b>Date of Revision</b> |
|------------------------|----------------------|--------------------------------|-------------------------|
| 0                      | RDG160622804-20      | Original Report                | 2016-07-27              |

FINAL

## EUT DESCRIPTION

This report has been prepared on behalf of *CHUNGHSIN INTERNATIONAL ELECTRONICS CO.,LTD* and their product, Model: MI1166R, FCC ID: 2AI5MN1186Q or the EUT (Equipment under Test) as referred to in the rest of this report.

### Technical Specification

|                               |   |
|-------------------------------|---|
| <b>Exposure Category:</b>     | Population / Uncontrolled                             |
| <b>Antenna Type(s):</b>       | Internal Antenna                                      |
| <b>Body-Worn Accessories:</b> | None  |
| <b>Operation Mode :</b>       | WLAN, Bluetooth                                       |
| <b>Frequency Band:</b>        | WLAN: 2412MHz-2462 MHz<br>Bluetooth : 2402MHz-2480MHz |
| <b>Conducted RF Power:</b>    | WLAN: 14.88 dBm                                       |
|                               | Bluetooth:2.79 dBm                                    |
|                               | BLE: 4.56 dBm   |
| <b>Dimensions (L*W*H):</b>    | 30 cm (L) × 20 cm (W) × 2.1 cm (H)                    |
| <b>Power Source:</b>          | 3.7 VDC Rechargeable Battery                          |
| <b>Normal Operation:</b>      | Body-worn   |

---

## REFERENCE, STANDARDS, AND GUIDELINES

---

### **FCC:**

The Report and Order requires routine SAR evaluation prior to equipment authorization of portable transmitter devices, including portable telephones. For consumer products, the applicable limit is 1.6 mW/g as recommended by the ANSI/IEEE standard C95.1-1992 [6] for an uncontrolled environment (Paragraph 65). According to the Supplement C of OET Bulletin 65 "Evaluating Compliance with FCC Guide-lines for Human Exposure to Radio frequency Electromagnetic Fields", released on Jun 29, 2001 by the FCC, the device should be evaluated at maximum output power (radiated from the antenna) under "worst-case" conditions for normal or intended use, incorporating normal antenna operating positions, device peak performance frequencies and positions for maximum RF energy coupling.

This report describes the methodology and results of experiments performed on wireless data terminal. The objective was to determine if there is RF radiation and if radiation is found, what is the extent of radiation with respect to safety limits. SAR (Specific Absorption Rate) is the measure of RF exposure determined by the amount of RF energy absorbed by human body (or its parts) – to determine how the RF energy couples to the body or head which is a primary health concern for body worn devices. The limit below which the exposure to RF is considered safe by regulatory bodies in North America is 1.6 mW/g average over 1 gram of tissue mass.

### **CE:**

The order requires routine SAR evaluation prior to equipment authorization of portable transmitter devices, including portable telephones. For consumer products, the applicable limit is 2 mW/g as recommended by EN62209-1 for an uncontrolled environment. According to the Standard, the device should be evaluated at maximum output power (radiated from the antenna) under "worst-case" conditions for normal or intended use, incorporating normal antenna operating positions, device peak performance frequencies and positions for maximum RF energy coupling.

This report describes the methodology and results of experiments performed on wireless data terminal. The objective was to determine if there is RF radiation and if radiation is found, what is the extent of radiation with respect to safety limits. SAR (Specific Absorption Rate) is the measure of RF exposure determined by the amount of RF energy absorbed by human body (or its parts) – to determine how the RF energy couples to the body or head which is a primary health concern for body worn devices. The limit below which the exposure to RF is considered safe by regulatory bodies in Europe is 2 mW/g average over 10 gram of tissue mass.

The test configurations were laid out on a specially designed test fixture to ensure the reproducibility of measurements. Each configuration was scanned for SAR. Analysis of each scan was carried out to characterize the above effects in the device.

**SAR Limits**

FCC Limit

| EXPOSURE LIMITS   | SAR (W/kg)   |  |
|---|--|--|
|   | (General Population / Uncontrolled Exposure Environment) | (Occupational / Controlled Exposure Environment) |
| Spatial Average<br>(averaged over the whole body)             | 0.08   | 0.4  |
| Spatial Peak<br>(averaged over any 1 g of tissue)             | 1.60   | 8.0  |
| Spatial Peak<br>(hands/wrists/feet/ankles averaged over 10 g) | 4.0  | 20.0   |

CE Limit

| EXPOSURE LIMITS   | SAR (W/kg)   |  |
|---|--|--|
|   | (General Population / Uncontrolled Exposure Environment) | (Occupational / Controlled Exposure Environment) |
| Spatial Average<br>(averaged over the whole body)             | 0.08   | 0.4  |
| Spatial Peak<br>(averaged over any 10 g of tissue)            | 2.0  | 10   |
| Spatial Peak<br>(hands/wrists/feet/ankles averaged over 10 g) | 4.0  | 20.0   |

Population/Uncontrolled Environments are defined as locations where there is the exposure of individual who have no knowledge or control of their exposure.

Occupational/Controlled Environments are defined as locations where there is exposure that may be incurred by people who are aware of the potential for exposure (i.e. as a result of employment or occupation).

General Population/Uncontrolled environments Spatial Peak limit 1.6W/kg (FCC) & 2 W/kg (CE) applied to the EUT.

---

## **FACILITIES**

---

The Test site used by Bay Area Compliance Laboratories Corp. (Dongguan) to collect test data is located on the No.69 Pulongcun, Puxinhu Industrial Zone, Tangxia, Dongguan, Guangdong, China

FINAL

## DESCRIPTION OF TEST SYSTEM

These measurements were performed with the automated near-field scanning system DASY5 from Schmid & Partner Engineering AG (SPEAG) which is the Fifth generation of the system shown in the figure hereinafter:



### DASY5 System Description

The DASY5 system for performing compliance tests consists of the following items:

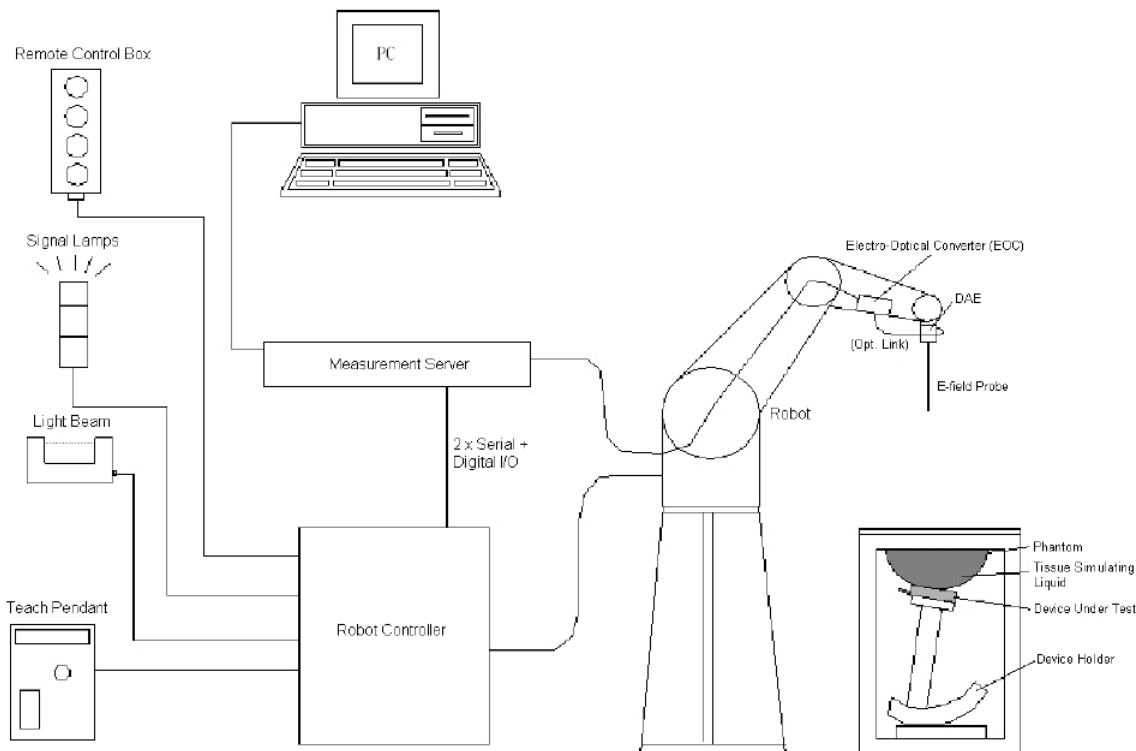

- A standard high precision 6-axis robot (Staubli TX=RX family) with controller, teach pendant and software. An arm extension for accommodating the data acquisition electronics (DAE).
- An isotropic field probe optimized and calibrated for the targeted measurement.
- A data acquisition electronics (DAE) which performs the signal application, signal multiplexing, AD-conversion, offset measurements, mechanical surface detection, collision detection, etc. The unit is battery powered with standard or rechargeable batteries. The signal is optically transmitted to the EOC.
- The Electro-optical converter (EOC) performs the conversion from optical to electrical signals for the digital communication to the DAE. To use optical surface detection, a special version of the EOC is required. The EOC signal is transmitted to the measurement server.
- The function of the measurement server is to perform the time critical tasks such as signal filtering, control of the robot operation and fast movement interrupts.
- The Light Beam used is for probe alignment. This improves the (absolute) accuracy of the probe positioning.
- A computer running Win7 professional operating system and the DASY52 software.
- Remote control and teach pendant as well as additional circuitry for robot safety such as warning lamps, etc.
- The phantom, the device holder and other accessories according to the targeted measurement.

### DASY5 Measurement Server

The DASY5 measurement server is based on a PC/104 CPU board with a 400MHz Intel ULV Celeron, 128MB chip-disk and 128MB RAM. The necessary circuits for communication with the DAE4 (or DAE3) electronics box, as well as the 16 bit AD-converter system for optical detection and digital I/O interface are contained on the DASY5 I/O board, which is directly connected to the PC/104 bus of the CPU board.



The measurement server performs all real-time data evaluation of field measurements and surface detection, controls robot movements and handles safety operation. The PC operating system cannot interfere with these time critical processes. All connections are supervised by a watchdog, and disconnection of any of the cables to the measurement server will automatically disarm the robot and disable all program-controlled robot movements. Furthermore, the measurement server is equipped with an expansion port which is reserved for future applications. Please note that this expansion port does not have a standardized point out, and therefore only devices provided by SPEAG can be connected. Devices from any other supplier could seriously damage the measurement server.

### Data Acquisition Electronics

The data acquisition electronics (DAE4) consist of a highly sensitive electrometer-grade preamplifier with auto-zeroing, a channel and gain-switching multiplexer, a fast 16 bit AD-converter and a command decoder with a control logic unit. Transmission to the measurement server is accomplished through an optical downlink for data and status information, as well as an optical uplink for commands and the clock.

The mechanical probe mounting device includes two different sensor systems for Back(LCD)al and sideways probe contacts. They are used for mechanical surface detection and probe collision detection.

The input impedance of both the DAE4 as well as of the DAE3 box is 200M $\Omega$ ; the inputs are symmetrical and floating. Common mode rejection is above 80 dB.

**EX3DV4 E-Field Probes**

|                      |   |
|----------------------|---|
| <b>Frequency</b>     | 10 MHz to > 6 GHz<br>Linearity: ± 0.2 dB (30 MHz to 6 GHz)  |
| <b>Directivity</b>   | ± 0.3 dB in TSL (rotation around probe axis)<br>± 0.5 dB in TSL (rotation normal to probe axis)   |
| <b>Dynamic Range</b> | 10 µW/g to > 100 mW/g<br>Linearity: ± 0.2 dB (noise: typically < 1 µW/g)  |
| <b>Dimensions</b>    | Overall length: 337 mm (Tip: 20 mm)<br>Tip diameter: 2.5 mm (Body: 12 mm)<br>Typical distance from probe tip to dipole centers: 1 mm  |
| <b>Application</b>   | High precision dosimetric measurements in any exposure scenario (e.g., very strong gradient fields); the only probe that enables compliance testing for frequencies up to 6 GHz with precision of better 30%. |
| <b>Compatibility</b> | DASY3, DASY4, DASY52 SAR and higher, EASY4/MRI  |

**SAM Twin Phantom**

The SAM twin phantom is a fiberglass shell phantom with 2mm shell thickness (except the ear region, where shell thickness

increases to 6 mm). The phantom has three measurement areas:

- \_ Left hand
- \_ Right hand
- \_ Flat phantom

The phantom table for the DASY systems based on the TX90XL and RX160L robots have the size of 100 x 50 x 85 cm (L x W x H).

The phantom table for the compact DASY systems based on the RX60L robot have the size of 100 x 75 x 91 cm (L x W x H); these tables are reinforced for mounting of the robot onto the table.

For easy dislocation these tables have fork lift cut outs at the bottom.

The bottom plate contains three pairs of bolts for locking the device holder. The device holder positions are adjusted to the standard measurement positions in the three sections. Only one device holder is necessary if two phantoms are used (e.g., for different liquids)

A white cover is provided to cover the phantom during off-periods to prevent water evaporation and changes in the liquid parameters. Free space scans of devices on top of this phantom cover are possible. Three reference marks are provided on the phantom counter. These reference marks are used to teach the absolute phantom position relative to the robot.



## Robots

The DASY5 system uses the high precision industrial robots TX90XL from Staubli SA (France). The TX robot family is the successor of the well known RX robot family and offers the same features important for our application:

- High precision (repeatability 0.02mm)
- High reliability (industrial design)
- Low maintenance costs (virtually maintenance free due to direct drive gears; no belt drives)
- Jerk-free straight movements (brushless synchrony motors; no stepper motors)
- Low ELF interference (motor control fields shielded via the closed metallic construction shields)

The above mentioned robots are controlled by the Staubli CS8c robot controllers. All information regarding the use and maintenance of the robot arm and the robot controller is contained on the CDs delivered along with the robot. Paper manuals are available upon request direct from Staubli.

## Area Scans

Area scans are defined prior to the measurement process being executed with a user defined variable spacing between each measurement point (integral) allowing low uncertainty measurements to be conducted. Scans defined for FCC applications utilize a 15mm 2 step integral, with 1.5mm interpolation used to locate the peak SAR area used for zoom scan assessments.

Where the system identifies multiple SAR peaks (which are within 25% of peak value) the system will provide the user with the option of assessing each peak location individually for zoom scan averaging.

## Zoom Scan (Cube Scan Averaging)

The averaging zoom scan volume utilized in the DASY5 software is in the shape of a cube and the side dimension of a 1 g or 10 g mass is dependent on the density of the liquid representing the simulated tissue. A density of 1000 kg/m<sup>3</sup> is used to represent the head and body tissue density and not the phantom liquid density, in order to be consistent with the definition of the liquid dielectric properties, i.e. the side length of the 1g cube is 10mm, with the side length of the 10g cube is 21.5mm.

When the cube intersects with the surface of the phantom, it is oriented so that 3 vertices touch the surface of the shell or the center of a face is tangent to the surface. The face of the cube closest to the surface is modified in order to conform to the tangent surface.

The zoom scan integer steps can be user defined so as to reduce uncertainty, but normal practice for typical test applications (including FCC) utilize a physical step of 7 x 7 x 7 (5mmx5mmx5mm) providing a volume of 30 mm in the X & Y & Z axis.

### Tissue Dielectric Parameters for Head and Body Phantoms

The head tissue dielectric parameters recommended by the IEEE SCC-34/SC-2 in P1528 have been incorporated in the following table. These head parameters are derived from planar layer models simulating the highest expected SAR for the dielectric properties and tissue thickness variations in a human head. Other head and body tissue parameters that have not been specified in P1528 are derived from the tissue dielectric parameters computed from the 4-Cole-Cole equations described in Reference [12] and extrapolated according to the head parameters specified in P1528.

#### Recommended Tissue Dielectric Parameters for Head and Body

| Frequency<br>(MHz) | Head Tissue  |                | Body Tissue  |                |
|--------------------|--------------|----------------|--------------|----------------|
|                    | $\epsilon_r$ | $\sigma$ (S/m) | $\epsilon_r$ | $\sigma$ (S/m) |
| 150                | 52.3         | 0.76           | 61.9         | 0.80           |
| 300                | 45.3         | 0.87           | 58.2         | 0.92           |
| 450                | 43.5         | 0.87           | 56.7         | 0.94           |
| 835                | 41.5         | 0.90           | 55.2         | 0.97           |
| 900                | 41.5         | 0.97           | 55.0         | 1.05           |
| 915                | 41.5         | 0.98           | 55.0         | 1.06           |
| 1450               | 40.5         | 1.20           | 54.0         | 1.30           |
| 1610               | 40.3         | 1.29           | 53.8         | 1.40           |
| 1800-2000          | 40.0         | 1.40           | 53.3         | 1.52           |
| 2450               | 39.2         | 1.80           | 52.7         | 1.95           |
| 3000               | 38.5         | 2.40           | 52.0         | 2.73           |
| 5800               | 35.3         | 5.27           | 48.2         | 6.00           |

## EQUIPMENT LIST AND CALIBRATION

### Equipments List & Calibration Information

| Equipment                      | Model         | S/N           | Calibration Date | Calibration Due Date |
|--------------------------------|---------------|---------------|------------------|----------------------|
| Robot                          | RX90          | D03636        | N/A              | N/A                  |
| DASY5 Test Software            | DASY52.8      | N/A           | N/A              | N/A                  |
| DASY5 Measurement Server       | DASY5 4.5.12  | 1470          | N/A              | N/A                  |
| Data Acquisition Electronics   | DAE4          | 1459          | 2015/9/18        | 2016/9/18            |
| E-Field Probe                  | EX3DV4        | 7329          | 2016/2/19        | 2017/2/19            |
| Dipole,2450MHz                 | D2450V3       | 971           | 2015/7/8         | 2018/7/8             |
| Mounting Device                | MD4HHTV5      | SD 000 H01 KA | N/A              | N/A                  |
| Twin SAM                       | Twin SAM V5.0 | 1874          | N/A              | N/A                  |
| Simulated Tissue 2450 MHz Body | TS-2450-B     | 1512245002    | Each Time        | /                    |
| Network Analyzer               | 8752C         | 3140A02356    | 2016/6/5         | 2017/6/4             |
| Dielectric probe kit           | 85070B        | US33020324    | 2016/6/13        | 2017/6/13            |
| Signal Generator               | E4422B        | MY41000355    | 2015/11/23       | 2016/11/22           |
| Power Meter                    | EPM-441A      | GB37481494    | 2015/11/3        | 2016/11/3            |
| Power Meter Sensor             | 8481A         | T-03-EM-127   | 2015/11/3        | 2016/11/3            |
| Power Amplifier                | 5205PE        | 1015          | N/A              | N/A                  |
| Directional Coupler            | 488Z          | N/A           | N/A              | N/A                  |
| Attenuator                     | 20dB, 100W    | N/A           | N/A              | N/A                  |

# SAR MEASUREMENT SYSTEM VERIFICATION

## Liquid Verification

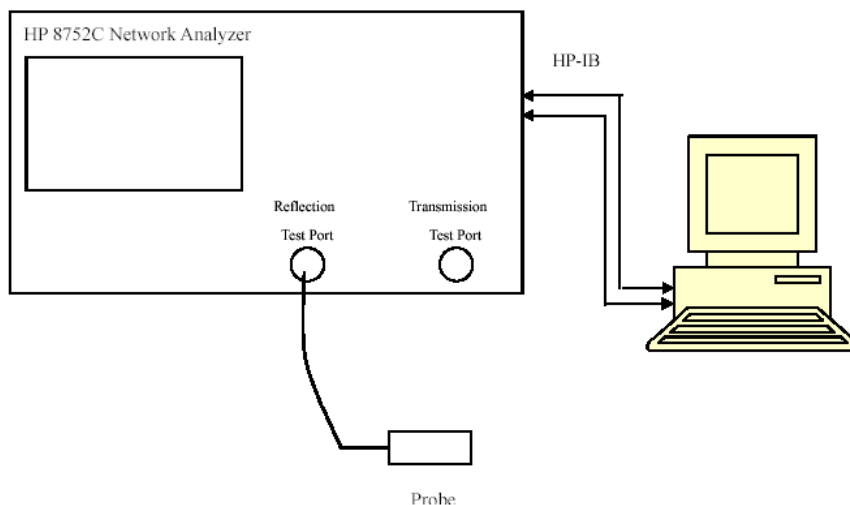

Liquid Verification Setup Block Diagram

## Liquid Verification Results

| Frequency (MHz) | Liquid Type                    | Liquid Parameter |                | Target Value |                | Delta (%)          |                      | Tolerance (%) |
|-----------------|--------------------------------|------------------|----------------|--------------|----------------|--------------------|----------------------|---------------|
|                 |                                | $\epsilon_r$     | $\sigma$ (S/m) | $\epsilon_r$ | $\sigma$ (S/m) | $\Delta\epsilon_r$ | $\Delta\sigma$ (S/m) |               |
| 2412            | Simulated Tissue 2450 MHz Body | 53.259           | 1.94           | 52.7         | 1.95           | 1.06               | -0.51                | ±5            |
| 2437            | Simulated Tissue 2450 MHz Body | 51.603           | 1.979          | 52.7         | 1.95           | -2.08              | 1.49                 | ±5            |
| 2450            | Simulated Tissue 2450 MHz Body | 52.24            | 2.031          | 52.7         | 1.95           | -0.87              | 4.15                 | ±5            |
| 2462            | Simulated Tissue 2450 MHz Body | 52.189           | 1.981          | 52.7         | 1.95           | -0.97              | 1.59                 | ±5            |

\*Liquid Verification above was performed on 2016-07-08.

### System Accuracy Verification

Prior to the assessment, the system validation kit was used to test whether the system was operating within its specifications of  $\pm 10\%$ . The validation results are tabulated below. And also the corresponding SAR plot is attached as well in the SAR plots files.

### System Verification Setup Block Diagram

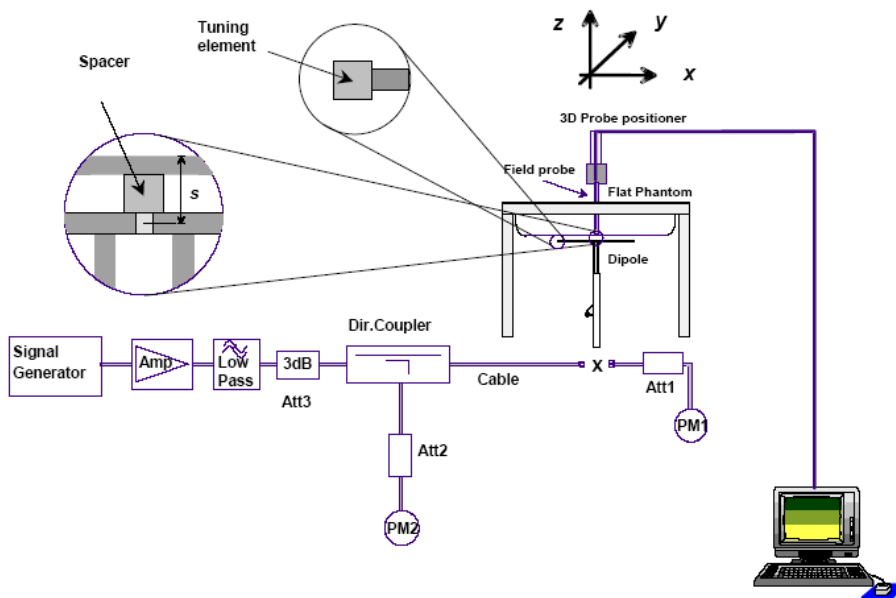

### System Accuracy Check Results

| Date       | Frequency Band | Liquid Type | Measured SAR (W/Kg) |      | Target Value (W/Kg) | Delta (%) | Tolerance (%) |
|------------|----------------|-------------|---------------------|------|---------------------|-----------|---------------|
| 2016-07-08 | 2450           | Body        | 1g                  | 53.3 | 50.6                | 5.34      | $\pm 10$      |

\*All SAR values are normalized to 1 Watt forward power.

**Test Laboratory: Bay Area Compliance Labs Corp.(Dongguan)**

**System Performance 2450 MHz Body Test**

**DUT:D2450V3; Type: 2450 MHz; Serial: 971**

Communication System: CW; Frequency: 2450 MHz;Duty Cycle: 1:1  
 Medium parameters used:  $f = 2450 \text{ MHz}$ ;  $\sigma = 2.031 \text{ S/m}$ ;  $\epsilon_r = 52.24$ ;  $\rho = 1000 \text{ kg/m}^3$   
 Phantom section: Flat Section

**DASY5 Configuration:**

- Probe: EX3DV4 - SN7329; ConvF(7.26, 7.26, 7.26); Calibrated: 2016/2/19;
- Sensor-Surface: 4mm (Mechanical Surface Detection)
- Electronics: DAE4 Sn1459; Calibrated: 2015/9/18
- Phantom: SAM (30deg probe tilt) with CRP v5.0\_20150321; Type: QD000P40CD; Serial: TP:1874
- Measurement SW: DASY52, Version 52.8 (8);

**System Performance 2450 MHz Body /Area Scan (61x81x1):** Interpolated grid:  $dx=1.000 \text{ mm}$ ,  $dy=1.000 \text{ mm}$   
 Maximum value of SAR (interpolated) = 64.3 W/kg

**System Performance 2450 MHz Body /Zoom Scan (7x7x7)/Cube 0:** Measurement grid:  $dx=5\text{mm}$ ,  $dy=5\text{mm}$ ,  $dz=5\text{mm}$

Reference Value = 182.1 V/m; Power Drift = -0.04 dB

Peak SAR (extrapolated) = 110 W/kg

**SAR(1 g) = 53.3 W/kg; SAR(10 g) = 24.7W/kg**

Maximum value of SAR (measured) = 60.4 W/kg

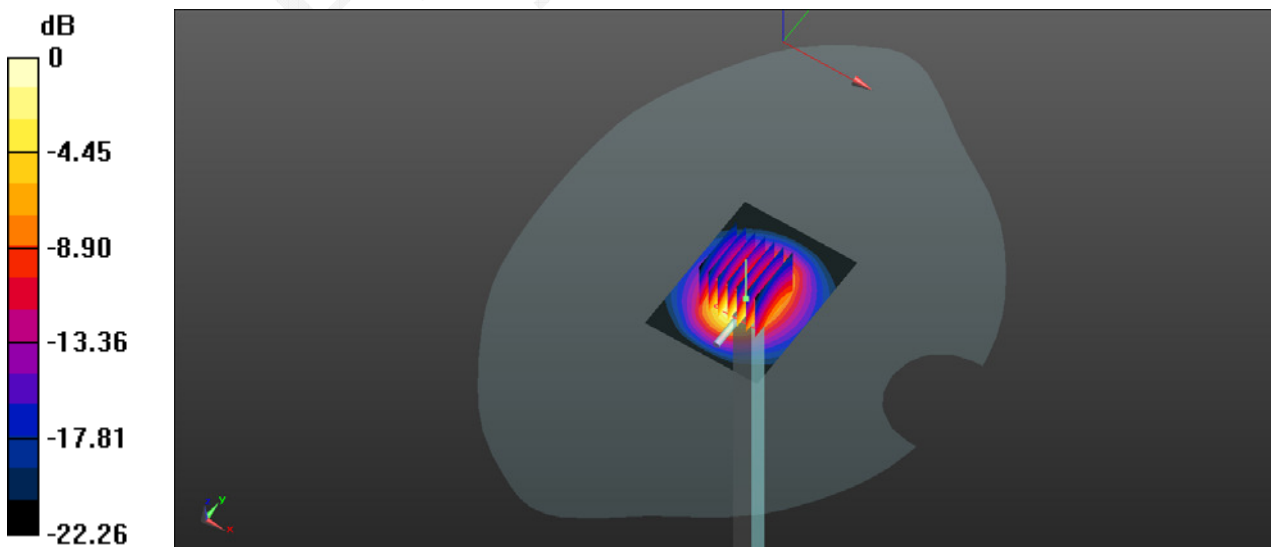

0 dB = 60.4 W/kg = 17.81 dBW/kg

## EUT TEST STRATEGY AND METHODOLOGY

### Test Positions for Device Operating Next to a Person’s Ear

This category includes most wireless handsets with fixed, retractable or internal antennas located toward the top half of the device, with or without a foldout, sliding or similar keypad cover. The handset should have its earpiece located within the upper ¼ of the device, either along the centerline or off-centered, as perceived by its users. This type of handset should be positioned in a normal operating position with the “test device reference point” located along the “vertical centerline” on the Back(LCD) of the device aligned to the “ear reference point”. The “test device reference point” should be located at the same level as the center of the earpiece region. The “vertical centerline” should bisect the Back(LCD) surface of the handset at its top and bottom edges. A “ear reference point” is located on the outer surface of the head phantom on each ear spacer. It is located 1.5 cm above the center of the ear canal entrance in the “phantom reference plane” defined by the three lines joining the center of each “ear reference point” (left and right) and the tip of the mouth.

A handset should be initially positioned with the earpiece region pressed against the ear spacer of a head phantom. For the SCC-34/SC-2 head phantom, the device should be positioned parallel to the “N-F” line defined along the base of the ear spacer that contains the “ear reference point”. For interim head phantoms, the device should be positioned parallel to the cheek for maximum RF energy coupling. The “test device reference point” is aligned to the “ear reference point” on the head phantom and the “vertical centerline” is aligned to the “phantom reference plane”. This is called the “initial ear position”. While maintaining these three alignments, the body of the handset is gradually adjusted to each of the following positions for evaluating SAR:

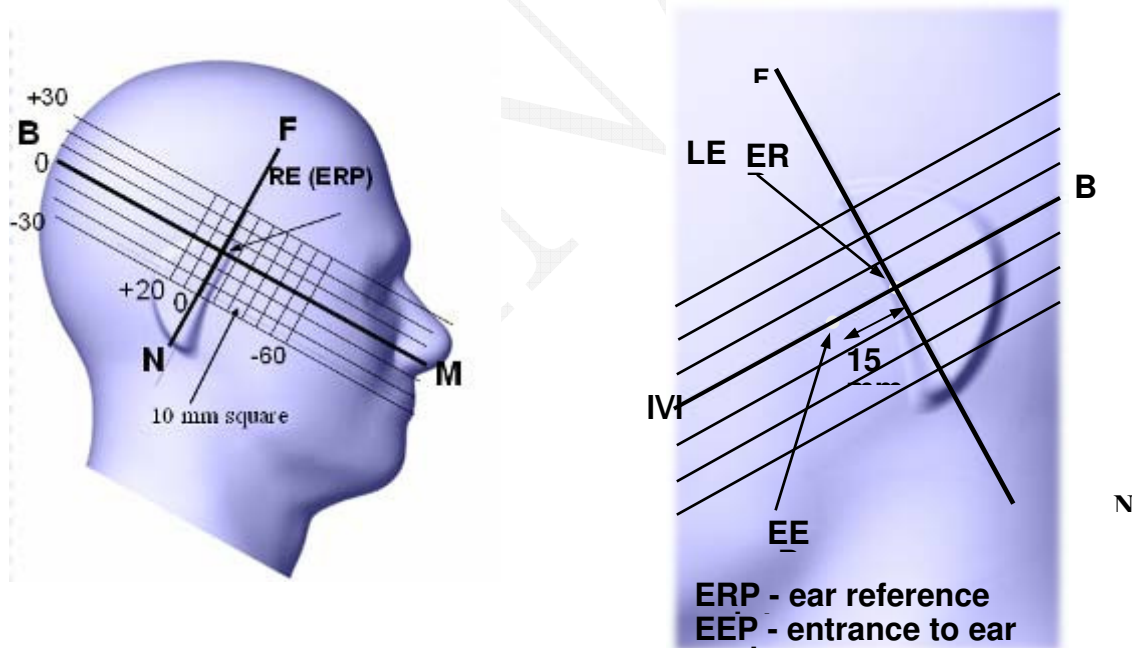

## Cheek/Touch Position

The device is brought toward the mouth of the head phantom by pivoting against the “ear reference point” or along the “N-F” line for the SCC-34/SC-2 head phantom.

This test position is established:

When any point on the display, keypad or mouthpiece portions of the handset is in contact with the phantom.

(or) When any portion of a foldout, sliding or similar keypad cover opened to its intended self-adjusting normal use position is in contact with the cheek or mouth of the phantom.

For existing head phantoms – when the handset loses contact with the phantom at the pivoting point, rotation should continue until the device touches the cheek of the phantom or breaks its last contact from the ear spacer.

### Cheek /Touch Position

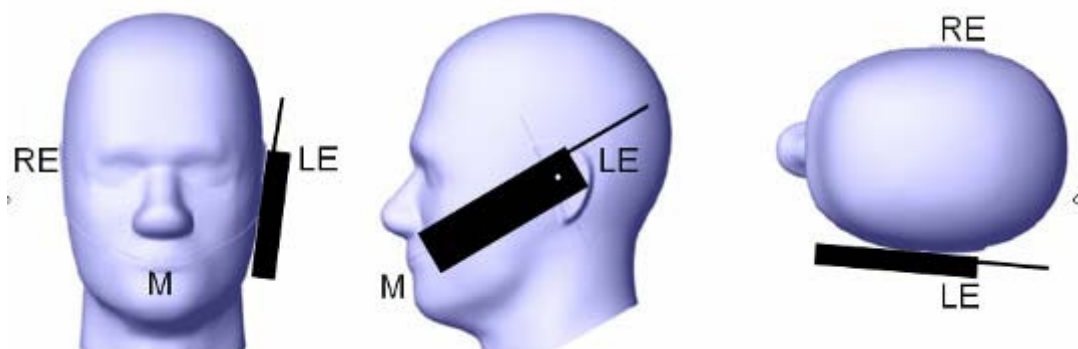

## Ear/Tilt Position

With the handset aligned in the “Cheek/Touch Position”:

1) If the earpiece of the handset is not in full contact with the phantom’s ear spacer (in the “Cheek/Touch position”) and the peak SAR location for the “Cheek/Touch” position is located at the ear spacer region or corresponds to the earpiece region of the handset, the device should be returned to the “initial ear position” by rotating it away from the mouth until the earpiece is in full contact with the ear spacer.

2) (otherwise) The handset should be moved (translated) away from the cheek perpendicular to the line passes through both “ear reference points” (note: one of these ear reference points may not physically exist on a split head model) for approximate 2-3 cm. While it is in this position, the device handset is tilted away from the mouth with respect to the “test device reference point” until the inside angle between the vertical centerline on the Back(LCD) surface of the phone and the horizontal line passing through the ear reference point is by 15 80°. After the tilt, it is then moved (translated) back toward the head perpendicular to the line passes through both “ear reference points” until the device touches the phantom or the ear spacer. If the antenna touches the head first, the positioning process should be repeated with a tilt angle less than 15° so that the device and its antenna would touch the phantom simultaneously. This test position may require a device holder or positioner to achieve the translation and tilting with acceptable positioning repeatability.

If a device is also designed to transmit with its keypad cover closed for operating in the head position, such positions should also be considered in the SAR evaluation. The device should be tested on the left and right side of the head phantom in the “Cheek/Touch” and “Ear/Tilt” positions. When applicable, each configuration should be tested with the antenna in its fully extended and fully retracted positions. These test configurations should be tested at the high, middle and low frequency channels of each operating mode; for example, AMPS, CDMA, and TDMA. If the SAR measured at the middle channel for each test configuration (left, right, Cheek/Touch, Tilt/Ear, extended and retracted) is at least 2.0 dB lower than the SAR limit, testing at the high and low channels is optional for such test configuration(s). If the transmission band of the test device is less than 10 MHz, testing at the high and low frequency channels is optional.

**Ear /Tilt 15° Position**

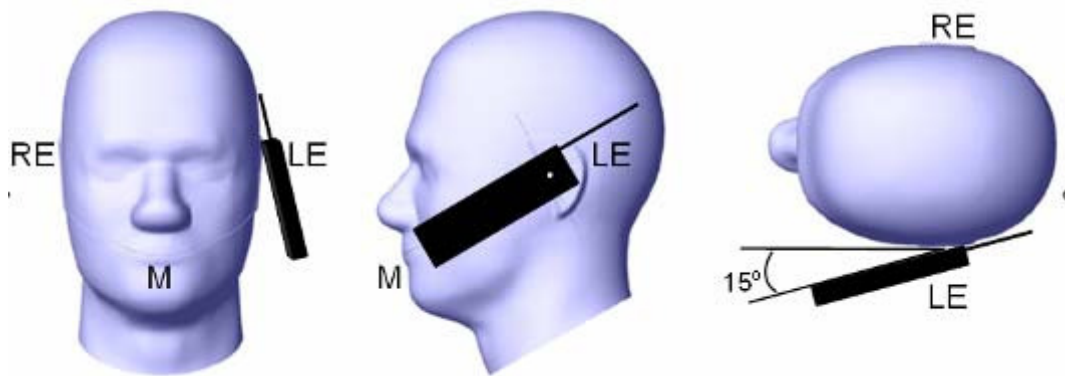

**Test positions for body-worn and other configurations**

Body-worn operating configurations should be tested with the belt-clips and holsters attached to the device and positioned against a flat phantom in normal use configurations. Devices with a headset output should be tested with a headset connected to the device. When multiple accessories that do not contain metallic components are supplied with the device, the device may be tested with only the accessory that dictates the closest spacing to the body. When multiple accessories that contain metallic components are supplied with the device, the device must be tested with each accessory that contains a unique metallic component. If multiple accessories share an identical metallic component (e.g., the same metallic belt-clip used with different holsters with no other metallic components), only the accessory that dictates the closest spacing to the body must be tested.

Body-worn accessories may not always be supplied or available as options for some devices that are intended to be authorized for body-worn use. A separation distance of 1.5 cm between the back of the device and a flat phantom is recommended for testing body-worn SAR compliance under such circumstances. Other separation distances may be used, but they should not exceed 2.5 cm. In these cases, the device may use body-worn accessories that provide a separation distance greater than that tested for the device provided however that the accessory contains no metallic components.

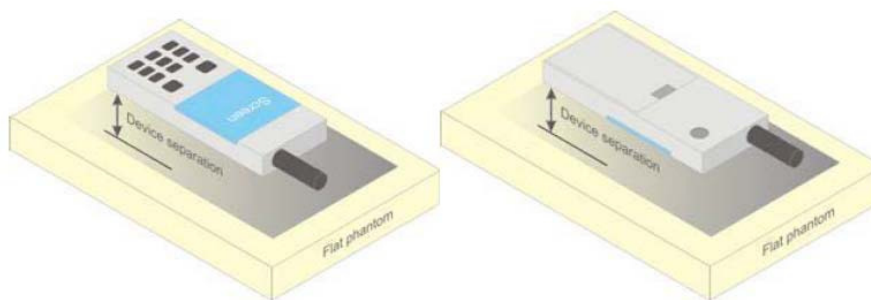

**Figure 5 – Test positions for body-worn devices**

## SAR Evaluation Procedure

The evaluation was performed with the following procedure:

Step 1: Measurement of the SAR value at a fixed location above the ear point or central position was used as a reference value for assessing the power drop. The SAR at this point is measured at the start of the test and then again at the end of the testing.

Step 2: The SAR distribution at the exposed side of the head was measured at a distance of 4 mm from the inner surface of the shell. The area covered the entire dimension of the head or radiating structures of the EUT, the horizontal grid spacing was 10 mm x 10 mm, and the SAR distribution was determined by integrated grid of 1.0 mm x 1.0 mm. Based on these data, the area of the maximum absorption was determined by spline interpolation. The first Area Scan covers the entire dimension of the EUT to ensure that the hotspot was correctly identified.

Step 3: Around this point, a volume of 30 mm x 30 mm x 30 mm was assessed by measuring 7x 7 x 7 points. On the basis of this data set, the spatial peak SAR value was evaluated under the following procedure:

1) The data at the surface were extrapolated, since the center of the dipoles is 1.2 mm away from the tip of the probe and the distance between the surface and the lowest measuring point is 1.3 mm. The extrapolation was based on a least square algorithm. A polynomial of the fourth order was calculated through the points in z-axes. This polynomial was then used to evaluate the points between the surface and the probe tip.

2) The maximum interpolated value was searched with a straightforward algorithm. Around this maximum the SAR values averaged over the spatial volumes (1 g or 10 g) were computed by the 3D-Spline interpolation algorithm. The 3D-Spline is composed of three one dimensional splines with the "Not a knot"-condition (in x, y and z-directions). The volume was integrated with the trapezoidal-algorithm. One thousand points (10 x 10 x 10) were interpolated to calculate the averages.

All neighboring volumes were evaluated until no neighboring volume with a higher average value was found.

Step 4: Re-measurement of the SAR value at the same location as in Step 1. If the value changed by more than 5%, the evaluation was repeated.

## Test methodology

KDB 447498 D01 General RF Exposure Guidance v06.  
KDB 865664 D01 SAR Measurement 100 MHz to 6 GHz v01r04  
KDB 865664 D02 RF Exposure Reporting v01r02  
KDB 248227 D01 802 11 Wi-Fi SAR v02r02

## CONDUCTED OUTPUT POWER MEASUREMENT

### Provision Applicable

The measured peak output power should be greater and within 5% than EMI measurement.

### Maximum Target Output Power

| Max Target Power(dBm) |         |        |      |
|-----------------------|---------|--------|------|
| Mode/Band             | Channel |        |      |
|                       | Low     | Middle | High |
| WLAN(802.11b)         | 15      | 15     | 15   |
| WLAN(802.11g)         | 13.4    | 13.4   | 13.4 |
| WLAN(802.11n HT20)    | 12.9    | 12.9   | 12.9 |
| WLAN(802.11n HT40)    | 12.3    | 12.3   | 12.3 |
| Bluetooth BDR/EDR     | 2.9     | 2.9    | 2.9  |
| BLE                   | 4.7     | 4.7    | 4.7  |

**Test Results:**

**Bluetooth**

| Mode         | Channel frequency (MHz) | RF Output Power (dBm) |
|--------------|-------------------------|-----------------------|
| BDR(GFSK)    | 2402                    | 1.05                  |
|              | 2441                    | 1.17                  |
|              | 2480                    | 0.8                   |
| EDR(4-DQPSK) | 2402                    | 2.45                  |
|              | 2441                    | 2.54                  |
|              | 2480                    | 2.24                  |
| EDR(8-DPSK)  | 2402                    | 2.6                   |
|              | 2441                    | <b>2.79</b>           |
|              | 2480                    | 2.42                  |
| BLE          | 2402                    | 4.5                   |
|              | 2441                    | <b>4.56</b>           |
|              | 2480                    | 4.01                  |

**WLAN**

| Mode         | Channel frequency (MHz) | RF Output Power (dBm) |
|--------------|-------------------------|-----------------------|
| 802.11b      | 2412                    | <b>14.88</b>          |
|              | 2437                    | 14.54                 |
|              | 2462                    | 14.60                 |
| 802.11g      | 2412                    | 13.32                 |
|              | 2437                    | 12.92                 |
|              | 2462                    | 13.12                 |
| 802.11n HT20 | 2412                    | 12.62                 |
|              | 2437                    | 12.41                 |
|              | 2462                    | 12.82                 |
| 802.11n HT40 | 2422                    | 12.24                 |
|              | 2437                    | 11.99                 |
|              | 2452                    | 11.83                 |

**Note:**

1. The output power was tested under data rate 1Mbps for 802.11b, 6Mbps for 802.11g, MCS0 for 802.11n HT20 and 802.11n HT40.
2. The WLAN and BT cannot transmit simultaneously.

## STANDALONE SAR DESCRIPTION

### Standalone SAR test exclusion considerations

| Mode      | Frequency (MHz) | Pavg (dBm) | Pavg (mW) | Distance (mm) | Calculated value | Threshold (1-g) | SAR Test Exclusion |
|-----------|-----------------|------------|-----------|---------------|------------------|-----------------|--------------------|
| WLAN      | 2462            | 15         | 31.62     | 0             | 9.9              | 3               | NO                 |
| Bluetooth | 2480            | 4.7        | 2.95      | 0             | 0.9              | 3               | YES                |

**NOTE:**

The 1-g and 10-g SAR test exclusion thresholds for 100 MHz to 6 GHz at test separation distances  $\leq 50$  mm are determined by:

$$[(\text{max. power of channel, including tune-up tolerance, mW}) / (\text{min. test separation distance, mm})] \cdot [\sqrt{f(\text{GHz})}] \leq 3.0 \text{ for 1-g SAR and } \leq 7.5 \text{ for 10-g extremity SAR, where}$$

1. f(GHz) is the RF channel transmit frequency in GHz.
2. Power and distance are rounded to the nearest mW and mm before calculation.
3. The result is rounded to one decimal place for comparison.
4. When the minimum test separation distance is  $< 5$  mm, a distance of 5 mm is applied to determine SAR test Exclusion.

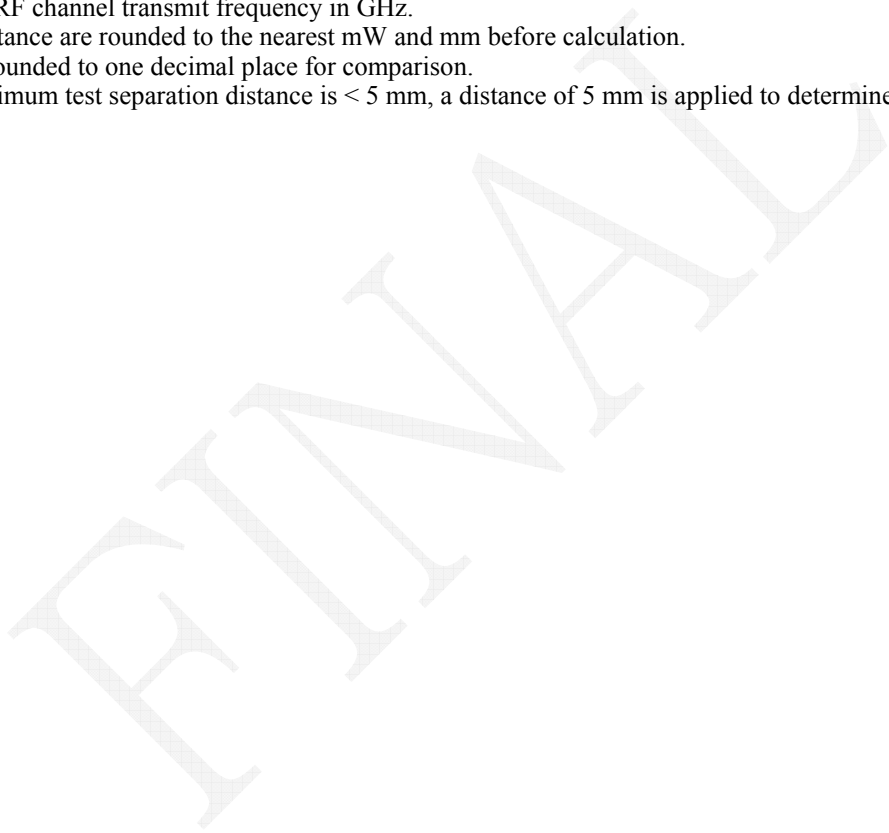

## SAR MEASUREMENT RESULTS

### Antenna Location

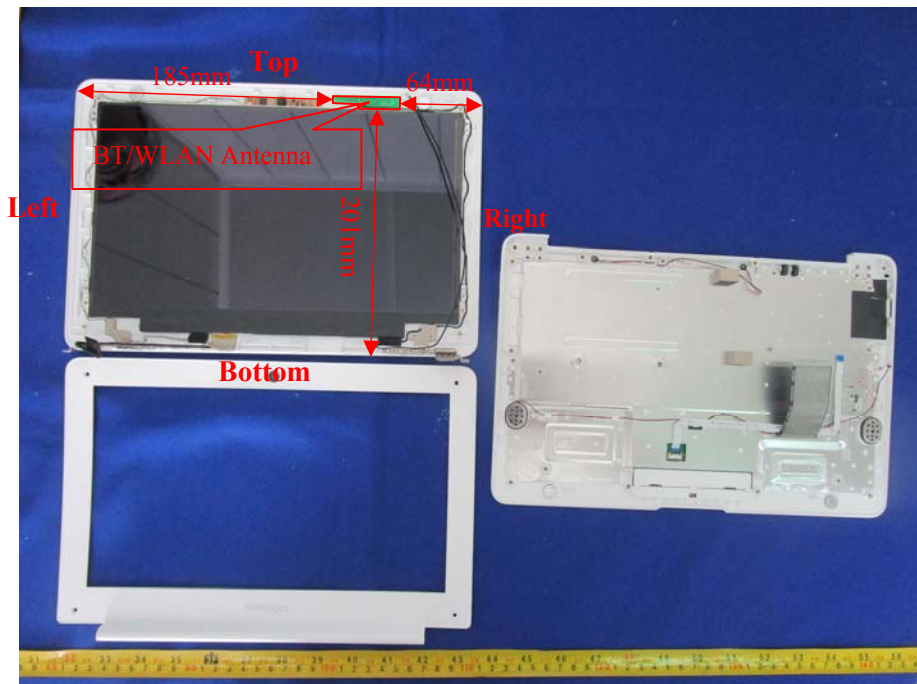

### Antenna Distance To Edge

| Antenna Distance To Edge(mm) |      |       |     |           |        |
|------------------------------|------|-------|-----|-----------|--------|
| Antenna                      | Left | Right | Top | Back(LCD) | Bottom |
| WLAN                         | 185  | 64    | 5.1 | 2.6       | 201    |

### SAR test exclusion for the EUT edge considerations Result

| Mode | Left  | Right | Top   | Back(LCD) | Bottom    |
|------|-------|-------|-------|-----------|-----------|
| WLAN | Judge | Judge | Judge | Required  | Exclusion |

**Note:**

**Required:** The distance is less than 5mm, the SAR test is required as Standalone SAR test exclusion considerations table.

**Exclusion:** The distance is more than 20cm to the edge, SAR test is not application.

**Judge:** Please refer the below table for detail.

**SAR test exclusion for the EUT edge considerations detail:**

**Distance < 50mm**

| Mode | Edge | Frequency (MHz) | Pavg (dBm) | Pavg (mW) | Distance (mm) | Calculated value | Threshold (1-g) | SAR Test required |
|------|------|-----------------|------------|-----------|---------------|------------------|-----------------|-------------------|
| WLAN | Top  | 2462            | 15         | 31.62     | 5.1           | 10.0             | 3               | YES               |

The 1-g and 10-g SAR test exclusion thresholds for 100 MHz to 6 GHz at test separation distances ≤ 50 mm are determined by:

$$[(\text{max. power of channel, including tune-up tolerance, mW}) / (\text{min. test separation distance, mm})] \cdot [\sqrt{f(\text{GHz})}] \leq 3.0 \text{ for 1-g SAR and } \leq 7.5 \text{ for 10-g extremity SAR, where}$$

1. f(GHz) is the RF channel transmit frequency in GHz.
2. Power and distance are rounded to the nearest mW and mm before calculation.
3. The result is rounded to one decimal place for comparison.
4. When the minimum test separation distance is < 5 mm, a distance of 5 mm is applied to determine SAR test Exclusion.

**Distance > 50mm**

| Mode | Edge  | Frequency (MHz) | Pavg (dBm) | Pavg (mW) | Distance (mm) | Test exclusion Threshold (mW) | SAR Test required |
|------|-------|-----------------|------------|-----------|---------------|-------------------------------|-------------------|
| WLAN | Left  | 2462            | 15         | 31.62     | 185           | 1446                          | No                |
|      | Right | 2462            | 15         | 31.62     | 64            | 236                           | No                |

At 100 MHz to 6 GHz and for *test separation distances* > 50 mm, the SAR test exclusion threshold is determined according to the following:

- a) [Power allowed at numeric threshold for 50 mm in step 1) + (test separation distance - 50 mm) · ( f(MHz)/150)] mW, at 100 MHz to 1500 MHz
- b) [Power allowed at numeric threshold for 50 mm in step 1) + (test separation distance - 50 mm) · 10] mW at > 1500 MHz and ≤ 6 GHz

**SAR Test Data****Environmental Conditions**

|                           |            |
|---------------------------|------------|
| <b>Temperature:</b>       | 22-23.8°C  |
| <b>Relative Humidity:</b> | 27%        |
| <b>ATM Pressure:</b>      | 997 mbar   |
| <b>Test Date:</b>         | 2016-07-08 |

Testing was performed by Rocky Xiao

**WLAN:**

| EUT Position             | Frequency (MHz) | Test Mode | Power Drift (dB) | Max. Meas. Power (dBm) | Max. Rated Power (dBm) | 1g SAR (W/Kg) |           |            |      |
|--------------------------|-----------------|-----------|------------------|------------------------|------------------------|---------------|-----------|------------|------|
|                          |                 |           |                  |                        |                        | Scaled Factor | Meas. SAR | Scaled SAR | Plot |
| Body-Back(LCD)<br>(0 mm) | 2412            | 802.11b   | -0.02            | 14.88                  | 15                     | 1.028         | 1.42      | 1.46       | #1   |
|                          | 2437            | 802.11b   | 0.15             | 14.54                  | 15                     | 1.112         | 1.27      | 1.412      | /    |
|                          | 2462            | 802.11b   | 0.09             | 14.6                   | 15                     | 1.096         | 1.285     | 1.408      | /    |
| Body-Top<br>(0 mm)       | 2412            | 802.11b   | -0.08            | 14.88                  | 15                     | 1.028         | 0.855     | 0.879      | #2   |
|                          | 2437            | 802.11b   | 0.1              | 14.54                  | 15                     | 1.112         | 0.758     | 0.843      | /    |
|                          | 2462            | 802.11b   | 0.06             | 14.6                   | 15                     | 1.096         | 0.766     | 0.84       | /    |

**2.4 GHz 802.11g/n OFDM SAR Test Exclusion Requirements**

| Modulation Mode    | Pavg (dBm) | Pavg (mW) | Measured SAR(W/kg) | Adjusted SAR(W/kg) | Limit(W/kg) | SAR Test Exclusion |
|--------------------|------------|-----------|--------------------|--------------------|-------------|--------------------|
| 802.11b(DSSS)      | 15         | 31.62     | 1.46               | /                  | /           | /                  |
| 802.11g(OFDM)      | 13.4       | 21.88     | /                  | 1.01               | 1.2         | Yes                |
| 802.11n HT20(OFDM) | 12.9       | 19.5      | /                  | 0.9                | 1.2         | Yes                |
| 802.11n HT40(OFDM) | 12.3       | 16.98     | /                  | 0.784              | 1.2         | Yes                |

**Note:**

1. When the 1-g SAR is  $\leq 0.8$ W/Kg, testing for other channels are optional.
2. When SAR is not measured at the maximum power level allowed for production units, the results must be scaled to the maximum tune-up tolerance limit according to the power applied to the individual channels tested to determine compliance.
3. KDB 447498-The test separation distances required for a device to demonstrate SAR compliance must be sufficiently conservative to support the operational separation distances required by the device and its antennas and radiating structures. The test separation distance 0mm is considered sufficiently conservative.
4. KDB 248227 D01-SAR is not required for 2.4 GHz OFDM when the highest reported SAR for DSSS is adjusted by the ratio of OFDM to DSSS specified maximum output power and the adjusted SAR is  $\leq 1.2$  W/kg.

## SAR Measurement Variability

In accordance with published RF Exposure KDB procedure 865664 D01 SAR measurement 100 MHz to 6 GHz v01. These additional measurements are repeated after the completion of all measurements requiring the same head or body tissue-equivalent medium in a frequency band. The test device should be returned to ambient conditions (normal room temperature) with the battery fully charged before it is re-mounted on the device holder for the repeated measurement(s) to minimize any unexpected variations in the repeated results

- 1) Repeated measurement is not required when the original highest measured SAR is  $< 0.80$  W/kg; steps 2) through 4) do not apply.
- 2) When the original highest measured SAR is  $\geq 0.80$  W/kg, repeat that measurement once.
- 3) Perform a second repeated measurement only if the ratio of largest to smallest SAR for the original and first repeated measurements is  $> 1.20$  or when the original or repeated measurement is  $\geq 1.45$  W/kg (~ 10% from the 1-g SAR limit).
- 4) Perform a third repeated measurement only if the original, first or second repeated measurement is  $\geq 1.5$  W/kg and the ratio of largest to smallest SAR for the original, first and second repeated measurements is  $> 1.20$ .

### The Highest Measured SAR Configuration in Each Frequency Band

#### Body SAR

| Frequency Band | Freq.(MHz) | EUT Position   | Meas. SAR (W/kg) |          | Largest to Smallest SAR Ratio |
|----------------|------------|----------------|------------------|----------|-------------------------------|
|                |            |                | Original         | Repeated |                               |
| WLAN           | 2412       | Body-Back(LCD) | 1.46             | 1.35     | 1.08                          |
|                |            | Body-Top       | 0.879            | 0.863    | 1.02                          |

#### Note:

Second Repeated Measurement is not required since the ratio of the largest to smallest SAR for the original and first repeated measurement is not  $> 1.20$ .

## SAR Plots (Summary of the Highest SAR Values)

**Test Laboratory: Bay Area Compliance Labs Corp.(Dongguan)**

**Test Plot 1#: WLAN Mode B Back(LCD) Low Channel**

**DUT: Notebook; Type: MI1166R;**

Communication System: 802.11 b; Frequency: 2412 MHz; Duty Cycle: 1:1

Medium parameters used:  $f = 2412$  MHz;  $\sigma = 1.94$  S/m;  $\epsilon_r = 53.259$ ;  $\rho = 1000$  kg/m<sup>3</sup>

Phantom section: Flat Section

DASY5 Configuration:

- Probe: EX3DV4 - SN7329; ConvF(7.26, 7.26, 7.26); Calibrated: 2016/2/19;
- Sensor-Surface: 4mm (Mechanical Surface Detection)
- Electronics: DAE4 Sn1459; Calibrated: 2015/9/18
- Phantom: SAM (30deg probe tilt) with CRP v5.0\_20150321; Type: QD000P40CD; Serial: TP:1874
- Measurement SW: DASY52, Version 52.8 (8);

**Body /WLAN Mode B Back(LCD) /Area Scan (101x161x1):** Interpolated grid: dx=1.000 mm, dy=1.000 mm

Maximum value of SAR (interpolated) = 1.37 W/kg

**Body /WLAN Mode B Back(LCD) /Zoom Scan (7x7x7)/Cube 0:** Measurement grid: dx=5mm, dy=5mm, dz=5mm

Reference Value = 15.44 V/m; Power Drift = -0.02 dB

Peak SAR (extrapolated) = 3.92 W/kg

**SAR(1 g) = 1.42 W/kg; SAR(10 g) = 0.506 W/kg**

Maximum value of SAR (measured) = 1.73 W/kg

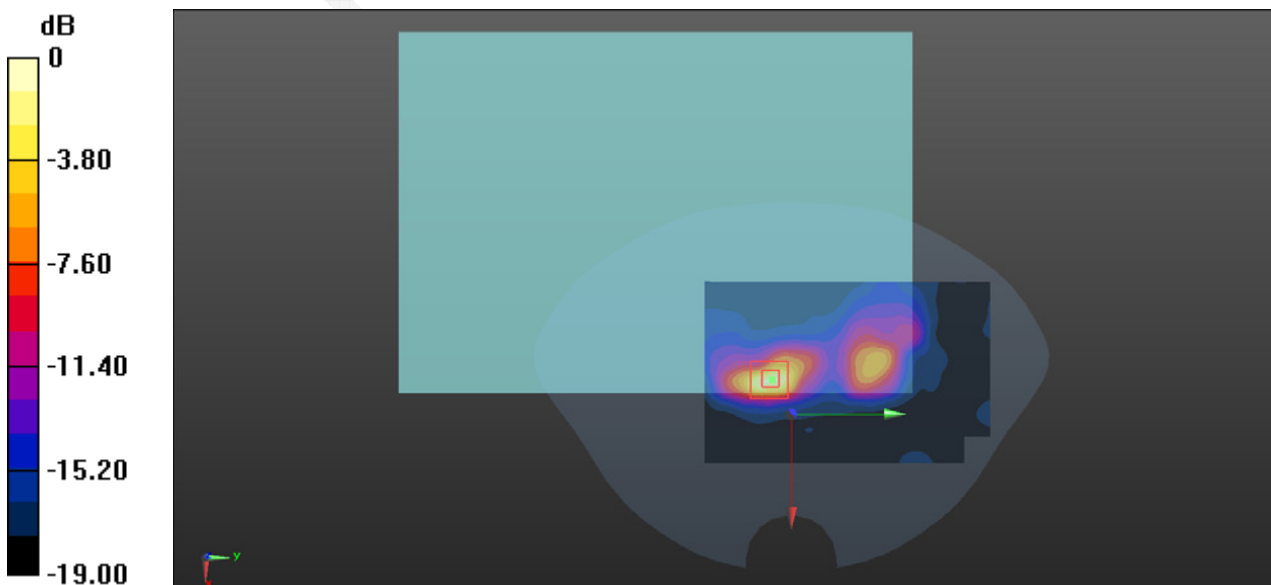

0 dB = 1.73 W/kg = 2.38 dBW/kg

**Test Laboratory: Bay Area Compliance Labs Corp.(Dongguan)**

**Test Plot 2#:WLAN Mode B Top Low Channel**

**DUT: Notebook; Type: MI1166R;**

Communication System: 802.11 b ; Frequency: 2412 MHz; Duty Cycle: 1:1  
 Medium parameters used:  $f = 2412 \text{ MHz}$ ;  $\sigma = 1.94 \text{ S/m}$ ;  $\epsilon_r = 53.259$ ;  $\rho = 1000 \text{ kg/m}^3$   
 Phantom section: Flat Section

DASY5 Configuration:

- Probe: EX3DV4 - SN7329; ConvF(7.26, 7.26, 7.26); Calibrated: 2016/2/19;
- Sensor-Surface: 4mm (Mechanical Surface Detection)
- Electronics: DAE4 Sn1459; Calibrated: 2015/9/18
- Phantom: SAM (30deg probe tilt) with CRP v5.0\_20150321; Type: QD000P40CD; Serial: TP:1874
- Measurement SW: DASY52, Version 52.8 (8);

**Body/WLAN Mode B Top/Area Scan (81x161x1):** Interpolated grid:  $dx=1.000 \text{ mm}$ ,  $dy=1.000 \text{ mm}$   
 Maximum value of SAR (interpolated) = 1.07 W/kg

**Body/WLAN Mode B Top/Zoom Scan (7x7x7)/Cube 0:** Measurement grid:  $dx=5\text{mm}$ ,  $dy=5\text{mm}$ ,  $dz=5\text{mm}$   
 Reference Value = 16.79 V/m; Power Drift = -0.08 dB  
 Peak SAR (extrapolated) = 1.78 W/kg  
**SAR(1 g) = 0.855 W/kg; SAR(10 g) = 0.377 W/kg**  
 Maximum value of SAR (measured) = 0.983 W/kg

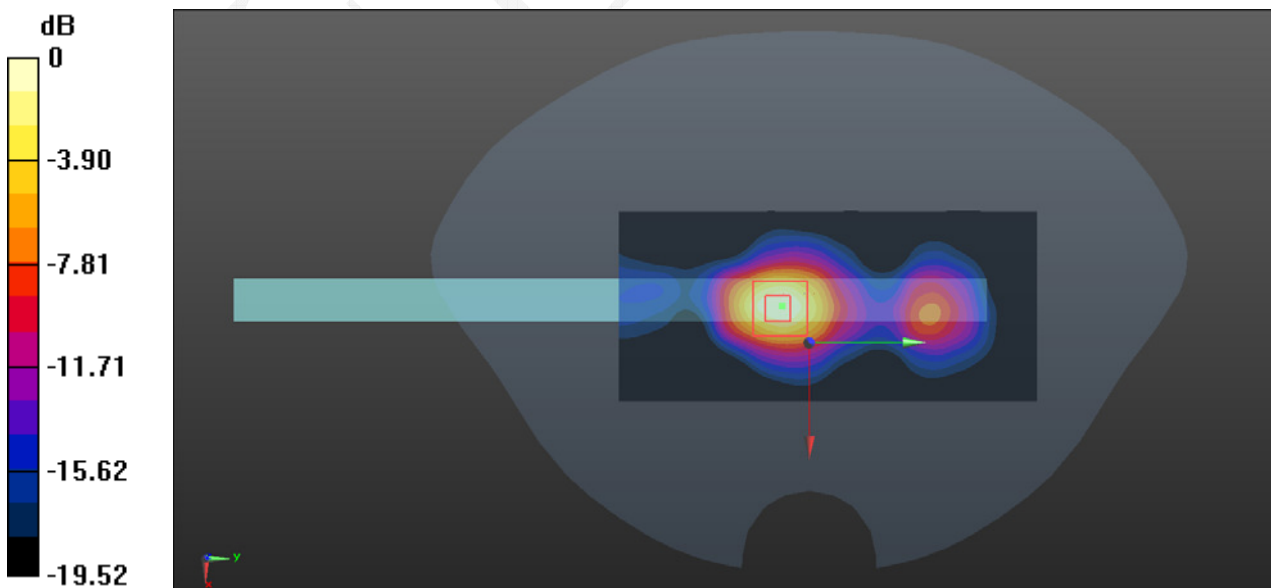

0 dB = 0.983 W/kg = -0.07 dBW/kg

## APPENDIX A MEASUREMENT UNCERTAINTY

The uncertainty budget has been determined for the measurement system and is given in the following Table.

**Measurement uncertainty evaluation for IEEE1528-2013 SAR test**

| Source of uncertainty                                | Tolerance/uncertainty ± % | Probability distribution | Divisor | ci (1 g) | ci (10 g) | Standard uncertainty ± %, (1 g) | Standard uncertainty ± %, (10 g) |
|--|---------------------------|--------------------------|---------|----------|-----------|---------------------------------|----------------------------------|
| <b>Measurement system</b>                            |                           |                          |         |          |           |                                 |                                  |
| Probe calibration                                    | 6.55                      | N                        | 1       | 1        | 1         | 6.6                             | 6.6                              |
| Axial Isotropy                                       | 4.7                       | R                        | √3      | 1        | 1         | 2.7                             | 2.7                              |
| Hemispherical Isotropy                               | 9.6                       | R                        | √3      | 0        | 0         | 0.0                             | 0.0                              |
| Boundary effect                                      | 1.0                       | R                        | √3      | 1        | 1         | 0.6                             | 0.6                              |
| Linearity  | 4.7                       | R                        | √3      | 1        | 1         | 2.7                             | 2.7                              |
| Detection limits                                     | 1.0                       | R                        | √3      | 1        | 1         | 0.6                             | 0.6                              |
| Readout electronics                                  | 0.3                       | N                        | 1       | 1        | 1         | 0.3                             | 0.3                              |
| Response time  | 0.0                       | R                        | √3      | 1        | 1         | 0.0                             | 0.0                              |
| Integration time                                     | 0.0                       | R                        | √3      | 1        | 1         | 0.0                             | 0.0                              |
| RF ambient conditions – noise                        | 1.0                       | R                        | √3      | 1        | 1         | 0.6                             | 0.6                              |
| RF ambient conditions–reflections                    | 1.0                       | R                        | √3      | 1        | 1         | 0.6                             | 0.6                              |
| Probe positioner mech. Restrictions                  | 0.8                       | R                        | √3      | 1        | 1         | 0.5                             | 0.5                              |
| Probe positioning with respect to phantom shell      | 6.7                       | R                        | √3      | 1        | 1         | 3.9                             | 3.9                              |
| Post-processing                                      | 2.0                       | R                        | √3      | 1        | 1         | 1.2                             | 1.2                              |
| <b>Test sample related</b>                           |                           |                          |         |          |           |                                 |                                  |
| Test sample positioning                              | 2.8                       | N                        | 1       | 1        | 1         | 2.8                             | 2.8                              |
| Device holder uncertainty                            | 6.3                       | N                        | 1       | 1        | 1         | 6.3                             | 6.3                              |
| Drift of output power                                | 5.0                       | R                        | √3      | 1        | 1         | 2.9                             | 2.9                              |
| <b>Phantom and set-up</b>                            |                           |                          |         |          |           |                                 |                                  |
| Phantom uncertainty (shape and thickness tolerances) | 4.0                       | R                        | √3      | 1        | 1         | 2.3                             | 2.3                              |
| Liquid conductivity target)                          | 5.0                       | R                        | √3      | 0.64     | 0.43      | 1.8                             | 1.2                              |
| Liquid conductivity meas.)                           | 2.5                       | N                        | 1       | 0.64     | 0.43      | 1.6                             | 1.1                              |
| Liquid permittivity target)                          | 5.0                       | R                        | √3      | 0.6      | 0.49      | 1.7                             | 1.4                              |
| Liquid permittivity meas.)                           | 2.5                       | N                        | 1       | 0.6      | 0.49      | 1.5                             | 1.2                              |
| Combined standard uncertainty                        |                           | RSS                      |         |          |           | 12.2                            | 12.0                             |
| Expanded uncertainty 95 % confidence interval)       |                           |                          |         |          |           | 24.3                            | 23.9                             |

**Measurement uncertainty evaluation for IEC62209-2 SAR test**

| Source of uncertainty  | Tolerance/uncertainty ± % | Probability distribution | Divisor | ci (1 g) | ci (10 g) | Standard uncertainty ± %, (1 g) | Standard uncertainty ± %, (10 g) |
|--|---------------------------|--------------------------|---------|----------|-----------|---------------------------------|----------------------------------|
| <b>Measurement system</b>  |                           |                          |         |          |           |                                 |                                  |
| Probe calibration  | 6.55                      | N                        | 1       | 1        | 1         | 6.6                             | 6.6                              |
| Axial Isotropy   | 4.7                       | R                        | √3      | 1        | 1         | 2.7                             | 2.7                              |
| Hemispherical Isotropy   | 9.6                       | R                        | √3      | 0        | 0         | 0.0                             | 0.0                              |
| Linearity  | 4.7                       | R                        | √3      | 1        | 1         | 2.7                             | 2.7                              |
| Modulation Response  | 0.0                       | R                        | √3      | 1        | 1         | 0.0                             | 0.0                              |
| Detection limits   | 1.0                       | R                        | √3      | 1        | 1         | 0.6                             | 0.6                              |
| Boundary effect  | 1.0                       | R                        | √3      | 1        | 1         | 0.6                             | 0.6                              |
| Readout electronics  | 0.3                       | N                        | 1       | 1        | 1         | 0.3                             | 0.3                              |
| Response time  | 0.0                       | R                        | √3      | 1        | 1         | 0.0                             | 0.0                              |
| Integration time   | 0.0                       | R                        | √3      | 1        | 1         | 0.0                             | 0.0                              |
| RF ambient conditions – noise  | 1.0                       | R                        | √3      | 1        | 1         | 0.6                             | 0.6                              |
| RF ambient conditions–reflections  | 1.0                       | R                        | √3      | 1        | 1         | 0.6                             | 0.6                              |
| Probe positioner mech. Restrictions  | 0.8                       | R                        | √3      | 1        | 1         | 0.5                             | 0.5                              |
| Probe positioning with respect to phantom shell                              | 6.7                       | R                        | √3      | 1        | 1         | 3.9                             | 3.9                              |
| Post-processing  | 2.0                       | R                        | √3      | 1        | 1         | 1.2                             | 1.2                              |
| <b>Test sample related</b>   |                           |                          |         |          |           |                                 |                                  |
| Device holder Uncertainty  | 6.3                       | N                        | 1       | 1        | 1         | 6.3                             | 6.3                              |
| Test sample positioning  | 2.8                       | N                        | 1       | 1        | 1         | 2.8                             | 2.8                              |
| Power scaling  | 4.5                       | R                        | √3      | 1        | 1         | 2.6                             | 2.6                              |
| Drift of output power  | 5.0                       | R                        | √3      | 1        | 1         | 2.9                             | 2.9                              |
| <b>Phantom and set-up</b>  |                           |                          |         |          |           |                                 |                                  |
| Phantom uncertainty (shape and thickness tolerances)                         | 4.0                       | R                        | √3      | 1        | 1         | 2.3                             | 2.3                              |
| Algorithm for correcting SAR for deviations in permittivity and conductivity | 1.9                       | N                        | 1       | 1        | 0.84      | 1.1                             | 0.9                              |
| Liquid conductivity (meas.)  | 2.5                       | N                        | 1       | 0.64     | 0.43      | 1.6                             | 1.1                              |
| Liquid permittivity (meas.)  | 2.5                       | N                        | 1       | 0.6      | 0.49      | 1.5                             | 1.2                              |
| Temp. unc. - Conductivity  | 1.7                       | R                        | √3      | 0.78     | 0.71      | 0.8                             | 0.7                              |
| Temp. unc. - Permittivity  | 0.3                       | R                        | √3      | 0.23     | 0.26      | 0.0                             | 0.0                              |
| Combined standard uncertainty  |                           | RSS                      |         |          |           | 12.2                            | 12.1                             |
| Expanded uncertainty 95 % confidence interval)                               |                           |                          |         |          |           | 24.5                            | 24.2                             |

# APPENDIX B – PROBE CALIBRATION CERTIFICATES

**Calibration Laboratory of  
Schmid & Partner  
Engineering AG**  
Zeughausstrasse 43, 8004 Zurich, Switzerland



**S** Schweizerischer Kalibrierdienst  
**C** Service suisse d'étalonnage  
**S** Servizio svizzero di taratura  
**S** Swiss Calibration Service

Accredited by the Swiss Accreditation Service (SAS)  
The Swiss Accreditation Service is one of the signatories to the EA  
Multilateral Agreement for the recognition of calibration certificates

Accreditation No.: **SCS 0108**

Client **BACL**

Certificate No: **EX3-7329\_Feb16**

## CALIBRATION CERTIFICATE

Object **EX3DV4 - SN:7329**

Calibration procedure(s) **QA CAL-01.v9, QA CAL-23.v5, QA CAL-25.v6  
Calibration procedure for dosimetric E-field probes**

Calibration date: **February 19, 2016**

This calibration certificate documents the traceability to national standards, which realize the physical units of measurements (SI).  
The measurements and the uncertainties with confidence probability are given on the following pages and are part of the certificate.

All calibrations have been conducted in the closed laboratory facility: environment temperature (22 ± 3)°C and humidity < 70%.

Calibration Equipment used (M&TE critical for calibration)

| Primary Standards          | ID              | Cal Date (Certificate No.)        | Scheduled Calibration  |
|----------------------------|-----------------|-----------------------------------|------------------------|
| Power meter E4419B         | GB41293874      | 01-Apr-15 (No. 217-02128)         | Mar-16                 |
| Power sensor E4412A        | MY41498087      | 01-Apr-15 (No. 217-02128)         | Mar-16                 |
| Reference 3 dB Attenuator  | SN: S5054 (3c)  | 01-Apr-15 (No. 217-02129)         | Mar-16                 |
| Reference 20 dB Attenuator | SN: S5277 (20x) | 01-Apr-15 (No. 217-02132)         | Mar-16                 |
| Reference 30 dB Attenuator | SN: S5129 (30b) | 01-Apr-15 (No. 217-02133)         | Mar-16                 |
| Reference Probe ES3DV2     | SN: 3013        | 31-Dec-15 (No. ES3-3013_Dec15)    | Dec-16                 |
| DAE4                       | SN: 660         | 23-Dec-15 (No. DAE4-660 Dec15)    | Dec-16                 |
| Secondary Standards        | ID              | Check Date (in house)             | Scheduled Check        |
| RF generator HP 8648C      | US3642U01700    | 4-Aug-99 (in house check Apr-13)  | In house check: Apr-16 |
| Network Analyzer HP 8753E  | US37390585      | 18-Oct-01 (in house check Oct-15) | In house check: Oct-16 |

|                | Name           | Function              | Signature |
|----------------|----------------|-----------------------|-----------|
| Calibrated by: | Jeton Kastrati | Laboratory Technician |           |
| Approved by:   | Katja Pokovic  | Technical Manager     |           |

Issued: February 20, 2016

This calibration certificate shall not be reproduced except in full without written approval of the laboratory.

**Calibration Laboratory of  
Schmid & Partner  
Engineering AG**  
Zeughausstrasse 43, 8004 Zurich, Switzerland



**S** Schweizerischer Kalibrierdienst  
**C** Service suisse d'étalonnage  
**S** Servizio svizzero di taratura  
Swiss Calibration Service

Accredited by the Swiss Accreditation Service (SAS)  
The Swiss Accreditation Service is one of the signatories to the EA  
Multilateral Agreement for the recognition of calibration certificates

Accreditation No.: **SCS 0108**

**Glossary:**

|                          |   |
|--------------------------|---|
| TSL                      | tissue simulating liquid  |
| NORM <sub>x,y,z</sub>    | sensitivity in free space   |
| ConvF                    | sensitivity in TSL / NORM <sub>x,y,z</sub>  |
| DCP                      | diode compression point   |
| CF                       | crest factor (1/duty_cycle) of the RF signal  |
| A, B, C, D               | modulation dependent linearization parameters   |
| Polarization $\phi$      | $\phi$ rotation around probe axis   |
| Polarization $\vartheta$ | $\vartheta$ rotation around an axis that is in the plane normal to probe axis (at measurement center),<br>i.e., $\vartheta = 0$ is normal to probe axis |
| Connector Angle          | information used in DASY system to align probe sensor X to the robot coordinate system  |

**Calibration is Performed According to the Following Standards:**

- a) IEEE Std 1528-2013, "IEEE Recommended Practice for Determining the Peak Spatial-Averaged Specific Absorption Rate (SAR) in the Human Head from Wireless Communications Devices: Measurement Techniques", June 2013
- b) IEC 62209-1, "Procedure to measure the Specific Absorption Rate (SAR) for hand-held devices used in close proximity to the ear (frequency range of 300 MHz to 3 GHz)", February 2005
- c) IEC 62209-2, "Procedure to determine the Specific Absorption Rate (SAR) for wireless communication devices used in close proximity to the human body (frequency range of 30 MHz to 6 GHz)", March 2010
- d) KDB 865664, "SAR Measurement Requirements for 100 MHz to 6 GHz"

**Methods Applied and Interpretation of Parameters:**

- **NORM<sub>x,y,z</sub>**: Assessed for E-field polarization  $\vartheta = 0$  ( $f \leq 900$  MHz in TEM-cell;  $f > 1800$  MHz: R22 waveguide). NORM<sub>x,y,z</sub> are only intermediate values, i.e., the uncertainties of NORM<sub>x,y,z</sub> does not affect the E<sup>2</sup>-field uncertainty inside TSL (see below ConvF).
- **NORM(f)<sub>x,y,z</sub>** = NORM<sub>x,y,z</sub> \* frequency\_response (see Frequency Response Chart). This linearization is implemented in DASY4 software versions later than 4.2. The uncertainty of the frequency response is included in the stated uncertainty of ConvF.
- **DCP<sub>x,y,z</sub>**: DCP are numerical linearization parameters assessed based on the data of power sweep with CW signal (no uncertainty required). DCP does not depend on frequency nor media.
- **PAR**: PAR is the Peak to Average Ratio that is not calibrated but determined based on the signal characteristics
- **A<sub>x,y,z</sub>; B<sub>x,y,z</sub>; C<sub>x,y,z</sub>; D<sub>x,y,z</sub>; VR<sub>x,y,z</sub>**: A, B, C, D are numerical linearization parameters assessed based on the data of power sweep for specific modulation signal. The parameters do not depend on frequency nor media. VR is the maximum calibration range expressed in RMS voltage across the diode.
- **ConvF and Boundary Effect Parameters**: Assessed in flat phantom using E-field (or Temperature Transfer Standard for  $f \leq 800$  MHz) and inside waveguide using analytical field distributions based on power measurements for  $f > 800$  MHz. The same setups are used for assessment of the parameters applied for boundary compensation (alpha, depth) of which typical uncertainty values are given. These parameters are used in DASY4 software to improve probe accuracy close to the boundary. The sensitivity in TSL corresponds to NORM<sub>x,y,z</sub> \* ConvF whereby the uncertainty corresponds to that given for ConvF. A frequency dependent ConvF is used in DASY version 4.4 and higher which allows extending the validity from  $\pm 50$  MHz to  $\pm 100$  MHz.
- **Spherical isotropy (3D deviation from isotropy)**: in a field of low gradients realized using a flat phantom exposed by a patch antenna.
- **Sensor Offset**: The sensor offset corresponds to the offset of virtual measurement center from the probe tip (on probe axis). No tolerance required.
- **Connector Angle**: The angle is assessed using the information gained by determining the NORM<sub>x</sub> (no uncertainty required).

EX3DV4 – SN:7329

February 19, 2016

# Probe EX3DV4

## SN:7329

Manufactured: December 11, 2014  
Calibrated: February 19, 2016

Calibrated for DASY/EASY Systems  
(Note: non-compatible with DASY2 system!)

EX3DV4- SN:7329

February 19, 2016

**DASY/EASY - Parameters of Probe: EX3DV4 - SN:7329**

**Basic Calibration Parameters**

|   | Sensor X | Sensor Y | Sensor Z | Unc (k=2) |
|---|----------|----------|----------|-----------|
| Norm ( $\mu\text{V}/(\text{V}/\text{m})^2$ ) <sup>A</sup> | 0.47     | 0.43     | 0.48     | ± 10.1 %  |
| DCP (mV) <sup>B</sup>                                     | 96.1     | 99.3     | 97.5     |           |

**Modulation Calibration Parameters**

| UID | Communication System Name |   | A<br>dB | B<br>dB $\sqrt{\mu\text{V}}$ | C   | D<br>dB | VR<br>mV | Unc <sup>E</sup><br>(k=2) |
|-----|---------------------------|---|---------|------------------------------|-----|---------|----------|---------------------------|
| 0   | CW                        | X | 0.0     | 0.0                          | 1.0 | 0.00    | 137.8    | ±3.3 %                    |
|     |                           | Y | 0.0     | 0.0                          | 1.0 |         | 145.3    |                           |
|     |                           | Z | 0.0     | 0.0                          | 1.0 |         | 155.8    |                           |

The reported uncertainty of measurement is stated as the standard uncertainty of measurement multiplied by the coverage factor k=2, which for a normal distribution corresponds to a coverage probability of approximately 95%.

<sup>A</sup> The uncertainties of Norm X,Y,Z do not affect the E<sup>2</sup>-field uncertainty inside TSL (see Pages 5 and 6).

<sup>B</sup> Numerical linearization parameter: uncertainty not required.

<sup>E</sup> Uncertainty is determined using the max. deviation from linear response applying rectangular distribution and is expressed for the square of the field value.

EX3DV4- SN:7329

February 19, 2016

**DASY/EASY - Parameters of Probe: EX3DV4 - SN:7329**

**Calibration Parameter Determined in Head Tissue Simulating Media**

| f (MHz) <sup>C</sup> | Relative Permittivity <sup>F</sup> | Conductivity (S/m) <sup>F</sup> | ConvF X | ConvF Y | ConvF Z | Alpha <sup>G</sup> | Depth (mm) <sup>G</sup> | Unc (k=2) |
|----------------------|------------------------------------|---------------------------------|---------|---------|---------|--------------------|-------------------------|-----------|
| 750                  | 41.9                               | 0.89                            | 9.90    | 9.90    | 9.90    | 0.57               | 0.80                    | ± 12.0 %  |
| 900                  | 41.5                               | 0.97                            | 9.37    | 9.37    | 9.37    | 0.40               | 0.89                    | ± 12.0 %  |
| 1750                 | 40.1                               | 1.37                            | 8.39    | 8.39    | 8.39    | 0.45               | 0.85                    | ± 12.0 %  |
| 1900                 | 40.0                               | 1.40                            | 7.94    | 7.94    | 7.94    | 0.46               | 0.86                    | ± 12.0 %  |
| 2450                 | 39.2                               | 1.80                            | 7.21    | 7.21    | 7.21    | 0.42               | 0.87                    | ± 12.0 %  |

<sup>C</sup> Frequency validity above 300 MHz of ± 100 MHz only applies for DASY v4.4 and higher (see Page 2), else it is restricted to ± 50 MHz. The uncertainty is the RSS of the ConvF uncertainty at calibration frequency and the uncertainty for the indicated frequency band. Frequency validity below 300 MHz is ± 10, 25, 40, 50 and 70 MHz for ConvF assessments at 30, 64, 128, 150 and 220 MHz respectively. Above 5 GHz frequency validity can be extended to ± 110 MHz.

<sup>F</sup> At frequencies below 3 GHz, the validity of tissue parameters ( $\epsilon$  and  $\sigma$ ) can be relaxed to ± 10% if liquid compensation formula is applied to measured SAR values. At frequencies above 3 GHz, the validity of tissue parameters ( $\epsilon$  and  $\sigma$ ) is restricted to ± 5%. The uncertainty is the RSS of the ConvF uncertainty for indicated target tissue parameters.

<sup>G</sup> Alpha/Depth are determined during calibration. SPEAG warrants that the remaining deviation due to the boundary effect after compensation is always less than ± 1% for frequencies below 3 GHz and below ± 2% for frequencies between 3-6 GHz at any distance larger than half the probe tip diameter from the boundary.

EX3DV4- SN:7329

February 19, 2016

### DASY/EASY - Parameters of Probe: EX3DV4 - SN:7329

#### Calibration Parameter Determined in Body Tissue Simulating Media

| f (MHz) <sup>C</sup> | Relative Permittivity <sup>F</sup> | Conductivity (S/m) <sup>F</sup> | ConvF X | ConvF Y | ConvF Z | Alpha <sup>G</sup> | Depth <sup>G</sup> (mm) | Unc (k=2) |
|----------------------|------------------------------------|---------------------------------|---------|---------|---------|--------------------|-------------------------|-----------|
| 750                  | 55.5                               | 0.96                            | 9.41    | 9.41    | 9.41    | 0.49               | 0.80                    | ± 12.0 %  |
| 900                  | 55.0                               | 1.05                            | 9.42    | 9.42    | 9.42    | 0.52               | 0.80                    | ± 12.0 %  |
| 1750                 | 53.4                               | 1.49                            | 7.86    | 7.86    | 7.86    | 0.39               | 0.86                    | ± 12.0 %  |
| 1900                 | 53.3                               | 1.52                            | 7.52    | 7.52    | 7.52    | 0.35               | 0.80                    | ± 12.0 %  |
| 2450                 | 52.7                               | 1.95                            | 7.26    | 7.26    | 7.26    | 0.37               | 0.86                    | ± 12.0 %  |

<sup>C</sup> Frequency validity above 300 MHz of ± 100 MHz only applies for DASY v4.4 and higher (see Page 2), else it is restricted to ± 50 MHz. The uncertainty is the RSS of the ConvF uncertainty at calibration frequency and the uncertainty for the indicated frequency band. Frequency validity below 300 MHz is ± 10, 25, 40, 50 and 70 MHz for ConvF assessments at 30, 64, 128, 150 and 220 MHz respectively. Above 5 GHz frequency validity can be extended to ± 110 MHz.

<sup>F</sup> At frequencies below 3 GHz, the validity of tissue parameters (c and σ) can be relaxed to ± 10% if liquid compensation formula is applied to measured SAR values. At frequencies above 3 GHz, the validity of tissue parameters (c and σ) is restricted to ± 5%. The uncertainty is the RSS of the ConvF uncertainty for indicated target tissue parameters.

<sup>G</sup> Alpha/Depth are determined during calibration. SPEAG warrants that the remaining deviation due to the boundary effect after compensation is always less than ± 1% for frequencies below 3 GHz and below ± 2% for frequencies between 3-6 GHz at any distance larger than half the probe tip diameter from the boundary.

EX3DV4-SN:7329

February 19, 2016

### Frequency Response of E-Field (TEM-Cell:ifi110 EXX, Waveguide: R22)

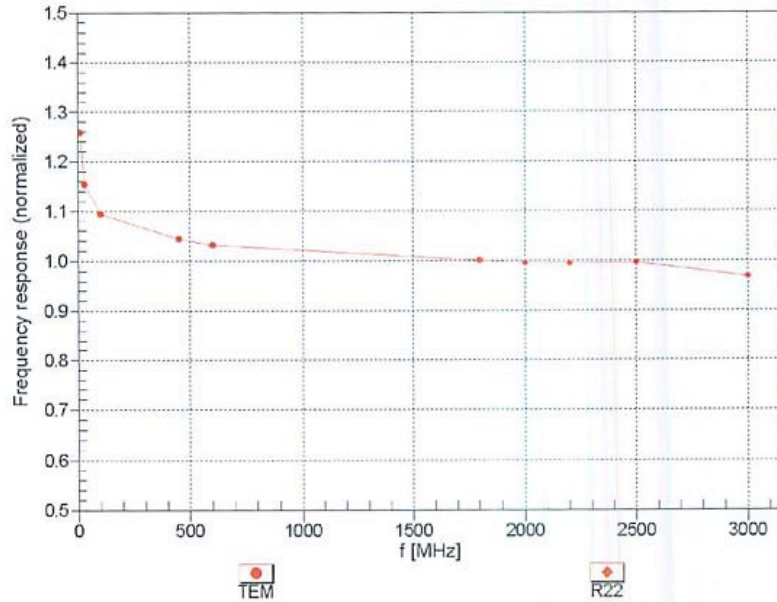

Uncertainty of Frequency Response of E-field:  $\pm 6.3\%$  (k=2)

EX3DV4- SN:7329

February 19, 2016

### Receiving Pattern ( $\phi$ ), $\theta = 0^\circ$

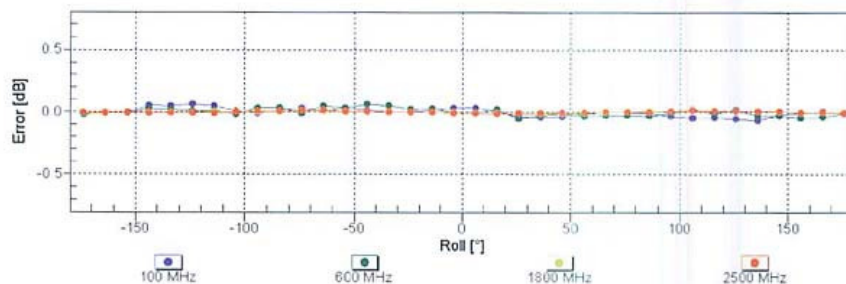
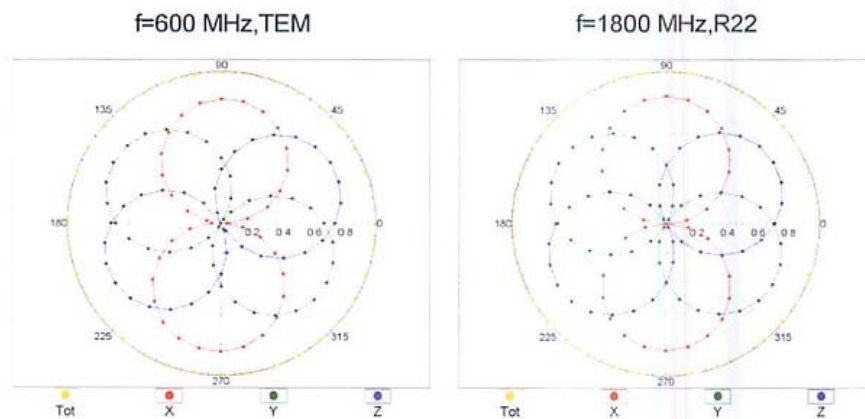

Uncertainty of Axial Isotropy Assessment:  $\pm 0.5\%$  (k=2)

EX3DV4- SN:7329

February 19, 2016

### Dynamic Range $f(SAR_{head})$ (TEM cell, $f_{eval}=1900$ MHz)

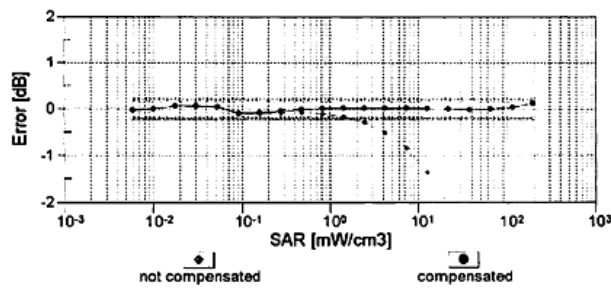
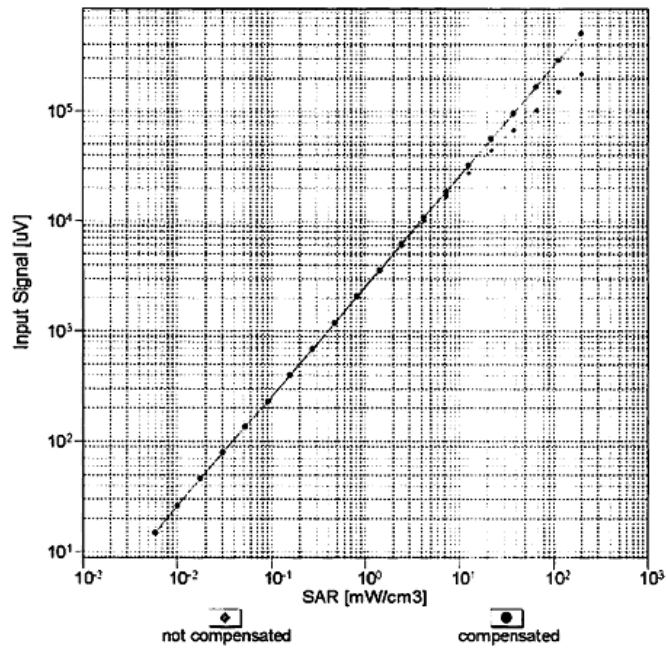

Uncertainty of Linearity Assessment:  $\pm 0.6\%$  ( $k=2$ )

EX3DV4-SN:7329

February 19, 2016

### Conversion Factor Assessment

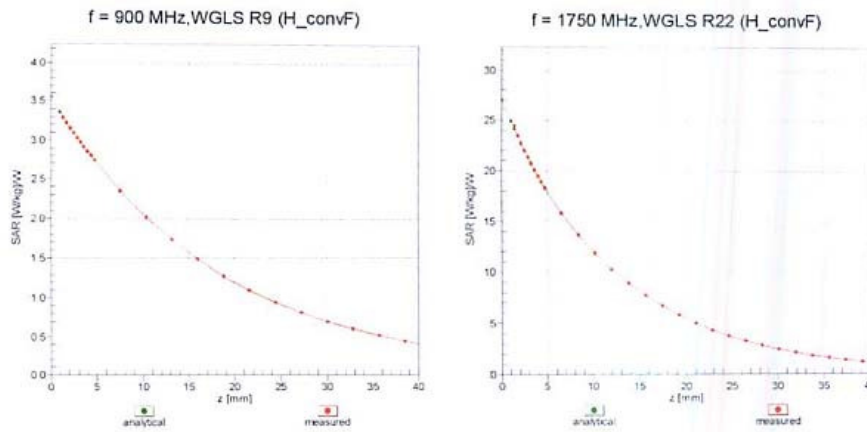

### Deviation from Isotropy in Liquid

Error ( $\phi, \theta$ ), f = 900 MHz

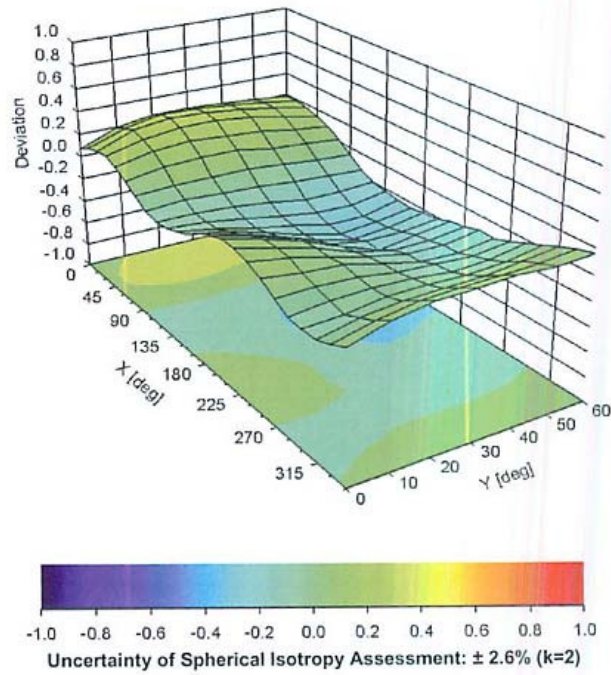

EX3DV4- SN:7329

February 19, 2016

**DASY/EASY - Parameters of Probe: EX3DV4 - SN:7329****Other Probe Parameters**

|   |            |
|---|------------|
| Sensor Arrangement                            | Triangular |
| Connector Angle (°)                           | 26         |
| Mechanical Surface Detection Mode             | enabled    |
| Optical Surface Detection Mode                | disabled   |
| Probe Overall Length                          | 337 mm     |
| Probe Body Diameter                           | 10 mm      |
| Tip Length                                    | 9 mm       |
| Tip Diameter                                  | 2.5 mm     |
| Probe Tip to Sensor X Calibration Point       | 1 mm       |
| Probe Tip to Sensor Y Calibration Point       | 1 mm       |
| Probe Tip to Sensor Z Calibration Point       | 1 mm       |
| Recommended Measurement Distance from Surface | 1.4 mm     |

# APPENDIX C DIPOLE CALIBRATION CERTIFICATES

**Calibration Laboratory of  
Schmid & Partner  
Engineering AG**  
Zeughausstrasse 43, 8004 Zurich, Switzerland



**S** Schweizerischer Kalibrierdienst  
**C** Service suisse d'étalonnage  
**S** Servizio svizzero di taratura  
**S** Swiss Calibration Service

Accredited by the Swiss Accreditation Service (SAS)  
The Swiss Accreditation Service is one of the signatories to the EA  
Multilateral Agreement for the recognition of calibration certificates

Accreditation No.: **SCS 0108**

Client **BACL**

Certificate No: **D2450V2-971\_Jul15**

## CALIBRATION CERTIFICATE

Object **D2450V2 - SN:971**

Calibration procedure(s) **QA CAL-05.v9  
Calibration procedure for dipole validation kits above 700 MHz**

Calibration date: **July 08, 2015**

This calibration certificate documents the traceability to national standards, which realize the physical units of measurements (SI).  
The measurements and the uncertainties with confidence probability are given on the following pages and are part of the certificate.

All calibrations have been conducted in the closed laboratory facility: environment temperature (22 ± 3)°C and humidity < 70%.

Calibration Equipment used (M&TE critical for calibration)

| Primary Standards           | ID #               | Cal Date (Certificate No.)        | Scheduled Calibration  |
|-----------------------------|--------------------|-----------------------------------|------------------------|
| Power meter EPM-442A        | GB37480704         | 07-Oct-14 (No. 217-02020)         | Oct-15                 |
| Power sensor HP 8481A       | US37292783         | 07-Oct-14 (No. 217-02020)         | Oct-15                 |
| Power sensor HP 8481A       | MY41092317         | 07-Oct-14 (No. 217-02021)         | Oct-15                 |
| Reference 20 dB Attenuator  | SN: 5058 (20k)     | 01-Apr-15 (No. 217-02131)         | Mar-16                 |
| Type-N mismatch combination | SN: 5047.2 / 06327 | 01-Apr-15 (No. 217-02134)         | Mar-16                 |
| Reference Probe ES3DV3      | SN: 3205           | 30-Dec-14 (No. ES3-3205_Dec14)    | Dec-15                 |
| DAE4                        | SN: 601            | 18-Aug-14 (No. DAE4-601_Aug14)    | Aug-15                 |
| Secondary Standards         | ID #               | Check Date (in house)             | Scheduled Check        |
| RF generator R&S SMT-06     | 100005             | 04-Aug-99 (in house check Oct-13) | In house check: Oct-16 |
| Network Analyzer HP 8753E   | US37390585 S4206   | 18-Oct-01 (in house check Oct-14) | In house check: Oct-15 |

|                | Name           | Function              | Signature |
|----------------|----------------|-----------------------|-----------|
| Calibrated by: | Jeton Kastrati | Laboratory Technician |           |
| Approved by:   | Katja Pokovic  | Technical Manager     |           |

Issued: July 9, 2015

This calibration certificate shall not be reproduced except in full without written approval of the laboratory.

**Calibration Laboratory of  
Schmid & Partner  
Engineering AG**  
Zeughausstrasse 43, 8004 Zurich, Switzerland



**S** Schweizerischer Kalibrierdienst  
**C** Service suisse d'étalonnage  
**S** Servizio svizzero di taratura  
**S** Swiss Calibration Service

Accredited by the Swiss Accreditation Service (SAS)  
The Swiss Accreditation Service is one of the signatories to the EA  
Multilateral Agreement for the recognition of calibration certificates

Accreditation No.: **SCS 0108**

**Glossary:**

TSL tissue simulating liquid  
ConvF sensitivity in TSL / NORM x,y,z  
N/A not applicable or not measured

**Calibration is Performed According to the Following Standards:**

- a) IEEE Std 1528-2013, "IEEE Recommended Practice for Determining the Peak Spatial-Averaged Specific Absorption Rate (SAR) in the Human Head from Wireless Communications Devices: Measurement Techniques", June 2013
- b) IEC 62209-1, "Procedure to measure the Specific Absorption Rate (SAR) for hand-held devices used in close proximity to the ear (frequency range of 300 MHz to 3 GHz)", February 2005
- c) IEC 62209-2, "Procedure to determine the Specific Absorption Rate (SAR) for wireless communication devices used in close proximity to the human body (frequency range of 30 MHz to 6 GHz)", March 2010
- d) KDB 865664, "SAR Measurement Requirements for 100 MHz to 6 GHz"

**Additional Documentation:**

- e) DASY4/5 System Handbook

**Methods Applied and Interpretation of Parameters:**

- *Measurement Conditions:* Further details are available from the Validation Report at the end of the certificate. All figures stated in the certificate are valid at the frequency indicated.
- *Antenna Parameters with TSL:* The dipole is mounted with the spacer to position its feed point exactly below the center marking of the flat phantom section, with the arms oriented parallel to the body axis.
- *Feed Point Impedance and Return Loss:* These parameters are measured with the dipole positioned under the liquid filled phantom. The impedance stated is transformed from the measurement at the SMA connector to the feed point. The Return Loss ensures low reflected power. No uncertainty required.
- *Electrical Delay:* One-way delay between the SMA connector and the antenna feed point. No uncertainty required.
- *SAR measured:* SAR measured at the stated antenna input power.
- *SAR normalized:* SAR as measured, normalized to an input power of 1 W at the antenna connector.
- *SAR for nominal TSL parameters:* The measured TSL parameters are used to calculate the nominal SAR result.

The reported uncertainty of measurement is stated as the standard uncertainty of measurement multiplied by the coverage factor  $k=2$ , which for a normal distribution corresponds to a coverage probability of approximately 95%.

**Measurement Conditions**

DASY system configuration, as far as not given on page 1.

|                              |                        |             |
|------------------------------|------------------------|-------------|
| DASY Version                 | DASY5                  | V52.8.8     |
| Extrapolation                | Advanced Extrapolation |             |
| Phantom                      | Modular Flat Phantom   |             |
| Distance Dipole Center - TSL | 10 mm                  | with Spacer |
| Zoom Scan Resolution         | dx, dy, dz = 5 mm      |             |
| Frequency                    | 2450 MHz ± 1 MHz       |             |

**Head TSL parameters**

The following parameters and calculations were applied.

|   | Temperature     | Permittivity | Conductivity     |
|---|-----------------|--------------|------------------|
| Nominal Head TSL parameters             | 22.0 °C         | 39.2         | 1.80 mho/m       |
| Measured Head TSL parameters            | (22.0 ± 0.2) °C | 37.9 ± 6 %   | 1.88 mho/m ± 6 % |
| Head TSL temperature change during test | < 0.5 °C        | ----         | ----             |

**SAR result with Head TSL**

|   |                    |                          |
|---|--------------------|--------------------------|
| <b>SAR averaged over 1 cm<sup>3</sup> (1 g) of Head TSL</b>   | Condition          |                          |
| SAR measured  | 250 mW input power | 13.7 W/kg                |
| SAR for nominal Head TSL parameters                           | normalized to 1W   | 53.3 W/kg ± 17.0 % (k=2) |
| <b>SAR averaged over 10 cm<sup>3</sup> (10 g) of Head TSL</b> | condition          |                          |
| SAR measured  | 250 mW input power | 6.40 W/kg                |
| SAR for nominal Head TSL parameters                           | normalized to 1W   | 25.2 W/kg ± 16.5 % (k=2) |

**Body TSL parameters**

The following parameters and calculations were applied.

|   | Temperature     | Permittivity | Conductivity     |
|---|-----------------|--------------|------------------|
| Nominal Body TSL parameters             | 22.0 °C         | 52.7         | 1.95 mho/m       |
| Measured Body TSL parameters            | (22.0 ± 0.2) °C | 52.4 ± 6 %   | 2.03 mho/m ± 6 % |
| Body TSL temperature change during test | < 0.5 °C        | ----         | ----             |

**SAR result with Body TSL**

|   |                    |                          |
|---|--------------------|--------------------------|
| <b>SAR averaged over 1 cm<sup>3</sup> (1 g) of Body TSL</b>   | Condition          |                          |
| SAR measured  | 250 mW input power | 12.9 W/kg                |
| SAR for nominal Body TSL parameters                           | normalized to 1W   | 50.6 W/kg ± 17.0 % (k=2) |
| <b>SAR averaged over 10 cm<sup>3</sup> (10 g) of Body TSL</b> | condition          |                          |
| SAR measured  | 250 mW input power | 6.05 W/kg                |
| SAR for nominal Body TSL parameters                           | normalized to 1W   | 23.9 W/kg ± 16.5 % (k=2) |

**Appendix (Additional assessments outside the scope of SCS 0108)**

**Antenna Parameters with Head TSL**

|                                      |                 |
|--------------------------------------|-----------------|
| Impedance, transformed to feed point | 53.5 Ω + 1.9 jΩ |
| Return Loss                          | - 28.3 dB       |

**Antenna Parameters with Body TSL**

|                                      |                 |
|--------------------------------------|-----------------|
| Impedance, transformed to feed point | 50.5 Ω + 3.6 jΩ |
| Return Loss                          | - 28.8 dB       |

**General Antenna Parameters and Design**

|                                  |          |
|----------------------------------|----------|
| Electrical Delay (one direction) | 1.155 ns |
|----------------------------------|----------|

After long term use with 100W radiated power, only a slight warming of the dipole near the feedpoint can be measured.

The dipole is made of standard semirigid coaxial cable. The center conductor of the feeding line is directly connected to the second arm of the dipole. The antenna is therefore short-circuited for DC-signals. On some of the dipoles, small end caps are added to the dipole arms in order to improve matching when loaded according to the position as explained in the "Measurement Conditions" paragraph. The SAR data are not affected by this change. The overall dipole length is still according to the Standard.

No excessive force must be applied to the dipole arms, because they might bend or the soldered connections near the feedpoint may be damaged.

**Additional EUT Data**

|                 |                   |
|-----------------|-------------------|
| Manufactured by | SPEAG             |
| Manufactured on | December 30, 2014 |

**DASY5 Validation Report for Head TSL**

Date: 08.07.2015

Test Laboratory: SPEAG, Zurich, Switzerland

**DUT: Dipole 2450 MHz; Type: D2450V2; Serial: D2450V2 - SN:971**

Communication System: UID 0 - CW; Frequency: 2450 MHz  
 Medium parameters used:  $f = 2450$  MHz;  $\sigma = 1.88$  S/m;  $\epsilon_r = 37.9$ ;  $\rho = 1000$  kg/m<sup>3</sup>  
 Phantom section: Flat Section  
 Measurement Standard: DASY5 (IEEE/IEC/ANSI C63.19-2011)

DASY52 Configuration:

- Probe: ES3DV3 - SN3205; ConvF(4.54, 4.54, 4.54); Calibrated: 30.12.2014;
- Sensor-Surface: 3mm (Mechanical Surface Detection)
- Electronics: DAE4 Sn601; Calibrated: 18.08.2014
- Phantom: Flat Phantom 5.0 (front); Type: QD000P50AA; Serial: 1001
- DASY52 52.8.8(1222); SEMCAD X 14.6.10(7331)

**Dipole Calibration for Head Tissue/Pin=250 mW, d=10mm/Zoom Scan (7x7x7)/Cube 0:**

Measurement grid: dx=5mm, dy=5mm, dz=5mm  
 Reference Value = 101.3 V/m; Power Drift = 0.03 dB  
 Peak SAR (extrapolated) = 28.1 W/kg  
**SAR(1 g) = 13.7 W/kg; SAR(10 g) = 6.4 W/kg**  
 Maximum value of SAR (measured) = 18.0 W/kg

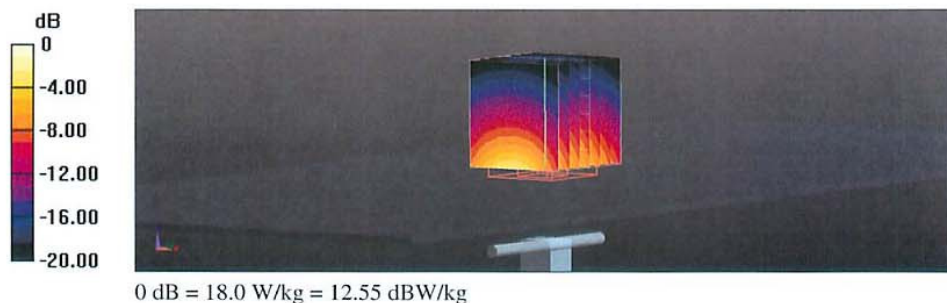

### Impedance Measurement Plot for Head TSL

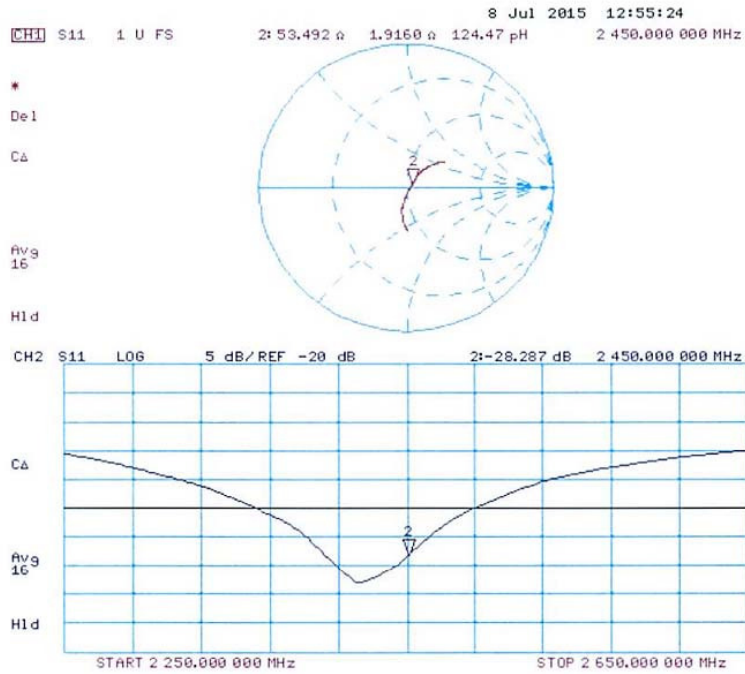

**DASY5 Validation Report for Body TSL**

Date: 08.07.2015

Test Laboratory: SPEAG, Zurich, Switzerland

**DUT: Dipole 2450 MHz; Type: D2450V2; Serial: D2450V2 - SN:971**

Communication System: UID 0 - CW; Frequency: 2450 MHz

Medium parameters used:  $f = 2450$  MHz;  $\sigma = 2.03$  S/m;  $\epsilon_r = 52.4$ ;  $\rho = 1000$  kg/m<sup>3</sup>

Phantom section: Flat Section

Measurement Standard: DASY5 (IEEE/IEC/ANSI C63.19-2011)

DASY52 Configuration:

- Probe: ES3DV3 - SN3205; ConvF(4.32, 4.32, 4.32); Calibrated: 30.12.2014;
- Sensor-Surface: 3mm (Mechanical Surface Detection)
- Electronics: DAE4 Sn601; Calibrated: 18.08.2014
- Phantom: Flat Phantom 5.0 (back); Type: QD000P50AA; Serial: 1002
- DASY52 52.8.8(1222); SEMCAD X 14.6.10(7331)

**Dipole Calibration for Body Tissue/Pin=250 mW, d=10mm/Zoom Scan (7x7x7)/Cube 0:**

Measurement grid: dx=5mm, dy=5mm, dz=5mm

Reference Value = 94.67 V/m; Power Drift = -0.01 dB

Peak SAR (extrapolated) = 26.4 W/kg

**SAR(1 g) = 12.9 W/kg; SAR(10 g) = 6.05 W/kg**

Maximum value of SAR (measured) = 17.0 W/kg

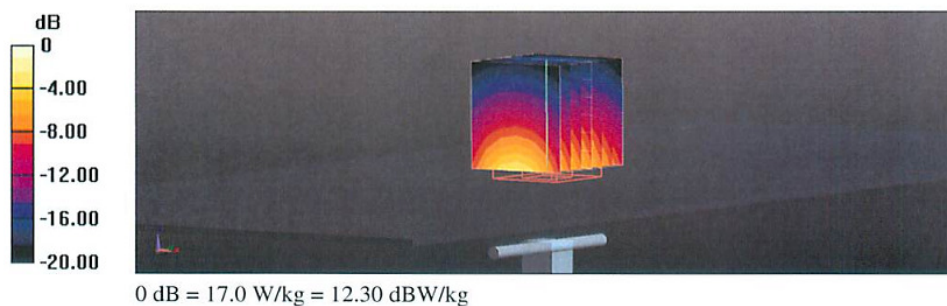

### Impedance Measurement Plot for Body TSL

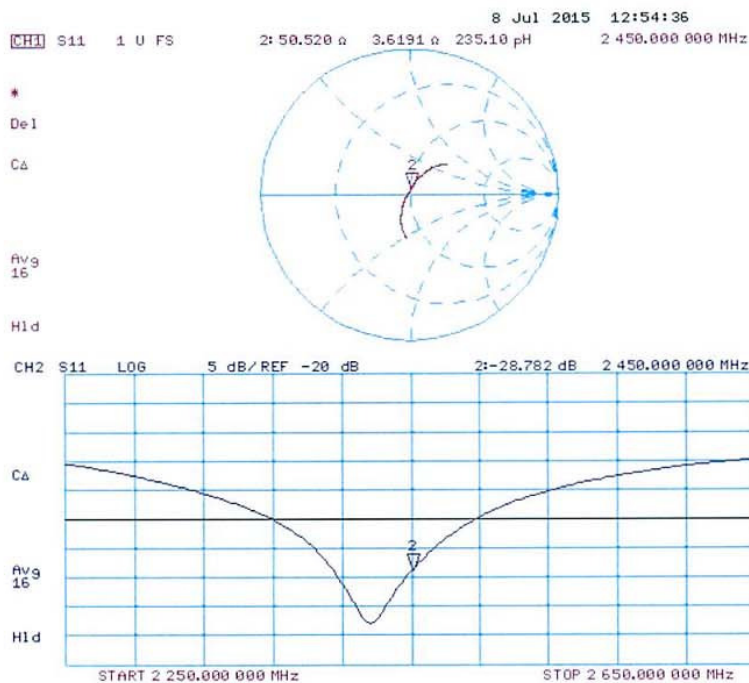

## APPENDIX D EUT TEST POSITION PHOTOS

Liquid depth  $\geq 15\text{cm}$



Body Back(LCD) (0 mm)



**Body Top (0mm)**



**\*\*\*\*\* END OF REPORT \*\*\*\*\***