



RADIO TEST REPORT

FCC ID : 2A15IMTC2
Equipment : Charger
Brand Name : MEATER
Model Name : MT-CP20
Applicant : Apption Labs Limited
66 Commercial Square, Leicester, LE2 7SR United Kingdom
Manufacturer (1) : AboCom Systems, Inc.
No. 77, Yu-Yih Rd, Chu-Nan Chen, Miao-Lih Hsuan, Taiwan, R.O.C.
Manufacturer (2) : Jin Yeong Hann Technology CO., LTD
No. 6, Lane 187, Sec. 2, Chung Cheng Rd, Hu Kou Hsiang, Hsin Chu Hsieh, Taiwan, R.O.C.
Standard : 47 CFR FCC Part 15.247

The product was received on Mar. 19, 2023, and testing was started from Apr. 27, 2023 and completed on Sep. 11, 2023. We, Sporton International Inc. Hsinchu Laboratory, would like to declare that the tested sample has been evaluated in accordance with the procedures given in ANSI C63.10-2013 and shown compliance with the applicable technical standards.

The test results in this report apply exclusively to the tested model / sample. Without written approval of Sporton International Inc. Hsinchu Laboratory, the test report shall not be reproduced except in full.



Approved by: Sam Chen

Sporton International Inc. Hsinchu Laboratory

No.8, Ln. 724, Bo'ai St., Zhubei City, Hsinchu County 302010, Taiwan (R.O.C.)



Table of Contents

History of this test report.....3

Summary of Test Result.....4

1 General Description5

1.1 Information.....5

1.2 Applicable Standards6

1.3 Testing Location Information.....6

1.4 Measurement Uncertainty6

2 Test Configuration of EUT7

2.1 Test Channel Mode7

2.2 The Worst Case Measurement Configuration.....7

2.3 EUT Operation during Test7

2.4 Accessories8

2.5 Support Equipment.....8

2.6 Test Setup Diagram9

3 Transmitter Test Result11

3.1 DTS Bandwidth.....11

3.2 Maximum Conducted Output Power12

3.3 Power Spectral Density15

3.4 Emissions in Non-restricted Frequency Bands17

3.5 Emissions in Restricted Frequency Bands.....18

4 Test Equipment and Calibration Data22

Appendix A. Test Results of DTS Bandwidth

Appendix B. Test Results of Maximum Conducted Output Power

Appendix C. Test Results of Power Spectral Density

Appendix D. Test Results of Emissions in Non-restricted Frequency Bands

Appendix E. Test Results of Emissions in Restricted Frequency Bands

Appendix F. Test Photos

Photographs of EUT v01



History of this test report

Report No.	Version	Description	Issued Date
FR333083-01	01	Initial issue of report	Oct. 25, 2023



Summary of Test Result

Report Clause	Ref Std. Clause	Test Items	Result (PASS/FAIL)	Remark
1.1.2	15.203	Antenna Requirement	PASS	-
-	15.207	AC Power-line Conducted Emissions	N/A	Note 1
3.1	15.247(a)	DTS Bandwidth	PASS	-
3.2	15.247(b)	Maximum Conducted Output Power	PASS	-
3.3	15.247(e)	Power Spectral Density	PASS	-
3.4	15.247(d)	Emissions in Non-restricted Frequency Bands	PASS	-
3.5	15.247(d)	Emissions in Restricted Frequency Bands	PASS	-

Note 1:
The EUT was powered by battery; it's not necessary to apply to AC Power Port Conducted Emission test.

Note 2:
Reference to Sporton Project No.: 333083 (After evaluating, related test items have been verified, and the original test data is replaced.)

Conformity Assessment Condition:

1. The test results (PASS/FAIL) with all measurement uncertainty excluded are presented against the regulation limits or in accordance with the requirements stipulated by the applicant/manufacturer who shall bear all the risks of non-compliance that may potentially occur if measurement uncertainty is taken into account.
2. The measurement uncertainty please refer to each test result in the chapter "Measurement Uncertainty".

Disclaimer:

The product specifications of the EUT presented in the test report that may affect the test assessments are declared by the manufacturer who shall take full responsibility for the authenticity.

Reviewed by: **Sam Chen**
Report Producer: **Sandy Chuang**



1 General Description

1.1 Information

1.1.1 RF General Information

Frequency Range (MHz)	Bluetooth Mode	Ch. Frequency (MHz)	Channel Number
2400-2483.5	LE	2402-2480	0-39 [40]

Band	Mode	BWch (MHz)	Nant
2.4-2.4835GHz	BT-LE(1Mbps)	1.0	1TX

Note:

- ♦ Bluetooth LE uses a GFSK modulation.
- ♦ BWch is the nominal channel bandwidth.

1.1.2 Antenna Information

Ant.	Port	Brand	Model Name	Antenna Type	Connector	Gain (dBi)
1	1	VORWERK	T-TSNC	PCB Antenna	N/A	2

Note1: The above information was declared by manufacturer.

Note2: **For Bluetooth function (1TX, 1RX):**

Only Port 1 can be used as transmitting/receiving functions.

1.1.3 Mode Test Duty Cycle

Mode	DC	DCF(dB)	T(s)	VBW(Hz) ≥ 1/T
BT-LE(1Mbps)	1	0	n/a (DC>=0.98)	n/a (DC>=0.98)

Note:

- ♦ DC is Duty Cycle.
- ♦ DCF is Duty Cycle Factor.

1.1.4 EUT Operational Condition

EUT Power Type	From Battery (1.5V)		
Function	<input checked="" type="checkbox"/> Point-to-multipoint	<input type="checkbox"/> Point-to-point	
Test Software Version	SmartRF Studio7_V2.13.1		
Support Mode	<input checked="" type="checkbox"/> LE 1M PHY: 1 Mb/s		
	<input type="checkbox"/> LE Coded PHY (S=2): 500 Kb/s		
	<input type="checkbox"/> LE Coded PHY (S=8): 125 Kb/s		
	<input type="checkbox"/> LE 2M PHY: 2 Mb/s		

Note: The above information was declared by manufacturer.



1.2 Applicable Standards

According to the specifications of the manufacturer, the EUT must comply with the requirements of the following standards:

- ♦ 47 CFR FCC Part 15.247
- ♦ ANSI C63.10-2013

The following reference test guidance is not within the scope of accreditation of TAF.

- ♦ FCC KDB 558074 D01 v05r02
- ♦ FCC KDB 414788 D01 v01r01

1.3 Testing Location Information

Testing Location Information	
Test Lab. : Sporton International Inc. Hsinchu Laboratory	
Hsinchu	ADD: No.8, Ln. 724, Bo'ai St., Zhubei City, Hsinchu County 302010, Taiwan (R.O.C.)
(TAF: 3787)	TEL: 886-3-656-9065 FAX: 886-3-656-9085
	Test site Designation No. TW3787 with FCC.
	Conformity Assessment Body Identifier (CABID) TW3787 with ISED.

Test Condition	Test Site No.	Test Engineer	Test Environment (°C / %)	Test Date
RF Conducted	TH01-CB	Mason Chan	22.7~23.8 / 61~62	May 08, 2023
Radiated Below 1GHz	03CH06-CB	Roy Mai	22.9~24.4 / 64~67	Sep. 11, 2023
Radiated Above 1GHz	03CH04-CB	Black Lu	22~23 / 55~58	May 08, 2023

1.4 Measurement Uncertainty

ISO/IEC 17025 requires that an estimate of the measurement uncertainties associated with the emissions test results be included in the report. The measurement uncertainties given below are based on a 95% confidence level (based on a coverage factor (k=2))

Test Items	Uncertainty	Remark
Radiated Emission (9kHz ~ 30MHz)	3.7 dB	Confidence levels of 95%
Radiated Emission (30MHz ~ 1,000MHz)	5.1 dB	Confidence levels of 95%
Radiated Emission (1GHz ~ 18GHz)	5.2 dB	Confidence levels of 95%
Radiated Emission (18GHz ~ 40GHz)	4.7 dB	Confidence levels of 95%
Conducted Emission	3.2 dB	Confidence levels of 95%
Output Power Measurement	0.8 dB	Confidence levels of 95%
Power Density Measurement	3.2 dB	Confidence levels of 95%
Bandwidth Measurement	2.0 %	Confidence levels of 95%



2 Test Configuration of EUT

2.1 Test Channel Mode

Mode	Power Setting
BT-LE(1Mbps)	-
2402MHz	5
2440MHz	5
2480MHz	5

2.2 The Worst Case Measurement Configuration

The Worst Case Mode for Following Conformance Tests	
Tests Item	DTS Bandwidth Maximum Conducted Output Power Power Spectral Density Emissions in Non-restricted Frequency Bands
Test Condition	Conducted measurement at transmit chains

The Worst Case Mode for Following Conformance Tests	
Tests Item	Emissions in Restricted Frequency Bands
Test Condition	Radiated measurement If EUT consist of multiple antenna assembly (multiple antenna are used in EUT regardless of spatial multiplexing MIMO configuration), the radiated test should be performed with highest antenna gain of each antenna type.
Operating Mode < 1GHz	Normal Link / Test Voltage: 1.5V
	1. The EUT was performed at X axis, Y axis and Z axis position, and the worst case was found at X axis. Thus, the measurement will follow this same test configuration. 2. There are two modes of EUT, one is Charge mode, the other is Standby mode. Standby mode has been evaluated to be the worst case. Consequently, measurement for Radiated Emission test will follow this same test mode.
1	EUT in X axis – Standby mode
Operating Mode > 1GHz	CTX
	The EUT was performed at X axis, Y axis and Z axis position, and the worst case was found at Y axis. Thus, the measurement will follow this same test configuration.
1	EUT in Y axis

2.3 EUT Operation during Test

The EUT was programmed to be in continuously transmitting mode.



2.4 Accessories

Accessories	
Battery*1	

2.5 Support Equipment

For Radiated (below 1GHz):

Support Equipment				
No.	Equipment	Brand Name	Model Name	FCC ID
A	iPad mini	Apple	ME279TA	N/A
B	Probe	MEATER	MT-PR10	N/A

For Radiated (above 1GHz):

Support Equipment				
No.	Equipment	Brand Name	Model Name	FCC ID
A	Notebook	DELL	E4300	N/A
B	Fixture	T1	LAUNCHXL-CC2640R2	N/A

For RF Conducted:

Support Equipment				
No.	Equipment	Brand Name	Model Name	FCC ID
A	Notebook	DELL	E4300	N/A
B	Fixture	T1	LAUNCHXL-CC2640R2	N/A

2.6 Test Setup Diagram

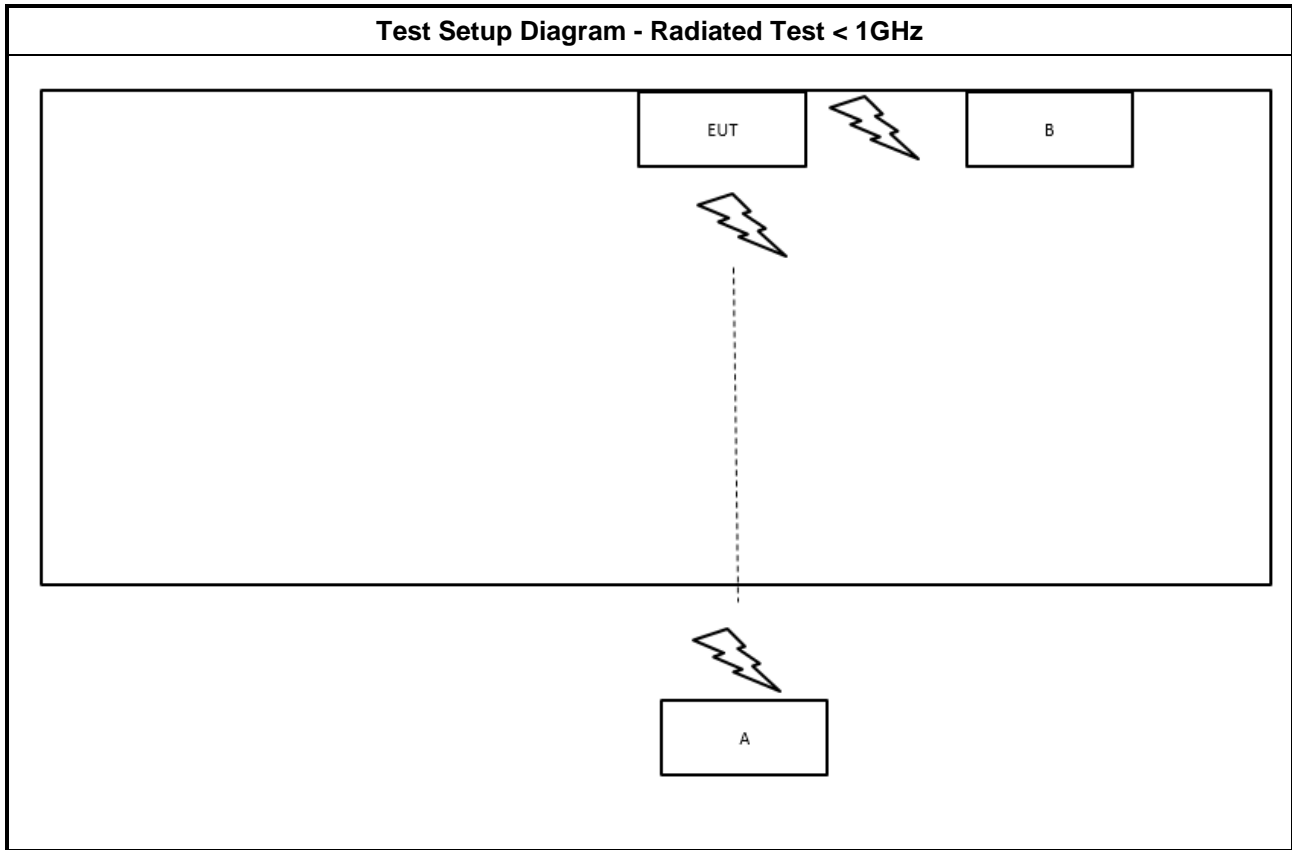

Test Setup Diagram - Radiated Test > 1GHz

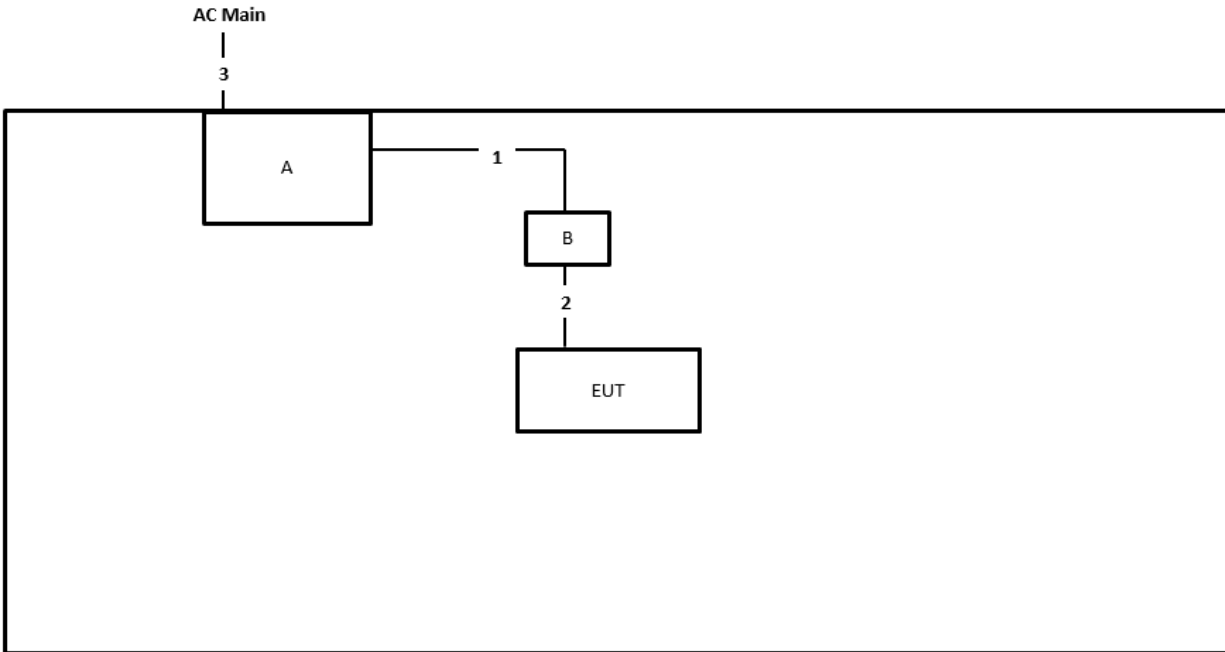

Item	Connection	Shielded	Length
1	USB cable	Yes	0.8m
2	Console cable	No	0.1m
3	Power cable	No	1.5m

3 Transmitter Test Result

3.1 DTS Bandwidth

3.1.1 6dB Bandwidth Limit

6dB Bandwidth Limit
Systems using digital modulation techniques:
<ul style="list-style-type: none"> ▪ 6 dB bandwidth \geq 500 kHz.

3.1.2 Measuring Instruments

Refer a test equipment and calibration data table in this test report.

3.1.3 Test Procedures

Test Method
<ul style="list-style-type: none"> ▪ For the emission bandwidth shall be measured using one of the options below:
<input checked="" type="checkbox"/> Refer as FCC KDB 558074, clause 8.2 & C63.10 clause 11.8.1 Option 1 for 6 dB bandwidth measurement.
<input type="checkbox"/> Refer as FCC KDB 558074, clause 8.2 & C63.10 clause 11.8.2 Option 2 for 6 dB bandwidth measurement.
<input type="checkbox"/> Refer as ANSI C63.10, clause 6.9.1 for occupied bandwidth testing.

3.1.4 Test Setup

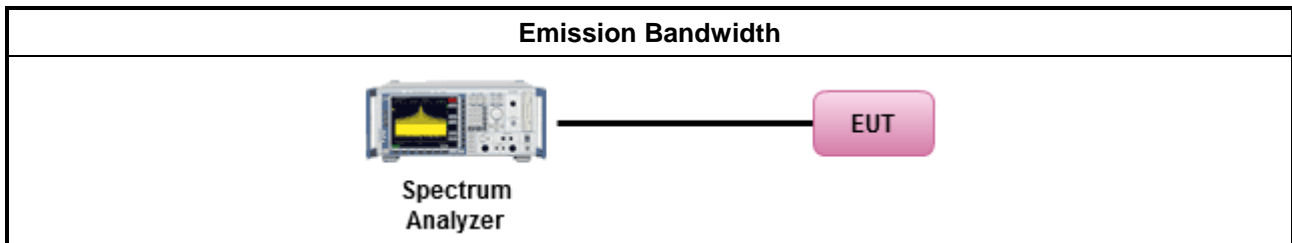

3.1.5 Test Result of Emission Bandwidth

Refer as Appendix A



3.2 Maximum Conducted Output Power

3.2.1 Maximum Conducted Output Power Limit

Maximum Conducted Output Power Limit	
	<ul style="list-style-type: none"> ▪ If $G_{TX} \leq 6$ dBi, then $P_{Out} \leq 30$ dBm (1 W)
	<ul style="list-style-type: none"> ▪ Point-to-multipoint systems (P2M): If $G_{TX} > 6$ dBi, then $P_{Out} = 30 - (G_{TX} - 6)$ dBm
	<ul style="list-style-type: none"> ▪ Point-to-point systems (P2P): If $G_{TX} > 6$ dBi, then $P_{Out} = 30 - (G_{TX} - 6)/3$ dBm
	<ul style="list-style-type: none"> ▪ Smart antenna system (SAS):
	<ul style="list-style-type: none"> - Single beam: If $G_{TX} > 6$ dBi, then $P_{Out} = 30 - (G_{TX} - 6)/3$ dBm
	<ul style="list-style-type: none"> - Overlap beam: If $G_{TX} > 6$ dBi, then $P_{Out} = 30 - (G_{TX} - 6)/3$ dBm
	<ul style="list-style-type: none"> - Aggregate power on all beams: If $G_{TX} > 6$ dBi, then $P_{Out} = 30 - (G_{TX} - 6)/3 + 8$ dB dBm
P_{Out} = maximum peak conducted output power or maximum conducted output power in dBm, G_{TX} = the maximum transmitting antenna directional gain in dBi.	

3.2.2 Measuring Instruments

Refer a test equipment and calibration data table in this test report.



3.2.3 Test Procedures

Test Method	
<ul style="list-style-type: none"> ▪ Maximum Peak Conducted Output Power 	
<input type="checkbox"/>	Refer as FCC KDB 558074, clause 8.3.1.1 & C63.10 clause 11.9.1.1 (RBW ≥ EBW method).
<input type="checkbox"/>	Refer as FCC KDB 558074, clause 8.3.1.3 & C63.10 clause 11.9.1.3 (peak power meter).
<ul style="list-style-type: none"> ▪ Maximum Conducted Output Power 	
[duty cycle ≥ 98% or external video / power trigger]	
<input type="checkbox"/>	Refer as FCC KDB 558074, clause 8.3.2.2 & C63.10 clause 11.9.2.2.2 Method AVGSA-1.
<input type="checkbox"/>	Refer as FCC KDB 558074, clause 8.3.2.2 & C63.10 clause 11.9.2.2.3 Method AVGSA-1A. (alternative)
duty cycle < 98% and average over on/off periods with duty factor	
<input type="checkbox"/>	Refer as FCC KDB 558074, clause 8.3.2.2 & C63.10 clause 11.9.2.2.4 Method AVGSA-2.
<input type="checkbox"/>	Refer as FCC KDB 558074, clause 8.3.2.2 & C63.10 clause 11.9.2.2.5 Method AVGSA-2A (alternative)
<input type="checkbox"/>	Refer as FCC KDB 558074, clause 8.3.2.2 & C63.10 clause 11.9.2.2.6 Method AVGSA-3
<input type="checkbox"/>	Refer as FCC KDB 558074, clause 8.3.2.2 & C63.10 clause 11.9.2.2.7 Method AVGSA-3A (alternative)
Measurement using a power meter (PM)	
<input type="checkbox"/>	Refer as FCC KDB 558074, clause 8.3.2.3 & C63.10 clause 11.9.2.3.1 Method AVGPM (using an RF average power meter).
<input checked="" type="checkbox"/>	Refer as FCC KDB 558074, clause 8.3.2.3 & C63.10 clause 11.9.2.3.2 Method AVGPM-G (using an gate RF average power meter).
<ul style="list-style-type: none"> ▪ For conducted measurement. 	
<ul style="list-style-type: none"> ▪ If the EUT supports multiple transmit chains using options given below: Refer as FCC KDB 662911, In-band power measurements. Using the measure-and-sum approach, measured all transmit ports individually. Sum the power (in linear power units e.g., mW) of all ports for each individual sample and save them. 	
<ul style="list-style-type: none"> ▪ If multiple transmit chains, EIRP calculation could be following as methods: $P_{total} = P_1 + P_2 + \dots + P_n$ (calculated in linear unit [mW] and transfer to log unit [dBm]) $EIRP_{total} = P_{total} + DG$ 	

3.2.4 Test Setup

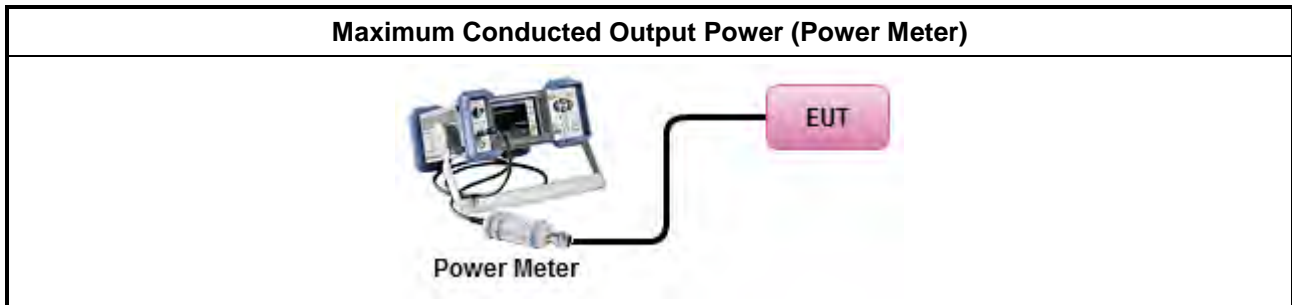

3.2.5 Test Result of Maximum Conducted Output Power

Refer as Appendix B



3.3 Power Spectral Density

3.3.1 Power Spectral Density Limit

Power Spectral Density Limit
<ul style="list-style-type: none"> Power Spectral Density (PSD) ≤ 8 dBm/3kHz

3.3.2 Measuring Instruments

Refer a test equipment and calibration data table in this test report.

3.3.3 Test Procedures

Test Method
<ul style="list-style-type: none"> Peak power spectral density procedures that the same method as used to determine the conducted output power. If maximum peak conducted output power was measured to demonstrate compliance to the output power limit, then the peak PSD procedure below (Method PKPSD) shall be used. If maximum conducted output power was measured to demonstrate compliance to the output power limit, then one of the average PSD procedures shall be used, as applicable based on the following criteria (the peak PSD procedure is also an acceptable option).
<input checked="" type="checkbox"/> Refer as FCC KDB 558074, clause 8.4 & C63.10 clause 11.10 Method Max. PSD. [duty cycle ≥ 98% or external video / power trigger]
<ul style="list-style-type: none"> For conducted measurement.
<ul style="list-style-type: none"> If The EUT supports multiple transmit chains using options given below: <ul style="list-style-type: none"> <input type="checkbox"/> Option 1: Measure and sum the spectra across the outputs. Refer as FCC KDB 662911, In-band power spectral density (PSD). Sample all transmit ports simultaneously using a spectrum analyzer for each transmit port. Where the trace bin-by-bin of each transmit port summing can be performed. (i.e., in the first spectral bin of output 1 is summed with that in the first spectral bin of output 2 and that from the first spectral bin of output 3, and so on up to the NTX output to obtain the value for the first frequency bin of the summed spectrum.). Add up the amplitude (power) values for the different transmit chains and use this as the new data trace. <input type="checkbox"/> Option 2: Measure and sum spectral maxima across the outputs. With this technique, spectra are measured at each output of the device at the required resolution bandwidth. The maximum value (peak) of each spectrum is determined. These maximum values are then summed mathematically in linear power units across the outputs. These operations shall be performed separately over frequency spans that have different out-of-band or spurious emission limits, <input type="checkbox"/> Option 3: Measure and add 10 log(N) dB, where N is the number of transmit chains. Refer as FCC KDB 662911, In-band power spectral density (PSD). Performed at each transmit chains and each transmit chains shall be compared with the limit have been reduced with 10 log(N). Or each transmit chains shall be add 10 log(N) to compared with the limit.

3.3.4 Test Setup

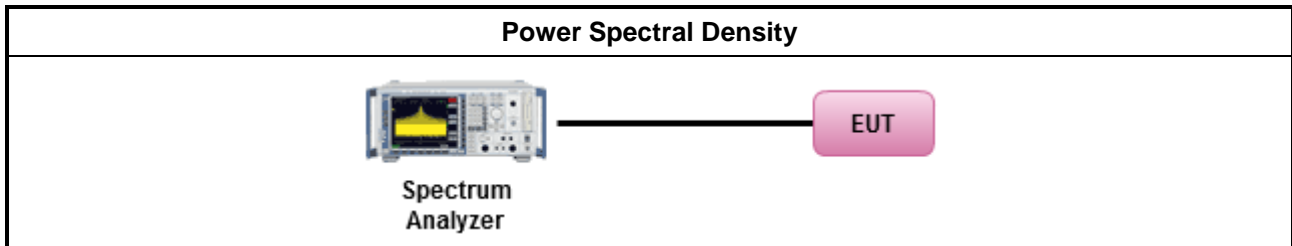

3.3.5 Test Result of Power Spectral Density

Refer as Appendix C

3.4 Emissions in Non-restricted Frequency Bands

3.4.1 Emissions in Non-restricted Frequency Bands Limit

Un-restricted Band Emissions Limit	
RF output power procedure	Limit (dBc)
Peak output power procedure	20
Average output power procedure	30

Note 1: If the peak output power procedure is used to measure the fundamental emission power to demonstrate compliance to requirements, then the peak conducted output power measured within any 100 kHz outside the authorized frequency band shall be attenuated by at least 20 dB relative to the maximum measured in-band peak PSD level.

Note 2: If the average output power procedure is used to measure the fundamental emission power to demonstrate compliance to requirements, then the power in any 100 kHz outside of the authorized frequency band shall be attenuated by at least 30 dB relative to the maximum measured in-band average PSD level.

3.4.2 Measuring Instruments

Refer a test equipment and calibration data table in this test report.

3.4.3 Test Procedures

Test Method
<ul style="list-style-type: none"> Refer as FCC KDB 558074, clause 8.5 for unwanted emissions into non-restricted bands.

3.4.4 Test Setup

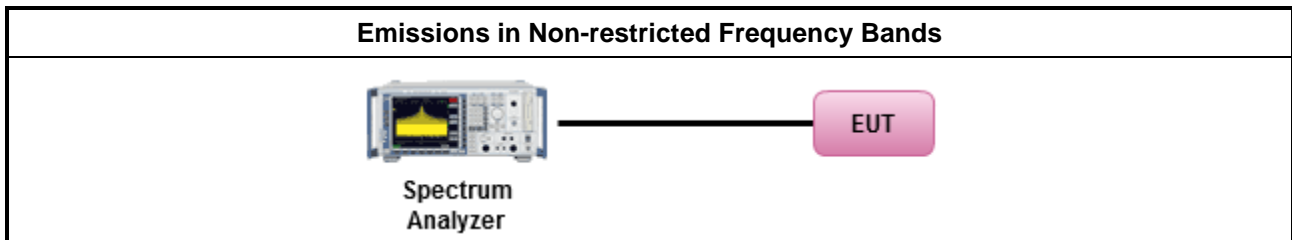

3.4.5 Test Result of Emissions in Non-restricted Frequency Bands

Refer as Appendix D



3.5 Emissions in Restricted Frequency Bands

3.5.1 Emissions in Restricted Frequency Bands Limit

Restricted Band Emissions Limit			
Frequency Range (MHz)	Field Strength (uV/m)	Field Strength (dBuV/m)	Measure Distance (m)
0.009~0.490	2400/F(kHz)	48.5 - 13.8	300
0.490~1.705	24000/F(kHz)	33.8 - 23	30
1.705~30.0	30	29	30
30~88	100	40	3
88~216	150	43.5	3
216~960	200	46	3
Above 960	500	54	3

Note 1: Test distance for frequencies at or above 30 MHz, measurements may be performed at a distance other than the limit distance provided they are not performed in the near field and the emissions to be measured can be detected by the measurement equipment. When performing measurements at a distance other than that specified, the results shall be extrapolated to the specified distance using an extrapolation factor of 20 dB/decade (inverse of linear distance for field-strength measurements, inverse of linear distance-squared for power-density measurements).

Note 2: Test distance for frequencies at below 30 MHz, measurements may be performed at a distance closer than the EUT limit distance; however, an attempt should be made to avoid making measurements in the near field. When performing measurements below 30 MHz at a closer distance than the limit distance, the results shall be extrapolated to the specified distance by either making measurements at a minimum of two or more distances on at least one radial to determine the proper extrapolation factor or by using the square of an inverse linear distance extrapolation factor (40 dB / decade). The test report shall specify the extrapolation method used to determine compliance of the EUT.

Note 3: Using the distance of 1m during the test for above 18 GHz, and the test value to correct for the distance factor at 3m.

3.5.2 Measuring Instruments

Refer a test equipment and calibration data table in this test report.



3.5.3 Test Procedures

Test Method	
<ul style="list-style-type: none"> ▪ The average emission levels shall be measured in [duty cycle \geq 98 or duty factor]. 	
<ul style="list-style-type: none"> ▪ Refer as ANSI C63.10, clause 6.10.3 band-edge testing shall be performed at the lowest frequency channel and highest frequency channel within the allowed operating band. 	
<ul style="list-style-type: none"> ▪ For the transmitter unwanted emissions shall be measured using following options below: 	
	<ul style="list-style-type: none"> ▪ Refer as FCC KDB 558074, clause 8.6 for unwanted emissions into restricted bands.
	<input type="checkbox"/> Refer as FCC KDB 558074, clause 8.6 & C63.10 clause 11.12.2.5.1(trace averaging for duty cycle \geq 98%).
	<input type="checkbox"/> Refer as FCC KDB 558074, clause 8.6 & C63.10 clause 11.12.2.5.2(trace averaging + duty factor).
	<input checked="" type="checkbox"/> Refer as FCC KDB 558074, clause 8.6 & C63.10 clause 11.12.2.5.3(Reduced VBW \geq 1/T).
	<input type="checkbox"/> Refer as ANSI C63.10, clause 11.12.2.5.3 (Reduced VBW). VBW \geq 1/T, where T is pulse time.
	<input type="checkbox"/> Refer as ANSI C63.10, clause 7.5 average value of pulsed emissions.
	<input checked="" type="checkbox"/> Refer as FCC KDB 558074, clause 8.6 & C63.10 clause 11.12.2.4 measurement procedure peak limit.
<ul style="list-style-type: none"> ▪ For the transmitter band-edge emissions shall be measured using following options below: 	
	<ul style="list-style-type: none"> ▪ Refer as FCC KDB 558074 clause 8.7 & c63.10 clause 11.13.1, When the performing peak or average radiated measurements, emissions within 2 MHz of the authorized band edge may be measured using the marker-delta method described below.
	<ul style="list-style-type: none"> ▪ Refer as FCC KDB 558074, clause 8.7 (ANSI C63.10, clause 6.10.6) for marker-delta method for band-edge measurements.
	<ul style="list-style-type: none"> ▪ Refer as FCC KDB 558074, clause 8.7 for narrower resolution bandwidth (100kHz) using the band power and summing the spectral levels (i.e., 1 MHz).
	<ul style="list-style-type: none"> ▪ For conducted unwanted emissions into restricted bands (absolute emission limits). Devices with multiple transmit chains using options given below: (1) Measure and sum the spectra across the outputs or (2) Measure and add 10 log(N) dB
	<ul style="list-style-type: none"> ▪ For FCC KDB 662911 The methodology described here may overestimate array gain, thereby resulting in apparent failures to satisfy the out-of-band limits even if the device is actually compliant. In such cases, compliance may be demonstrated by performing radiated tests around the frequencies at which the apparent failures occurred.

3.5.4 Test Setup

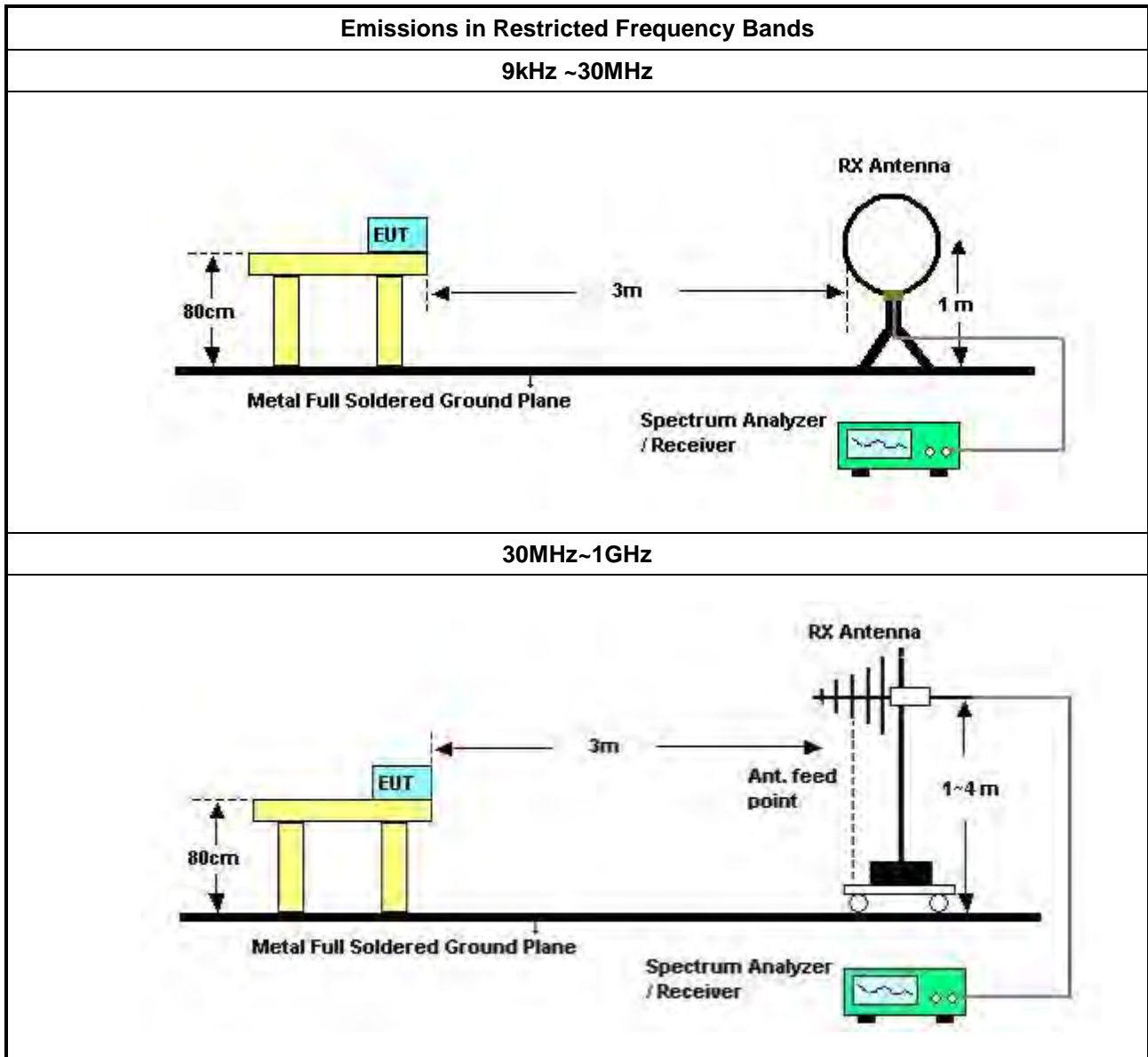

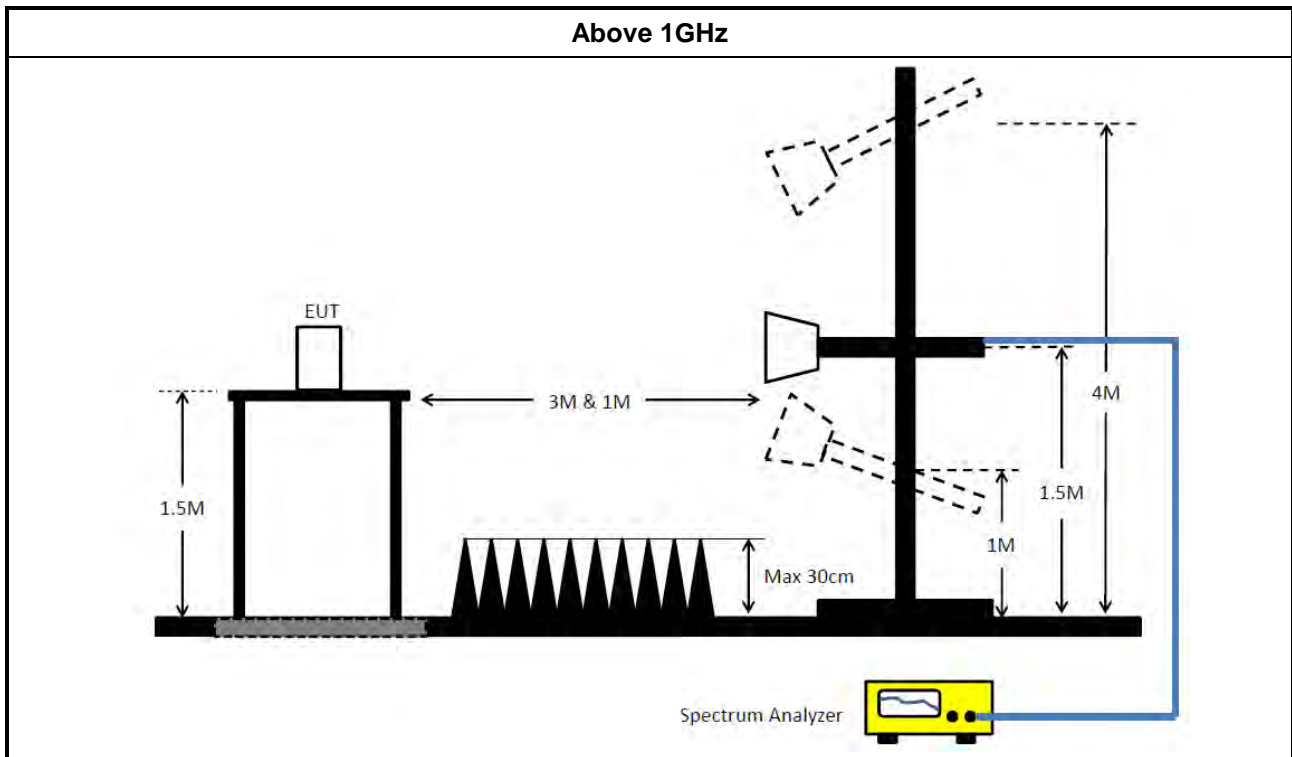

3.5.5 Measurement Results Calculation

The measured Level is calculated using:

Corrected Reading: Antenna factor (AF) + Cable loss (CL) + Read level (Raw) - Preamp factor (PA)(if applicable) = Level.

3.5.6 Emissions in Restricted Frequency Bands (Below 30MHz)

There is a comparison data of both open-field test site and alternative test site - semi-Anechoic chamber according to KDB414788 Radiated Test Site, and the result came out very similar.

All amplitude of spurious emissions that are attenuated by more than 20 dB below the permissible value has no need to be reported.

The radiated emissions were investigated from 9 kHz or the lowest frequency generated within the device, up to the 10th harmonic or 40 GHz, whichever is appropriate.

3.5.7 Test Result of Emissions in Restricted Frequency Bands

Refer as Appendix E



4 Test Equipment and Calibration Data

Instrument	Brand	Model No.	Serial No.	Characteristics	Calibration Date	Calibration Due Date	Remark
Loop Antenna	Teseq	HLA 6120	31244	9kHz - 30 MHz	Mar. 23, 2023	Mar. 22, 2024	Radiation (03CH06-CB)
3m Semi Anechoic Chamber NSA	TDK	SAC-3M	03CH06-CB	30 MHz ~ 1 GHz	Aug. 03, 2023	Aug. 02, 2024	Radiation (03CH06-CB)
Bilog Antenna with 6 dB attenuator	TESEQ & EMCI	CBL6112D & N-6-06	37878 & AT-N0606	20MHz ~ 2GHz	Jul. 30, 2023	Jul. 29, 2024	Radiation (03CH06-CB)
Pre-Amplifier	Agilent	310N	187290	0.1MHz ~ 1GHz	Nov. 04, 2022	Nov. 03, 2023	Radiation (03CH06-CB)
Spectrum analyzer	R&S	FSP40	100080	9kHz~40GHz	Dec. 21, 2022	Dec. 20, 2023	Radiation (03CH06-CB)
EMI Test Receiver	R&S	ESCS	826547/017	9kHz ~ 2.75GHz	Jun. 13, 2023	Jun. 12, 2024	Radiation (03CH06-CB)
RF Cable-low	Woken	RG402	Low Cable-24+68	30MHz~1GHz	Aug. 15, 2023	Aug. 14, 2024	Radiation (03CH06-CB)
Test Software	SPORTON	SENSE	V5.10	-	N.C.R.	N.C.R.	Radiation (03CH06-CB)
3m Semi Anechoic Chamber VSWR	TDK	SAC-3M	03CH04-CB	1GHz ~18GHz 3m	Feb. 23, 2023	Feb. 22, 2024	Radiation (03CH04-CB)
Horn Antenna	ETS- Lindgren	3115	00143147	750MHz~18GHz	Oct. 12, 2022	Oct. 11, 2023	Radiation (03CH04-CB)
Horn Antenna	Schwarzbeck	BBHA 9170	BBHA91702 52	15GHz ~ 40GHz	Aug. 22, 2022	Aug. 21, 2023	Radiation (03CH04-CB)
Pre-Amplifier	Agilent	83017A	MY5327006 3	0.5GHz ~ 26.5GHz	Jul. 01, 2022	Jun. 30, 2023	Radiation (03CH04-CB)
Pre-Amplifier	SGH	SGH184	20221107-3	18GHz ~ 40GHz	Nov. 16, 2022	Nov. 15, 2023	Radiation (03CH04-CB)
Spectrum Analyzer	R&S	FSP40	100142	9kHz~40GHz	Mar. 21, 2023	Mar. 20, 2024	Radiation (03CH04-CB)
RF Cable-high	Woken	RG402	High Cable-21	1GHz - 18GHz	Oct. 03, 2022	Oct. 02, 2023	Radiation (03CH04-CB)
RF Cable-high	Woken	RG402	High Cable-21+67	1GHz - 18GHz	Oct. 03, 2022	Oct. 02, 2023	Radiation (03CH04-CB)
High Cable	Woken	WCA0929M	40G#5+6	1GHz ~ 40 GHz	Dec. 07, 2022	Dec. 06, 2023	Radiation (03CH04-CB)
High Cable	Woken	WCA0929M	40G#5	1GHz ~ 40 GHz	Dec. 07, 2022	Dec. 06, 2023	Radiation (03CH04-CB)
High Cable	Woken	WCA0929M	40G#6	1GHz ~ 40 GHz	Dec. 07, 2022	Dec. 06, 2023	Radiation (03CH04-CB)



Instrument	Brand	Model No.	Serial No.	Characteristics	Calibration Date	Calibration Due Date	Remark
Test Software	SPORTON	SENSE	V5.10	-	N.C.R.	N.C.R.	Radiation (03CH04-CB)
Spectrum analyzer	R&S	FSV40	100979	9kHz~40GHz	May 27, 2022	May 26, 2023	Conducted (TH01-CB)
Switct	SPTCB	SP-SWI	SWI-01	1 GHz ~26.5 GHz	Oct. 04, 2022	Oct. 03, 2023	Conducted (TH01-CB)
RF Cable-high	Woken	RG402	High Cable-06	1 GHz – 18 GHz	Oct. 03, 2022	Oct. 02, 2023	Conducted (TH01-CB)
RF Cable-high	Woken	RG402	High Cable-07	1 GHz – 18 GHz	Oct. 03, 2022	Oct. 02, 2023	Conducted (TH01-CB)
RF Cable-high	Woken	RG402	High Cable-08	1 GHz – 18 GHz	Oct. 03, 2022	Oct. 02, 2023	Conducted (TH01-CB)
RF Cable-high	Woken	RG402	High Cable-09	1 GHz – 18 GHz	Oct. 03, 2022	Oct. 02, 2023	Conducted (TH01-CB)
RF Cable-high	Woken	RG402	High Cable-10	1 GHz – 18 GHz	Oct. 03, 2022	Oct. 02, 2023	Conducted (TH01-CB)
RF Cable-high	Woken	RG402	High Cable-30	1 GHz – 18 GHz	Oct. 03, 2022	Oct. 02, 2023	Conducted (TH01-CB)
Power Sensor	Agilent	E9327A	US40442088	50MHz~18GHz	Feb. 22, 2023	Feb. 21, 2024	Conducted (TH01-CB)
Power Meter	Agilent	E4416A	GB41291199	50MHz~18GHz	Feb. 22, 2023	Feb. 21, 2024	Conducted (TH01-CB)
Test Software	SPORTON	SENSE	V5.10	-	N.C.R.	N.C.R.	Conducted (TH01-CB)

Note: Calibration Interval of instruments listed above is one year.

N.C.R. means Non-Calibration required.



Summary

Mode	Max-N dB (Hz)	Max-OBW (Hz)	ITU-Code	Min-N dB (Hz)	Min-OBW (Hz)
2.4-2.4835GHz	-	-	-	-	-
BT-LE(1Mbps)	685k	1.053M	1M05F1D	676.25k	1.044M

Max-N dB = Maximum 6dB down bandwidth; Max-OBW = Maximum 99% occupied bandwidth;
Min-N dB = Minimum 6dB down bandwidth; Min-OBW = Minimum 99% occupied bandwidth



Result

Mode	Result	Limit (Hz)	Port 1-N dB (Hz)	Port 1-OBW (Hz)
BT-LE(1Mbps)	-	-	-	-
2402MHz	Pass	500k	681.25k	1.053M
2440MHz	Pass	500k	685k	1.044M
2480MHz	Pass	500k	676.25k	1.051M

Port X-N dB = Port X 6dB down bandwidth;
Port X-OBW = Port X 99% occupied bandwidth

2.4-2.4835GHz_BT-LE(1Mbps)

EBW-DTS

2402MHz

08/05/2023

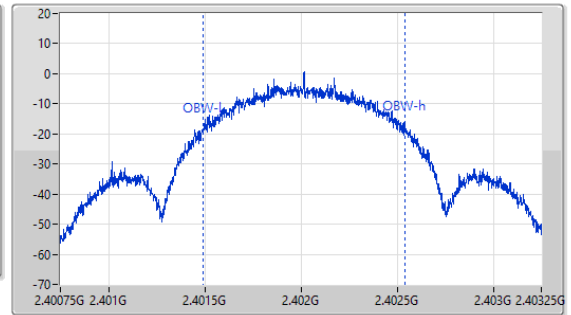
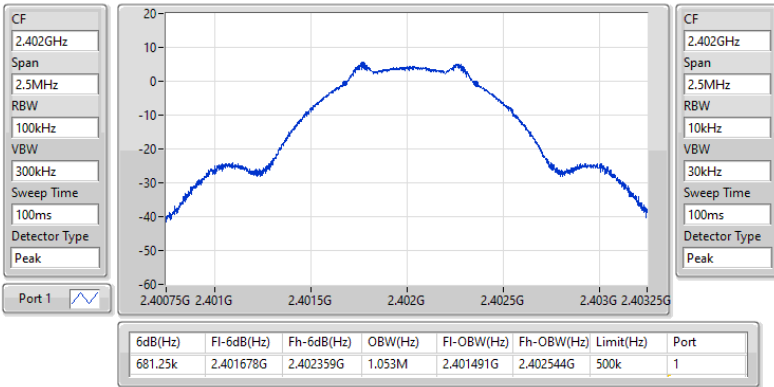

2.4-2.4835GHz_BT-LE(1Mbps)

EBW-DTS

2440MHz

08/05/2023

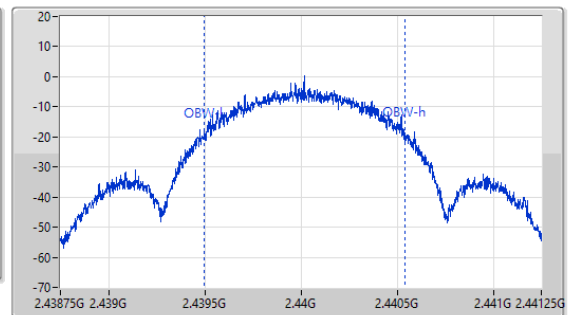
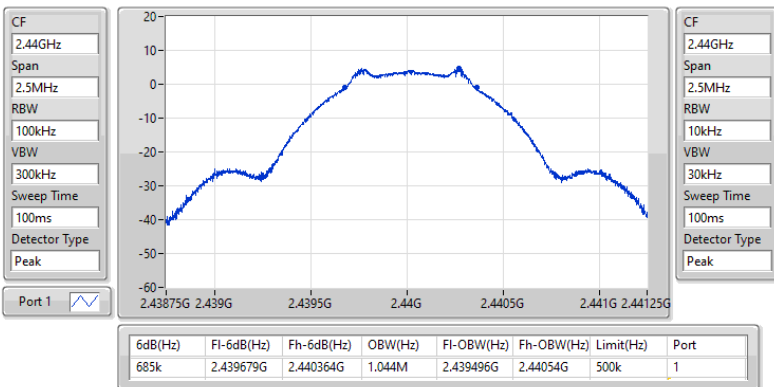

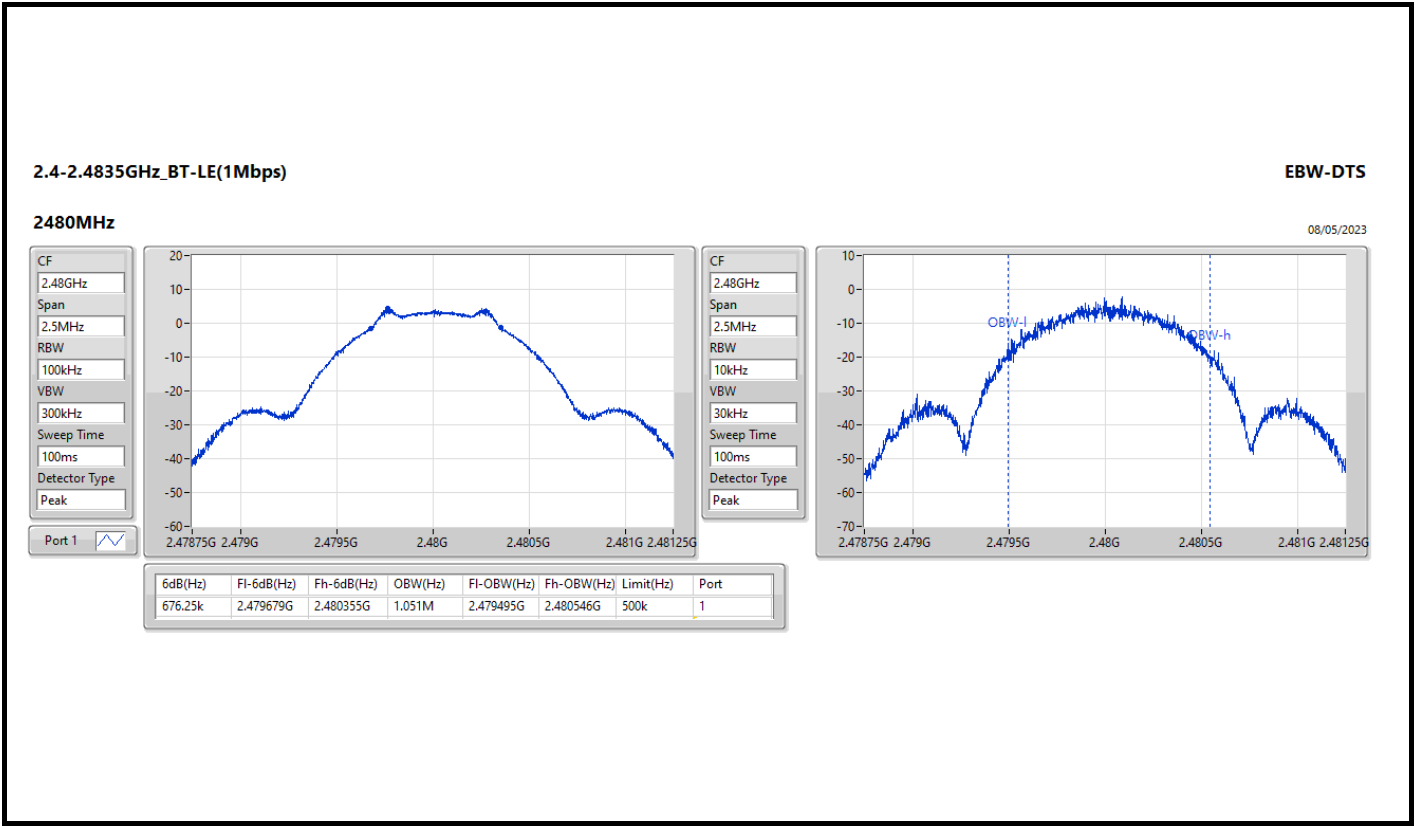



Summary

Mode	Total Power (dBm)	Power (W)
2.4-2.4835GHz	-	-
BT-LE(1Mbps)	5.23	0.00333



Result

Mode	Result	DG (dBi)	Total Power (dBm)	Power Limit (dBm)
BT-LE(1Mbps)	-	-	-	-
2402MHz	Pass	2.00	5.23	30.00
2440MHz	Pass	2.00	4.74	30.00
2480MHz	Pass	2.00	4.41	30.00

DG = Directional Gain; Port X = Port X output power



Summary

Mode	PD (dBm/RBW)
2.4-2.4835GHz	-
BT-LE(1Mbps)	-7.85

RBW = 3kHz:



Result

Mode	Result	DG (dBi)	PD (dBm/RBW)	PD Limit (dBm/RBW)
BT-LE(1Mbps)	-	-	-	-
2402MHz	Pass	2.00	-7.85	8.00
2440MHz	Pass	2.00	-8.55	8.00
2480MHz	Pass	2.00	-9.81	8.00

DG = Directional Gain; RBW = 3kHz;
PD = trace bin-by-bin of each transmits port summing can be performed maximum power density; Port X = Port X Power Density;

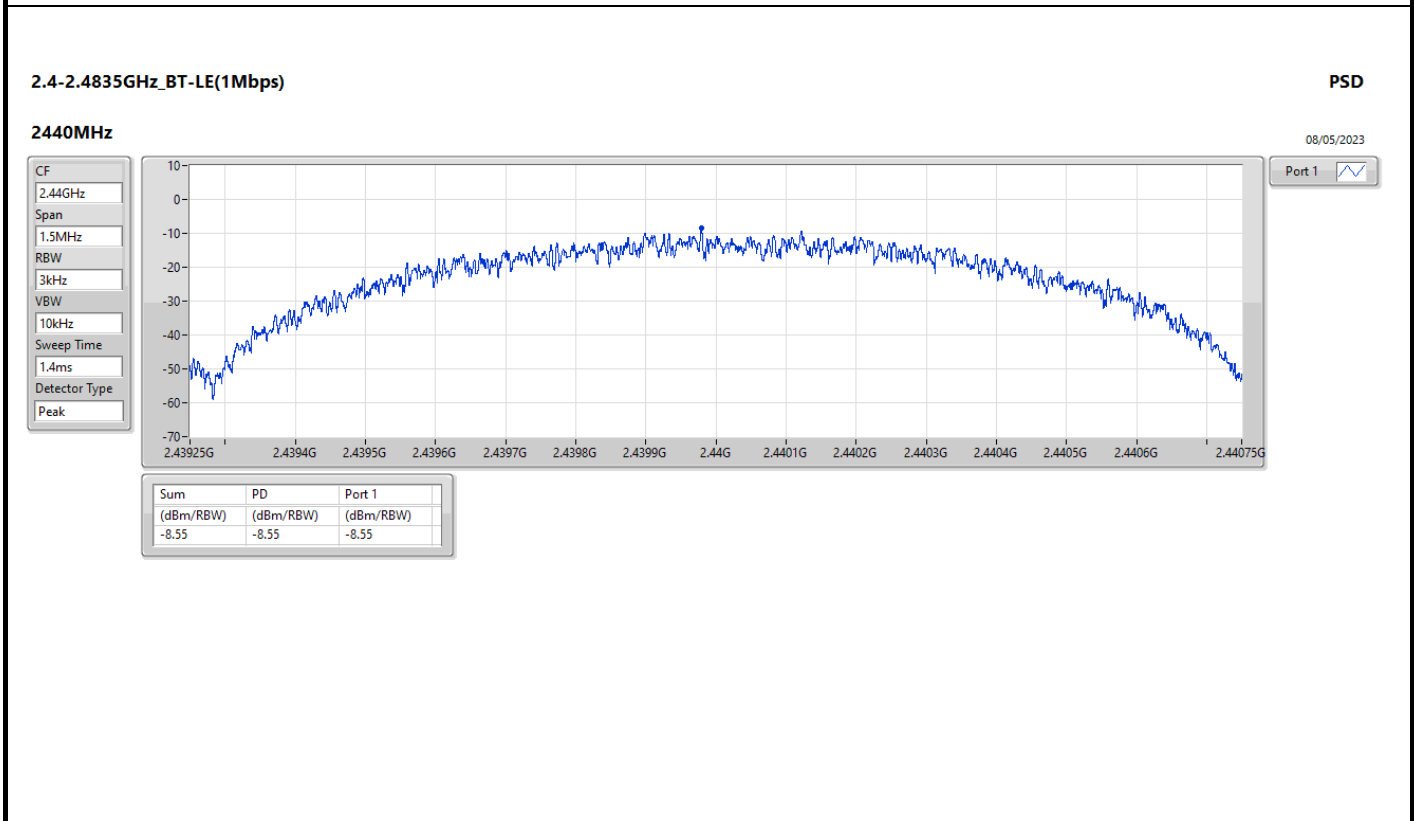
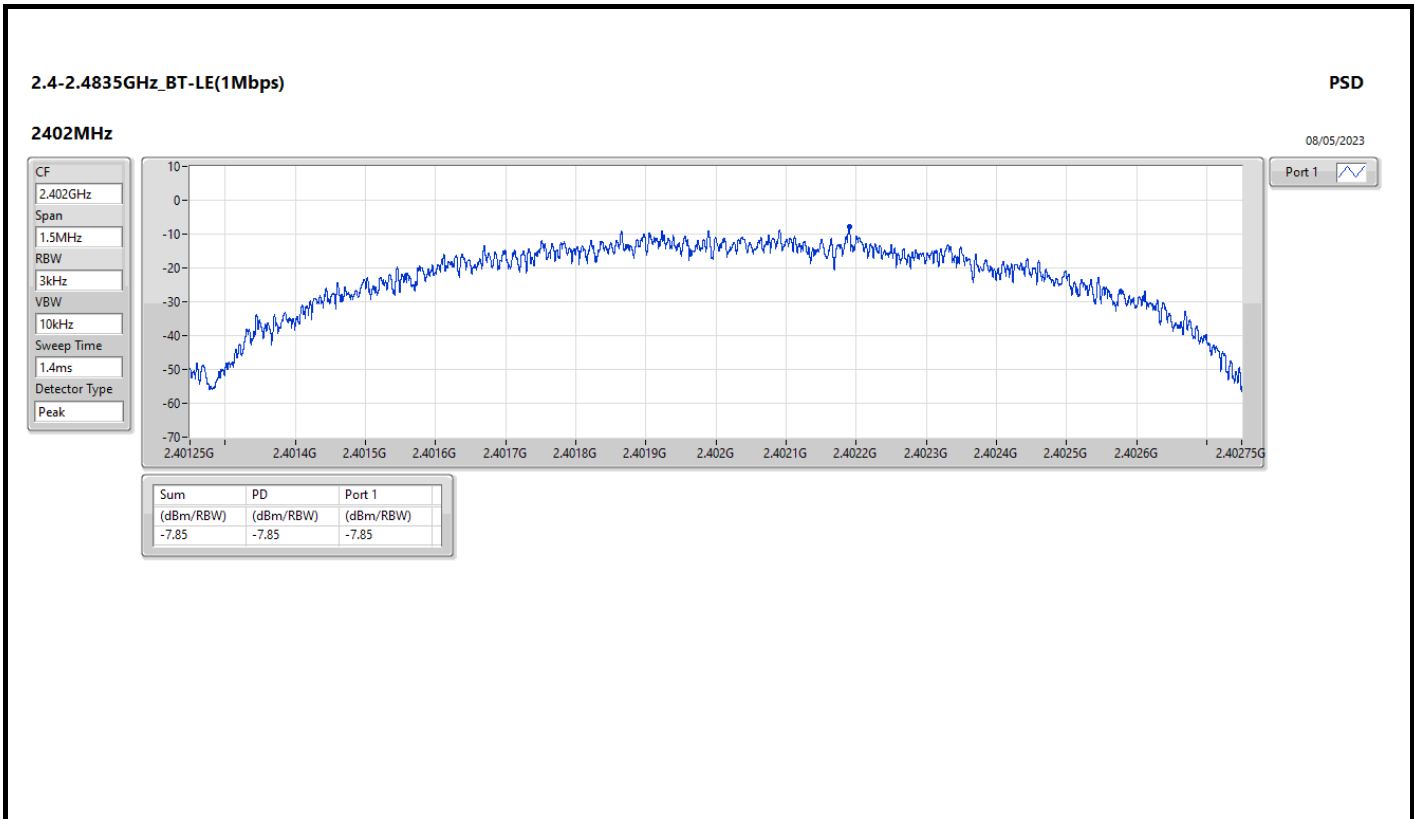

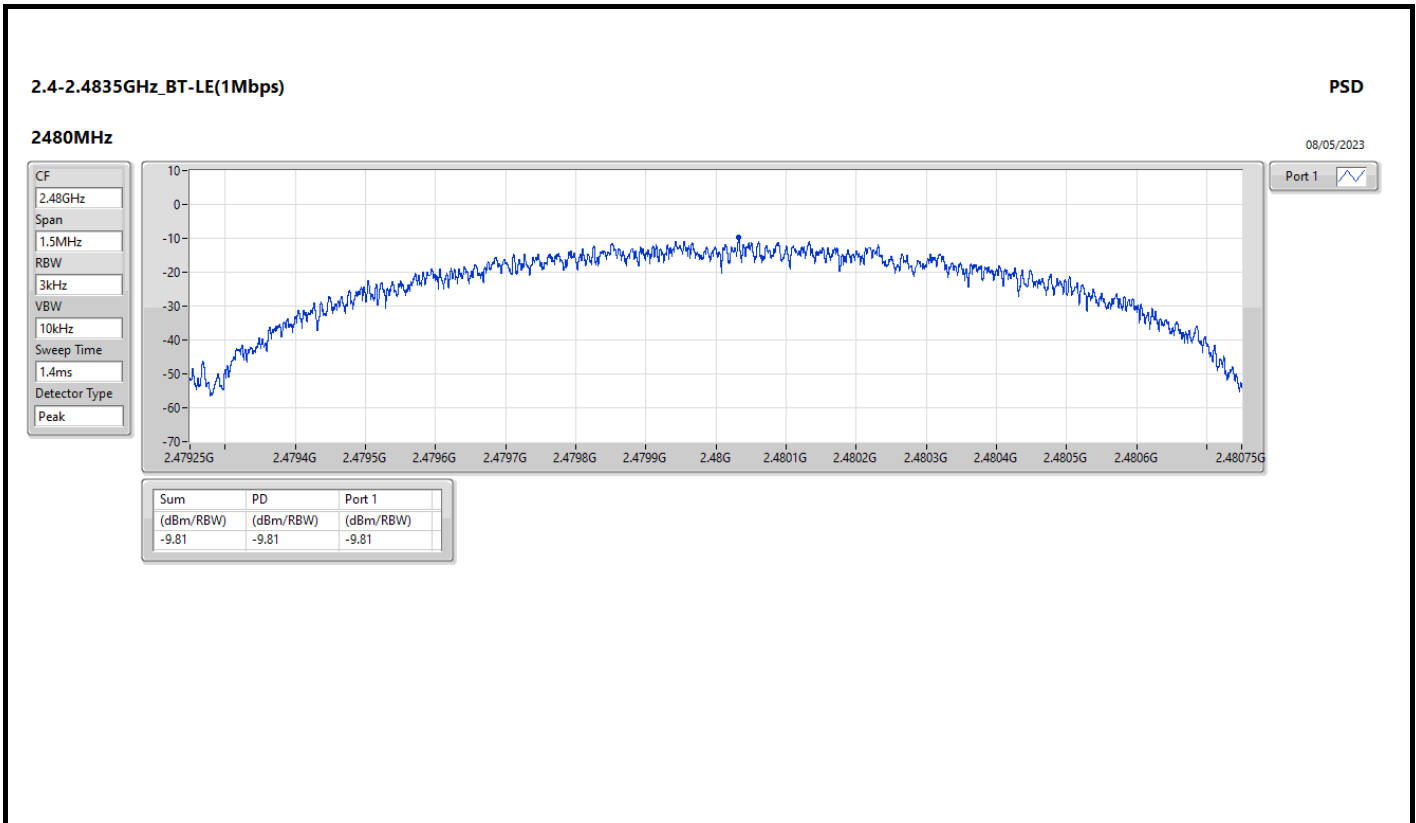



Summary

Mode	Result	Ref (Hz)	Ref (dBm)	Limit (dBm)	Freq (Hz)	Level (dBm)	Freq (Hz)	Level (dBm)	Freq (Hz)	Level (dBm)	Freq (Hz)	Level (dBm)	Freq (Hz)	Level (dBm)	Port
2.4-2.4835GHz	-	-	-	-	-	-	-	-	-	-	-	-	-	-	-
BT-LE(1Mbps)	Pass	2.40167G	4.71	-25.29	2.16968G	-53.29	2.4G	-42.55	2.4G	-42.34	2.5013G	-50.80	21.61428G	-47.05	1



Result

Mode	Result	Ref (Hz)	Ref (dBm)	Limit (dBm)	Freq (Hz)	Level (dBm)	Freq (Hz)	Level (dBm)	Freq (Hz)	Level (dBm)	Freq (Hz)	Level (dBm)	Freq (Hz)	Level (dBm)	Port
BT-LE(1Mbps)	-	-	-	-	-	-	-	-	-	-	-	-	-	-	-
2402MHz	Pass	2.40167G	4.71	-25.29	2.16968G	-53.29	2.4G	-42.55	2.4G	-42.34	2.5013G	-50.80	21.61428G	-47.05	1
2440MHz	Pass	2.40167G	4.71	-25.29	1.86418G	-53.25	2.39772G	-50.46	2.4G	-55.84	2.50118G	-50.18	21.67333G	-47.46	1
2480MHz	Pass	2.40167G	4.71	-25.29	2.07685G	-52.39	2.39712G	-49.84	2.4G	-55.43	2.5025G	-50.86	21.96578G	-47.26	1

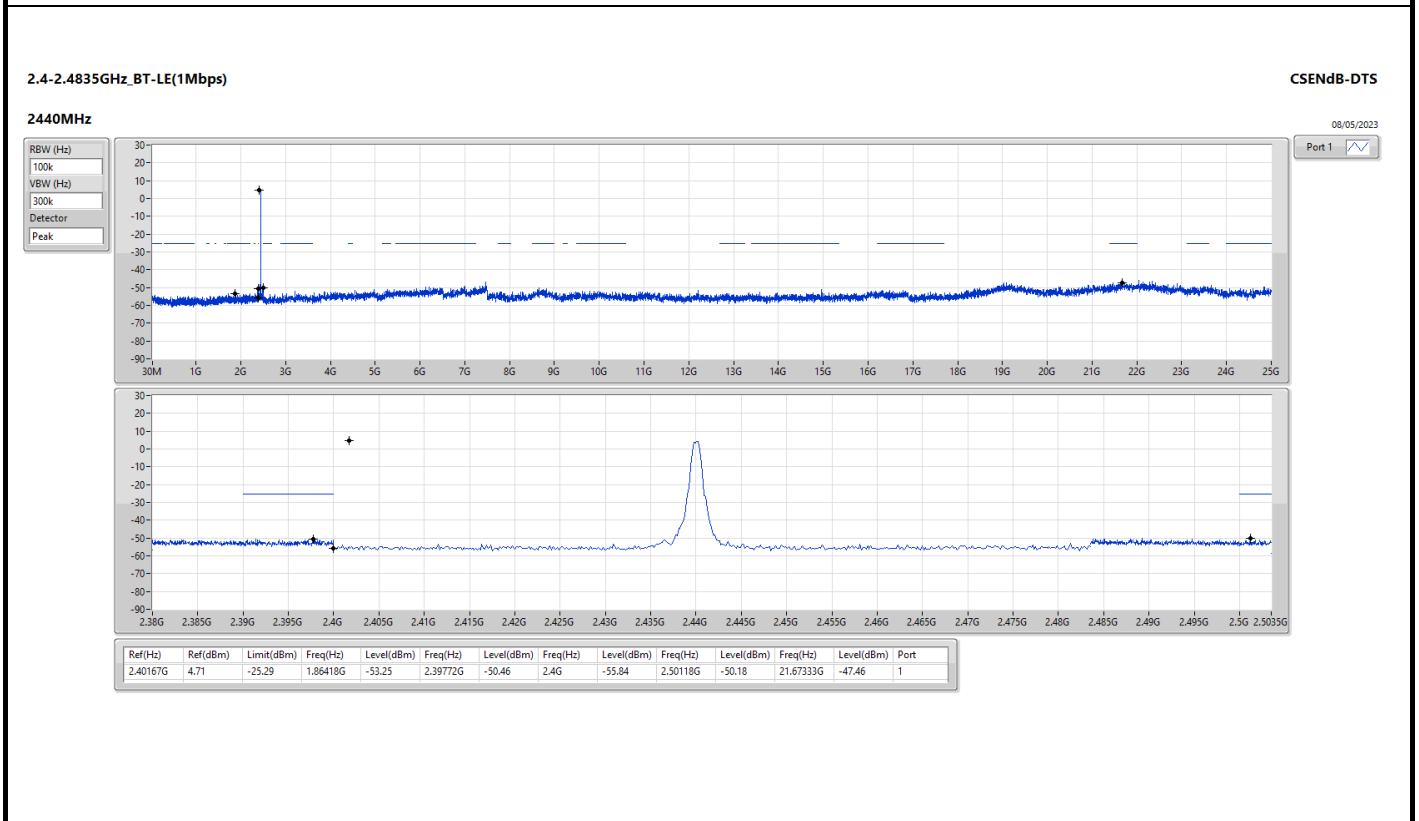
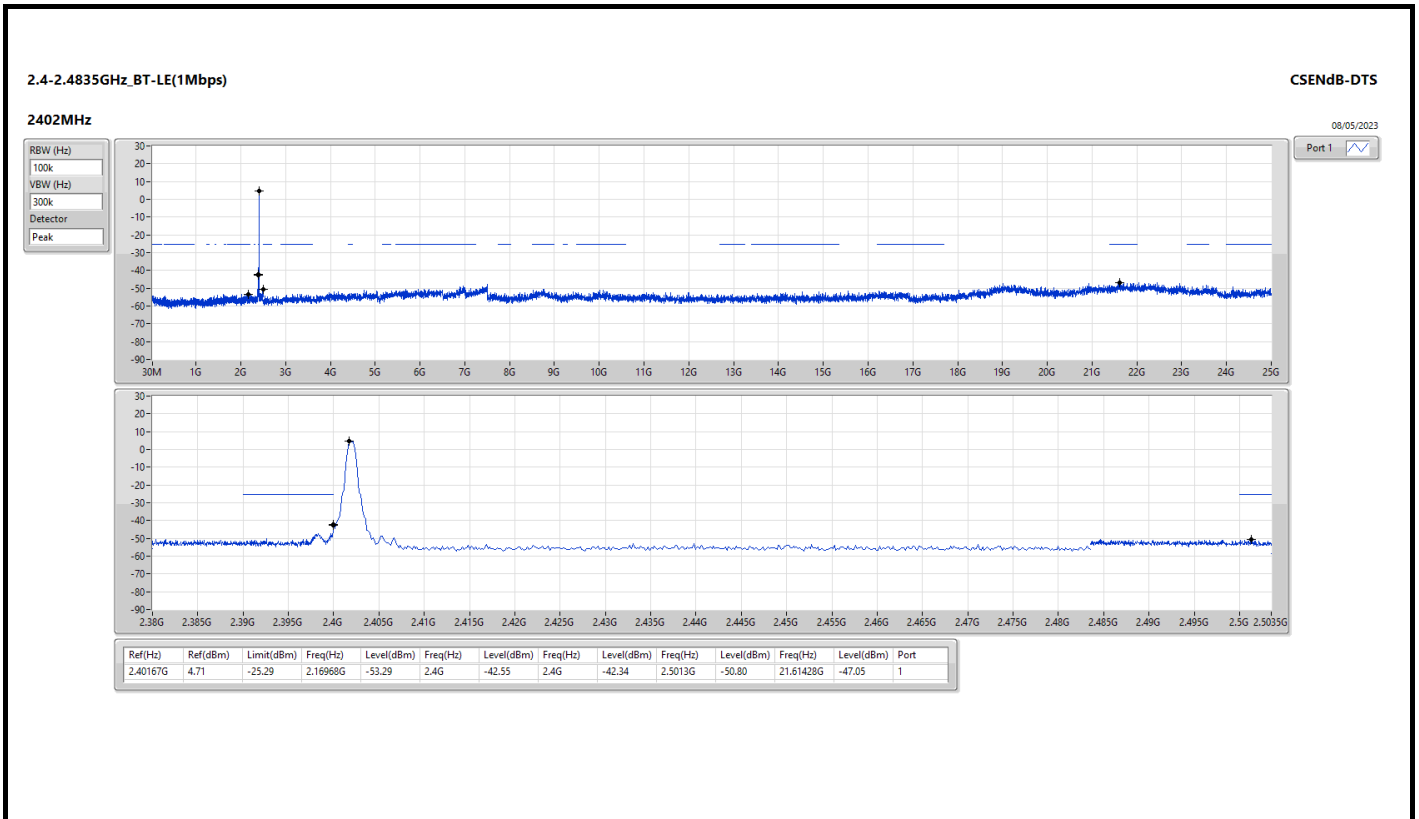

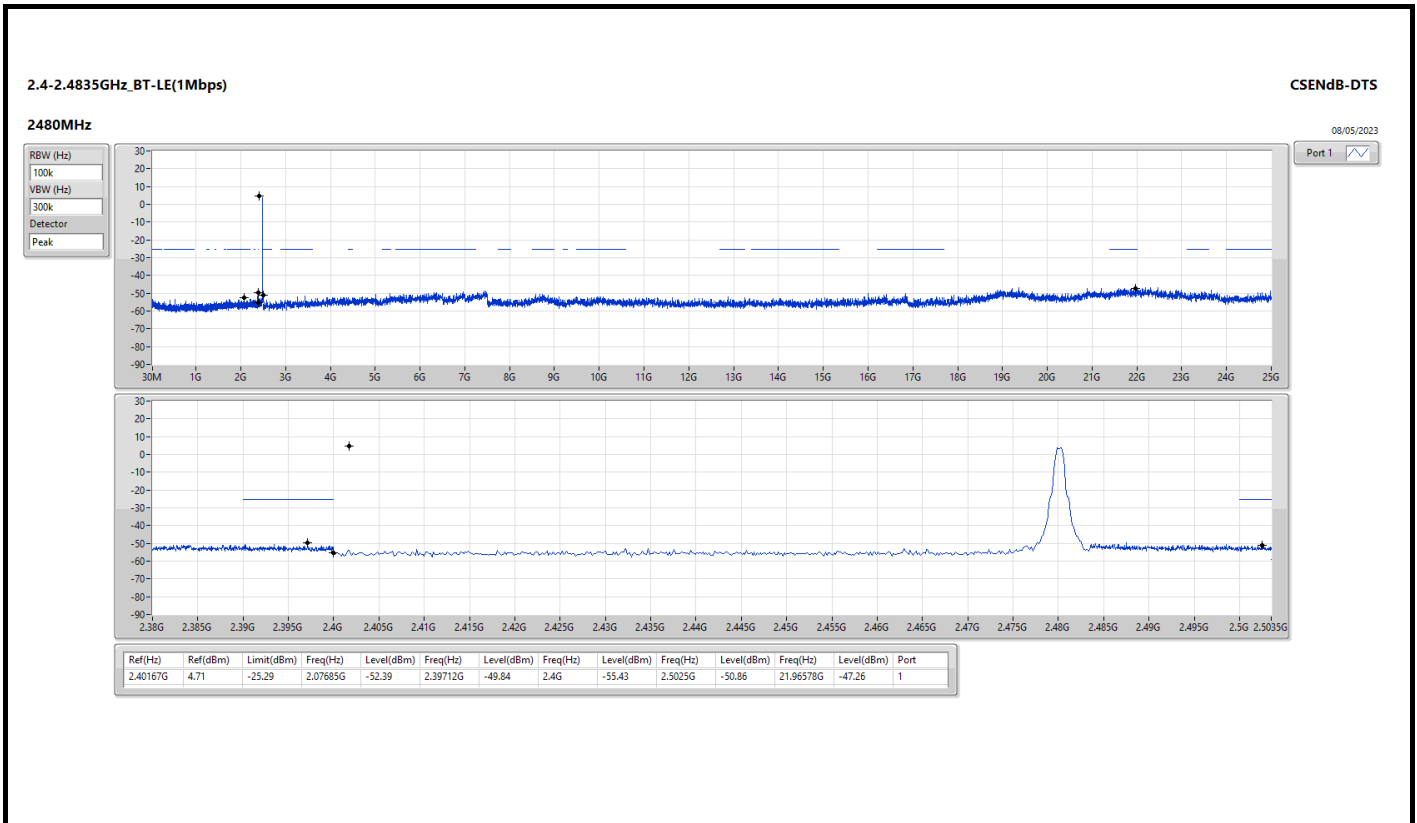



Summary

Mode	Result	Type	Freq (Hz)	Level (dBuV/m)	Limit (dBuV/m)	Margin (dB)	Condition
Mode 1	Pass	PK	35.82M	29.64	40.00	-10.36	Vertical

Mode 1

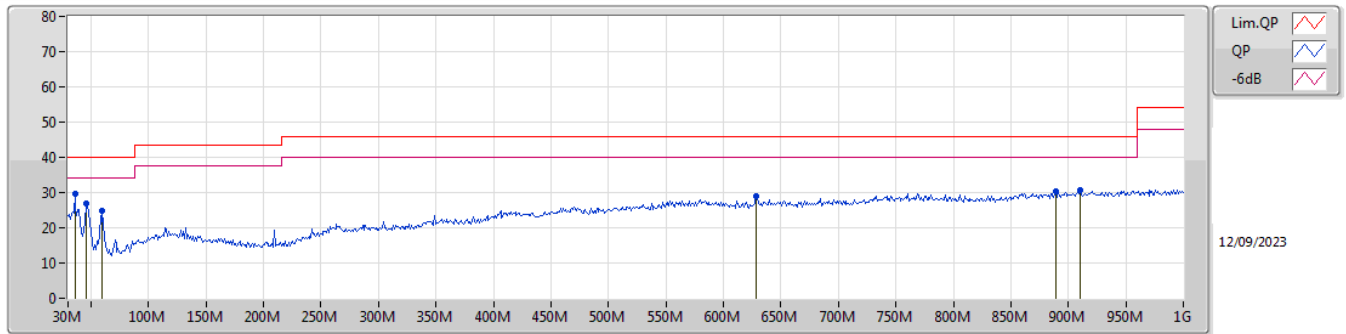

Type	Freq (Hz)	Level (dBuV/m)	Limit (dBuV/m)	Margin (dB)	Factor (dB/m)	Dist (m)	Condition	Azimuth (°)	Height (m)	Comment	Raw (dBuV/m)	AF (dB/m)	CL (dB)	PA (dB)
PK	35.82M	29.64	40.00	-10.36	-9.94	3	Vertical	295	1.00	"Worst"	39.58	21.13	1.00	32.07
PK	45.52M	27.00	40.00	-13.00	-14.63	3	Vertical	357	2.00	-	41.63	16.44	1.10	32.17
PK	60.07M	24.85	40.00	-15.15	-18.57	3	Vertical	138	1.25	-	43.42	12.53	1.10	32.20
PK	628.49M	28.89	46.00	-17.11	-3.29	3	Vertical	277	1.25	-	32.18	25.09	3.41	31.79
PK	889.42M	30.20	46.00	-15.80	-0.51	3	Vertical	289	1.25	-	30.71	26.38	4.16	31.05
PK	910.76M	30.79	46.00	-15.21	-0.16	3	Vertical	150	1.50	-	30.95	26.53	4.22	30.91

Mode 1

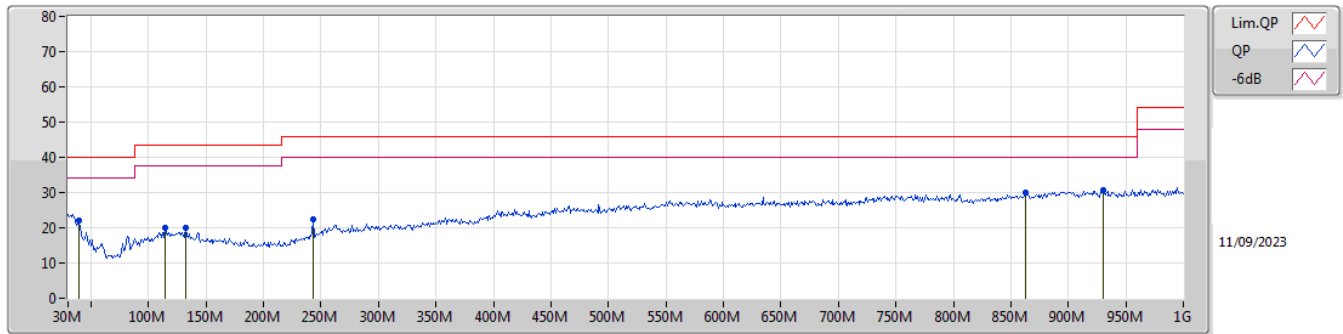

Type	Freq (Hz)	Level (dBuV/m)	Limit (dBuV/m)	Margin (dB)	Factor (dB/m)	Dist (m)	Condition	Azimuth (°)	Height (m)	Comment	Raw (dBuV/m)	AF (dB/m)	CL (dB)	PA (dB)
PK	39.7M	22.10	40.00	-17.90	-11.80	3	Horizontal	268	3.00	-	33.90	19.32	1.00	32.12
PK	114.39M	20.04	43.50	-23.46	-12.57	3	Horizontal	66	2.00	-	32.61	17.93	1.47	31.97
PK	132.82M	20.00	43.50	-23.50	-12.71	3	Horizontal	164	1.25	-	32.71	17.70	1.56	31.97
PK	243.4M	22.41	46.00	-23.59	-12.31	3	Horizontal	146	1.25	-	34.72	17.55	2.07	31.93
PK	863.23M	29.88	46.00	-16.12	-0.86	3	Horizontal	249	1.00	-	30.74	26.20	4.05	31.11
PK	930.16M	30.85	46.00	-15.15	0.00	3	Horizontal	20	3.00	"Worst"	30.85	26.46	4.26	30.72



Summary

Mode	Result	Type	Freq (Hz)	Level (dBuV/m)	Limit (dBuV/m)	Margin (dB)	Dist (m)	Condition	Azimuth (°)	Height (m)	Comments
2.4-2.4835GHz	-	-	-	-	-	-	-	-	-	-	-
BT-LE(1Mbps)	Pass	AV	4.96012G	51.49	54.00	-2.51	3	Horizontal	70	1.80	-

2.4-2.4835GHz_BT-LE(1Mbps)

2402MHz_TX

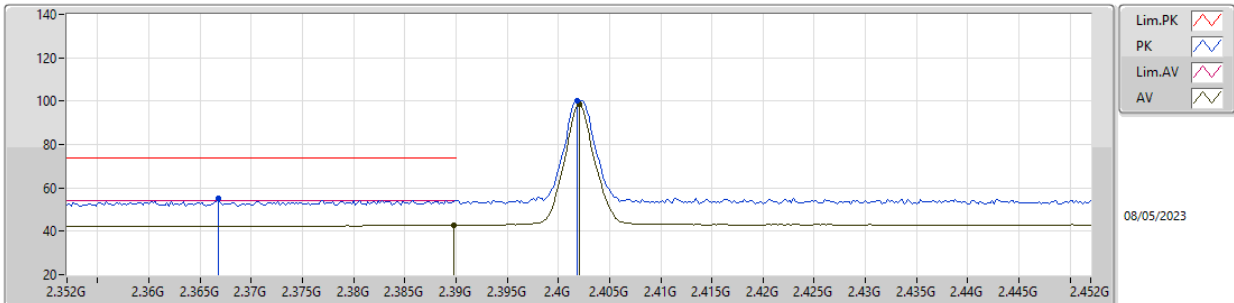

EUT_Y_1TX
Setting 5
04-E-G-4

Type	Freq (Hz)	Level (dBuV/m)	Limit (dBuV/m)	Margin (dB)	Raw (dBuV)	Dist (m)	Condition	Azimuth (°)	Height (m)	Comment	AF (dB)	CL (dB)	PA (dB)
PK	2.3668G	54.96	74.00	-19.04	24.28	3	Vertical	248	1.98	-	27.50	3.18	-
AV	2.3898G	42.75	54.00	-11.25	11.92	3	Vertical	248	1.98	-	27.64	3.19	-
PK	2.4018G	98.51	Inf	-Inf	69.27	3	Vertical	248	1.98	-	27.70	3.20	-
AV	2.402G	98.51	Inf	-Inf	67.61	3	Vertical	248	1.98	-	27.70	3.20	-

2.4-2.4835GHz_BT-LE(1Mbps)

2402MHz_TX

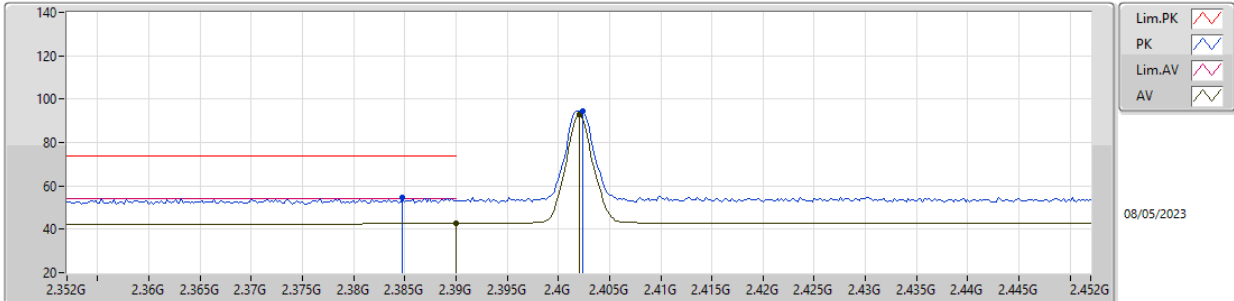

EUT_V_1TX
Setting 5
04-E-G-4

Type	Freq (Hz)	Level (dBuV/m)	Limit (dBuV/m)	Margin (dB)	Raw (dBuV)	Dist (m)	Condition	Azimuth (°)	Height (m)	Comment	AF (dB)	CL (dB)	PA (dB)
PK	2.3848G	54.70	74.00	-19.30	23.90	3	Horizontal	128	2.12	-	27.61	3.19	-
AV	2.39G	42.68	54.00	-11.32	11.84	3	Horizontal	128	2.12	-	27.64	3.20	-
PK	2.4024G	94.60	Inf	-Inf	63.70	3	Horizontal	128	2.12	-	27.70	3.20	-
AV	2.402G	93.01	Inf	-Inf	62.11	3	Horizontal	128	2.12	-	27.70	3.20	-

2.4-2.4835GHz_BT-LE(1Mbps)

2402MHz_TX

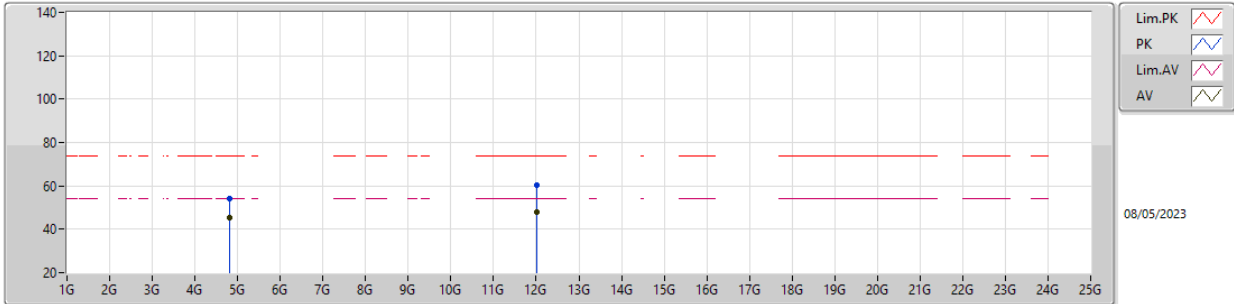





EUT_Y_1TX
Setting 5
04-E-G-4

Type	Freq (Hz)	Level (dBuV/m)	Limit (dBuV/m)	Margin (dB)	Raw (dBuV)	Dist (m)	Condition	Azimuth (°)	Height (m)	Comment	AF (dB)	CL (dB)	PA (dB)
PK	4.80354G	54.05	74.00	-19.95	48.80	3	Vertical	272	1.97	-	32.61	5.30	32.66
AV	4.80406G	45.58	54.00	-8.42	40.33	3	Vertical	272	1.97	-	32.61	5.30	32.66
PK	12.01144G	60.33	74.00	-13.67	47.29	3	Vertical	309	2.60	-	38.80	8.61	34.37
AV	12.009G	47.79	54.00	-6.21	34.77	3	Vertical	309	2.60	-	38.80	8.60	34.38

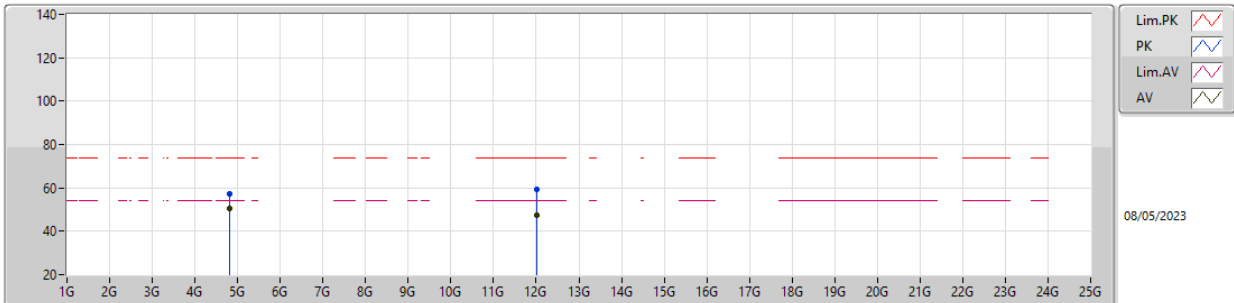
2.4-2.4835GHz_BT-LE(1Mbps)

2402MHz_TX



Lim.PK 
 PK 
 Lim.AV 
 AV 

08/05/2023

EUT_Y_1TX
Setting 5
04-E-G-4

Type	Freq (Hz)	Level (dBuV/m)	Limit (dBuV/m)	Margin (dB)	Raw (dBuV)	Dist (m)	Condition	Azimuth (°)	Height (m)	Comment	AF (dB)	CL (dB)	PA (dB)
PK	4.80362G	57.36	74.00	-16.64	52.11	3	Horizontal	283	1.93	-	32.61	5.30	32.66
AV	4.80404G	50.64	54.00	-3.36	45.39	3	Horizontal	283	1.93	-	32.61	5.30	32.66
PK	12.00874G	59.49	74.00	-14.51	46.47	3	Horizontal	319	1.80	-	38.80	8.60	34.38
AV	12.01112G	47.22	54.00	-6.78	34.18	3	Horizontal	319	1.80	-	38.80	8.61	34.37

2.4-2.4835GHz_BT-LE(1Mbps)

2440MHz_TX

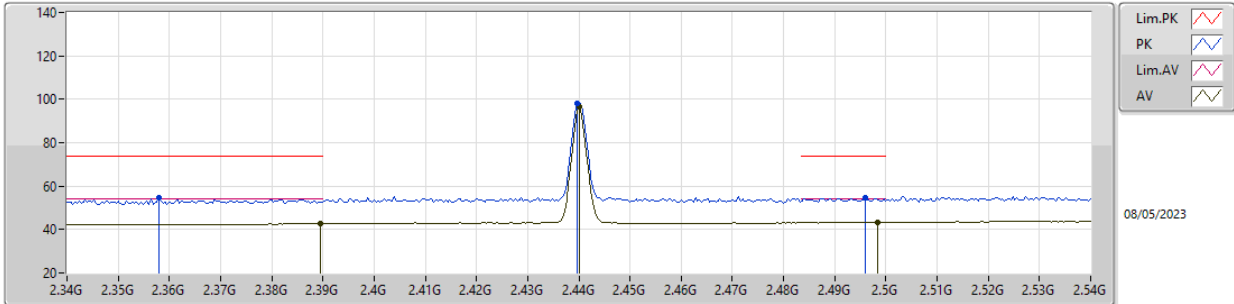

EUT_Y_1TX
Setting 5
04-E-G-4

Type	Freq (Hz)	Level (dBuV/m)	Limit (dBuV/m)	Margin (dB)	Raw (dBuV)	Dist (m)	Condition	Azimuth (°)	Height (m)	Comment	AF (dB)	CL (dB)	PA (dB)
PK	2.358G	54.40	74.00	-19.60	23.77	3	Vertical	276	1.85	-	27.45	3.18	-
AV	2.3896G	42.67	54.00	-11.33	11.84	3	Vertical	276	1.85	-	27.64	3.19	-
PK	2.4396G	98.07	Inf	-Inf	67.13	3	Vertical	276	1.85	-	27.70	3.24	-
AV	2.44G	96.43	Inf	-Inf	65.49	3	Vertical	276	1.85	-	27.70	3.24	-
PK	2.496G	54.44	74.00	-19.56	23.26	3	Vertical	276	1.85	-	27.88	3.30	-
AV	2.4984G	43.30	54.00	-10.70	12.11	3	Vertical	276	1.85	-	27.89	3.30	-

2.4-2.4835GHz_BT-LE(1Mbps)

2440MHz_TX

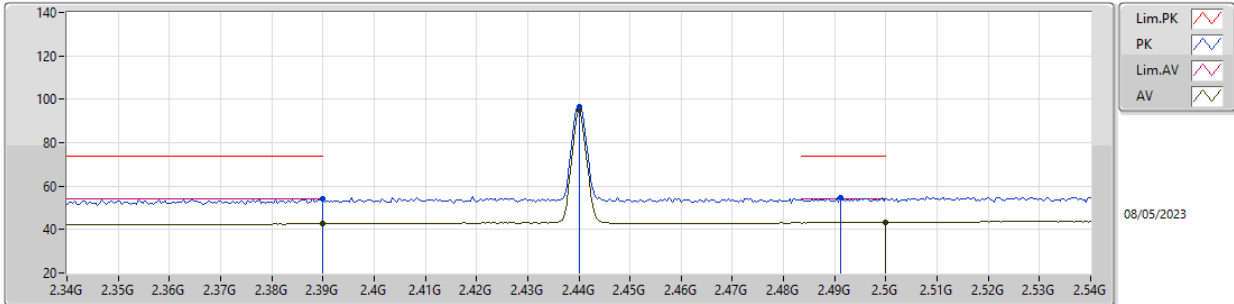

EUT_Y_1TX
Setting 5
04-E-G-4

Type	Freq (Hz)	Level (dBuV/m)	Limit (dBuV/m)	Margin (dB)	Raw (dBuV)	Dist (m)	Condition	Azimuth (°)	Height (m)	Comment	AF (dB)	CL (dB)	PA (dB)
PK	2.39G	54.23	74.00	-19.77	23.39	3	Horizontal	122	1.80	-	27.64	3.20	-
AV	2.39G	42.70	54.00	-11.30	11.86	3	Horizontal	122	1.80	-	27.64	3.20	-
PK	2.44G	96.51	Inf	-Inf	65.57	3	Horizontal	122	1.80	-	27.70	3.24	-
AV	2.44G	94.94	Inf	-Inf	64.00	3	Horizontal	122	1.80	-	27.70	3.24	-
PK	2.4912G	54.55	74.00	-19.45	23.40	3	Horizontal	122	1.80	-	27.86	3.29	-
AV	2.5G	43.33	54.00	-10.67	12.13	3	Horizontal	122	1.80	-	27.90	3.30	-

2.4-2.4835GHz_BT-LE(1Mbps)

2440MHz_TX

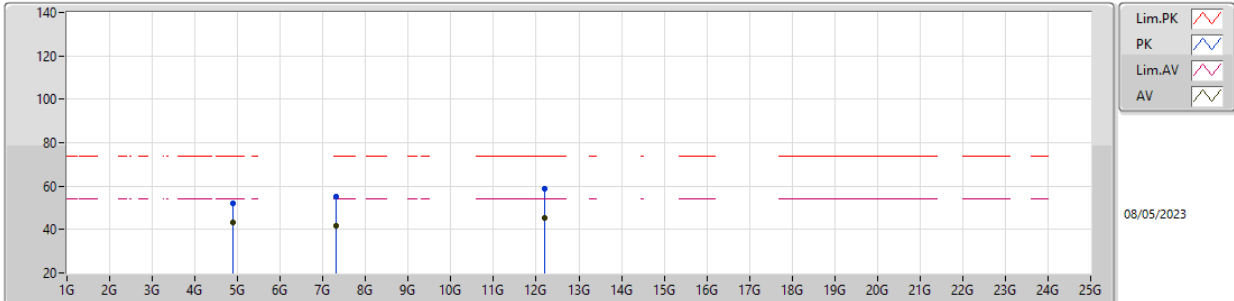

EUT_Y_1TX
Setting 5
04-E-G-4

Type	Freq (Hz)	Level (dBuV/m)	Limit (dBuV/m)	Margin (dB)	Raw (dBuV)	Dist (m)	Condition	Azimuth (°)	Height (m)	Comment	AF (dB)	CL (dB)	PA (dB)
PK	4.88052G	52.31	74.00	-21.69	46.87	3	Vertical	226	2.08	-	32.76	5.30	32.62
AV	4.8801G	43.03	54.00	-10.97	37.59	3	Vertical	226	2.08	-	32.76	5.30	32.62
PK	7.32064G	55.05	74.00	-18.95	43.65	3	Vertical	274	2.45	-	37.70	6.92	33.22
AV	7.31946G	41.69	54.00	-12.31	30.29	3	Vertical	274	2.45	-	37.70	6.92	33.22
PK	12.19904G	58.72	74.00	-15.28	45.71	3	Vertical	304	1.86	-	38.60	8.70	34.29
AV	12.19908G	45.51	54.00	-8.49	32.50	3	Vertical	304	1.86	-	38.60	8.70	34.29

2.4-2.4835GHz_BT-LE(1Mbps)

2440MHz_TX

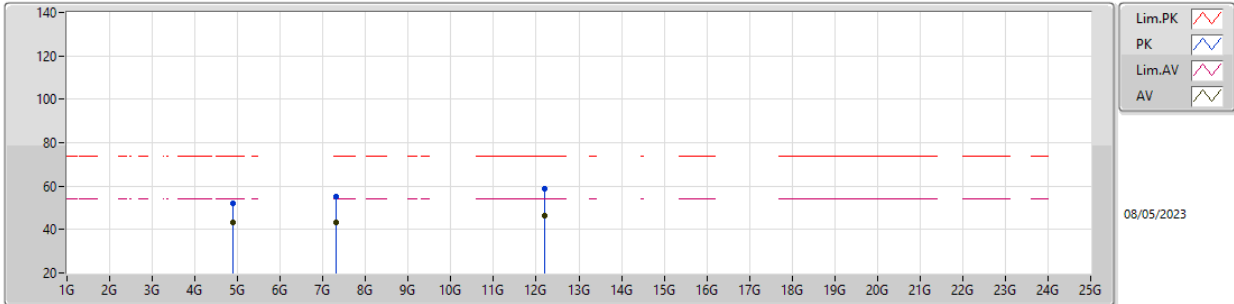

EUT_Y_1TX
Setting 5
04-E-G-4

Type	Freq (Hz)	Level (dBuV/m)	Limit (dBuV/m)	Margin (dB)	Raw (dBuV)	Dist (m)	Condition	Azimuth (°)	Height (m)	Comment	AF (dB)	CL (dB)	PA (dB)
PK	4.87938G	52.12	74.00	-21.88	46.68	3	Horizontal	254	1.80	-	32.76	5.30	32.62
AV	4.88006G	43.14	54.00	-10.86	37.70	3	Horizontal	254	1.80	-	32.76	5.30	32.62
PK	7.31944G	55.02	74.00	-18.98	43.62	3	Horizontal	153	2.33	-	37.70	6.92	33.22
AV	7.31942G	43.17	54.00	-10.83	31.77	3	Horizontal	153	2.33	-	37.70	6.92	33.22
PK	12.19906G	58.67	74.00	-15.33	45.66	3	Horizontal	308	1.81	-	38.60	8.70	34.29
AV	12.19902G	46.36	54.00	-7.64	33.35	3	Horizontal	308	1.81	-	38.60	8.70	34.29

2.4-2.4835GHz_BT-LE(1Mbps)

2480MHz_TX

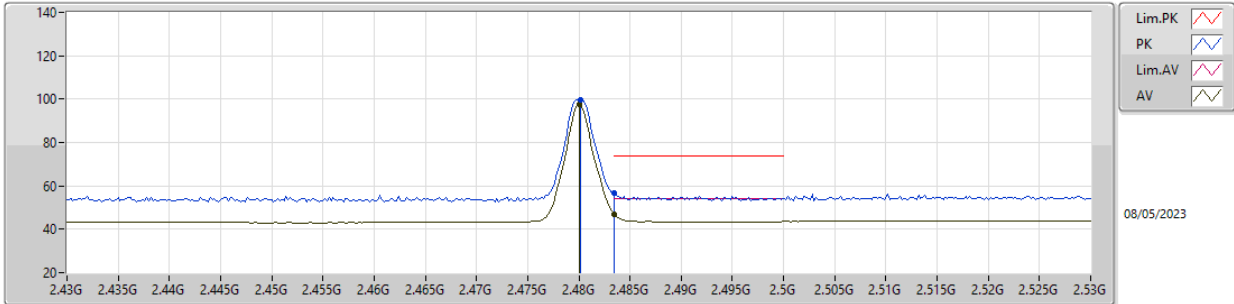

EUT_Y_1TX
Setting 5
04-E-G-4

Type	Freq (Hz)	Level (dBuV/m)	Limit (dBuV/m)	Margin (dB)	Raw (dBuV)	Dist (m)	Condition	Azimuth (°)	Height (m)	Comment	AF (dB)	CL (dB)	PA (dB)
PK	2.4802G	99.56	Inf	-Inf	68.46	3	Vertical	265	2.08	-	27.82	3.28	-
AV	2.48G	97.84	Inf	-Inf	66.74	3	Vertical	265	2.08	-	27.82	3.28	-
PK	2.4835G	56.62	74.00	-17.38	25.51	3	Vertical	265	2.08	-	27.83	3.28	-
AV	2.4835G	47.15	54.00	-6.85	16.04	3	Vertical	265	2.08	-	27.83	3.28	-

2.4-2.4835GHz_BT-LE(1Mbps)

2480MHz_TX

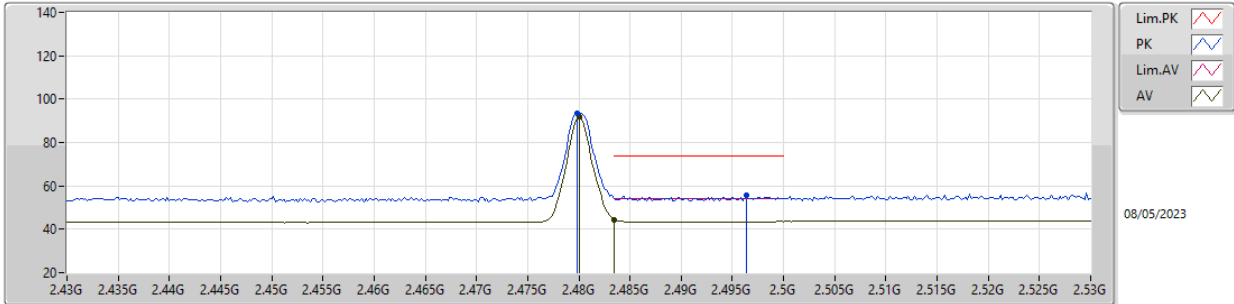

EUT_Y_1TX
Setting 5
04-E-G-4

Type	Freq (Hz)	Level (dBuV/m)	Limit (dBuV/m)	Margin (dB)	Raw (dBuV)	Dist (m)	Condition	Azimuth (°)	Height (m)	Comment	AF (dB)	CL (dB)	PA (dB)
PK	2.4798G	93.25	Inf	-Inf	62.15	3	Horizontal	125	2.49	-	27.82	3.28	-
AV	2.48G	91.64	Inf	-Inf	60.54	3	Horizontal	125	2.49	-	27.82	3.28	-
PK	2.4964G	55.66	74.00	-18.34	24.47	3	Horizontal	125	2.49	-	27.89	3.30	-
AV	2.4835G	44.52	54.00	-9.48	13.41	3	Horizontal	125	2.49	-	27.83	3.28	-

2.4-2.4835GHz_BT-LE(1Mbps)

2480MHz_TX

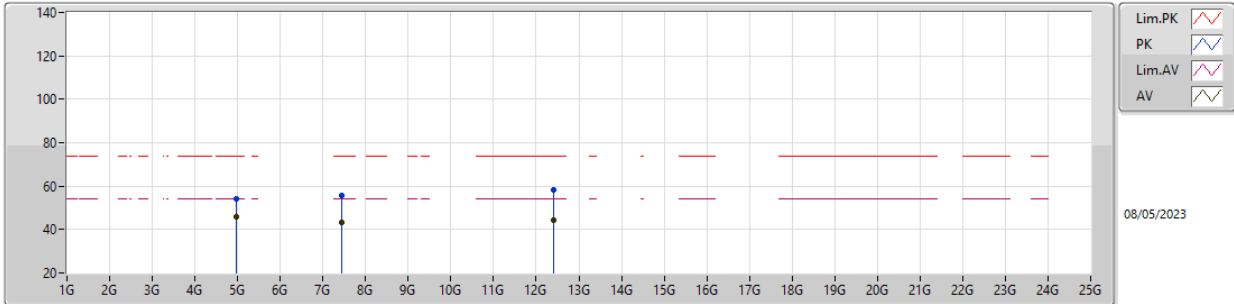

EUT_Y_1TX
Setting 5
04-E-G-4

Type	Freq (Hz)	Level (dBuV/m)	Limit (dBuV/m)	Margin (dB)	Raw (dBuV)	Dist (m)	Condition	Azimuth (°)	Height (m)	Comment	AF (dB)	CL (dB)	PA (dB)
PK	4.9605G	54.23	74.00	-19.77	48.59	3	Vertical	197	2.68	-	32.92	5.30	32.58
AV	4.96002G	46.06	54.00	-7.94	40.42	3	Vertical	197	2.68	-	32.92	5.30	32.58
PK	7.44076G	55.83	74.00	-18.17	44.65	3	Vertical	257	2.87	-	37.42	7.02	33.26
AV	7.43944G	43.11	54.00	-10.89	31.93	3	Vertical	257	2.87	-	37.42	7.02	33.26
PK	12.3987G	58.10	74.00	-15.90	44.70	3	Vertical	310	1.91	-	38.80	8.80	34.20
AV	12.40122G	44.46	54.00	-9.54	31.06	3	Vertical	310	1.91	-	38.80	8.80	34.20

2.4-2.4835GHz_BT-LE(1Mbps)

2480MHz_TX

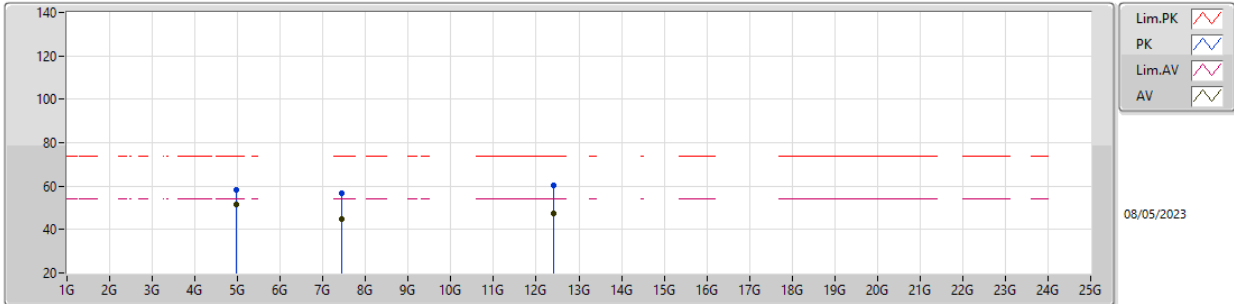

EUT_Y_1TX
Setting 5
04-E-G-4

Type	Freq (Hz)	Level (dBuV/m)	Limit (dBuV/m)	Margin (dB)	Raw (dBuV)	Dist (m)	Condition	Azimuth (°)	Height (m)	Comment	AF (dB)	CL (dB)	PA (dB)
PK	4.96056G	58.44	74.00	-15.56	52.80	3	Horizontal	70	1.80	-	32.92	5.30	32.58
AV	4.96012G	51.49	54.00	-2.51	45.85	3	Horizontal	70	1.80	-	32.92	5.30	32.58
PK	7.43946G	56.94	74.00	-17.06	45.76	3	Horizontal	234	2.26	-	37.42	7.02	33.26
AV	7.4406G	44.66	54.00	-9.34	33.48	3	Horizontal	234	2.26	-	37.42	7.02	33.26
PK	12.39876G	60.53	74.00	-13.47	47.13	3	Horizontal	290	1.79	-	38.80	8.80	34.20
AV	12.399G	47.18	54.00	-6.82	33.78	3	Horizontal	290	1.79	-	38.80	8.80	34.20