



FCC Test Report

FCC ID: 2AI56-PX347CPRIME

Product: LED Monitor
Trade Mark: Pixio
Model Number: PX347c Prime
Serial Model: NB34C
Report No.: NTEK- 2017NT05033049F

Prepared for

HKC Corporation Limited
Building 1, 2, 3, Huike Industrial Park, Mingying Industrial Zone, ShuiTian, ShiYan,
Baoan, Shenzhen, China

Prepared by

Shenzhen NTEK Testing Technology Co., Ltd.
1/F, Building E, Fenda Science Park, Sanwei Community,
Xixiang Street Bao'an District, Shenzhen 518126 P.R. China
Tel.: +86-755-6115 9388
Fax.: +86-755-6115 6599
Website:<http://www.ntek.org.cn>

TEST RESULT CERTIFICATION

Applicant's name : HKC Corporation Limited
 Address : Building 1, 2, 3, Huike Industrial Park, Mingying Industrial Zone, ShuiTian, ShiYan, Baoan, Shenzhen, China

Manufacturer's Name : Chongqing Huikejinyang Technology Co.,Ltd
 Address : 1-1, Building 3, No.16, Shigui Dadao, Jieshi Town, Ba'nan District, Chongqing City 401320

Product description

Product name..... : LED Monitor
 Model and/or type reference : PX347c Prime
 FCC Part15B:01 Oct.2016
Standards..... : ANSI C63.4:2014

This device described above has been tested by NTEK, and the test results show that the equipment under test (EUT) is in compliance with Part 15 of FCC Rules. And it is applicable only to the tested sample identified in the report.

This report shall not be reproduced except in full, without the written approval of NTEK, this document may be altered or revised by NTEK, personnel only, and shall be noted in the revision of the document.

Date of Test :
 Date (s) of performance of tests..... : 03 May 2017 ~11 May 2017
 Date of Issue..... : 11 May. 2017
 Test Result..... : **Pass**

Testing Engineer : _____
Lake Xie
 (Lake Xie)

Technical Manager : _____
Jason Chen
 (Jason Chen)

Authorized Signatory : _____
Sam Chen
 (Sam Chen)

Table of Contents	Page
1 . TEST SUMMARY	4
1.1 TEST FACILITY	5
1.2 MEASUREMENT UNCERTAINTY	5
2 . GENERAL INFORMATION	6
2.1 GENERAL DESCRIPTION OF EUT	6
2.2 DESCRIPTION OF TEST SETUP	8
2.3 DESCRIPTION TEST PERIPHERAL AND EUT PERIPHERAL	9
2.4 MEASUREMENT INSTRUMENTS LIST	10
3 . EMC EMISSION TEST	11
3.1 CONDUCTED EMISSION MEASUREMENT	11
3.1.1 POWER LINE CONDUCTED EMISSION	11
3.1.2 TEST PROCEDURE	12
3.1.3 TEST SETUP	12
3.1.4 EUT OPERATING CONDITIONS	12
3.1.5 TEST RESULTS	13
3.2 RADIATED EMISSION MEASUREMENT	25
3.2.1 LIMITS OF RADIATED EMISSION MEASUREMENT	25
3.2.2 TEST PROCEDURE	25
3.2.3 TEST SETUP	26
3.2.4 TEST RESULTS	27
3.2.5 TEST RESULTS(1000~6000MHz)	33
4 . EUT TEST PHOTO	36

1. TEST SUMMARY

Test procedures according to the technical standards:

EMC Emission				
Standard	Test Item	Limit	Judgment	Remark
FCC Part15B:2016 ANSI C63.4: 2014	Conducted Emission	Class B	PASS	
	Radiated Emission	Class B	PASS	

NOTE:

- (1) 'N/A' denotes test is not applicable in this Test Report
- (2) For client's request and manual description, the test will not be executed.

1.1 TEST FACILITY

Shenzhen NTEK Testing Technology Co., Ltd
 Add. : 1/F, Building E, Fenda Science Park, Sanwei Community, Xixiang Street, Bao'an District, Shenzhen 518126 P.R. China.
 FCC Registration Number:238937; IC Registration Number:9270A-1
 CNAS Registration Number:L5516

1.2 MEASUREMENT UNCERTAINTY

The reported uncertainty of measurement $y \pm U$, where expanded uncertainty U is based on a standard uncertainty multiplied by a coverage factor of $k=2$, providing a level of confidence of approximately **95 %**.

A. Conducted Measurement :

Test Site	Method	Measurement Frequency Range	U, (dB)	NOTE
NTEKC01	ANSI	150 KHz ~ 30MHz	3.2	

B. Radiated Measurement :

Test Site	Method	Measurement Frequency Range	U, (dB)	NOTE
NTEKA01	ANSI	30MHz ~ 1000MHz	4.7	
		1GHz ~12.4GHz	5.0	

2. GENERAL INFORMATION

2.1 GENERAL DESCRIPTION OF EUT

Equipment	LED Monitor	
Trade Mark	Pixio	
Model Name	PX347c Prime	
Serial Model	NB34C	
Model difference	All the model are the same circuit and RF module, except the model No. and colour.	
Product Description	The EUT is a LED Monitor.	
	Connecting I/O port:	DP, HDMI, DVI
	Operation the highest Frequency:	165MHz
	Modulation Type:	N/A
Power Source	AC Voltage	
Power Rating	AC 100-240V 50/60Hz 1.3A	
Adapter	N/A	
Battery	N/A	
HW Version	A1.1	
SW Version	N/A	

2.1.1 DESCRIPTION OF TEST MODES

To investigate the maximum EMI emission characteristics generates from EUT, the test system was pre-scanning tested base on the consideration of following EUT operation mode or test configuration mode which possible have effect on EMI emission level. Each of these EUT operation mode(s) or test configuration mode(s) mentioned above was evaluated respectively.

Pretest Mode	Description
Mode 1	DP(H,M,L)
Mode 2	DVI(H,M,L)
Mode 3	HDMI(H,M,L)

For Conducted Test	
Final Test Mode	Description
Mode 1	DP(H,M,L)
Mode 2	DVI(H,M,L)
Mode 3	HDMI(H,M,L)

For Radiated Test	
Final Test Mode	Description
Mode 1	DP(H,M,L)
Mode 2	DVI(H,M,L)
Mode 3	HDMI(H,M,L)

Note: Final Test Mode: Through Pre-scan, find the mode 3 is the worst case.

Only the worst case mode is recorded in the report.

H is stand for high resolution, M is stand for middle resolution, L is stand for Low resolution.

2.2 DESCRIPTION OF TEST SETUP

CE

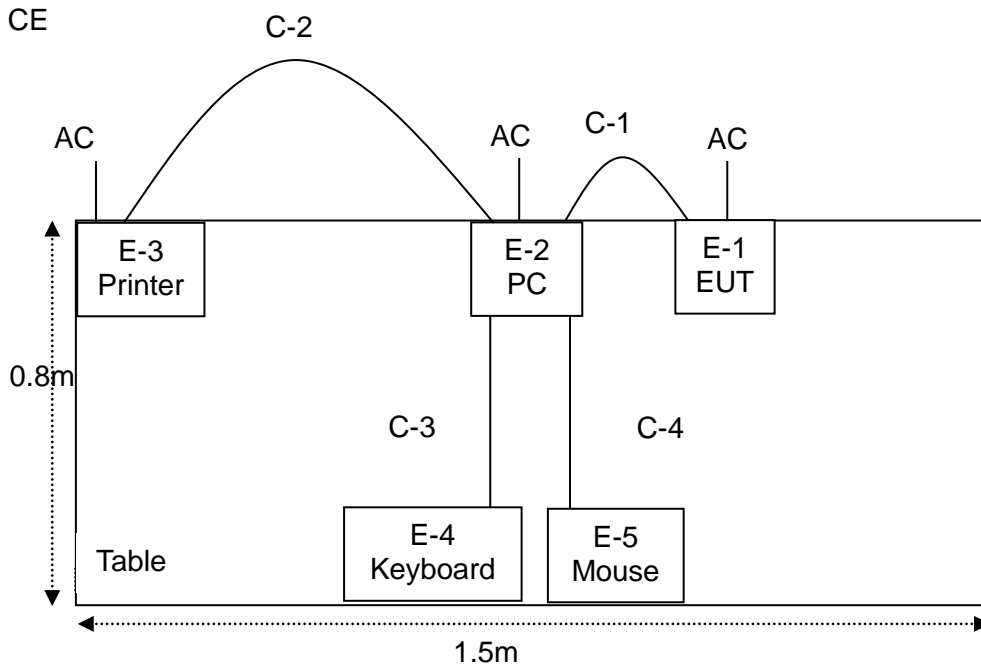

RE

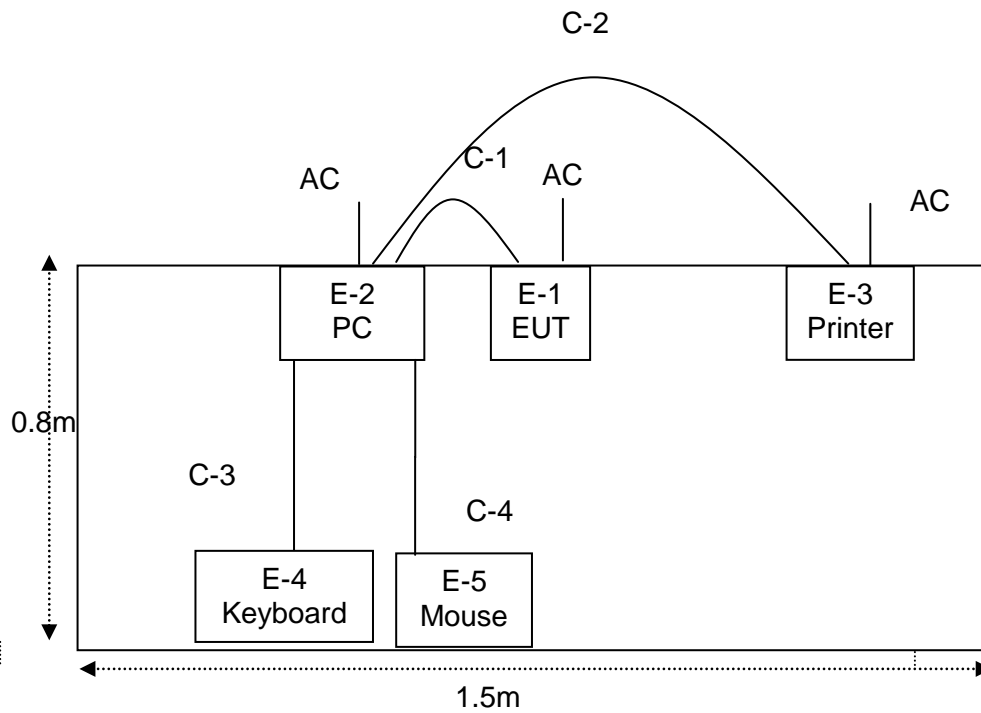

2.3 DESCRIPTION TEST PERIPHERAL AND EUT PERIPHERAL

The EUT has been tested as an independent unit together with other necessary accessories or support units. The following support units or accessories were used to form a representative test configuration during the tests.

Item	Equipment	Brand	Model/Type No.	Series No.	Note
E-1	LED Monitor	Pixio	PX347c Prime	N/A	EUT
E-2	Personal computer	DELL	FT4Y23X	N/A	
E-3	Printer	Canon	L11121E	N/A	
E-4	Keyboard	DELL	SK-8185	N/A	
E-5	Mouse	DELL	MS111-P	N/A	

Item	Cable Type	Shielded Type	Ferrite Core	Length	Note
C-1	HDMI	NO	NO	0.8m	
C-2	USB Cable	NO	NO	1.5m	
C-3	Keyboard Cable	NO	NO	1.2m	
C-4	Mouse Cable	NO	NO	1.2m	

Note:

- (1) The support equipment was authorized by Declaration of Confirmation.
- (2) For detachable type I/O cable should be specified the length in cm in 『Length』 column.
- (3) “YES” means “shielded” “with core”; “NO” means “unshielded” “without core”.

2.4 MEASUREMENT INSTRUMENTS LIST

Radiation Test equipment

Item	Kind of Equipment	Manufacturer	Type No.	Serial No.	Last calibration	Calibrated until	Calibration period
1	Spectrum Analyzer	Agilent	E4407B	MY45108040	2016.07.06	2017.07.05	1 year
2	Test Receiver	R&S	ESPI	101318	2016.06.07	2017.06.06	1 year
3	Bilog Antenna	TESEQ	CBL6111D	31216	2016.07.06	2017.07.05	1 year
4	50Ω Coaxial Switch	Anritsu	MP59B	6200264416	2016.06.07	2017.06.06	1 year
5	Spectrum Analyzer	ADVANTEST	R3132	150900201	2016.06.07	2017.06.06	1 year
6	Horn Antenna	EM	EM-AH-10180	2011071402	2016.07.06	2017.07.05	1 year
7	Horn Ant	Schwarzbeck	BBHA 9170	9170-181	2016.07.06	2017.07.05	1 year
8	Amplifier	EM	EM-30180	060538	2016.07.06	2017.07.05	1 year
9	Loop Antenna	ARA	PLA-1030/B	1029	2016.06.08	2017.06.07	1 year
10	Power Meter	R&S	NRVS	100696	2016.07.06	2017.07.05	1 year
11	Power Sensor	R&S	URV5-Z4	0395.1619.05	2016.07.06	2017.07.05	1 year
12	Test Cable	N/A	R-01	N/A	2016.07.06	2017.07.05	1 year
13	Test Cable	N/A	R-02	N/A	2016.07.06	2017.07.05	1 year

Conduction Test equipment

Item	Kind of Equipment	Manufacturer	Type No.	Serial No.	Last calibration	Calibrated until	Calibration period
1	Test Receiver	R&S	ESCI	101160	2016.06.06	2017.06.05	1 year
2	LISN	R&S	ENV216	101313	2016.08.24	2017.08.23	1 year
3	LISN	EMCO	3816/2	00042990	2016.08.24	2017.08.23	1 year
4	50Ω Coaxial Switch	Anritsu	MP59B	6200264417	2016.06.07	2017.06.06	1 year
5	Passive Voltage Probe	R&S	ESH2-Z3	100196	2016.06.07	2017.06.06	1 year
6	Absorbing clamp	R&S	MOS-21	100423	2016.06.08	2017.06.07	1 year
7	Test Cable	N/A	C01	N/A	2016.06.08	2017.06.07	1 year
8	Test Cable	N/A	C02	N/A	2016.06.08	2017.06.07	1 year
9	Test Cable	N/A	C03	N/A	2016.06.08	2017.06.07	1 year

3. EMC EMISSION TEST

3.1 CONDUCTED EMISSION MEASUREMENT

3.1.1 POWER LINE CONDUCTED EMISSION (Frequency Range 150KHz-30MHz)

FREQUENCY (MHz)	Class A (dBuV)		Class B (dBuV)	
	Quasi-peak	Average	Quasi-peak	Average
0.15 -0.5	79.00	66.00	66 - 56 *	56 - 46 *
0.50 -5.0	73.00	60.00	56.00	46.00
5.0 -30.0	73.00	60.00	60.00	50.00

Note:

- (1) The tighter limit applies at the band edges.
- (2) The limit of " * " marked band means the limitation decreases linearly with the logarithm of the frequency in the range.

The following table is the setting of the receiver

Receiver Parameters	Setting
Attenuation	10 dB
Start Frequency	0.15 MHz
Stop Frequency	30 MHz
IF Bandwidth	9 kHz

3.1.2 TEST PROCEDURE

- a. The EUT was placed 0.8 meters from the horizontal ground plane with EUT being connected to the power mains through a line impedance stabilization network (LISN). All other support equipments powered from additional LISN(s). The LISN provide 50 Ohm/ 50uH of coupling impedance for the measuring instrument.
- b. Interconnecting cables that hang closer than 40 cm to the ground plane shall be folded back and forth in the center forming a bundle 30 to 40 cm long.
- c. I/O cables that are not connected to a peripheral shall be bundled in the center. The end of the cable may be terminated, if required, using the correct terminating impedance. The overall length shall not exceed 1 m.
- d. LISN at least 80 cm from nearest part of EUT chassis.
- e. For the actual test configuration, please refer to the related Item –EUT Test Photos.

3.1.3 TEST SETUP

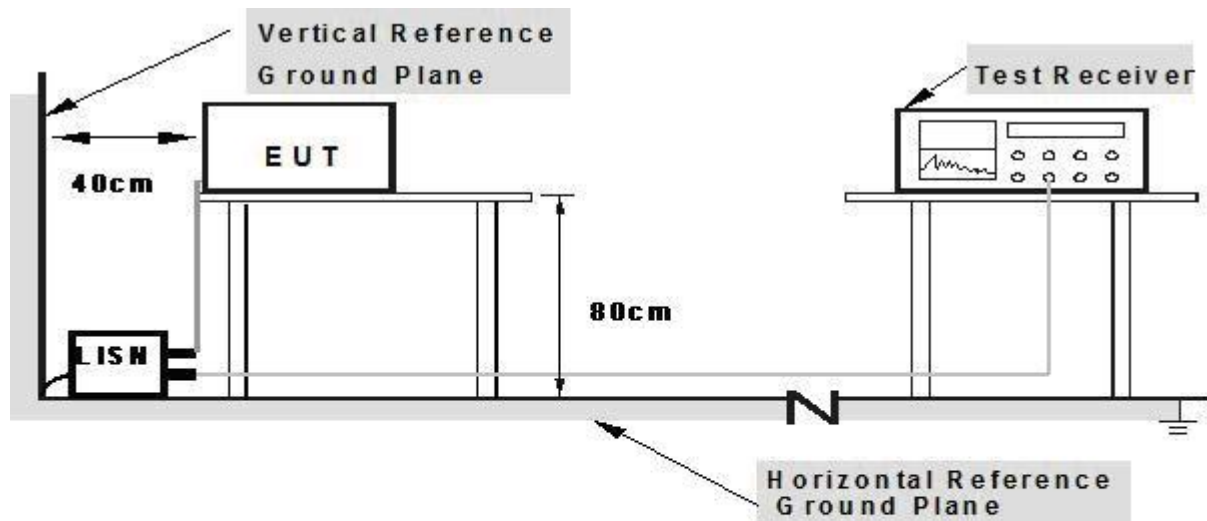

Note: 1. Support units were connected to second LISN.

2. Both of LISNs (AMN) are 80 cm from EUT and at least 80 cm from other units and other metal planes

3.1.4 EUT OPERATING CONDITIONS

The EUT tested system was configured as the statements of 2.3 Unless otherwise a special operating condition is specified in the follows during the testing.

3.1.5 TEST RESULTS

EUT:	LED Monitor	Model Name. :	PX347c Prime
Temperature:	26 °C	Relative Humidity:	54%
Pressure:	1010hPa	Test Date:	2017-5-3
Test Mode:	Mode 3(H)	Phase :	L
Test Voltage:	AC 120V/60Hz		

Frequency (MHz)	Reading Level (dBμV)	Correct Factor (dB)	Measure-ment (dBμV)	Limits (dBμV)	Margin (dB)	Remark
0.1785	51.06	10.14	61.20	64.55	-3.35	QP
0.1785	31.32	10.14	41.46	54.55	-13.09	AVG
0.2519	46.68	10.12	56.80	61.69	-4.89	QP
0.2519	27.75	10.12	37.87	51.69	-13.82	AVG
0.3034	41.38	10.12	51.50	60.15	-8.65	QP
0.3034	21.58	10.12	31.70	50.15	-18.45	AVG
0.4102	33.35	10.15	43.50	57.64	-14.14	QP
0.4102	14.30	10.15	24.45	47.64	-23.19	AVG
0.7137	26.70	10.20	36.90	56.00	-19.10	QP
0.7137	12.41	10.20	22.61	46.00	-23.39	AVG
4.6379	30.02	10.24	40.26	56.00	-15.74	QP
4.6379	17.55	10.24	27.79	46.00	-18.21	AVG

Remark:

1. All readings are Quasi-Peak and Average values.
2. Factor = Insertion Loss + Cable Loss.

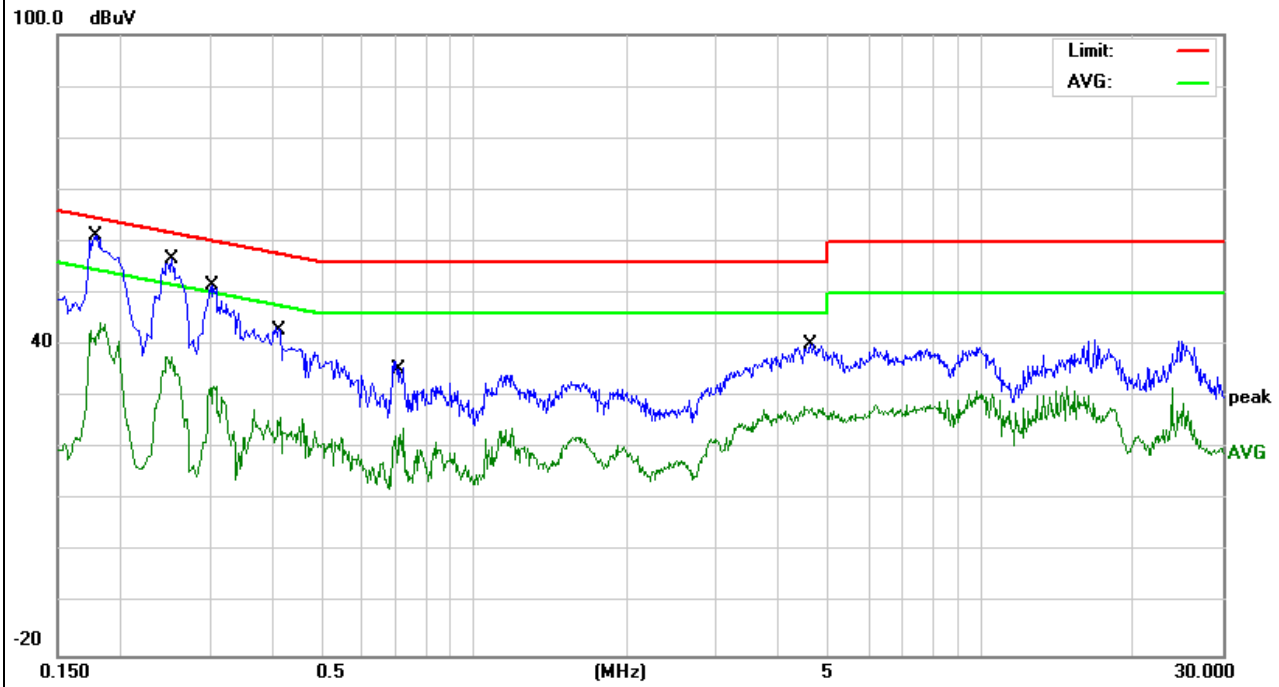

EUT:	LED Monitor	Model Name. :	PX347c Prime
Temperature:	26 °C	Relative Humidity:	54%
Pressure:	1010hPa	Test Date:	2017-5-3
Test Mode:	Mode 3(H)	Phase :	N
Test Voltage:	AC 120V/60Hz		

Frequency (MHz)	Reading Level (dBμV)	Correct Factor (dB)	Measure-ment (dBμV)	Limits (dBμV)	Margin (dB)	Remark
0.1833	47.55	10.13	57.68	64.33	-6.65	QP
0.1833	32.26	10.13	42.39	54.33	-11.94	AVG
0.2479	44.18	10.12	54.30	61.82	-7.52	QP
0.2479	24.91	10.12	35.03	51.82	-16.79	AVG
0.3034	43.49	10.11	53.60	60.15	-6.55	QP
0.3034	28.16	10.11	38.27	50.15	-11.88	AVG
0.4192	36.73	10.17	46.90	57.46	-10.56	QP
0.4192	22.10	10.17	32.27	47.46	-15.19	AVG
0.5299	33.23	10.17	43.40	56.00	-12.60	QP
0.5299	20.36	10.17	30.53	46.00	-15.47	AVG
4.6817	32.18	10.23	42.41	56.00	-13.59	QP
4.6817	17.34	10.23	27.57	46.00	-18.43	AVG

Remark:

1. All readings are Quasi-Peak and Average values.
2. Factor = Insertion Loss + Cable Loss.

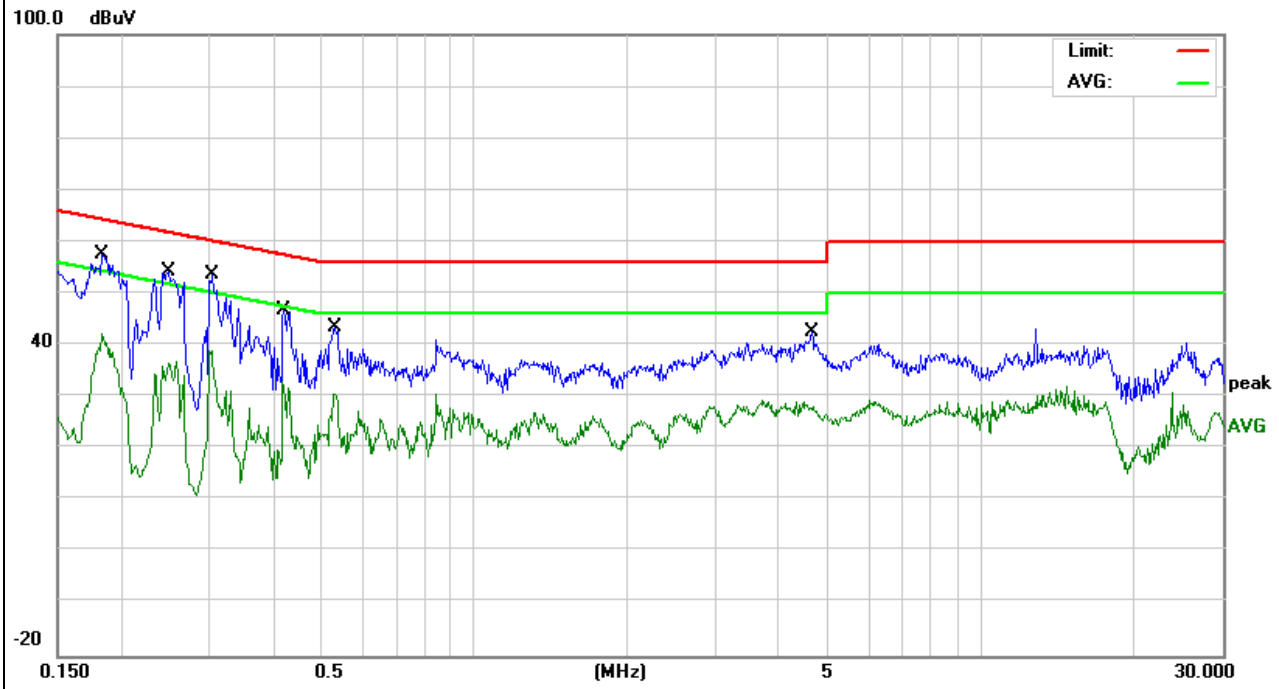

EUT:	LED Monitor	Model Name. :	PX347c Prime
Temperature:	26 °C	Relative Humidity:	54%
Pressure:	1010hPa	Test Date:	2017-5-3
Test Mode:	Mode 3(M)	Phase :	L
Test Voltage:	AC 120V/60Hz		

Frequency (MHz)	Reading Level (dBμV)	Correct Factor (dB)	Measure-ment (dBμV)	Limits (dBμV)	Margin (dB)	Remark
0.1766	51.17	10.13	61.30	64.64	-3.34	QP
0.1766	30.35	10.13	40.48	54.64	-14.16	AVG
0.2403	45.18	10.12	55.30	62.08	-6.78	QP
0.2403	22.86	10.12	32.98	52.08	-19.10	AVG
0.3064	41.29	10.11	51.40	60.07	-8.67	QP
0.3064	21.02	10.11	31.13	50.07	-18.94	AVG
0.5736	30.81	10.19	41.00	56.00	-15.00	QP
0.5736	15.23	10.19	25.42	46.00	-20.58	AVG
0.902	28.66	10.24	38.90	56.00	-17.10	QP
0.902	17.72	10.24	27.96	46.00	-18.04	AVG
4.6897	32.36	10.23	42.59	56.00	-13.41	QP
4.6897	17.60	10.23	27.83	46.00	-18.17	AVG

Remark:

1. All readings are Quasi-Peak and Average values.
2. Factor = Insertion Loss + Cable Loss.

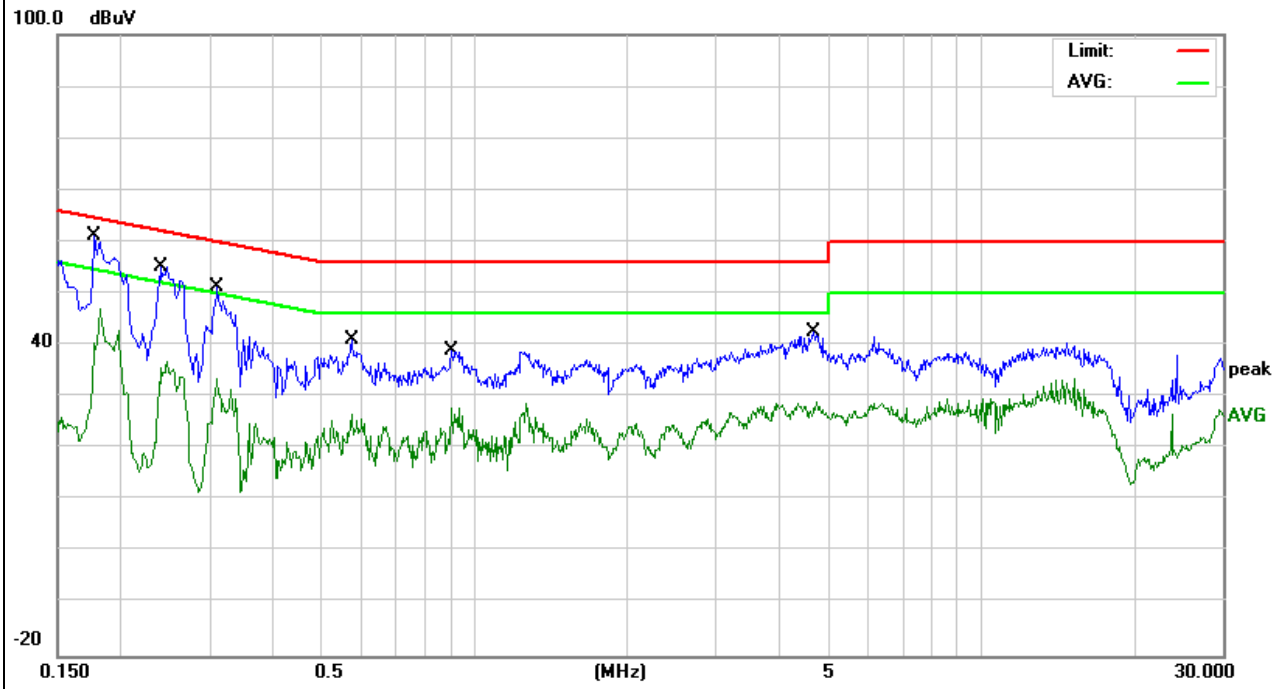

EUT:	LED Monitor	Model Name. :	PX347c Prime
Temperature:	26 °C	Relative Humidity:	54%
Pressure:	1010hPa	Test Date:	2017-5-3
Test Mode:	Mode 3(M)	Phase :	N
Test Voltage:	AC 120V/60Hz		

Frequency (MHz)	Reading Level (dBμV)	Correct Factor (dB)	Measure-ment (dBμV)	Limits (dBμV)	Margin (dB)	Remark
0.1844	48.12	10.14	58.26	64.28	-6.02	QP
0.1844	32.05	10.14	42.19	54.28	-12.09	AVG
0.2058	45.57	10.13	55.7	63.37	-7.67	QP
0.2058	16.48	10.13	26.61	53.37	-26.76	AVG
0.2519	42.58	10.12	52.7	61.69	-8.99	QP
0.2519	26.03	10.12	36.15	51.69	-15.54	AVG
0.3113	42.58	10.12	52.7	59.93	-7.23	QP
0.3113	21.89	10.12	32.01	49.93	-17.92	AVG
0.4697	33.56	10.14	43.7	56.52	-12.82	QP
0.4697	18.55	10.14	28.69	46.52	-17.83	AVG
4.5099	32.96	10.24	43.2	56.00	-12.80	QP
4.5099	16.22	10.24	26.46	46.00	-19.54	AVG

Remark:

1. All readings are Quasi-Peak and Average values.
2. Factor = Insertion Loss + Cable Loss.

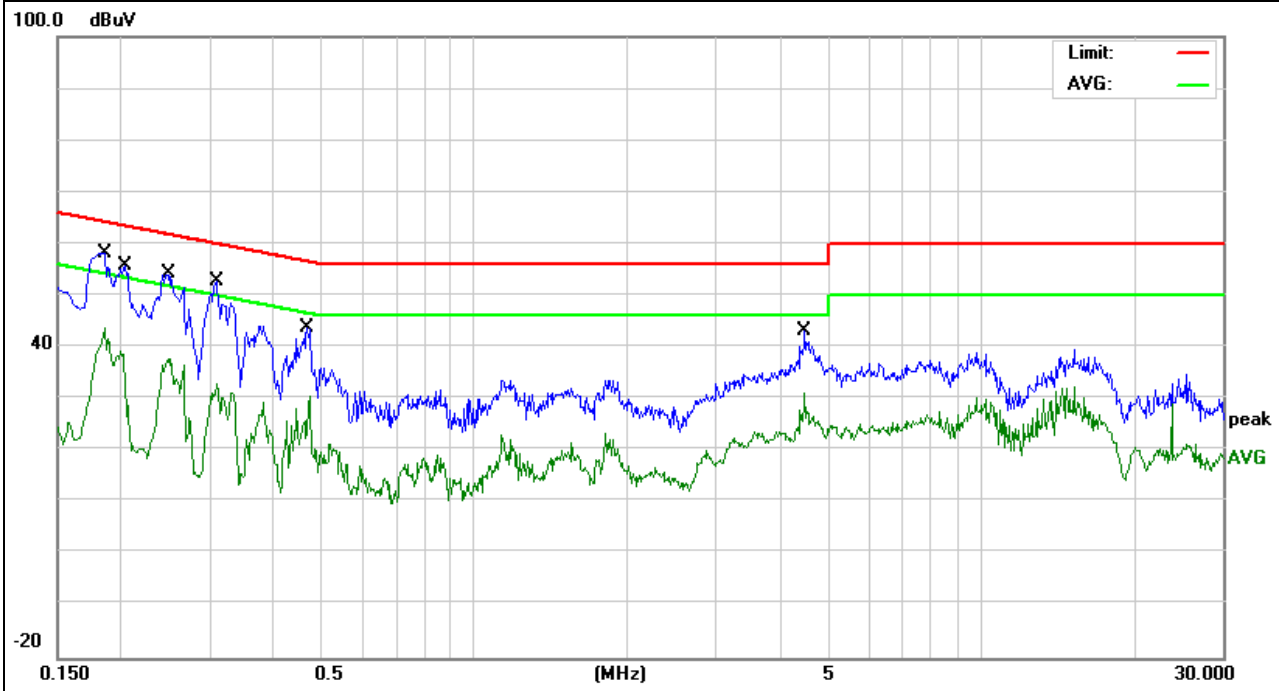

EUT:	LED Monitor	Model Name. :	PX347c Prime
Temperature:	26 °C	Relative Humidity:	54%
Pressure:	1010hPa	Test Date:	2017-5-3
Test Mode:	Mode 3(L)	Phase :	L
Test Voltage:	AC 120V/60Hz		

Frequency (MHz)	Reading Level (dBμV)	Correct Factor (dB)	Measure-ment (dBμV)	Limits (dBμV)	Margin (dB)	Remark
0.1844	47.37	10.13	57.50	64.28	-6.78	QP
0.1844	36.39	10.13	46.52	54.28	-7.76	AVG
0.256	45.69	10.11	55.80	61.56	-5.76	QP
0.256	22.83	10.11	32.94	51.56	-18.62	AVG
0.3059	38.79	10.11	48.90	60.08	-11.18	QP
0.3059	20.02	10.11	30.13	50.08	-19.95	AVG
0.4138	34.33	10.17	44.50	57.57	-13.07	QP
0.4138	15.21	10.17	25.38	47.57	-22.19	AVG
1.022	29.26	10.24	39.50	56.00	-16.50	QP
1.022	11.60	10.24	21.84	46.00	-24.16	AVG
1.3816	26.58	10.22	36.80	56.00	-19.20	QP
1.3816	12.84	10.22	23.06	46.00	-22.94	AVG

Remark:

1. All readings are Quasi-Peak and Average values.
2. Factor = Insertion Loss + Cable Loss.

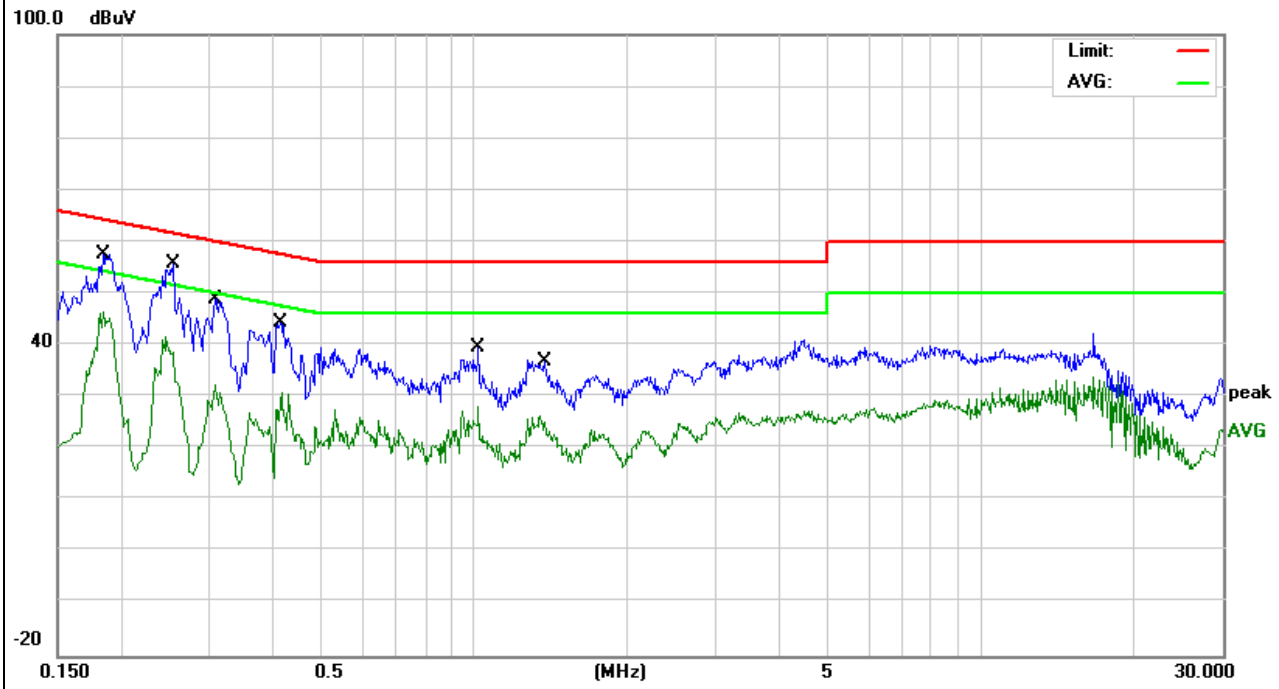

EUT:	LED Monitor	Model Name. :	PX347c Prime
Temperature:	26 °C	Relative Humidity:	54%
Pressure:	1010hPa	Test Date:	2017-5-3
Test Mode:	Mode 3(L)	Phase :	N
Test Voltage:	AC 120V/60Hz		

Frequency (MHz)	Reading Level (dBμV)	Correct Factor (dB)	Measure-ment (dBμV)	Limits (dBμV)	Margin (dB)	Remark
0.1766	47.76	10.14	57.90	64.64	-6.74	QP
0.1766	32.65	10.14	42.79	54.64	-11.85	AVG
0.1995	45.17	10.13	55.30	63.63	-8.33	QP
0.1995	26.50	10.13	36.63	53.63	-17.00	AVG
0.2379	44.57	10.13	54.70	62.17	-7.47	QP
0.2379	27.88	10.13	38.01	52.17	-14.16	AVG
0.3113	39.58	10.12	49.70	59.93	-10.23	QP
0.3113	21.44	10.12	31.56	49.93	-18.37	AVG
0.502	30.66	10.14	40.80	56.00	-15.20	QP
0.502	18.87	10.14	29.01	46.00	-16.99	AVG
4.3939	31.67	10.23	41.90	56.00	-14.10	QP
4.3939	19.91	10.23	30.14	46.00	-15.86	AVG

Remark:

1. All readings are Quasi-Peak and Average values.
2. Factor = Insertion Loss + Cable Loss.

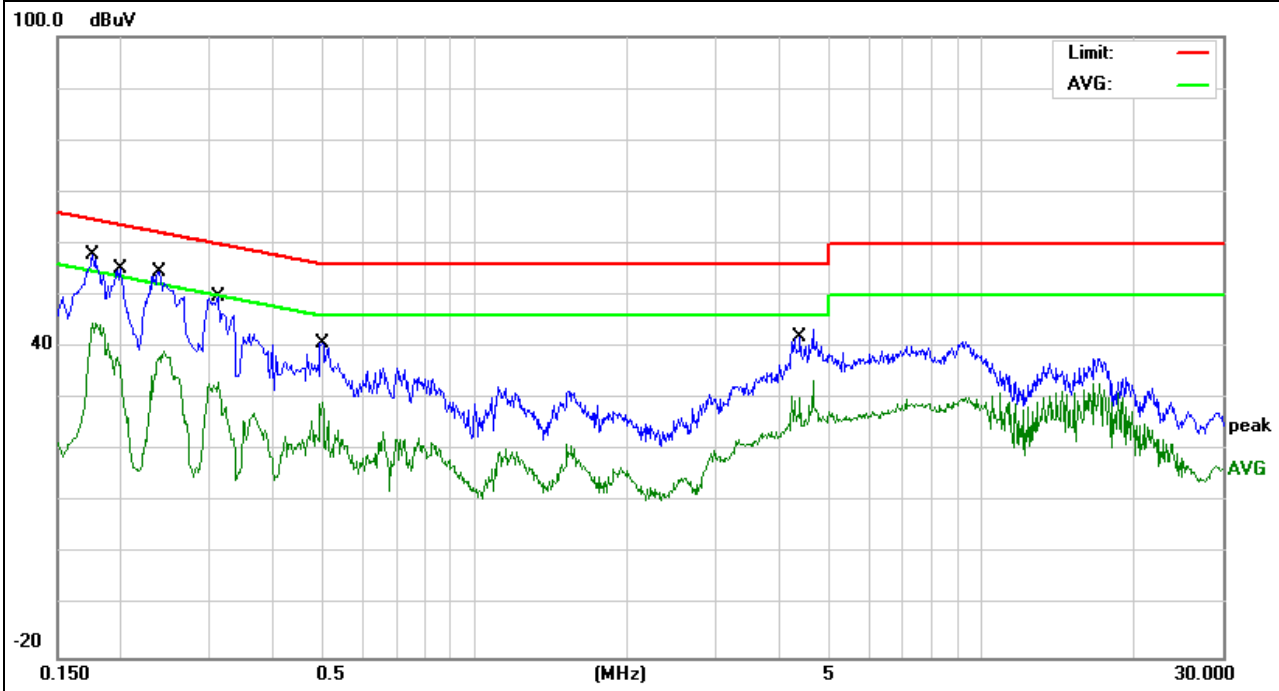

EUT:	LED Monitor	Model Name. :	PX347c Prime
Temperature:	26 °C	Relative Humidity:	54%
Pressure:	1010hPa	Test Date:	2017-5-3
Test Mode:	Mode 3(H)	Phase :	L
Test Voltage:	AC 240V/60Hz		

Frequency (MHz)	Reading Level (dBμV)	Correct Factor (dB)	Measure-ment (dBμV)	Limits (dBμV)	Margin (dB)	Remark
0.1779	48.25	10.14	58.39	64.58	-6.19	QP
0.1779	33.87	10.14	44.01	54.58	-10.57	AVG
0.2419	44.62	10.13	54.75	62.03	-7.28	QP
0.2419	26.48	10.13	36.61	52.03	-15.42	AVG
0.3059	38.37	10.12	48.49	60.08	-11.59	QP
0.3059	19.11	10.12	29.23	50.08	-20.85	AVG
4.4858	30.03	10.23	40.26	56.00	-15.74	QP
4.4858	17.83	10.23	28.06	46.00	-17.94	AVG
9.9497	29.27	10.29	39.56	60.00	-20.44	QP
9.9497	20.84	10.29	31.13	50.00	-18.87	AVG
14.8099	30.75	10.33	41.08	60.00	-18.92	QP
14.8099	21.63	10.33	31.96	50.00	-18.04	AVG

Remark:

1. All readings are Quasi-Peak and Average values.
2. Factor = Insertion Loss + Cable Loss.

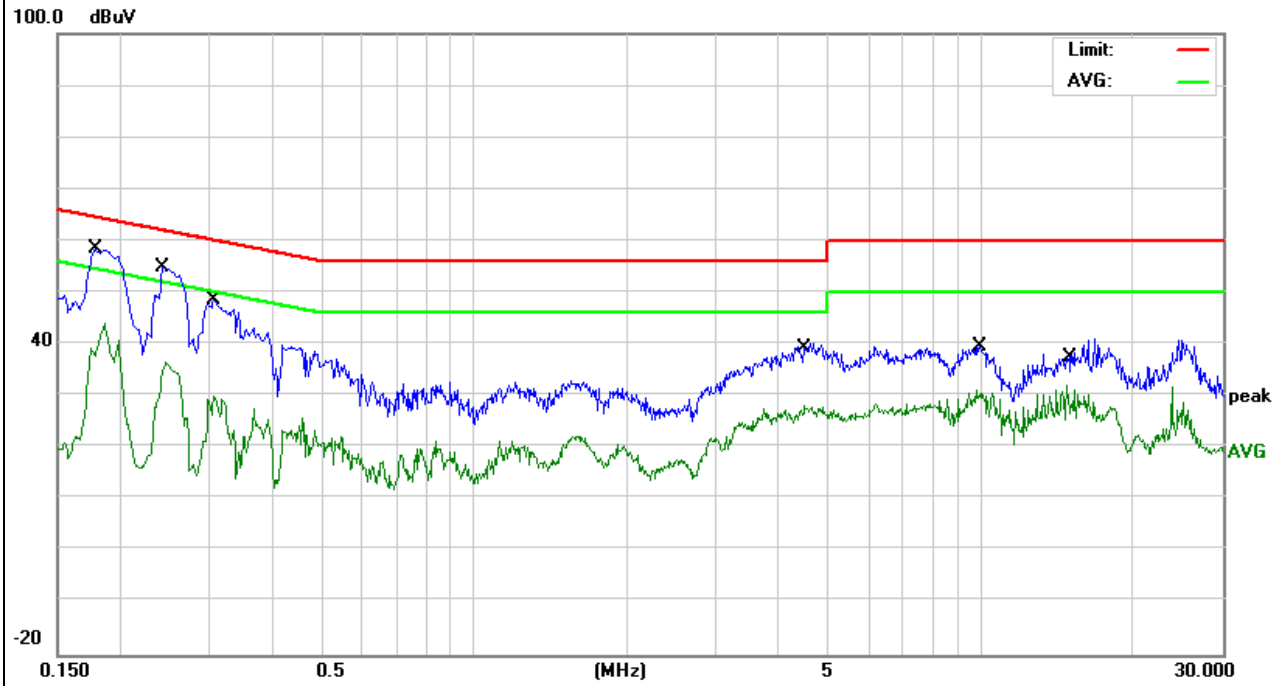

EUT:	LED Monitor	Model Name. :	PX347c Prime
Temperature:	26 °C	Relative Humidity:	54%
Pressure:	1010hPa	Test Date:	2017-5-3
Test Mode:	Mode 3(H)	Phase :	N
Test Voltage:	AC 240V/60Hz		

Frequency (MHz)	Reading Level (dBμV)	Correct Factor (dB)	Measure-ment (dBμV)	Limits (dBμV)	Margin (dB)	Remark
0.1819	48.54	10.13	58.67	64.39	-5.72	QP
0.1819	33.50	10.13	43.63	54.39	-10.76	AVG
0.254	42.66	10.11	52.77	61.62	-8.85	QP
0.254	24.06	10.11	34.17	51.62	-17.45	AVG
0.3059	38.99	10.11	49.1	60.08	-10.98	QP
0.3059	22.98	10.11	33.09	50.08	-16.99	AVG
0.518	29.85	10.17	40.02	56.00	-15.98	QP
0.518	18.81	10.17	28.98	46.00	-17.02	AVG
4.6337	32.18	10.23	42.41	56.00	-13.59	QP
4.6337	20.75	10.23	30.98	46.00	-15.02	AVG
25.474	29.94	10.38	40.32	60.00	-19.68	QP
25.474	20.60	10.38	30.98	50.00	-19.02	AVG

Remark:

1. All readings are Quasi-Peak and Average values.
2. Factor = Insertion Loss + Cable Loss.

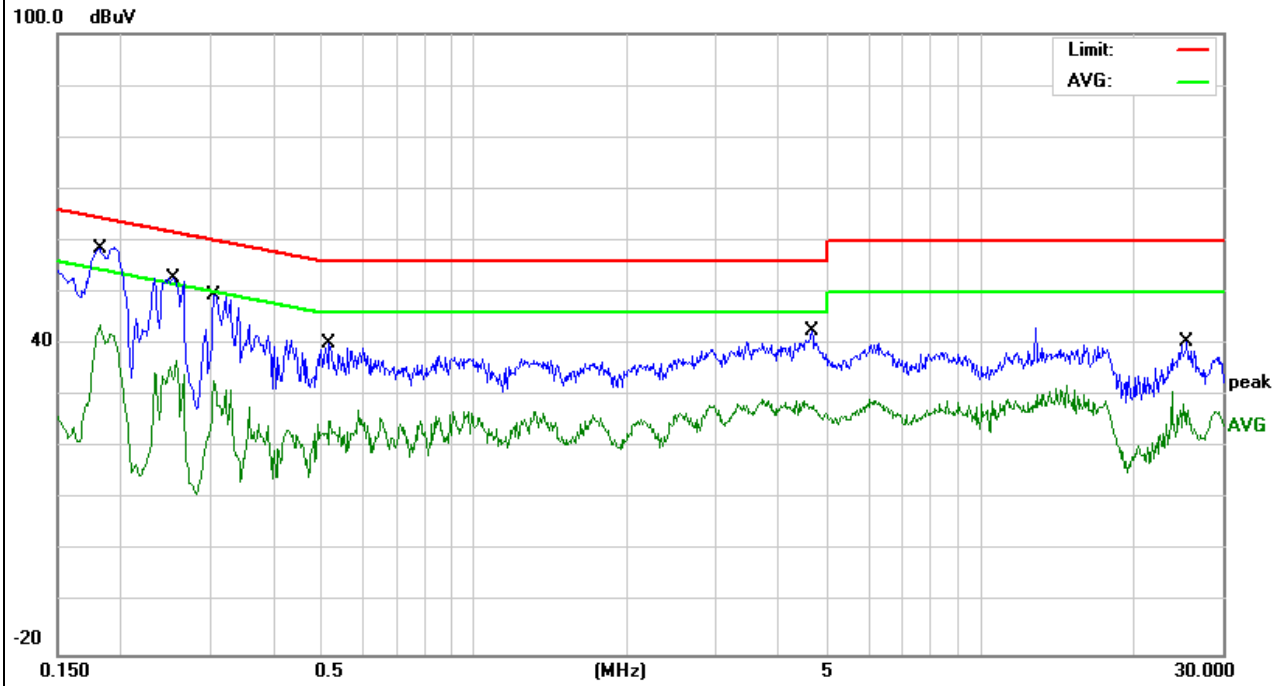

EUT:	LED Monitor	Model Name. :	PX347c Prime
Temperature:	26 °C	Relative Humidity:	54%
Pressure:	1010hPa	Test Date:	2017-5-3
Test Mode:	Mode 3(M)	Phase :	L
Test Voltage:	AC 240V/60Hz		

Frequency (MHz)	Reading Level (dBμV)	Correct Factor (dB)	Measure-ment (dBμV)	Limits (dBμV)	Margin (dB)	Remark
0.15	50.27	10.14	60.41	65.99	-5.58	QP
0.15	18.22	10.14	28.36	55.99	-27.63	AVG
0.1819	48.29	10.13	58.42	64.39	-5.97	QP
0.1819	35.35	10.13	45.48	54.39	-8.91	AVG
0.2459	43.34	10.12	53.46	61.89	-8.43	QP
0.2459	25.26	10.12	35.38	51.89	-16.51	AVG
0.314	37.33	10.12	47.45	59.86	-12.41	QP
0.314	21.38	10.12	31.5	49.86	-18.36	AVG
4.3498	32.37	10.22	42.59	56.00	-13.41	QP
4.3498	18.43	10.22	28.65	46.00	-17.35	AVG
6.1257	31.28	10.25	41.53	60.00	-18.47	QP
6.1257	18.65	10.25	28.90	50.00	-21.10	AVG

Remark:

1. All readings are Quasi-Peak and Average values.
2. Factor = Insertion Loss + Cable Loss.

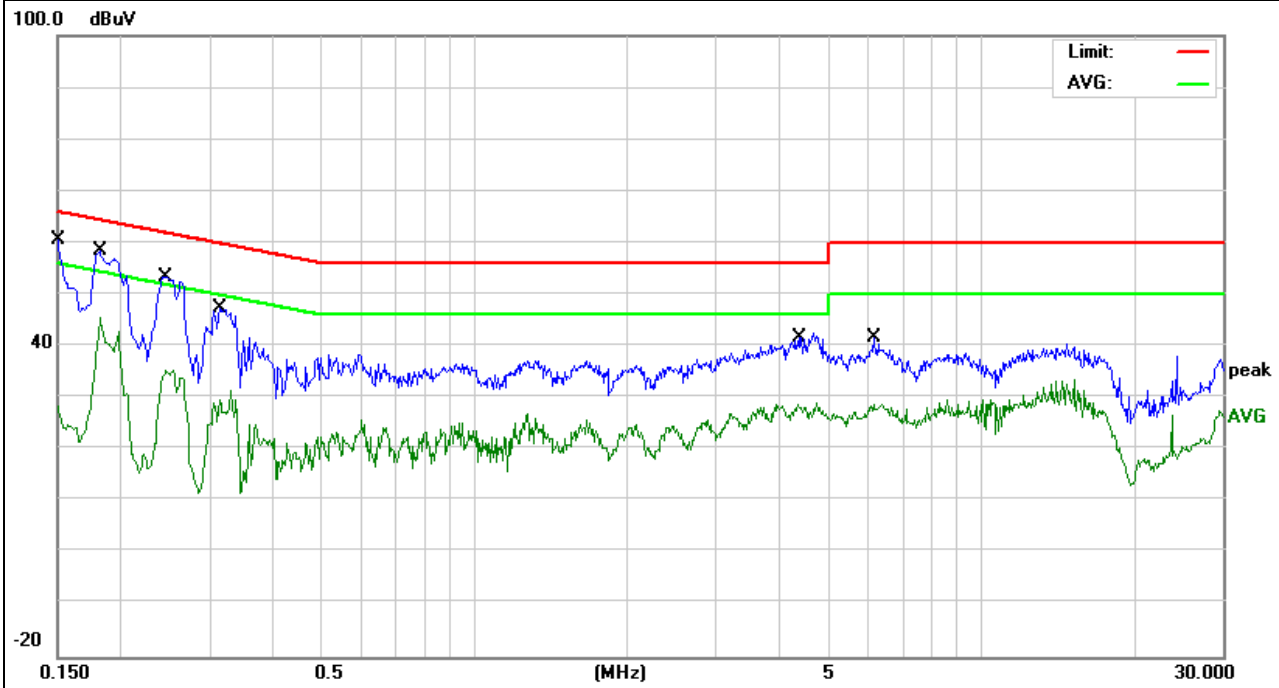

EUT:	LED Monitor	Model Name. :	PX347c Prime
Temperature:	26 °C	Relative Humidity:	54%
Pressure:	1010hPa	Test Date:	2017-5-3
Test Mode:	Mode 3(M)	Phase :	N
Test Voltage:	AC 240V/60Hz		

Frequency (MHz)	Reading Level (dBμV)	Correct Factor (dB)	Measure-ment (dBμV)	Limits (dBμV)	Margin (dB)	Remark
0.1819	48.12	10.14	58.26	64.39	-6.13	QP
0.1819	33.68	10.14	43.82	54.39	-10.57	AVG
0.2419	42.56	10.13	52.69	62.03	-9.34	QP
0.2419	26.71	10.13	36.84	52.03	-15.19	AVG
0.3099	38.50	10.12	48.62	59.97	-11.35	QP
0.3099	20.90	10.12	31.02	49.97	-18.95	AVG
0.4698	27.80	10.14	37.94	56.52	-18.58	QP
0.4698	11.24	10.14	21.38	46.52	-25.14	AVG
4.6897	28.88	10.24	39.12	56.00	-16.88	QP
4.6897	15.88	10.24	26.12	46.00	-19.88	AVG
9.7737	28.52	10.29	38.81	60.00	-21.19	QP
9.7737	19.87	10.29	30.16	50.00	-19.84	AVG

Remark:

1. All readings are Quasi-Peak and Average values.
2. Factor = Insertion Loss + Cable Loss.

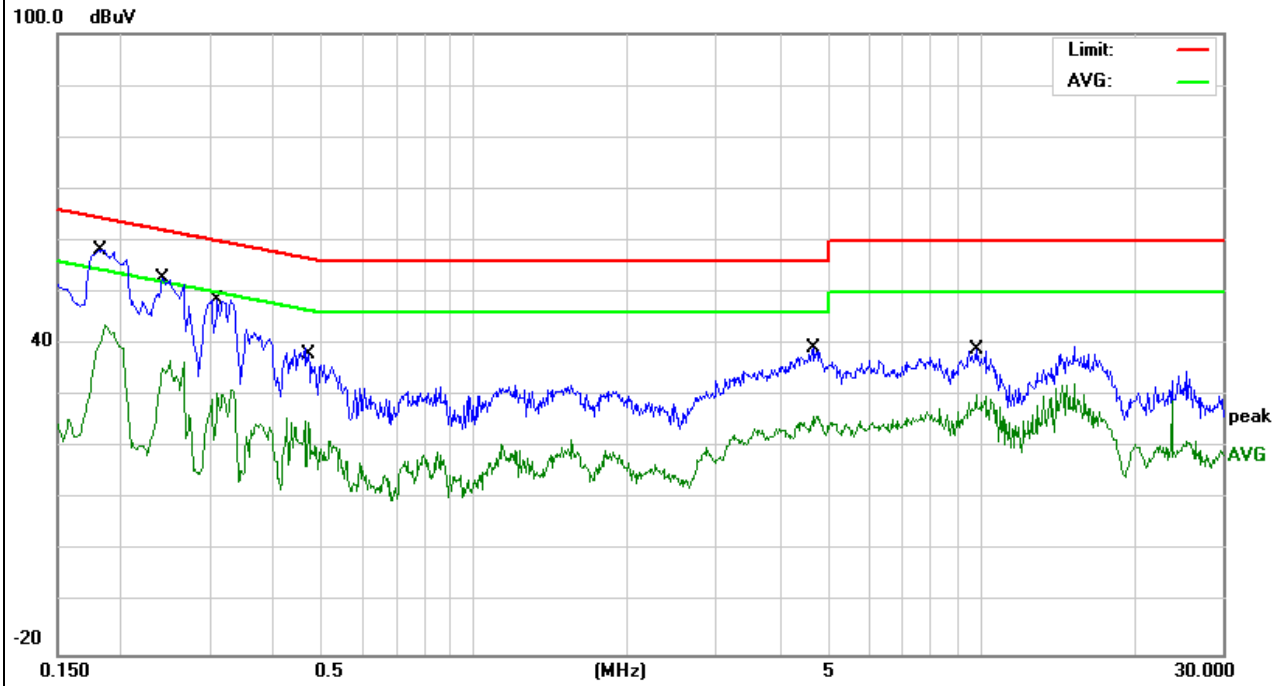

EUT:	LED Monitor	Model Name. :	PX347c Prime
Temperature:	26 °C	Relative Humidity:	54%
Pressure:	1010hPa	Test Date:	2017-5-3
Test Mode:	Mode 3(L)	Phase :	L
Test Voltage:	AC 240V/60Hz		

Frequency (MHz)	Reading Level (dBμV)	Correct Factor (dB)	Measure-ment (dBμV)	Limits (dBμV)	Margin (dB)	Remark
0.1748	47.38	10.15	57.53	64.72	-7.19	QP
0.1748	32.53	10.15	42.68	54.72	-12.04	AVG
0.234	42.88	10.13	53.01	62.30	-9.29	QP
0.234	28.69	10.13	38.82	52.30	-13.48	AVG
0.2977	38.92	10.12	49.04	60.30	-11.26	QP
0.2977	21.79	10.12	31.91	50.30	-18.39	AVG
0.778	24.09	10.20	34.29	56.00	-21.71	QP
0.778	12.14	10.20	22.34	46.00	-23.66	AVG
4.8258	29.94	10.24	40.18	56.00	-15.82	QP
4.8258	16.81	10.24	27.05	46.00	-18.95	AVG
9.3258	30.80	10.29	41.09	60.00	-18.91	QP
9.3258	19.98	10.29	30.27	50.00	-19.73	AVG

Remark:

1. All readings are Quasi-Peak and Average values.
2. Factor = Insertion Loss + Cable Loss.



EUT:	LED Monitor	Model Name. :	PX347c Prime
Temperature:	26 °C	Relative Humidity:	54%
Pressure:	1010hPa	Test Date:	2017-5-3
Test Mode:	Mode 3(L)	Phase :	N
Test Voltage:	AC 240V/60Hz		

Frequency (MHz)	Reading Level (dBμV)	Correct Factor (dB)	Measure-ment (dBμV)	Limits (dBμV)	Margin (dB)	Remark
0.1819	46.24	10.13	56.37	64.39	-8.02	QP
0.1819	37.02	10.13	47.15	54.39	-7.24	AVG
0.2419	41.12	10.12	51.24	62.03	-10.79	QP
0.2419	29.01	10.12	39.13	52.03	-12.90	AVG
0.318	36.36	10.12	46.48	59.76	-13.28	QP
0.318	16.99	10.12	27.11	49.76	-22.65	AVG
0.4979	29.47	10.16	39.63	56.03	-16.40	QP
0.4979	17.40	10.16	27.56	46.03	-18.47	AVG
1.314	24.75	10.22	34.97	56.00	-21.03	QP
1.314	13.85	10.22	24.07	46.00	-21.93	AVG
4.4659	30.91	10.22	41.13	56.00	-14.87	QP
4.4659	17.11	10.22	27.33	46.00	-18.67	AVG

Remark:

1. All readings are Quasi-Peak and Average values.
2. Factor = Insertion Loss + Cable Loss.

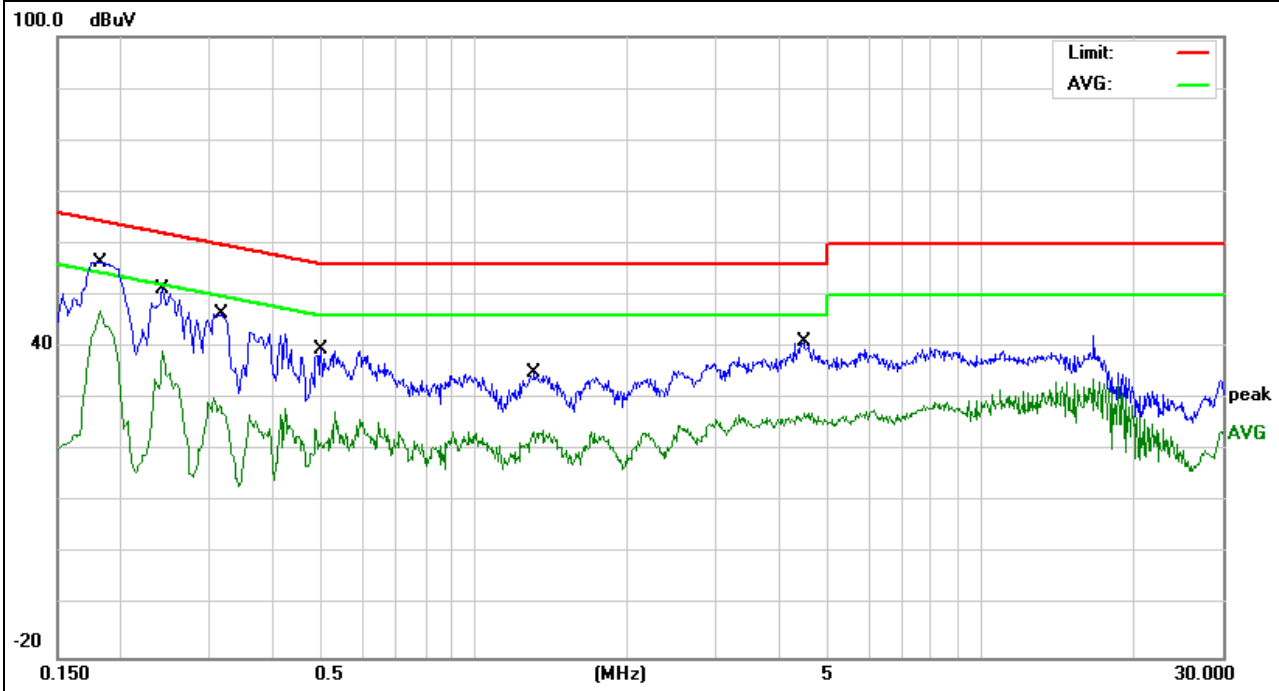

3.2 RADIATED EMISSION MEASUREMENT

3.2.1 LIMITS OF RADIATED EMISSION MEASUREMENT

FREQUENCY (MHz)	Class A (at 10m)	Class B (at 3m)
	dBuV/m	dBuV/m
30 ~ 88	39.0	40.0
88 ~ 216	43.5	43.5
216 ~ 960	46.5	46.0
Above 960	49.5	54.0

Notes:

- (1) The limit for radiated test was performed according to as following:
FCC PART 15B /ICES-003.
- (2) The tighter limit applies at the band edges.
- (3) Emission level (dBuV/m)=20log Emission level (uV/m).

3.2.2 TEST PROCEDURE

Test Arrangement for Radiated Emissions up to 1 GHz

- a. The EUT was placed on the top of a rotating table 0.8 meters above the ground at an accredited test facility. The table was rotated 360 degrees to determine the position of the highest radiation.
- b. The EUT was set 3 meters away from the interference-receiving antenna, which was mounted on the top of a variable-height antenna tower.
- c. The antenna is a broadband antenna, and its height is varied from one meter to four meters above the ground to determine the maximum value of the field strength. Both horizontal and vertical polarizations of the antenna are set to make the measurement.
- d. For each suspected emission, the EUT was arranged to its worst case and then the antenna was tuned to heights from 1 meter to 4 meters and the rotatable table was turned from 0 degrees to 360 degrees to find the maximum reading.

Note: The resolution bandwidth and video bandwidth of test receiver/spectrum analyzer is 120kHz for quasi-peak detection (QP) at frequency below 1GHz.

Test Arrangement for Radiated Emissions above 1 GHz.

- a. The EUT was placed on the top of a rotating table 0.8 meters above the ground at an
- b. accredited chamber room. The table was rotated 360 degrees to determine the position of
- c. the highest radiation.
- b. The EUT was set 3 meters away from the interference-receiving antenna, which was mounted on the top of a variable-height antenna tower.
- d. The height of antenna can be varied from one meter to four meters, the height of
- e. adjustment depends on the EUT height and the antenna 3dB beamwidth both, to detect
- f. the maximum value of the field strength.Both horizontal and vertical polarizations of the
- g. antenna are set to make the measurement.
- d. For each suspected emission, the EUT was arranged to its worst case and then the antenna was tuned to heights and the rotatable table was turned from 0 degrees to 360 degrees to find the maximum reading.

Note: For the hand-held device, the EUT should be measured for all 3 axes and only the worst case is recorded in the report

During the radiated emission test, the Spectrum Analyzer was set with the following configurations:

Frequency Band (MHz)	Function	Resolution bandwidth	Video Bandwidth
30 to 1000	QP	120 kHz	300 kHz
Above 1000	Peak	1 MHz	1 MHz
	Avg	1 MHz	10 Hz

3.2.3 TEST SETUP

For Radiated Emission 30~1000MHz

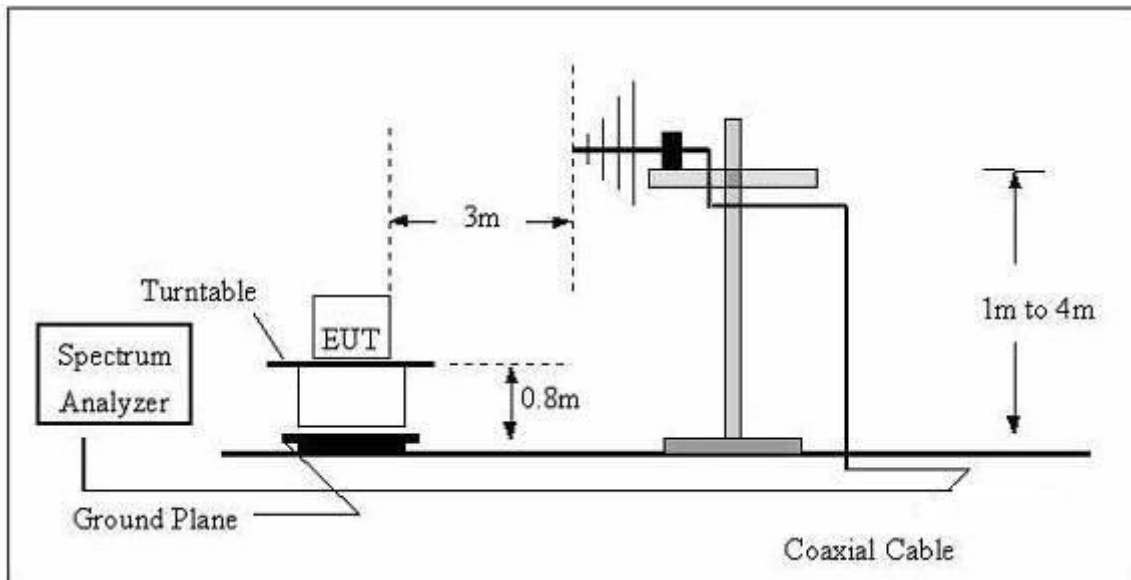

Radiated Emission Test Set-Up Frequency Above 1GHz

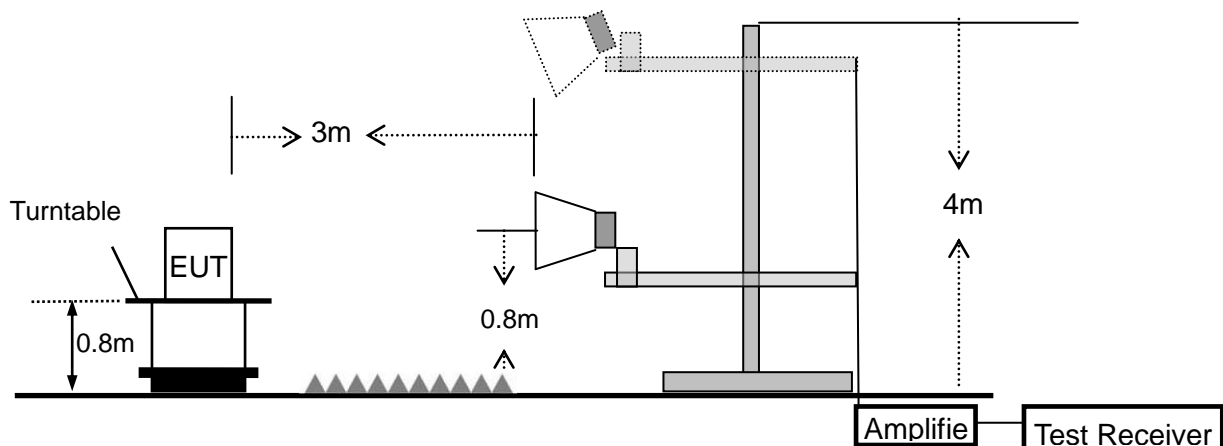

3.2.4 TEST RESULTS

TEST RESULTS (30~1000 MHz)

EUT:	LED Monitor	Model Name:	PX347c Prime
Temperature:	24 °C	Relative Humidity:	54%
Pressure:	1010 hPa	Test Date :	2017-5-3
Test Mode :	Mode 3(H)	Polarization :	Horizontal
Test Power :	AC 120V/60Hz		

Polar (H/V)	Frequency	Meter Reading	Factor	Emission Level	Limits	Margin	Remark
	(MHz)	(dBuV)	(dB)	(dBuV/m)	(dBuV/m)	(dB)	
H	109.4116	17.83	12.54	30.37	43.50	-13.13	QP
H	121.9753	16.11	13.78	29.89	43.50	-13.61	QP
H	177.5089	15.62	11.54	27.16	43.50	-16.34	QP
H	319.9370	15.32	16.89	32.21	46.00	-13.79	QP
H	576.6443	13.26	24.71	37.97	46.00	-8.03	QP
H	962.1621	10.20	31.33	41.53	54.00	-12.47	QP

Remark:
Factor = Antenna Factor + Cable Loss - Amplifier.

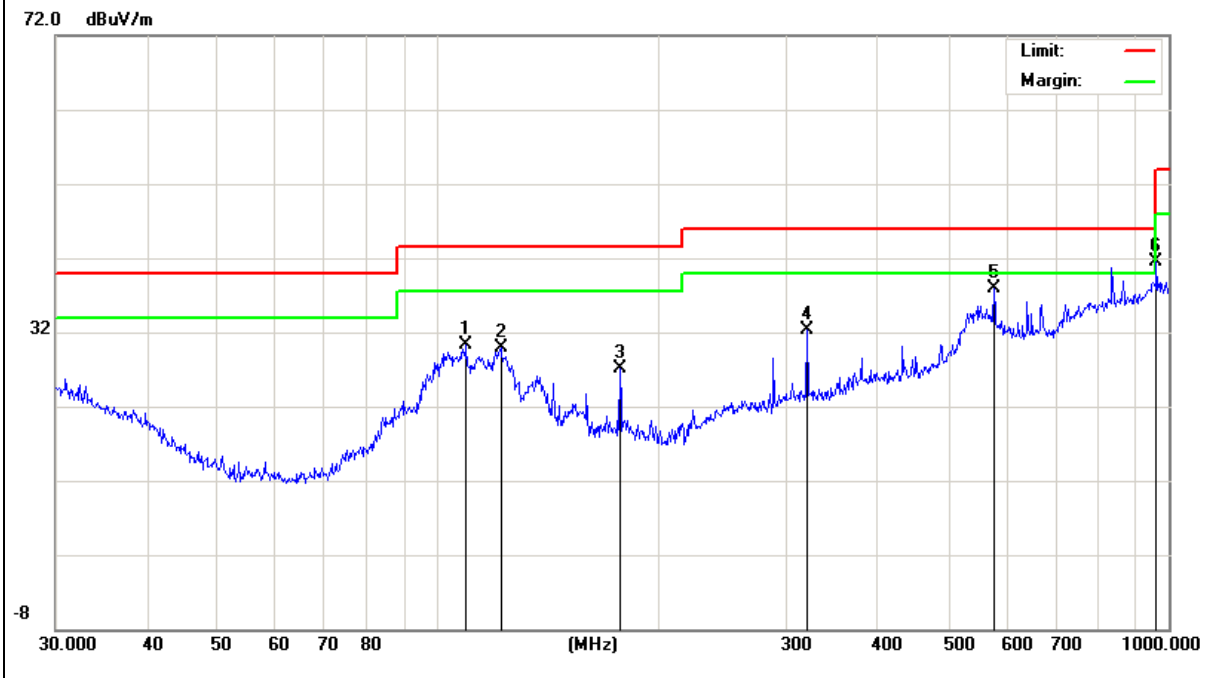

EUT:	LED Monitor	Model Name :	PX347c Prime
Temperature:	24 °C	Relative Humidity:	54%
Pressure:	1010 hPa	Test Date :	2017-5-3
Test Mode :	Mode 3(H)	Polarization :	Vertical
Test Power :	AC 120V/60Hz		

Polar (H/V)	Frequency	Meter Reading	Factor	Emission Level	Limits	Margin	Remark
	(MHz)	(dBuV)	(dB)	(dBuV/m)	(dBuV/m)	(dB)	
V	107.8876	21.79	12.44	34.23	43.50	-9.27	QP
V	176.2684	16.13	11.55	27.68	43.50	-15.82	QP
V	287.9904	12.93	15.94	28.87	46.00	-17.13	QP
V	432.5457	13.92	20.67	34.59	46.00	-11.41	QP
V	547.0977	11.62	24.68	36.30	46.00	-9.70	QP
V	866.0878	13.43	29.11	42.54	46.00	-3.46	QP

Remark:

Factor = Antenna Factor + Cable Loss - Amplifier.

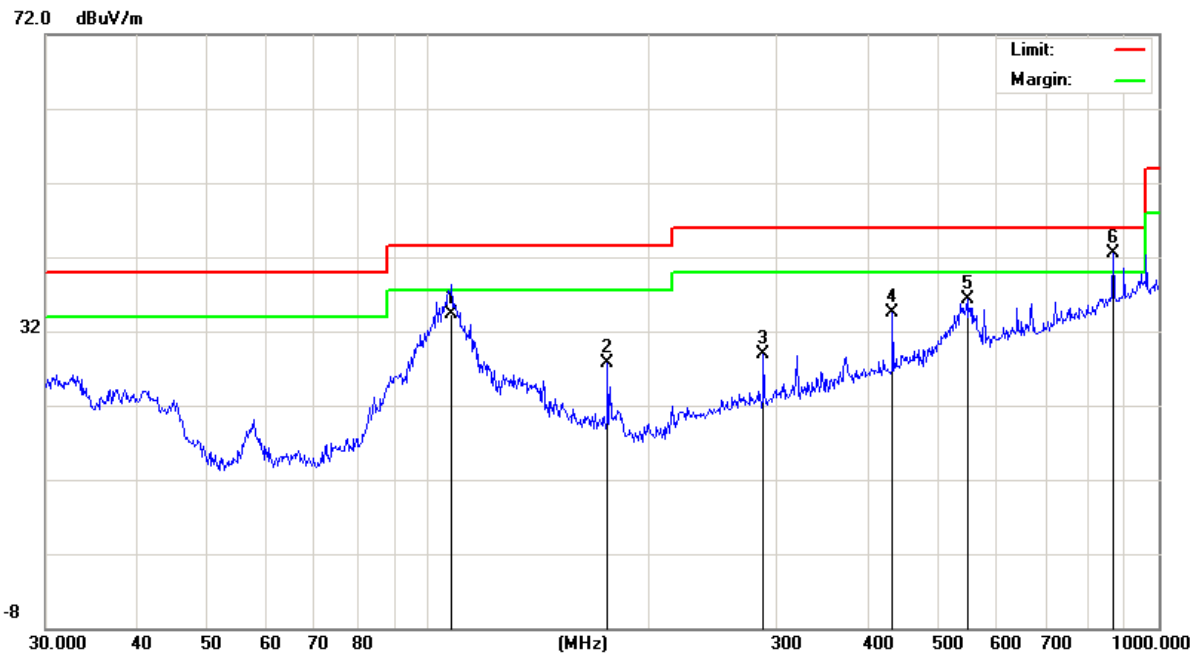

EUT:	LED Monitor	Model Name:	PX347c Prime
Temperature:	24 °C	Relative Humidity:	54%
Pressure:	1010 hPa	Test Date :	2017-5-3
Test Mode :	Mode 3(M)	Polarization :	Horizontal
Test Power :	AC 120V/60Hz		

Polar (H/V)	Frequency	Meter Reading	Factor	Emission Level	Limits	Margin	Remark
	(MHz)	(dBuV)	(dB)	(dBuV/m)	(dBuV/m)	(dB)	
H	113.3161	19.04	13.02	32.06	43.50	-11.44	QP
H	319.9370	15.82	16.89	32.71	46.00	-13.29	QP
H	640.6109	11.26	25.31	36.57	46.00	-9.43	QP
H	721.7259	12.24	26.47	38.71	46.00	-7.29	QP
H	839.1816	11.03	28.76	39.79	46.00	-6.21	QP
H	962.1621	11.20	31.33	42.53	54.00	-11.47	QP

Remark:
Factor = Antenna Factor + Cable Loss - Amplifier.

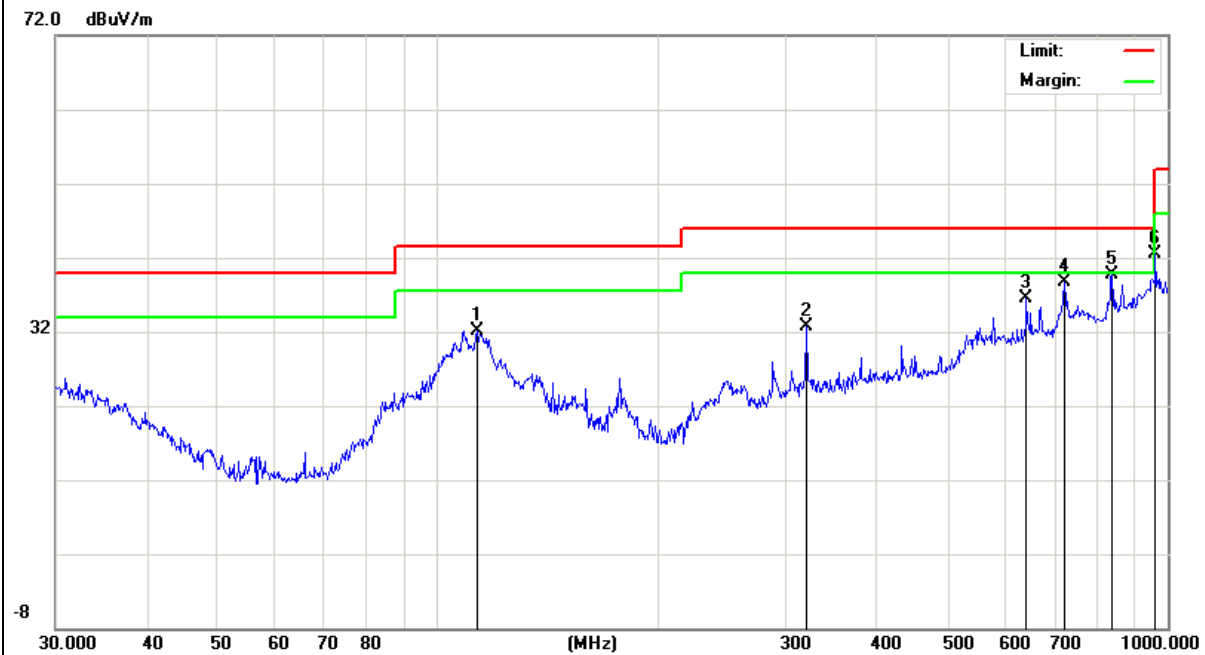

EUT:	LED Monitor	Model Name :	PX347c Prime
Temperature:	24 °C	Relative Humidity:	54%
Pressure:	1010 hPa	Test Date :	2017-5-3
Test Mode :	Mode 3(M)	Polarization :	Vertical
Test Power :	AC 120V/60Hz		

Polar (H/V)	Frequency	Meter Reading	Factor	Emission Level	Limits	Margin	Remark
	(MHz)	(dBuV)	(dB)	(dBuV/m)	(dBuV/m)	(dB)	
V	44.9004	13.39	11.22	24.61	40.00	-15.39	QP
V	102.7192	23.93	12.07	36.00	43.50	-7.50	QP
V	176.2684	17.13	11.55	28.68	43.50	-14.82	QP
V	287.9904	13.43	15.94	29.37	46.00	-16.63	QP
V	547.0977	13.12	24.68	37.80	46.00	-8.20	QP
V	962.1621	12.01	31.33	43.34	54.00	-10.66	QP

Remark:

Factor = Antenna Factor + Cable Loss - Amplifier.

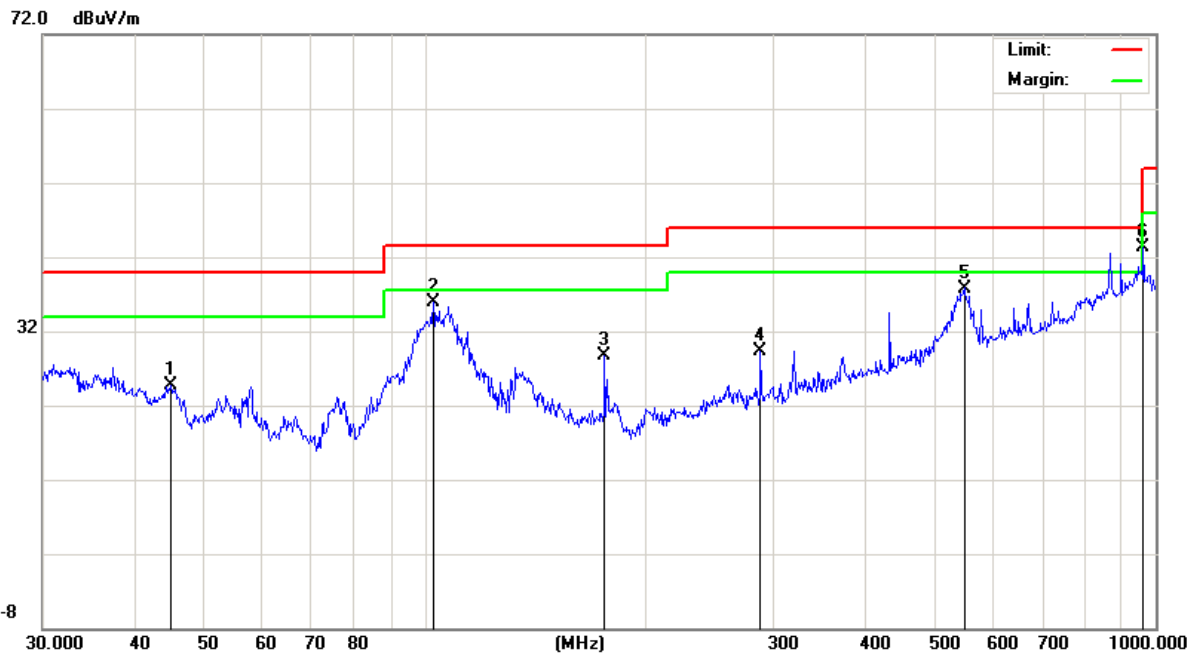

EUT:	LED Monitor	Model Name:	PX347c Prime
Temperature:	24 °C	Relative Humidity:	54%
Pressure:	1010 hPa	Test Date :	2017-5-3
Test Mode :	Mode 3(L)	Polarization :	Horizontal
Test Power :	AC 120V/60Hz		

Polar (H/V)	Frequency	Meter Reading	Factor	Emission Level	Limits	Margin	Remark
	(MHz)	(dBuV)	(dB)	(dBuV/m)	(dBuV/m)	(dB)	
H	107.8876	17.46	12.44	29.90	43.50	-13.60	QP
H	143.8291	17.13	12.97	30.10	43.50	-13.40	QP
H	319.9370	14.32	16.89	31.21	46.00	-14.79	QP
H	721.7259	13.74	26.47	40.21	46.00	-5.79	QP
H	836.2441	12.58	28.70	41.28	46.00	-4.72	QP
H	962.1621	11.20	31.33	42.53	54.00	-11.47	QP

Remark:
Factor = Antenna Factor + Cable Loss - Amplifier.

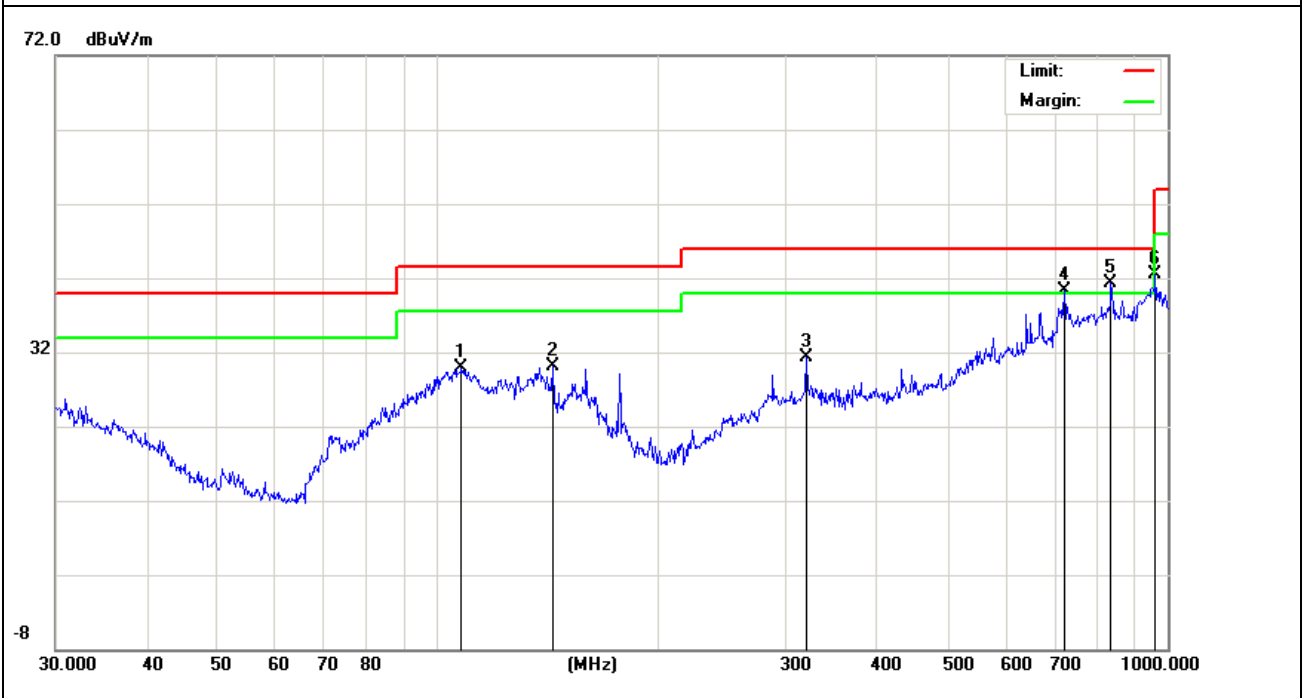

EUT:	LED Monitor	Model Name:	PX347c Prime
Temperature:	24 °C	Relative Humidity:	54%
Pressure:	1010 hPa	Test Date :	2017-5-3
Test Mode :	Mode 3(L)	Polarization :	Vertical
Test Power :	AC 120V/60Hz		

Polar (H/V)	Frequency	Meter Reading	Factor	Emission Level	Limits	Margin	Remark
	(MHz)	(dBuV)	(dB)	(dBuV/m)	(dBuV/m)	(dB)	
V	102.7192	24.43	12.07	36.50	43.50	-7.00	QP
V	176.2684	17.63	11.55	29.18	43.50	-14.32	QP
V	287.9904	15.93	15.94	31.87	46.00	-14.13	QP
V	432.5457	15.92	20.67	36.59	46.00	-9.41	QP
V	547.0977	12.12	24.68	36.80	46.00	-9.20	QP
V	866.0878	13.79	29.11	42.90	46.00	-3.10	QP

Remark:
Factor = Antenna Factor + Cable Loss - Amplifier.

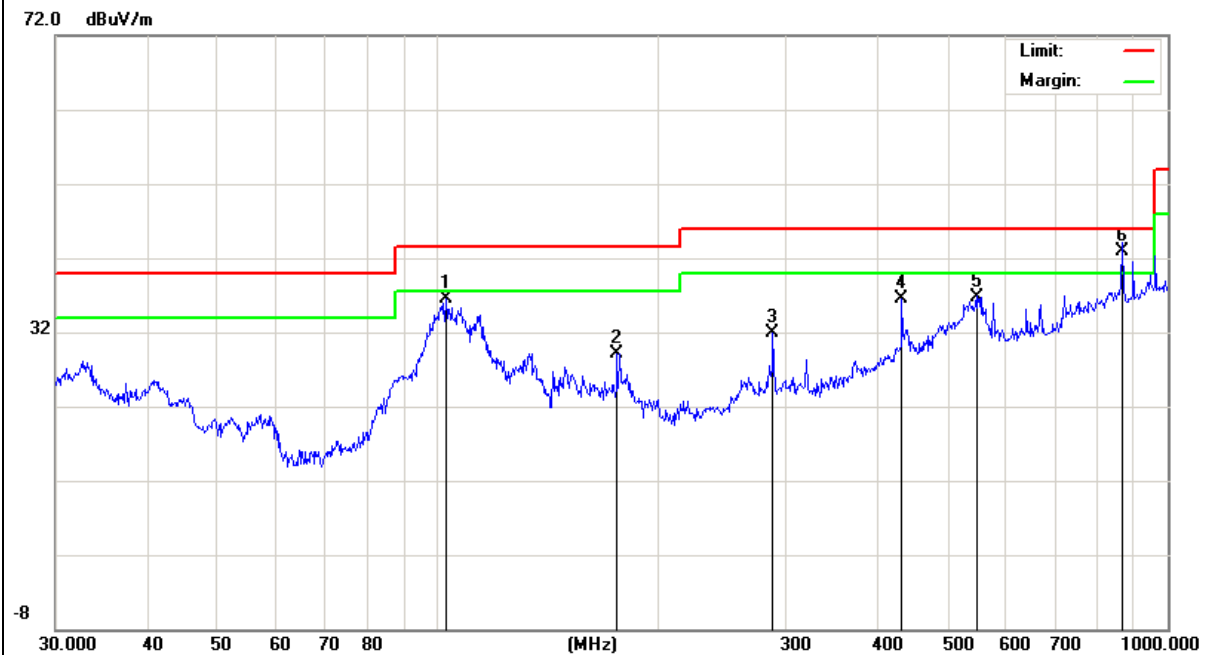

3.2.5 TEST RESULTS(1000~6000MHz)

EUT:	LED Monitor	Model Name :	PX347c Prime
Temperature:	24 °C	Relative Humidity:	54%
Pressure:	1010 hPa	Test Date :	2017-5-3
Test Mode :	Mode 3(H)		
Test Power :	AC 120V/60Hz		

All the modulation modes have been tested, and the worst result was report as below:

Polar (H/V)	Frequency	Reading	Correct	Result	Limit	Over Limit	Remark
	(MHz)	(dBuV/m)	dB/m	(dBuV/m)	(dBuV/m)	(dB)	
V	1414.13	51.81	-12	39.80	74	-34.20	Pk
V	1414.13	46.02	-12	34.00	54	-20.00	AV
V	1865.51	46.82	-10.2	36.67	74	-37.33	Pk
V	1865.45	47.14	-10.1	37.00	54	-17.00	AV
V	3280.31	42.97	-7.87	35.10	74	-38.90	Pk
V	3280.32	38.25	-7.88	30.37	54	-23.63	AV
H	1408.07	56.13	-12	44.10	74	-29.90	Pk
H	1408.08	49.49	-12	37.48	54	-16.52	AV
H	3004.59	48.54	-10.2	38.30	74	-35.70	Pk
H	3004.64	49.36	-10.2	39.14	54	-14.86	AV
H	4891.74	44.84	-7.84	37.00	74	-37.00	Pk
H	4891.49	38.83	-7.82	31.01	54	-22.99	AV

Remark:

Emission Level = Read Level+Antenna Factor + Cable Loss - Amplifier.

Margin= Emission Level-Limits

Note:

1. Measuring frequencies from 1 GHz to 13GHz.
2. Radiated emissions measured in frequency above 1000MHz were made with an instrument using
Peak detector mode of the emission shown in Actual FS column.
3. The frequency that above 3GHz is mainly from the environment noise

EUT:	LED Monitor	Model Name :	PX347c Prime
Temperature:	24 °C	Relative Humidity:	54%
Pressure:	1010 hPa	Test Date :	2017-5-3
Test Mode :	Mode 3(M)		
Test Power :	AC 120V/60Hz		

All the modulation modes have been tested, and the worst result was report as below:

Pol ar (H/V)	Frequency	Readin g	Correct	Result	Limit	Over Limit	Remar k
	(MHz)	(dBuV/ m)	dB/m	(dBuV/ m)	(dBuV/ m)	(dB)	
V	1573.52	46.67	-11.07	35.60	74	-38.40	Pk
V	1573.63	48.67	-11.07	37.60	54	-16.40	AV
V	1865.51	46.82	-11.10	35.72	74	-38.28	Pk
V	1865.71	48.60	-11.09	37.51	54	-16.49	AV
V	3274.43	43.99	-7.89	36.10	74	-37.90	Pk
V	3274.55	37.90	-7.89	30.01	54	-23.99	AV
H	1573.52	55.57	-11.47	44.10	74	-29.90	Pk
H	1573.67	48.89	-11.45	37.44	54	-16.56	AV
H	2742.22	46.41	-10.21	36.20	74	-37.80	Pk
H	2742.32	46.92	-10.19	36.73	54	-17.27	AV
H	4512.57	40.22	-0.62	39.60	74	-34.40	Pk
H	4512.77	38.83	-0.62	38.21	54	-15.79	AV

Remark:

Emission Level = Read Level+Antenna Factor + Cable Loss - Amplifier.

Margin= Emission Level-Limits

Note:

1. Measuring frequencies from 1 GHz to 13GHz.
2. Radiated emissions measured in frequency above 1000MHz were made with an instrument using Peak detector mode of the emission shown in Actual FS column.
3. The frequency that above 3GHz is mainly from the environment noise

EUT:	LED Monitor	Model Name :	PX347c Prime
Temperature:	24 °C	Relative Humidity:	54%
Pressure:	1010 hPa	Test Date :	2017-5-3
Test Mode :	Mode 3(L)		
Test Power :	AC 120V/60Hz		

All the modulation modes have been tested, and the worst result was report as below:

Polar (H/V)	Frequency	Reading	Correct	Result	Limit	Over Limit	Remark
	(MHz)	(dBuV/m)	dB/m	(dBuV/m)	(dBuV/m)	(dB)	
V	1413.13	45.71	-12.01	33.70	74	-40.30	Pk
V	1413.16	46.02	-12.01	34.01	54	-19.99	AV
V	2227.55	53.39	-11.09	42.30	74	-31.70	Pk
V	2227.58	46.52	-11.08	35.44	54	-18.56	AV
V	2752.04	47.14	-10.14	37.00	74	-37.00	Pk
V	2752.11	45.89	-10.12	35.77	54	-18.23	AV
H	1666.38	53.29	-11.19	42.10	74	-31.90	Pk
H	1666.42	51.90	-11.10	40.80	54	-13.20	AV
H	2732.39	47.38	-10.28	37.10	74	-36.90	Pk
H	2732.13	51.11	-10.27	40.84	54	-13.16	AV
H	3303.86	46.54	-7.84	38.70	74	-35.30	Pk
H	3303.91	38.83	-7.83	31.00	54	-23.00	AV

Remark:

Emission Level = Read Level+Antenna Factor + Cable Loss - Amplifier.

Margin= Emission Level-Limits

Note:

1. Measuring frequencies from 1 GHz to 13GHz.

2. Radiated emissions measured in frequency above 1000MHz were made with an instrument using

Peak detector mode of the emission shown in Actual FS column.

3. The frequency that above 3GHz is mainly from the environment noise

4. EUT TEST PHOTO

Radiated Measurement Photos

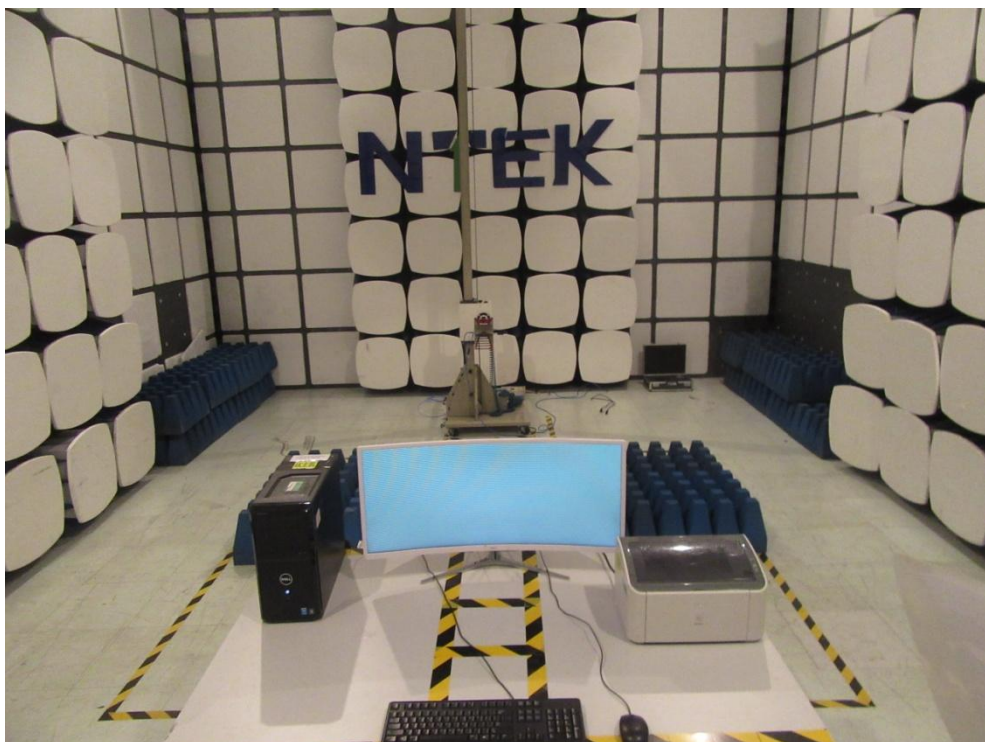

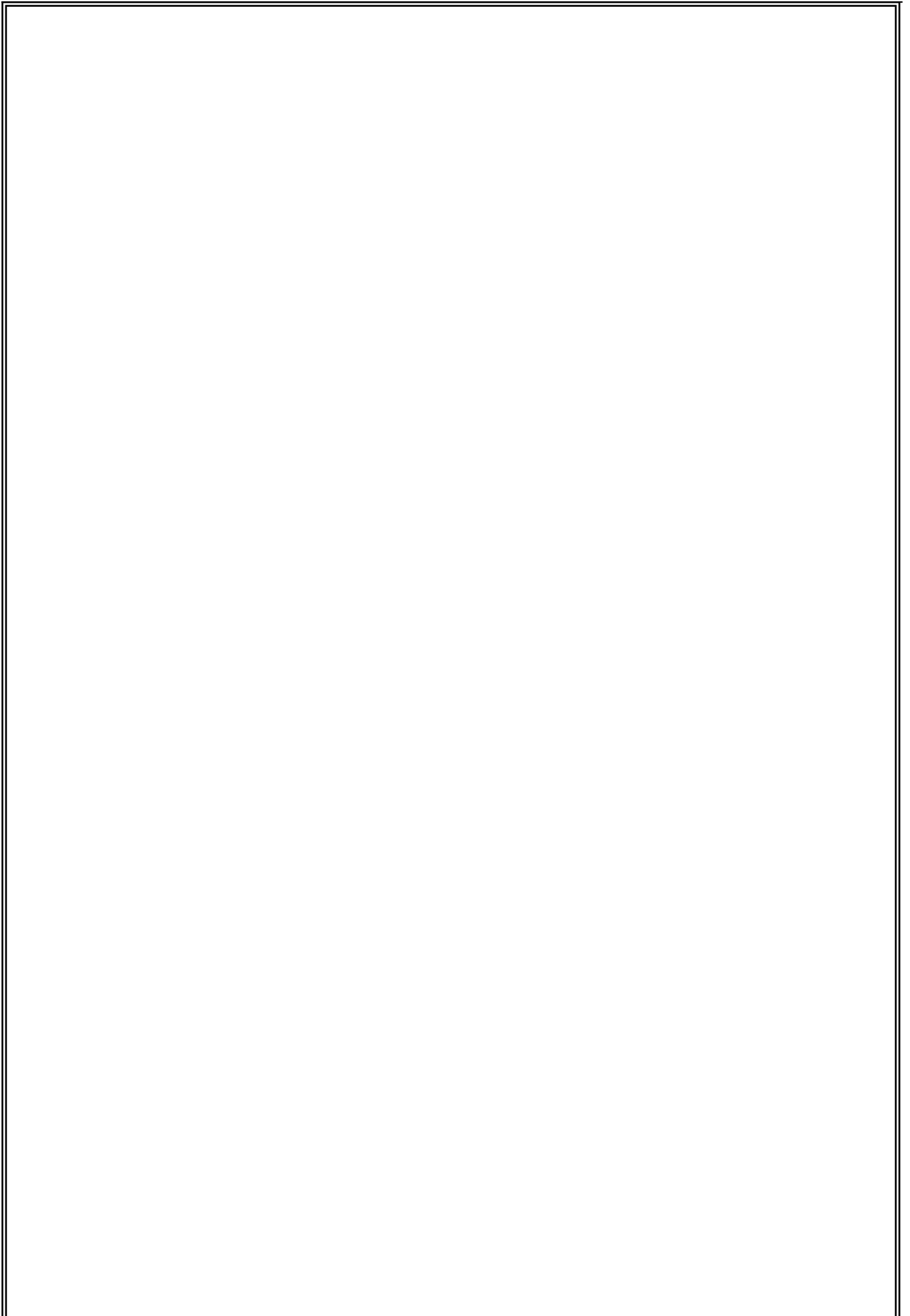

Conducted Measurement Photos

