

# SPECIFICATION

Product Name: Lighting Control Switch(Motion Sensor)

Model No.: MC083V (American Version)

Issue Date: August 28, 2018

CUSTOMER APPROVED

## 1. Features

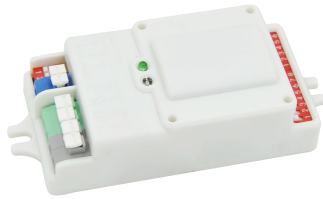

- High installation for car parks, etc.
- Work with 1-10V dimmable LED driver, easy to achieve 2-step or 3-step dimming function.
- DIP setting allows the user easy to adjust sensor parameters.

## 2. Parameter

<b>Input</b>	Operating Voltage Range	108-305V AC 50/60Hz
	DC Input Voltage	N/A
	Rated Voltage	120/277V AC 50/60Hz
	No-load Power	N/A
	Stand-by Power	≤0.5W
	Surge Test	L--N:1kV
<b>Output</b>	Working Mode	ON/OFF function, 1-10V step dimming
	Type of Load	Inductive or Resistive Load
	Load Capacity	400W @120Vac, 800W @277Vac (Inductive) 800W @120Vac, 1000W @230Vac (Resistive)
	Current of Load	N/A
	Max. Surge Capacity	30A (50% I <sub>peak</sub> , t <sub>width</sub> =500us, 230Vac full load, cold start); 60A (50% I <sub>peak</sub> , t <sub>width</sub> =200us, 230Vac, full load, cold start)
<b>Dim Interface</b>	1-10V Dimming	20mA Max
	Synchronous Control	N/A
	High Low-level	N/A
	PWM Control	N/A
<b>Sensor Parameters</b>	Operating Frequency	5.8 GHz ±75 MHz, ISM Band.
	Transmitting power	0.5mW Max.
	Hold time	5S/30S/90S/3min/20min/30min
	Stand-by DIM Level	25%(2.2-2.5V)/35%(3.0-3.5V)/50%(5.0-5.5V)
	Stand-by Period	0S/5S/5min/10min/30min/1h/+∞
	Detection Area	100%/75%/50%/10%
	Daylight Sensor	2Lux/5Lux/10Lux/25Lux/50Lux/100Lux/Disable (Ambient light diffusion)
	Daylight on/off	N/A
	Detecting Radius	4-6m(ceiling mounting: 8m) See note 2
	Mounting Height	15m Max
	Detecting Angle	150°(wall mounting) 360°(ceiling mounting)

Shenzhen Merrytek Technology Co.,Ltd

Add: 2<sup>nd</sup> and 3<sup>rd</sup> floor, NO.3 Building, 380 Xiangshan Avenue, Luotian, Yanluo, Baoan, Shenzhen, 518127, China  
Tel: +86 (0)755-2305 7253 Fax: +86 (0)755-2786 3012 Website: www.merrytek.com

<b>Wireless Module</b>	Operating Frequency	N/A
	Transmitting power	N/A
	Transmitting distance	N/A
	Modulation mode	N/A
	Number of coding	N/A
<b>Operating Environment</b>	Operating Temperature	-25°C...+60°C
	Storage Temperature	Temperature: -40°C...+80°C; Humidity: 10%-95% (non-condensing)
<b>Certificate Standards</b>	Safety standards	EN61058-1
	EMC standards	EN300440; EN301489-1; EN55015; EN61547; EN61000-3-2; EN61000-3-3; EN62479
	Environmental Requirement	Compliant to RoHS
	Certificate	CE, RED,UL
<b>Others</b>	Wiring Method	Press terminal, wire diameter: 0.75-1.5mm <sup>2</sup>
	IP Rating	IP20
	Protection Class	Class II
	Installation	Built-in installation
	Dimension	93.5*45*28.5mm
	Package	Bubble bag +Clapboard+ Carton(K=A)
	Net Weight	61.2g
	Lifetime	50,000h @ Ta Full load

Note

1. "N/A" means not available.
2. Detection area is effected on volume of motion object and motion speed. The detection area is tested by a 165cm height person and walking speed is 0.5m/s.

### 3. Function

1) ON/OFF function (stand-by period be set to "0"s)

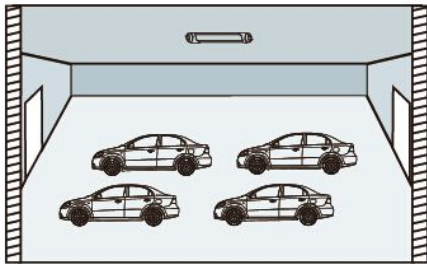

1 With sufficient ambient light, the light will not be switched on even if with motion signal.

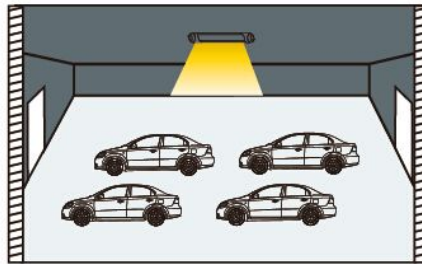

2 With insufficient ambient light, the sensor switches on the light when motion is detected.



3 After elapse of hold time, the sensor switches off the light when no motion is detected.

2) 2-step dimming function (stand-by period be set to "+∞")

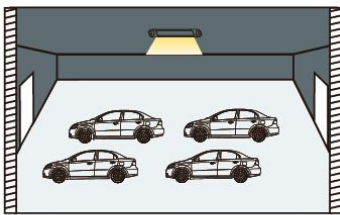

1 If there is no motion detected, the light will be remained at a low light level all the time.

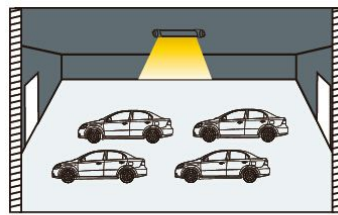

2 When motion is detected, the sensor will switch on the light to 100% brightness

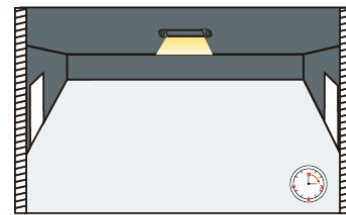

3 After elapse of hold time, the sensor dims the light at the present low light level if no motion is detected.

3) 3-step dimming function (stand-by period be set to "5S/5min/10min/30min/1h")

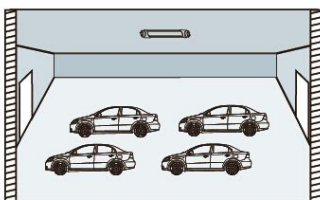

1 With sufficient ambient light, the light will not be switched on even if with motion signal.

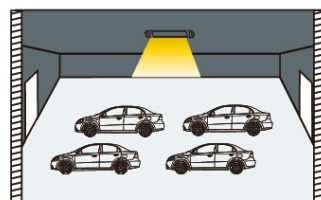

2 With insufficient ambient light, the sensor switches on the light when motion is detected.

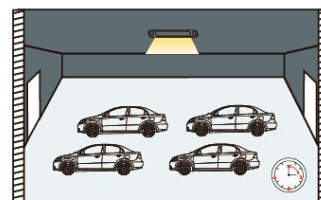

3 After elapse of hold time, the sensor dims the light at a low light level if no new motion is detected.



4 After elapse of standby period, the sensor switches off the light if no motion is detected in the detection zone.

#### 4. Dimension (mm)

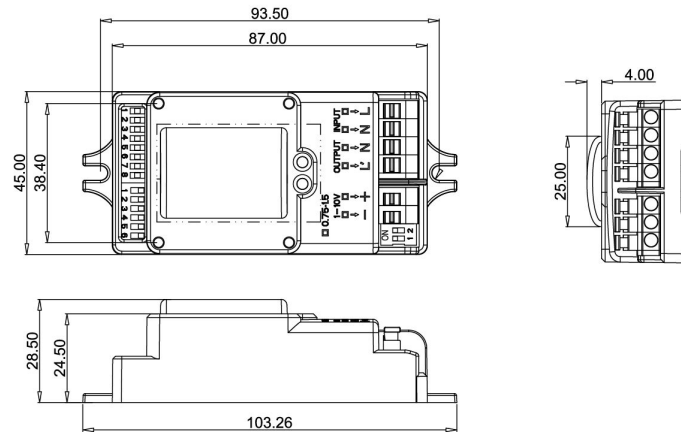

#### 5. Wiring

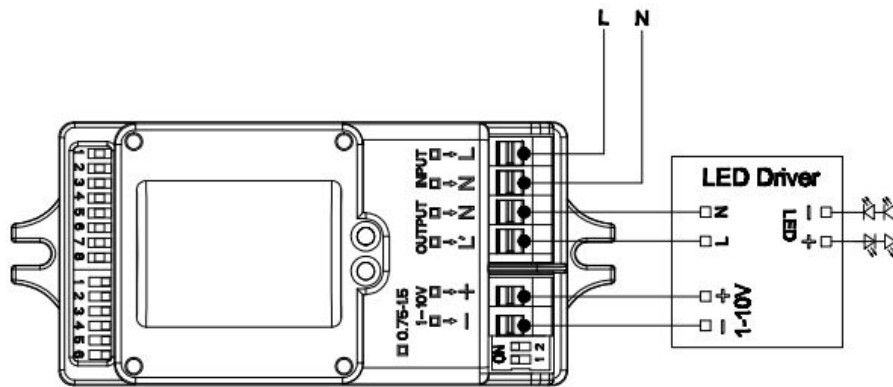

\*The sensor is designed for connect one load only. Connect more than one loads may damage the sensor.

#### 6. Structure

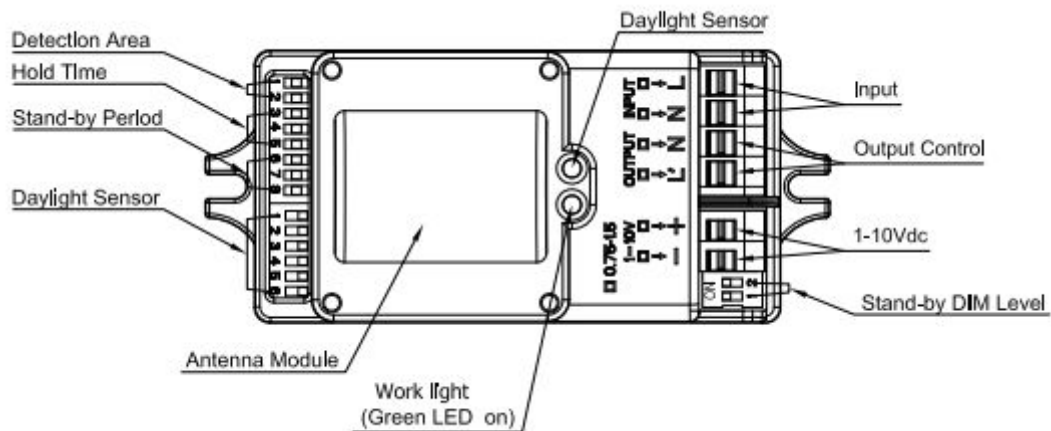

## 7. Radiation Pattern

### Ceiling mounting

Ceiling mounted height: 3m  
Sensitivity: 100%/75%/50%/10%

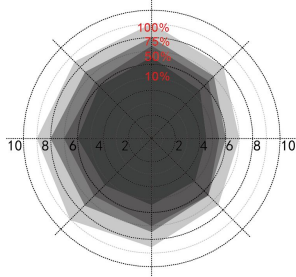

Normal moving (Speed:1m/s)

Ceiling mounted height: 9m  
Sensitivity: 100%/75%/50%/10%

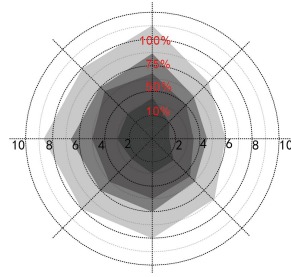

Normal moving (Speed:1m/s)

Ceiling mounted height: 15m (\*)  
Sensitivity: 100%/75%/50%

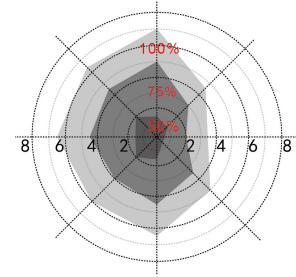

Normal moving (Speed:1m/s)

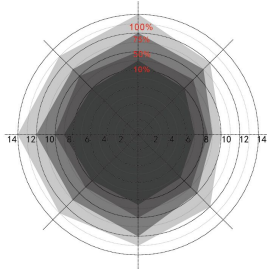

Slow moving (Speed 0.3m/s)

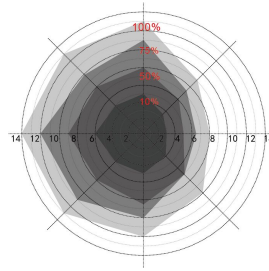

Slow moving (Speed 0.3m/s)

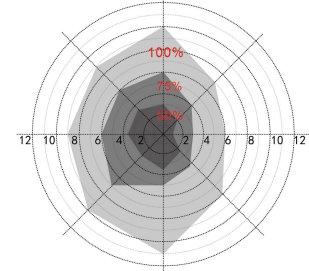

Slow moving (Speed 0.3m/s)

\*Only 100%/75%/50% detection sensitivity is workable when installed at 15m mounting height. 10% sensitivity is not able to detect motion signal.

### Wall mounting

Horizon mounted height: 2m  
Sensitivity: 100%/75%/50%/10%

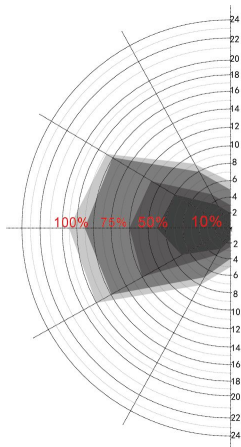

Normal moving (Speed: 1m/s)

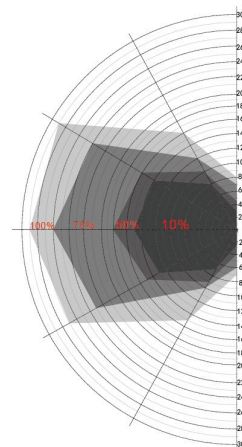

Slow moving (Speed 0.3m/s)

## 8. DIP Switch Setting

### Detection Area

	1	2	
I	ON	ON	100%
II	ON	-	75%
III	-	ON	50%
IV	-	-	10%

### Hold Time

	3	4	5	
I	ON	ON	ON	5s
II	-	ON	ON	30s
III	ON	-	ON	90s
IV	-	-	ON	3min
V	ON	ON	-	20min
VI	-	-	-	30min

### Stand-by Period

	6	7	8	
I	ON	ON	ON	0s
II	-	ON	ON	5s
III	ON	-	ON	5min
IV	-	-	ON	10min
V	ON	ON	-	30min
VI	-	ON	-	60min
VII	-	-	-	+∞

Shenzhen Merrytek Technology Co.,Ltd

Add: 2<sup>nd</sup> and 3<sup>rd</sup> floor, NO.3 Building, 380 Xiangshan Avenue, Luotian, Yanluo, Baoan, Shenzhen, 518127, China  
Tel: +86 (0)755-2305 7253 Fax: +86 (0)755-2786 3012 Website: www.merrytek.com

Stand-by Dim Level

	1	2	
I	ON	ON	50%
II	ON	-	35%
III	-	-	25%

Daylight Sensor

	1	2	3	4	5	6	
I	ON	ON	ON	ON	ON	ON	2lux
II	-	ON	ON	ON	ON	ON	5lux
III	ON	-	ON	ON	ON	ON	15lux
IV	ON	ON	-	ON	ON	ON	25lux
V	ON	ON	ON	-	ON	ON	50lux
VI	ON	ON	ON	ON	-	ON	100lux
VII	ON	ON	ON	ON	ON	-	Disable*

## 9.Initialization

1) On/Off function /3-step dimming function:

After power on, the sensor automatically turns on light at 100% brightness. After 10sec, it turns off the light. During the initialization, the sensor is not able to detect movement.

2) 2-step dimming function:

After power on, the sensor automatically turns on light at 100% brightness. After 10sec, it dims the light to a low light level (set by stand-by dim level). During the initialization, the sensor is not able to detect movement.

## 10. Application Notice

The sensor is designed to work with active 1-10V dimmable LED driver.



## 11. Version Change

Version	Date	Description
A0	August 28, 2018	Released new product

## FCC Warning

This device complies with part 15 of the FCC rules. Operation is subject to the following two conditions: (1) this device may not cause harmful interference, and (2) this device must accept any interference received, including interference that may cause undesired operation.

Changes or modifications not expressly approved by the party responsible for compliance could void the user's authority to operate the equipment.

NOTE: This equipment has been tested and found to comply with the limits for a Class B digital device, pursuant to part 15 of the FCC Rules. These limits are designed to provide reasonable protection against harmful interference in a residential installation. This equipment generates uses and can radiate radio frequency energy and, if not installed and used in accordance with the instructions, may cause harmful interference to radio communications. However, there is no guarantee that interference will not occur in a particular installation. If this equipment does cause harmful interference to radio or television reception, which can be determined by turning the equipment off and on, the user is encouraged to try to correct the interference by one or more of the following measures:

- Reorient or relocate the receiving antenna.
- Increase the separation between the equipment and receiver.
- Connect the equipment into an outlet on a circuit different from that to which the receiver is connected.
- Consult the dealer or an experienced radio/TV technician for help.

## Radiation Exposure Statement

This equipment complies with FCC radiation exposure limits set forth for an uncontrolled environment. This equipment should be installed and operated with minimum distance 20cm between the radiator and your body.