



# **FCC RADIO TEST REPORT**

## **FCC ID: 2AI4FGANKERV15**

**Product :** Ganker

**Trade Name :** N/A

**Model Name:** Ganker V1.5

**Serial Model :** N/A

**Report No. :** POCE-160711011F

### **Prepared for**

Shenzhen GJS technology co., LTD

5-110, Shenzhen-Hong Kong Youth Innovation and Entrepreneur Hub,  
Qianhai Pilot Free trade Zone, Nanshan, Shenzhen, China

### **Prepared by**

Shenzhen POCE Technology Co.,Ltd.

Room 502, Bldg. 1, Xinghua Garden, Baoan Road Xixiang,  
Baoan District, Shenzhen, China

## TEST RESULT CERTIFICATION

**Applicant's name** ..... : Shenzhen GJS technology co., LTD  
**Address** ..... : 5-110, Shenzhen-Hong Kong Youth Innovation and Entrepreneur Hub, Qianhai Pilot Free trade Zone, Nanshan, Shenzhen, China  
**Manufacturer's Name** ..... : Shenzhen GJS technology co., LTD  
**Address** ..... : 5-110, Shenzhen-Hong Kong Youth Innovation and Entrepreneur Hub, Qianhai Pilot Free trade Zone, Nanshan, Shenzhen, China

### Product description

**Product name** ..... : Ganker  
**Model and/or type reference** : Ganker V1.5  
**Trade Name** : N/A

**Standards** ..... : FCC Part15.247

**Test procedure** ..... ANSI C63.10-2013

This device described above has been tested by POCE, and the test results show that the equipment under test (EUT) is in compliance with the FCC requirements. And it is applicable only to the tested sample identified in the report.

This report shall not be reproduced except in full, without the written approval of POCE, this document may be altered or revised by POCE, personal only, and shall be noted in the revision of the document.

**Date of Test** ..... :

**Date (s) of performance of tests** ..... : 06 Jul. 2016 ~12 Jul. 2016

**Date of Issue** ..... : 12 Jul. 2016

**Test Result** ..... : **Pass**

Testing Engineer :



(Ken Li)

Technical Manager :



(Jimmy Yao)

Authorized Signatory :

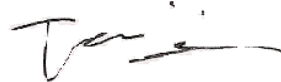

(Terry Yang)

**Table of Contents**

	<b>Page</b>
<b>1 . SUMMARY OF TEST RESULTS</b>	<b>5</b>
1.1 TEST FACILITY	6
1.2 MEASUREMENT UNCERTAINTY	6
<b>2 . GENERAL INFORMATION</b>	<b>7</b>
2.1 GENERAL DESCRIPTION OF EUT	7
2.2 DESCRIPTION OF TEST MODES	9
2.3 BLOCK DIGRAM SHOWING THE CONFIGURATION OF SYSTEM TESTED	10
2.4 DESCRIPTION OF SUPPORT UNITS(CONDUCTED MODE)	11
2.5 EQUIPMENTS LIST FOR ALL TEST ITEMS	12
<b>3 . EMC EMISSION TEST</b>	<b>13</b>
3.1 CONDUCTED EMISSION MEASUREMENT	13
3.1.1 POWER LINE CONDUCTED EMISSION LIMITS	13
3.1.2 TEST PROCEDURE	14
3.1.3 DEVIATION FROM TEST STANDARD	14
3.1.4 TEST SETUP	14
3.1.5 EUT OPERATING CONDITIONS	14
3.1.6 TEST RESULTS	15
3.2 RADIATED EMISSION MEASUREMENT	17
3.2.1 RADIATED EMISSION LIMITS	17
3.2.2 TEST PROCEDURE	18
3.2.3 DEVIATION FROM TEST STANDARD	18
3.2.4 TEST SETUP	19
3.2.5 EUT OPERATING CONDITIONS	20
3.2.6 TEST RESULTS (BETWEEN 9KHZ – 30 MHZ)	21
3.2.7 TEST RESULTS (BETWEEN 30MHZ – 1GHZ)	22
3.2.8 TEST RESULTS (ABOVE 1000 MHZ)	23
<b>4 . POWER SPECTRAL DENSITY TEST</b>	<b>26</b>
4.1 APPLIED PROCEDURES / LIMIT	26
4.1.1 TEST PROCEDURE	26
4.1.2 DEVIATION FROM STANDARD	26
4.1.3 TEST SETUP	26
4.1.4 EUT OPERATION CONDITIONS	26
4.1.5 TEST RESULTS	27
<b>5 . BANDWIDTH TEST</b>	<b>33</b>
5.1 APPLIED PROCEDURES / LIMIT	33
5.1.1 TEST PROCEDURE	33
5.1.2 DEVIATION FROM STANDARD	33

<b>Table of Contents</b>	<b>Page</b>
5.1.3 TEST SETUP	33
5.1.4 EUT OPERATION CONDITIONS	33
5.1.5 TEST RESULTS	34
<b>6 . PEAK OUTPUT POWER TEST</b>	<b>40</b>
6.1 APPLIED PROCEDURES / LIMIT	40
6.1.1 TEST PROCEDURE	40
6.1.2 DEVIATION FROM STANDARD	40
6.1.3 TEST SETUP	40
6.1.4 EUT OPERATION CONDITIONS	40
6.1.5 TEST RESULTS	41
<b>7 . 100 KHZ BANDWIDTH OF FREQUENCY BAND EDGE</b>	<b>42</b>
7.1 DEVIATION FROM STANDARD	42
7.2 TEST SETUP	42
7.3 EUT OPERATION CONDITIONS	42
7.4 TEST RESULTS	43
<b>8 . ANTENNA REQUIREMENT</b>	<b>47</b>
8.1 STANDARD REQUIREMENT	47
8.2 EUT ANTENNA	47
<b>9 . EUT TEST PHOTO</b>	<b>48</b>
<b>APPENDIX-PHOTOGRAPHS OF EUT CONSTRUCTIONAL DETAILS</b>	

## 1. SUMMARY OF TEST RESULTS

Test procedures according to the technical standards:

<b>FCC Part15 (15.247) , Subpart C</b>			
Standard Section	Test Item	Judgment	Remark
15.207	Conducted Emission	PASS	
15.247 (a)(2)	6dB Bandwidth	PASS	
15.247 (b)	Peak Output Power	PASS	
15.247 (c)	Radiated Spurious Emission	PASS	
15.247 (d)	Power Spectral Density	PASS	
15.205	Band Edge Emission	PASS	
15.203	Antenna Requirement	PASS	

**NOTE:**

(1) "N/A" denotes test is not applicable in this Test Report

## 1.1 TEST FACILITY

Shenzhen POCE Technology Co.,Ltd.

Add.: Room 502, Bldg. 1, Xinghua Garden, Baoan Road Xixiang, Baoan District, Shenzhen, China

FCC-Registration No.: 222278

## 1.2 MEASUREMENT UNCERTAINTY

The reported uncertainty of measurement  $y \pm U$ , where expanded uncertainty  $U$  is based on a standard uncertainty multiplied by a coverage factor of  $k=2$ , providing a level of confidence of approximately 95 %.

No.	Item	Uncertainty
1	Conducted Emission Test	$\pm 1.38\text{dB}$
2	RF power,conducted	$\pm 0.16\text{dB}$
3	Spurious emissions,conducted	$\pm 0.21\text{dB}$
4	All emissions,radiated(<1G)	$\pm 4.68\text{dB}$
5	All emissions,radiated(>1G)	$\pm 4.89\text{dB}$
6	Temperature	$\pm 0.5^{\circ}\text{C}$
7	Humidity	$\pm 2\%$

## 2. GENERAL INFORMATION

### 2.1 GENERAL DESCRIPTION OF EUT

Equipment	Ganker	
Trade Name	N/A	
Model Name	Ganker V1.5	
Serial Model	N/A	
Model Difference	N/A	
Product Description	The EUT is a Ganker	
	Operation Frequency:	802.11b/g/n20MHz:2412~2462 MHz
	Modulation Type:	CCK/OFDM/DBPSK/DAPSK
	Bit Rate of Transmitter	802.11b:11/5.5/2/1 Mbps 802.11g:54/48/36/24/18/12/9/6Mbps 802.11n(20MHz): 78/52/6.5Mbps
	Number Of Channel	802.11b/g/n20MHz:11CH
	Antenna Designation:	Please see Note 3.
	Output Power(Conducted,AV):	802.11b: 9.12 dBm (Max.) 802.11g: 7.79 dBm (Max.) 802.11n(20M) : 7.77dBm (Max.)
	Antenna Gain (dBi)	0.9dbi
	Based on the application, features, or specification exhibited in User's Manual, the EUT is considered as an ITE/Computing Device. More details of EUT technical specification, please refer to the User's Manual.	
Channel List	Please refer to the Note 2.	
Adapter	AC Power Input: 100-240V~, 50/60Hz, 0.3A Output: 5.0V---, 2.0A	
Battery	DC7.4V	
Connecting I/O Port(s)	Please refer to the User's Manual	

Note:

1. For a more detailed features description, please refer to the manufacturer's specifications or the User's Manual.

2.

Channel List for 802.11b/g/n(20)							
Channel	Frequency (MHz)	Channel	Frequency (MHz)	Channel	Frequency (MHz)	Channel	Frequency (MHz)
01	2412	04	2427	07	2442	10	2457
02	2417	05	2432	08	2447	11	2462
03	2422	06	2437	09	2452		

3.

Table for Filed Antenna

Ant	Brand	Model Name	Antenna Type	Connector	Gain (dBi)	NOTE
A	N/A	N/A	Integrated antenna	N/A	0.9	Wifi Antenna



## 2.2 DESCRIPTION OF TEST MODES

To investigate the maximum EMI emission characteristics generates from EUT, the test system was pre-scanning tested base on the consideration of following EUT operation mode or test configuration mode which possible have effect on EMI emission level. Each of these EUT operation mode(s) or test configuration mode(s) mentioned above was evaluated respectively.

Pretest Mode	Description
Mode 1	802.11b CH1/ CH6/ CH11
Mode 2	802.11g CH1/ CH6/ CH11
Mode 3	802.11n CH1/ CH6/ CH11
Mode 4	Link Mode

For Conducted Emission	
Final Test Mode	Description
Mode 4	Link Mode

For Radiated Emission	
Final Test Mode	Description
Mode 1	802.11b CH1/ CH6/ CH11
Mode 2	802.11g CH1/ CH6/ CH11
Mode 3	802.11n CH1/ CH6/ CH11
Mode 4	Link Mode

Note:

- (1) The measurements are performed at the highest, middle, lowest available channels.
- (2) The measurements are performed at all Bit Rate of Transmitter, the worst data was reported

### 2.3 BLOCK DIGRAM SHOWING THE CONFIGURATION OF SYSTEM TESTED

Conducted Emission Test

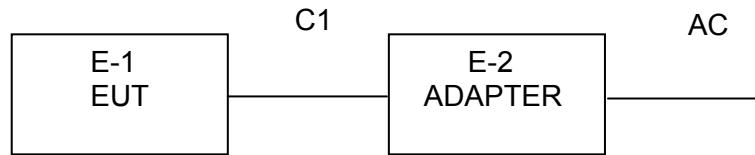

Radiated Spurious Emission Test

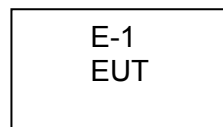

### 2.4 DESCRIPTION OF SUPPORT UNITS(CONDUCTED MODE)

The EUT has been tested as an independent unit together with other necessary accessories or support units. The following support units or accessories were used to form a representative test configuration during the tests.

Item	Equipment	Mfr/Brand	Model/Type No.	Series No.	Note
E-1	Ganker	E-matic	Ganker V1.5	N/A	EUT
E-2	Adapter	N/A	PGAE0500200U1UL	N/A	

Item	Shielded Type	Ferrite Core	Length	Note
C-1	NO	NO	0.9M	

Note:

- (1) The support equipment was authorized by Declaration of Confirmation.
- (2) For detachable type I/O cable should be specified the length in cm in 『Length』 column.

## 2.5 EQUIPMENTS LIST FOR ALL TEST ITEMS

### Radiation Test equipment

Item	Kind of Equipment	Manufacturer	Type No.	Serial No.	Last calibration	Calibrated until	Calibration period
1	Spectrum Analyzer	Agilent	E4407B	MY45108040	2016.07.06	2017.07.05	1 year
2	Test Receiver	R&S	ESPI	101318	2016.06.07	2017.06.06	1 year
3	Bilog Antenna	TESEQ	CBL6111D	31216	2016.07.06	2017.07.05	1 year
4	50Ω Coaxial Switch	Anritsu	MP59B	6200264416	2016.06.07	2017.06.06	1 year
5	Spectrum Analyzer	ADVANTEST	R3132	150900201	2016.06.07	2017.06.06	1 year
6	Horn Antenna	EM	EM-AH-10180	2011071402	2016.07.06	2017.07.05	1 year
7	Horn Ant	Schwarzbeck	BBHA 9170	9170-181	2016.07.06	2017.07.05	1 year
8	Amplifier	EM	EM-30180	060538	2015.12.22	2016.12.21	1 year
9	Loop Antenna	ARA	PLA-1030/B	1029	2016.06.08	2017.06.07	1 year
10	Power Meter	R&S	NRVS	100696	2016.07.06	2017.07.05	1 year
11	Power Sensor	R&S	URV5-Z4	0395.1619.05	2016.07.06	2017.07.05	1 year

### Conduction Test equipment

Item	Kind of Equipment	Manufacturer	Type No.	Serial No.	Last calibration	Calibrated until	Calibration period
1	Test Receiver	R&S	ESCI	101160	2016.06.06	2017.06.05	1 year
2	LISN	R&S	ENV216	101313	2015.08.24	2016.08.23	1 year
3	LISN	EMCO	3816/2	00042990	2015.08.24	2016.08.23	1 year
4	50Ω Coaxial Switch	Anritsu	MP59B	6200264417	2016.06.07	2017.06.06	1 year
5	Passive Voltage Probe	R&S	ESH2-Z3	100196	2016.06.07	2017.06.06	1 year
6	Absorbing clamp	R&S	MOS-21	100423	2016.06.08	2017.06.07	1 year

### 3. EMC EMISSION TEST

#### 3.1 CONDUCTED EMISSION MEASUREMENT

##### 3.1.1 POWER LINE CONDUCTED EMISSION Limits (Frequency Range 150KHz-30MHz)

FREQUENCY (MHz)	Class A (dBuV)		Class B (dBuV)		Standard
	Quasi-peak	Average	Quasi-peak	Average	
0.15 -0.5	79.00	66.00	66 - 56 *	56 - 46 *	CISPR
0.50 -5.0	73.00	60.00	56.00	46.00	CISPR
5.0 -30.0	73.00	60.00	60.00	50.00	CISPR

0.15 -0.5	79.00	66.00	66 - 56 *	56 - 46 *	FCC
0.50 -5.0	73.00	60.00	56.00	46.00	FCC
5.0 -30.0	73.00	60.00	60.00	50.00	FCC

Note:

- (1) The tighter limit applies at the band edges.
- (2) The limit of " \* " marked band means the limitation decreases linearly with the logarithm of the frequency in the range.

The following table is the setting of the receiver

Receiver Parameters	Setting
Attenuation	10 dB
Start Frequency	0.15 MHz
Stop Frequency	30 MHz
IF Bandwidth	9 kHz

**3.1.2 TEST PROCEDURE**

- a. The EUT was placed 0.8 meters from the horizontal ground plane with EUT being connected to the power mains through a line impedance stabilization network (LISN). All other support equipments powered from additional LISN(s). The LISN provide 50 Ohm/ 50uH of coupling impedance for the measuring instrument.
- b. Interconnecting cables that hang closer than 40 cm to the ground plane shall be folded back and forth in the center forming a bundle 30 to 40 cm long.
- c. I/O cables that are not connected to a peripheral shall be bundled in the center. The end of the cable may be terminated, if required, using the correct terminating impedance. The overall length shall not exceed 1 m.
- d. LISN at least 80 cm from nearest part of EUT chassis.
- e. For the actual test configuration, please refer to the related Item –EUT Test Photos.

**3.1.3 DEVIATION FROM TEST STANDARD**

No deviation

**3.1.4 TEST SETUP**

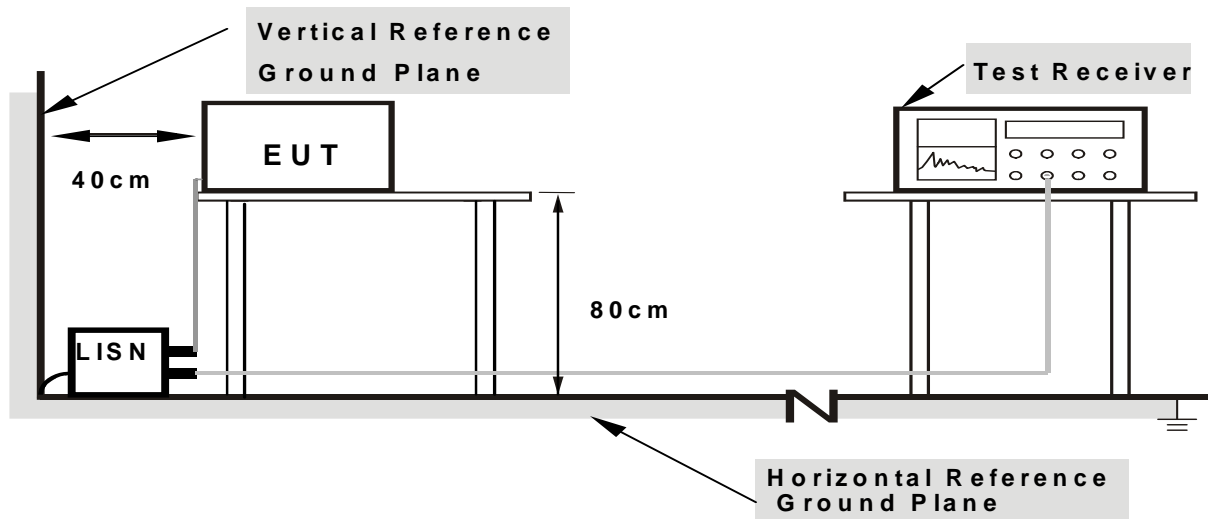

- Note:**
- 1. Support units were connected to second LISN.
  - 2. Both of LISNs (AMN) are 80 cm from EUT and at least 80 from other units and other metal planes

**3.1.5 EUT OPERATING CONDITIONS**

The EUT was configured for testing in a typical fashion (as a customer would normally use it). The EUT has been programmed to continuously transmit during test. This operating condition was tested and used to collect the included data.

### 3.1.6 TEST RESULTS

EUT :	Ganker	Model Name. :	Ganker V1.5
Temperature :	26 °C	Relative Humidity :	54%
Pressure :	1010hPa	Phase :	L
Test Voltage :	AC120V/60Hz	Test Mode :	Mode 4

Frequency (MHz)	Meter Reading (dBμV)	Factor (dB)	Emission Level (dBμV)	Limits (dBμV)	Margin (dB)	Detector Type
0.634	38.91	10.13	49.04	56	-6.96	QP
0.634	21.32	10.13	31.45	46	-14.55	AVG
0.854	34.19	10.15	44.34	56	-11.66	QP
0.854	15.29	10.15	25.44	46	-20.56	AVG
1.414	34.07	10.17	44.24	56	-11.76	QP
1.414	14.31	10.17	24.48	46	-21.52	AVG
1.954	33.29	10.18	43.47	56	-12.53	QP
1.954	12.67	10.18	22.85	46	-23.15	AVG
2.946	13.67	10.19	23.86	46	-22.14	AVG
2.9539	31.82	10.19	42.01	56	-13.99	QP
10.626	39.5	10.13	49.63	60	-10.37	QP

Remark:

1. All readings are Quasi-Peak and Average values.
2. Factor = Insertion Loss + Cable Loss.

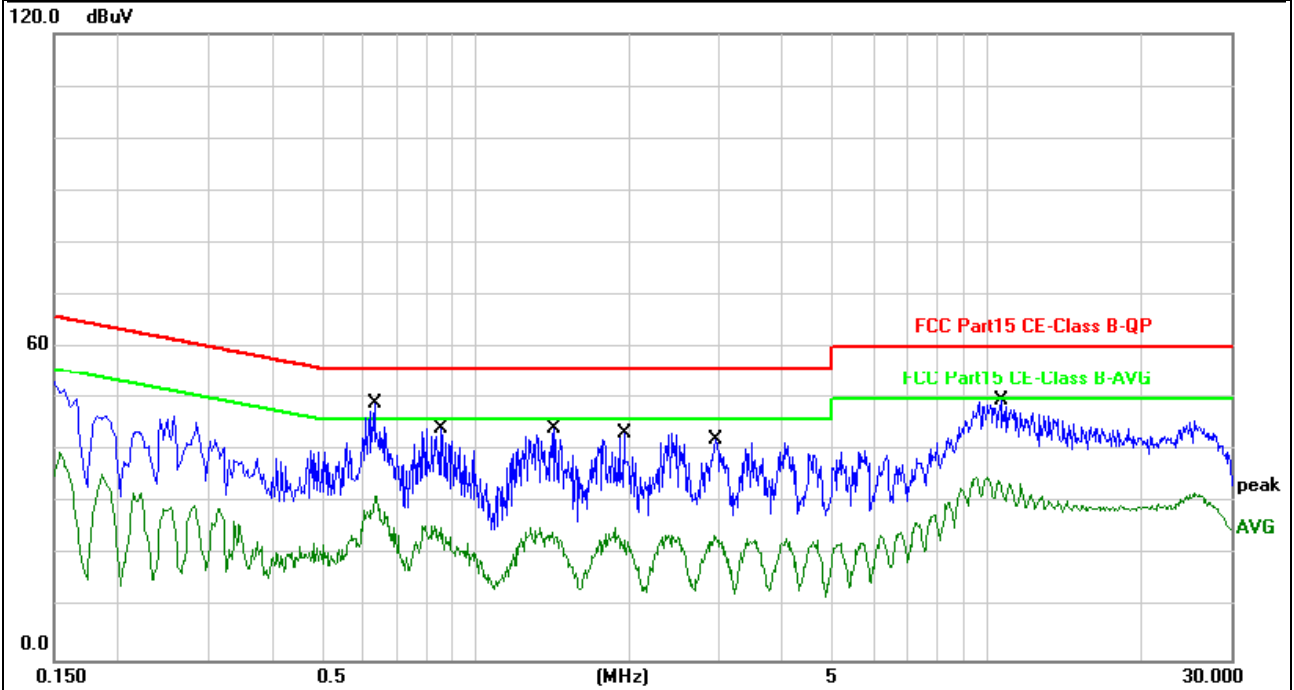

EUT :	Ganker	Model Name. :	Ganker V1.5
Temperature :	26 °C	Relative Humidity :	54%
Pressure :	1010hPa	Phase :	N
Test Voltage :	AC120V/60Hz	Test Mode :	Mode 4

Frequency (MHz)	Meter Reading (dBμV)	Factor (dB)	Emission Level (dBμV)	Limits (dBμV)	Margin (dB)	Detector Type
0.634	40.77	10.13	50.9	56	-5.1	QP
0.634	27.31	10.13	37.44	46	-8.56	AVG
1.386	34.13	10.17	44.3	56	-11.7	QP
1.386	20.69	10.17	30.86	46	-15.14	AVG
1.842	33.83	10.18	44.01	56	-11.99	QP
1.842	21.01	10.18	31.19	46	-14.81	AVG
2.366	33.44	10.18	43.62	56	-12.38	QP
2.366	21.26	10.18	31.44	46	-14.56	AVG
10.162	40.7	10.12	50.82	60	-9.18	QP
10.162	29.22	10.12	39.34	50	-10.66	AVG
12.226	38.04	10.13	48.17	60	-11.83	QP
12.226	26.84	10.13	36.97	50	-13.03	AVG

Remark:

1. All readings are Quasi-Peak and Average values.
2. Factor = Insertion Loss + Cable Loss.

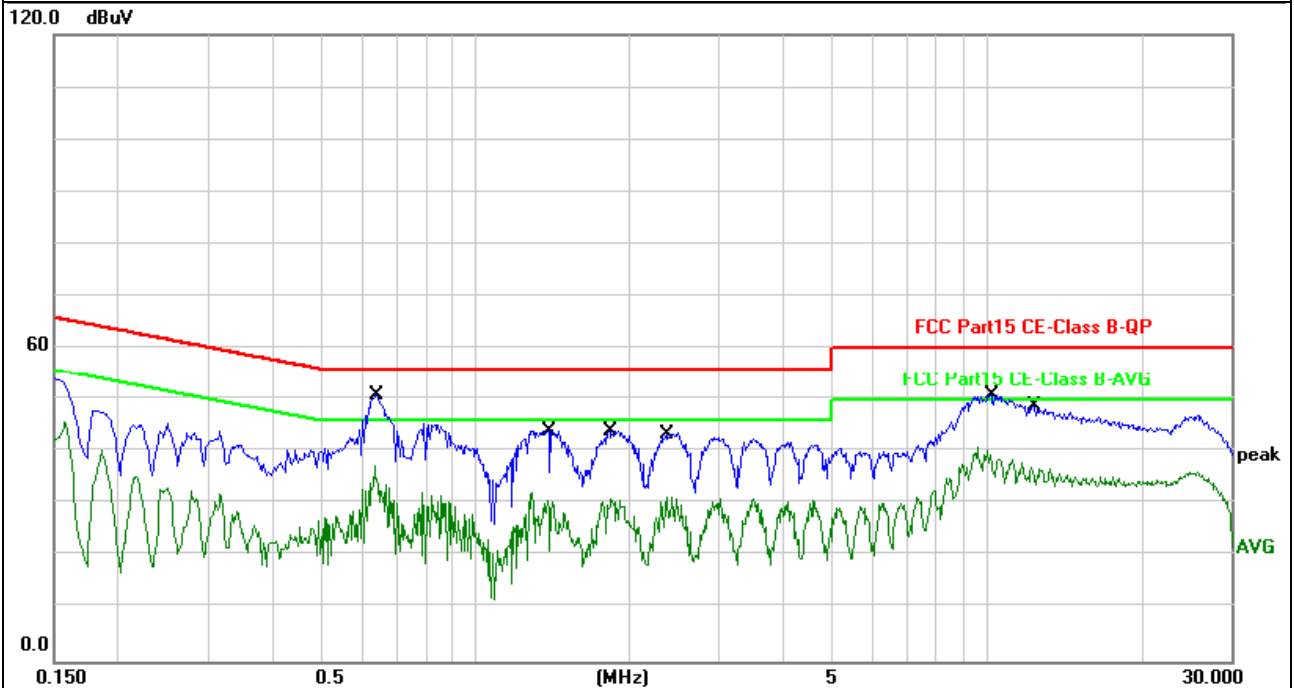



### 3.2 RADIATED EMISSION MEASUREMENT

#### 3.2.1 RADIATED EMISSION LIMITS (Frequency Range 9kHz-1000MHz)

20dBc in any 100 kHz bandwidth outside the operating frequency band. In case the emission fall within the restricted band specified on 15.205(a), then the 15.209(a) limit in the table below has to be followed.

Frequencies (MHz)	Field Strength (micorvolts/meter)	Measurement Distance (meters)
0.009~0.490	2400/F(KHz)	300
0.490~1.705	24000/F(KHz)	30
1.705~30.0	30	30
30~88	100	3
88~216	150	3
216~960	200	3
Above 960	500	3

#### LIMITS OF RADIATED EMISSION MEASUREMENT (Above 1000MHz)

FREQUENCY (MHz)	Class A (dBuV/m) (at 3M)		Class B (dBuV/m) (at 3M)	
	PEAK	AVERAGE	PEAK	AVERAGE
Above 1000	80	60	74	54

Notes:

- (1) The limit for radiated test was performed according to FCC PART 15C.
- (2) The tighter limit applies at the band edges.
- (3) Emission level (dBuV/m)=20log Emission level (uV/m).

Spectrum Parameter	Setting
Attenuation	Auto
Start Frequency	1000 MHz
Stop Frequency	10th carrier harmonic
RB / VB (emission in restricted band)	1 MHz / 1 MHz for Peak, 1 MHz / 10Hz for Average

Receiver Parameter	Setting
Attenuation	Auto
Start ~ Stop Frequency	9kHz~150kHz / RB 200Hz for QP
Start ~ Stop Frequency	150kHz~30MHz / RB 9kHz for QP
Start ~ Stop Frequency	30MHz~1000MHz / RB 120kHz for QP

### **3.2.2 TEST PROCEDURE**

- a. The measuring distance of at 3 m shall be used for measurements at frequency up to 1GHz. For frequencies above 1GHz, any suitable measuring distance may be used.
- b. The EUT was placed on the top of a rotating table 0.8 meters above the ground at a 3 meter open area test site. The table was rotated 360 degrees to determine the position of the highest radiation.
- c. The height of the equipment or of the substitution antenna shall be 0.8 m; the height of the test antenna shall vary between 1 m to 4 m. Both horizontal and vertical polarizations of the antenna are set to make the measurement.
- d. The initial step in collecting conducted emission data is a spectrum analyzer peak detector mode pre-scanning the measurement frequency range. Significant peaks are then marked and then Quasi Peak detector mode re-measured.
- e. If the Peak Mode measured value compliance with and lower than Quasi Peak Mode Limit, the EUT shall be deemed to meet QP Limits and then no additional QP Mode measurement performed.
- f. For the actual test configuration, please refer to the related Item –EUT Test Photos.

Note:

Both horizontal and vertical antenna polarities were tested and performed pretest to three orthogonal axis. The worst case emissions were reported

### **3.2.3 DEVIATION FROM TEST STANDARD**

No deviation

### 3.2.4 TEST SETUP

#### (A) Radiated Emission Test-Up Frequency Below 30MHz

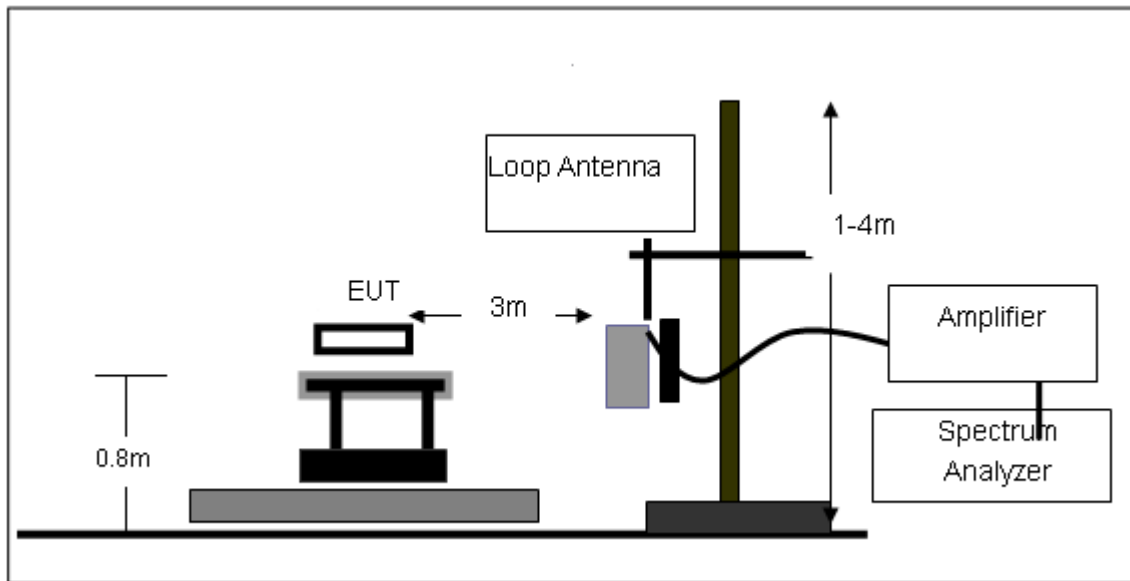

#### (B) Radiated Emission Test-Up Frequency 30MHz~1GHz

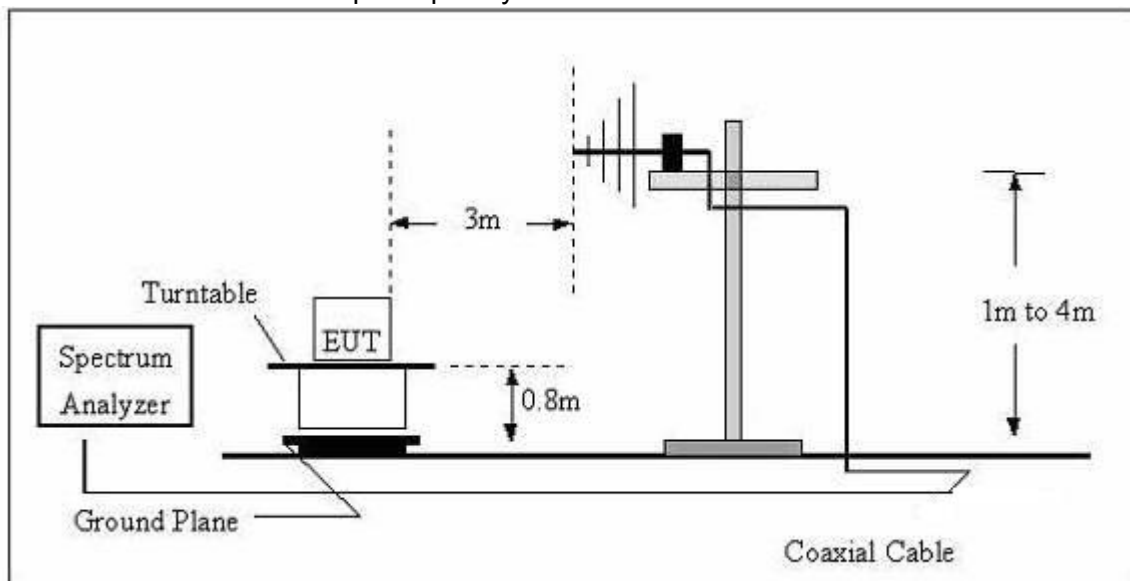

(C) Radiated Emission Test-Up Frequency Above 1GHz

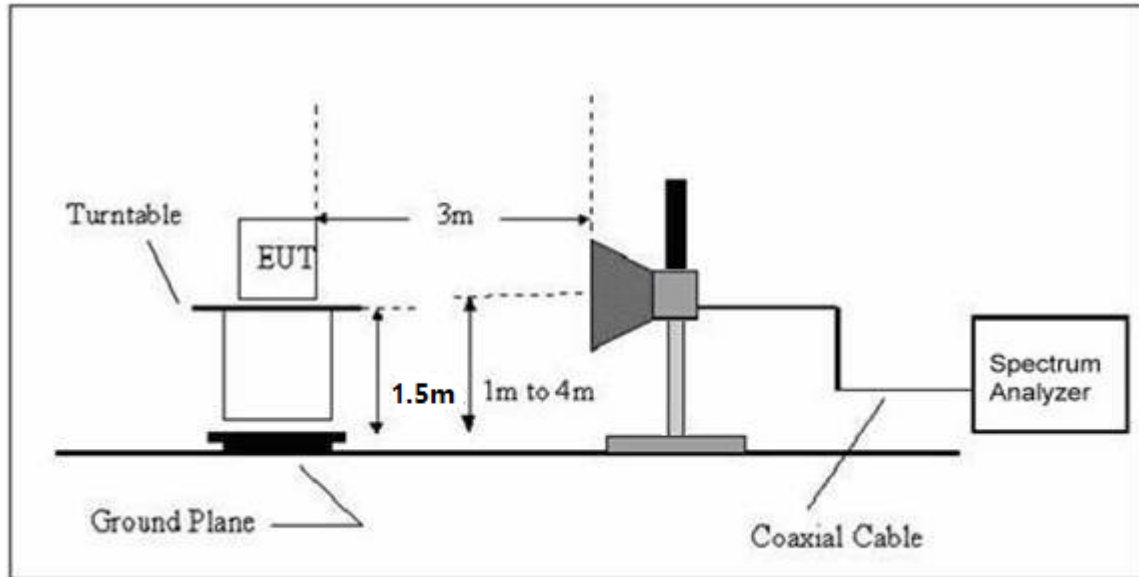

**3.2.5 EUT OPERATING CONDITIONS**

The EUT tested system was configured as the statements of 2.4 Unless otherwise a special operating condition is specified in the follows during the testing.

### 3.2.6 TEST RESULTS (BETWEEN 9KHZ – 30 MHZ)

EUT:	Ganker	Model Name. :	Ganker V1.5
Temperature:	20 °C	Relative Humidity:	48%
Pressure:	1010 hPa	Test Voltage :	DC 7.4V
Test Mode :	TX	Polarization :	--

Freq. (MHz)	Reading (dBuV/m)	Limit (dBuV/m)	Margin (dB)	State P/F
--	--	--	--	PASS
--	--	--	--	PASS

**NOTE:**

The amplitude of spurious emissions which are attenuated by more than 20dB below the permissible value has no need to be reported.

Distance extrapolation factor =  $40 \log(\text{specific distance}/\text{test distance})(\text{dB})$ ;

Limit line = specific limits(dBuv) + distance extrapolation factor.

### 3.2.7 TEST RESULTS (BETWEEN 30MHZ – 1GHZ)

EUT :	Ganker	Model Name :	Ganker V1.5
Temperature :	20 °C	Relative Humidity :	48%
Pressure:	1010 hPa	Test Voltage :	DC 7.4V
Test Mode :	TX		

Polar (H/V)	Frequency	Meter Reading	Factor	Emission Level	Limits	Margin	Detector Type
	(MHz)	(dBuV)	(dB)	(dBuV/m)	(dBuV/m)	(dB)	
V	194.4534	43.74	-15.86	27.88	43.5	-15.62	QP
V	232.5318	44.82	-14.91	29.91	46	-16.09	QP
V	325.5958	48.94	-11.92	37.02	46	-8.98	QP
V	365.5391	40.44	-11.07	29.37	46	-16.63	QP
V	399.0302	38.94	-10.2	28.74	46	-17.26	QP
V	972.3374	29.04	-0.39	28.65	54	-25.35	QP
H	43.9658	32.2	-9.35	22.85	40	-17.15	QP
H	167.2368	35.63	-13.29	22.34	43.5	-21.16	QP
H	324.4561	37.69	-11.95	25.74	46	-20.26	QP
H	400.4319	37.53	-10.17	27.36	46	-18.64	QP
H	454.31	37.53	-8.95	28.58	46	-17.42	QP
H	694.4174	31.59	-4.48	27.11	46	-18.89	QP

**Remark:**

Absolute Level= ReadingLevel+ Factor, Margin= Limit- Absolute Level

### 3.2.8 TEST RESULTS (ABOVE 1000 MHZ)

#### 802.11b

Normal Voltage

Polar (H/V)	Frequency	Meter Reading	Factor	Emission Level	Limits	Margin	Detector Type
	(MHz)	(dBuV)	(dB)	(dBuV/m)	(dBuV/m)	(dB)	
<b>operation frequency:2412</b>							
V	4824.642	67.44	-3.60	63.84	74.00	-10.16	Pk
V	4824.642	46.28	-3.60	42.68	54.00	-11.32	AV
H	4825.246	66.95	-3.58	63.37	74.00	-10.63	Pk
H	4825.246	43.26	-3.58	39.68	54.00	-14.32	AV

**Remark:**

Absolute Level= ReadingLevel+ Factor, Margin= Limit- Absolute Level

#### 802.11b

Normal Voltage

Polar (H/V)	Frequency	Meter Reading	Factor	Emission Level	Limits	Margin	Detector Type
	(MHz)	(dBuV)	(dB)	(dBuV/m)	(dBuV/m)	(dB)	
<b>operation frequency:2437</b>							
V	4874.549	65.19	-3.64	61.55	74.00	-12.45	Pk
V	4874.549	42.57	-3.64	38.93	54.00	-15.07	AV
H	4875.184	64.28	-3.64	60.64	74.00	-13.36	Pk
H	4875.184	41.17	-3.64	37.53	54.00	-16.47	AV

**Remark:**

Absolute Level= ReadingLevel+ Factor, Margin= Limit- Absolute Level

#### 802.11b

Normal Voltage

Polar (H/V)	Frequency	Meter Reading	Factor	Emission Level	Limits	Margin	Detector Type
	(MHz)	(dBuV)	(dB)	(dBuV/m)	(dBuV/m)	(dB)	
<b>operation frequency:2462</b>							
V	4925.016	56.39	-3.64	52.75	74.00	-21.25	pk
H	4923.864	55.48	-3.66	51.82	74.00	-22.18	pk

**Remark:**

Absolute Level= ReadingLevel+ Factor, Margin= Limit- Absolute Level

**802.11g**

Normal Voltage

Polar (H/V)	Frequency	Meter Reading	Factor	Emission Level	Limits	Margin	Detector Type
	(MHz)	(dBuV)	(dB)	(dBuV/m)	(dBuV/m)	(dB)	
<b>operation frequency:2412</b>							
V	4823.618	62.57	-3.6	58.97	74.00	-15.03	Pk
V	4823.618	40.61	-3.6	37.01	54.00	-16.99	AV
H	4824.197	63.22	-3.6	59.62	74.00	-14.38	Pk
H	4824.197	42.08	-3.6	38.48	54.00	-15.52	AV

**Remark:**

Absolute Level= ReadingLevel+ Factor, Margin= Limit- Absolute Level

**802.11g**

Normal Voltage

Polar (H/V)	Frequency	Meter Reading	Factor	Emission Level	Limits	Margin	Detector Type
	(MHz)	(dBuV)	(dB)	(dBuV/m)	(dBuV/m)	(dB)	
<b>operation frequency:2437</b>							
V	4873.291	63.17	-3.63	59.54	74.00	-14.46	Pk
V	4873.291	41.24	-3.63	37.61	54.00	-16.39	AV
H	4874.609	60.48	-3.64	56.84	74.00	-17.16	Pk
H	4874.609	40.83	-3.64	37.19	54.00	-16.81	AV

**Remark:**

Absolute Level= ReadingLevel+ Factor, Margin= Limit- Absolute Level

**802.11g**

Normal Voltage

Polar (H/V)	Frequency	Meter Reading	Factor	Emission Level	Limits	Margin	Detector Type
	(MHz)	(dBuV)	(dB)	(dBuV/m)	(dBuV/m)	(dB)	
<b>operation frequency:2462</b>							
V	4924.527	55.21	-3.60	51.61	74.00	-22.39	pk
H	4923.256	56.09	-3.66	52.43	74.00	-21.57	pk

**Remark:**

Absolute Level= ReadingLevel+ Factor, Margin= Limit- Absolute Level



**802.11n(20MHz)**

Normal Voltage

Polar (H/V)	Frequency	Meter Reading	Factor	Emission Level	Limits	Margin	Detector Type
	(MHz)	(dBuV)	(dB)	(dBuV/m)	(dBuV/m)	(dB)	
<b>operation frequency:2412</b>							
V	4825.307	62.18	-3.58	58.6	74.00	-15.40	Pk
V	4825.307	41.97	-3.58	38.39	54.00	-15.61	AV
H	4824.592	61.27	-3.60	57.67	74.00	-16.33	Pk
H	4824.592	39.58	-3.60	35.98	54.00	-18.02	AV

**Remark:**

Absolute Level= ReadingLevel+ Factor, Margin= Limit- Absolute Level

**802.11n(20MHz)**

Normal Voltage

Polar (H/V)	Frequency	Meter Reading	Factor	Emission Level	Limits	Margin	Detector Type
	(MHz)	(dBuV)	(dB)	(dBuV/m)	(dBuV/m)	(dB)	
<b>operation frequency:2437</b>							
V	4875.627	63.17	-3.63	59.54	74.00	-14.46	Pk
V	4875.627	41.24	-3.63	37.61	54.00	-16.39	AV
H	4873.834	60.48	-3.64	56.84	74.00	-17.16	Pk
H	4873.834	40.83	-3.64	37.19	54.00	-16.81	AV

**Remark:**

Absolute Level= ReadingLevel+ Factor, Margin= Limit- Absolute Level

**802.11n(20MHz)**

Normal Voltage

Polar (H/V)	Frequency	Meter Reading	Factor	Emission Level	Limits	Margin	Detector Type
	(MHz)	(dBuV)	(dB)	(dBuV/m)	(dBuV/m)	(dB)	
<b>operation frequency:2462</b>							
V	4922.907	59.67	-3.64	56.03	74.00	-17.97	pk
V	4922.907	37.19	-3.64	33.55	54.00	-20.45	AV
H	4925.648	55.94	-3.66	52.28	74.00	-21.72	pk

**Remark:**

Absolute Level= ReadingLevel+ Factor, Margin= Limit- Absolute Level

#### 4. POWER SPECTRAL DENSITY TEST

##### 4.1 APPLIED PROCEDURES / LIMIT

FCC Part15 (15.247) , Subpart C				
Section	Test Item	Limit	Frequency Range (MHz)	Result
15.247	Power Spectral Density	8 dBm (in any 3KHz)	2400-2483.5	PASS

##### 4.1.1 TEST PROCEDURE

1. Set analyzer center frequency to DTS channel center frequency.
2. Set the span to 1.5 times the DTS channel bandwidth.
3. Set the RBW  $\geq$  3 kHz.
4. Set the VBW  $\geq$  3 x RBW.
5. Detector = peak.
6. Sweep time = auto couple.
7. Trace mode = max hold.
8. Allow trace to fully stabilize.
9. Use the peak marker function to determine the maximum amplitude level.
10. If measured value exceeds limit, reduce RBW (no less than 3 kHz) and repeat.

##### 4.1.2 DEVIATION FROM STANDARD

No deviation.

##### 4.1.3 TEST SETUP

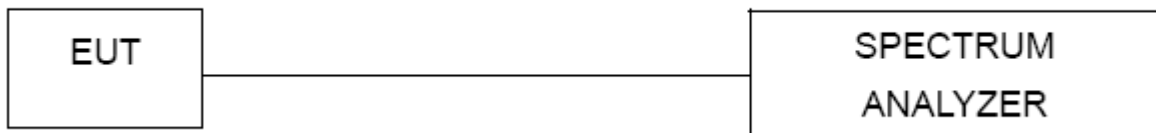

##### 4.1.4 EUT OPERATION CONDITIONS

The EUT tested system was configured as the statements of 2.1 Unless otherwise a special operating condition is specified in the follows during the testing.

### 4.1.5 TEST RESULTS

EUT :	Ganker	Model Name :	Ganker V1.5
Temperature :	25 °C	Relative Humidity :	60%
Pressure :	1015 hPa	Test Voltage :	DC 3.7V
Test Mode :	TX b Mode /CH01, CH06, CH11		

Frequency	Power Density (dBm)	Limit (dBm)	Result
2412 MHz	-12.22	8	PASS
2437 MHz	-12.20	8	PASS
2462 MHz	-11.62	8	PASS

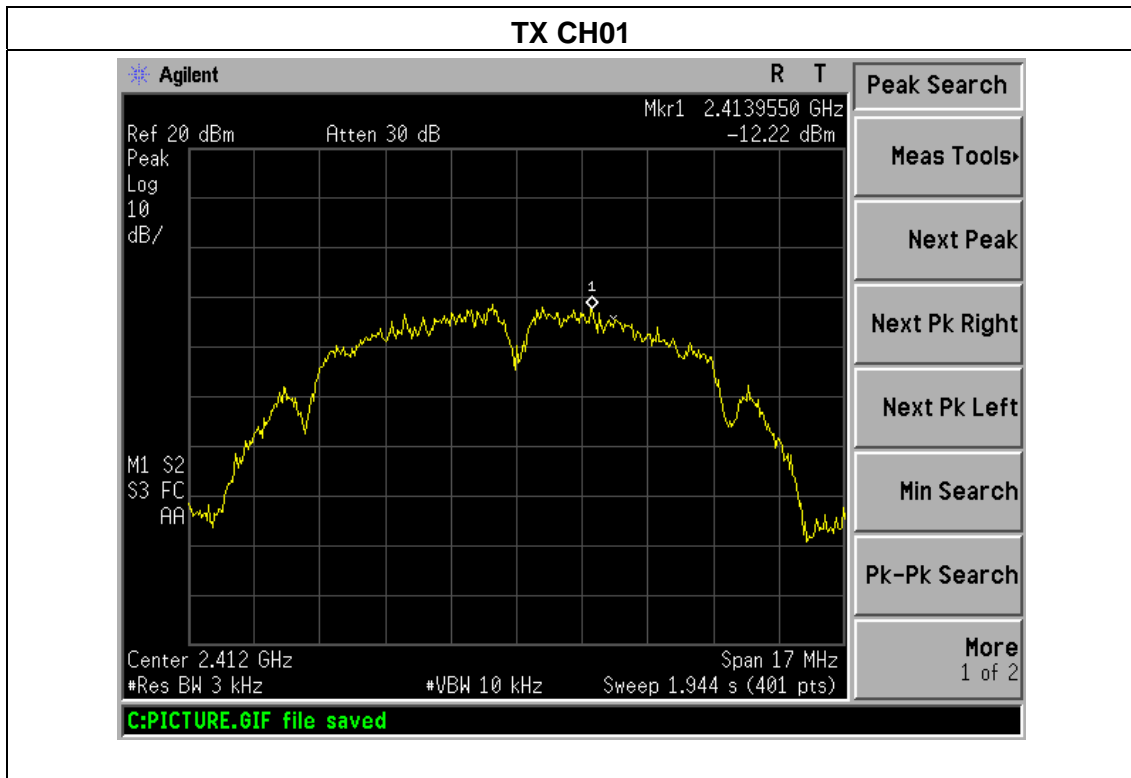

### TX CH06

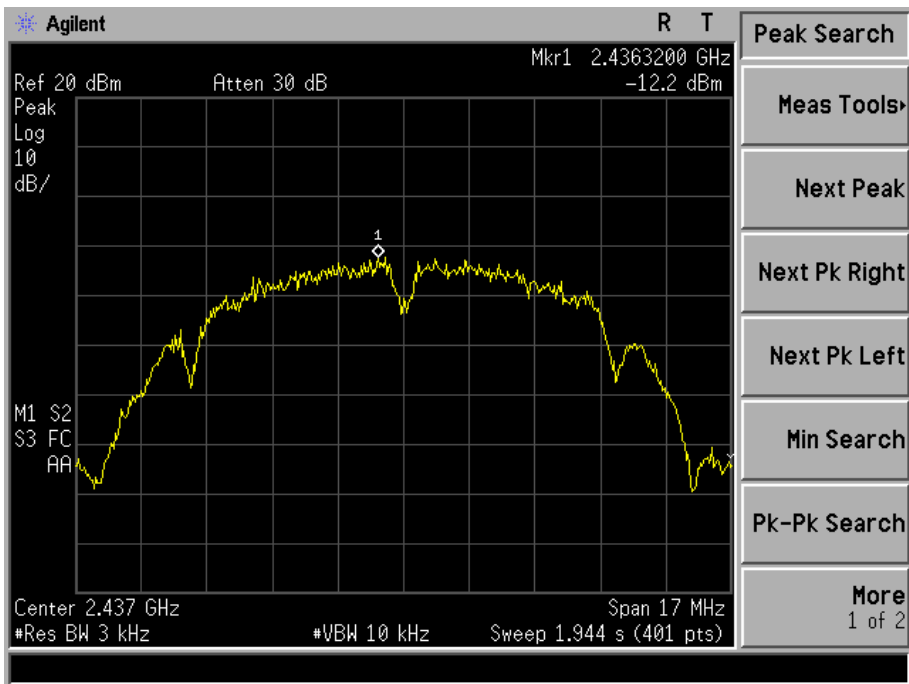

### TX CH11

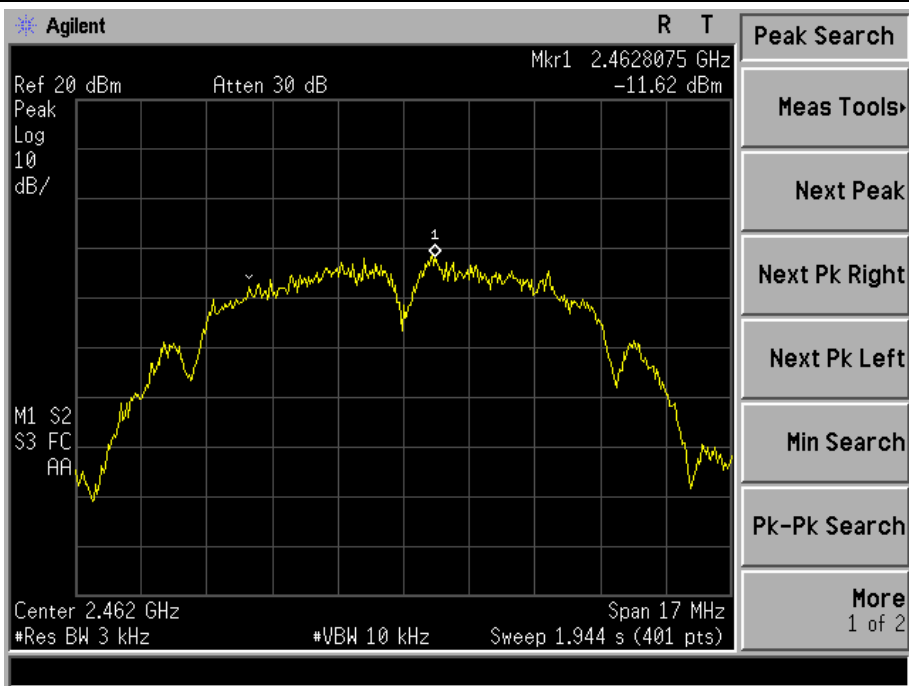

EUT :	Ganker	Model Name :	Ganker V1.5
Temperature :	25 °C	Relative Humidity :	60%
Pressure :	1015 hPa	Test Voltage :	DC 3.7V
Test Mode :	TX g Mode /CH01, CH06, CH11		

Frequency	Power Density (dBm)	Limit (dBm)	Result
2412 MHz	-13.96	8	PASS
2437 MHz	-13.68	8	PASS
2462 MHz	-14.46	8	PASS

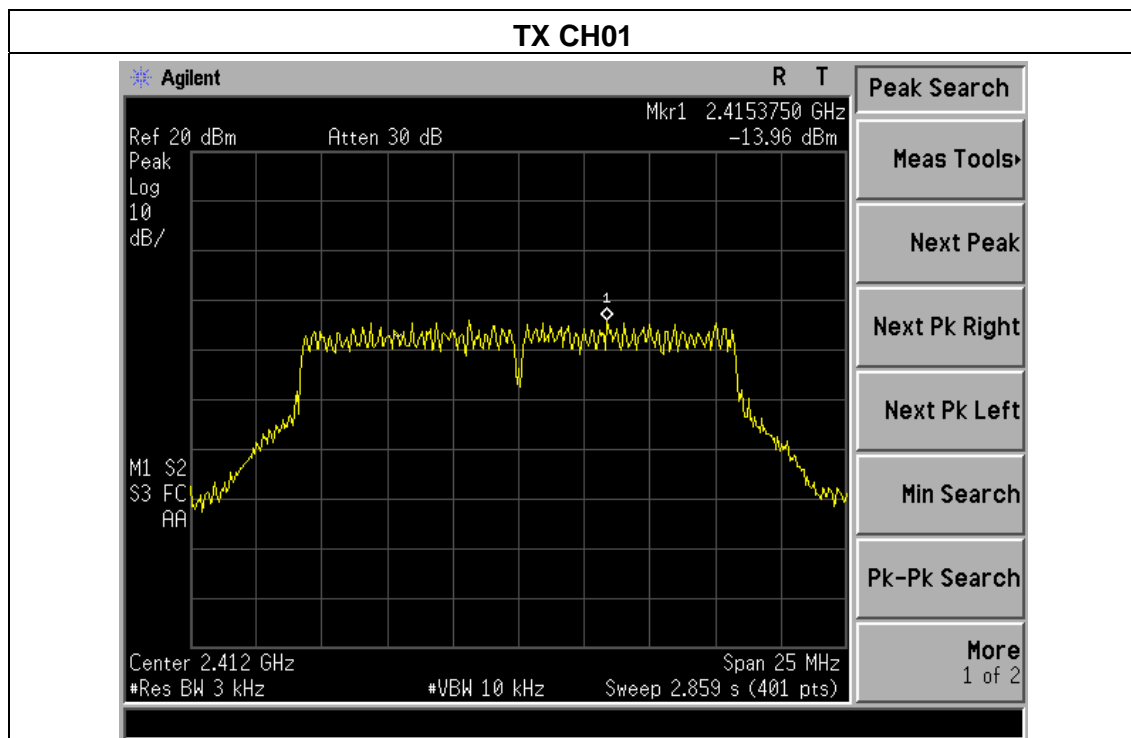

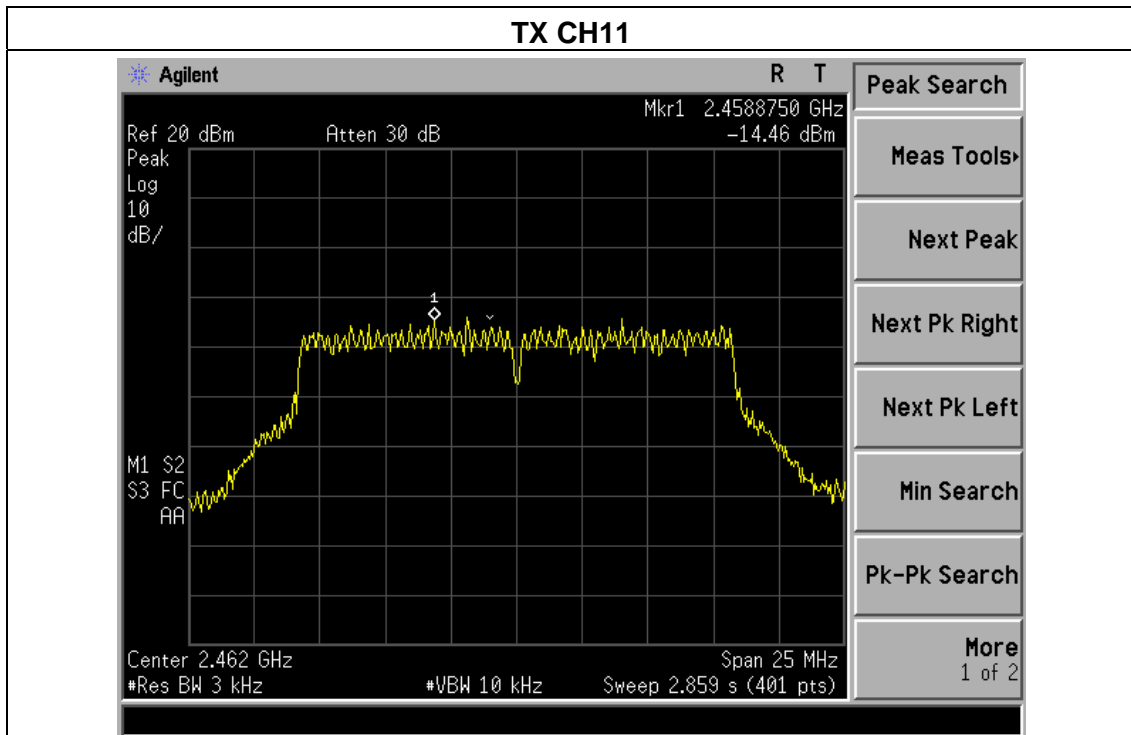
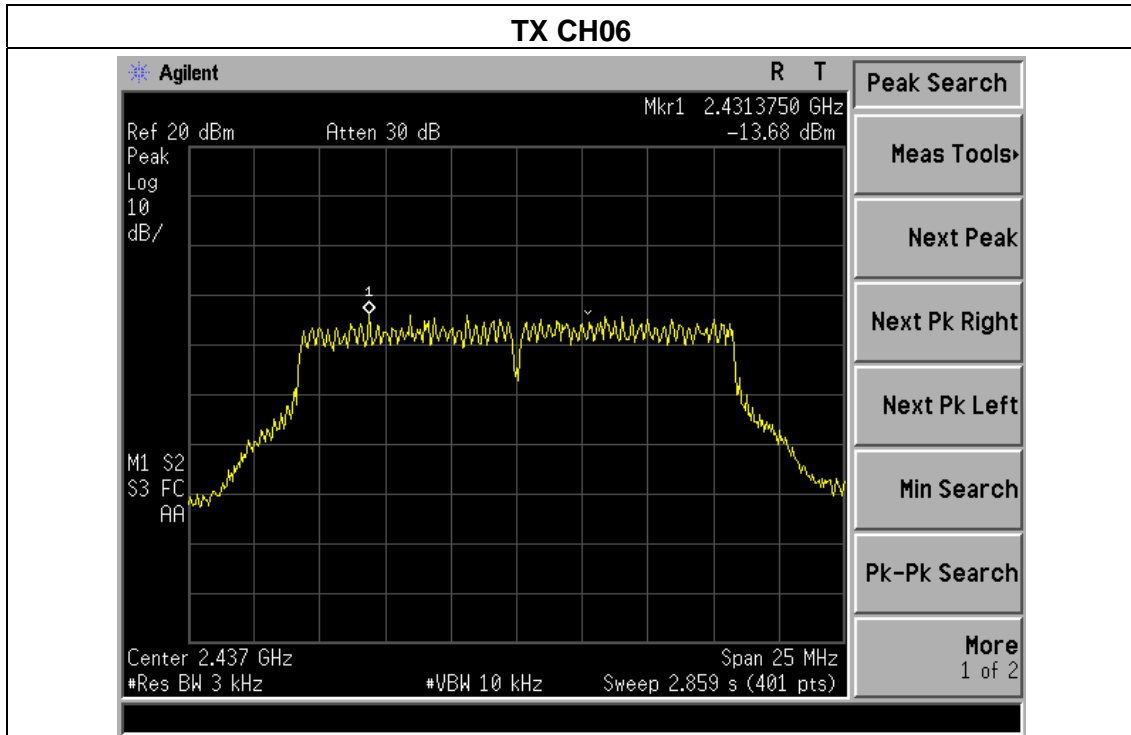

EUT :	Ganker	Model Name :	Ganker V1.5
Temperature :	25 °C	Relative Humidity :	60%
Pressure :	1015 hPa	Test Voltage :	DC 3.7V
Test Mode :	TX n Mode(20M) /CH01, CH06, CH11		

Frequency	Power Density (dBm)	Limit (dBm)	Result
2412 MHz	-15.97	8	PASS
2437 MHz	-15.46	8	PASS
2462 MHz	-15.54	8	PASS

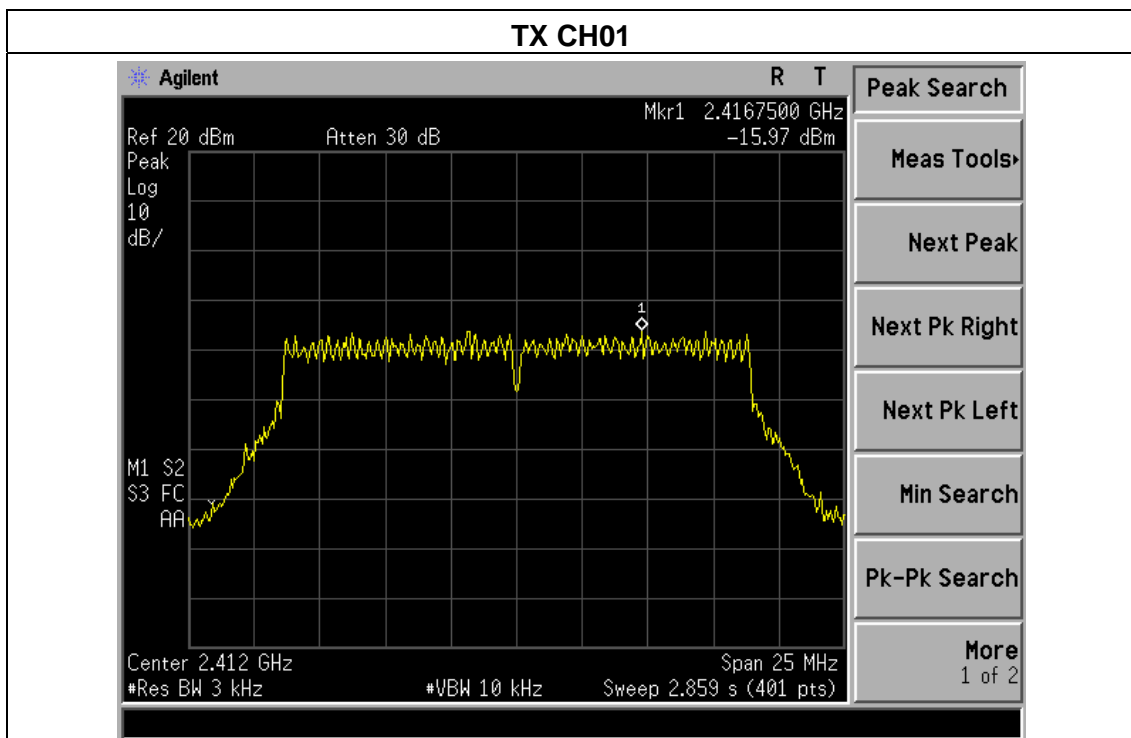

### TX CH06

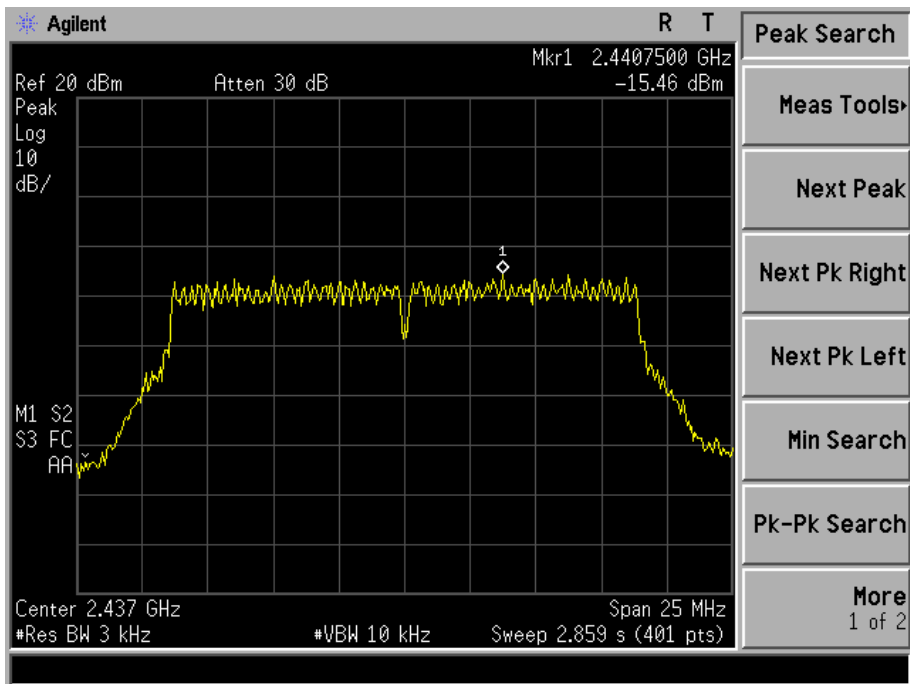

### TX CH11

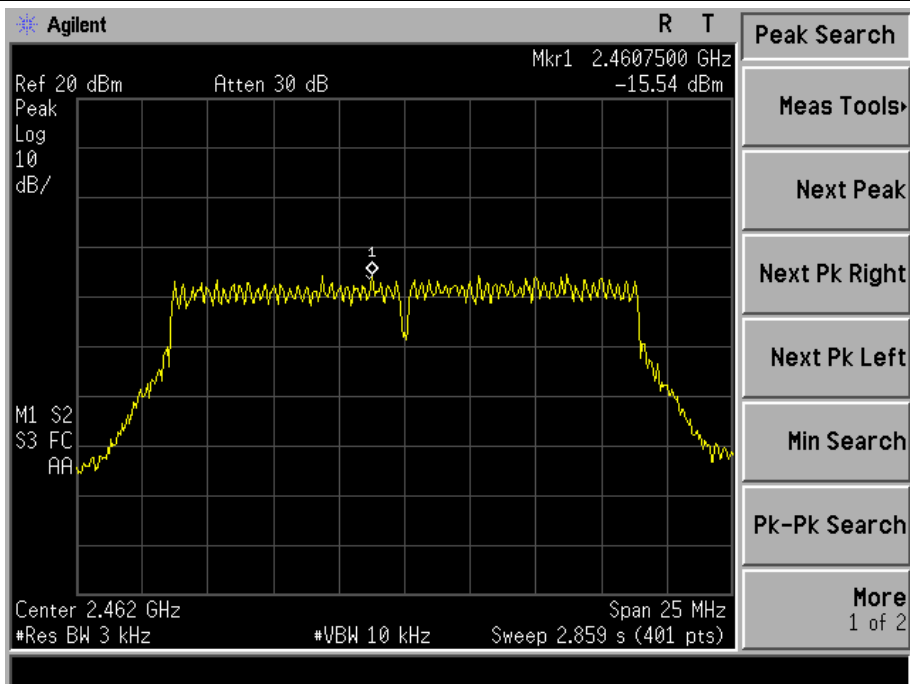



## 5. BANDWIDTH TEST

### 5.1 APPLIED PROCEDURES / LIMIT

FCC Part15 (15.247) , Subpart C				
Section	Test Item	Limit	Frequency Range (MHz)	Result
15.247(a)(2)	Bandwidth	$\geq 500\text{KHz}$ (6dB bandwidth)	2400-2483.5	PASS

#### 5.1.1 TEST PROCEDURE

1. Set resolution bandwidth (RBW) = 1-5% or DTS BW, not to exceed 100 kHz.
2. Set the video bandwidth (VBW)  $\geq 3 \times$  RBW.
3. Detector = Peak.
4. Trace mode = max hold.
5. Sweep = auto couple.
6. Allow the trace to stabilize.
7. Measure the maximum width of the emission that is constrained by the frequencies associated with the two outermost amplitude points (upper and lower) that are attenuated by 6 dB relative to the maximum level measured in the fundamental emission.

#### 5.1.2 DEVIATION FROM STANDARD

No deviation.

#### 5.1.3 TEST SETUP



#### 5.1.4 EUT OPERATION CONDITIONS

The EUT tested system was configured as the statements of 2.4 Unless otherwise a special operating condition is specified in the follows during the testing.

### 5.1.5 TEST RESULTS

EUT :	Ganker	Model Name :	Ganker V1.5
Temperature :	25 °C	Relative Humidity :	60%
Pressure :	1012 hPa	Test Voltage :	DC 3.7V
Test Mode :	TX b Mode /CH01, CH06, CH11		

Channel	Frequency (MHz)	6dB bandwidth (MHz)	Limit (kHz)	Result
Low	2412	8.04	500	Pass
Middle	2437	8.12	500	Pass
High	2462	8.08	500	Pass

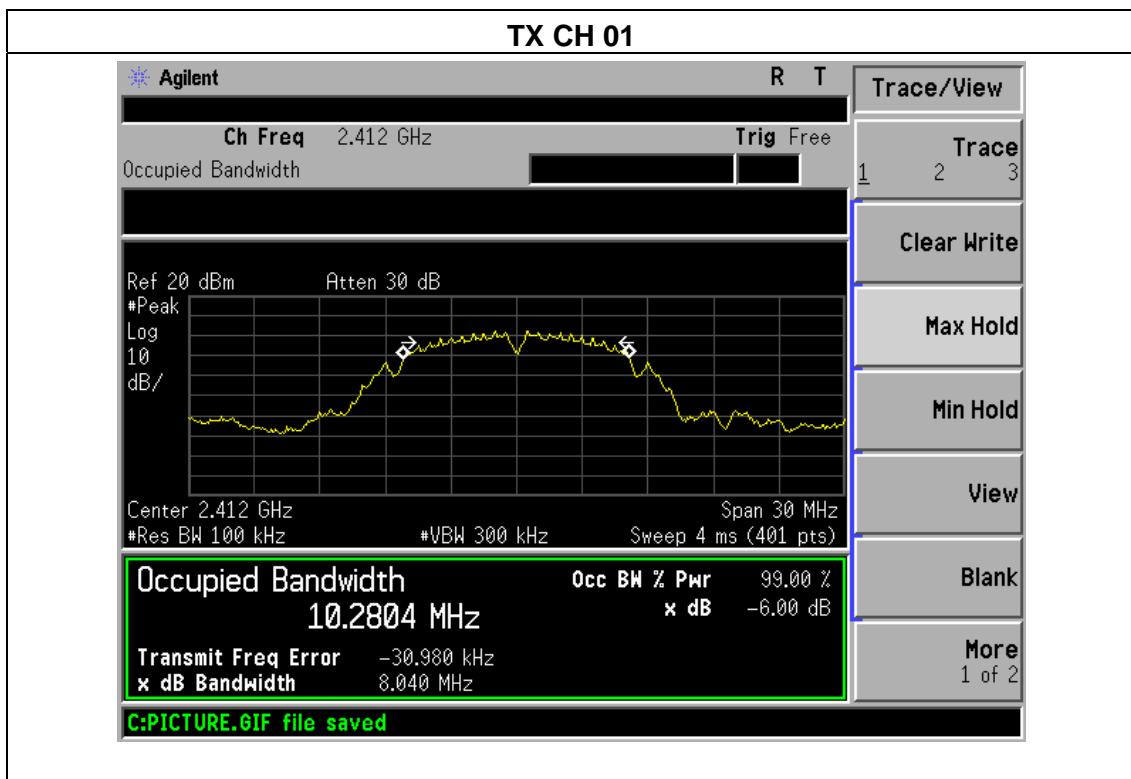

### TX CH 06

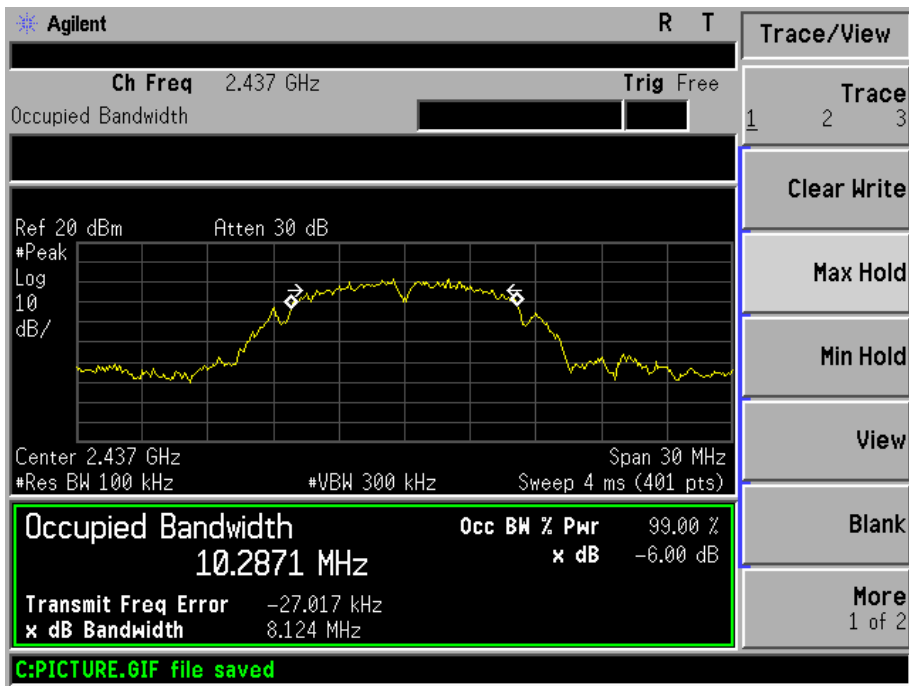

### TX CH 11

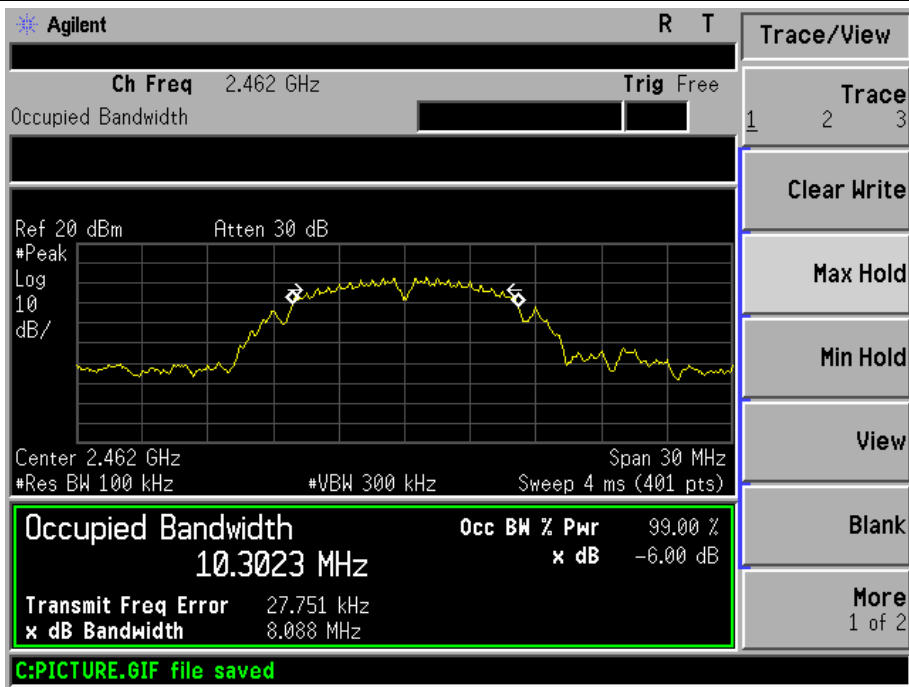

EUT :	Ganker	Model Name :	Ganker V1.5
Temperature :	25 °C	Relative Humidity :	60%
Pressure :	1012 hPa	Test Voltage :	DC 3.7V
Test Mode :	TX g Mode /CH01, CH06, CH11		

Channel	Frequency (MHz)	6dB bandwidth (MHz)	Limit (kHz)	Result
Low	2412	16.45	500	Pass
Middle	2437	16.54	500	Pass
High	2462	16.42	500	Pass

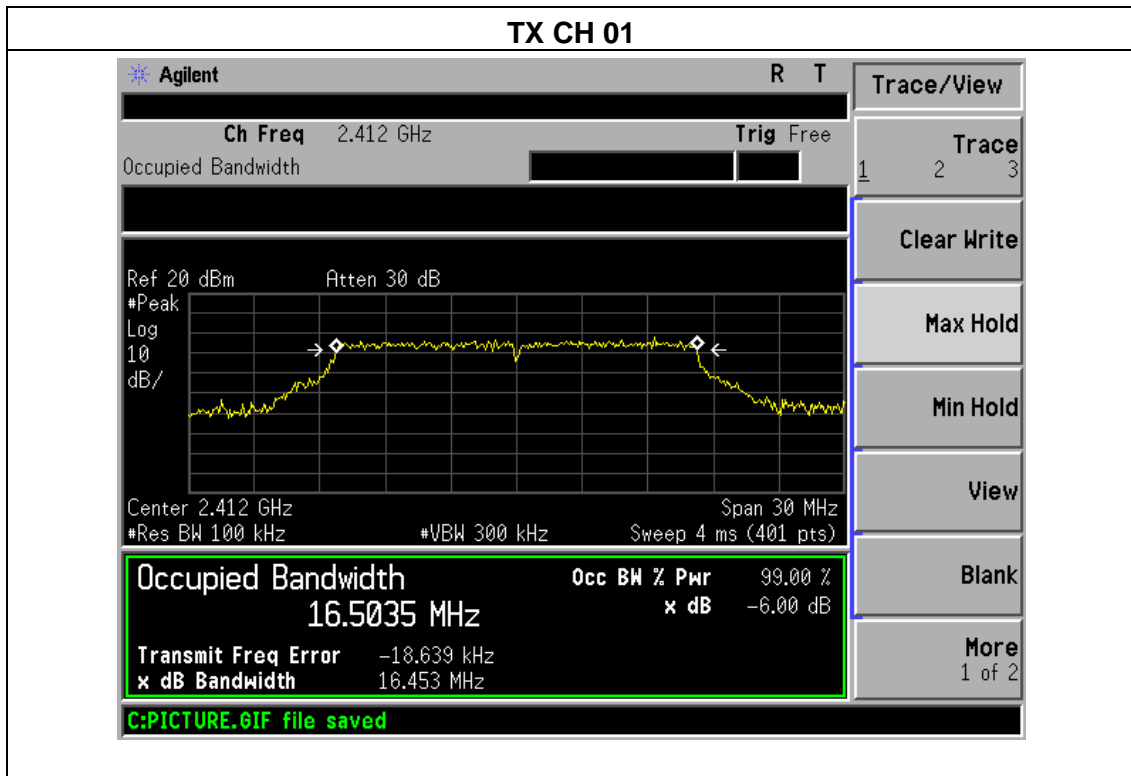

### TX CH 06

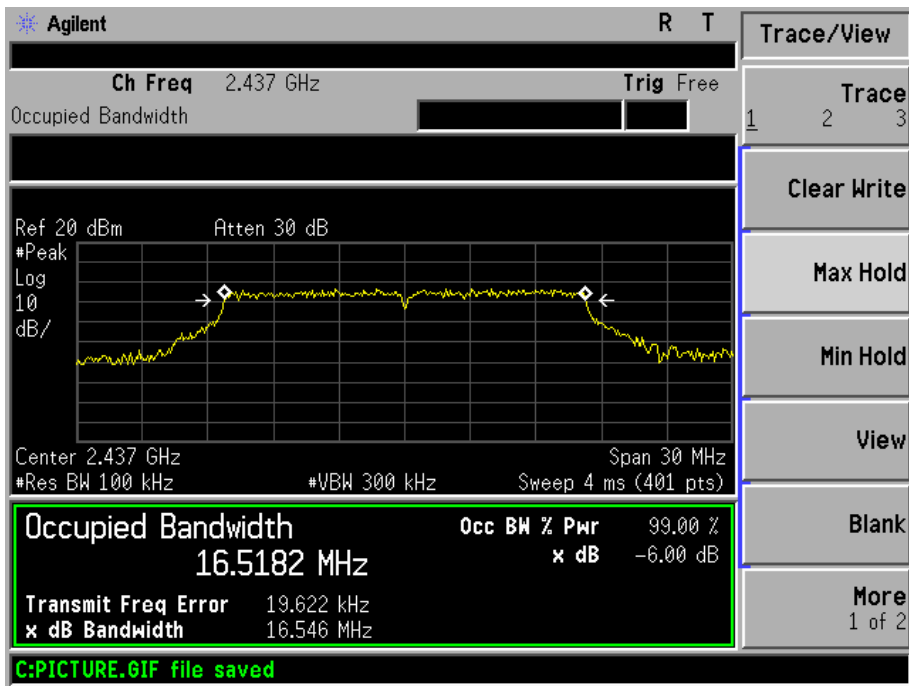

### TX CH 11

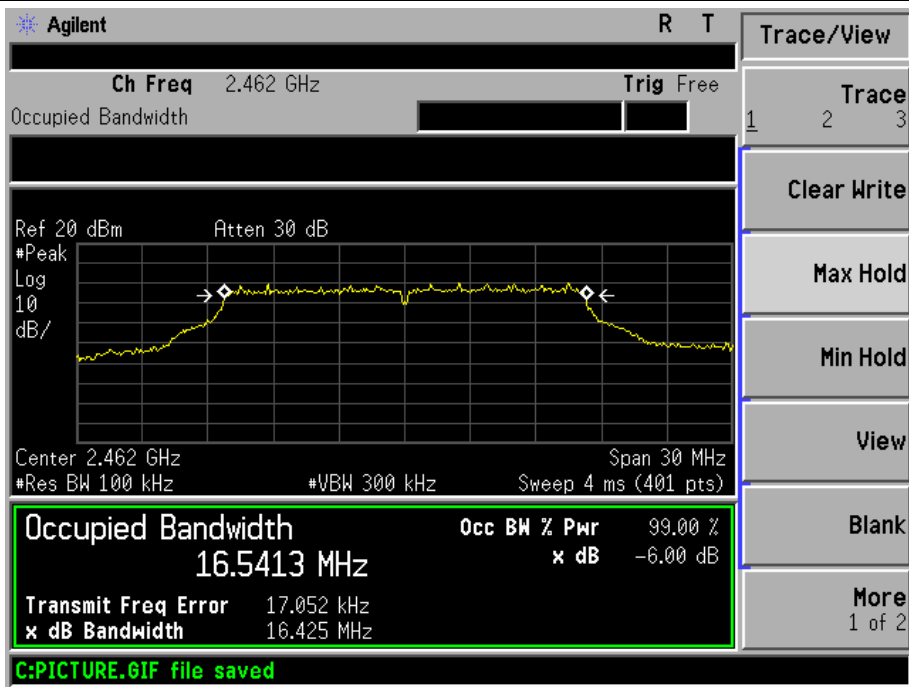

EUT :	Ganker	Model Name :	Ganker V1.5
Temperature :	25 °C	Relative Humidity :	60%
Pressure :	1012 hPa	Test Voltage :	DC 3.7V
Test Mode :	TX n Mode(20M) /CH01, CH06, CH11		

Channel	Frequency (MHz)	6dB bandwidth (MHz)	Limit (kHz)	Result
Low	2412	17.63	500	Pass
Middle	2437	17.64	500	Pass
High	2462	17.66	500	Pass

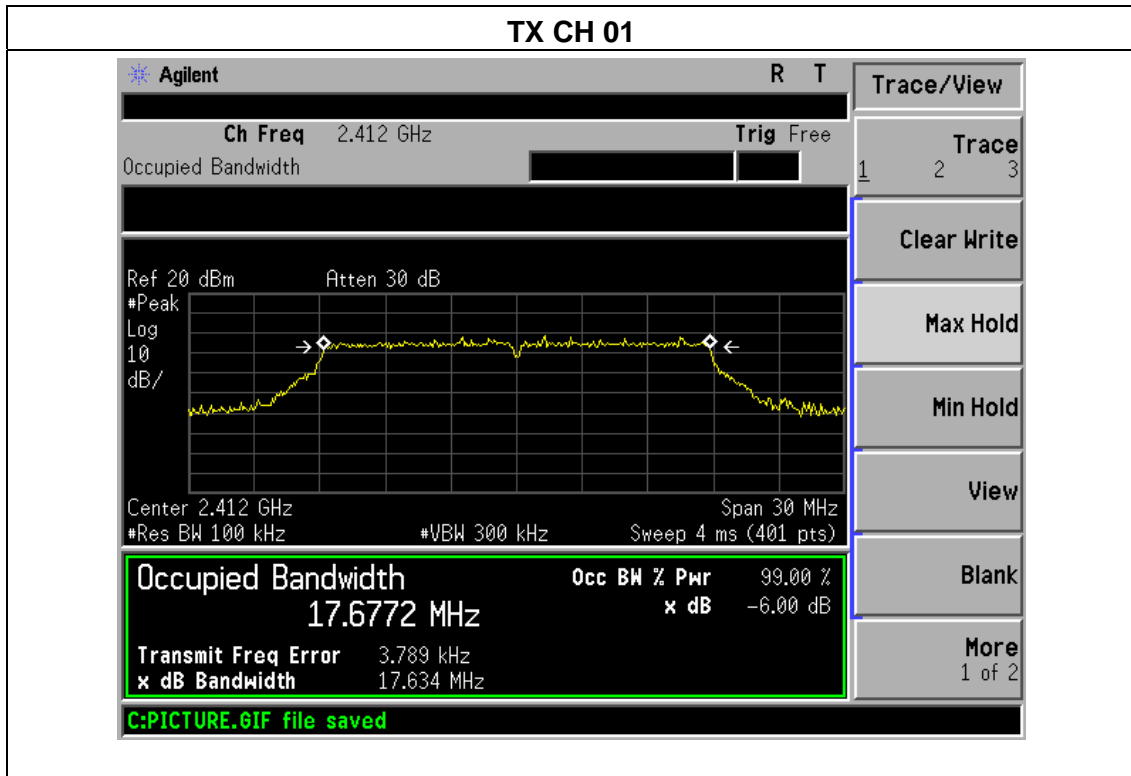

### TX CH 06

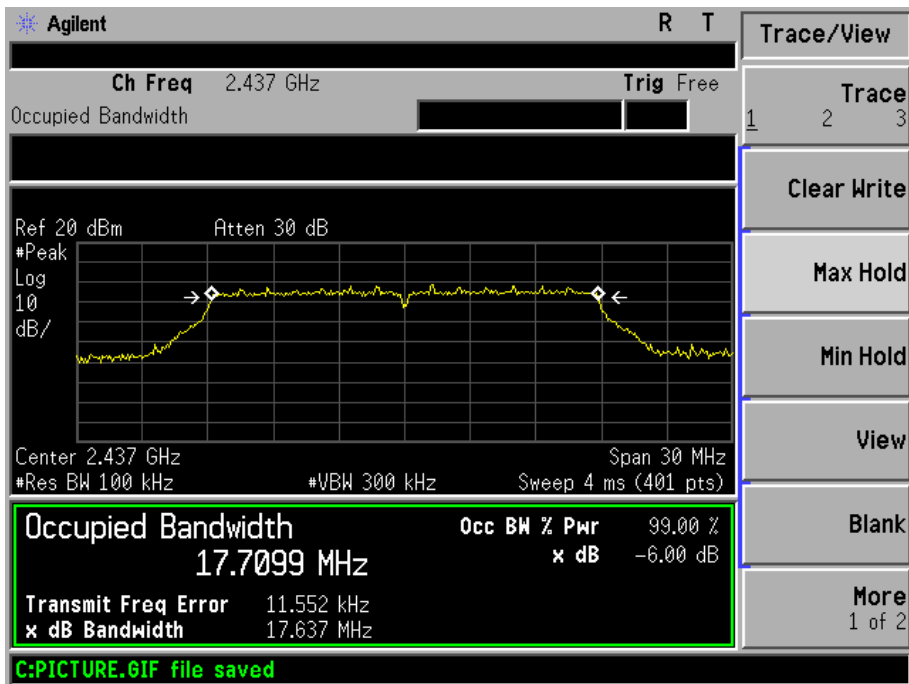

### TX CH 11

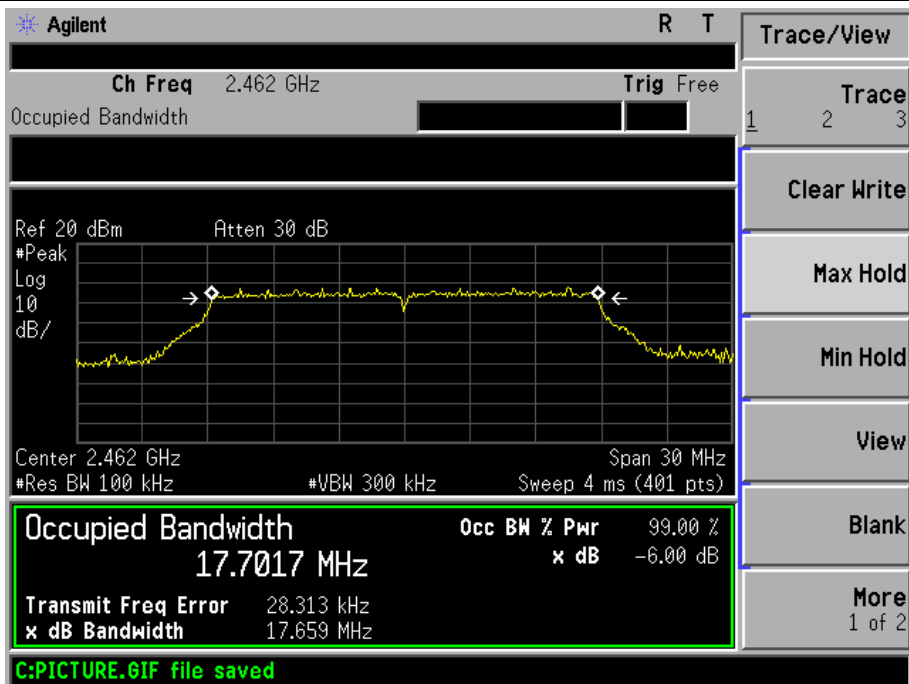

## 6. PEAK OUTPUT POWER TEST

### 6.1 APPLIED PROCEDURES / LIMIT

FCC Part15 (15.247) , Subpart C				
Section	Test Item	Limit	Frequency Range (MHz)	Result
15.247(b)(3)	Peak Output Power	1 watt or 30dBm	2400-2483.5	PASS

#### 6.1.1 TEST PROCEDURE

- a. The EUT was directly connected to the Power meter

#### 6.1.2 DEVIATION FROM STANDARD

No deviation.

#### 6.1.3 TEST SETUP



#### 6.1.4 EUT OPERATION CONDITIONS

The EUT tested system was configured as the statements of 2.4 Unless otherwise a special operating condition is specified in the follows during the testing.



**6.1.5 TEST RESULTS**

EUT :	Ganker	Model Name :	Ganker V1.5
Temperature :	25 °C	Relative Humidity :	60%
Pressure :	1012 hPa	Test Voltage :	DC 3.7V
Test Mode :	TX b/g/n(20M)		

<b>TX 802.11b Mode</b>			
Test Channel	Frequency	Maximum Conducted Output Power(PK)	LIMIT
	(MHz)	(dBm)	dBm
CH01	2412	9.12	30
CH06	2437	8.91	30
CH11	2462	8.82	30
<b>TX 802.11g Mode</b>			
CH01	2412	7.79	30
CH06	2437	7.65	30
CH11	2462	7.70	30
<b>TX 802.11n-HT20 Mode</b>			
CH01	2412	7.77	30
CH06	2437	7.72	30
CH11	2462	7.64	30

## 7. 100 KHZ BANDWIDTH OF FREQUENCY BAND EDGE

### APPLICABLE STANDARD

In any 100 kHz bandwidth outside the frequency band in which the spread spectrum or digitally modulated intentional radiator is operating, the radio frequency power that is produced by the intentional radiator shall be at least 20 dB below that in the 100 kHz bandwidth within the band that contains the highest level of the desired power, based on either an RF conducted or a radiated measurement, provided the transmitter demonstrates compliance with the peak conducted power limits. If the transmitter complies with the conducted power limits based on the use of RMS averaging over a time interval, as permitted under paragraph (b)(3) of this section, the attenuation required under this paragraph shall be 30 dB instead of 20 dB. Attenuation below the general limits specified in §15.209(a) is not required. In addition, radiated emissions which fall in the restricted bands, as defined in §15.205(a), must also comply with the radiated emission limits specified in §15.209(a) (see §15.205(c)).

### TEST PROCEDURE

- a) Check the calibration of the measuring instrument using either an internal calibrator or a known signal from an external generator.
- b) Position the EUT without connection to measurement instrument. Turn on the EUT and connect its antenna terminal to measurement instrument via a low loss cable. Then set it to any one measured frequency within its operating range, and make sure the instrument is operated in its linear range.
- c) Set RBW to 100 kHz and VBW of spectrum analyzer to 300 kHz with a convenient frequency span including 100 kHz bandwidth from band edge.
- d) Measure the highest amplitude appearing on spectral display and set it as a reference level. Plot the graph with marking the highest point and edge frequency.
- e) Repeat above procedures until all measured frequencies were complete.

### 7.1 DEVIATION FROM STANDARD

No deviation.

### 7.2 TEST SETUP



### 7.3 EUT OPERATION CONDITIONS

The EUT tested system was configured as the statements of 2.4 Unless otherwise a special operating condition is specified in the follows during the testing.

### 7.4 TEST RESULTS

EUT :	Ganker	Model Name :	Ganker V1.5
Temperature :	25 °C	Relative Humidity :	60%
Pressure :	1012 hPa	Test Voltage :	DC 3.7V

Frequency Band	Delta Peak to band emission (dBc)	> Limit (dBc)	Result
802.11b mode			
Left-band	42.80	20	Pass
Right-band	48.58	20	Pass
802.11g mode			
Left-band	31.72	20	Pass
Right-band	32.06	20	Pass
802.11n-HT20 mode			
Left-band	30.41	20	Pass
Right-band	34.97	20	Pass

### 802.11b: Band Edge, Left Side

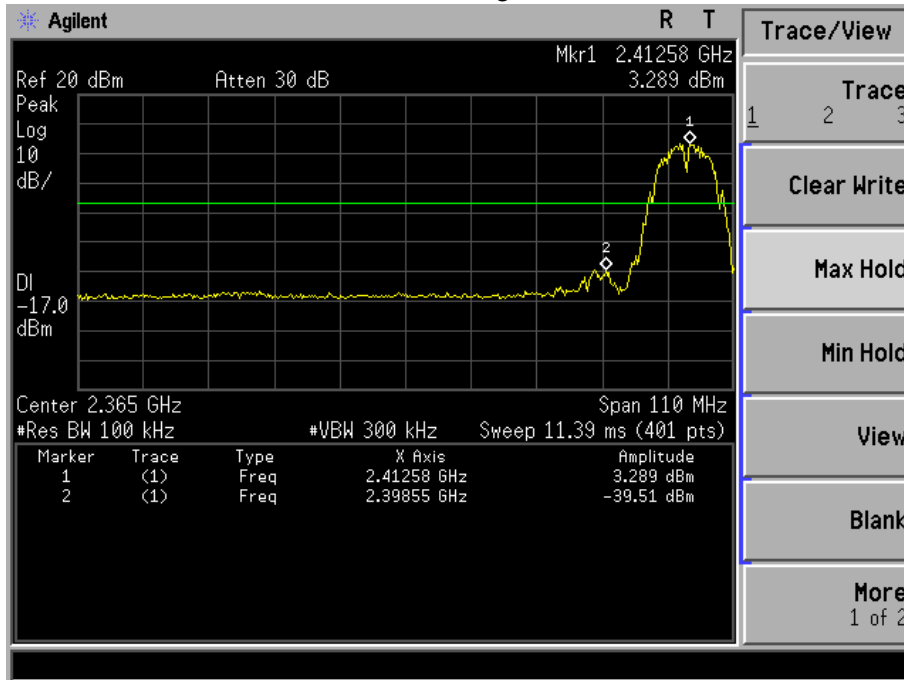

### 802.11b: Band Edge, Right Side

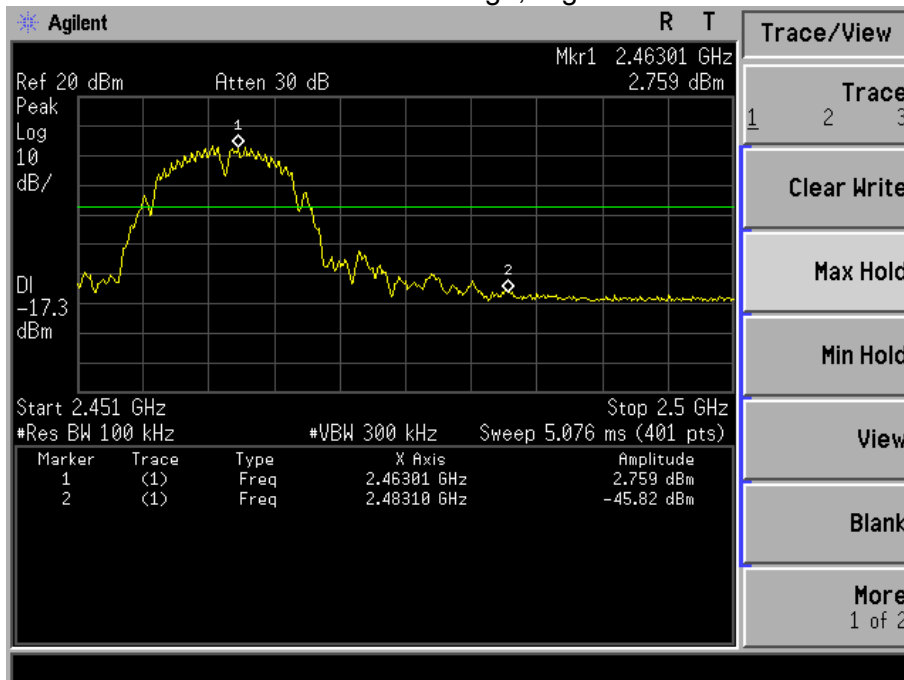

### 802.11g: Band Edge, Left Side

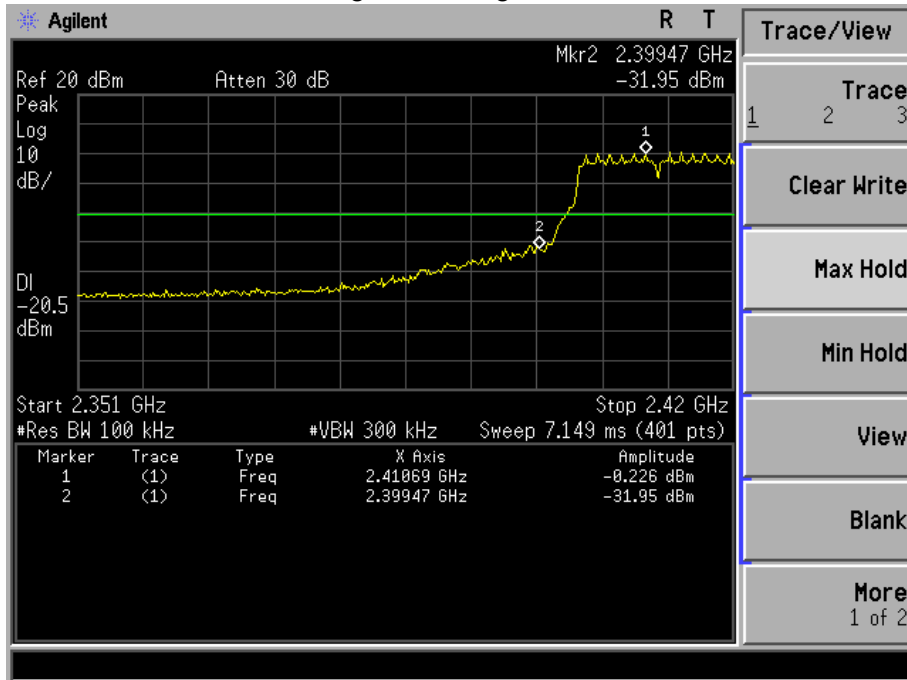

### 802.11g: Band Edge, Right Side

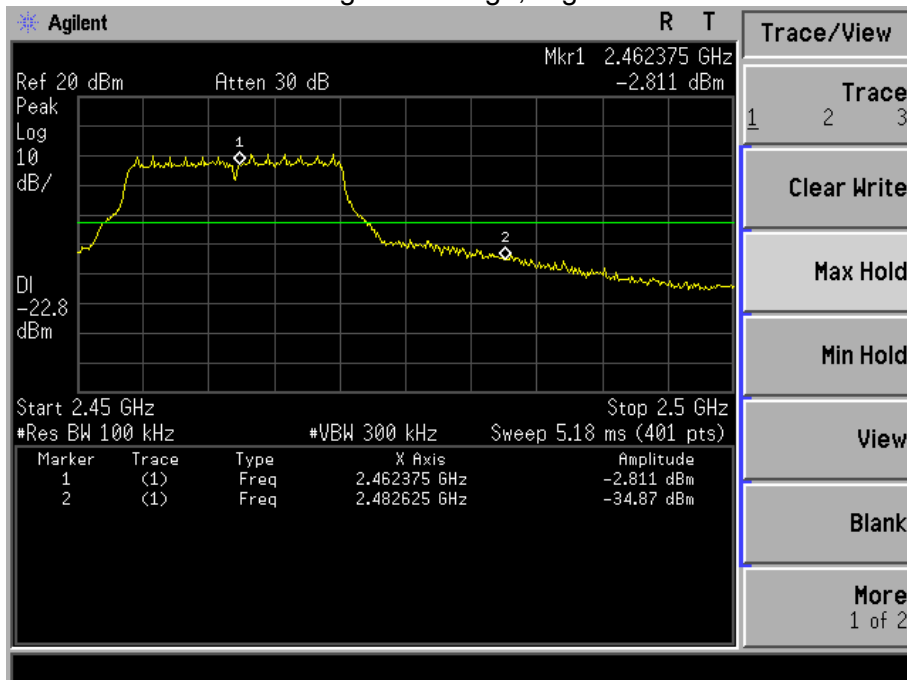

### 802.11n-HT20: Band Edge, Left Side

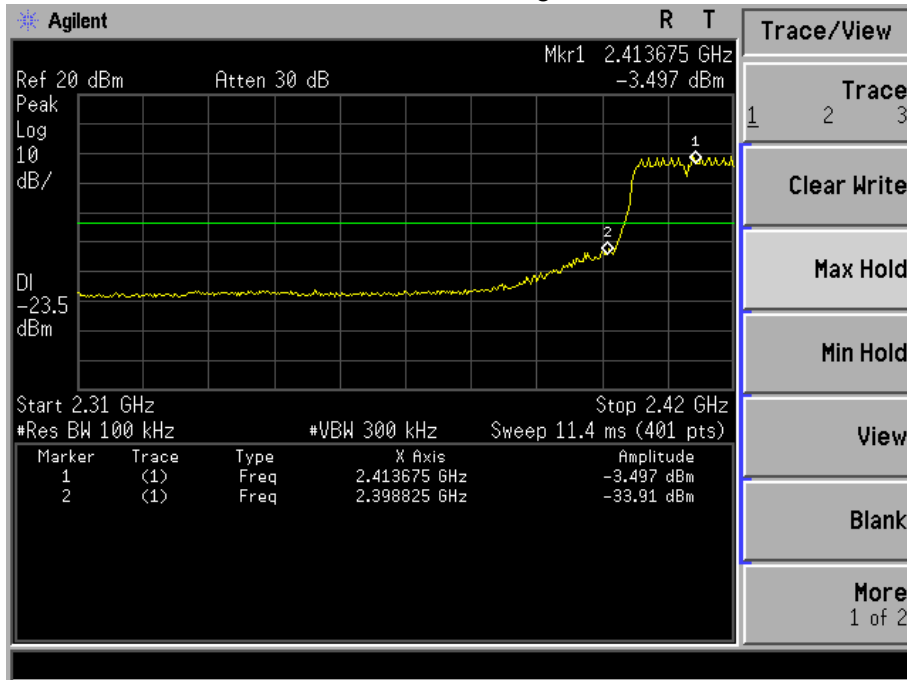

### 802.11n-HT20: Band Edge, Right Side

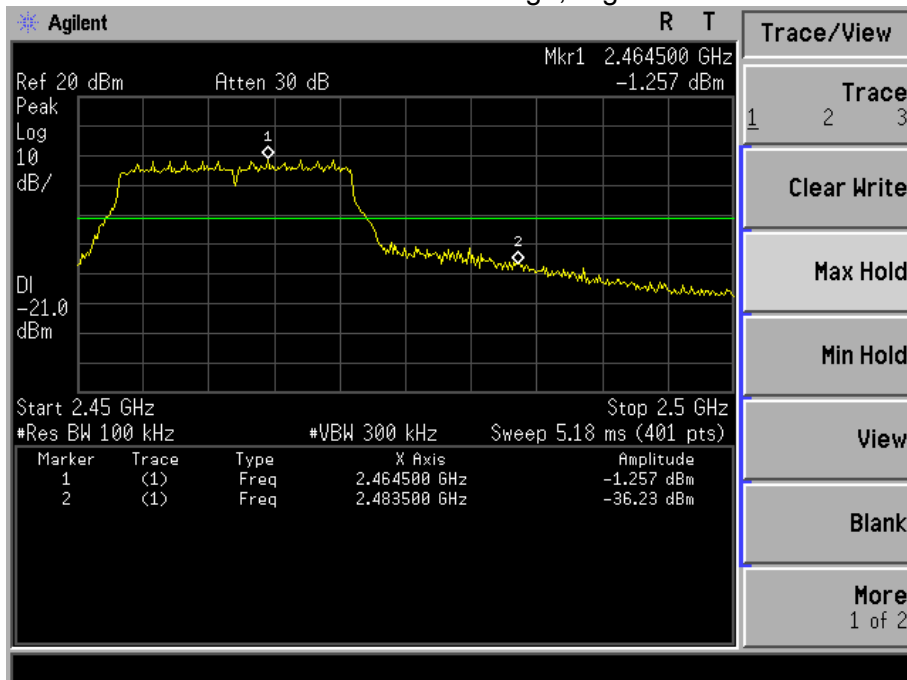

## **8. ANTENNA REQUIREMENT**

### **8.1 STANDARD REQUIREMENT**

15.203 requirement: For intentional device, according to 15.203: an intentional radiator shall be designed to ensure that no antenna other than that furnished by the responsible party shall be used with the device.

### **8.2 EUT ANTENNA**

The EUT antenna is Integrated antenna.It's permanent attached antenna. It comply with the standard requirement.

## 9. EUT TEST PHOTO

### Radiated Measurement Photos

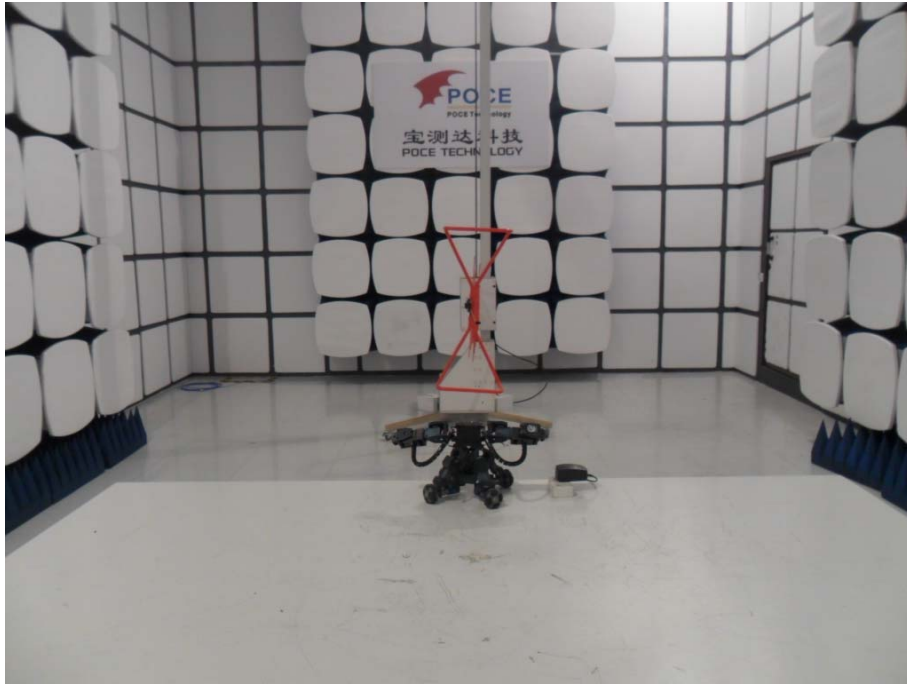

### Radiated Measurement Photos

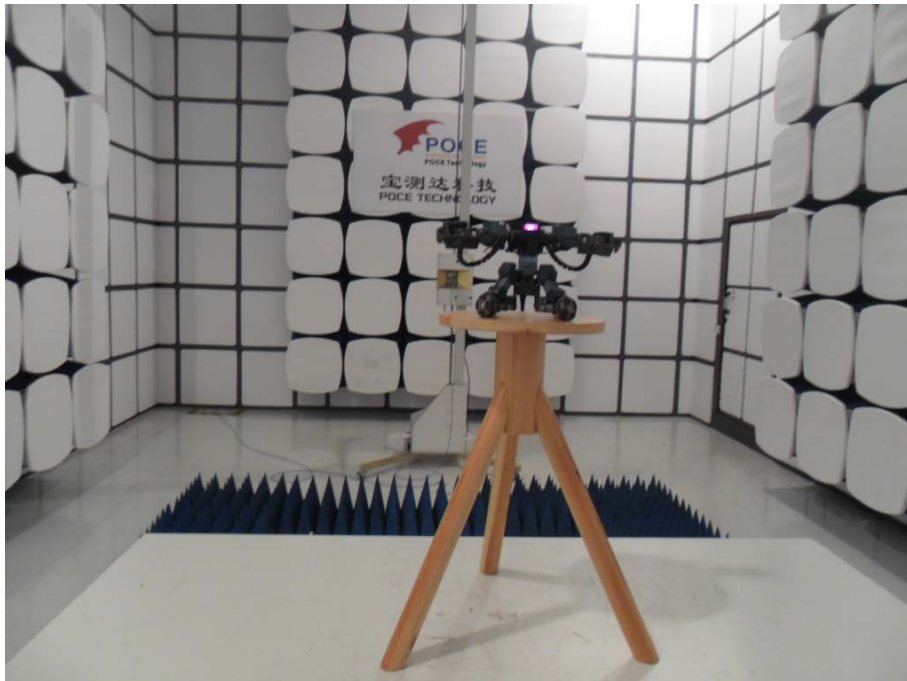



### Conducted Measurement Photos

