

FCC TEST REPORT

(Part 15, Subpart E)

Applicant:	Shenzhen GJS technology Co., LTD.
Address:	313 Bldg 7, Qianhai Shenzhen-Hong Kong Youth Innovation and Entrepreneur Hub, 35 Qianwan 1st Rd, Qianhai Shenzhen-Hong Kong Modern Service Industry Cooperation Zone, Shenzhen, Guangdong Province, China

Manufacturer or Supplier:	Shenzhen GJS technology Co., LTD.
Address:	313 Bldg 7, Qianhai Shenzhen-Hong Kong Youth Innovation and Entrepreneur Hub, 35 Qianwan 1st Rd, Qianhai Shenzhen-Hong Kong Modern Service Industry Cooperation Zone, Shenzhen, Guangdong Province, China
Product:	GANKER EX BATTLE ROBOT
Brand Name:	GJS ROBOT
Model Name:	G00500
FCC ID:	2A14F-G00500
Date of tests:	Jul. 03, 2019 ~ Jul. 29, 2019

The tests have been carried out according to the requirements of the following standard:

FCC Part 15, Subpart E, Section 15.407

CONCLUSION: The submitted sample was found to COMPLY with the test requirement

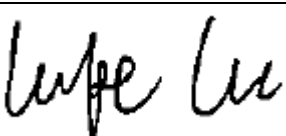
Prepared by Alex Chen Engineer / Mobile Department	Approved by Luke Lu Manager / Mobile Department
 Date: Aug. 01, 2019	 Date: Aug. 01, 2019

This report is governed by, and incorporates by reference, CPS Conditions of Service as posted at the date of issuance of this report at <http://www.bureauveritas.com/home/about-us/bur-business/cps/about-us/terms-conditions> and is intended for your exclusive use. Any copying or replication of this report to or for any other person or entity, or use of our name or trademark, is permitted only with our prior written permission. This report sets forth our findings solely with respect to the test samples identified herein. The results set forth in this report are not indicative or representative of the quality or characteristics of the lot from which a test sample was taken or any similar or identical product unless specifically and expressly noted. Our report includes all of the tests requested by you and the results thereof based upon the information that you provided to us. Measurement uncertainty is only provided upon request for accredited tests. You have 60 days from date of issuance of this report to notify us of any material error or omission caused by our negligence or if you require measurement uncertainty; provided, however, that such notice shall be in writing and shall specifically address the issue you wish to raise. A failure to raise such issue within the prescribed time shall constitute your unqualified acceptance of the completeness of this report, the tests conducted and the correctness of the report contents.



TABLE OF CONTENTS

RELEASE CONTROL RECORD	4
1 SUMMARY OF TEST RESULTS	5
1.1 MEASUREMENT UNCERTAINTY	5
2 GENERAL INFORMATION.....	6
2.1 GENERAL DESCRIPTION OF EUT	6
2.2 DESCRIPTION OF TEST MODES	8
2.2.1 TEST MODE APPLICABILITY AND TESTED CHANNEL DETAIL.....	9
2.3 DUTY CYCLE OF TEST SIGNAL	12
2.4 DESCRIPTION OF SUPPORT UNITS	13
2.4.1 CONFIGURATION OF SYSTEM UNDER TEST	14
2.5 GENERAL DESCRIPTION OF APPLIED STANDARDS	14
3 TEST TYPES AND RESULTS.....	15
3.1 RADIATED EMISSION AND BANDEDGE MEASUREMENT.....	15
3.1.1 LIMITS OF RADIATED EMISSION AND BANDEDGE MEASUREMENT.....	15
3.1.2 LIMITS OF UNWANTED EMISSION.....	15
3.1.3 TEST INSTRUMENTS.....	16
3.1.4 TEST PROCEDURES	17
3.1.5 DEVIATION FROM TEST STANDARD	17
3.1.6 TEST SETUP.....	18
3.1.7 EUT OPERATING CONDITION	19
3.1.8 TEST RESULTS	20
3.2 MAXIMUM CONDUCTED OUTPUT POWER MEASUREMENT	40
3.2.1 LIMITS OF MAXIMUM CONDUCTED OUTPUT POWER MEASUREMENT	40
3.2.2 TEST SETUP.....	41
3.2.3 TEST INSTRUMENTS.....	41
3.2.4 TEST PROCEDURE.....	42
3.2.5 DEVIATION FROM TEST STANDARD	44
3.2.6 EUT OPERATING CONDITIONS	44
3.2.7 TEST RESULTS	45
3.3 MAXIMUM POWER SPECTRAL DENSITY MEASUREMENT.....	52
3.3.1 LIMITS OF MAXIMUM POWER SPECTRAL DENSITY MEASUREMENT	52
3.3.2 TEST SETUP.....	52
3.3.3 TEST INSTRUMENTS.....	52



3.3.4	TEST PROCEDURES	53
3.3.5	DEVIATION FROM TEST STANDARD	53
3.3.6	EUT OPERATING CONDITIONS	53
3.3.7	TEST RESULTS	54
3.4	FREQUENCY STABILITY	58
3.4.1	LIMITS OF FREQUENCY STABILITY MEASUREMENT	58
3.4.2	TEST SETUP	58
3.4.3	TEST INSTRUMENTS	58
3.4.4	TEST PROCEDURE	59
3.4.5	DEVIATION FROM TEST STANDARD	59
3.4.6	EUT OPERATING CONDITION	59
3.4.7	TEST RESULTS	60
4	PHOTOGRAPHS OF THE TEST CONFIGURATION	62
5	APPENDIX A – MODIFICATIONS RECORDERS FOR ENGINEERING CHANGES TO THE EUT BY THE LAB	63



BUREAU
VERITAS

Test Report No.: RF190702W005

RELEASE CONTROL RECORD

ISSUE NO.	REASON FOR CHANGE	DATE ISSUED
RF190702W005	Original release	Aug. 01, 2019



1 SUMMARY OF TEST RESULTS

The EUT has been tested according to the following specifications:

APPLIED STANDARD: FCC PART 15, SUBPART E (SECTION 15.407)			
STANDARD SECTION	TEST TYPE AND LIMIT	RESULT	REMARK
15.407(b) (1/2/3/4/6)	Radiated Emission & Band Edge Measurement	PASS	Meet the requirement of limit. Minimum passing margin is -3.34dB at 83.35MHz.
15.407(a/1/2/3)	Maximum conducted output Power	PASS	Meet the requirement of limit.
15.407(a/1/2/3)	Peak Power Spectral Density	PASS	Meet the requirement of limit.
15.407(a) (1),(5)	26 dB Bandwidth	PASS	Meet the requirement of limit. (for U-NII-1 Band)
15.407(e)	6 dB Bandwidth	PASS	Meet the requirement of limit. (U-NII-3 Band only)
15.407(g)	Frequency Stability	PASS	Meet the requirement of limit.
15.203	Antenna Requirement	PASS	No antenna connector is used.

1.1 MEASUREMENT UNCERTAINTY

Where relevant, the following measurement uncertainty levels have been estimated for tests performed on the EUT as specified in CISPR 16-4-2:

MEASUREMENT	UNCERTAINTY
All Radiated emissions	±4.48dB
Conducted emissions	±2 dB
Occupied Channel Bandwidth	±21.7KHz
Conducted Output power	±1.03 dB
Power Spectral Density	±0.95 dB

This uncertainty represents an expanded uncertainty expressed at approximately the 95% confidence level using a coverage factor of k = 2.



2 GENERAL INFORMATION

2.1 GENERAL DESCRIPTION OF EUT

PRODUCT	GANKER EX BATTLE ROBOT
BRAND NAME	GJS ROBOT
MODEL NAME	G00500
NOMINAL VOLTAGE	DC 7.4V
BATTERY	Manufacturer: Shenzhen EPT Battery Co., Ltd Model Name: 54959P Power Rating: DC 7.4V, 2000mAh, Li-ion
MODULATION TYPE	64QAM, 16QAM, QPSK, BPSK
MODULATION TECHNOLOGY	OFDM
TRANSFER RATE	802.11a: 54.0/ 48.0/ 36.0/ 24.0/ 18.0/ 12.0/ 9.0/ 6.0Mbps 802.11n: up to MCS7
OPERATING FREQUENCY	5180 ~ 5240MHz, 5745 ~ 5805MHz
NUMBER OF CHANNEL	5180 ~ 5240MHz: 4 for 802.11a, 802.11n (20MHz) 5745 ~ 5805MHz: 4 for 802.11a, 802.11n (20MHz)
AVERAGE POWER	18.18dBm for 5180 ~ 5240MHz 18.28dBm for 5745 ~ 5805MHz
ANTENNA TYPE	5180 ~ 5240MHz: PCB Antenna0 with 1.07dBi gain 5180 ~ 5240MHz: PCB Antenna1 with 1.07dBi gain 5745 ~ 5805MHz: PCB Antenna0 with 1.07dBi gain 5745 ~ 5805MHz: PCB Antenna1 with 1.07dBi gain
HW VERSION	V4.0
SW VERSION	V0.32
I/O PORTS	Refer to user's manual
CABLE SUPPLIED	USB cable: non-shielded, detachable, 0.3meter

NOTE:

- For a more detailed features description, please refer to the manufacturer's specifications or the user's manual.
- The EUT incorporates a SISO function with 802.11a mode and a MIMO function with 802.11n (20MHz) mode. Physically, the EUT provides two completed transmitters and two receivers.

MODULATION MODE	TX FUNCTION
802.11a	1TX/1RX diversity
802.11n (20MHz)	2TX/2RX



Test Report No.: RF190702W005

3. For the test results, the EUT had been tested with all conditions. But only the worst case was shown in test report.



2.2 DESCRIPTION OF TEST MODES

FOR 5150 ~ 5250MHz

4 channels are provided for 802.11a, 802.11n (20MHz):

CHANNEL	FREQUENCY	CHANNEL	FREQUENCY
36	5180 MHz	44	5220 MHz
40	5200 MHz	48	5240 MHz

FOR 5725 ~ 5805MHz

4 channels are provided for 802.11a, 802.11n (20MHz):

CHANNEL	FREQUENCY	CHANNEL	FREQUENCY
149	5745 MHz	157	5785 MHz
153	5765 MHz	161	5805 MHz



2.2.1 TEST MODE APPLICABILITY AND TESTED CHANNEL DETAIL

EUT CONFIGURE MODE	APPLICABLE TO			DESCRIPTION
	RE≥1G	RE<1G	APCM	
A	-	-	-	Powered by Adapter with wifi(5G) link
B	√	√	√	Powered by Battery with wifi(5G) link
C	-	-	-	Powered by USB with wifi(5G) link

Where **RE≥1G**: Radiated Emission above 1GHz

RE<1G: Radiated Emission below 1GHz

APCM: Antenna Port Conducted Measurement

NOTE:

The EUT had been pre-tested on the positioned of each 3 axis. The worst case was found when positioned on **X-plane**.

NOTE: "-" means no effect.

RADIATED EMISSION TEST (ABOVE 1GHz):

- Pre-Scan has been conducted to determine the worst-case mode from all possible combinations between available modulations, data rates and antenna ports (if EUT with antenna diversity architecture).
- Following channel(s) was (were) selected for the final test as listed below.

EUT CONFIGURE MODE	MODE	FREQ. BAND (MHz)	AVAILABLE CHANNEL	TESTED CHANNEL	MODULATION TECHNOLOGY	MODULATION TYPE	DATA RATE (Mbps)
B	802.11a	5180-5240	36 to 48	36, 40, 48	OFDM	BPSK	6.0
B	802.11n (20MHz)		36 to 48	36, 40, 48	OFDM	BPSK	MCS0
B	802.11a	5725-5805	149 to 161	149, 157, 161	OFDM	BPSK	6.0
B	802.11n (20MHz)		149 to 161	149, 157, 161	OFDM	BPSK	MCS0



RADIATED EMISSION TEST (BELOW 1GHz):

- Pre-Scan has been conducted to determine the worst-case mode from all possible combinations between available modulations, data rates and antenna ports (if EUT with antenna diversity architecture).
- Following channel(s) was (were) selected for the final test as listed below.

EUT CONFIGURE MODE	MODE	FREQ. BAND (MHz)	AVAILABLE CHANNEL	TESTED CHANNEL	MODULATION TECHNOLOGY	MODULATION TYPE	DATA RATE (Mbps)
B	802.11a	5180-5320	36 to 64	40	OFDM	BPSK	6.0

BANDEDGE MEASUREMENT:

- Pre-Scan has been conducted to determine the worst-case mode from all possible combinations between available modulations, data rates and antenna ports (if EUT with antenna diversity architecture).
- Following channel(s) was (were) selected for the final test as listed below.

EUT CONFIGURE MODE	MODE	FREQ. BAND (MHz)	AVAILABLE CHANNEL	TESTED CHANNEL	MODULATION TECHNOLOGY	MODULATION TYPE	DATA RATE (Mbps)
B	802.11a	5180-5240	36 to 48	36, 48	OFDM	BPSK	6.0
B	802.11n (20MHz)		36 to 48	36, 48	OFDM	BPSK	MCS0
B	802.11a	5725-5805	149 to 161	149, 161	OFDM	BPSK	6.0
B	802.11n (20MHz)		149 to 161	149, 161	OFDM	BPSK	MCS0



ANTENNA PORT CONDUCTED MEASUREMENT:

- This item includes all test value of each mode, but only includes spectrum plot of worst value of each mode.
- Pre-Scan has been conducted to determine the worst-case mode from all possible combinations between available modulations, data rates and antenna ports (if EUT with antenna diversity architecture).
- Following channel(s) was (were) selected for the final test as listed below.

EUT CONFIGURE MODE	MODE	FREQ. BAND (MHz)	AVAILABLE CHANNEL	TESTED CHANNEL	MODULATION TECHNOLOGY	MODULATION TYPE	DATA RATE (Mbps)
B	802.11a	5180-5240	36 to 48	36, 40, 48	OFDM	BPSK	6.0
B	802.11n (20MHz)		36 to 48	36, 40, 48	OFDM	BPSK	MCS0
B	802.11a	5725-5805	149 to 161	149, 161	OFDM	BPSK	6.0
B	802.11n (20MHz)		149 to 161	149, 161	OFDM	BPSK	MCS0

TEST CONDITION:

APPLICABLE TO	ENVIRONMENTAL CONDITIONS	INPUT POWER	TESTED BY
RE<1G	23deg. C, 70%RH	DC 7.4V from battery	Tony Xiong
RE≥1G	23deg. C, 70%RH	DC 7.4V from battery	Tony Xiong
APCM	23deg. C, 70%RH	DC 7.4V from battery	Walker Ye



2.3 DUTY CYCLE OF TEST SIGNAL

Duty cycle of test signal is < 98%, duty factor shall be considered.

802.11a: Duty cycle = 2.019/2.084 = 0.969, Duty factor = 10 * log(1/0.969) = 0.138

802.11n (20MHz): Duty cycle = 1.880/1.933 = 0.973, Duty factor = 10 * log(1/0.973) = 0.121

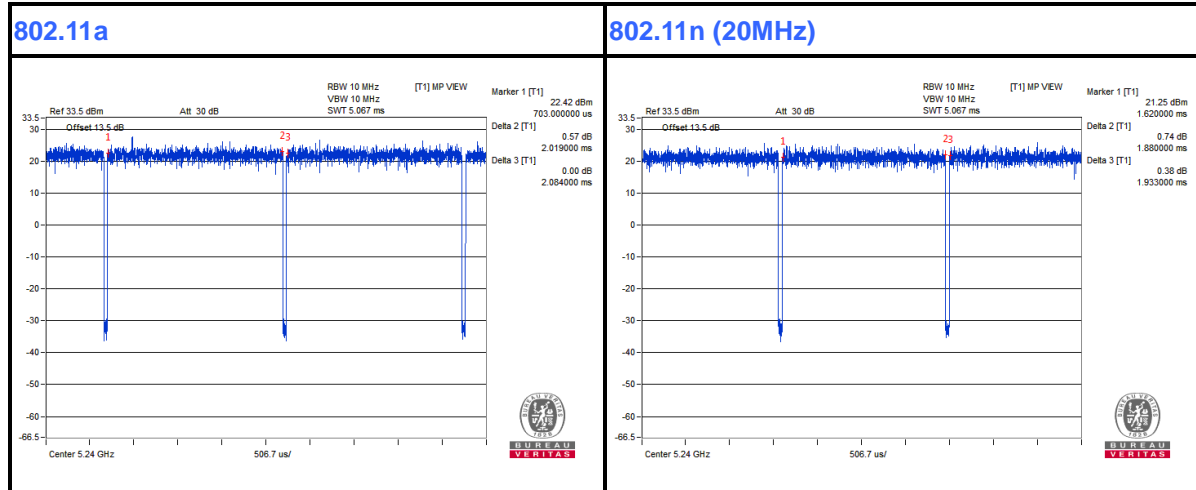



2.4 DESCRIPTION OF SUPPORT UNITS

The EUT has been tested as an independent unit together with other necessary accessories or support units. The following support units or accessories were used to form a representative test configuration during the tests.

NO.	PRODUCT	BRAND	MODEL NO.	SERIAL NO.	FCC ID
1	Laptop	Lenovo	Thnikpad L440	R90FTFKN	N/A

NO.	SIGNAL CABLE DESCRIPTION OF THE ABOVE SUPPORT UNITS
1	AC Line: Unshielded, Detachable 1.5m

NOTE:

1. All power cords of the above support units are non shielded (1.8m).



2.4.1 CONFIGURATION OF SYSTEM UNDER TEST

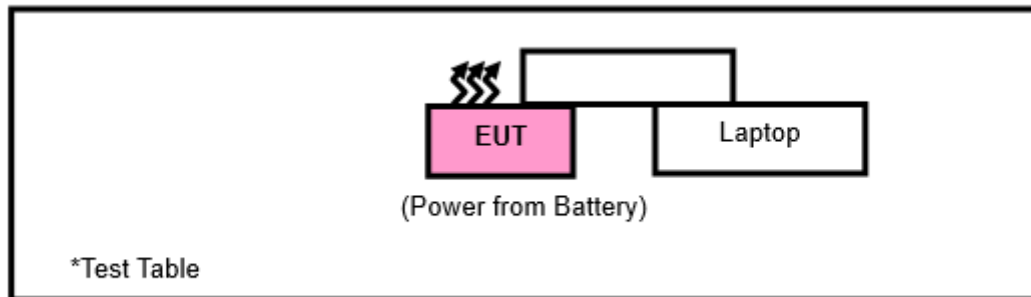

2.5 GENERAL DESCRIPTION OF APPLIED STANDARDS

The EUT is a RF Product. According to the specifications of the manufacturer, it must comply with the requirements of the following standards:

FCC Part 15, Subpart E (15.407)

KDB 789033 D02 General U-NII Test Procedures New Rules v02r01

ANSI C63.10-2013

All test items have been performed and recorded as per the above standards.

NOTE: The EUT is also considered as a kind of computer peripheral, because the connection to computer is necessary for typical use. It has been verified to comply with the requirements of FCC Part 15, Subpart B, Class B (Certification). The test report has been issued separately.



3 TEST TYPES AND RESULTS

3.1 RADIATED EMISSION AND BANDEDGE MEASUREMENT

3.1.1 LIMITS OF RADIATED EMISSION AND BANDEDGE MEASUREMENT

Radiated emissions which fall in the restricted bands must comply with the radiated emission limits specified as below table:

FREQUENCIES (MHz)	FIELD STRENGTH (microvolts/meter)	MEASUREMENT DISTANCE (meters)
0.009 ~ 0.490	2400/F(kHz)	300
0.490 ~ 1.705	24000/F(kHz)	30
1.705 ~ 30.0	30	30
30 ~ 88	100	3
88 ~ 216	150	3
216 ~ 960	200	3
Above 960	500	3

NOTE:

1. The lower limit shall apply at the transition frequencies.
2. Emission level (dBuV/m) = 20 log Emission level (uV/m).
3. For frequencies above 1000MHz, the field strength limits are based on average detector, however, the peak field strength of any emission shall not exceed the maximum permitted average limits, specified above by more than 20dB under any condition of modulation.

3.1.2 LIMITS OF UNWANTED EMISSION

RESTRICTED BANDS	APPLICABLE TO	LIMIT	
	789033 D02 General UNII Test Procedures New Rules v01r02	FIELD STRENGTH AT 3m (dBµV/m)	
	PK : 74	AV : 54	
OUT OF THE RESTRICTED BANDS	APPLICABLE TO	EIRP LIMIT (dBm/MHz)	EQUIVALENT FIELD STRENGTH AT 3m (dBµV/m)
	15.407(b)(1)	PK : -27	PK : 68.3
	15.407(b)(4)	See note 2 (FCC 16-24)	

NOTE: The following formula is used to convert the equipment isotropic radiated power (eirp) to field strength:

$$E = \frac{1000000\sqrt{30P}}{3} \mu\text{V/m, where P is the eirp (Watts).}$$

2. All emissions shall be limited to a level of -27 dBm/MHz at 75 MHz or more above or below the band edge increasing linearly to 10 dBm/MHz at 25 MHz above or below the band edge, and from 25 MHz above or below the band edge increasing linearly to a level of 15.6 dBm/MHz at 5 MHz above or below the band edge, and from 5 MHz above or below the band edge increasing linearly to a level of 27 dBm/MHz at the band edge.

3.1.3 TEST INSTRUMENTS

Equipment	Manufacturer	Model No.	Serial No.	Last Cal.	Next Cal.
3m Semi-anechoic Chamber	ETS-LINDGREN	9m*6m*6m	Euroshieldpn-CT0001143-1216	Feb. 26,19	Feb. 25,20
Bilog Antenna	ETS-LINDGREN	3143B	00161965	Feb. 26,19	Feb. 25,20
Horn Antenna	ETS-LINDGREN	3117	00168728	Feb. 26,19	Feb. 25,20
Horn Antenna (18GHz-40GHz)	N/A	QWH-SL-18-40-K-SG/QMS-00361	15433	Nov. 21, 18	Nov. 20, 19
Test Software	E3	V 9.160323	N/A	N/A	N/A
Test Software	ADT	ADT_Radiated_V7.6.15.9.2	N/A	N/A	N/A
10dB Attenuator	JFW/USA	50HF-010-SMA	1505	Jul. 09,19	Jul. 08, 20
MXE EMI Receiver	KEYSIGHT	N9038A-544	MY54450026	Feb. 26,19	Feb. 25,20
Signal Pre-Amplifier	EMSI	EMC 9135	980249	Jun. 24,19	Jun. 23,20
Signal Pre-Amplifier	EMSI	EMC 012645B	980257	Jun. 24,19	Jun. 23,20
Signal Pre-Amplifier	EMSI	EMC 184045B	980259	Jun. 24,19	Jun. 23,20

NOTE:

1. The calibration interval of the above test instruments is 12 months and the calibrations are traceable to CEPREI/CHINA, GRGT/CHINA and NIM/CHINA.
2. The test was performed in 3m Chamber.
3. The FCC Site Registration No. is 525120; The Designation No. is CN1171.



3.1.4 TEST PROCEDURES

- a. The EUT was placed on the top of a rotating table 0.8 meters (for below 1GHz) / 1.5 meters (for above 1GHz) above the ground at 3 meter chamber room for test. The table was rotated 360 degrees to determine the position of the highest radiation.
- b. The EUT was set 3 meters away from the interference-receiving antenna, which was mounted on the top of a variable-height antenna tower.
- c. The antenna is a broadband antenna, and its height is varied from one meter to four meters above the ground to determine the maximum value of the field strength. Both horizontal and vertical polarizations of the antenna are set to make the measurement.
- d. For each suspected emission, the EUT was arranged to its worst case and then the antenna was tuned to heights from 1 meter to 4 meters and the rotatable table was turned from 0 degrees to 360 degrees to find the maximum reading.
- e. The test-receiver system was set to Peak Detect Function and Specified Bandwidth with Maximum Hold Mode.
- f. If the emission level of the EUT in peak mode was 10dB lower than the limit specified, then testing could be stopped and the peak values of the EUT would be reported. Otherwise the emissions that did not have 10dB margin would be re-tested one by one using peak, quasi-peak or average method as specified and then reported in a data sheet.

NOTE:

1. The resolution bandwidth and video bandwidth of test receiver/spectrum analyzer is 120kHz for Peak detection (PK) and Quasi-peak detection (QP) at frequency below 1GHz.
2. The resolution bandwidth of test receiver/spectrum analyzer is 1MHz and video bandwidth is 3MHz for Peak detection at frequency above 1GHz.
3. The resolution bandwidth of test receiver/spectrum analyzer is 1MHz and the video bandwidth is 10Hz for Average detection (AV) at frequency above 1GHz.
4. All modes of operation were investigated and the worst-case emissions are reported.

3.1.5 DEVIATION FROM TEST STANDARD

No deviation.



3.1.6 TEST SETUP

< Frequency Range 30MHz~1GHz >

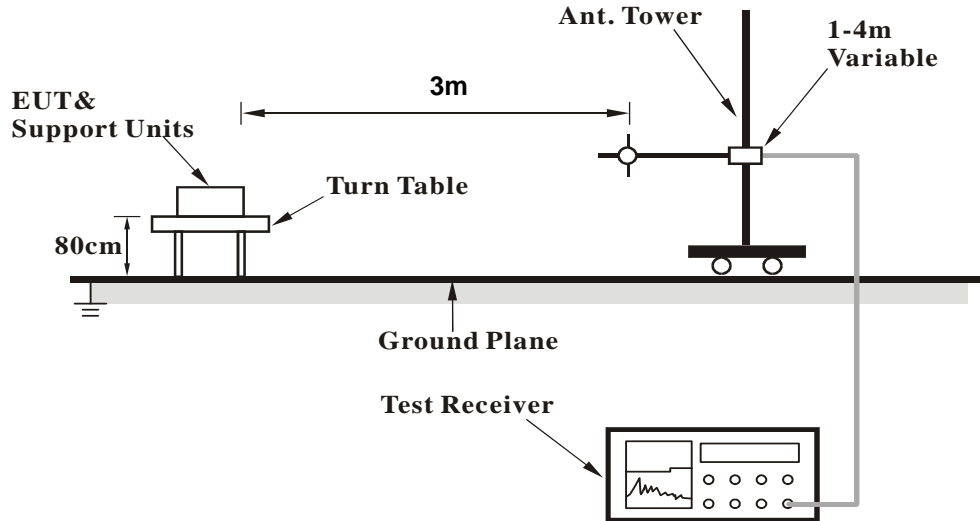

<Frequency Range above 1GHz>

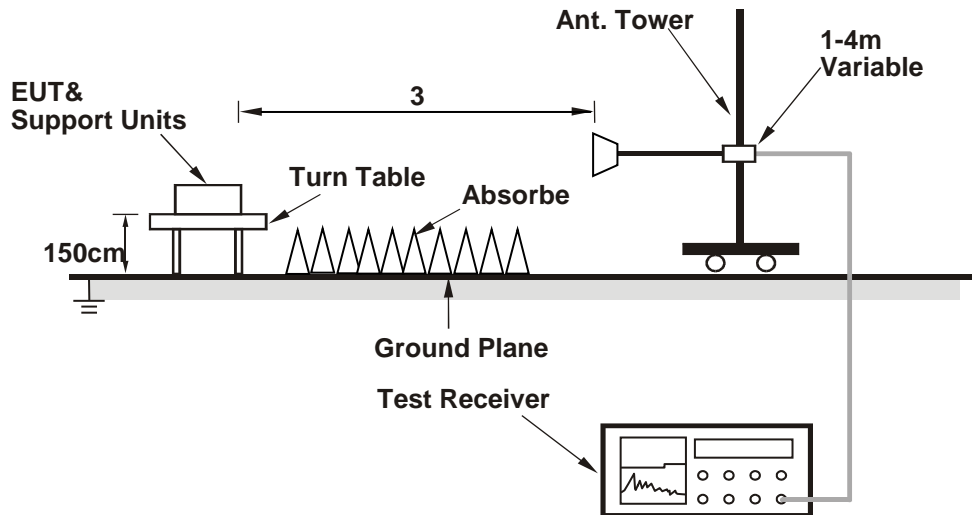

For the actual test configuration, please refer to the attached file (Test Setup Photo).



3.1.7 EUT OPERATING CONDITION

- a. Set the EUT under full load condition and placed them on a testing table.
- b. Set the transmitter part of EUT under transmission condition continuously at specific channel frequency.
- c. The necessary accessories enable the EUT in full functions.



3.1.8 TEST RESULTS

BELOW 1GHz WORST-CASE:

30 MHz – 1GHz data:

802.11a TEST DATA FROM ANT 0:

CHANNEL	TX Channel 40	DETECTOR FUNCTION	Quasi-Peak (QP)
FREQUENCY RANGE	30MHz ~ 1GHz		

ANTENNA POLARITY & TEST DISTANCE: HORIZONTAL AT 3 M										
FREQ. (MHz)	EMISSION LEVEL (dBuV/m)	READ LEVEL (dBuV)	LIMIT (dBuV/m)	MARGIN (dB)	ANTENNA FACTOR (dB /m)	CABLE LOSS (dB)	PREAMP FACTOR (dB)	ANTENNA HEIGHT (cm)	TABLE ANGLE (Degree)	REMARK
86.26	26.67	54.35	40	-13.33	8.35	1.25	37.28	100	0	Peak
109.54	27.35	53.96	43.5	-16.15	9.13	1.38	37.12	100	0	Peak
171.62	32.54	57.16	43.5	-10.96	10.38	1.68	36.68	100	0	Peak
231.76	29.69	52.15	46	-16.31	12.2	1.95	36.61	100	0	Peak
422.85	25.74	42.41	46	-20.26	17.5	2.7	36.87	100	0	Peak
675.05	34.43	46.2	46	-11.57	22.28	3.44	37.49	100	0	Peak

REMARKS:

1. Emission level (dBuV/m) = Raw Value (dBuV) + Correction Factor (dB/m).
2. Correction Factor (dB/m) = Antenna Factor (dB/m) + Cable Factor (dB).
3. The other emission levels were very low against the limit.
4. Margin value = Emission level – Limit value.

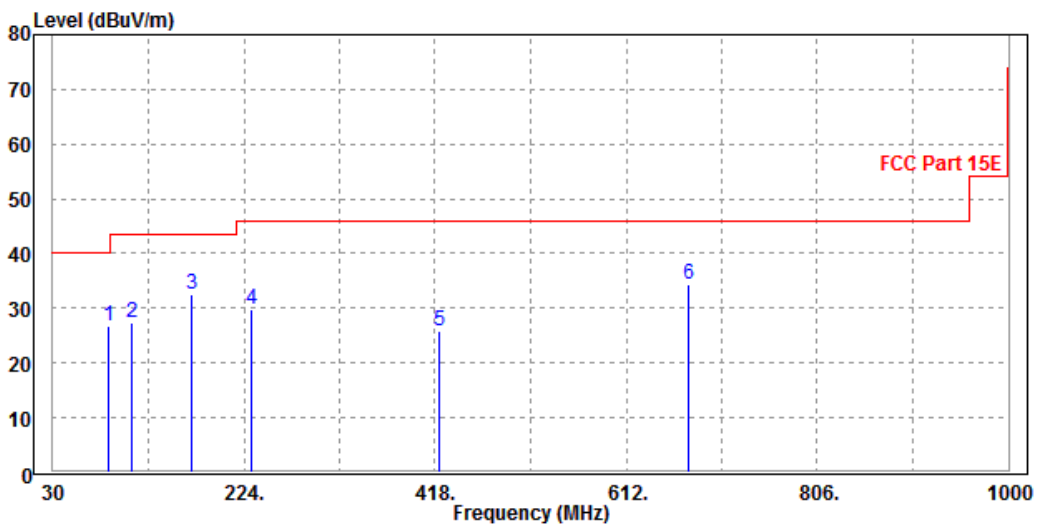



CHANNEL	Channel 40	DETECTOR FUNCTION	Quasi-Peak (QP)
FREQUENCY RANGE	30MHz ~ 1GHz		

ANTENNA POLARITY & TEST DISTANCE: VERTICAL AT 3 M										
FREQ. (MHz)	EMISSION LEVEL (dBuV/m)	READ LEVEL (dBuV)	LIMIT (dBuV/m)	MARGIN (dB)	ANTENNA FACTOR (dB /m)	CABLE LOSS (dB)	PREAMP FACTOR (dB)	ANTENNA HEIGHT (cm)	TABLE ANGLE (Degree)	REMARK
40.67	34.85	58.54	40	-5.15	12.88	0.93	37.5	100	360	Peak
83.35	36.66	64.34	40	-3.34	8.4	1.23	37.31	100	360	Peak
178.41	24.66	49.21	43.5	-18.84	10.4	1.7	36.65	100	360	Peak
450.01	27.05	43.16	46	-18.95	18	2.81	36.92	100	360	Peak
500.45	23.86	39.16	46	-22.14	18.71	2.99	37	100	360	Peak
675.05	26.48	38.25	46	-19.52	22.28	3.44	37.49	100	360	Peak

REMARKS:

1. Emission level (dBuV/m) = Raw Value (dBuV) + Correction Factor (dB/m).
2. Correction Factor (dB/m) = Antenna Factor (dB/m) + Cable Factor (dB).
3. The other emission levels were very low against the limit.
4. Margin value = Emission level – Limit value.

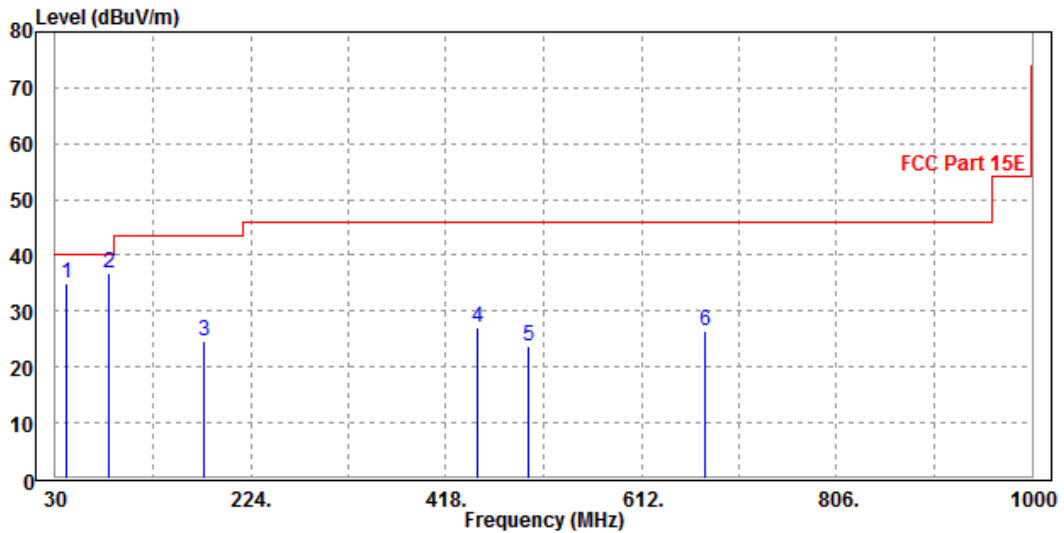



ABOVE 1GHZ WORST-CASE:

Note: For higher frequency, the emission is too low to be detected.

Band 1

802.11a TEST DATA FROM ANT 0:

CHANNEL	TX Channel 36	DETECTOR FUNCTION	Peak (PK)
FREQUENCY RANGE	1GHz ~ 40GHz		Average (AV)

ANTENNA POLARITY & TEST DISTANCE: HORIZONTAL AT 3 M

FREQ. (MHz)	EMISSION LEVEL (dBuV/m)	READ LEVEL (dBuV)	LIMIT (dBuV/m)	MARGIN (dB)	ANTENNA FACTOR (dB /m)	CABLE LOSS (dB)	PREAMP FACTOR (dB)	ANTENNA HEIGHT (cm)	TABLE ANGLE (Degree)	REMARK
5150	61.37	64.35	74	-12.63	35.95	7.42	46.35	200	123	Peak
5150	48.68	51.66	54	-5.32	35.95	7.42	46.35	200	123	Average
5180	103.39	106.33			35.98	7.43	46.35	200	123	Peak
5180	94.88	97.82			35.98	7.43	46.35	200	123	Average
5350	56.78	59.46	74	-17.22	36.15	7.47	46.3	200	123	Peak
5350	43.24	45.92	54	-10.76	36.15	7.47	46.3	200	123	Average

ANTENNA POLARITY & TEST DISTANCE: VERTICAL AT 3 M

FREQ. (MHz)	EMISSION LEVEL (dBuV/m)	READ LEVEL (dBuV)	LIMIT (dBuV/m)	MARGIN (dB)	ANTENNA FACTOR (dB /m)	CABLE LOSS (dB)	PREAMP FACTOR (dB)	ANTENNA HEIGHT (cm)	TABLE ANGLE (Degree)	REMARK
5150	62.18	64.82	74	-11.82	36.29	7.42	46.35	100	185	Peak
5150	47.58	50.22	54	-6.42	36.29	7.42	46.35	100	185	Average
5180	104.62	107.23			36.31	7.43	46.35	100	185	Peak
5180	95.01	97.62			36.31	7.43	46.35	100	185	Average
5350	56.7	59.12	74	-17.3	36.41	7.47	46.3	100	185	Peak
5350	43.47	45.89	54	-10.53	36.41	7.47	46.3	100	185	Average

REMARKS:

- Emission Level = Read Level+ Antenna Factor + Cable Loss- Preamp Factor
Margin value = Emission level – Limit value.
- 5180MHz: Fundamental frequency.



CHANNEL	TX Channel 40	DETECTOR FUNCTION	Peak (PK)
FREQUENCY RANGE	1GHz ~ 40GHz		Average (AV)

ANTENNA POLARITY & TEST DISTANCE: HORIZONTAL AT 3 M										
FREQ. (MHz)	EMISSION LEVEL (dBuV/m)	READ LEVEL (dBuV)	LIMIT (dBuV/m)	MARGIN (dB)	ANTENNA FACTOR (dB /m)	CABLE LOSS (dB)	PREAMP FACTOR (dB)	ANTENNA HEIGHT (cm)	TABLE ANGLE (Degree)	REMARK
5150	61.24	64.22	74	-12.76	35.95	7.42	46.35	200	165	Peak
5150	49.33	52.31	54	-4.67	35.95	7.42	46.35	200	165	Average
5200	107.73	110.64			36	7.43	46.34	200	165	Peak
5200	97.58	100.49			36	7.43	46.34	200	165	Average
5350	57.43	60.11	74	-16.57	36.15	7.47	46.3	200	165	Peak
5350	44.23	46.91	54	-9.77	36.15	7.47	46.3	200	165	Average

ANTENNA POLARITY & TEST DISTANCE: VERTICAL AT 3 M										
FREQ. (MHz)	EMISSION LEVEL (dBuV/m)	READ LEVEL (dBuV)	LIMIT (dBuV/m)	MARGIN (dB)	ANTENNA FACTOR (dB /m)	CABLE LOSS (dB)	PREAMP FACTOR (dB)	ANTENNA HEIGHT (cm)	TABLE ANGLE (Degree)	REMARK
5150	59.47	62.11	74	-14.53	36.29	7.42	46.35	100	246	Peak
5150	47.25	49.89	54	-6.75	36.29	7.42	46.35	100	246	Average
5200	106.27	108.86			36.32	7.43	46.34	100	246	Peak
5200	97.53	100.12			36.32	7.43	46.34	100	246	Average
5350	56.4	58.82	74	-17.6	36.41	7.47	46.3	100	246	Peak
5350	43.54	45.96	54	-10.46	36.41	7.47	46.3	100	246	Average

REMARKS:

- Emission Level = Read Level+ Antenna Factor + Cable Loss- Preamp Factor
Margin value = Emission level – Limit value.
- 5200MHz: Fundamental frequency.



CHANNEL	TX Channel 48	DETECTOR FUNCTION	Peak (PK)
FREQUENCY RANGE	1GHz ~ 40GHz		Average (AV)

ANTENNA POLARITY & TEST DISTANCE: HORIZONTAL AT 3 M

FREQ. (MHz)	EMISSION LEVEL (dBuV/m)	READ LEVEL (dBuV)	LIMIT (dBuV/m)	MARGIN (dB)	ANTENNA FACTOR (dB /m)	CABLE LOSS (dB)	PREAMP FACTOR (dB)	ANTENNA HEIGHT (cm)	TABLE ANGLE (Degree)	REMARK
5150	59.17	62.15	74	-14.83	35.95	7.42	46.35	100	197	Peak
5150	45.61	48.59	54	-8.39	35.95	7.42	46.35	100	197	Average
5240	107.31	110.16			36.04	7.44	46.33	100	197	Peak
5240	108.28	111.13			36.04	7.44	46.33	100	197	Average
5350	57.17	59.85	74	-16.83	36.15	7.47	46.3	100	197	Peak
5350	44.09	46.77	54	-9.91	36.15	7.47	46.3	100	197	Average

ANTENNA POLARITY & TEST DISTANCE: VERTICAL AT 3 M

FREQ. (MHz)	EMISSION LEVEL (dBuV/m)	READ LEVEL (dBuV)	LIMIT (dBuV/m)	MARGIN (dB)	ANTENNA FACTOR (dB /m)	CABLE LOSS (dB)	PREAMP FACTOR (dB)	ANTENNA HEIGHT (cm)	TABLE ANGLE (Degree)	REMARK
5150	59.48	62.12	74	-14.52	36.29	7.42	46.35	154	87	Peak
5150	46.67	49.31	54	-7.33	36.29	7.42	46.35	154	87	Average
5240	109.44	111.99			36.34	7.44	46.33	154	87	Peak
5240	100.92	103.47			36.34	7.44	46.33	154	87	Average
5350	56.44	58.86	74	-17.56	36.41	7.47	46.3	154	87	Peak
5350	43.8	46.22	54	-10.2	36.41	7.47	46.3	154	87	Average

REMARKS:

- Emission Level = Read Level+ Antenna Factor + Cable Loss- Preamp Factor
Margin value = Emission level – Limit value.
- 5240MHz: Fundamental frequency.



802.11n (20MHz) TEST DATA FROM ANT 0+ANT1:

CHANNEL	TX Channel 36	DETECTOR FUNCTION	Peak (PK)
FREQUENCY RANGE	1GHz ~ 40GHz		Average (AV)

ANTENNA POLARITY & TEST DISTANCE: HORIZONTAL AT 3 M										
FREQ. (MHz)	EMISSION LEVEL (dBuV/m)	READ LEVEL (dBuV)	LIMIT (dBuV/m)	MARGIN (dB)	ANTENNA FACTOR (dB /m)	CABLE LOSS (dB)	PREAMP FACTOR (dB)	ANTENNA HEIGHT (cm)	TABLE ANGLE (Degree)	REMARK
5150	60.57	63.55	74	-13.43	35.95	7.42	46.35	120	129	Peak
5150	48.18	51.16	54	-5.82	35.95	7.42	46.35	120	129	Average
5180	107.29	110.23			35.98	7.43	46.35	120	129	Peak
5180	97.57	100.51			35.98	7.43	46.35	120	129	Average
5350	56.56	59.24	74	-17.44	36.15	7.47	46.3	120	129	Peak
5350	44.14	46.82	54	-9.86	36.15	7.47	46.3	120	129	Average

ANTENNA POLARITY & TEST DISTANCE: VERTICAL AT 3 M										
FREQ. (MHz)	EMISSION LEVEL (dBuV/m)	READ LEVEL (dBuV)	LIMIT (dBuV/m)	MARGIN (dB)	ANTENNA FACTOR (dB /m)	CABLE LOSS (dB)	PREAMP FACTOR (dB)	ANTENNA HEIGHT (cm)	TABLE ANGLE (Degree)	REMARK
5150	58.72	61.36	74	-15.28	36.29	7.42	46.35	100	235	Peak
5150	45.65	48.29	54	-8.35	36.29	7.42	46.35	100	235	Average
5180	103.85	106.46	74	29.85	36.31	7.43	46.35	100	235	Peak
5180	94.55	97.16	54	40.55	36.31	7.43	46.35	100	235	Average
5350	57.73	60.15	74	-16.27	36.41	7.47	46.3	100	235	Peak
5350	43.89	46.31	54	-10.11	36.41	7.47	46.3	100	235	Average

REMARKS:

1. Emission Level = Read Level+ Antenna Factor + Cable Loss- Preamp Factor
Margin value = Emission level – Limit value.
2. 5180MHz: Fundamental frequency.



CHANNEL	TX Channel 40	DETECTOR FUNCTION	Peak (PK)
FREQUENCY RANGE	1GHz ~ 40GHz		Average (AV)

ANTENNA POLARITY & TEST DISTANCE: HORIZONTAL AT 3 M										
FREQ. (MHz)	EMISSION LEVEL (dBuV/m)	READ LEVEL (dBuV)	LIMIT (dBuV/m)	MARGIN (dB)	ANTENNA FACTOR (dB /m)	CABLE LOSS (dB)	PREAMP FACTOR (dB)	ANTENNA HEIGHT (cm)	TABLE ANGLE (Degree)	REMARK
5150	58.91	61.89	74	-15.09	35.95	7.42	46.35	157	198	Peak
5150	45.91	48.89	54	-8.09	35.95	7.42	46.35	157	198	Average
5200	104.06	106.97			36	7.43	46.34	157	198	Peak
5200	95.25	98.16			36	7.43	46.34	157	198	Average
5350	54.99	57.67	74	-19.01	36.15	7.47	46.3	157	198	Peak
5350	43.51	46.19	54	-10.49	36.15	7.47	46.3	157	198	Average
ANTENNA POLARITY & TEST DISTANCE: VERTICAL AT 3 M										
FREQ. (MHz)	EMISSION LEVEL (dBuV/m)	READ LEVEL (dBuV)	LIMIT (dBuV/m)	MARGIN (dB)	ANTENNA FACTOR (dB /m)	CABLE LOSS (dB)	PREAMP FACTOR (dB)	ANTENNA HEIGHT (cm)	TABLE ANGLE (Degree)	REMARK
5150	57.57	60.21	74	-16.43	36.29	7.42	46.35	100	260	Peak
5150	44.95	47.59	54	-9.05	36.29	7.42	46.35	100	260	Average
5200	101.57	104.16			36.32	7.43	46.34	100	260	Peak
5200	92.54	95.13			36.32	7.43	46.34	100	260	Average
5350	56.74	59.16	74	-17.26	36.41	7.47	46.3	100	260	Peak
5350	43.7	46.12	54	-10.3	36.41	7.47	46.3	100	260	Average

REMARKS:

- Emission Level = Read Level+ Antenna Factor + Cable Loss- Preamp Factor
Margin value = Emission level – Limit value.
- 5200MHz: Fundamental frequency.



CHANNEL	TX Channel 48	DETECTOR FUNCTION	Peak (PK)
FREQUENCY RANGE	1GHz ~ 40GHz		Average (AV)

ANTENNA POLARITY & TEST DISTANCE: HORIZONTAL AT 3 M										
FREQ. (MHz)	EMISSION LEVEL (dBuV/m)	READ LEVEL (dBuV)	LIMIT (dBuV/m)	MARGIN (dB)	ANTENNA FACTOR (dB /m)	CABLE LOSS (dB)	PREAMP FACTOR (dB)	ANTENNA HEIGHT (cm)	TABLE ANGLE (Degree)	REMARK
5150	58.21	61.19	74	-15.79	35.95	7.42	46.35	158	145	Peak
5150	45.28	48.26	54	-8.72	35.95	7.42	46.35	158	145	Average
5240	105.76	108.61			36.04	7.44	46.33	158	145	Peak
5240	95.46	98.31			36.04	7.44	46.33	158	145	Average
5350	57.57	60.25	74	-16.43	36.15	7.47	46.3	158	145	Peak
5350	43.93	46.61	54	-10.07	36.15	7.47	46.3	158	145	Average

ANTENNA POLARITY & TEST DISTANCE: VERTICAL AT 3 M										
FREQ. (MHz)	EMISSION LEVEL (dBuV/m)	READ LEVEL (dBuV)	LIMIT (dBuV/m)	MARGIN (dB)	ANTENNA FACTOR (dB /m)	CABLE LOSS (dB)	PREAMP FACTOR (dB)	ANTENNA HEIGHT (cm)	TABLE ANGLE (Degree)	REMARK
5150	57.54	60.18	74	-16.46	36.29	7.42	46.35	100	257	Peak
5150	44.92	47.56	54	-9.08	36.29	7.42	46.35	100	257	Average
5240	104.67	107.22			36.34	7.44	46.33	100	257	Peak
5240	94.07	96.62			36.34	7.44	46.33	100	257	Average
5350	56.7	59.12	74	-17.3	36.41	7.47	46.3	100	257	Peak
5350	43.82	46.24	54	-10.18	36.41	7.47	46.3	100	257	Average

REMARKS:

- Emission Level = Read Level+ Antenna Factor + Cable Loss- Preamp Factor
Margin value = Emission level – Limit value.
- 5240MHz: Fundamental frequency.



Band 4

802.11a TEST DATA FROM ANT 0:

CHANNEL	TX Channel 149	DETECTOR FUNCTION	Peak (PK)
FREQUENCY RANGE	1GHz ~ 40GHz		Average (AV)

ANTENNA POLARITY & TEST DISTANCE: HORIZONTAL AT 3 M										
FREQ. (MHz)	EMISSION LEVEL (dBuV/m)	READ LEVEL (dBuV)	LIMIT (dBuV/m)	MARGIN (dB)	ANTENNA FACTOR (dB /m)	CABLE LOSS (dB)	PREAMP FACTOR (dB)	ANTENNA HEIGHT (cm)	TABLE ANGLE (Degree)	REMARK
5745	109.16	111.19			36.4	7.75	46.18	200	125	Peak
5745	99.23	101.26			36.4	7.75	46.18	200	125	Average
ANTENNA POLARITY & TEST DISTANCE: VERTICAL AT 3 M										
FREQ. (MHz)	EMISSION LEVEL (dBuV/m)	READ LEVEL (dBuV)	LIMIT (dBuV/m)	MARGIN (dB)	ANTENNA FACTOR (dB /m)	CABLE LOSS (dB)	PREAMP FACTOR (dB)	ANTENNA HEIGHT (cm)	TABLE ANGLE (Degree)	REMARK
5745	108.79	110.57			36.65	7.75	46.18	100	80	Peak
5745	98.34	100.12			36.65	7.75	46.18	100	80	Average

REMARKS:

1. Emission Level = Read Level+ Antenna Factor + Cable Loss- Preamp Factor
Margin value = Emission level – Limit value.
2. 5745MHz: Fundamental frequency.



OBE DATA

802.11a TEST DATA FROM ANT 0:

ANTENNA POLARITY & TEST DISTANCE: HORIZONTAL AT 3 M										
FREQ. (MHz)	EMISSION LEVEL (dBuV/m)	READ LEVEL (dBuV)	LIMIT (dBuV/m)	MARGIN (dB)	ANTENNA FACTOR (dB /m)	CABLE LOSS (dB)	PREAMP FACTOR (dB)	ANTENNA HEIGHT (cm)	TABLE ANGLE (Degree)	REMARK
5620.3	56.91	59.16	68.3	-11.39	36.35	7.62	46.22	100	0	Peak
5951.375	56.46	58.14	68.3	-11.84	36.48	7.96	46.12	100	0	Peak
ANTENNA POLARITY & TEST DISTANCE: VERTICAL AT 3 M										
FREQ. (MHz)	EMISSION LEVEL (dBuV/m)	READ LEVEL (dBuV)	LIMIT (dBuV/m)	MARGIN (dB)	ANTENNA FACTOR (dB /m)	CABLE LOSS (dB)	PREAMP FACTOR (dB)	ANTENNA HEIGHT (cm)	TABLE ANGLE (Degree)	REMARK
5617.45	57.13	59.16	68.3	-11.17	36.57	7.62	46.22	200	0	Peak
5967.525	56.9	58.26	68.3	-11.4	36.78	7.98	46.12	200	0	Peak

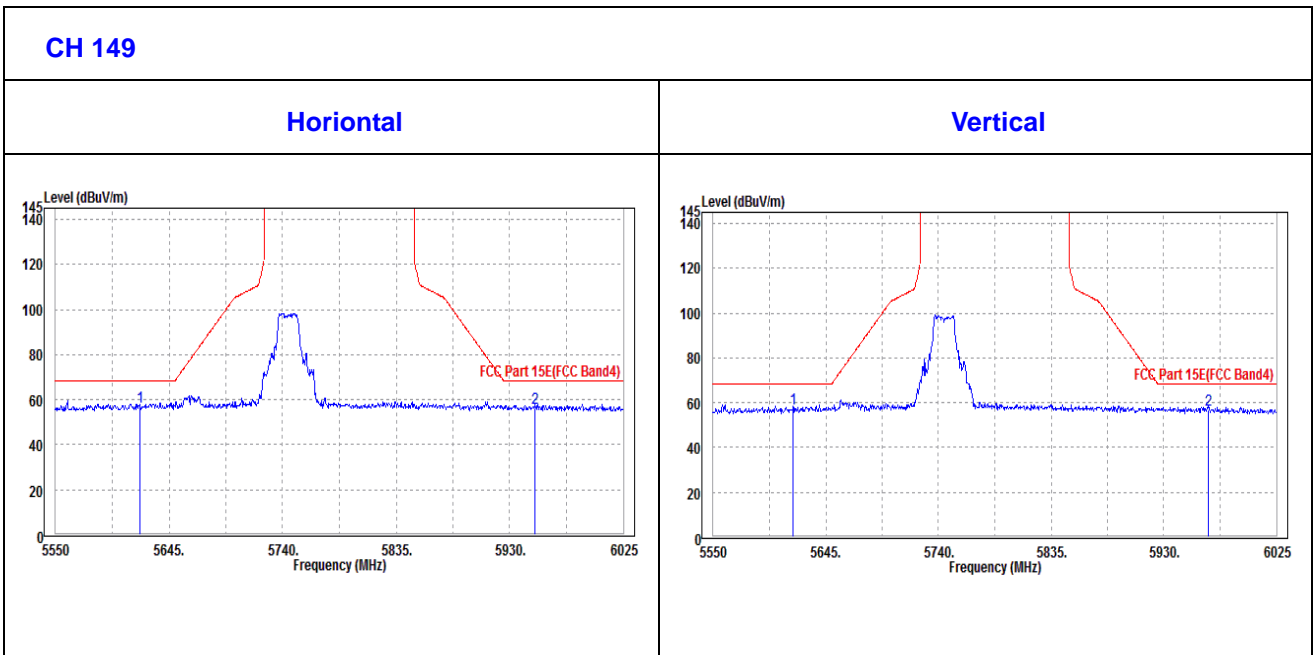



CHANNEL	TX Channel 157	DETECTOR FUNCTION	Peak (PK)
FREQUENCY RANGE	1GHz ~ 40GHz		Average (AV)

ANTENNA POLARITY & TEST DISTANCE: HORIZONTAL AT 3 M

FREQ. (MHz)	EMISSION LEVEL (dBuV/m)	READ LEVEL (dBuV)	LIMIT (dBuV/m)	MARGIN (dB)	ANTENNA FACTOR (dB /m)	CABLE LOSS (dB)	PREAMP FACTOR (dB)	ANTENNA HEIGHT (cm)	TABLE ANGLE (Degree)	REMARK
5785	103.92	105.89			36.41	7.79	46.17	200	150	Peak
5785	94.84	96.81			36.41	7.79	46.17	200	150	Average

ANTENNA POLARITY & TEST DISTANCE: VERTICAL AT 3 M

FREQ. (MHz)	EMISSION LEVEL (dBuV/m)	READ LEVEL (dBuV)	LIMIT (dBuV/m)	MARGIN (dB)	ANTENNA FACTOR (dB /m)	CABLE LOSS (dB)	PREAMP FACTOR (dB)	ANTENNA HEIGHT (cm)	TABLE ANGLE (Degree)	REMARK
5785	107.55	109.26			36.67	7.79	46.17	120	196	Peak
5785	99.93	101.64			36.67	7.79	46.17	120	196	Average

REMARKS:

- Emission Level = Read Level+ Antenna Factor + Cable Loss- Preamp Factor
Margin value = Emission level – Limit value.
- 5785MHz: Fundamental frequency.



Oobe Data

802.11a TEST DATA FROM ANT 0:

ANTENNA POLARITY & TEST DISTANCE: HORIZONTAL AT 3 M										
FREQ. (MHz)	EMISSION LEVEL (dBuV/m)	READ LEVEL (dBuV)	LIMIT (dBuV/m)	MARGIN (dB)	ANTENNA FACTOR (dB /m)	CABLE LOSS (dB)	PREAMP FACTOR (dB)	ANTENNA HEIGHT (cm)	TABLE ANGLE (Degree)	REMARK
5599.875	50.18	52.46	68.3	-18.12	36.34	7.6	46.22	200	0	Peak
5966.1	46.23	47.88	68.3	-22.07	36.49	7.98	46.12	200	0	Peak
ANTENNA POLARITY & TEST DISTANCE: VERTICAL AT 3 M										
FREQ. (MHz)	EMISSION LEVEL (dBuV/m)	READ LEVEL (dBuV)	LIMIT (dBuV/m)	MARGIN (dB)	ANTENNA FACTOR (dB /m)	CABLE LOSS (dB)	PREAMP FACTOR (dB)	ANTENNA HEIGHT (cm)	TABLE ANGLE (Degree)	REMARK
5602.25	48.17	50.23	68.3	-20.13	36.56	7.6	46.22	100	0	Peak
5975.6	47.78	49.12	68.3	-20.52	36.79	7.99	46.12	100	0	Peak

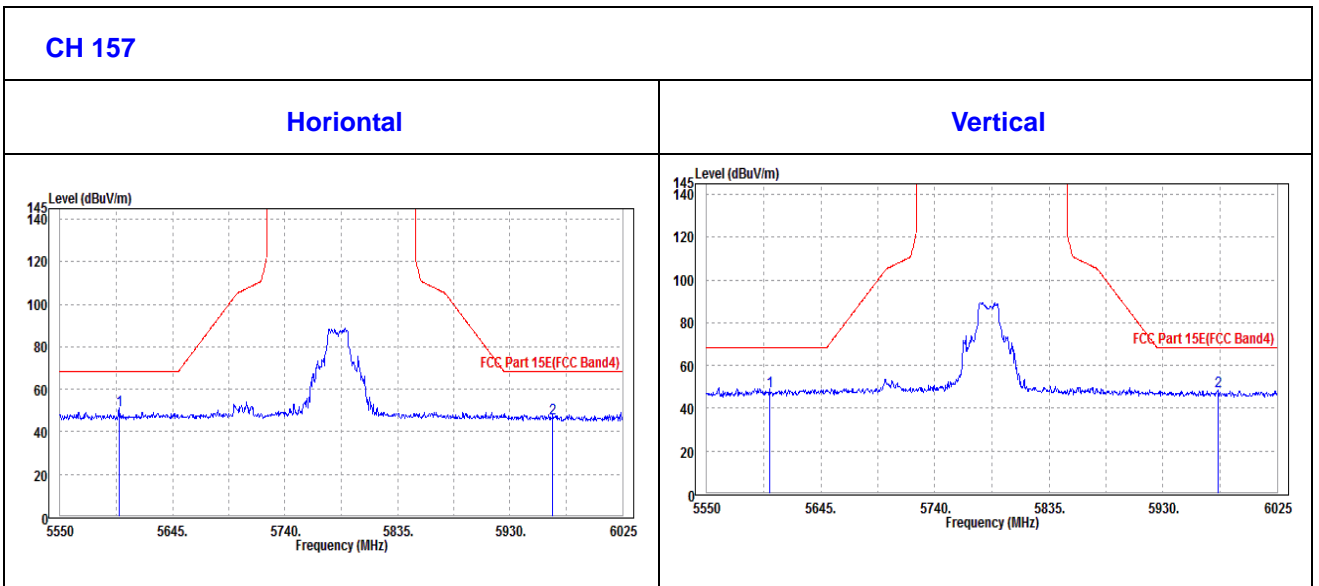



CHANNEL	TX Channel 161	DETECTOR FUNCTION	Peak (PK)
FREQUENCY RANGE	1GHz ~ 40GHz		Average (AV)

ANTENNA POLARITY & TEST DISTANCE: HORIZONTAL AT 3 M										
FREQ. (MHz)	EMISSION LEVEL (dBuV/m)	READ LEVEL (dBuV)	LIMIT (dBuV/m)	MARGIN (dB)	ANTENNA FACTOR (dB /m)	CABLE LOSS (dB)	PREAMP FACTOR (dB)	ANTENNA HEIGHT (cm)	TABLE ANGLE (Degree)	REMARK
5825	107.96	109.86			36.43	7.83	46.16	143	135	Peak
5825	99.47	101.37			36.43	7.83	46.16	143	135	Average
ANTENNA POLARITY & TEST DISTANCE: VERTICAL AT 3 M										
FREQ. (MHz)	EMISSION LEVEL (dBuV/m)	READ LEVEL (dBuV)	LIMIT (dBuV/m)	MARGIN (dB)	ANTENNA FACTOR (dB /m)	CABLE LOSS (dB)	PREAMP FACTOR (dB)	ANTENNA HEIGHT (cm)	TABLE ANGLE (Degree)	REMARK
5825	108.23	109.87			36.69	7.83	46.16	100	188	Peak
5825	99.01	100.65			36.69	7.83	46.16	100	188	Average

REMARKS:

- Emission Level = Read Level+ Antenna Factor + Cable Loss- Preamp Factor
Margin value = Emission level – Limit value.
- 5805MHz: Fundamental frequency.



Oobe Data

802.11a TEST DATA FROM ANT 0:

ANTENNA POLARITY & TEST DISTANCE: HORIZONTAL AT 3 M										
FREQ. (MHz)	EMISSION LEVEL (dBuV/m)	READ LEVEL (dBuV)	LIMIT (dBuV/m)	MARGIN (dB)	ANTENNA FACTOR (dB /m)	CABLE LOSS (dB)	PREAMP FACTOR (dB)	ANTENNA HEIGHT (cm)	TABLE ANGLE (Degree)	REMARK
5611.275	58.79	61.06	68.3	-9.51	36.34	7.61	46.22	200	156	Peak
5966.575	56.88	58.53	68.3	-11.42	36.49	7.98	46.12	200	156	Peak
ANTENNA POLARITY & TEST DISTANCE: VERTICAL AT 3 M										
FREQ. (MHz)	EMISSION LEVEL (dBuV/m)	READ LEVEL (dBuV)	LIMIT (dBuV/m)	MARGIN (dB)	ANTENNA FACTOR (dB /m)	CABLE LOSS (dB)	PREAMP FACTOR (dB)	ANTENNA HEIGHT (cm)	TABLE ANGLE (Degree)	REMARK
5599.875	61.2	63.26	68.3	-7.1	36.56	7.6	46.22	100	164	Peak
5955.175	57.25	58.64	68.3	-11.05	36.77	7.96	46.12	100	164	Peak

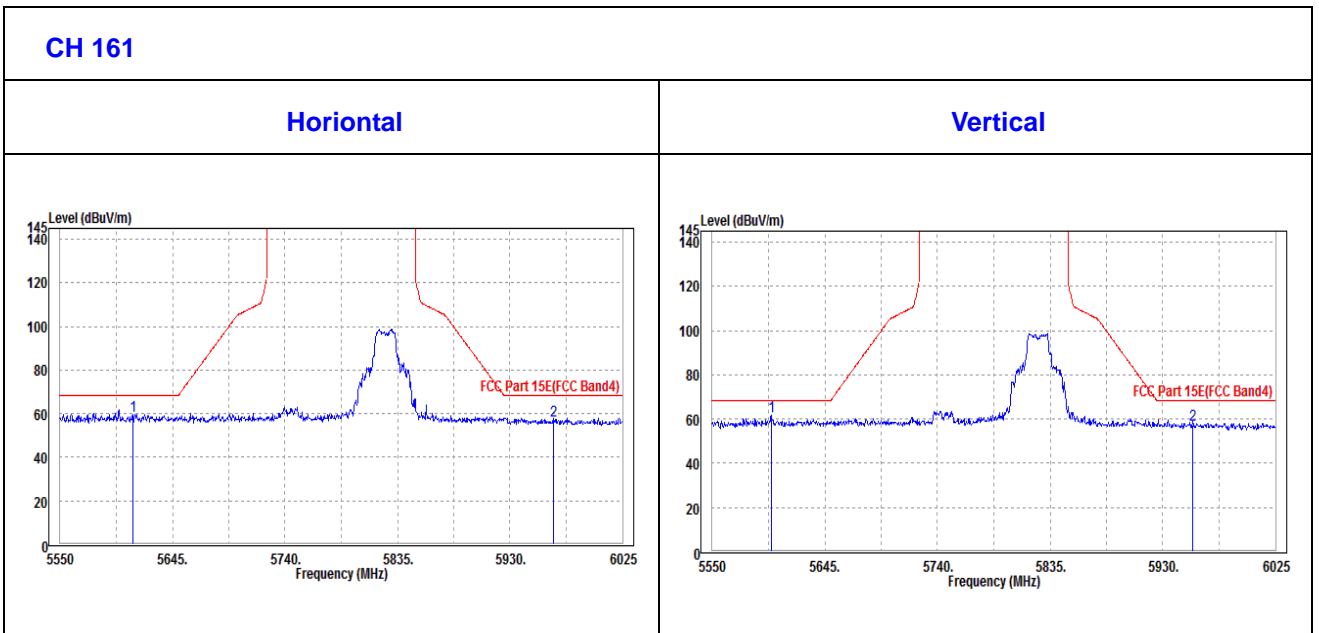



802.11n (20MHz) TEST DATA FROM ANT 0+ANT1:

CHANNEL	TX Channel 149	DETECTOR FUNCTION	Peak (PK)
FREQUENCY RANGE	1GHz ~ 40GHz		Average (AV)

ANTENNA POLARITY & TEST DISTANCE: HORIZONTAL AT 3 M										
FREQ. (MHz)	EMISSION LEVEL (dBuV/m)	READ LEVEL (dBuV)	LIMIT (dBuV/m)	MARGIN (dB)	ANTENNA FACTOR (dB /m)	CABLE LOSS (dB)	PREAMP FACTOR (dB)	ANTENNA HEIGHT (cm)	TABLE ANGLE (Degree)	REMARK
5745	104.2	106.23			36.4	7.75	46.18	100	164	Peak
5745	96.15	98.18			36.4	7.75	46.18	100	144	Average
ANTENNA POLARITY & TEST DISTANCE: VERTICAL AT 3 M										
FREQ. (MHz)	EMISSION LEVEL (dBuV/m)	READ LEVEL (dBuV)	LIMIT (dBuV/m)	MARGIN (dB)	ANTENNA FACTOR (dB /m)	CABLE LOSS (dB)	PREAMP FACTOR (dB)	ANTENNA HEIGHT (cm)	TABLE ANGLE (Degree)	REMARK
5745	107.38	109.16			36.65	7.75	46.18	131	59	Peak
5745	97.35	99.13			36.65	7.75	46.18	131	59	Average

REMARKS:

- Emission Level = Read Level+ Antenna Factor + Cable Loss- Preamp Factor
Margin value = Emission level – Limit value.
- 5745MHz: Fundamental frequency.



Oobe DATA

802.11n (20MHz) TEST DATA FROM ANT 0+ANT1:

ANTENNA POLARITY & TEST DISTANCE: HORIZONTAL AT 3 M										
FREQ. (MHz)	EMISSION LEVEL (dBuV/m)	READ LEVEL (dBuV)	LIMIT (dBuV/m)	MARGIN (dB)	ANTENNA FACTOR (dB /m)	CABLE LOSS (dB)	PREAMP FACTOR (dB)	ANTENNA HEIGHT (cm)	TABLE ANGLE (Degree)	REMARK
5619.825	57.6	59.85	68.3	-10.7	36.35	7.62	46.22	100	0	Peak
5970.85	57.41	59.06	68.3	-10.89	36.49	7.98	46.12	100	0	Peak
ANTENNA POLARITY & TEST DISTANCE: VERTICAL AT 3 M										
FREQ. (MHz)	EMISSION LEVEL (dBuV/m)	READ LEVEL (dBuV)	LIMIT (dBuV/m)	MARGIN (dB)	ANTENNA FACTOR (dB /m)	CABLE LOSS (dB)	PREAMP FACTOR (dB)	ANTENNA HEIGHT (cm)	TABLE ANGLE (Degree)	REMARK
5607.95	57.83	59.88	68.3	-10.47	36.56	7.61	46.22	200	121	Peak
5980.825	55.82	57.16	68.3	-12.48	36.79	7.99	46.12	200	121	Peak

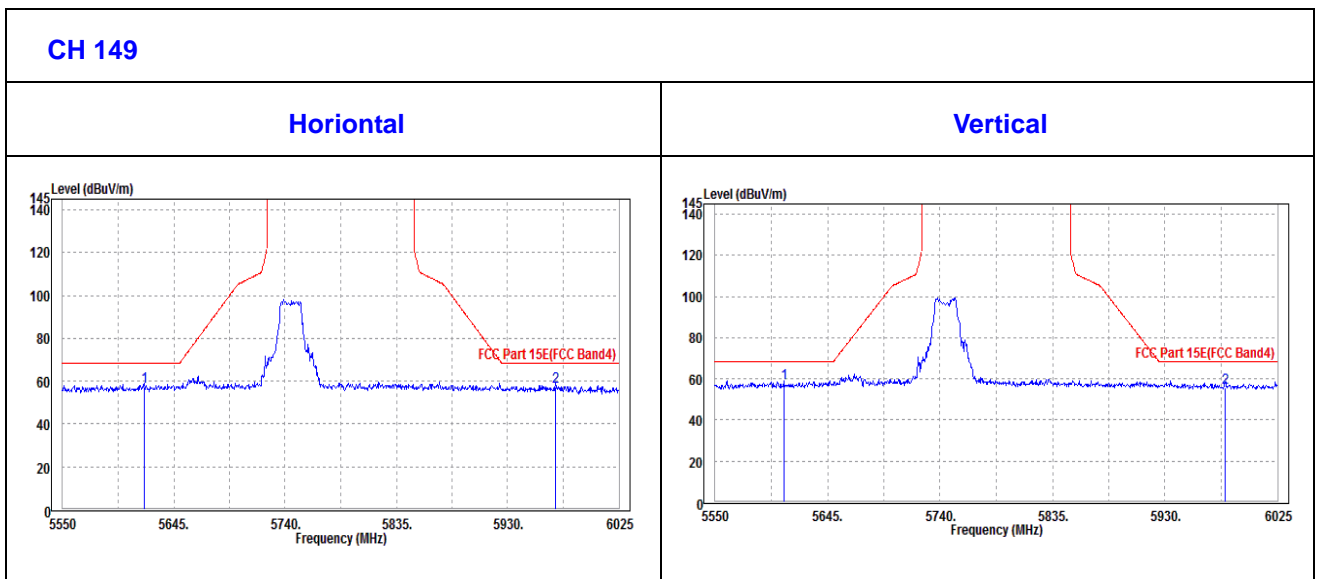



CHANNEL	TX Channel 157	DETECTOR FUNCTION	Peak (PK)
FREQUENCY RANGE	1GHz ~ 40GHz		Average (AV)

ANTENNA POLARITY & TEST DISTANCE: HORIZONTAL AT 3 M

FREQ. (MHz)	EMISSION LEVEL (dBuV/m)	READ LEVEL (dBuV)	LIMIT (dBuV/m)	MARGIN (dB)	ANTENNA FACTOR (dB /m)	CABLE LOSS (dB)	PREAMP FACTOR (dB)	ANTENNA HEIGHT (cm)	TABLE ANGLE (Degree)	REMARK
5785	106.27	108.24			36.41	7.79	46.17	148	145	Peak
5785	96.14	98.11			36.41	7.79	46.17	148	145	Average

ANTENNA POLARITY & TEST DISTANCE: VERTICAL AT 3 M

FREQ. (MHz)	EMISSION LEVEL (dBuV/m)	READ LEVEL (dBuV)	LIMIT (dBuV/m)	MARGIN (dB)	ANTENNA FACTOR (dB /m)	CABLE LOSS (dB)	PREAMP FACTOR (dB)	ANTENNA HEIGHT (cm)	TABLE ANGLE (Degree)	REMARK
5785	106.63	108.34			36.67	7.79	46.17	100	120	Peak
5785	96.45	98.16			36.67	7.79	46.17	100	120	Average

REMARKS:

- Emission Level = Read Level+ Antenna Factor + Cable Loss- Preamp Factor
Margin value = Emission level – Limit value.
- 5785MHz: Fundamental frequency.



Oobe Data

802.11n (20MHz) TEST DATA FROM ANT 0+ANT1:

ANTENNA POLARITY & TEST DISTANCE: HORIZONTAL AT 3 M										
FREQ. (MHz)	EMISSION LEVEL (dBuV/m)	READ LEVEL (dBuV)	LIMIT (dBuV/m)	MARGIN (dB)	ANTENNA FACTOR (dB /m)	CABLE LOSS (dB)	PREAMP FACTOR (dB)	ANTENNA HEIGHT (cm)	TABLE ANGLE (Degree)	REMARK
5599.87 5	58.87	61.15	68.3	-9.43	36.34	7.6	46.22	200	0	Peak
5949.95	56.57	58.25	68.3	-11.73	36.48	7.96	46.12	200	0	Peak
ANTENNA POLARITY & TEST DISTANCE: VERTICAL AT 3 M										
FREQ. (MHz)	EMISSION LEVEL (dBuV/m)	READ LEVEL (dBuV)	LIMIT (dBuV/m)	MARGIN (dB)	ANTENNA FACTOR (dB /m)	CABLE LOSS (dB)	PREAMP FACTOR (dB)	ANTENNA HEIGHT (cm)	TABLE ANGLE (Degree)	REMARK
5598.92 5	57.48	59.54	68.3	-10.82	36.56	7.6	46.22	100	0	Peak
5958.5	57.88	59.25	68.3	-10.42	36.78	7.97	46.12	100	0	Peak

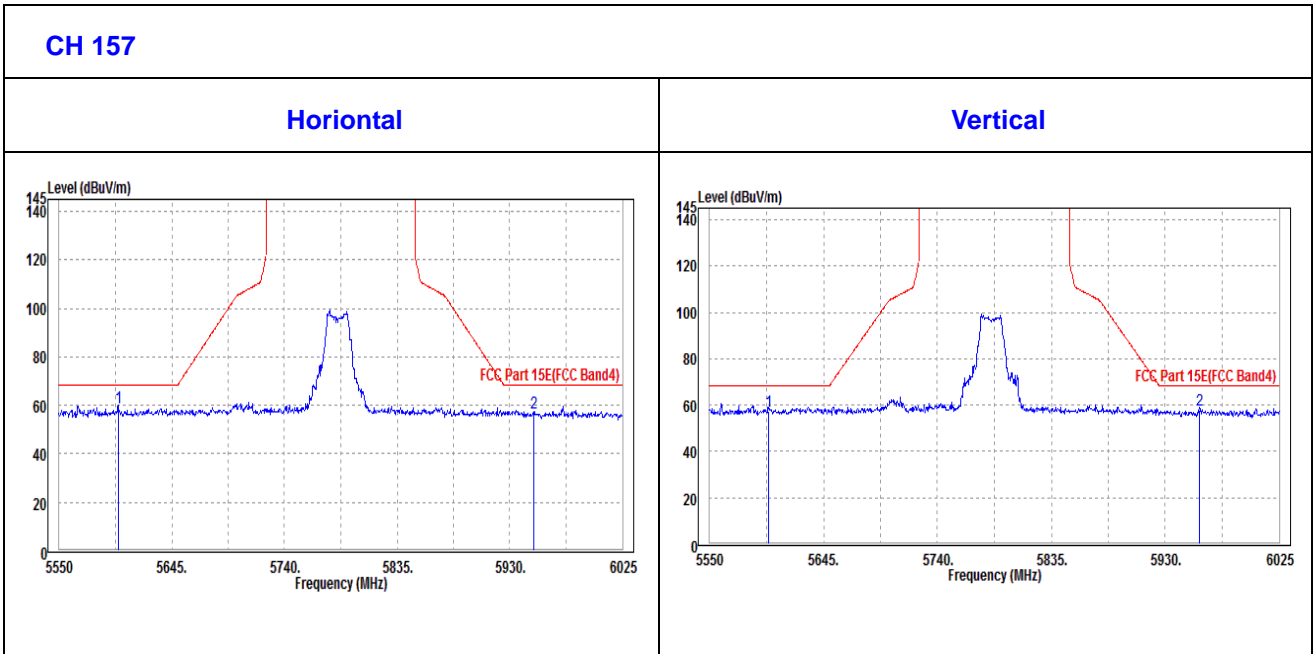



CHANNEL	TX Channel 161	DETECTOR FUNCTION	Peak (PK)
FREQUENCY RANGE	1GHz ~ 40GHz		Average (AV)

ANTENNA POLARITY & TEST DISTANCE: HORIZONTAL AT 3 M										
FREQ. (MHz)	EMISSION LEVEL (dBuV/m)	READ LEVEL (dBuV)	LIMIT (dBuV/m)	MARGIN (dB)	ANTENNA FACTOR (dB /m)	CABLE LOSS (dB)	PREAMP FACTOR (dB)	ANTENNA HEIGHT (cm)	TABLE ANGLE (Degree)	REMARK
5825	105.78	107.68			36.43	7.83	46.16	119	87	Peak
5825	97.02	98.92			36.43	7.83	46.16	119	87	Average
ANTENNA POLARITY & TEST DISTANCE: VERTICAL AT 3 M										
FREQ. (MHz)	EMISSION LEVEL (dBuV/m)	READ LEVEL (dBuV)	LIMIT (dBuV/m)	MARGIN (dB)	ANTENNA FACTOR (dB /m)	CABLE LOSS (dB)	PREAMP FACTOR (dB)	ANTENNA HEIGHT (cm)	TABLE ANGLE (Degree)	REMARK
5825	106.91	108.55			36.69	7.83	46.16	100	200	Peak
5825	97.57	99.21			36.69	7.83	46.16	100	200	Average

REMARKS:

1. Emission Level = Read Level+ Antenna Factor + Cable Loss- Preamp Factor
Margin value = Emission level – Limit value.
2. 5805MHz: Fundamental frequency.



OBE DATA

802.11n (20MHZ) TEST DATA FROM ANT 0+ANT1:

ANTENNA POLARITY & TEST DISTANCE: HORIZONTAL AT 3 M										
FREQ. (MHz)	EMISSION LEVEL (dBuV/m)	READ LEVEL (dBuV)	LIMIT (dBuV/m)	MARGIN (dB)	ANTENNA FACTOR (dB /m)	CABLE LOSS (dB)	PREAMP FACTOR (dB)	ANTENNA HEIGHT (cm)	TABLE ANGLE (Degree)	REMARK
5599.875	57.95	60.23	68.3	-10.35	36.34	7.6	46.22	100	0	Peak
5971.8	57.97	59.62	68.3	-10.33	36.49	7.98	46.12	100	0	Peak
ANTENNA POLARITY & TEST DISTANCE: VERTICAL AT 3 M										
FREQ. (MHz)	EMISSION LEVEL (dBuV/m)	READ LEVEL (dBuV)	LIMIT (dBuV/m)	MARGIN (dB)	ANTENNA FACTOR (dB /m)	CABLE LOSS (dB)	PREAMP FACTOR (dB)	ANTENNA HEIGHT (cm)	TABLE ANGLE (Degree)	REMARK
5635.025	58.25	60.24	68.3	-10.05	36.58	7.64	46.21	200	0	Peak
5944.25	57.75	59.16	68.3	-10.55	36.77	7.95	46.13	200	0	Peak

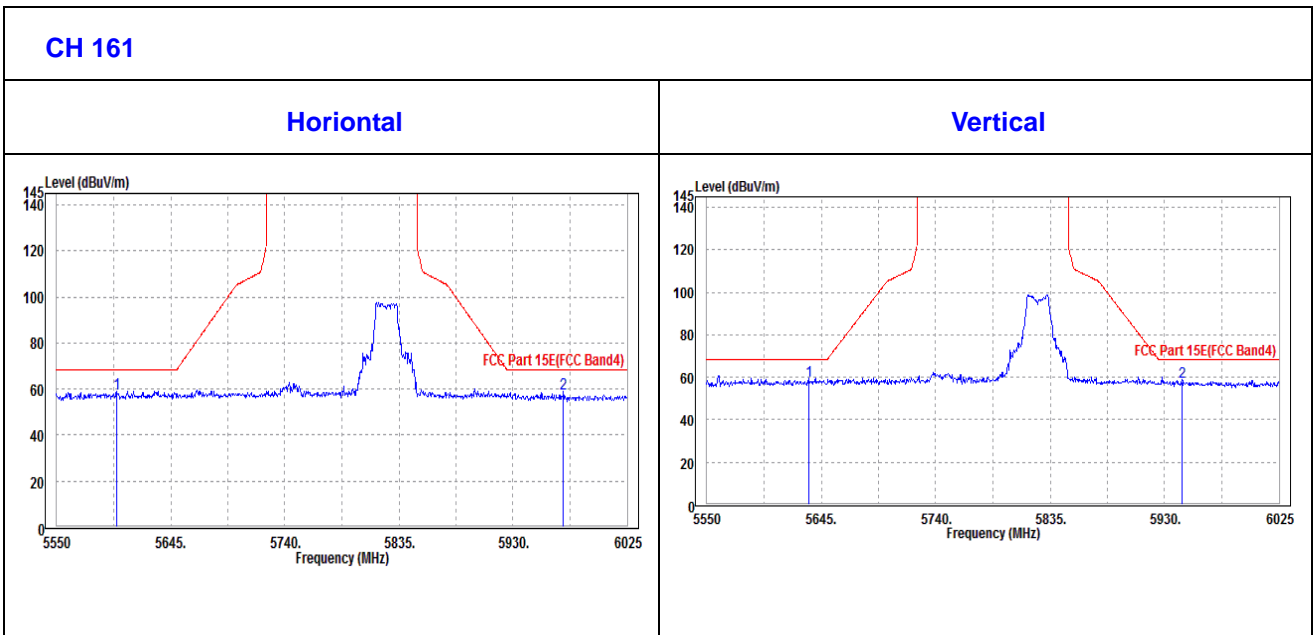



3.2 MAXIMUM CONDUCTED OUTPUT POWER MEASUREMENT

3.2.1 LIMITS OF MAXIMUM CONDUCTED OUTPUT POWER MEASUREMENT

Operation Band	EUT Category		LIMIT
U-NII-1		Outdoor Access Point	1 Watt (30 dBm) (Max. e.i.r.p \leq 125mW(21 dBm) at any elevation angle above 30 degrees as measured from the horizon)
		Fixed point-to-point Access Point	1 Watt (30 dBm)
		Indoor Access Point	1 Watt (30 dBm)
	√	Client devices	250mW (24 dBm)
U-NII-3	√		1 Watt (30 dBm)

NOTE: Where B is the 26dB emission bandwidth in MHz.



3.2.2 TEST SETUP

FOR POWER OUTPUT MEASUREMENT

802.11a, 802.11n (20MHz), TEST CONFIGURATION

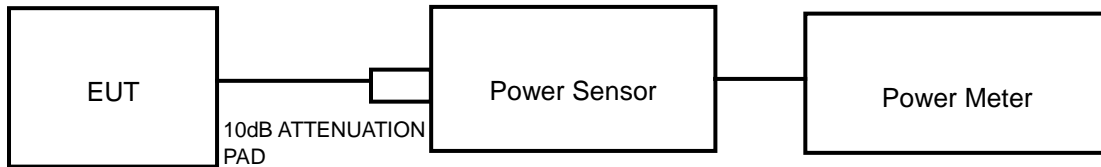

FOR 26dB BANDWIDTH

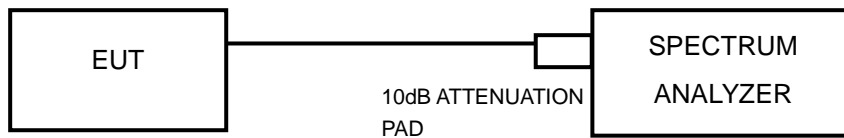

3.2.3 TEST INSTRUMENTS

Equipment	Manufacturer	Model No.	Serial No.	Last Cal.	Next Cal.
Power Meter	ANRITSU	ML2495A	1506002	Feb. 26,19	Feb. 25,20
EXA Signal Analyzer	KEYSIGHT	N9010A-526	MY54510322	Feb. 26,19	Feb. 25,20
EXA Signal Analyzer	KEYSIGHT	N9010A-544	MY54510355	Feb. 26,19	Feb. 25,20
Power Sensor	ANRITSU	MA2411B	1339352	Feb. 26,19	Feb. 25,20

NOTE:

1. The calibration interval of the above test instruments is 12 months and the calibrations are traceable to CEPREI/CHINA, GRGT/CHINA and NIM/CHINA.
2. The test was performed in RF Oven room.



3.2.4 TEST PROCEDURE

FOR POWER MEASUREMENT

For 802.11a, 802.11n (20MHz)

Method PM is used to perform output power measurement, trigger and gating function of wide band power meter is enabled to measure max output power of TX on burst. Duty factor is not added to measured value.



FOR 99 PERCENT OCCUPIED BANDWIDTH

The following procedure shall be used for measuring (99 %) power bandwidth:

1. Set center frequency to the nominal EUT channel center frequency.
2. Set span = 1.5 times to 5.0 times the OBW.
3. Set RBW = 1 % to 5 % of the OBW
4. Set VBW $\geq 3 \cdot$ RBW
5. Video averaging is not permitted. Where practical, a sample detection and single sweep mode shall be used. Otherwise, peak detection and max hold mode (until the trace stabilizes) shall be used.
6. Use the 99 % power bandwidth function of the instrument (if available).
7. If the instrument does not have a 99 % power bandwidth function, the trace data points are recovered and directly summed in power units. The recovered amplitude data points, beginning at the lowest frequency, are placed in a running sum until 0.5 % of the total is reached; that frequency is recorded as the lower frequency. The process is repeated until 99.5 % of the total is reached; that frequency is recorded as the upper frequency. The 99% occupied bandwidth is the difference between these two frequencies.

FOR 26dB BANDWIDTH

- 1) Set RBW = approximately 1% of the emission bandwidth.
- 2) Set the VBW > RBW.
- 3) Detector = Peak.
- 4) Trace mode = max hold.
- 5) Measure the maximum width of the emission that is 26 dB down from the peak of the emission. Compare this with the RBW setting of the analyzer. Readjust RBW and repeat measurement as needed until the RBW/EBW ratio is approximately 1%.

FOR 6dB BANDWIDTH

1. Set RBW = 100 kHz.
2. Set the video bandwidth (VBW) ≥ 3 RBW.
3. Detector = Peak.
4. Trace mode = max hold.
5. Sweep = auto couple.
6. Allow the trace to stabilize.
7. Measure the maximum width of the emission that is constrained by the frequencies associated with the two outermost amplitude points (upper and lower frequencies) that are attenuated by 6 dB relative to the maximum level measured in the fundamental emission.



3.2.5 DEVIATION FROM TEST STANDARD

No deviation.

3.2.6 EUT OPERATING CONDITIONS

The software provided by client to enable the EUT under transmission condition continuously at specific channel frequencies individually.



3.2.7 TEST RESULTS

OUTPUT POWER:

802.11a

CHANNEL	CHANNEL FREQUENCY (MHz)	AVERAGE POWER				POWER LIMIT (dBm)	PASS/FAIL
		ANT 0 (dBm)	ANT 1 (dBm)	Total (mW)	Total (dBm)		
36	5180	15.72	15.65	/	/	24	PASS
40	5200	17.21	16.70	/	/	24	PASS
48	5240	18.18	18.05	/	/	24	PASS
149	5745	18.01	18.21	/	/	30	PASS
157	5785	18.22	18.28	/	/	30	PASS
161	5805	18.06	18.18	/	/	30	PASS

802.11n (20MHz)

CHANNEL	CHANNEL FREQUENCY (MHz)	AVERAGE POWER				POWER LIMIT (dBm)	PASS/FAIL
		ANT 0 (dBm)	ANT 1 (dBm)	Total (mW)	Total (dBm)		
36	5180	15.57	14.53	64.44	18.09	24	PASS
40	5200	15.55	14.58	64.6	18.1	24	PASS
48	5240	15.61	14.55	64.9	18.12	24	PASS
149	5745	15.03	15.34	66.04	18.2	30	PASS
157	5785	15.31	14.93	65.08	18.13	30	PASS
161	5805	15.53	14.47	63.72	18.04	30	PASS



99% OCCUPIED BANDWIDTH & 26dB BANDWIDTH/6dB BANDWIDTH DATA FROM ANT 0:

802.11a

CHANNEL	CHANNEL FREQUENCY (MHz)	99% OCCUPIED BANDWIDTH	26dB BANDWIDTH (MHz)	PASS/FAIL
36	5180	16.86	27.29	PASS
40	5200	16.98	29.24	PASS
48	5240	17.22	32.49	PASS
CHANNEL	CHANNEL FREQUENCY	99% OCCUPIED BANDWIDTH	6dB BANDWIDTH	PASS/FAIL
149	5745	16.80	16.27	PASS
157	5785	18.00	16.08	PASS
161	5805	18.00	16.93	PASS



802.11n (20MHz)

CHANNEL	CHANNEL FREQUENCY (MHz)	99% OCCUPIED BANDWIDTH	26dB BANDWIDTH (MHz)	PASS/FAIL
36	5180	16.92	27.83	PASS
40	5200	16.86	30.00	PASS
48	5240	17.94	25.17	PASS
CHANNEL	CHANNEL FREQUENCY	99% OCCUPIED BANDWIDTH	6dB BANDWIDTH	PASS/FAIL
149	5745	18.12	17.13	PASS
157	5785	18.12	17.16	PASS
161	5805	17.76	17.68	PASS



**BUREAU
VERITAS**

Test Report No.: RF190702W005

For U-NII-1:

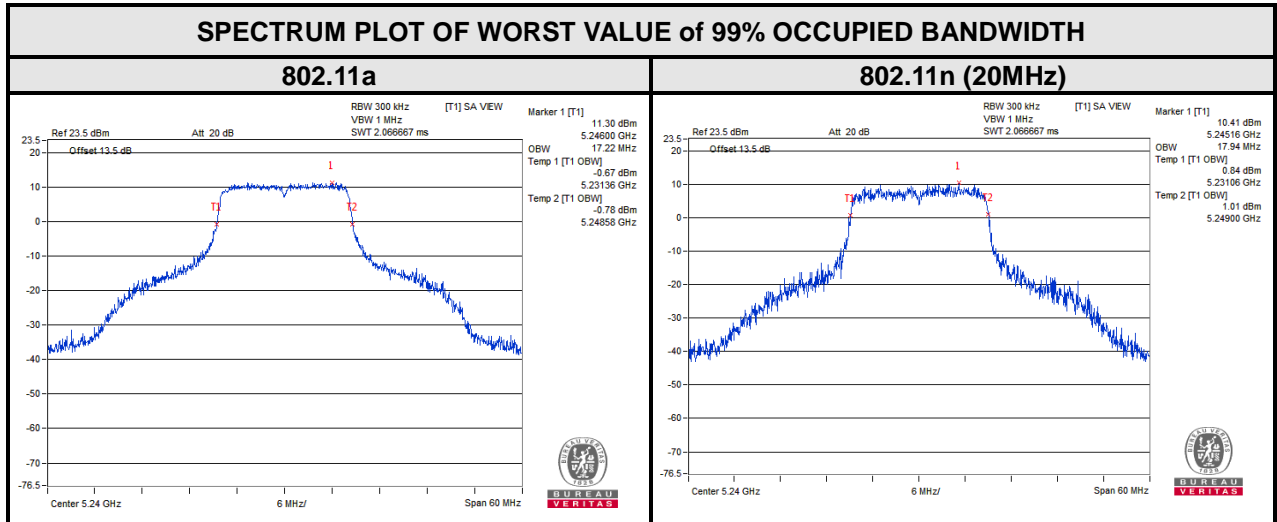



BUREAU
VERITAS

Test Report No.: RF190702W005

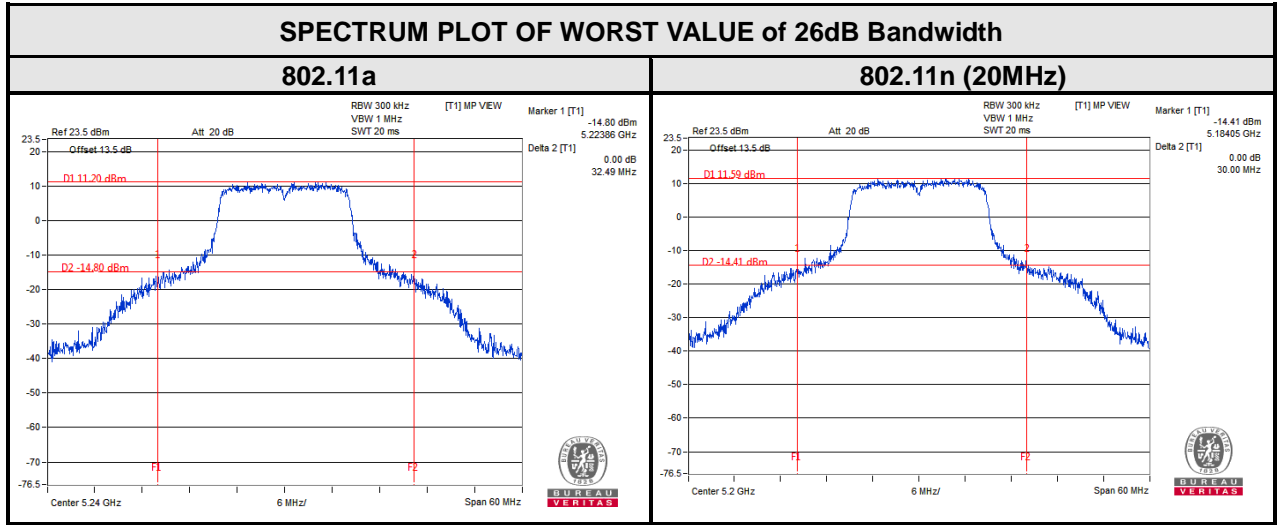



**BUREAU
VERITAS**

Test Report No.: RF190702W005

For U-NII-3:

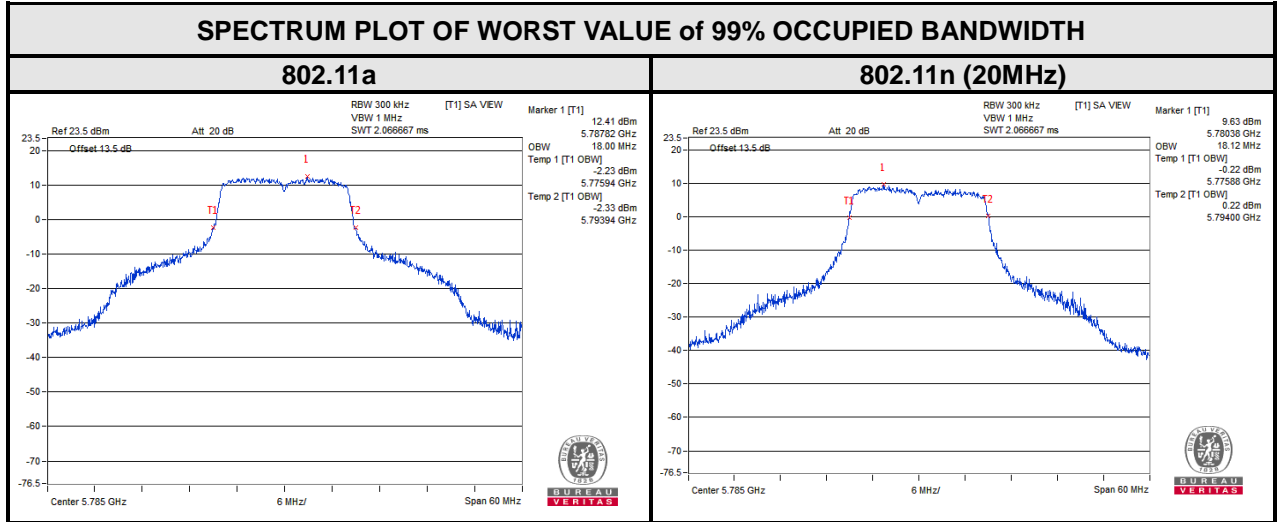



BUREAU VERITAS

Test Report No.: RF190702W005

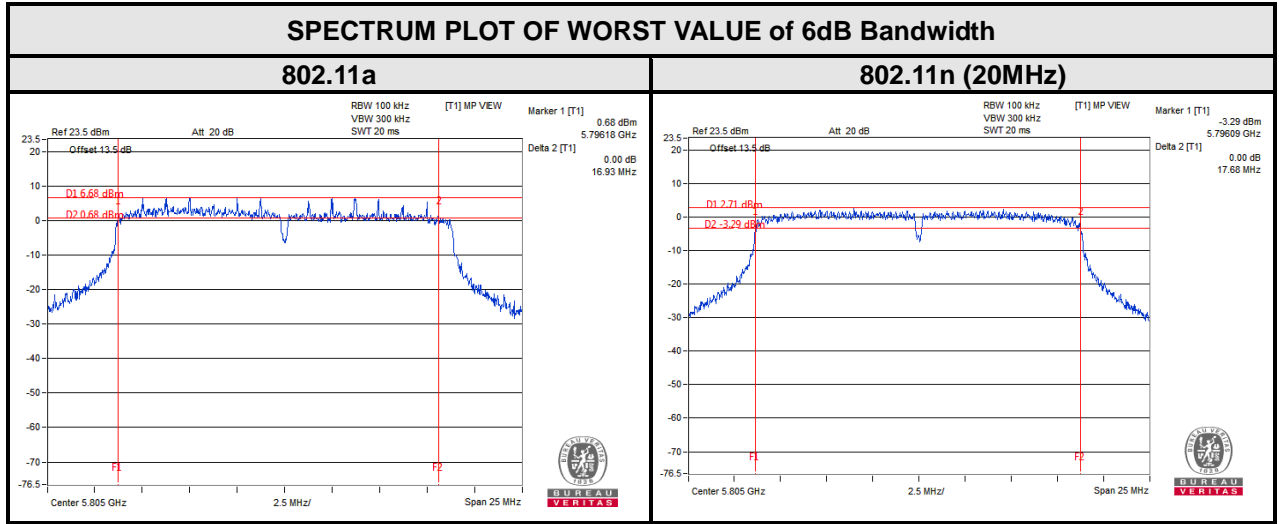



3.3 MAXIMUM POWER SPECTRAL DENSITY MEASUREMENT

3.3.1 LIMITS OF MAXIMUM POWER SPECTRAL DENSITY MEASUREMENT

Operation Band	EUT Category		LIMIT
U-NII-1		Outdoor Access Point	17dBm/ MHz
		Fixed point-to-point Access Point	
		Indoor Access Point	
	√	Client devices	11dBm/ MHz
U-NII-2A		√	11dBm/ MHz
U-NII-2C		√	11dBm/ MHz
U-NII-3		√	30dBm/ 500kHz

3.3.2 TEST SETUP

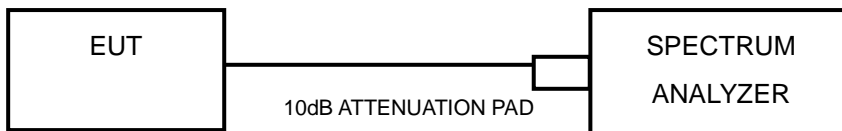

3.3.3 TEST INSTRUMENTS

Refer to section 3.3.3 to get information of above instrument.



3.3.4 TEST PROCEDURES

Using method SA-2

- 1) Set span to encompass the entire emission bandwidth (EBW) of the signal.
- 2) Set RBW = 1 MHz, Set VBW \geq 3 MHz, Detector = RMS
- 3) Set Channel power measure = 1MHz
- 4) Sweep time = auto, trigger set to "free run".
- 5) Trace average at least 100 traces in power averaging mode.
- 6) Add $10 \log(1/x)$, where x is the duty cycle, to the measured power in order to compute the average power during the actual transmission times (because the measurement represents an average over both the on and off times of the transmission).
- 7) Record the max value

3.3.5 DEVIATION FROM TEST STANDARD

No deviation.

3.3.6 EUT OPERATING CONDITIONS

Same as 3.1.6.



3.3.7 TEST RESULTS

For U-NII-1

802.11a

CHANNEL	FREQUENCY (MHz)	ANT 0 PSD w/o Duty Factor (dBm/MHz)	ANT 1 PSD w/o Duty Factor (dBm/MHz)	Duty Factor	ANT 0 PSD with Duty Factor (dBm/MHz)	ANT 1 PSD with Duty Factor (dBm/MHz)	MAXIMUM LIMIT (dBm/MHz)	PASS/ FAIL
36	5180	9.75	8.89	0.138	9.89	9.03	11	PASS
40	5200	9.85	8.55	0.138	9.99	8.69	11	PASS
48	5240	9.61	8.92	0.138	9.75	9.06	11	PASS

802.11n (20MHz)

CHANNEL	FREQUENCY (MHz)	ANT 0 PSD w/o Duty Factor (dBm/MHz)	ANT 1 PSD w/o Duty Factor (dBm/MHz)	Duty Factor	Total PSD with Duty Factor (dBm/MHz)	MAXIMUM LIMIT (dBm/MHz)	PASS/FAIL
36	5180	7.93	4.24	0.121	9.6	11	PASS
40	5200	8.43	4.35	0.121	9.98	11	PASS
48	5240	8.46	4.14	0.121	9.95	11	PASS

Note: $N_{ANT} = 2$, $N_{SS} = 1$, Directional gain = $G_{ANT} + 10 \log(N_{ANT} / N_{SS})$ dBi = 4.08dBi < 6dBi, density limit shall not be reduced.



For U-NII-3:

802.11a

CHANNEL	FREQUENCY (MHz)	ANT 0 PSD w/o Duty Factor (dBm/MHz)	ANT 1 PSD w/o Duty Factor (dBm/MHz)	Duty Factor	ANT 0 PSD with Duty Factor (dBm/500kHz)	ANT 1 PSD with Duty Factor (dBm/500kHz)	LIMIT (dBm/500kHz)	PASS /FAIL
149	5745	7.42	9.53	0.138	4.55	6.66	30	PASS
157	5785	9.55	9.32	0.138	6.68	6.45	30	PASS
161	5805	7.24	4.82	0.138	4.37	1.95	30	PASS

802.11n (20MHz)

CHANNEL	FREQUENCY (MHz)	ANT 0 PSD w/o Duty Factor (dBm/MHz)	ANT 1 PSD w/o Duty Factor (dBm/MHz)	Total PSD w/o Duty Factor (dBm/500kHz)	Duty Factor	Total PSD with Duty Factor (dBm/500kHz)	LIMIT (dBm/500kHz)	PASS /FAIL
149	5745	6.89	6.35	6.63	0.121	6.75	30	PASS
157	5785	6.98	5.68	6.38	0.121	6.50	30	PASS
161	5805	4.22	5.29	4.79	0.121	4.91	30	PASS

Note: N_{ANT} = 2, N_{SS}=1, Directional gain = G_{ANT} + 10 log(N_{ANT}/ N_{SS}) dBi = 4.08dBi < 6dBi, density limit shall not be reduced.



BUREAU VERITAS

Test Report No.: RF190702W005

For 5180~5240MHz

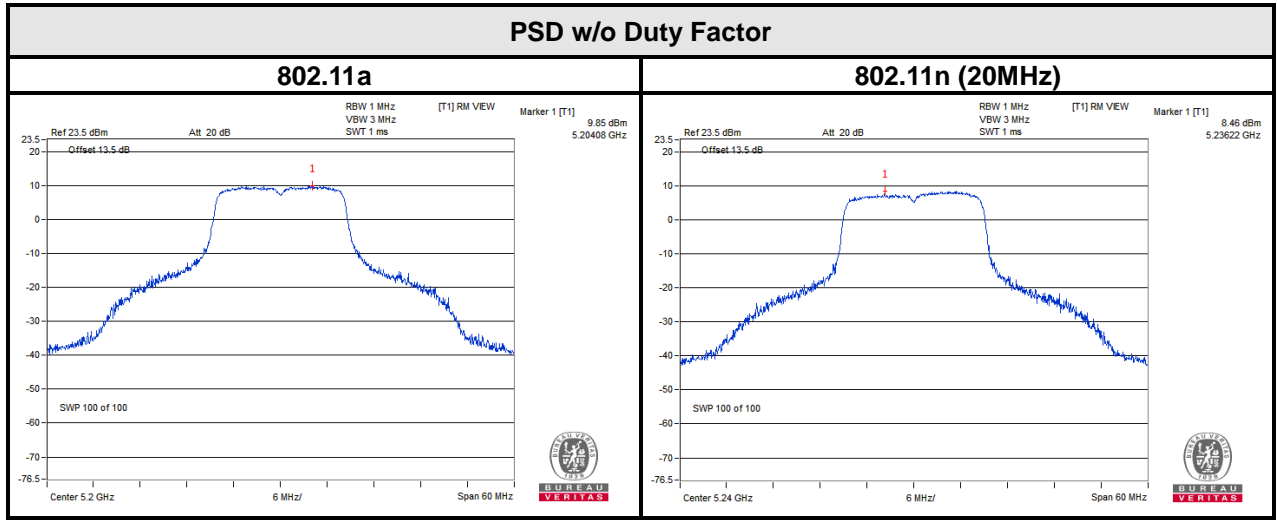



**BUREAU
VERITAS**

Test Report No.: RF190702W005

For 5745~5805MHz

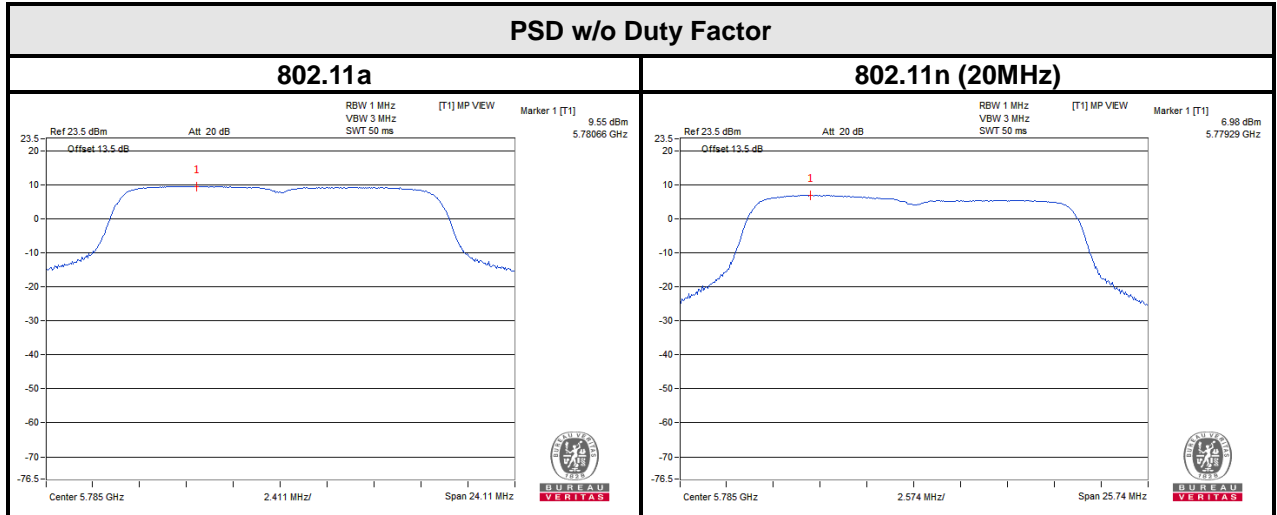



3.4 FREQUENCY STABILITY

3.4.1 LIMITS OF FREQUENCY STABILITY MEASUREMENT

The frequency of the carrier signal shall be maintained within band of operation

3.4.2 TEST SETUP

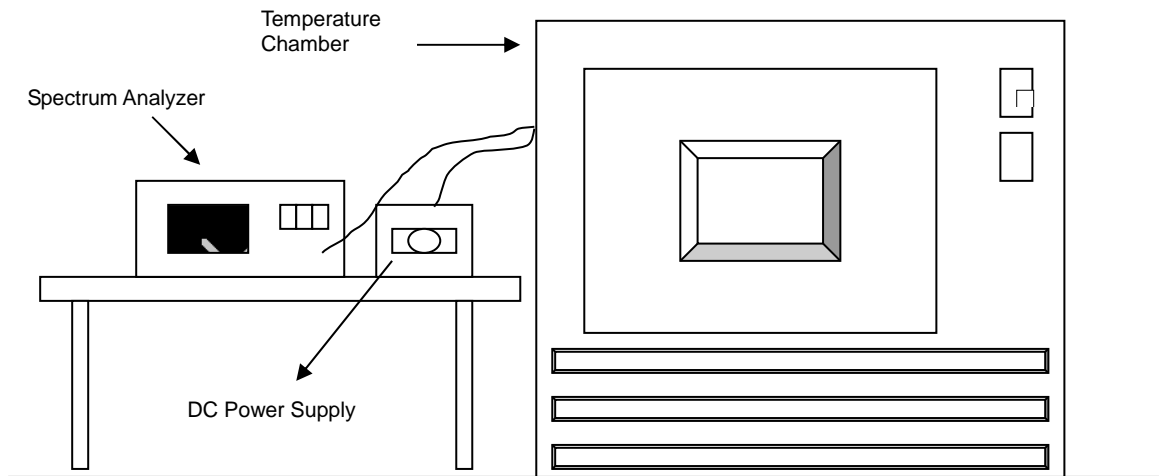

3.4.3 TEST INSTRUMENTS

Refer to section 3.3.3 to get information of above instrument.



3.4.4 TEST PROCEDURE

- a. The EUT was placed inside the environmental test chamber and powered by nominal DC voltage.
- b. Turn the EUT on and couple its output to a spectrum analyzer.
- c. Turn the EUT off and set the chamber to the highest temperature specified.
- d. Allow sufficient time (approximately 30 min) for the temperature of the chamber to stabilize, turn the EUT on and measure the operating frequency after 2, 5, and 10 minutes.
- e. Repeat step 2 and 3 with the temperature chamber set to the lowest temperature.
- f. The test chamber was allowed to stabilize at +20 degree C for a minimum of 30 minutes. The supply voltage was then adjusted on the EUT from 85% to 115% and the frequency record.

3.4.5 DEVIATION FROM TEST STANDARD

No deviation.

3.4.6 EUT OPERATING CONDITION

Set the EUT transmit at un-modulation mode to test frequency stability.



3.4.7 TEST RESULTS

TEST DATA FROM ANT 0:

FREQUENCY STABILITY VERSUS TEMP.										
OPERATING FREQUENCY: 5180MHz										
TEMP. (°C)	Power Supply (Vdc)	0 MINUTE		2 MINUTES		5 MINUTES		10 MINUTE		RESULT
		Measured Frequency (MHz)	Frequency Drift (ppm)	Measured Frequency (MHz)	Frequency Drift (ppm)	Measured Frequency (MHz)	Frequency Drift (ppm)	Measured Frequency (MHz)	Frequency Drift (ppm)	
50	120	5179.977	-4.382	5179.979	-3.919	5179.979	-4.035	5179.982	-3.398	PASS
40	120	5179.984	-3.069	5179.980	-3.822	5179.979	-4.035	5179.978	-4.208	PASS
30	120	5180.012	2.452	5180.011	2.201	5180.013	2.548	5180.015	2.973	PASS
20	120	5179.988	-2.259	5179.986	-2.568	5179.984	-3.089	5179.985	-2.838	PASS
10	120	5179.972	-5.386	5179.976	-4.614	5179.974	-4.903	5179.979	-3.958	PASS
0	120	5179.969	-5.830	5179.969	-5.927	5179.971	-5.502	5179.971	-5.425	PASS
-10	120	5180.000	0.019	5179.998	-0.367	5179.997	-0.483	5179.994	-1.120	PASS
-20	120	5180.000	0.097	5180.006	1.178	5180.001	0.347	5179.999	-0.019	PASS
-30	120	5179.984	-3.012	5179.982	-3.320	5179.978	-4.228	5179.987	-2.490	PASS

FREQUENCY STABILITY VERSUS VOLTAGE										
OPERATING FREQUENCY: 5180MHz										
TEMP. (°C)	Power Supply (Vdc)	0 MINUTE		2 MINUTE		5 MINUTE		10 MINUTE		RESULT
		Measured Frequency (MHz)	Frequency Drift (ppm)	Measured Frequency (MHz)	Frequency Drift (ppm)	Measured Frequency (MHz)	Frequency Drift (ppm)	Measured Frequency (MHz)	Frequency Drift (ppm)	
20	138	5179.989	-2.124	5179.985	-2.780	5179.985	-2.896	5179.985	-2.819	PASS
	120	5179.988	-2.259	5179.986	-2.568	5179.984	-3.089	5179.985	-2.838	PASS
	102	5179.988	-2.162	5179.985	-2.799	5179.985	-2.819	5179.985	-2.799	PASS



FREQUENCY STABILITY VERSUS TEMP.										
OPERATING FREQUENCY: 5805MHz										
TEMP. (°C)	Power Supply (Vdc)	0 MINUTE		2 MINUTES		5 MINUTES		10 MINUTE		RESULT
		Measured Frequency (MHz)	Frequency Drift (ppm)	Measured Frequency (MHz)	Frequency Drift (ppm)	Measured Frequency (MHz)	Frequency Drift (ppm)	Measured Frequency (MHz)	Frequency Drift (ppm)	
50	120	5805.008	1.413	5805.005	0.999	5805.003	0.551	5805.004	0.844	PASS
40	120	5804.987	-2.222	5804.983	-2.825	5804.979	-3.583	5804.976	-4.083	PASS
30	120	5805.015	2.722	5805.014	2.481	5805.02	3.445	5805.019	3.307	PASS
20	120	5805.006	1.189	5805.009	1.585	5805.005	0.999	5804.998	-0.345	PASS
10	120	5805.001	0.207	5805.001	0.310	5805.007	1.344	5805.006	1.068	PASS
0	120	5805.003	0.637	5805.001	0.241	5805.003	0.603	5804.997	-0.362	PASS
-10	120	5805.021	3.669	5805.015	2.739	5805.019	3.325	5805.021	3.652	PASS
-20	120	5804.981	-3.152	5804.982	-3.101	5804.988	-2.033	5804.981	-3.118	PASS
-30	120	5804.995	-0.758	5805.004	0.724	5805.001	0.207	5804.995	-0.706	PASS

FREQUENCY STABILITY VERSUS VOLTAGE										
OPERATING FREQUENCY: 5805MHz										
TEMP. (°C)	Power Supply (Vdc)	0 MINUTE		2 MINUTE		5 MINUTE		10 MINUTE		RESULT
		Measured Frequency (MHz)	Frequency Drift (ppm)	Measured Frequency (MHz)	Frequency Drift (ppm)	Measured Frequency (MHz)	Frequency Drift (ppm)	Measured Frequency (MHz)	Frequency Drift (ppm)	
20	138	5805.006	1.171	5805.008	1.516	5805.004	0.827	5804.999	-0.172	PASS
	120	5805.006	1.189	5805.009	1.585	5805.005	0.999	5804.998	-0.345	PASS
	102	5805.007	1.206	5805.008	1.430	5805.005	0.965	5804.998	-0.241	PASS



BUREAU Test Report No.: RF190702W005
VERITAS

4 PHOTOGRAPHS OF THE TEST CONFIGURATION

Please refer to the attached file (Test Setup Photo).



5 APPENDIX A – MODIFICATIONS RECORDERS FOR ENGINEERING CHANGES TO THE EUT BY THE LAB

No modifications were made to the EUT by the lab during the test.

---END---