

# FCC Radio Test Report

## FCC ID: 2AI49-FORCEPRO

**Report No.** : BTL-FCCP-2-2302G030A  
**Equipment** : ForcePro  
**Model Name** : ForcePro  
**Brand Name** : Wildix  
**Applicant** : Wildix EE OU  
**Address** : Narva mnt 7-339A Tallinn, Estonia 10117 WGM

**Radio Function** : Bluetooth Low Energy (5.0)

**FCC Rule Part(s)** : FCC CFR Title 47, Part 15, Subpart C (15.247)  
**Measurement Procedure(s)** : ANSI C63.10-2013

**Date of Receipt** : 2023/2/15  
**Date of Test** : 2023/3/28 ~ 2023/3/29  
**Issued Date** : 2023/11/28

The above equipment has been tested and found in compliance with the requirement of the above standards by BTL Inc.

**Prepared by** :   
Eddie Lee, Engineer

**Approved by** :   
Jerry Chuang, Supervisor

**BTL Inc.**

No.18, Ln. 171, Sec. 2, Jiuzong Rd., Neihu Dist., Taipei City 114, Taiwan

Tel: +886-2-2657-3299 Fax: +886-2-2657-3331 Web: www.newbtl.com Service mail: btl\_qa@newbtl.com

**Declaration**

**BTL** represents to the client that testing is done in accordance with standard procedures as applicable and that test instruments used has been calibrated with standards traceable to international standard(s) and/or national standard(s).

**BTL's** reports apply only to the specific samples tested under conditions. It is manufacture's responsibility to ensure that additional production units of this model are manufactured with the identical electrical and mechanical components. **BTL** shall have no liability for any declarations, inferences or generalizations drawn by the client or others from **BTL** issued reports.

This report is the confidential property of the client. As a mutual protection to the clients, the public and ourselves, the test report shall not be reproduced, except in full, without our written approval.

**BTL's** laboratory quality assurance procedures are in compliance with the **ISO/IEC 17025** requirements, and accredited by the conformity assessment authorities listed in this test report.

**BTL** is not responsible for the sampling stage, so the results only apply to the sample as received.

The information, data and test plan are provided by manufacturer which may affect the validity of results, so it is manufacturer's responsibility to ensure that the apparatus meets the essential requirements of applied standards and in all the possible configurations as representative of its intended use.

**Limitation**

For the use of the authority's logo is limited unless the Test Standard(s)/Scope(s)/Item(s) mentioned in this test report is (are) included in the conformity assessment authorities acceptance respective.

Please note that the measurement uncertainty is provided for informational purpose only and are not use in determining the Pass/Fail results.

**CONTENTS**

REVISION HISTORY	4
1 SUMMARY OF TEST RESULTS	5
1.1 TEST FACILITY	6
1.2 MEASUREMENT UNCERTAINTY	6
1.3 TEST ENVIRONMENT CONDITIONS	6
2 GENERAL INFORMATION	7
2.1 DESCRIPTION OF EUT	7
2.2 TEST MODES	9
2.3 BLOCK DIAGRAM SHOWING THE CONFIGURATION OF SYSTEM TESTED	10
2.4 SUPPORT UNITS	11
3 AC POWER LINE CONDUCTED EMISSIONS TEST	12
3.1 LIMIT	12
3.2 TEST PROCEDURE	12
3.3 DEVIATION FROM TEST STANDARD	12
3.4 TEST SETUP	13
3.5 TEST RESULT	13
4 RADIATED EMISSIONS TEST	14
4.1 LIMIT	14
4.2 TEST PROCEDURE	15
4.3 DEVIATION FROM TEST STANDARD	15
4.4 TEST SETUP	15
4.5 EUT OPERATING CONDITIONS	16
4.6 TEST RESULT – BELOW 30 MHZ	16
4.7 TEST RESULT – 30 MHZ TO 1 GHZ	16
5 LIST OF MEASURING EQUIPMENTS	17
6 EUT TEST PHOTO	18
7 EUT PHOTOS	18
APPENDIX A AC POWER LINE CONDUCTED EMISSIONS	19
APPENDIX B RADIATED EMISSIONS - 30 MHZ TO 1 GHZ	24

**REVISION HISTORY**

Report No.	Version	Description	Issued Date	Note
BTL-FCCP-2-2302G030A	R00	Original Report.	2023/11/28	Valid

## 1 SUMMARY OF TEST RESULTS

Test procedures according to the technical standards.

Standard(s) Section	Description	Test Result	Judgement	Remark
15.207	AC Power Line Conducted Emissions	APPENDIX A	Pass	-----
15.205 15.209 15.247(d)	Radiated Emissions	APPENDIX B	Pass	-----
15.247(a)(2)	Bandwidth	NOTE (3)	Pass	-----
15.247(b)(3)	Output Power	NOTE (3)	Pass	-----
15.247(e)	Power Spectral Density	NOTE (3)	Pass	-----
15.247(d)	Antenna conducted Spurious Emission	NOTE (3)	Pass	-----
15.203	Antenna Requirement	-----	Pass	-----

**NOTE:**

- (1) "N/A" denotes test is not applicable in this Test Report.
- (2) The report format version is TP.1.1.1.
- (1) The differences compared with test report BTL-FCCP-2-2204C250(FCC ID:2APPZ-V65):
  - 1) Added adapter\* 1: GQ12-050200-AU.
  - 2) Changed product name, brand, model name and applicant information.
 After evaluated, the changes with respect to the original one, only ac power line conducted emissions and radiated emissions below 1 GHz tests need to be verified.

The test records and results please refer to the test report number: BTL-FCCP-2-2204C250, issued date is Aug. 16, 2022, and issued by:

Test Laboratory: BTL Inc.

Address: No. 3 Jinshagang 1st Rd. Shixia, Dalang Town Dongguan City, Guangdong 523792 People's Republic of China.

Which was accredited by A2LA, accreditation number is 5123.02, with the scopes of cited standards in this test report.

This report is only valid conjunction with the above referenced test report.

### 1.1 TEST FACILITY

The test facilities used to collect the test data in this report:

No. 72, Ln. 169, Sec. 2, Datong Rd., Xizhi Dist., New Taipei City 221, Taiwan

The test sites and facilities are covered under FCC RN: 674415 and DN: TW0659.

C06       CB21       CB22

No. 68-1, Ln. 169, Sec. 2, Datong Rd., Xizhi Dist., New Taipei City 221, Taiwan

The test sites and facilities are covered under FCC RN: 674415 and DN: TW0659.

C05       CB08       CB11       CB15       CB16  
 SR05

### 1.2 MEASUREMENT UNCERTAINTY

The reported uncertainty of measurement  $y \pm U$ , where expanded uncertainty  $U$  is based on a standard uncertainty multiplied by a coverage factor of  $k = 2$ , providing a level of confidence of approximately **95 %**. The measurement instrumentation uncertainty considerations contained in CISPR 16-4-2. The BTL measurement uncertainty is less than the CISPR 16-4-2  $U_{cispr}$  requirement.

A. AC power line conducted emissions test:

Test Site	Method	Measurement Frequency Range	U (dB)
C05	CISPR	150 kHz ~ 30MHz	3.44

B. Radiated emissions test :

Test Site	Measurement Frequency Range	U,(dB)
CB21	0.03 GHz ~ 0.2 GHz	4.17
	0.2 GHz ~ 1 GHz	4.72

NOTE:

Unless specifically mentioned, the uncertainty of measurement has not been taken into account to declare the compliance or non-compliance to the specification.

### 1.3 TEST ENVIRONMENT CONDITIONS

Test Item	Environment Condition	Test Voltage	Tested by
AC Power Line Conducted Emissions	19 °C, 68 %	AC 120 V	Jay Tien
Radiated emissions below 1 GHz	21 °C, 61 %	AC 120 V	Mark Wang

## 2 GENERAL INFORMATION

### 2.1 DESCRIPTION OF EUT

Equipment	ForcePro
Model Name	ForcePro
Brand Name	Wildix
Model Difference	N/A
Power Source	1# DC voltage supplied from AC adapter. 2# Supplied from PoE.
Power Rating	1# I/P: 100-240V~50/60Hz 0.3A    O/P: 5.0V $\equiv$ 2.0A 2# PoE 48V
Products Covered	1* Adapter: GQ12-050200-AU
Operation Band	2400 MHz ~ 2483.5 MHz
Operation Frequency	2402 MHz ~ 2480 MHz
Modulation Technology	GFSK
Transfer Rate	1 Mbps, 2 Mbps
Output Power Max.	1 Mbps: 5.00 dBm (0.0032 W) 2 Mbps: 5.05 dBm (0.0032 W)
Test Model	ForcePro
Sample Status	Engineering Sample
EUT Modification(s)	N/A

**NOTE:**

- (1) The above EUT information is declared by manufacturer and for more detailed features description, please refers to the manufacturer's specifications or user's manual.

## (2) Channel List:

Channel	Frequency (MHz)	Channel	Frequency (MHz)
00	2402	20	2442
01	2404	21	2444
02	2406	22	2446
03	2408	23	2448
04	2410	24	2450
05	2412	25	2452
06	2414	26	2454
07	2416	27	2456
08	2418	28	2458
09	2420	29	2460
10	2422	30	2462
11	2424	31	2464
12	2426	32	2466
13	2428	33	2468
14	2430	34	2470
15	2432	35	2472
16	2434	36	2474
17	2436	37	2476
18	2438	38	2478
19	2440	39	2480

## (3) Table for Filed Antenna:

Ant.	Manufacturer	P/N	Type	Connector	Gain (dBi)
1	Dongguan YiJia Electronics Communication Technology Co.,Ltd.	YJL01.106.031.303A	FPC	N/A	5.2

(4) The above Antenna information are derived from the antenna data sheet provided by manufacturer and for more detailed features description, please refer to the manufacturer's specifications, the laboratory shall not be held responsible.



## 2.2 TEST MODES

Test Items	Test mode	Channel	Note
AC power line conducted emissions	Normal/Idle	-	-
Transmitter Radiated Emissions (below 1GHz)	2 Mbps	19	-

**NOTE:**

- (1) All X, Y and Z axes are evaluated, but only the worst case (X axis) is recorded.
- (2) For radiated spurious emissions below 1 GHz test, the 2Mbps Channel 19 is found to be the worst case and recorded.

**2.3 BLOCK DIAGRAM SHOWING THE CONFIGURATION OF SYSTEM TESTED**

Equipment letters and Cable numbers refer to item numbers described in the tables of clause 2.4.

AC power line conducted emissions

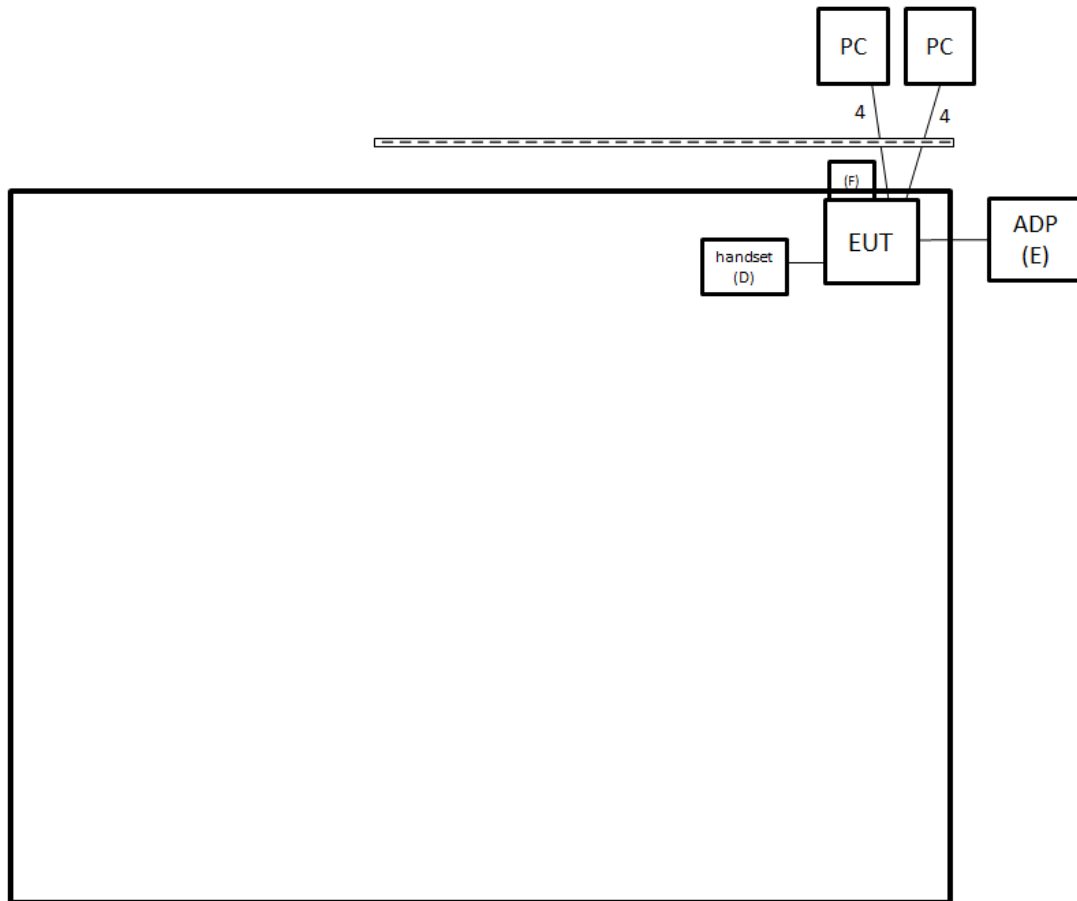

### Radiated Emissions

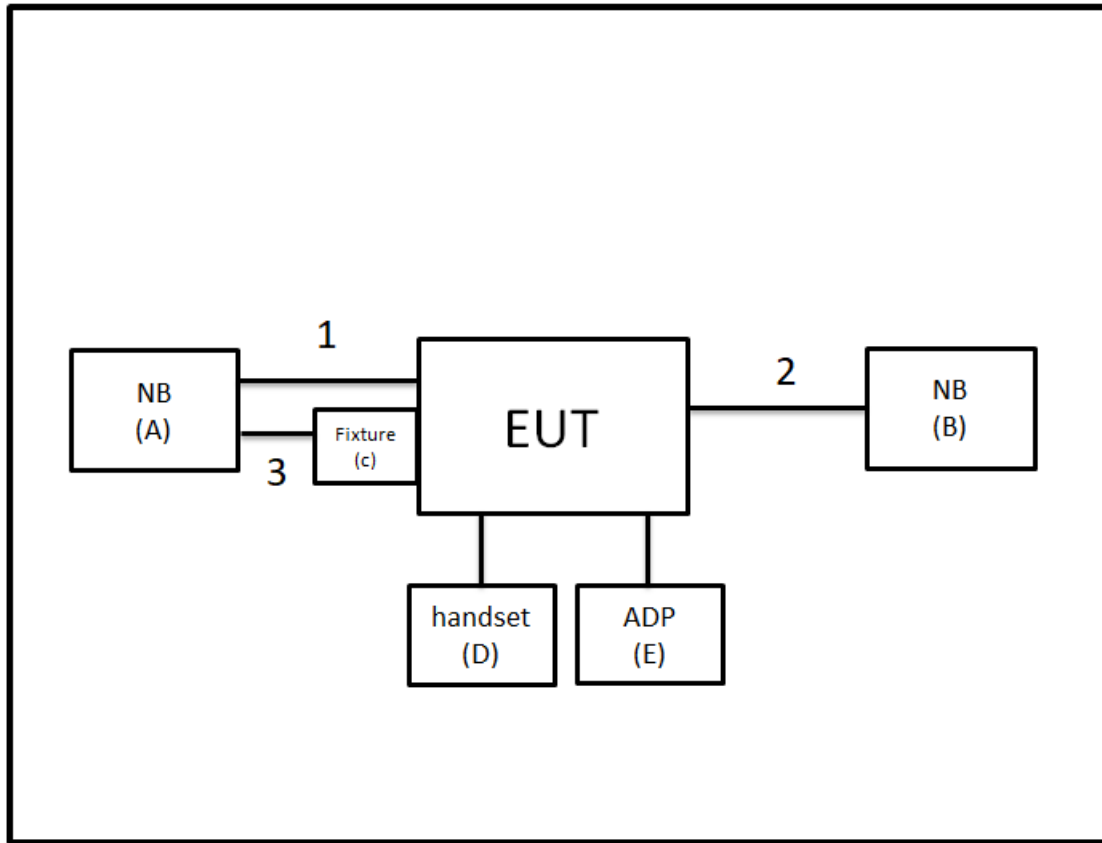

### 2.4 SUPPORT UNITS

Item	Equipment	Brand	Model No.	Series No.	Remarks
A	NB	HP	TPN-I119	N/A	Furnished by test lab.
B	NB	HP	TPN-I119	N/A	Furnished by test lab.
C	Fixture	N/A	N/A	N/A	Furnished by test lab.
D	handset	N/A	N/A	N/A	Furnished by test lab.
E	ADAPTER	Intertek	GQ12-050200-AU	N/A	Supplied by test requester.
F	USB Dongle	Kingston	DTX	N/A	Furnished by test lab.
G	PC	DELL	OptiPlex 790 MT	64NJVBX	Furnished by test lab.

Item	Shielded	Ferrite Core	Length	Cable Type	Remarks
1	N/A	N/A	1m	RJ45 Cable	Furnished by test lab.
2	N/A	N/A	1m	RJ45 Cable	Furnished by test lab.
3	N/A	N/A	1m	USB extension Cable	Furnished by test lab.
4	NO	NO	6m	RJ-45 Cable	Furnished by test lab.

### 3 AC POWER LINE CONDUCTED EMISSIONS TEST

#### 3.1 LIMIT

Frequency (MHz)	Limit (dB $\mu$ V)	
	Quasi-peak	Average
0.15 - 0.5	66 - 56 *	56 - 46 *
0.50 - 5.0	56	46
5.0 - 30.0	60	50

**NOTE:**

- (1) The tighter limit applies at the band edges.
- (2) The limit of " \* " marked band means the limitation decreases linearly with the logarithm of the frequency in the range.
- (3) The test result calculated as following:  
 Measurement Value = Reading Level + Correct Factor  
 Correct Factor = Insertion Loss + Cable Loss + Attenuator Factor (if use)  
 Margin Level = Measurement Value – Limit Value  
 Calculation example:

Reading Level		Correct Factor		Measurement Value
38.22	+	3.45	=	41.67

Measurement Value		Limit Value		Margin Level
41.67	-	60	=	-18.33

The following table is the setting of the receiver.

Receiver Parameter	Setting
Attenuation	10 dB
Start Frequency	0.15 MHz
Stop Frequency	30 MHz
IF Bandwidth	9 KHz

#### 3.2 TEST PROCEDURE

- a. The EUT was placed 0.8 m above the horizontal ground plane with the EUT being connected to the power mains through a line impedance stabilization network (LISN).  
 All other support equipment were powered from an additional LISN(s).  
 The LISN provides 50 Ohm/50uH of impedance for the measuring instrument.
- b. Interconnecting cables that hang closer than 40 cm to the ground plane shall be folded back and forth in the center forming a bundle to keep the cable above 40 cm.
- c. Excess I/O cables that are not connected to a peripheral shall be bundled in the center.  
 The end of the cable will be terminated, using the correct terminating impedance.  
 The overall length shall not exceed 1 m.
- d. The LISN is spaced at least 80 cm from the nearest part of the EUT chassis.
- e. For the actual test configuration, please refer to the related Item – EUT TEST PHOTO.

**NOTE:**

- (1) In the results, each reading is marked as Peak, QP or AVG per the detector used.  
 BW=9 kHz (6 dB Bandwidth)
- (2) All readings are Peak unless otherwise stated QP or AVG in column of Note. Both the QP and the AVG readings must be less than the limit for compliance.

#### 3.3 DEVIATION FROM TEST STANDARD

No deviation.

### 3.4 TEST SETUP

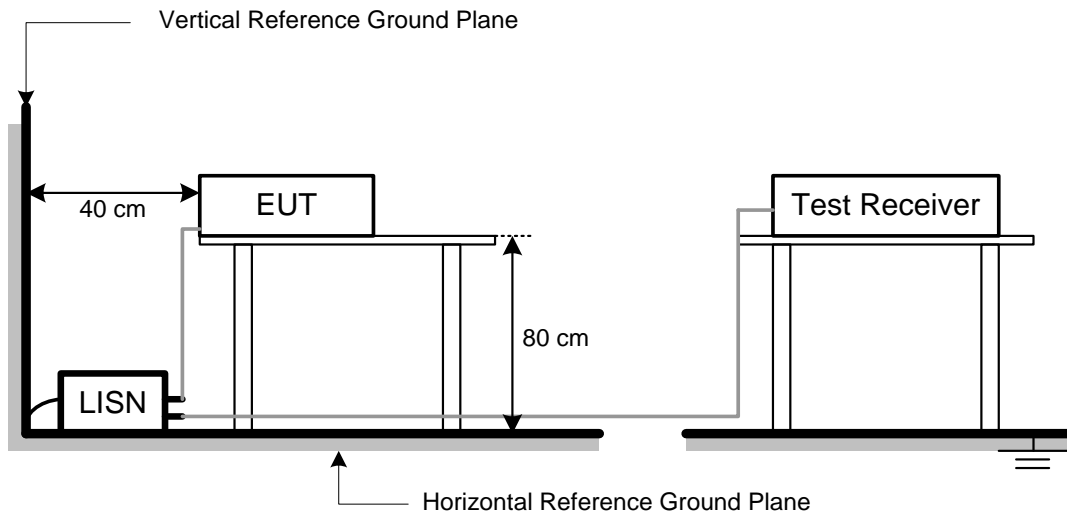

### 3.5 TEST RESULT

Please refer to the **APPENDIX A**.

## 4 RADIATED EMISSIONS TEST

### 4.1 LIMIT

In case the emission fall within the restricted band specified on 15.205, then the 15.209 limit in the table below has to be followed.

#### LIMITS OF RADIATED EMISSIONS MEASUREMENT (9 kHz to 1000 MHz)

Frequency (MHz)	Field Strength (microvolts/meter)	Measurement Distance (meters)
0.009~0.490	2400/F(KHz)	300
0.490~1.705	24000/F(KHz)	30
1.705~30.0	30	30
30~88	100	3
88~216	150	3
216~960	200	3
960~1000	500	3

#### NOTE:

- (1) The limit for radiated test was performed according to FCC CFR Title 47, Part 15, Subpart C.
- (2) The tighter limit applies at the band edges.
- (3) Emission level (dBuV/m)=20log Emission level (uV/m).
- (4) The test result calculated as following:

Measurement Value = Reading Level + Correct Factor

Correct Factor = Antenna Factor + Cable Loss - Amplifier Gain(if use)

Margin Level = Measurement Value - Limit Value

Calculation example:

Reading Level		Correct Factor		Measurement Value
41.91	+	-8.36	=	33.55

Measurement Value		Limit Value		Margin Level
33.55	-	43.50	=	-9.95

Spectrum Parameter	Setting
Attenuation	Auto
Start Frequency	1000 MHz
Stop Frequency	10th carrier harmonic
RBW / VBW (Emission in restricted band)	1MHz / 3MHz for Peak, 1MHz / 1/T for Average

Spectrum Parameter	Setting
Attenuation	Auto
Start ~ Stop Frequency	9KHz~90KHz for PK/AVG detector
Start ~ Stop Frequency	90KHz~110KHz for QP detector
Start ~ Stop Frequency	110KHz~490KHz for PK/AVG detector
Start ~ Stop Frequency	490KHz~30MHz for QP detector
Start ~ Stop Frequency	30MHz~1000MHz for QP detector

#### 4.2 TEST PROCEDURE

- The measuring distance of 3 m shall be used for measurements. The EUT was placed on the top of a rotating table 0.8 meter above the ground at a 3 meter semi-anechoic chamber. The table was rotated 360 degrees to determine the position of the highest radiation.(below 1GHz)
- The height of the equipment or of the substitution antenna shall be 0.8 m or 1.5 m, the height of the test antenna shall vary between 1 m to 4 m. Both horizontal and vertical polarizations of the antenna are set to make the measurement.
- For each suspected emission, the EUT was arranged to its worst case and then the antenna was tuned to heights find the maximum reading (used Bore sight function).
- The initial step in collecting radiated emission data is a receiver peak detector mode pre-scanning the measurement frequency range. Significant peaks are then marked and then Quasi Peak detector mode re-measured.
- All readings are Peak unless otherwise stated QP in column of Note. Peak denotes that the Peak reading compliance with the QP Limits and then QP Mode measurement didn't perform. (below 1GHz)
- For the actual test configuration, please refer to the related Item – EUT TEST PHOTO.

#### 4.3 DEVIATION FROM TEST STANDARD

No deviation.

#### 4.4 TEST SETUP

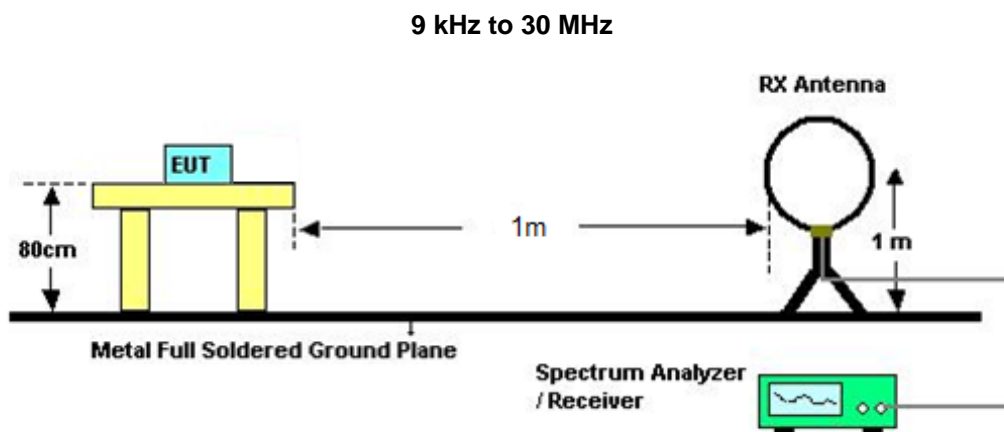

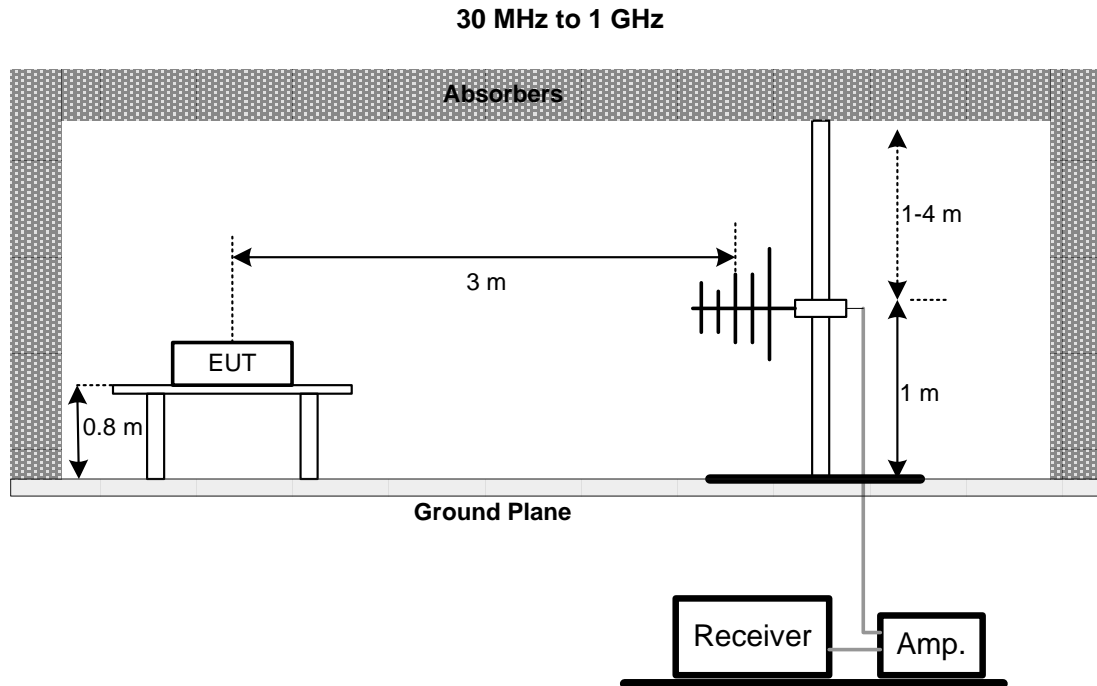

#### 4.5 EUT OPERATING CONDITIONS

The EUT was programmed to be in continuously transmitting mode.

#### 4.6 TEST RESULT – BELOW 30 MHZ

There were no emissions found below 30 MHz within 20 dB of the limit.

#### 4.7 TEST RESULT – 30 MHZ TO 1 GHZ

Please refer to the APPENDIX B.

#### NOTE:

- (1) No limit: This is fundamental signal, the judgment is not applicable.  
For fundamental signal judgment was referred to Peak output test.



## 5 LIST OF MEASURING EQUIPMENTS

AC Power Line Conducted Emissions						
Item	Kind of Equipment	Manufacturer	Type No.	Serial No.	Calibrated Date	Calibrated Until
1	TWO-LINE V-NETWORK	R&S	ENV216	101521	2022/9/28	2023/9/27
2	Test Cable	EMCI	EMCCFD300-BM-BMR-5000	220331	2022/3/31	2023/3/30
3	EMI Test Receiver	R&S	ESR 7	101433	2022/11/16	2023/11/15
4	Measurement Software	EZ	EZ EMC (Version NB-03A1-01)	N/A	N/A	N/A

Radiated Emissions						
Item	Kind of Equipment	Manufacturer	Type No.	Serial No.	Calibrated Date	Calibrated Until
1	Preamplifier	EMCI	EMC330N	980850	2022/9/19	2023/9/18
2	Test Cable	EMCI	EMC104-SM-SM-1000	220319	2023/3/14	2024/3/13
3	Test Cable	EMCI	EMC104-SM-SM-3000	220322	2023/3/14	2024/3/13
4	Test Cable	EMCI	EMC104-SM-SM-7000	220324	2023/3/14	2024/3/13
5	EXA Signal Analyzer	keysight	N9020B	MY57120120	2023/2/24	2024/2/23
6	Log-bicon Antenna	Schwarzbeck	VULB9168	1369	2022/5/20	2023/5/19
7	6dB Attenuator	EMCI	EMCI-N-6-06	AT-06001	2022/5/20	2023/5/19
8	Measurement Software	EZ	EZ EMC (Version NB-03A1-01)	N/A	N/A	N/A

Remark: "N/A" denotes no model name, no serial no. or no calibration specified.  
All calibration period of equipment list is one year.

**6 EUT TEST PHOTO**

Please refer to document Appendix No.: TP-2302G030-FCCP-1 (APPENDIX-TEST PHOTOS).

**7 EUT PHOTOS**

Please refer to document Appendix No.: EP-2302G030-1 (APPENDIX-EUT PHOTOS).

## **APPENDIX A AC POWER LINE CONDUCTED EMISSIONS**

Test Mode	Normal	Tested Date	2023/3/29
Test Frequency	-	Phase	Line

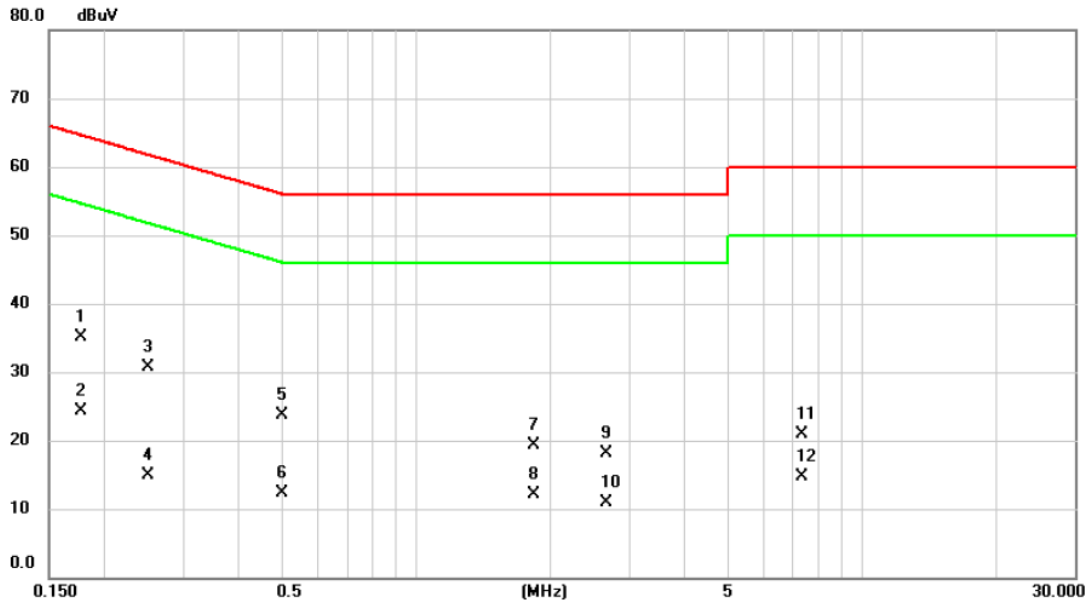

No.	Mk.	Freq.	Reading Level	Correct Factor	Measurement	Limit	Margin	Detector	Comment
		MHz	dBuV	dB	dBuV	dBuV	dB		
1	*	0.1770	25.41	9.63	35.04	64.63	-29.59	QP	
2		0.1770	14.68	9.63	24.31	54.63	-30.32	AVG	
3		0.2512	21.07	9.63	30.70	61.72	-31.02	QP	
4		0.2512	5.23	9.63	14.86	51.72	-36.86	AVG	
5		0.4987	14.02	9.63	23.65	56.02	-32.37	QP	
6		0.4987	2.76	9.63	12.39	46.02	-33.63	AVG	
7		1.8307	9.52	9.70	19.22	56.00	-36.78	QP	
8		1.8307	2.41	9.70	12.11	46.00	-33.89	AVG	
9		2.6767	8.48	9.72	18.20	56.00	-37.80	QP	
10		2.6767	1.22	9.72	10.94	46.00	-35.06	AVG	
11		7.3207	10.99	9.82	20.81	60.00	-39.19	QP	
12		7.3207	4.91	9.82	14.73	50.00	-35.27	AVG	

REMARKS:

- (1) Measurement Value = Reading Level + Correct Factor.
- (2) Margin Level = Measurement Value - Limit Value.

Test Mode	Normal	Tested Date	2023/3/29
Test Frequency	-	Phase	Neutral

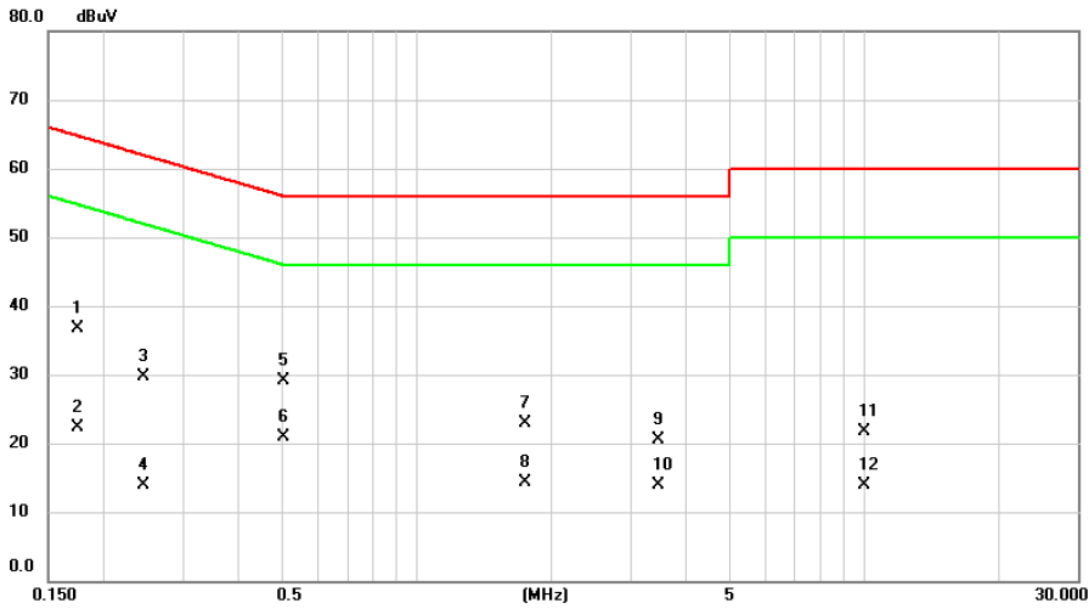

No. Mk.	Freq. MHz	Reading Level dBuV	Correct Factor dB	Measurement dBuV	Limit dBuV	Margin dB	Detector	Comment
1	0.1748	27.10	9.65	36.75	64.73	-27.98	QP	
2	0.1750	12.66	9.65	22.31	54.72	-32.41	AVG	
3	0.2445	20.02	9.64	29.66	61.94	-32.28	QP	
4	0.2445	4.33	9.64	13.97	51.94	-37.97	AVG	
5	0.5055	19.47	9.64	29.11	56.00	-26.89	QP	
6 *	0.5055	11.34	9.64	20.98	46.00	-25.02	AVG	
7	1.7408	13.29	9.70	22.99	56.00	-33.01	QP	
8	1.7408	4.51	9.70	14.21	46.00	-31.79	AVG	
9	3.4643	10.76	9.75	20.51	56.00	-35.49	QP	
10	3.4643	4.25	9.75	14.00	46.00	-32.00	AVG	
11	10.0004	11.89	9.91	21.80	60.00	-38.20	QP	
12	10.0004	4.08	9.91	13.99	50.00	-36.01	AVG	

**REMARKS:**

- (1) Measurement Value = Reading Level + Correct Factor.
- (2) Margin Level = Measurement Value - Limit Value.

Test Mode	Idle	Tested Date	2023/3/29
Test Frequency	-	Phase	Line

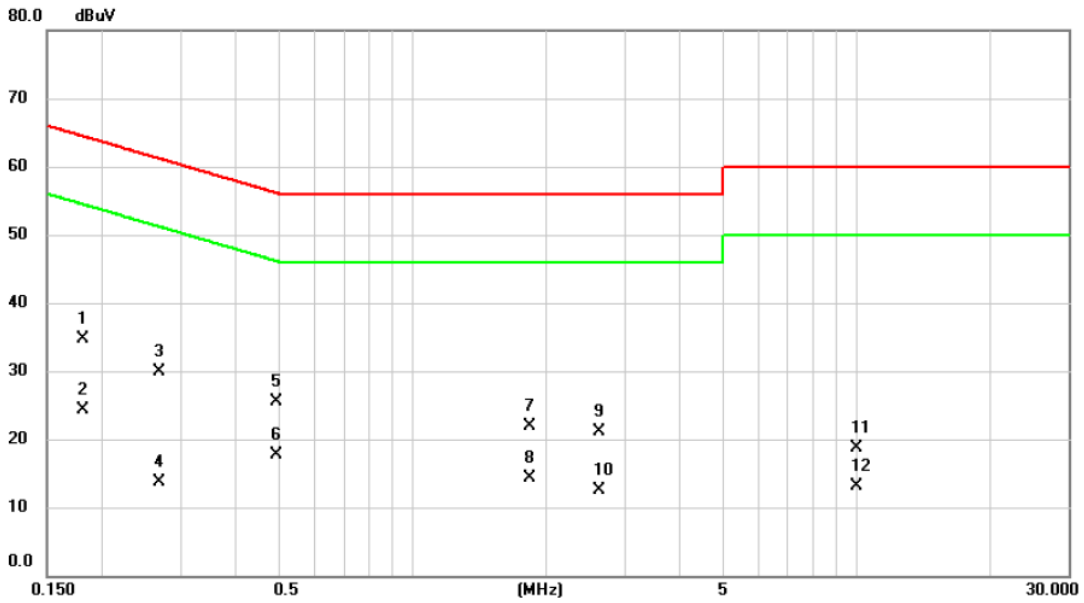

No. Mk.	Freq. MHz	Reading Level dBuV	Correct Factor dB	Measurement dBuV	Limit dBuV	Margin dB	Detector	Comment
1	0.1815	25.08	9.63	34.71	64.42	-29.71	QP	
2	0.1815	14.75	9.63	24.38	54.42	-30.04	AVG	
3	0.2692	20.35	9.63	29.98	61.14	-31.16	QP	
4	0.2692	4.15	9.63	13.78	51.14	-37.36	AVG	
5	0.4920	15.92	9.63	25.55	56.13	-30.58	QP	
6 *	0.4920	8.14	9.63	17.77	46.13	-28.36	AVG	
7	1.8398	12.26	9.70	21.96	56.00	-34.04	QP	
8	1.8398	4.56	9.70	14.26	46.00	-31.74	AVG	
9	2.6363	11.42	9.72	21.14	56.00	-34.86	QP	
10	2.6363	2.78	9.72	12.50	46.00	-33.50	AVG	
11	10.0004	8.81	9.88	18.69	60.00	-41.31	QP	
12	10.0004	3.28	9.88	13.16	50.00	-36.84	AVG	

**REMARKS:**

- (1) Measurement Value = Reading Level + Correct Factor.
- (2) Margin Level = Measurement Value - Limit Value.

Test Mode	Idle	Tested Date	2023/3/29
Test Frequency	-	Phase	Neutral

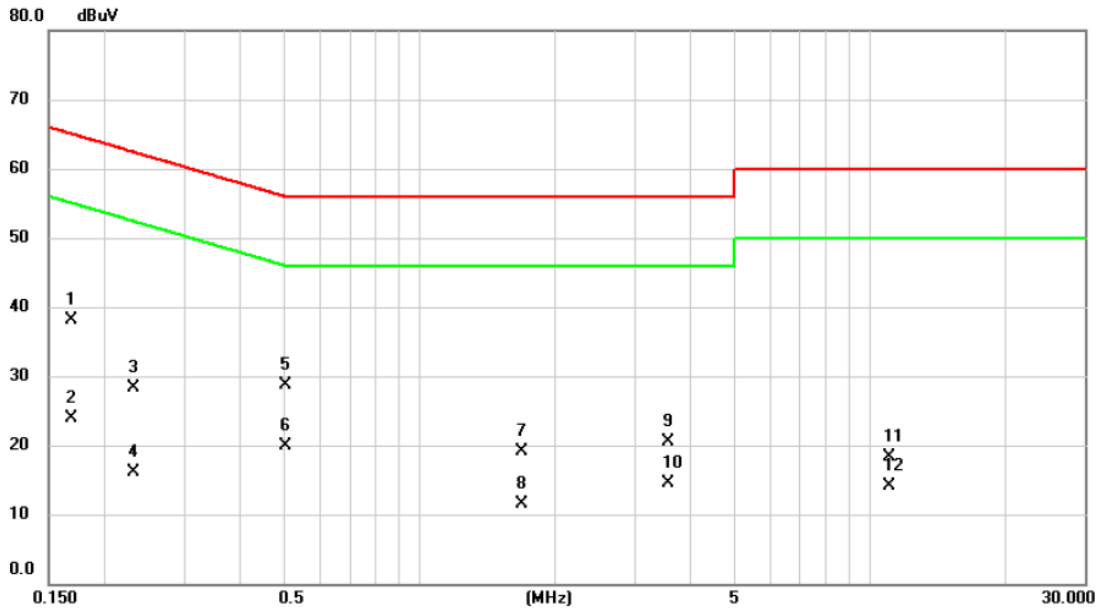

No. Mk.	Freq. MHz	Reading Level dBuV	Correct Factor dB	Measurement dBuV	Limit dBuV	Margin dB	Detector	Comment
1	0.1680	28.44	9.65	38.09	65.06	-26.97	QP	
2	0.1680	14.32	9.65	23.97	55.06	-31.09	AVG	
3	0.2310	18.74	9.64	28.38	62.41	-34.03	QP	
4	0.2310	6.43	9.64	16.07	52.41	-36.34	AVG	
5	0.5032	19.13	9.64	28.77	56.00	-27.23	QP	
6 *	0.5032	10.21	9.64	19.85	46.00	-26.15	AVG	
7	1.6823	9.50	9.70	19.20	56.00	-36.80	QP	
8	1.6823	1.80	9.70	11.50	46.00	-34.50	AVG	
9	3.5768	10.76	9.76	20.52	56.00	-35.48	QP	
10	3.5768	4.77	9.76	14.53	46.00	-31.47	AVG	
11	11.0513	8.34	9.92	18.26	60.00	-41.74	QP	
12	11.0513	4.21	9.92	14.13	50.00	-35.87	AVG	

**REMARKS:**

- (1) Measurement Value = Reading Level + Correct Factor.
- (2) Margin Level = Measurement Value - Limit Value.

## **APPENDIX B    RADIATED EMISSIONS - 30 MHZ TO 1 GHZ**



Test Mode	BLE 5.0 (2 Mbps)	Test Date	2023/3/28
Test Frequency	2440MHz	Polarization	Vertical
Temp	21°C	Hum.	61%

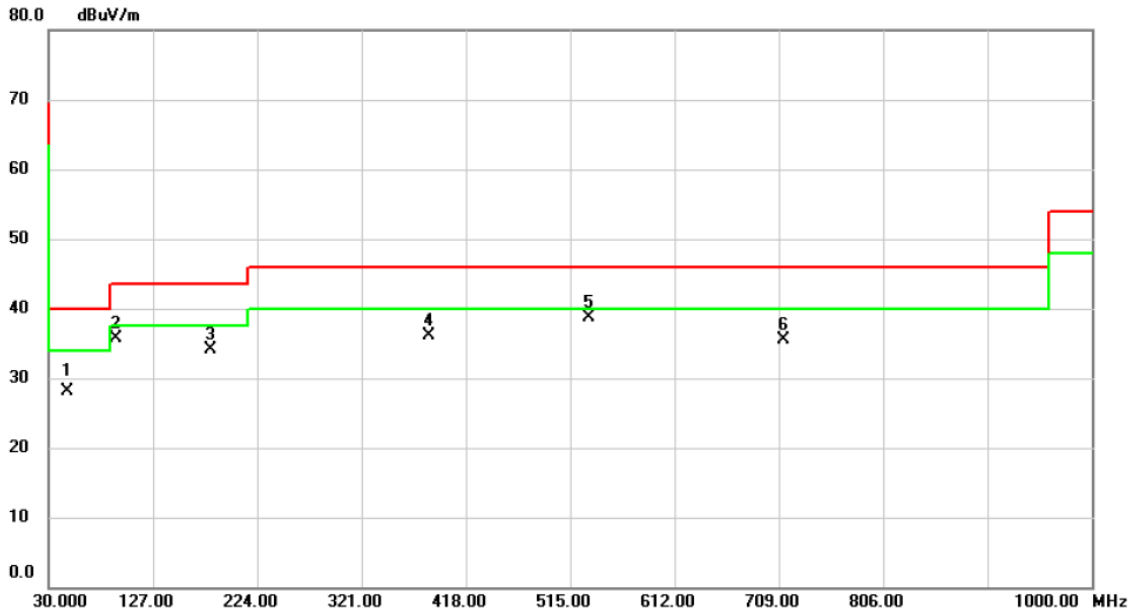

No.	Mk.	Freq.	Reading Level	Correct Factor	Measurement	Limit	Over	Detector	Comment
		MHz	dBuV	dB	dBuV/m	dBuV/m	dB		
1		47.0073	40.42	-12.25	28.17	40.00	-11.83	QP	
2		92.7590	54.03	-18.26	35.77	43.50	-7.73	peak	
3		180.6410	48.77	-14.61	34.16	43.50	-9.34	peak	
4		383.9530	46.88	-10.75	36.13	46.00	-9.87	peak	
5	*	532.8803	46.39	-7.67	38.72	46.00	-7.28	peak	
6		713.4620	40.07	-4.62	35.45	46.00	-10.55	peak	

**REMARKS:**

- (1) Measurement Value = Reading Level + Correct Factor.
- (2) Margin Level = Measurement Value - Limit Value.

Test Mode	BLE 5.0 (2 Mbps)	Test Date	2023/3/28
Test Frequency	2440MHz	Polarization	Horizontal
Temp	21°C	Hum.	61%

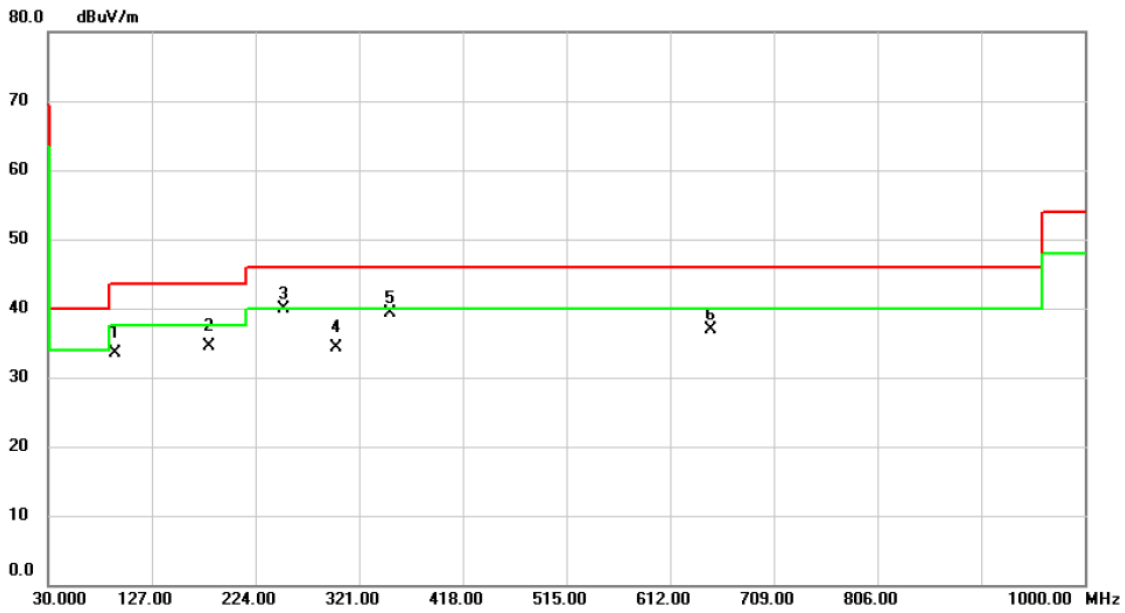

No.	Mk.	Freq.	Reading Level	Correct Factor	Measurement	Limit	Over		
		MHz	dBuV	dB	dBuV/m	dBuV/m	dB	Detector	Comment
1		92.5327	51.82	-18.29	33.53	43.50	-9.97	QP	
2		180.8997	49.23	-14.64	34.59	43.50	-8.91	QP	
3	*	250.0283	54.33	-14.39	39.94	46.00	-6.06	peak	
4		299.9833	47.08	-12.78	34.30	46.00	-11.70	QP	
5		350.0030	51.10	-11.76	39.34	46.00	-6.66	peak	
6		650.0240	42.35	-5.51	36.84	46.00	-9.16	peak	

**REMARKS:**

- (1) Measurement Value = Reading Level + Correct Factor.
- (2) Margin Level = Measurement Value - Limit Value.

**End of Test Report**