FCC Test Report

Report No.: AGC00594170601FE03

FCC ID : 2A13K-CS22SA
APPLICATION PURPOSE : Original Equipment
PRODUCT DESIGNATION : Rugged Mobile Phone
BRAND NAME : Cyrus
MODEL NAME : CS22SA
CLIENT : Cyrus Technology GmbH
DATE OF ISSUE : July 10, 2017
STANDARD(S) : FCC Part 15 Rules
TEST PROCEDURE(S) : ANSI C63.10 (2013)
REPORT VERSION : V1.0

Attestation of Global Compliance (Shenzhen) Co., Ltd



CAUTION:

This report shall not be reproduced except in full without the written permission of the test laboratory and shall not be quoted out of context.



Report Revise Record

Report Version	Revise Time	Issued Date	Valid Version	Notes
V1.0	/	July 10, 2017	Valid	Original Report

TABLE OF CONTENTS

1. VERIFICATION OF CONFORMITY	5
2. GENERAL INFORMATION	6
2.1. PRODUCT DESCRIPTION	6
2.2. TABLE OF CARRIER FREQUENCIES	6
2.3. RECEIVER INPUT BANDWIDTH.....	7
2.4. EXAMPLE OF A HOPPING SEQUENCY IN DATA MODE	7
2.5. EQUALLY AVERAGE USE OF FREQUENCIES AND BEHAVIOUR.....	7
2.6. RELATED SUBMITTAL(S) / GRANT (S)	8
2.7. TEST METHODOLOGY	8
2.8. SPECIAL ACCESSORIES	8
2.9. EQUIPMENT MODIFICATIONS.....	8
3. MEASUREMENT UNCERTAINTY.....	9
4. DESCRIPTION OF TEST MODES.....	9
5. SYSTEM TEST CONFIGURATION	9
5.1. CONFIGURATION OF EUT SYSTEM.....	9
5.2. EQUIPMENT USED IN EUT SYSTEM.....	10
5.3. SUMMARY OF TEST RESULTS.....	10
6. TEST FACILITY	11
7. PEAK OUTPUT POWER	13
7.1. MEASUREMENT PROCEDURE.....	13
7.2. TEST SET-UP (BLOCK DIAGRAM OF CONFIGURATION)	13
7.3. LIMITS AND MEASUREMENT RESULT	13
8. 20DB BANDWIDTH.....	16
8.1. MEASUREMENT PROCEDURE.....	16
8.2. TEST SET-UP (BLOCK DIAGRAM OF CONFIGURATION)	16
8.3. LIMITS AND MEASUREMENT RESULTS.....	16
9. CONDUCTED SPURIOUS EMISSION	19
9.1. MEASUREMENT PROCEDURE.....	19
9.2. TEST SET-UP (BLOCK DIAGRAM OF CONFIGURATION)	19
9.3. MEASUREMENT EQUIPMENT USED.....	19
9.4. LIMITS AND MEASUREMENT RESULT	19
10. RADIATED EMISSION	25
10.1. MEASUREMENT PROCEDURE.....	25
10.2. TEST SETUP.....	26
10.3. LIMITS AND MEASUREMENT RESULT	27

- 10.4. TEST RESULT 28
- 11. BAND EDGE EMISSION 31**
 - 11.1. MEASUREMENT PROCEDURE 31
 - 11.2. TEST SET-UP 31
 - 11.3. Radiated TEST RESULT 32
 - 11.4 Conducted TEST RESULT 33
- 12. NUMBER OF HOPPING FREQUENCY..... 37**
 - 12.1. MEASUREMENT PROCEDURE..... 37
 - 12.2. TEST SETUP (BLOCK DIAGRAM OF CONFIGURATION) 37
 - 12.3. MEASUREMENT EQUIPMENT USED..... 37
 - 12.4. LIMITS AND MEASUREMENT RESULT 37
- 13.1. MEASUREMENT PROCEDURE..... 38
 - 13.2. TEST SETUP (BLOCK DIAGRAM OF CONFIGURATION) 38
 - 13.3. MEASUREMENT EQUIPMENT USED..... 38
 - 13.4. LIMITS AND MEASUREMENT RESULT 38
 - Test Graph 39
- 14. FREQUENCY SEPARATION 40**
 - 14.1. MEASUREMENT PROCEDURE..... 40
 - 14.2. TEST SETUP (BLOCK DIAGRAM OF CONFIGURATION) 40
 - 14.3. MEASUREMENT EQUIPMENT USED..... 40
 - 14.4. LIMITS AND MEASUREMENT RESULT 40
- 15. FCC LINE CONDUCTED EMISSION TEST 41**
 - 15.1. LIMITS OF LINE CONDUCTED EMISSION TEST 41
 - 15.2. BLOCK DIAGRAM OF LINE CONDUCTED EMISSION TEST 41
 - 15.3. PRELIMINARY PROCEDURE OF LINE CONDUCTED EMISSION TEST 42
 - 15.4. FINAL PROCEDURE OF LINE CONDUCTED EMISSION TEST 42
 - 15.5. TEST RESULT OF LINE CONDUCTED EMISSION TEST 43
- APPENDIX A: PHOTOGRAPHS OF TEST SETUP 45**

1. VERIFICATION OF CONFORMITY

Applicant	Cyrus Technology GmbH
Address	Hergelsbendenstraße 49 D-52080 Aachen Germany
Manufacturer	Shenzhen Xin Kingbrand Enterprises Co., Ltd
Address	KingBrand Industrial Zone, Nanpu Road, Shang Liao Lin Pikeng, Shajing Town, Baoan District, Shenzhen City, Guangdong Province, China
Product Designation	Rugged Mobile Phone
Brand Name	Cyrus
Test Model	CS22SA
Date of test	June 23, 2017~July 10, 2017
Deviation	None
Condition of Test Sample	Normal
Report Template	AGCRT-US-BR/RF

We hereby certify that:

The above equipment was tested by Dongguan Precise Testing Service Co., Ltd. The test data, data evaluation, test procedures, and equipment configurations shown in this report were made in accordance with the procedures given in ANSI C63.10 (2013) and the energy emitted by the sample EUT tested as described in this report is in compliance with radiated emission limits of FCC Rules Part 15.247.

Tested By	
	_____ Donjon Huang(Huang Dongyang) July 10, 2017
Reviewed By	
	_____ Bart Xie(Xie Xiaobin) July 10, 2017
Approved By	
	_____ Solger Zhang(Zhang Hongyi) Authorized Officer July 10, 2017

2. GENERAL INFORMATION

2.1. PRODUCT DESCRIPTION

The EUT is “Rugged Mobile Phone ” designed as a “Communication Device”. It is designed by way of utilizing the FHSS technology to achieve the system operation.

A major technical description of EUT is described as following

Operation Frequency	2.402 GHz to 2.480GHz
Bluetooth Version	V 3.0
Modulation	GFSK, $\pi/4$ -DQPSK, 8DPSK
Number of channels	79(For BR/EDR)
Hardware Version	FQ5_02
Software Version	smartphone_A7N_20170607_V0.01
Antenna Designation	Integrated Antenna
Antenna Gain	0.5dBi
Power Supply	DC3.8V by Battery

2.2. TABLE OF CARRIER FREQUENCIES

Frequency Band	Channel Number	Frequency
2400~2483.5MHZ	0	2402MHZ
	1	2403MHZ
	:	:
	38	2440 MHZ
	39	2441 MHZ
	40	2442 MHZ
	:	:
	77	2479 MHZ
	78	2480 MHZ

2.3. RECEIVER INPUT BANDWIDTH

The input bandwidth of the receiver is 1.3MHz. In every connection one Bluetooth device is the master and the other one is slave. The master determines the hopping sequence. The slave follows this sequence. Both devices shift between RX and TX time slot according to the clock of the master. Additionally the type of connection (e.g. single or multislotted packet) is set up at the beginning of the connection. The master adapts its hopping frequency and its TX/RX timing according to the packet type of the connection. Also the slave of the connection will use these settings.

Repeating of a packet has no influence on the hopping sequence. The hopping sequence generated by the master of the connection will be followed in any case. That means, a repeated packet will not be sent on the same frequency, it is sent on the next frequency of the hopping sequence.

2.4. EXAMPLE OF A HOPPING SEQUENCE IN DATA MODE

Example of a 79 hopping sequence in data mode:

40,21,44,23,42,53,46,55,48,33,52,35,50,65,54,67
56,37,60,39,58,69,62,71,64,25,68,27,66,57,70,59
72,29,76,31,74,61,78,63,01,41,05,43,03,73,07,75
09,45,13,47,11,77,15,00,64,49,66,53,68,02,70,06
01, 51, 03, 55, 05, 04

2.5. EQUALLY AVERAGE USE OF FREQUENCIES AND BEHAVIOUR

The generation of the hopping sequence in connection mode depends essentially on two input values:

1. LAP/UAP of the master of the connection.
2. Internal master clock

The LAP (lower address part) are the 24 LSB's of the 48 BD_ADDRESS. The BD_ADDRESS is an unambiguous number of every Bluetooth unit. The UAP (upper address part) are the 24 MSB's of the 48 BD_ADDRESS.

The internal clock of a Bluetooth unit is derived from a free running clock which is never adjusted and is never turned off. For synchronization with other units only offsets are used. It has no relation to the time of the day. Its resolution is at least half the RX/TX slot length of 312.5µs. The clock has a cycle of about one day (23h30). In most cases it is implemented as a 28-bit counter. For the deriving of the hopping sequence the entire LAP (24 bits), 4 LSB's (4 bits) (Input 1) and the 27 MSB's of the clock (Input 2) are used. With these input values different mathematical procedures (permutations, additions, XOR-operations) are performed to generate the sequence. This will be done at the beginning of every new transmission.

Regarding short transmissions the Bluetooth system has the following behavior:

The first connection between the two devices is established, a hopping sequence was generated. For transmitting the wanted data the complete hopping sequence was not used. The connection ended. The second connection will be established. A new hopping sequence is generated. Due to the fact the Bluetooth clock has a different value, because the period between the two transmissions is longer (and it cannot be shorter) than the minimum resolution of the clock (312.5µs). The hopping sequence will always differ from the first one.

2.6. RELATED SUBMITTAL(S) / GRANT (S)

This submittal(s) (test report) is intended for **FCC ID: 2A13K-CS22SA** filing to comply with Section 15.247 of the FCC Part 15, Subpart C Rules.

2.7. TEST METHODOLOGY

Both conducted and radiated testing was performed according to the procedures in ANSI C63.10 (2013). Radiated testing was performed at an antenna to EUT distance 3 meters.

2.8. SPECIAL ACCESSORIES

Refer to section 5.2.

2.9. EQUIPMENT MODIFICATIONS

Not available for this EUT intended for grant.

3. MEASUREMENT UNCERTAINTY

Conducted measurement: +/- 2.75dB

Radiated measurement: +/- 3.2dB

4. DESCRIPTION OF TEST MODES

NO.	TEST MODE DESCRIPTION
1	Low channel GFSK
2	Middle channel GFSK
3	High channel GFSK
4	Low channel $\pi/4$ -DQPSK
5	Middle channel $\pi/4$ -DQPSK
6	High channel $\pi/4$ -DQPSK
7	Low channel 8DPSK
8	Middle channel 8DPSK
9	High channel 8DPSK
10	Normal Hopping

Note:

1. All the test modes can be supply by Built-in Li-ion battery, only the result of the worst case was recorded in the report, if no other cases.
2. For Radiated Emission, 3axis were chosen for testing for each applicable mode.

5. SYSTEM TEST CONFIGURATION

5.1. CONFIGURATION OF EUT SYSTEM

Configuration:

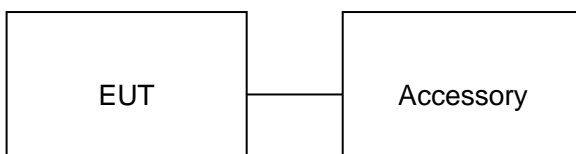

5.2. EQUIPMENT USED IN EUT SYSTEM

Item	Equipment	Model No.	ID or Specification	Remark
1	Rugged Mobile Phone	CS22SA	FCC ID: 2AI3K-CS22SA	EUT
2	Adapter	RKL-0510	DC 5.0V/2A	Accessory
3	Battery	V28S	DC3.8V/ 3000mAh	Accessory
4	USB Cable	N/A	N/A	Accessory
5	Earphone	N/A	N/A	Accessory

5.3. SUMMARY OF TEST RESULTS

FCC RULES	DESCRIPTION OF TEST	RESULT
§15.247	Peak Output Power	Compliant
§15.247	20 dB Bandwidth	Compliant
§15.247	Spurious Emission	Compliant
§15.209	Radiated Emission	Compliant
§15.247	Band Edges	Compliant
§15.207	Conduction Emission	Compliant
§15.247	Number of Hopping Frequency	Compliant
§15.247	Time of Occupancy	Compliant
§15.247	Frequency Separation	Compliant

6. TEST FACILITY

Site	Dongguan Precise Testing Service Co., Ltd.
Location	Building D,Baoding Technology Park,Guangming Road2,Dongcheng District, Dongguan, Guangdong, China,
FCC Registration No.	371540
Description	The test site is constructed and calibrated to meet the FCC requirements in documents ANSI C63.10:2013.

ALL TEST EQUIPMENT LIST

FOR RADIATED EMISSION TEST (BELOW 1GHZ)

Radiated Emission Test Site					
Name of Equipment	Manufacturer	Model Number	Serial Number	Last Calibration	Due Calibration
EMI Test Receiver	Rohde & Schwarz	ESCI	101417	July 3, 2016	July 2, 2017
EMI Test Receiver	Rohde & Schwarz	ESCI	101417	July 2, 2017	July 1, 2018
Trilog Broadband Antenna (25M-1GHz)	SCHWARZBECK	VULB9160	9160-3355	July 3, 2016	July 2, 2017
Trilog Broadband Antenna (25M-1GHz)	SCHWARZBECK	VULB9160	9160-3355	July 2, 2017	July 1, 2018
Signal Amplifier	SCHWARZBECK	BBV 9475	9745-0013	July 3, 2016	July 2, 2017
Signal Amplifier	SCHWARZBECK	BBV 9475	9745-0013	July 2, 2017	July 1, 2018
RF Cable	SCHWARZBECK	AK9515E	96221	July 3, 2016	July 2, 2017
RF Cable	SCHWARZBECK	AK9515E	96221	July 2, 2017	July 1, 2018
3m Anechoic Chamber	CHENGYU	966	PTS-001	June 2, 2017	June 1, 2018
MULTI-DEVICE Positioning Controller	Max-Full	MF-7802	MF780208339	N/A	N/A
Active loop antenna (9K-30MHz)	Schwarzbeck	FMZB1519	1519-038	June 2, 2017	June 1, 2018
Spectrum analyzer	Agilent	E4407B	MY46185649	June 2, 2017	June 1, 2018
Power Probe	R&S	NRP-Z23	100323	July 24,2016	July 23,2017
RF attenuator	N/A	RFA20db	68	N/A	N/A

FOR RADIATED EMISSION TEST (1GHZ ABOVE)

Radiated Emission Test Site					
Name of Equipment	Manufacturer	Model Number	Serial Number	Last Calibration	Due Calibration
EMI Test Receiver	Rohde & Schwarz	ESCI	101417	July 3, 2016	July 2, 2017
EMI Test Receiver	Rohde & Schwarz	ESCI	101417	July 2, 2017	July 1, 2018
Horn Antenna (1G-18GHz)	SCHWARZBECK	BBHA9120D	9120D-1246	July 10, 2016	July 9, 2018

Spectrum Analyzer	Agilent	E4411B	MY4511453	July 3, 2016	July 2, 2017
Spectrum Analyzer	Agilent	E4411B	MY4511453	July 2, 2017	July 1, 2018
Signal Amplifier	SCHWARZBECK	BBV 9718	9718-269	July 6, 2016	July 5, 2017
RF Cable	SCHWARZBECK	AK9515H	96220	July 7, 2016	July 6, 2017
3m Anechoic Chamber	CHENGYU	966	PTS-001	June 2, 2017	June 1, 2018
MULTI-DEVICE Positioning Controller	Max-Full	MF-7802	MF780208339	N/A	N/A
Horn Ant (18G-40GHz)	Schwarzbeck	BBHA 9170	9170-181	June 2, 2017	June 1, 2018
Power Probe	R&S	NRP-Z23	100323	July 24, 2016	July 23, 2017
RF attenuator	N/A	RFA20db	68	N/A	N/A

Conducted Emission Test Site					
Name of Equipment	Manufacturer	Model Number	Serial Number	Last Calibration	Due Calibration
EMI Test Receiver	Rohde & Schwarz	ESCI	101417	July 3, 2016	July 2, 2017
EMI Test Receiver	Rohde & Schwarz	ESCI	101417	July 2, 2017	July 1, 2018
Artificial Mains Network	Narda	L2-16B	000WX31025	July 7, 2016	July 6, 2017
Artificial Mains Network	Narda	L2-16B	000WX31025	July 2, 2017	July 1, 2018
Artificial Mains Network (AUX)	Narda	L2-16B	000WX31026	July 7, 2016	July 6, 2017
Artificial Mains Network (AUX)	Narda	L2-16B	000WX31026	July 2, 2017	July 1, 2018
RF Cable	SCHWARZBECK	AK9515E	96222	July 3, 2016	July 2, 2017
RF Cable	SCHWARZBECK	AK9515E	96222	July 2, 2017	July 1, 2018
Shielded Room	CHENGYU	843	PTS-002	June 2, 2017	June 1, 2018

7. PEAK OUTPUT POWER

7.1. MEASUREMENT PROCEDURE

For peak power test:

1. Connect EUT RF output port to the Spectrum Analyzer through an RF attenuator
2. Set the EUT Work on the top, middle and the bottom operation frequency individually.
3. RBW > the 20 dB bandwidth of the emission being measured, VBW \geq RBW.
4. Record the maximum power from the Spectrum Analyzer.

For average power test:

1. Connect EUT RF output port to power probe through an RF attenuator.
2. Connect the power probe to the PC.
3. Set the EUT Work on the top, the middle and the bottom operation frequency individually.
4. Record the maximum power from the software.

Note : The EUT was tested according for compliance ANSI C63.10 (2013) requirements.

7.2. TEST SET-UP (BLOCK DIAGRAM OF CONFIGURATION)

PEAK POWER TEST SETUP

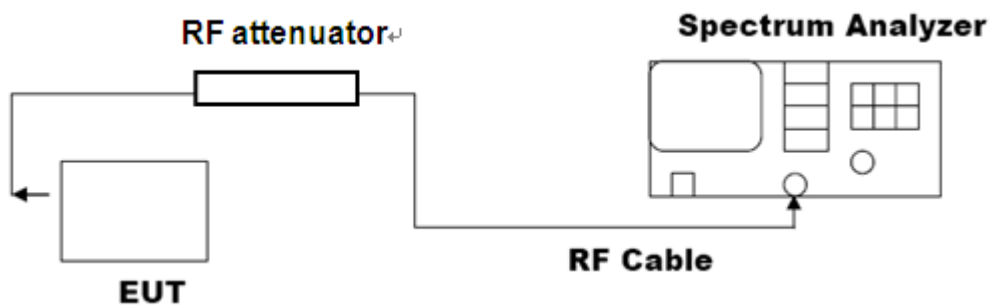

7.3. LIMITS AND MEASUREMENT RESULT

Mode	Frequency (GHz)	Peak Power (dBm)	Applicable Limits (dBm)	Pass or Fail
GFSK	2.402	-1.849	30	Pass
	2.441	-0.411	30	Pass
	2.480	0.759	30	Pass

Mode	Frequency (GHz)	Peak Power (dBm)	Applicable Limits (dBm)	Pass or Fail
π /4-DQPSK	2.402	-2.848	30	Pass
	2.441	-1.106	30	Pass
	2.480	-0.021	30	Pass

Mode	Frequency (GHz)	Peak Power (dBm)	Applicable Limits (dBm)	Pass or Fail
8DPSK	2.402	-2.930	30	Pass
	2.441	-1.229	30	Pass
	2.480	-0.081	30	Pass

Test Graph

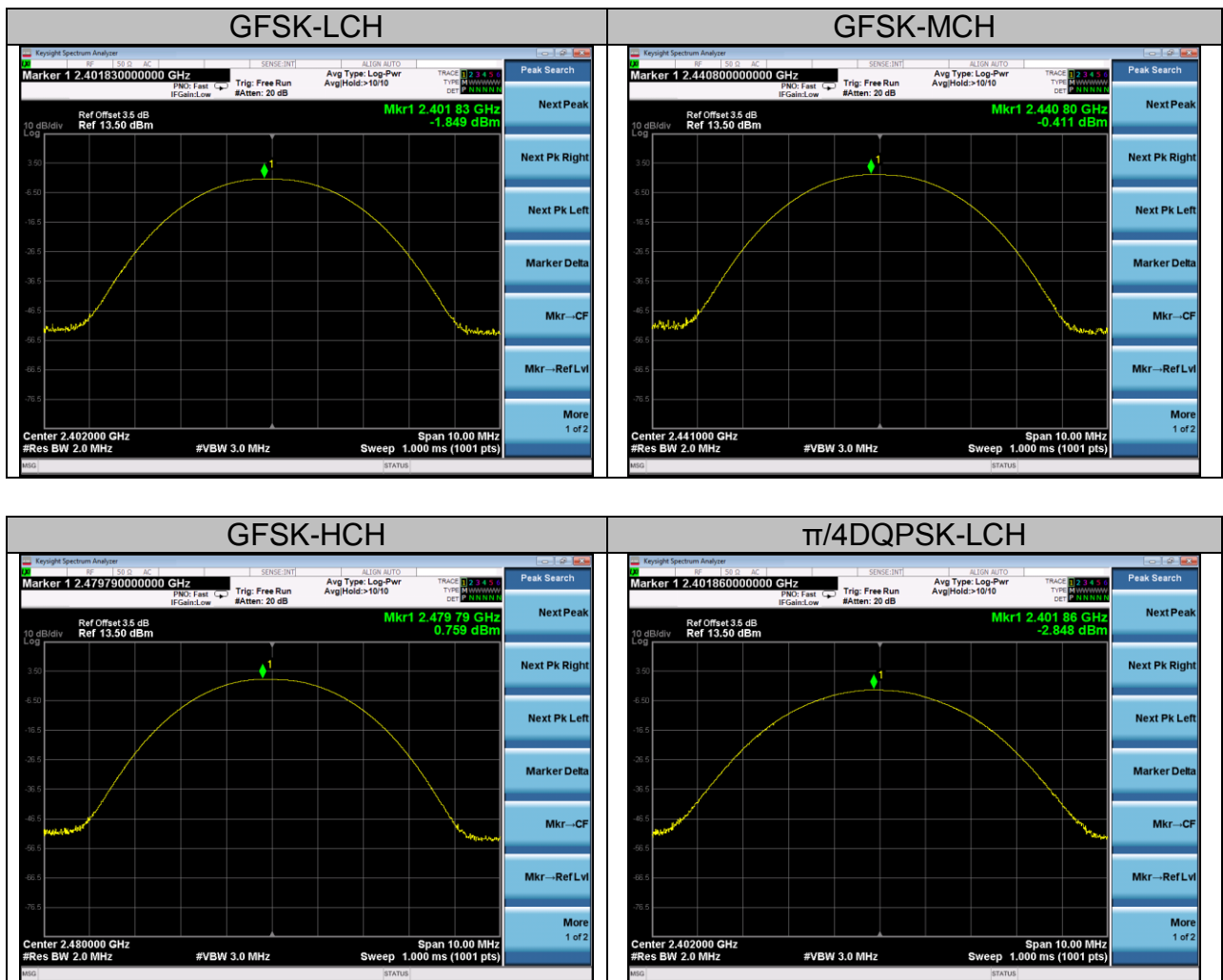

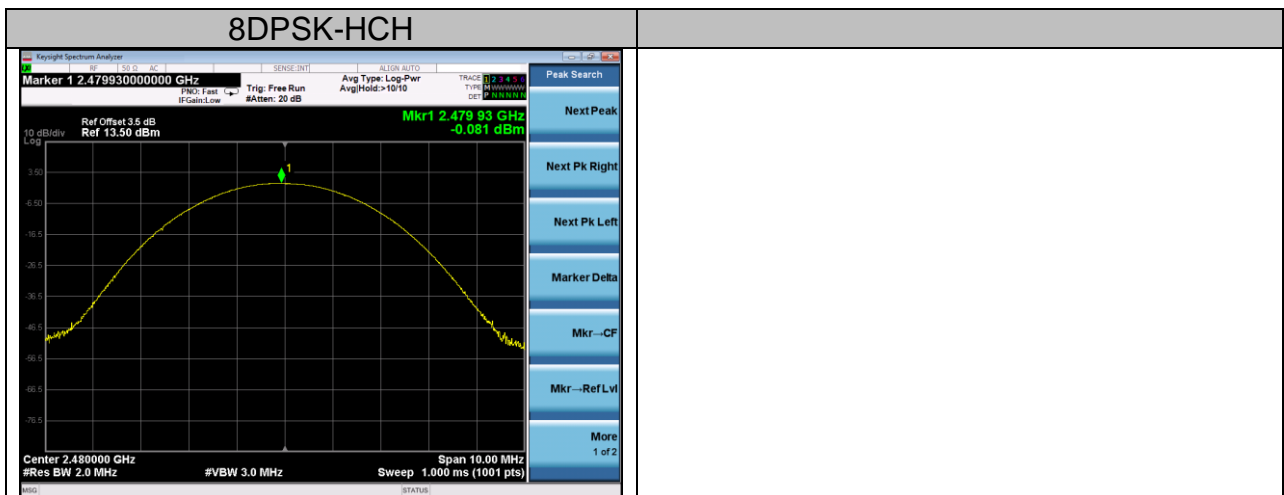
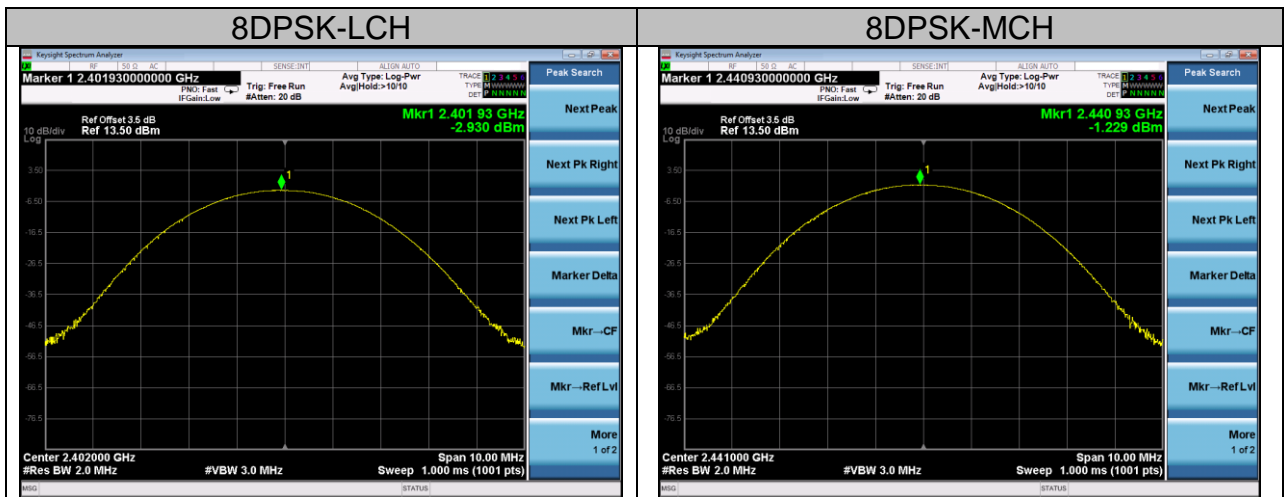
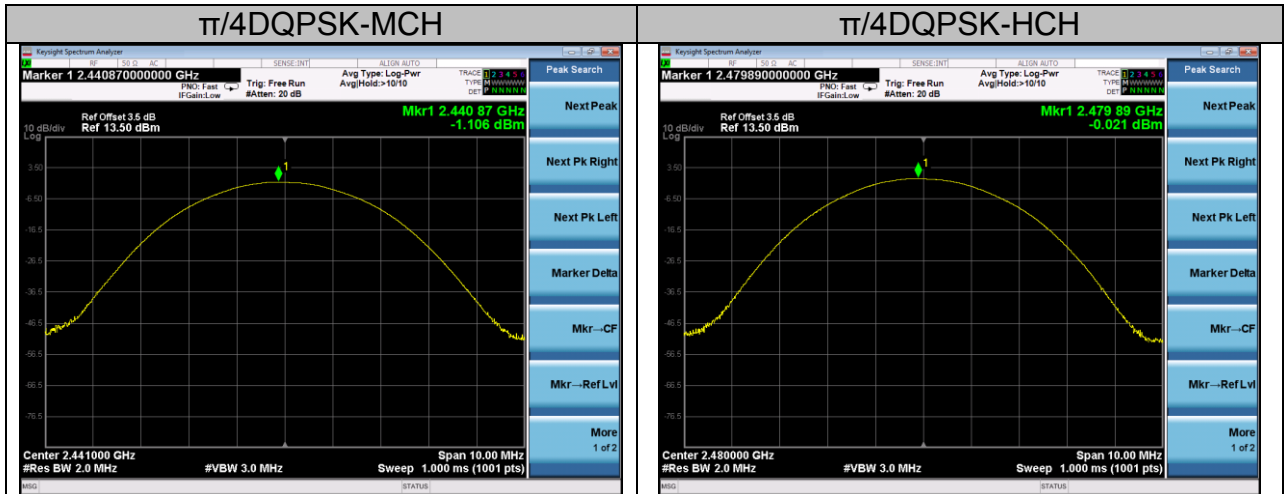

8. 20DB BANDWIDTH

8.1. MEASUREMENT PROCEDURE

1. Connect EUT RF output port to the Spectrum Analyzer through an RF attenuator
2. Set the EUT Work on the top, the middle and the bottom operation frequency individually.
3. Set Span = approximately 2 to 3 times the 20 dB bandwidth, centered on a hoping channel
RBW \geq 1% of the 20 dB bandwidth, VBW \geq RBW; Sweep = auto; Detector function = peak
4. Set SPA Trace 1 Max hold, then View.

8.2. TEST SET-UP (BLOCK DIAGRAM OF CONFIGURATION)

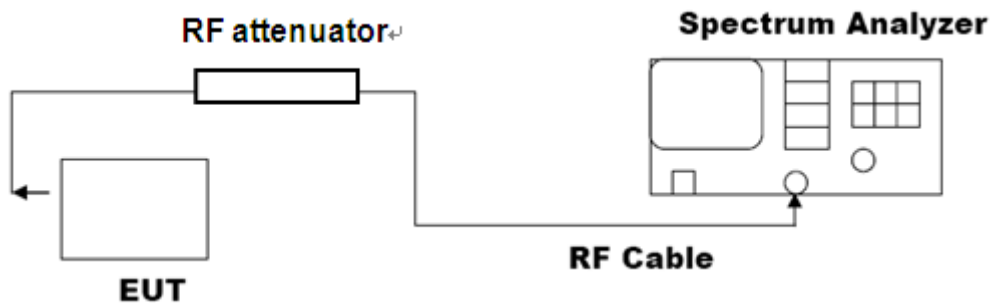

8.3. LIMITS AND MEASUREMENT RESULTS

Mode	Channel.	20dB Bandwidth [KHz]	Verdict
GFSK	LCH	828.4	PASS
GFSK	MCH	833.3	PASS
GFSK	HCH	838.2	PASS
$\pi/4$ DQPSK	LCH	1131	PASS
$\pi/4$ DQPSK	MCH	1127	PASS
$\pi/4$ DQPSK	HCH	1125	PASS
8DPSK	LCH	1122	PASS
8DPSK	MCH	1120	PASS
8DPSK	HCH	1114	PASS

Test Graph

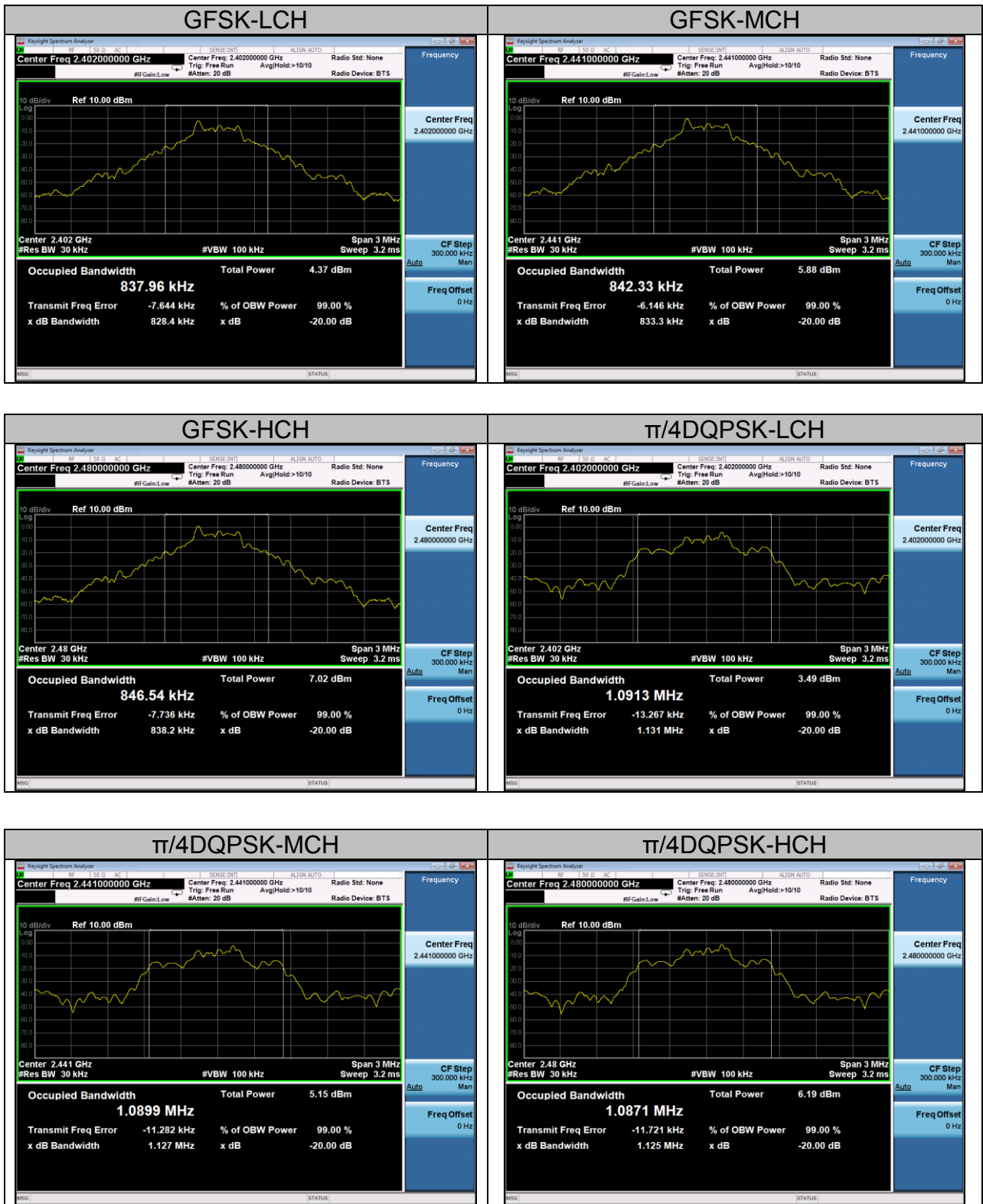

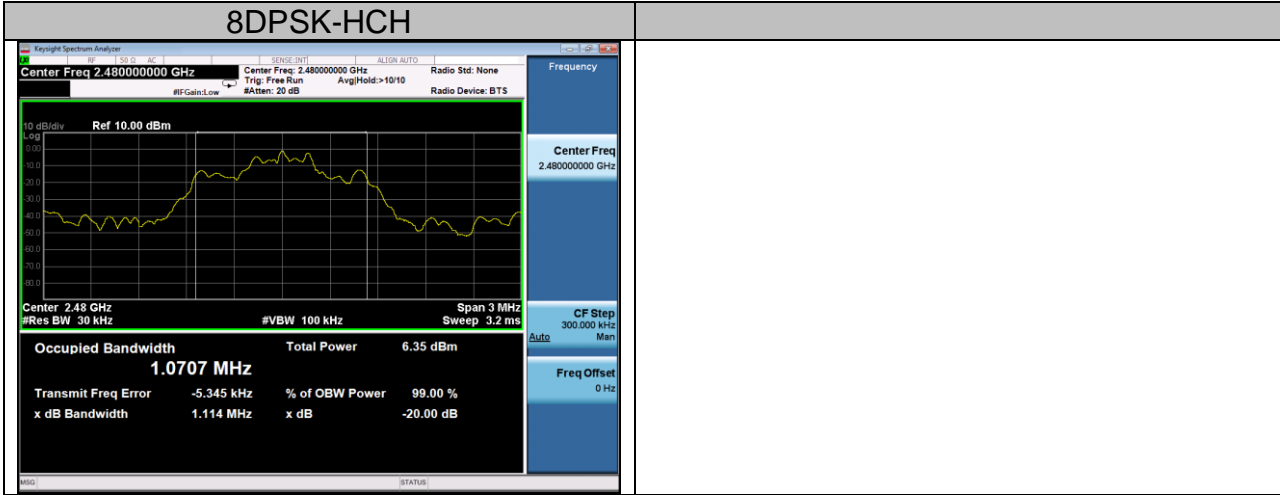
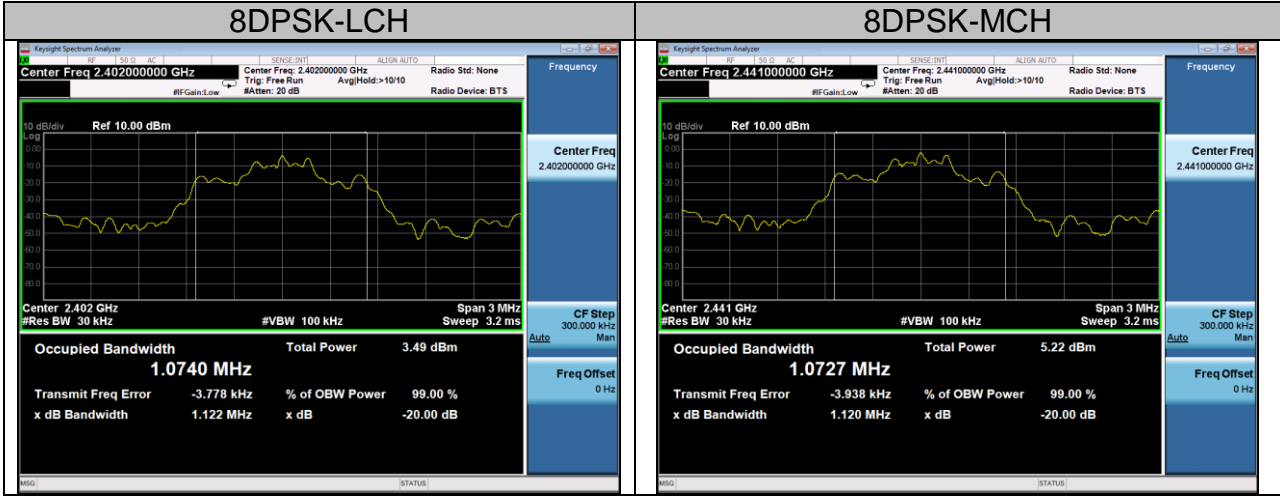

9. CONDUCTED SPURIOUS EMISSION

9.1. MEASUREMENT PROCEDURE

1. Connect EUT RF output port to the Spectrum Analyzer through an RF attenuator
2. Set the EUT Work on the top, the Middle and the bottom operation frequency individually.
3. Set the Span = wide enough to capture the peak level of the in-band emission and all spurious emissions from the lowest frequency generated in the EUT up through the 10th harmonic.
RBW = 100 kHz; VBW \geq RBW; Sweep = auto; Detector function = peak.
4. Set SPA Trace 1 Max hold, then View.

Note: The EUT was tested according for compliance ANSI C63.10 (2013) requirements. Owing to satisfy the requirements of the number of measurement points, we set the RBW=1MHz, VBW > RBW, scan up through 10th harmonic, and consider the tested results as the worst case, if the tested results conform to the requirement, we can deem that the real tested results(set the RBW=100KHz, VBW > RBW) are conform to the requirement.

9.2. TEST SET-UP (BLOCK DIAGRAM OF CONFIGURATION)

The same as described in section 8.2

9.3. MEASUREMENT EQUIPMENT USED

The same as described in section 6

9.4. LIMITS AND MEASUREMENT RESULT

LIMITS AND MEASUREMENT RESULT		
Applicable Limits	Measurement Result	
	Test Data	Criteria
In any 100 KHz Bandwidth Outside the frequency band in which the spread spectrum intentional radiator is operating, the radio frequency power that is produce by the intentional radiator shall be at least 20 dB below that in 100KHz bandwidth within the band that contains the highest level of the desired power. In addition, radiation emissions which fall in the restricted bands, as defined in §15.205(a), must also comply with the radiated emission limits specified in§15.209(a)	At least -20dBc than the limit Specified on the BOTTOM Channel	PASS
	At least -20dBc than the limit Specified on the TOP Channel	PASS

Test Graph

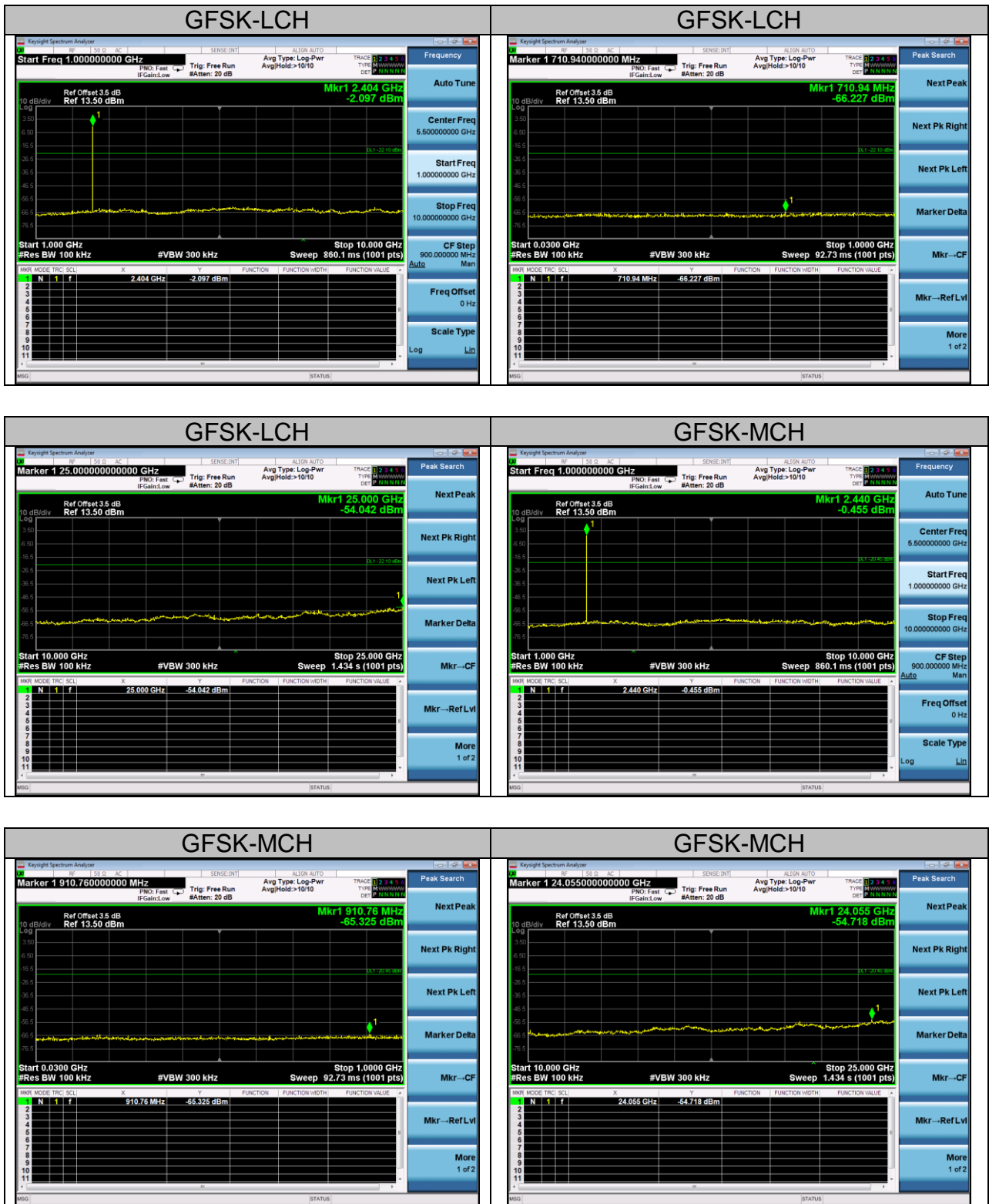

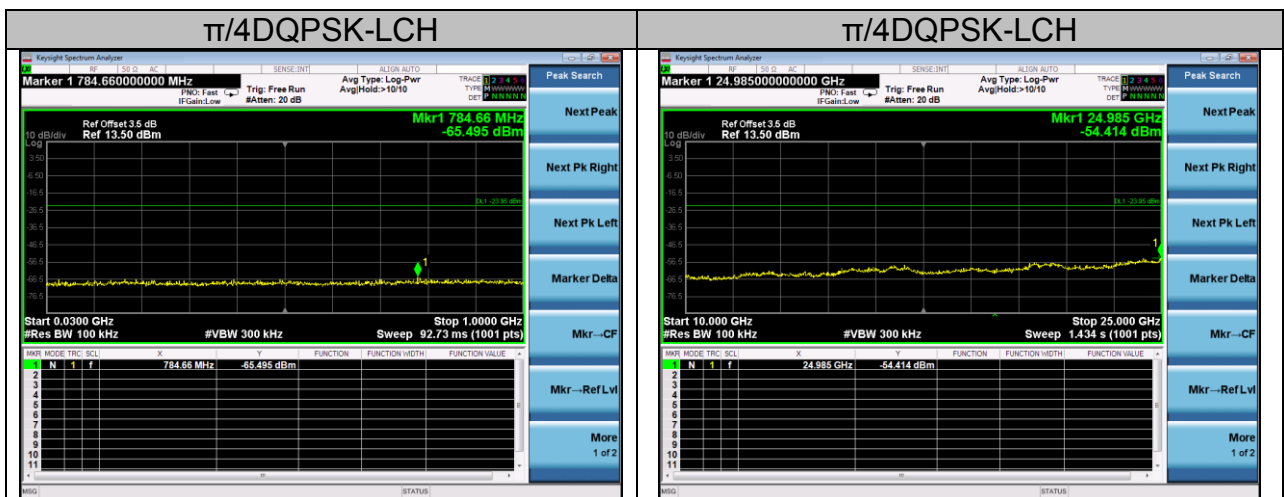
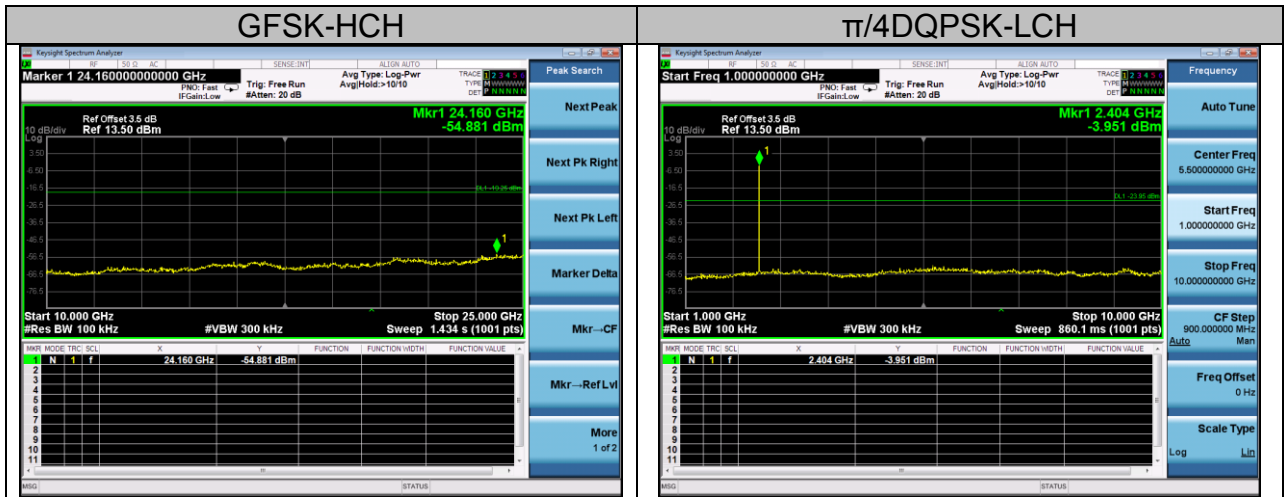
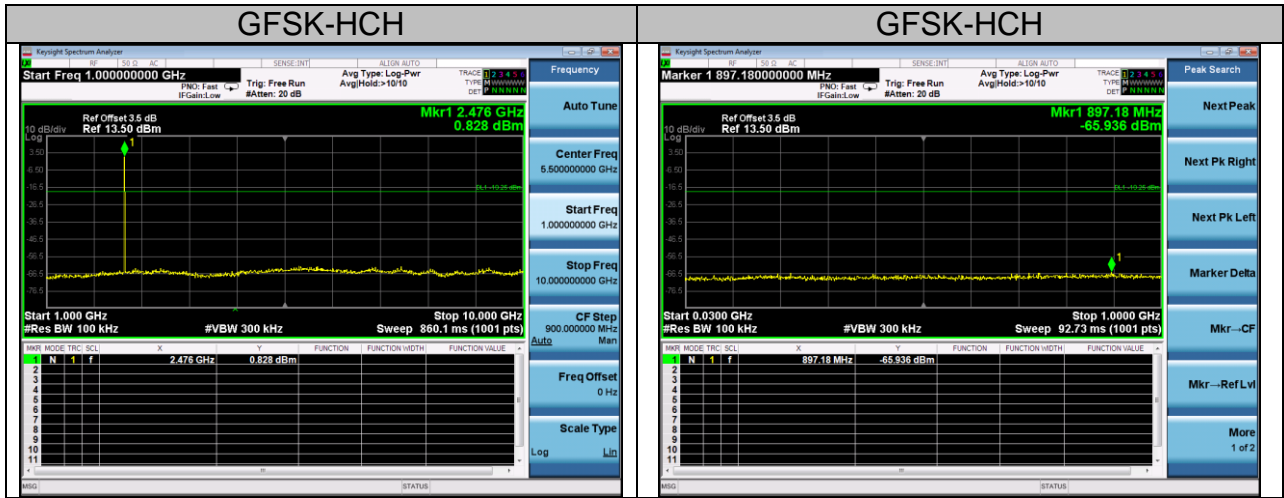

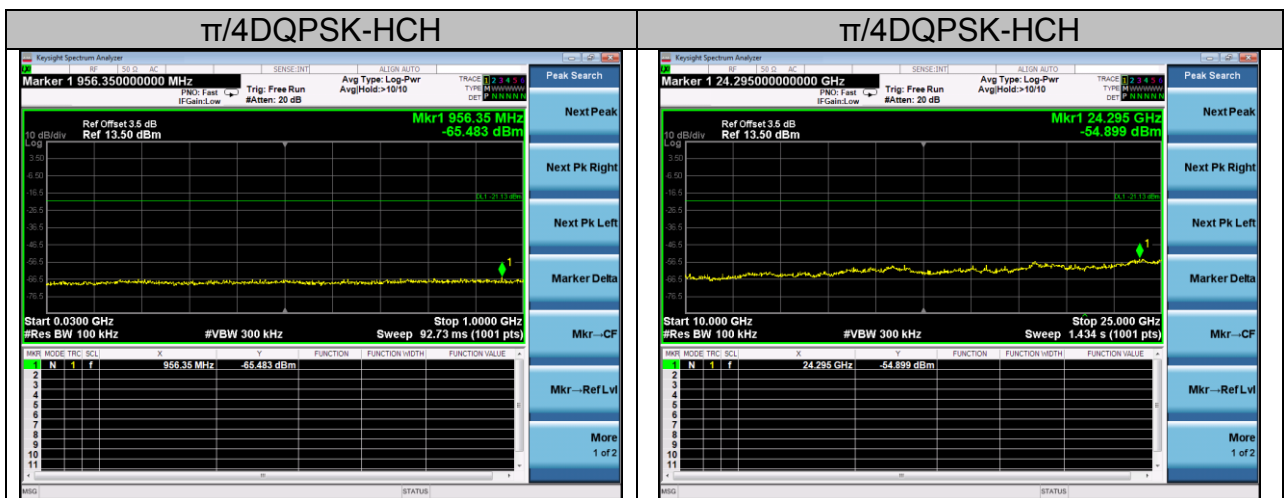
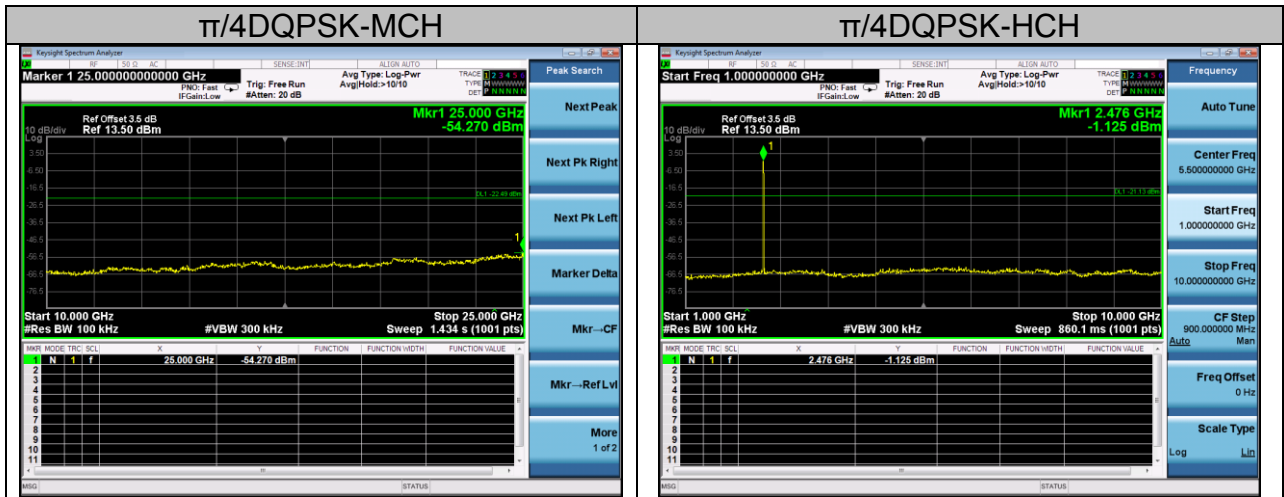
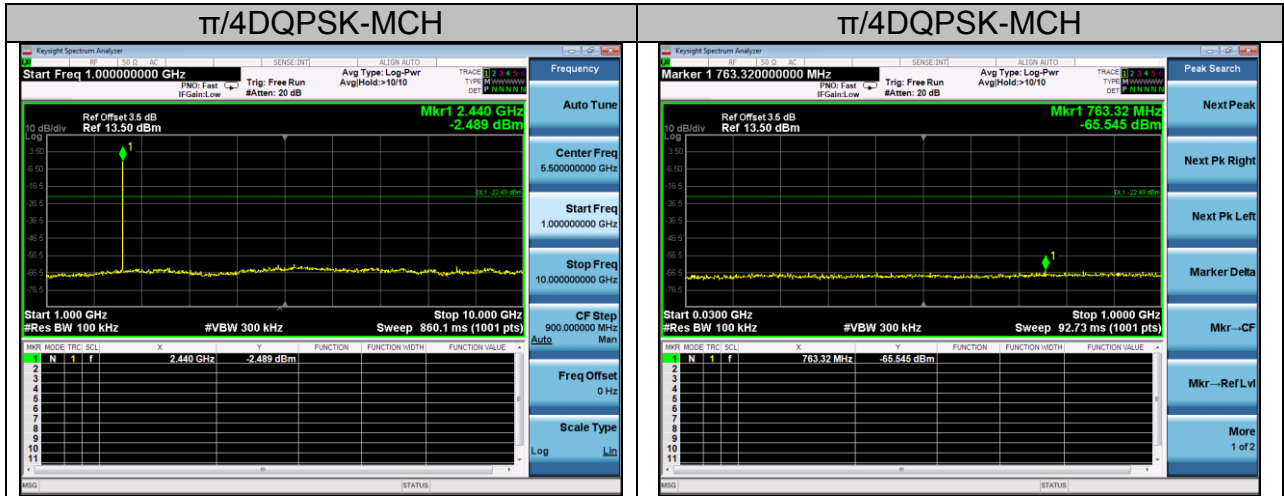

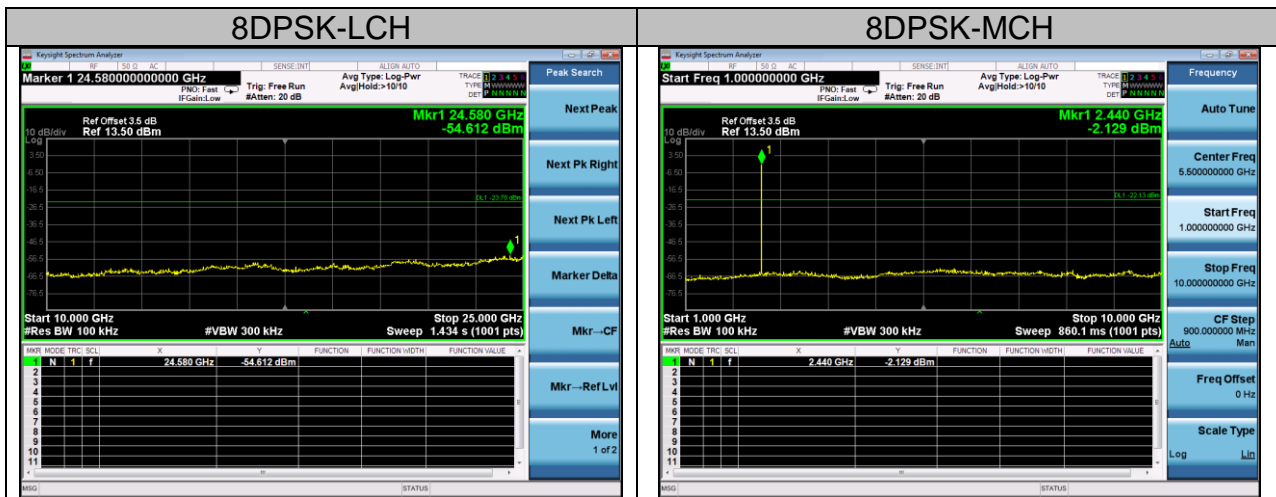
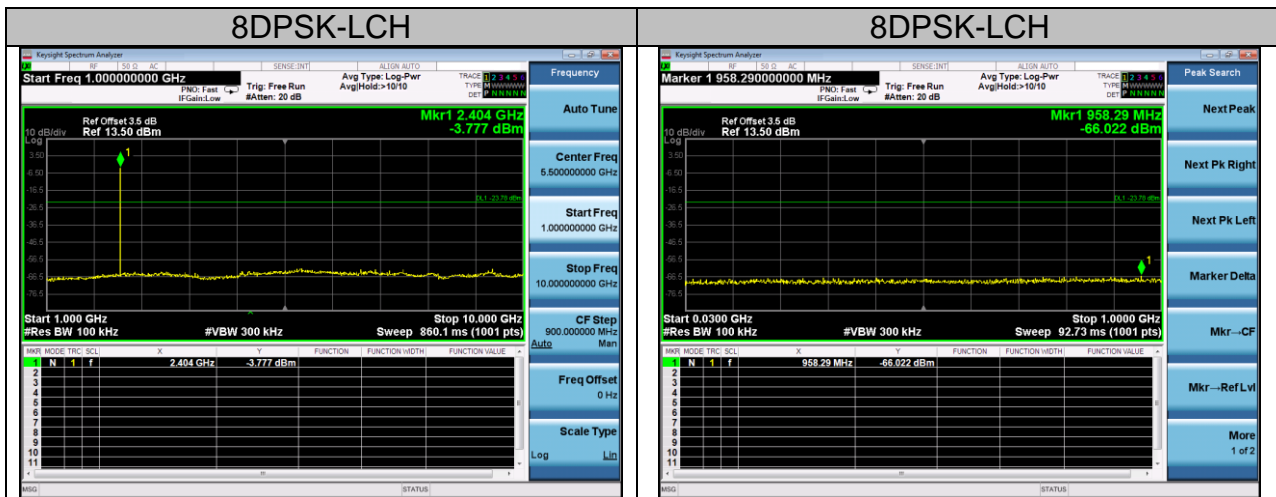

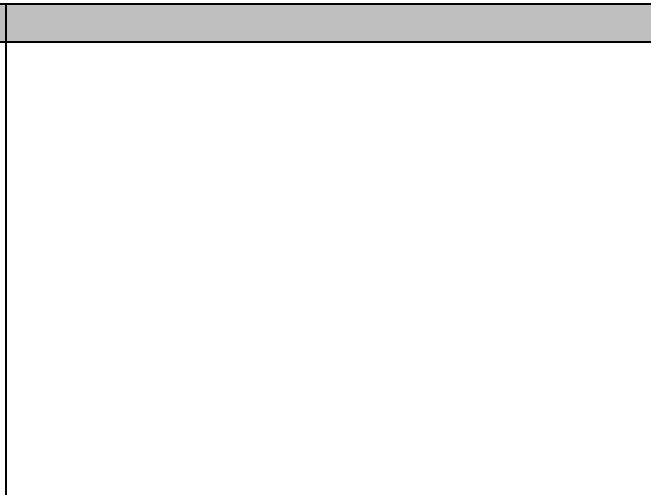
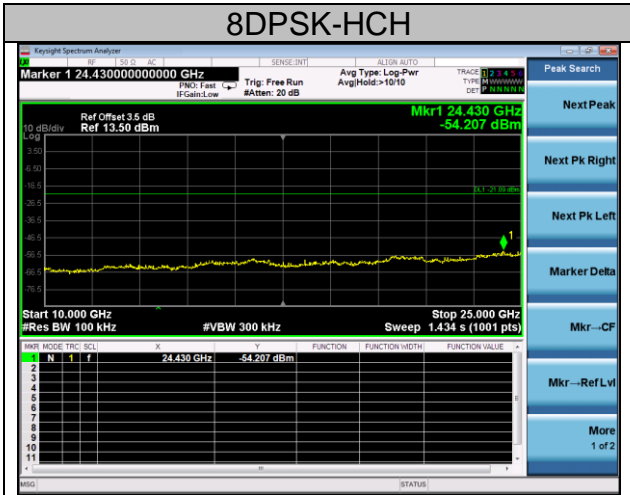
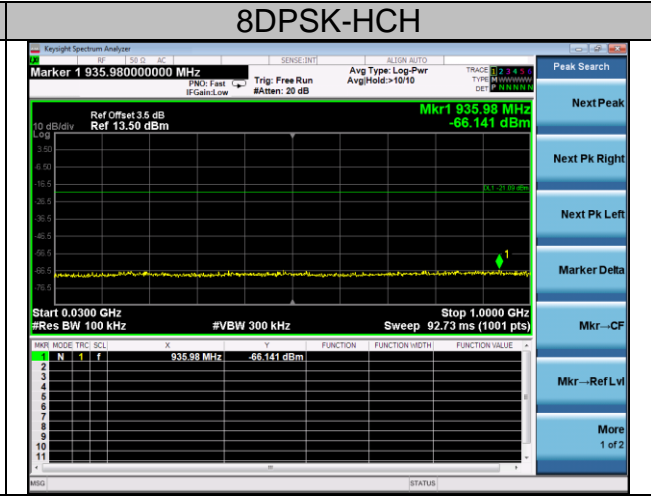
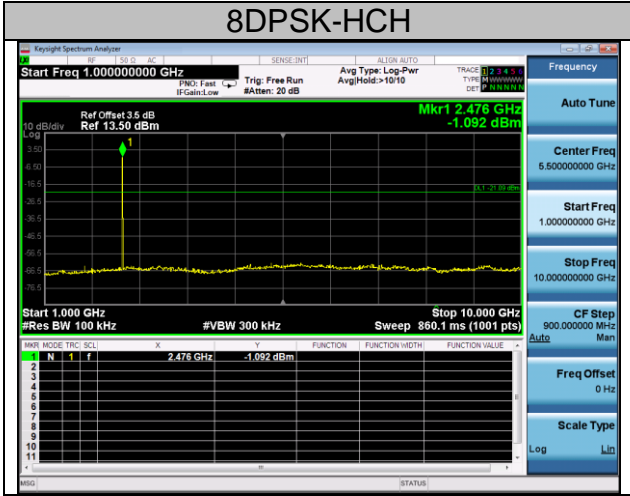

10. RADIATED EMISSION

10.1. MEASUREMENT PROCEDURE

1. The EUT was placed on the top of the turntable 0.8 or 1.5 meter above ground. The phase center of the receiving antenna mounted on the top of a height-variable antenna tower was placed 3 meters far away from the turntable.
2. Power on the EUT and all the supporting units. The turntable was rotated by 360 degrees to determine the position of the highest radiation.
3. The height of the broadband receiving antenna was varied between one meter and four meters above ground to find the maximum emissions field strength of both horizontal and vertical polarization.
4. For each suspected emissions, the antenna tower was scan (from 1 M to 4 M) and then the turntable was rotated (from 0 degree to 360 degrees) to find the maximum reading.
5. Set the test-receiver system to Peak or CISPR quasi-peak Detect Function with specified bandwidth under Maximum Hold Mode.
6. For emissions above 1GHz, use 1MHz VBW and RBW for peak reading. Then 1MHz RBW and 10Hz VBW for average reading in spectrum analyzer. Place the measurement antenna away from each area of the EUT determined to be a source of emissions at the specified measurement distance, while keeping the measurement antenna aimed at the source of emissions at each frequency of significant emissions, with polarization oriented for maximum response. The measurement antenna may have to be higher or lower than the EUT, depending on the radiation pattern of the emission and staying aimed at the emission source for receiving the maximum signal. The final measurement antenna elevation shall be that which maximizes the emissions. The measurement antenna elevation for maximum emissions shall be restricted to a range of heights of from 1 m to 4 m above the ground or reference ground plane.
7. When the radiated emissions limits are expressed in terms of the average value of the emissions, and pulsed operation is employed, the measurement field strength shall be determined by averaging over one complete pulse train, including blanking intervals, as long as the pulse train does not exceed 0.1 seconds. As an alternative (provided the transmitter operates for longer than 0.1 seconds) or in cases where the pulse train exceeds 0.1 seconds, the measured field strength shall be determined from the average absolute voltage during a 0.1 second interval during which the field strength is at its maximum values.
8. If the emissions level of the EUT in peak mode was 3 dB lower than the average limit specified, then testing will be stopped and peak values of EUT will be reported, otherwise, the emissions which do not have 3 dB margin will be repeated one by one using the quasi-peak method for below 1GHz.
9. For testing above 1GHz, the emissions level of the EUT in peak mode was lower than average limit (that means the emissions level in peak mode also complies with the limit in average mode), then testing will be stopped and peak values of EUT will be reported, otherwise, the emissions will be measured in average mode again and reported.
10. In case the emission is lower than 30MHz, loop antenna has to be used for measurement and the recorded data should be QP measured by receiver. High - Low scan is not required in this case.

10.2. TEST SETUP

Radiated Emission Test-Setup Frequency Below 30MHz

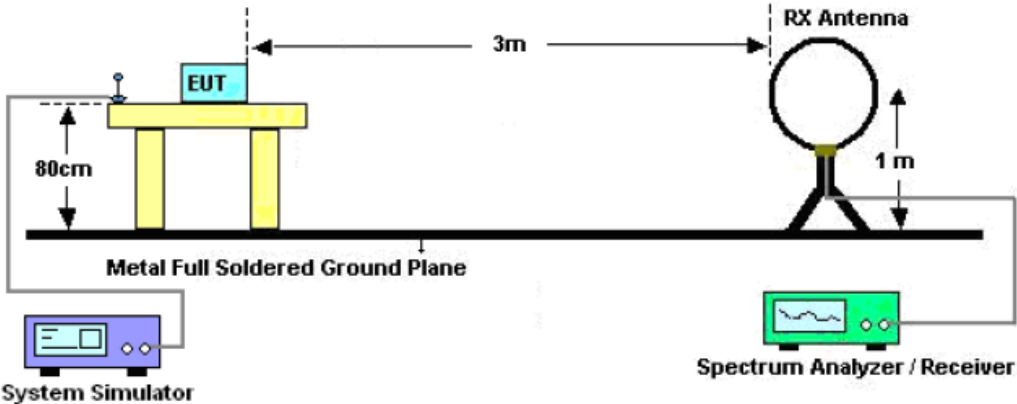

RADIATED EMISSION TEST SETUP 30MHz-1000MHz

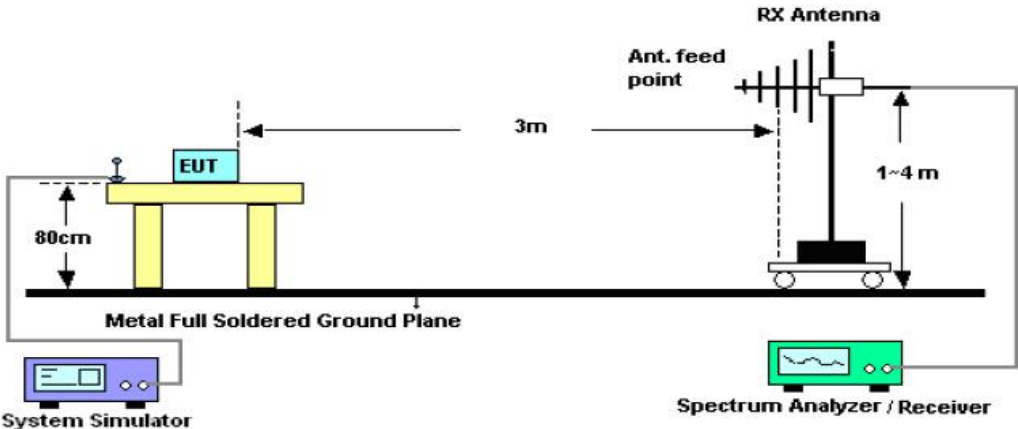

RADIATED EMISSION TEST SETUP ABOVE 1000MHz

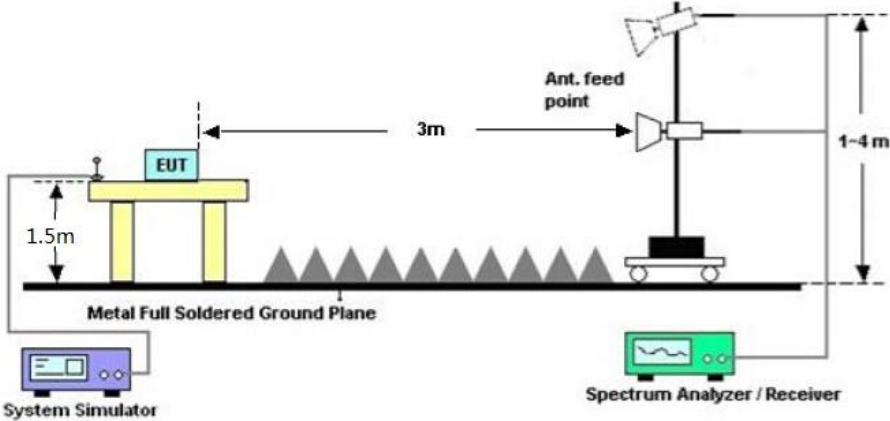

10.3. LIMITS AND MEASUREMENT RESULT

15.209(a) Limit in the below table has to be followed

Frequencies (MHz)	Field Strength (micorvolts/meter)	Measurement Distance (meters)
0.009~0.490	2400/F(KHz)	300
0.490~1.705	24000/F(KHz)	30
1.705~30.0	30	30
30~88	100	3
88~216	150	3
216~960	200	3
Above 960	500	3

10.4. TEST RESULT

RADIATED EMISSION BELOW 30MHZ

No emission found between lowest internal used/generated frequencies to 30MHz.

RADIATED EMISSION BELOW 1GHZ

RADIATED EMISSION TEST- (30MHZ-1GHZ) -HORIZONTAL



No.	Mk	Freq.	Reading	Factor	Measurement	Limit	Over	Detector	Antenna	Table	Comment
		MHz	dBuV	dB/m	dBuV/m	dBuV/m	dB		Height	Degree	
									cm	degree	
1		41.3167	9.64	11.81	21.45	40.00	-18.55	peak			
2		114.0667	15.40	7.23	22.63	43.50	-20.87	peak			
3	*	185.2000	21.77	11.31	33.08	43.50	-10.42	peak			
4		321.0000	16.89	16.81	33.70	46.00	-12.30	peak			
5		451.9500	7.32	20.61	27.93	46.00	-18.07	peak			
6		545.7167	10.42	22.36	32.78	46.00	-13.22	peak			

RESULT: PASS

RADIATED EMISSION TEST- (30MHZ-1GHZ) -VERTICAL



No.	Mk	Freq.	Reading	Factor	Measurement	Limit	Over	Detector	Antenna Height	Table Degree	Comment
		MHz	dBuV	dB/m	dBuV/m	dBuV/m	dB		cm	degree	
1	*	41.3167	27.03	8.81	35.84	40.00	-4.16	peak			
2		180.3500	18.73	13.98	32.71	43.50	-10.79	peak			
3		329.0833	14.83	17.35	32.18	46.00	-13.82	peak			
4		456.8000	9.12	20.66	29.78	46.00	-16.22	peak			
5		550.5667	13.06	22.48	35.54	46.00	-10.46	peak			
6		891.6833	3.17	28.39	31.56	46.00	-14.44	peak			

RESULT: PASS

- Note:** 1. Factor=Antenna Factor + Cable loss, Margin=Measurement-Limit.
 2. The "Factor" value can be calculated automatically by software of measurement system.
 3. All test modes for different EUT are pre-tested. The low channel for GFSK mode is the worst case and recorded in the report.

RADIATED EMISSION TEST- (ABOVE 1GHZ)

Frequency	Meter Reading	Factor	Emission Level	Limits	Margin	Detector	Comment
(MHz)	(dBμV)	(dB)	(dBμV/m)	(dBμV/m)	(dB)	Type	
Low Channel (2402 MHz)							
4804	64.06	-3.62	60.44	74	-13.56	Pk	Vertical
4804	44.32	-3.62	40.70	54	-13.30	AV	Vertical
4804	62.44	-3.64	58.80	74	-15.20	Pk	Horizontal
4804	45.24	-3.64	41.60	54	-12.40	AV	Horizontal
Mid Channel (2441 MHz)							
4882	63.95	-3.65	60.30	74	-13.70	Pk	Vertical
4882	43.92	-3.65	40.27	54	-13.73	AV	Vertical
4882	62.74	-3.68	59.06	74	-14.94	Pk	Horizontal
4882	42.42	-3.68	38.74	54	-15.26	AV	Horizontal
High Channel (2480 MHz)							
4960	63.95	-3.59	60.36	74	-13.64	pk	Vertical
4960	44.45	-3.59	40.86	54	-13.14	AV	Vertical
4960	63.36	-3.59	59.77	74	-14.23	pk	Horizontal
4960	42.63	-3.59	39.04	54	-14.96	AV	Horizontal

Note:

- 1) 30MHz~25GHz:(Scan with GFSK, π/4-DQPSK,8DPSK, the worst casw is GFSK Mode)
- 2) Factor = Antenna Factor + Cable Loss – Pre-amplifier.
Emission Level = Meter Reading + Factor
Margin = Emission Leve - Limit

RESULT: PASS

11. BAND EDGE EMISSION

11.1. MEASUREMENT PROCEDURE

1. The transmitter output is connected to a spectrum analyzer. The resolution bandwidth is set to 100kHz. The video bandwidth is set to 300kHz.
2. Transmitter set to the normal hopping mode at 2.4 and 2.4835 GHz.

11.2. TEST SET-UP

Radiated same as 10.2

Conducted set up

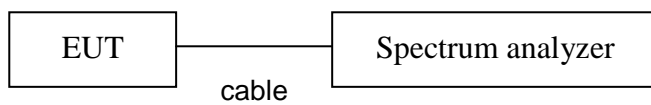

11.3. Radiated TEST RESULT

Frequency (MHz)	Meter Reading (dBμV)	Factor (dB)	Emission Level (dBμV/m)	Limits (dBμV/m)	Margin (dB)	Detector Type	Comment
GFSK							
2399.9	62.68	-12.99	49.69	74	-24.31	peak	Vertical
2399.9	54.14	-12.99	41.15	54	-12.85	AVG	Vertical
2399.9	66.58	-12.99	53.59	74	-20.41	peak	Horizontal
2399.9	46.91	-12.99	33.92	54	-20.08	AVG	Horizontal
2483.6	62.21	-12.78	49.43	74	-24.57	peak	Vertical
2483.6	52.05	-12.78	39.27	54	-14.73	AVG	Vertical
2483.6	64.01	-12.78	51.23	74	-22.77	peak	Horizontal
2483.6	53.74	-12.78	40.96	54	-13.04	AVG	Horizontal
π/4-DQPSK							
2399.9	61.05	-12.99	48.06	74	-25.94	peak	Vertical
2399.9	54.42	-12.99	41.43	54	-12.57	AVG	Vertical
2399.9	63.56	-12.99	50.57	74	-23.43	peak	Horizontal
2399.9	53.45	-12.99	40.46	54	-13.54	AVG	Horizontal
2483.6	62.94	-12.78	50.16	74	-23.84	peak	Vertical
2483.6	51.76	-12.78	38.98	54	-15.02	AVG	Vertical
2483.6	61.50	-12.78	48.72	74	-25.28	peak	Horizontal
2483.6	50.20	-12.78	37.42	54	-16.58	AVG	Horizontal
8DPSK							
2399.9	63.26	-12.99	50.27	74	-23.73	peak	Vertical
2399.9	55.67	-12.99	42.68	54	-11.32	AVG	Vertical
2399.9	64.33	-12.99	51.34	74	-22.66	peak	Horizontal
2399.9	50.41	-12.99	37.42	54	-16.58	AVG	Horizontal
2483.6	61.35	-12.78	48.57	74	-25.43	peak	Vertical
2483.6	53.64	-12.78	40.86	54	-13.14	AVG	Vertical
2483.6	62.60	-12.78	49.82	74	-24.18	peak	Horizontal
2483.6	55.98	-12.78	43.20	54	-10.80	AVG	Horizontal

RESULT: PASS

Note: The other modes radiation emission have enough 20dB margin.

Factor=Antenna Factor + Cable loss - Amplifier gain, Over=Measure-Limit.

The "Factor" value can be calculated automatically by software of measurement system.

11.4 Conducted TEST RESULT

Test Graph

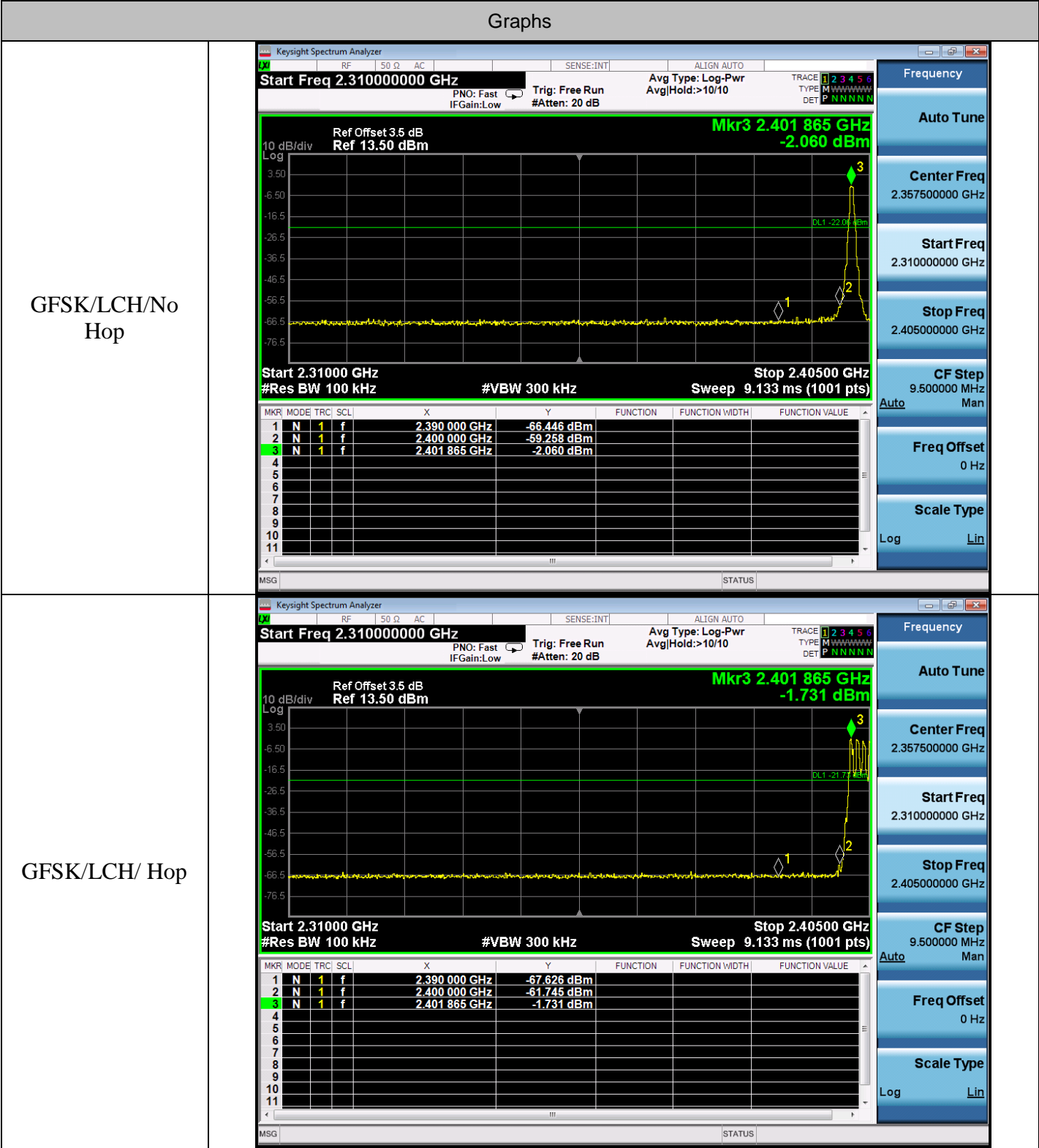

GFSK/HCH/No Hop

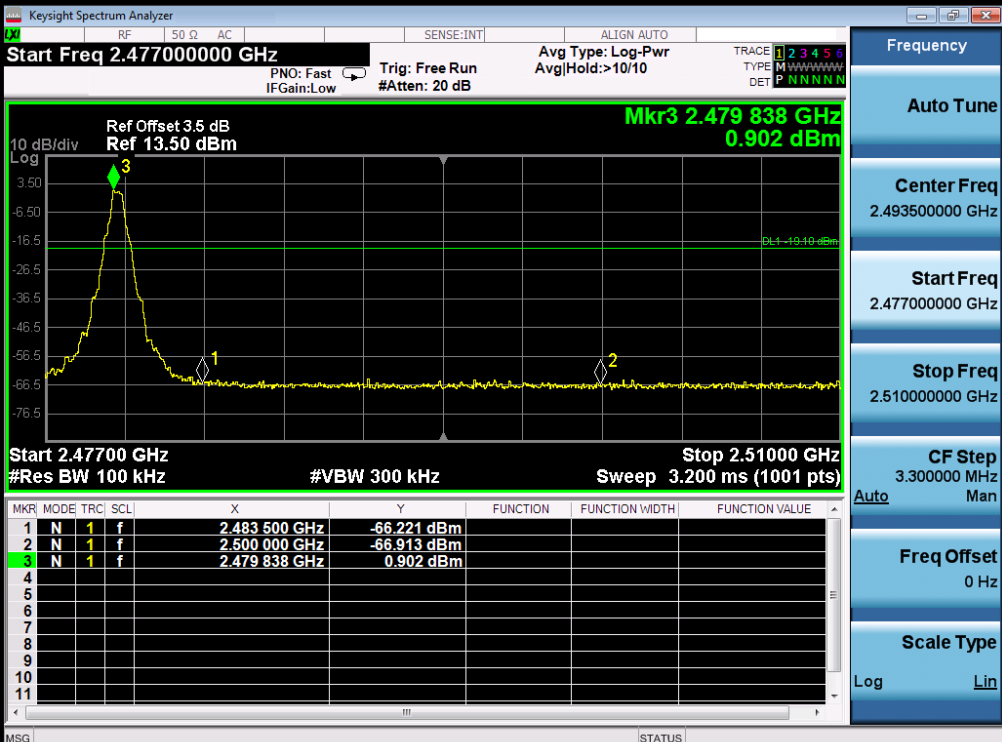

GFSK/HCH/Hop

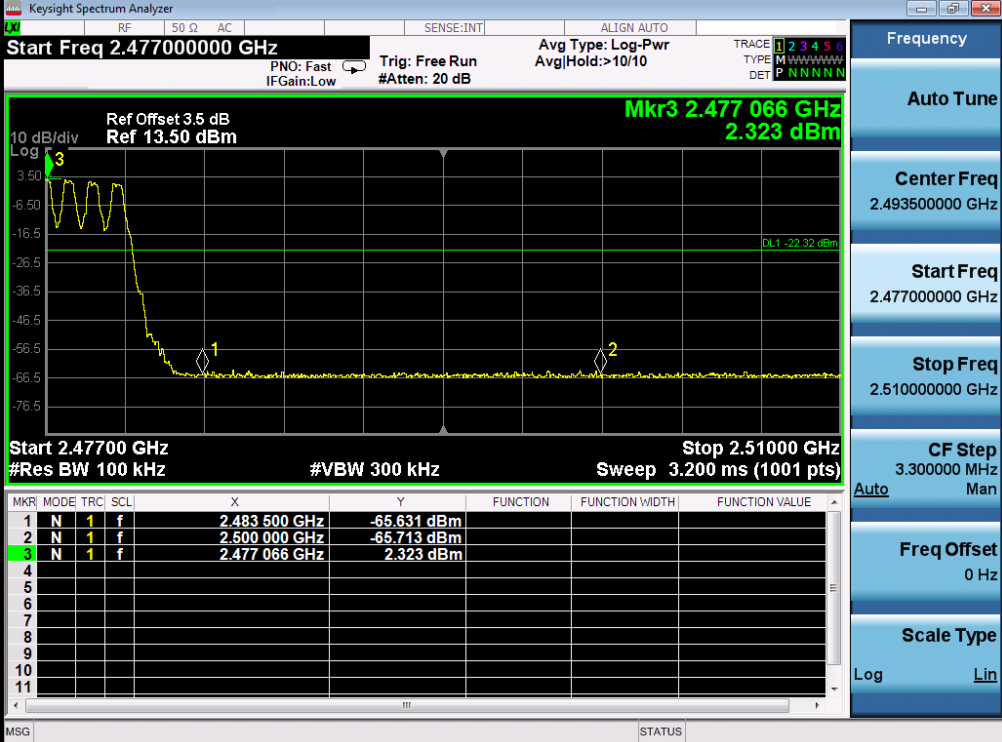

π
 /4DQPSK/LCH/No
 Hop

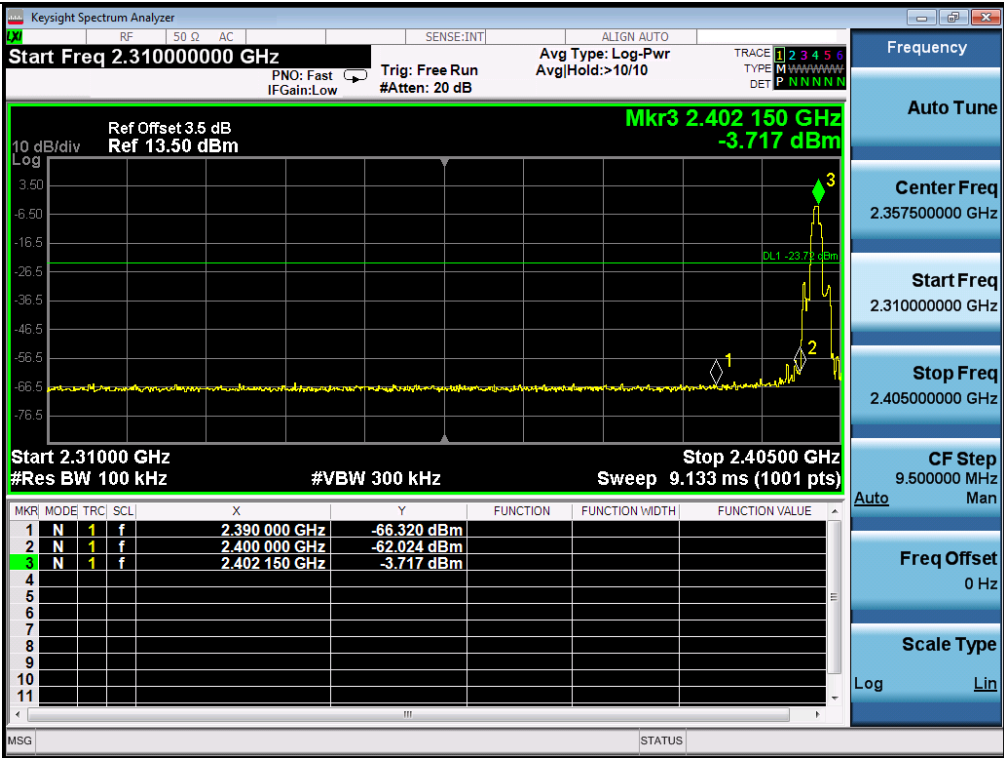

π
 /4DQPSK/HCH/No
 Hop

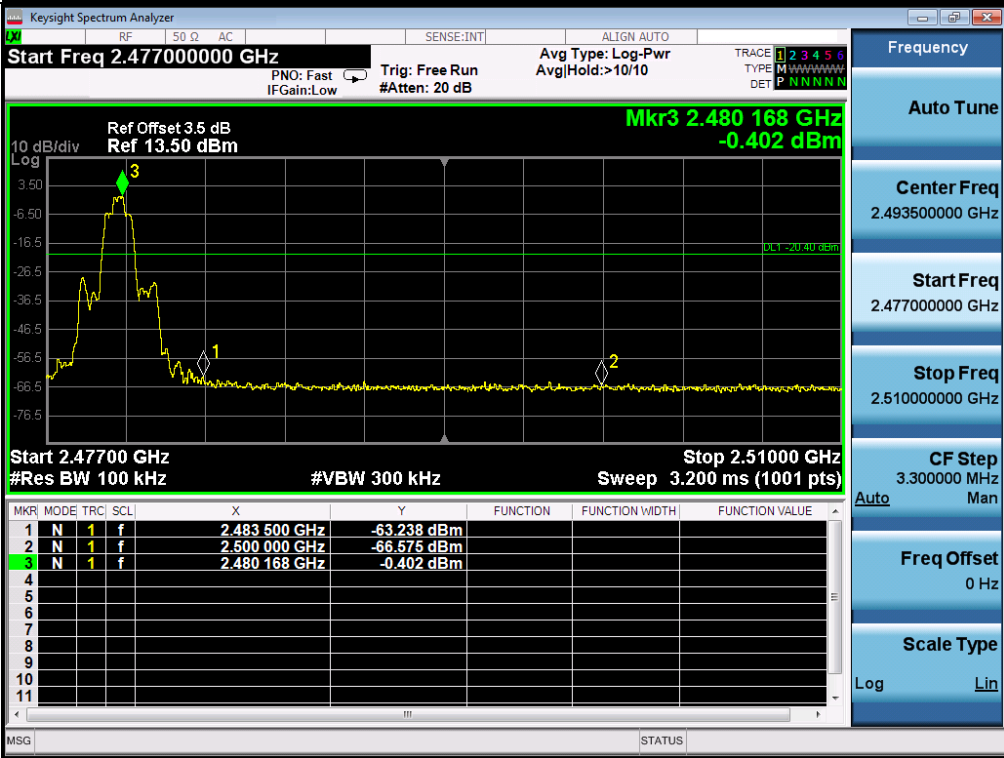

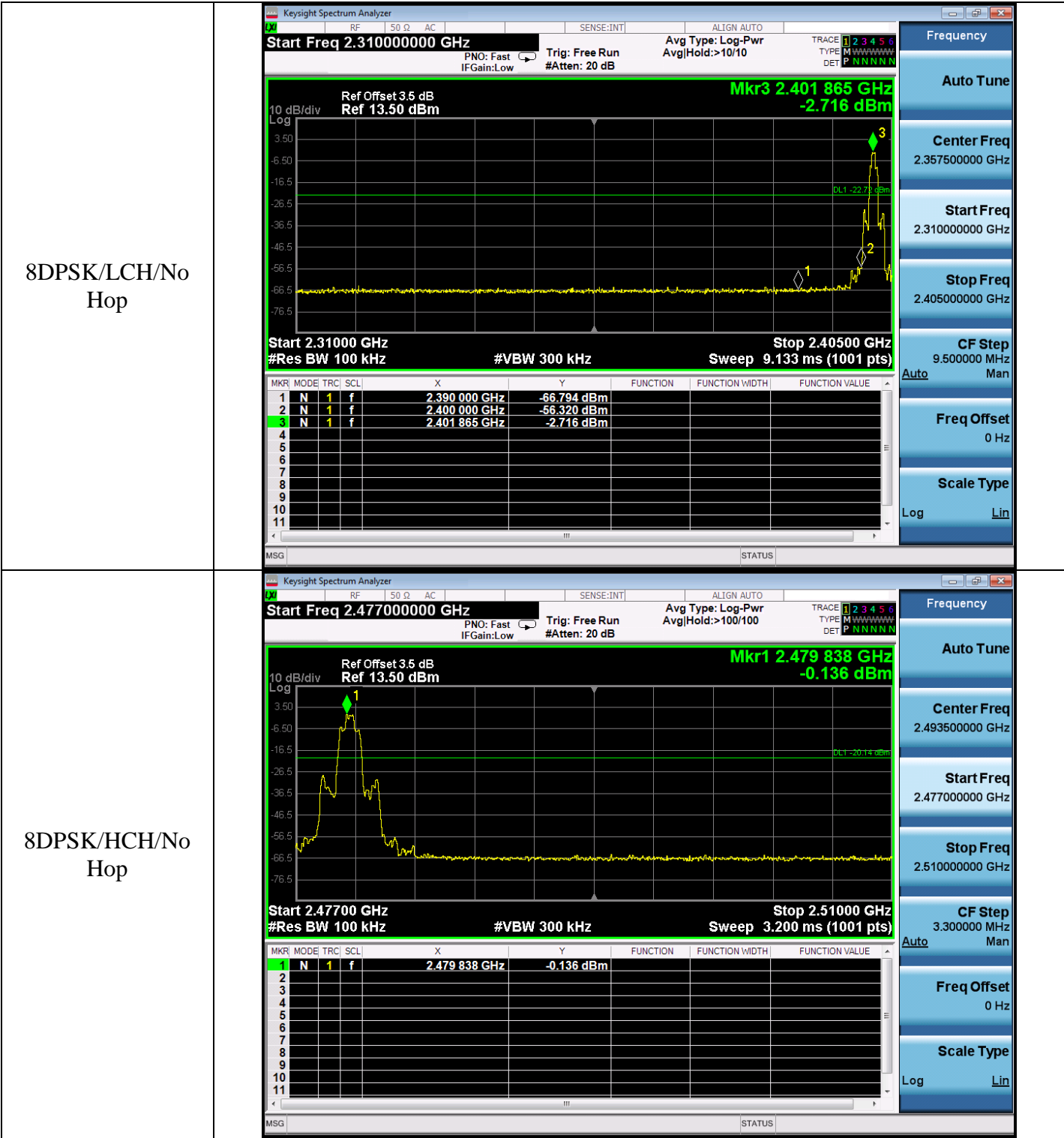

Note: All modes were tested, only the worst case record in the report.

13. TIME OF OCCUPANCY (DWELL TIME)

13.1. MEASUREMENT PROCEDURE

The EUT shall have its hopping function enabled. Use the following spectrum analyzer settings:

1. Span: Zero span, centered on a hopping channel.
2. RBW shall be \leq channel spacing and where possible RBW should be set $\gg 1 / T$, where T is the expected dwell time per channel.
3. Sweep: As necessary to capture the entire dwell time per hopping channel; where possible use a video trigger and trigger delay so that the transmitted signal starts a little to the right of the start of the plot. The trigger level might need slight adjustment to prevent triggering when the system hops on an adjacent channel; a second plot might be needed with a longer sweep time to show two successive hops on a channel.
4. Detector function: Peak. Trace: Max hold.
5. Use the marker-delta function to determine the transmit time per hop.
6. Repeat the measurement using a longer sweep time to determine the number of hops over the period specified in the requirements. The sweep time shall be equal to, or less than, the period specified in the requirements. Determine the number of hops over the sweep time and calculate the total number of hops in the period specified in the requirements, using the following equation:
(Number of hops in the period specified in the requirements) = (number of hops on spectrum analyzer) \times (period specified in the requirements / analyzer sweep time)
7. The average time of occupancy is calculated from the transmit time per hop multiplied by the number of hops in the period specified in the requirements.

13.2. TEST SETUP (BLOCK DIAGRAM OF CONFIGURATION)

Same as described in section 8.2

13.3. MEASUREMENT EQUIPMENT USED

The same as described in section 6

13.4. LIMITS AND MEASUREMENT RESULT

Channel.	Burst Width [ms/hop/ch]	Dwell Time[ms]	Verdict	Limit (ms)
LCH	3.085	329.067078	PASS	400
MCH	3.085	329.067078	PASS	400
HCH	3.085	329.067078	PASS	400

Note: The DH5 for GFSK modulation is the worst case and recorded in the report.

The dwell time is calculated with the following formula:

$$\text{Dwell time} = t_{\text{pulse}} \times n_{\text{hops}} / \text{number of channels} \times 31.6 \text{ s}$$

Where:

- t_{pulse} is the measured pulse time (pls. refer the plots of the spectrum analyser above) [s],
- n_{hops} is the number of hops per second in the actual operating mode of the transmitter [1/s].

The hopping rate of the system is 1600 hops per second and the system uses 79 channels. For this reason one time slot has a length of 625 μs .

With the used hopping mode (DH5) a packet need 5 timeslots for transmitting and the next timeslot for receiving. So the system makes in worst case 266,67 hops per second in transmit mode ($n_{\text{hops}} = 266.667 \text{ 1/s}$)

Test Graph



14. FREQUENCY SEPARATION

14.1. MEASUREMENT PROCEDURE

1. Place the EUT on the table and set it in transmitting mode
2. Remove the antenna from the EUT and then connect a low RF cable from the antenna port to the spectrum analyzer
3. Set Span = wide enough to capture the peaks of two adjacent channels Resolution (or IF) Bandwidth (RBW) \geq 1% of the span Video (or Average) Bandwidth (VBW) \geq RBW; Sweep = auto; Detector function = peak; Trace = max hold

14.2. TEST SETUP (BLOCK DIAGRAM OF CONFIGURATION)

Same as described in section 6.2

14.3. MEASUREMENT EQUIPMENT USED

The same as described in section 6.3

14.4. LIMITS AND MEASUREMENT RESULT

Mode	Channel.	Carrier Frequency Separation [MHz]	Verdict
GFSK	Hop	0.999	PASS

Note: All modes were tested, only the worst case record in the report.

Test Graph

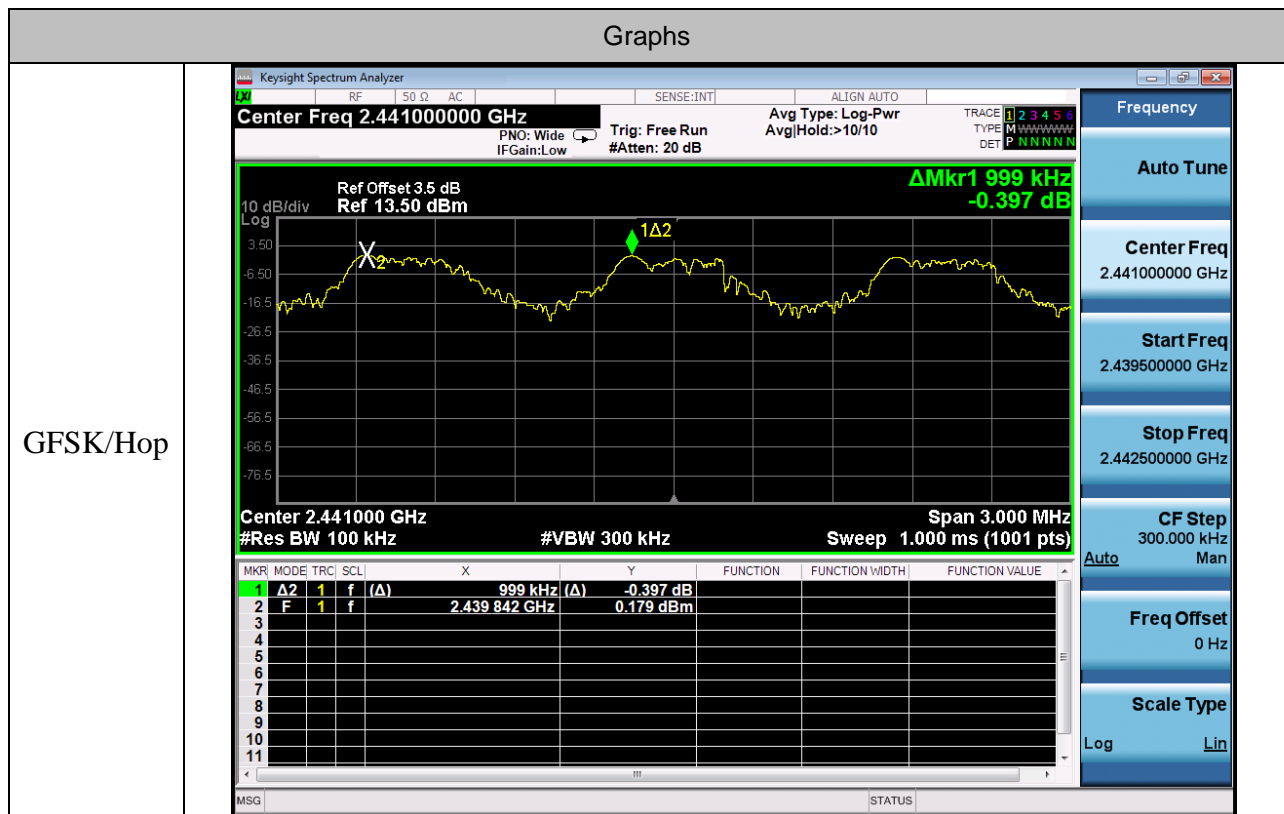

15. FCC LINE CONDUCTED EMISSION TEST

15.1. LIMITS OF LINE CONDUCTED EMISSION TEST

Frequency	Maximum RF Line Voltage	
	Q.P.(dBuV)	Average(dBuV)
150kHz~500kHz	66-56	56-46
500kHz~5MHz	56	46
5MHz~30MHz	60	50

Note:

1. The lower limit shall apply at the transition frequency.
2. The limit decreases linearly with the logarithm of the frequency in the range 0.15 MHz to 0.50 MHz.

15.2. BLOCK DIAGRAM OF LINE CONDUCTED EMISSION TEST

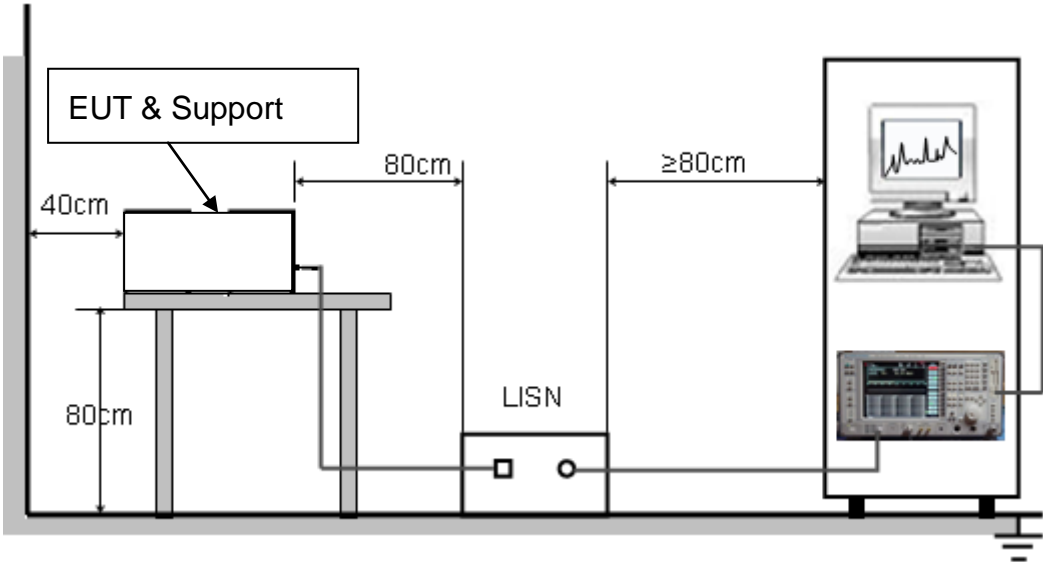

15.3. PRELIMINARY PROCEDURE OF LINE CONDUCTED EMISSION TEST

1. The equipment was set up as per the test configuration to simulate typical actual usage per the user's manual. When the EUT is a tabletop system, a wooden table with a height of 0.8 meters is used and is placed on the ground plane as per ANSI C63.10 (see Test Facility for the dimensions of the ground plane used). When the EUT is a floor-standing equipment, it is placed on the ground plane which has a 3-12 mm non-conductive covering to insulate the EUT from the ground plane.
2. Support equipment, if needed, was placed as per ANSI C63.10.
3. All I/O cables were positioned to simulate typical actual usage as per ANSI C63.10.
4. All support equipments received AC120V/60Hz power from a LISN, if any.
5. The EUT received DC charging voltage by adapter which received 120V/60Hz power by a LISN..
6. The test program was started. Emissions were measured on each current carrying line of the EUT using a spectrum Analyzer / Receiver connected to the LISN powering the EUT. The LISN has two monitoring points: Line 1 (Hot Side) and Line 2 (Neutral Side). Two scans were taken: one with Line 1 connected to Analyzer / Receiver and Line 2 connected to a 50 ohm load; the second scan had Line 1 connected to a 50 ohm load and Line 2 connected to the Analyzer / Receiver.
7. Analyzer / Receiver scanned from 150 kHz to 30MHz for emissions in each of the test modes.
8. During the above scans, the emissions were maximized by cable manipulation.
9. The test mode(s) were scanned during the preliminary test.

Then, the EUT configuration and cable configuration of the above highest emission level were recorded for reference of final testing.

15.4. FINAL PROCEDURE OF LINE CONDUCTED EMISSION TEST

1. EUT and support equipment was set up on the test bench as per step 2 of the preliminary test.
2. A scan was taken on both power lines, Line 1 and Line 2, recording at least the six highest emissions. Emission frequency and amplitude were recorded into a computer in which correction factors were used to calculate the emission level and compare reading to the applicable limit. If EUT emission level was less -2dB to the A.V. limit in Peak mode, then the emission signal was re-checked using Q.P and Average detector.
3. The test data of the worst case condition(s) was reported on the Summary Data page.

15.5. TEST RESULT OF LINE CONDUCTED EMISSION TEST

Line Conducted Emission Test Line 1-L

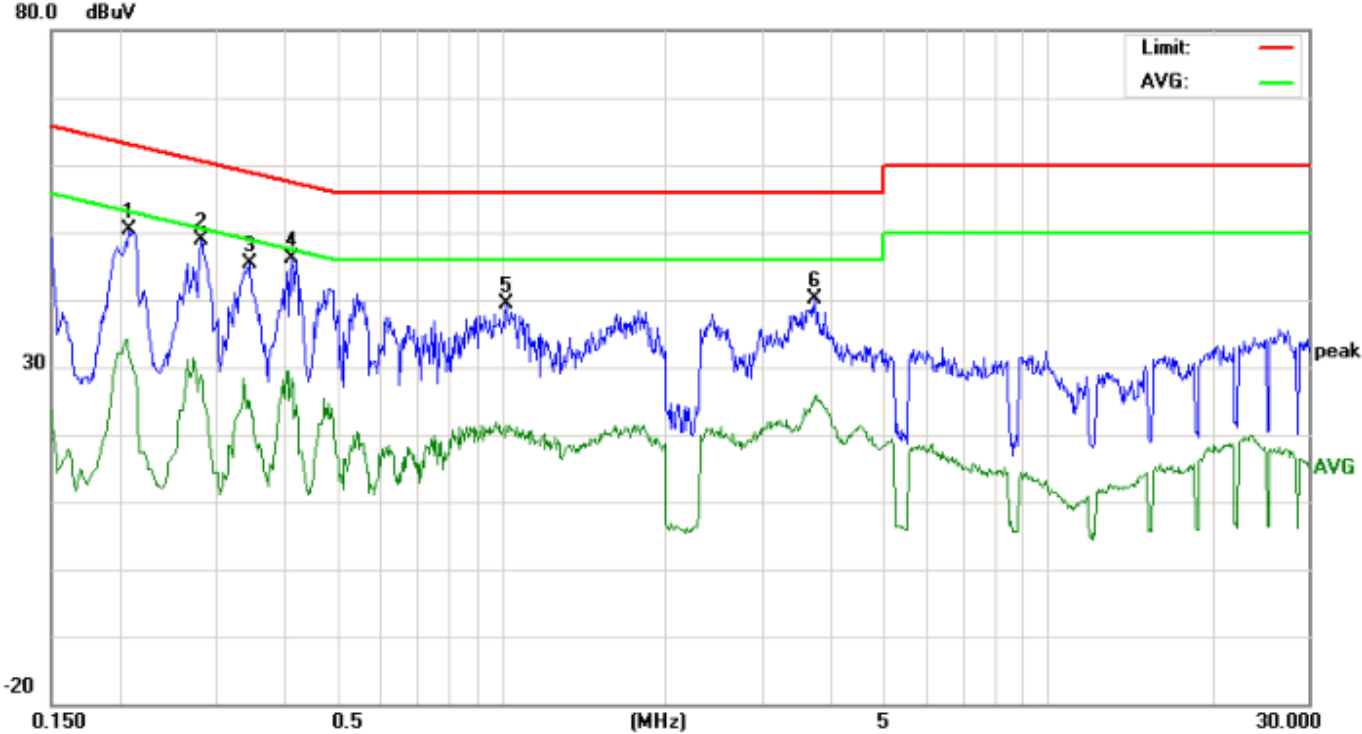

No.	Freq. (MHz)	Reading_Level (dBuV)			Correct Factor (dB)	Measurement (dBuV)			Limit (dBuV)		Margin (dB)		P/F	Comment
		Peak	QP	AVG		Peak	QP	AVG	QP	AVG	QP	AVG		
1	0.2083	40.26		21.85	10.22	50.48		32.07	63.27	53.27	-12.79	-21.20	P	
2	0.2819	38.71		18.69	10.28	48.99		28.97	60.76	50.76	-11.77	-21.79	P	
3	0.3464	35.06		14.49	10.31	45.37		24.80	59.05	49.05	-13.68	-24.25	P	
4	0.4140	35.82		18.08	10.34	46.16		28.42	57.57	47.57	-11.41	-19.15	P	
5	1.0260	29.10		10.94	10.37	39.47		21.31	56.00	46.00	-16.53	-24.69	P	
6	3.7460	29.54		15.12	10.47	40.01		25.59	56.00	46.00	-15.99	-20.41	P	

Line Conducted Emission Test Line 2-N

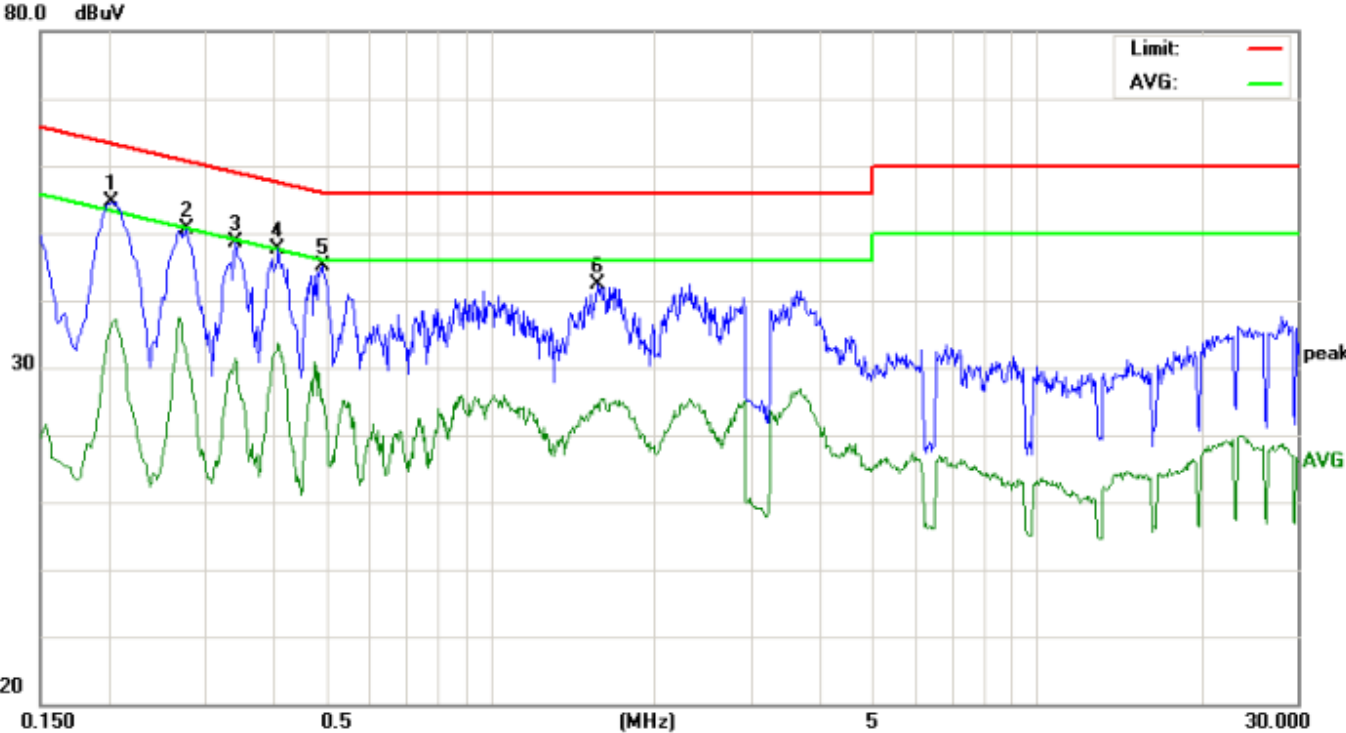

No.	Freq. (MHz)	Reading_Level (dBuV)			Correct Factor (dB)	Measurement (dBuV)			Limit (dBuV)		Margin (dB)		P/F	Comment
		Peak	QP	AVG		Peak	QP	AVG	QP	AVG	QP	AVG		
1	0.2020	44.49		26.24	10.22	54.71		36.46	63.52	53.52	-8.81	-17.06	P	
2	0.2779	40.29		21.40	10.28	50.57		31.68	60.88	50.88	-10.31	-19.20	P	
3	0.3420	38.35		21.02	10.31	48.66		31.33	59.15	49.15	-10.49	-17.82	P	
4	0.4100	37.31		23.32	10.34	47.65		33.66	57.65	47.65	-10.00	-13.99	P	
5	0.4940	34.64		14.95	10.40	45.04		25.35	56.10	46.10	-11.06	-20.75	P	
6	1.5740	32.00		14.34	10.36	42.36		24.70	56.00	46.00	-13.64	-21.30	P	

APPENDIX A: PHOTOGRAPHS OF TEST SETUP
FCC LINE CONDUCTED EMISSION TEST SETUP



FCC RADIATED EMISSION TEST SETUP



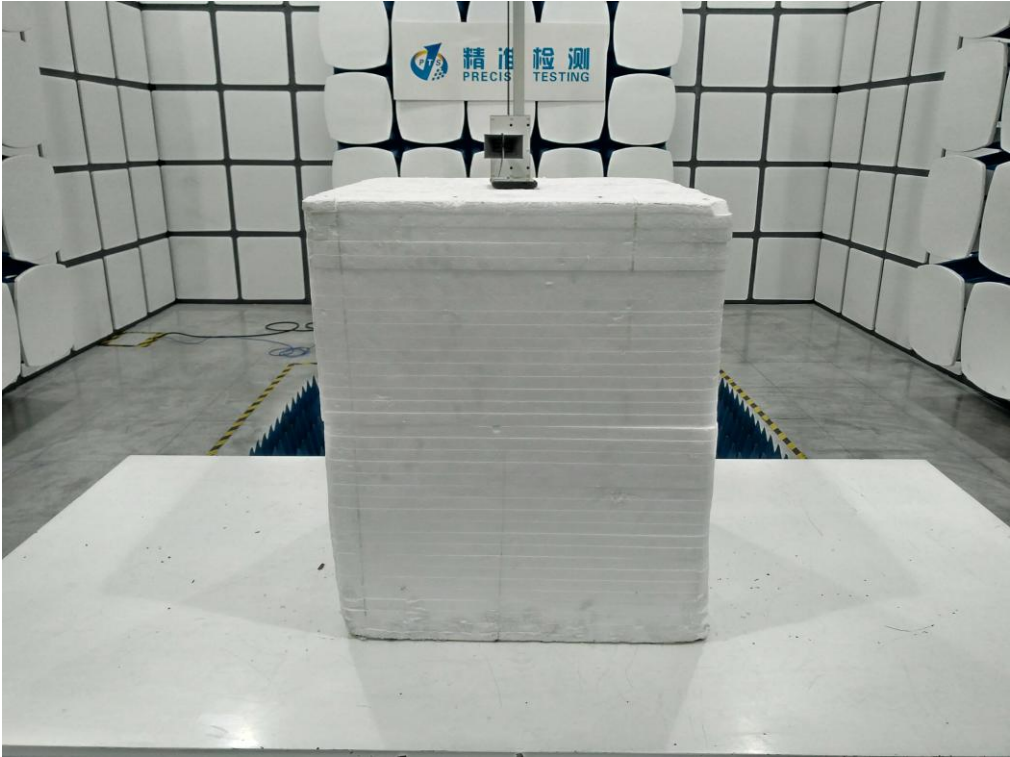

----END OF REPORT----